

SONY®

Click 

“Handycam” Handbook HDR-CX130E/CX160E/CX180E



Table of Contents

Enjoy Useful Functions

Index

HANDYCAM®

Using the “Handycam” Handbook

You will find information on using your camcorder to its fullest in this “Handycam” Handbook. Read the “Handycam” Handbook in addition to the Operating Guide (a separate volume). Information on using your camcorder connected to a computer will be also found in the Operating Guide and the “PMB Help” that is the Help of the supplied “PMB (Picture Motion Browser)” software.

Searching for information quickly

Click an item on the right edge of each page, and you will jump to the page for that item.



← Click here.

- You can search for an item by keyword using Adobe Reader. Refer to the Help of Adobe Reader for tips on how to use Adobe Reader.
- You can print out the “Handycam” Handbook.

Read this first

Supplied items

The numbers in () are the supplied quantity.

- AC Adaptor (1)
- Power cord (Mains lead) (1)
- Component A/V cable (1) **A**
- A/V connecting cable (1) **B**
- USB connection support cable (1) **C**
Use this cable when the Built-in USB Cable of the camcorder (p. 14) is too short for connection.
- Rechargeable battery pack NP-FV50 (1)
- CD-ROM “Handycam” Application Software (1)
 - “PMB” (software, including “PMB Help”)
 - “Handycam” Handbook (PDF)
- “Operating Guide” (1)

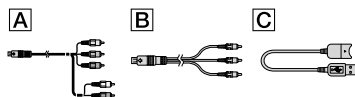

- This camcorder has a built-in software application called “PMB Portable”.
- See page 21 for the memory card you can use with this camcorder.

Using the camcorder

- Do not hold the camcorder by the following parts, and also do not hold the camcorder by the jack covers.

LCD Screen

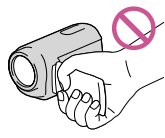

Battery pack

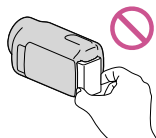

Built-in USB Cable



- The camcorder is not dustproofed, dripproofed or waterproofed. See “About handling of your camcorder” (p. 98).

Menu items, LCD panel, and lens

- A menu item that is grayed out is not available under the current recording or playback conditions.
- The LCD screen is manufactured using extremely high-precision technology, so over 99.99% of the pixels are operational for effective use. However, there may be some tiny black points and/or bright points (white, red, blue, or green in color) that appear constantly on the LCD screen. These points are normal results of the manufacturing process and do not affect the recording in any way.

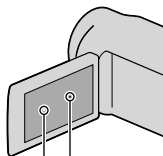

Black points
White, red, blue or green points

- Exposing the LCD screen or the lens to direct sunlight for long periods of time may cause malfunctions.
- Do not aim at the sun. Doing so might cause your camcorder to malfunction. Take images of the sun only in low light conditions, such as at dusk.

About language setting

- The on-screen displays in each local language are used for illustrating the operating procedures. Change the screen language before using the camcorder if necessary (p. 19).

On recording

- To ensure stable operation of the memory card, it is recommended to format the memory card with your camcorder before the first use (p. 77). Formatting the memory card will erase all the data stored on it and the data will be irrecoverable. Save your important data on your PC etc.
- Before starting to record, test the recording function to make sure the image and sound are recorded without any problems.
- Compensation for the contents of recordings cannot be provided, even if recording or playback is not possible due to a malfunction of the camcorder, recording media, etc.
- TV color systems differ depending on the country/region. To view your recordings on a TV, you need a PAL system-based TV.
- Television programs, films, video tapes, and other materials may be copyrighted. Unauthorized recording of such materials may be contrary to the copyright laws.
- Use the camcorder in accordance with local regulations.

Notes on playing back

- You may not be able to play back normally images recorded on your camcorder with other devices. Also, you may not be able to play back images recorded on other devices with your camcorder.
- Standard (STD) image quality movies recorded on SD memory cards cannot be played on AV equipment of other manufacturers.

DVD media recorded with HD image quality (high definition)

- DVD media recorded with high definition image quality (HD) can be played back with devices that are compatible with the AVCHD standard. You cannot play discs recorded with high definition image quality (HD) with DVD players/recorders as they are not compatible with the AVCHD format. If you insert a disc recorded with the AVCHD format (high definition image quality (HD)) into a DVD

player/recorder, you may not be able to eject the disc.

Save all your recorded image data

- To prevent your image data from being lost, save all your recorded images on external media periodically. To save images on your computer, see page 46, and to save images on external devices, see page 52.
- The type of discs or media on which the images can be saved depend on the [ REC Mode] selected when the images were recorded. Movies recorded with [50p Quality **PS**] can be saved using external media (p. 54). Movies recorded with [Highest Quality **FX**] can be saved on external media or on Blu-ray discs (p. 51, 54).

Notes on battery pack/AC Adaptor

- Be sure to remove the battery pack or the AC Adaptor after turning off the camcorder.
- Disconnect the AC Adaptor from the camcorder, holding both the camcorder and the DC plug.

Note on the camcorder/battery pack temperature

- When the temperature of the camcorder or battery pack becomes extremely high or extremely low, you may not be able to record or play back on the camcorder, due to the protection features of the camcorder being activated in such situations. In this case, an indicator appears on the LCD screen (p. 90).

When the camcorder is connected to a computer or accessories

- Do not try to format the recording media of the camcorder using a computer. If you do so, your camcorder may not operate correctly.
- When connecting the camcorder to another device with communication cables, be sure to insert the connector plug in the correct way. Pushing the plug forcibly into the terminal will damage the terminal and may result in a malfunction of the camcorder.

- When the camcorder is connected to other devices through a USB connection and the power of the camcorder is turned on, do not close the LCD panel. The image data that has been recorded may be lost.

If you cannot record/play back images, perform [Format]

- If you repeat recording/deleting images for a long time, fragmentation of data occurs on the recording media. Images cannot be saved or recorded. In such a case, save your images on some type of external media first, and then perform [Format] by touching **MENU** (MENU) → [Setup] → [Media Settings] → [Format] → the desired medium (HDR-CX160E/CX180E) → **OK** → **OK**.

Notes on optional accessories

- We recommend using genuine Sony accessories.
- Genuine Sony accessories may not be available in some countries/regions.

About this manual, illustrations and on-screen displays



- The example images used in this manual for illustration purposes are captured using a digital still camera, and therefore may appear different from images and screen indicators that actually appear on your camcorder. And, the illustrations of your camcorder and its screen indication are exaggerated or simplified for understandability.
- In this manual, the internal memory (HDR-CX160E/CX180E) and the memory card are called “recording media.”
- In this manual, the DVD disc recorded with high definition image quality (HD) is called AVCHD recording disc.
- Design and specifications of your camcorder and accessories are subject to change without notice.

Confirm the model name of your camcorder

- The model name is shown in this manual when there is a difference in specification between models. Confirm the model name on the bottom of your camcorder.
- The main differences in specification of this series are as follows.

	Recording media	Capacity of internal recording media
HDR-CX130E	Memory card	—
HDR-CX160E	Internal memory	16 GB
HDR-CX180E	Internal memory + memory card	32 GB

Notes on use

- Do not do any of the following. Otherwise, the recording media may be damaged, recorded images may be impossible to play back or may be lost, or other malfunctions could occur.
 - ejecting the memory card when the access lamp (p. 22) is lit or flashing
 - removing the battery pack or AC Adaptor from the camcorder, or applying mechanical shock or vibration to the camcorder when the  (Movie)/ (Photo) lamps (p. 24) or the access lamp (p. 22) are lit or flashing
- When using a shoulder belt (sold separately), do not crash the camcorder against an object.

Enjoy useful functions

Beautiful & easy anywhere & anytime

Recording

● Checking your golf swing

Golf Shot (66)

Smth Slw REC (65)



● Capturing images beautifully without cumbersome setting

Intelligent Auto (34)

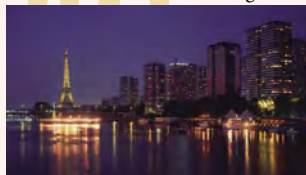

● Focus on the child on the left side of the screen

Tracking the subject (36)

Spot Focus (68)





- **Recording in a dimly-lit room**

Low Lux (69)

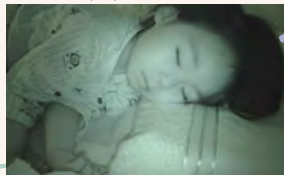

- **Capturing fireworks, or a sunset in all its splendor**

Fireworks (69)

Sunrise&Sunset (69)



- **Capturing photos during movie recording**

Dual Rec (37)

Smile Shutter (37)



- **Changing the image quality and recording mode**

FHD / **FSDA** Setting (35)

Recording mode (35)

- **Changing the recording media**

Media setting (20)

Fun & simple playback & edit

Using

- **Playing back a digest of your movies**

Highlight Playback (38)

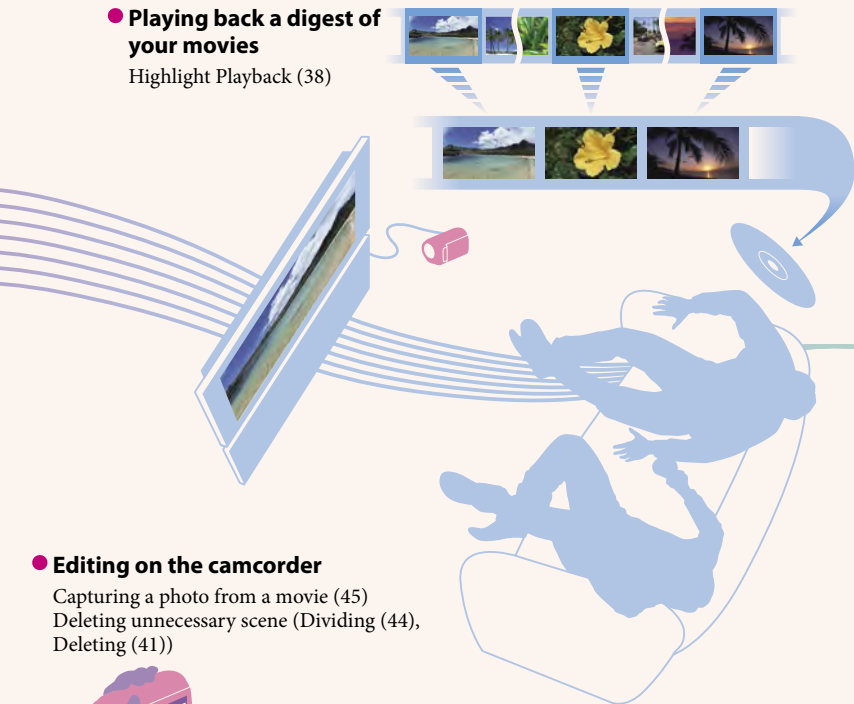

- **Editing on the camcorder**

Capturing a photo from a movie (45)

Deleting unnecessary scene (Dividing (44),

Deleting (41))

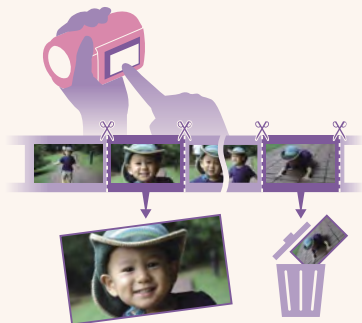

Easy ways to store good memories

Saving

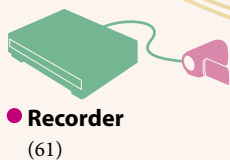
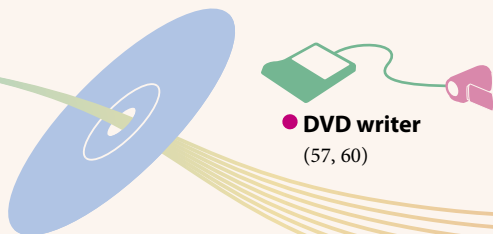
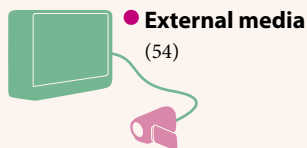
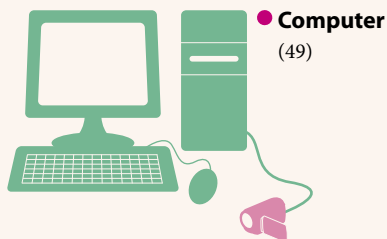

Easy uploading

- **Uploading with a PC when you are out**

PMB Portable

Table of contents

Using the “Handycam” Handbook	2
Searching for information quickly	2
Read this first	3
Notes on use	5
Enjoy useful functions	6

Getting started

Step 1: Charging the battery pack	13
Step 2: Turning the power on, and setting the date and time	17
Changing the language setting	19
Step 3: Preparing the recording media	20
Selecting recording media (HDR-CX160E/CX180E)	20
Inserting a memory card	21

Recording/Playback

Recording	23
Recording movies	24
Shooting photos	26
Playback on the camcorder	27
Operating the camcorder while playing a movie	29
Viewing photos	30
Playing images on a TV	31
List of connection	31
Using “BRAVIA” Sync	33

Advanced operations

Useful functions for recording movies and photos	34
Zooming	34
Recording better images automatically (Intelligent Auto)	34
Selecting high definition image quality (HD) or standard image quality (STD)	35
Selecting the recording mode	35
Using the Tracking focus function	36
Capturing smiles automatically (Smile Shutter)	37
Recording high quality photos during movie recording (Dual Rec)	37
Recording in mirror mode	38

Enjoying a digest of your movies (Highlight Playback).....	38
Changing the settings for Highlight Playback	39
Saving Highlight Playback ( Scenario Save)	40
Converting and sharing Highlight Playback scenes or Highlight scenarios	40
Making good use of your camcorder	41
Deleting movies and photos	41
Protecting recorded movies and photos (Protect)	42
Copying images (HDR-CX160E/CX180E)	43
Dividing a movie	44
Capturing a photo from a movie (HDR-CX160E/CX180E)	45







Saving movies and photos with a computer

Selecting the method for creating a disc (computer).....	46
Creating a disc with one touch (Disc Burn)	48
Importing movies and photos to a computer.....	49
Saving images on a disc	50

Saving images with an external device

Selecting a method for saving images with an external device	52
The devices on which the created disc can be played back.....	53
Saving images on an external media device	54
Saving desired movies and photos	56
Playing back images in the external media device on the camcorder.....	56
Creating a disc with the DVD writer, DVDirect Express.....	57
Performing [DISC BURN OPTION].....	58
Playing back a disc on the DVD writer.....	59
Creating a high definition image quality (HD) disc with a DVD writer, etc., other than DVDirect Express.....	60
Creating a standard definition image quality (STD) disc with a recorder, etc.	61

Customizing your camcorder

Using menus	63
Operating menus	63
Menu lists	64
 Shooting Mode (Items for selecting a shooting mode)	65
 Camera/Mic (Items for customized shooting)	67
 Image Quality/Size (Items for setting up image quality or size)	74
 Playback Function (Items for playback)	76
 Edit/Copy (Items for editing)	76
 Setup (Other setup items)	77

Additional information

 Troubleshooting	84
Self-diagnosis display/Warning indicators	90
Using your camcorder abroad	94
Maintenance and precautions	96
About the AVCHD format	96
About the memory card	96
About the "InfolITHIUM" battery pack	97
About x.v.Color	98
About handling of your camcorder	98

Quick reference

Screen indicators	103
Parts and controls	104
Index	106

Step 1: Charging the battery pack

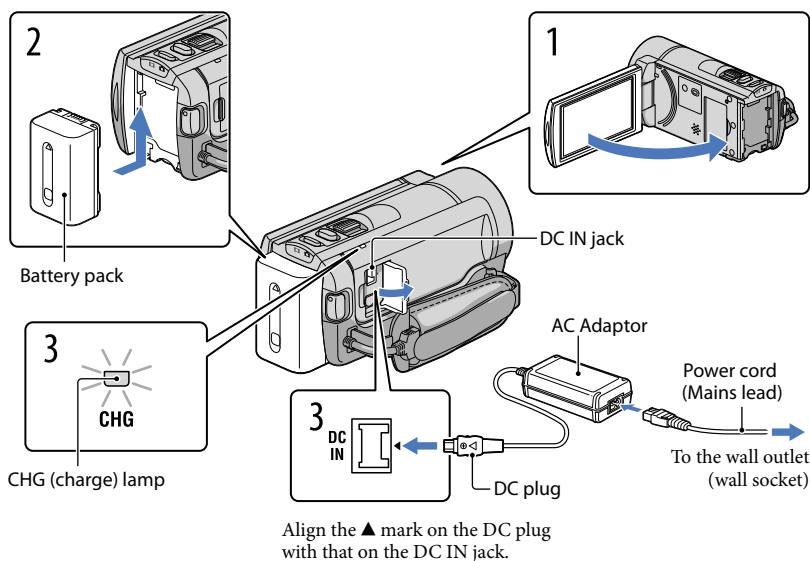

You can charge the “InfoLITHIUM” battery pack (V series) after attaching it to your camcorder.

⚡ Notes

- You cannot attach any “InfoLITHIUM” battery pack other than the V series to your camcorder.

- 1 Turn off your camcorder by closing the LCD screen.
- 2 Attach the battery pack by sliding it in the direction of the arrow until it clicks.
- 3 Connect the AC Adaptor and the power cord (mains lead) to your camcorder and the wall outlet (wall socket).

The CHG (charge) lamp lights up and charging starts. The CHG (charge) lamp turns off when the battery pack is fully charged.

-
- # 4
- When the battery is charged, disconnect the AC Adaptor from the DC IN jack of your camcorder.
-

To charge the battery using your computer

This method is useful when the AC Adaptor is not available.

- ① Turn off the camcorder and attach the battery pack to the camcorder.
- ② Connect the camcorder to a running computer using the Built-in USB Cable.

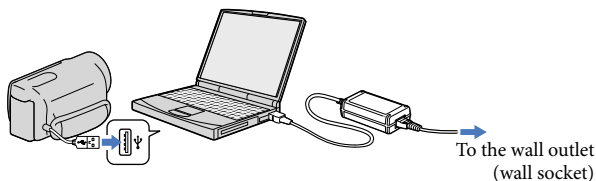

- ③ When the battery is fully charged, disconnect the camcorder from the computer.

⚡ Notes

- Operation with all computers is not assured.
- If you connect the camcorder to a laptop computer that is not connected to a power source, the battery of the laptop computer will continue to use up its charge. Do not leave the camcorder connected to a computer in this manner.
- Charging with a personally assembled computer, with a converted computer, or through a USB hub are not guaranteed. The camcorder may not function correctly depending on the USB device which is used with the computer.

💡 Tips

- You can charge the battery by connecting the Built-in USB Cable to a wall outlet (wall socket) using an AC-U501AD/AC-U50AG USB charger/AC Adaptor (sold separately). You cannot use a Sony CP-AH2R or CP-AL portable power supply device (sold separately) to charge the camcorder.
- The USB charger/AC Adaptor may not be available in some countries/regions.
- The CHG (charge) lamp may not light up when the remaining battery power is too low. In such a case, charge the battery using the supplied AC adaptor.

Charging time

Approximate time (min.) required when you fully charge a fully discharged battery pack.

Battery pack	Charging time	
	AC Adaptor	Built-in USB Cable*
NP-FV50 (supplied)	155	315
NP-FV70	195	600
NP-FV100	390	1050

- The charging times shown in the table above are measured when charging the camcorder at a temperature of 25 °C (77 °F). It is recommended that you charge the battery in a temperature range of 10 °C to 30 °C (50 °F to 86 °F).

* The charging times are measured without using the USB Connection support cable.

Tips

- When your camcorder is on, you can check the approximate amount of remaining battery power with the remaining battery indicator at the upper right on the LCD screen.

To remove the battery pack

Close the LCD screen. Slide the BATT (battery) release lever (①) and remove the battery pack (②).

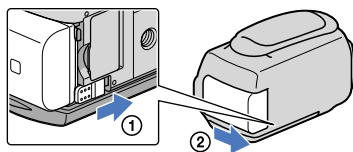

To use a wall outlet (wall socket) as a power source

Make the same connections as “Step 1: Charging the battery pack” (p. 13). Even if the battery pack is attached, the battery pack is not discharged.



Charging the battery pack abroad

You can charge the battery pack in any countries/regions using the AC Adaptor supplied with your camcorder within the AC 100 V - 240 V, 50 Hz/60 Hz range.

Notes

- Do not use an electronic voltage transformer.

Notes on the battery pack

- When you remove the battery pack or disconnect the AC Adaptor, turn the camcorder off and make sure that the  (Movie)/ (Photo) lamps (p. 24), the access lamp (p. 22) are turned off.
- The CHG (charge) lamp flashes during charging under the following conditions:
 - The battery pack is not attached correctly.
 - The battery pack is damaged.
 - The temperature of the battery pack is low.
Remove the battery pack from your camcorder and put it in a warm place.
 - The temperature of the battery pack is high.
Remove the battery pack from your camcorder and put it in a cool place.
- We do not recommend using an NP-FV30, which only allows short recording and playback times, with your camcorder.
- In the default setting, the power turns off automatically if you leave your camcorder without any operation for about 5 minutes, to save battery power ([A. Shut Off], p. 81).

Notes on the AC Adaptor

- Use the nearby wall outlet (wall socket) when using the AC Adaptor. Disconnect the AC Adaptor from the wall outlet (wall socket) immediately if any malfunction occurs while using your camcorder.
- Do not use the AC Adaptor placed in a narrow space, such as between a wall and furniture.
- Do not short-circuit the DC plug of the AC Adaptor or battery terminal with any metallic objects. This may cause a malfunction.

Step 2: Turning the power on, and setting the date and time

1 Open the LCD screen of your camcorder.

Your camcorder is turned on and the lens cover is opened.

- To turn on your camcorder when the LCD screen is open, press POWER.

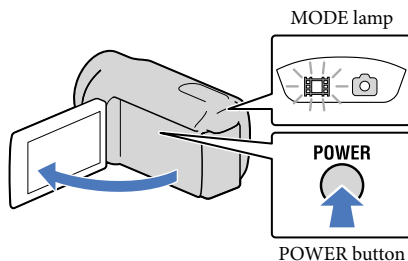

2 Select the desired language, then touch [Next].

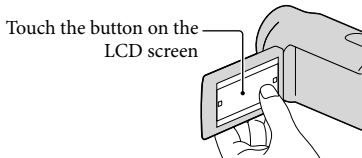

3 Select the desired geographical area with </>, then touch [Next].

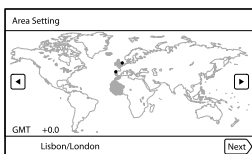

- To set the date and time again, touch **MENU** (MENU) → [Setup] → [Clock Settings] → [Date & Time Setting] → [Date & Time]. When an item is not on the screen, touch **▲** / **▼** until the item appears.

4 Set [Summer Time], then touch [Next].

- If you set [Summer Time] to [On], the clock advances 1 hour.

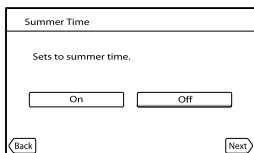

5 Select the date format, then touch [Next].

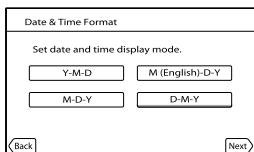

6 Select the date and time, touch \blacktriangle / \blacktriangledown to set the value, then touch [Next] → **OK** *.

- * The confirmation screen appears only when you set the clock for the first time.

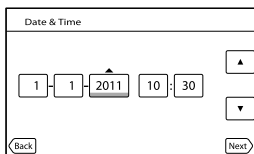

The clock starts.

⚡ Notes

- The date and time does not appear during recording, but they are automatically recorded on the recording media, and can be displayed during playback. To display the date and time, touch **MENU** (MENU) → [Setup] → \square (Playback Settings) → [Data Code] → [Date/Time] → **OK**.
- You can turn off the operation beeps by touching **MENU** (MENU) → [Setup] → 🔊 (General Settings) → [Beep] → [Off] → **OK**.
- If the button you touch does not react correctly, calibrate the touch panel (p. 100).

To turn off the power

Close the LCD screen.





The  (Movie) lamp flashes for a few seconds and the camcorder is turned off.

Tips

- You can turn off the camcorder also by pressing POWER.
- When [Power On By LCD] (p. 81) is set to [Off], turn off your camcorder by pressing POWER.

Changing the language setting

You can change the on-screen displays to show messages in a specified language.

Touch  (MENU) → [Setup] → [ (General Settings)] → [Language Setting] → a desired language →  →  → .

Step 3: Preparing the recording media

The recording media that can be used differs depending on your camcorder. The following icons are displayed on the screen of your camcorder.

HDR-CX130E



Memory card

HDR-CX160E/CX180E



Internal memory



Memory card

* In the default setting, both movies and photos are recorded on this recording media. You can perform recording, playback and editing operations on the selected medium.

Selecting recording media (HDR-CX160E/CX180E)

1 Touch **MENU** (MENU) → [Setup] → [(Media Settings)] → [Media Select].
The [Media Select] screen appears.

2 Touch the desired recording medium, then touch **OK**.
Both movies and photos are recorded on the selected medium.

To check the recording media settings

In either movie recording mode or photo recording mode, the media icon of the selected recording media is displayed at the top right corner of the screen.

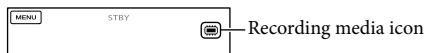



• The icon displayed may vary depending on your model.

Inserting a memory card

⚡ Notes

- Set the recording medium to [Memory Card] to record movies and/or photos on a memory card (HDR-CX160E/CX180E).

Types of memory card you can use with your camcorder

		SD Speed Class	Described in this manual
“Memory Stick PRO Duo” media (Mark2)		—	“Memory Stick PRO Duo” media
“Memory Stick PRO-HG Duo” media			
SD memory card		Class 4 or faster	SD card
SDHC memory card			
SDXC memory card			

- Operation with all memory cards is not assured.
- “Memory Stick PRO Duo” media, half the size of “Memory Stick”, or standard size SD cards can be used for this camcorder.
- Do not attach a label or the like on memory card or memory card adaptor. Doing so may cause a malfunction.
- “Memory Stick PRO Duo” media of up to 32 GB and SD cards of up to 64 GB have been verified to operate with your camcorder.

⚡ Notes

- A MultiMediaCard cannot be used with this camcorder.
- Movies recorded on SDXC memory cards cannot be imported to or played back on computers or AV devices not supporting the exFAT* file system by connecting the camcorder to these devices with the USB cable. Confirm in advance that the connecting equipment is supporting the exFAT system. If you connect an equipment not supporting the exFAT system and the format screen appears, do not perform the format. All the data recorded will be lost.

* The exFAT is a file system that is used for SDXC memory cards.

1 Open the cover, and insert the memory card with the notched edge in the direction as illustrated until it clicks.

- Close the cover after inserting the memory card.

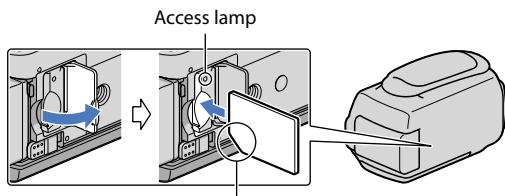

Note the direction of notched corner.

The [Preparing image database file. Please wait.] screen appears if you insert a new memory card. Wait until the screen disappears.

2 Close the cover.

⚡ Notes

- If [Failed to create a new Image Database File. It may be possible that there is not enough free space.] is displayed, format the memory card (p. 77).
- Confirm the direction of the memory card. If you forcibly insert the memory card in the wrong direction, the memory card, memory card slot, or image data may be damaged.
- Do not open the cover during recording.
- When inserting or ejecting the memory card, be careful so that the memory card does not pop out and drop.

To eject the memory card

Open the cover and lightly push the memory card in once.

Recording

In the default setting, movies and photos are recorded on the following media. Movies are recorded with high definition image quality (HD).

HDR-CX130E: Memory card

HDR-CX160E/CX180E: Internal recording media

Tips

- To change the recording media, see page 20 (HDR-CX160E/CX180E).

- 1 Fasten the grip belt.

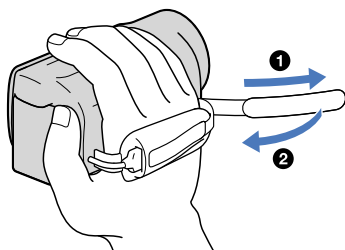

- 2 Open the LCD screen of your camcorder.

Your camcorder is turned on and the lens cover is opened.

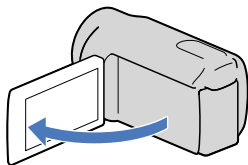

Recording movies

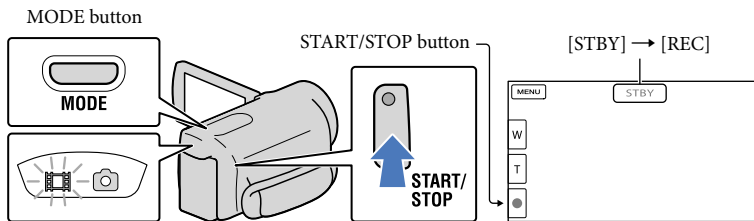

☰ (Movie): When recording a movie

📷 (Photo): When recording a photo

1 Press MODE to turn on the ☰ (Movie) lamp.

2 Press START/STOP to start recording.

To stop recording, press START/STOP again.

To display items on the LCD screen again

Touch anywhere on the screen except the buttons on the LCD screen so that you can use items. You can change the settings using the [Display Setting] menu (p. 74).

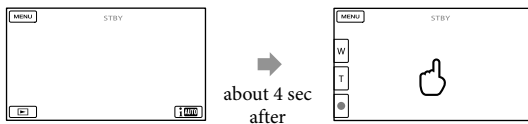

To capture smiles

In the default setting, a photo is automatically recorded when the camcorder detects the smile of a person during movie recording (Smile Shutter, p. 72). When the camcorder detects faces during movie recording, image quality is automatically adjusted ([Face Detection], p. 72).

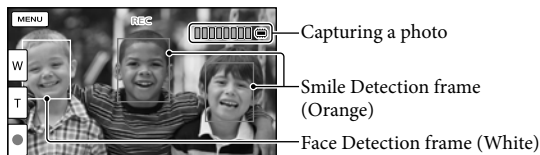

⚡ Notes

- If you close the LCD screen while recording movies, the camcorder stops recording.
- The maximum continuous recordable time of movies is about 13 hours.
- When a movie file exceeds 2 GB, the next movie file is created automatically.
- It will take several seconds until you can start recording after you turn on the camcorder. You cannot operate your camcorder during this time.
- The following states will be indicated if data is still being written onto the recording media after recording has finished. During this time, do not apply shock or vibration to the camcorder, or remove the battery or AC Adaptor.
 - Access lamp (p. 22) is lit or flashing
 - The media icon in the upper right of the LCD screen is flashing

💡 Tips

- You can record photos during movie recording by pressing PHOTO fully (Dual Rec, p. 37).
- [SteadyShot] is set to [Active] in the default setting.
- You can specify the priority face by touching it (p. 36).
- You can capture photos from recorded movies (p. 45).
- You can check the recordable time, estimated remaining capacity, etc., by touching **MENU** (MENU) → [Setup] → [Media Settings] → [Media Info].
- The LCD screen of your camcorder can display recording images across the entire screen (full pixel display). However, this may cause slight trimming of the top, bottom, right and left edges of images when played back on a TV which is not compatible with full pixel display. In this case, set [Guide Frame] to [On] (p. 73), and record images using the outer frame displayed on the screen as a guide.
- To adjust the angle of the LCD panel, first open the LCD panel 90 degrees to the camcorder (①), and then adjust the angle (②).

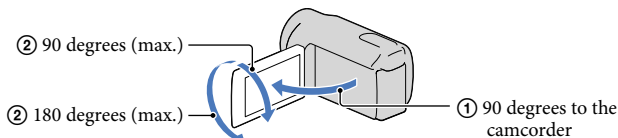

Data code during recording

The recording date, time and condition are recorded automatically on the recording media. They are not displayed during recording. However, you can check them as [Data Code] during playback. To display them, touch **MENU** (MENU) → [Setup] → [Data Code] (Playback Settings) → [Data Code] → a desired setting → **OK**.

Shooting photos

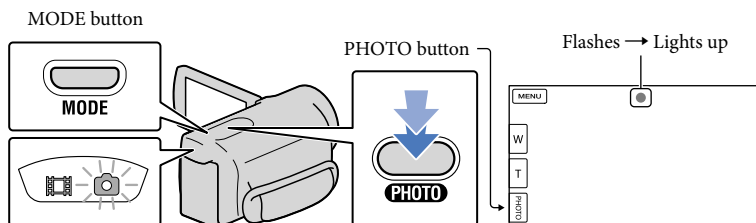

(Movie): When recording a movie
 (Photo): When recording a photo

When disappears, the photo is recorded.

1 Press MODE to turn on the (Photo) lamp.

The LCD screen display switches for photo recording mode, and the screen aspect ratio becomes 4:3.

2 Press PHOTO lightly to adjust the focus, then press it fully.

Tips

- To change the image size, touch **MENU** (MENU) → [Image Quality/Size] → [Image Size] → a desired setting → **OK**.
- You cannot record photos while is displayed.

Playback on the camcorder

You can enjoy the playback of images with powerful sound through the stereo speakers built into the camcorder.

In the default setting, movies and photos that are recorded on the following recording media are played.

HDR-CX130E: Memory card

HDR-CX160E/CX180E: Internal recording media

Tips

- To change the recording media, see page 20 (HDR-CX160E/CX180E).
- The camcorder displays recorded images as an event automatically based on the date and time.

1 Open the LCD screen of your camcorder.

Your camcorder is turned on and the lens cover is opened.

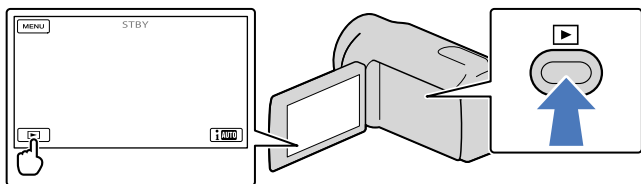

2 Press (View Images).

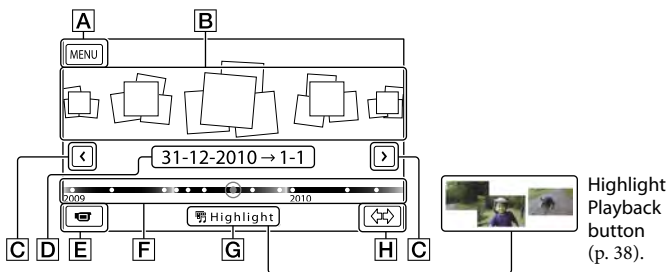

The Event View screen appears after some seconds.

3 Touch / to select the desired event (B).



- A** To the MENU screen
- B** Events
- C**  /  : To the previous/next event
- D** Event name

E Change to the movie/photo recording mode

F Time-line bar

G Highlight Playback button*

H Change Event Scale button

* Appears only when the image quality is set to [**HD** HD Quality].

The Event Index screen appears when you touch the event that is displayed on the center.

- You can also choose an event by touching ● on the time-line bar.
- Touch ⇄ (Change Event Scale) on the bottom right of the screen so that you can change the time range of the time-line bar from one and a half years to three months, which changes the number of the events that can be displayed on the time-line bar.

4 Touch an image you want to view.

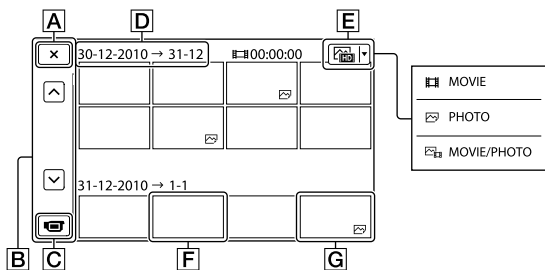

Touch **E** to select the image type to be displayed in the index from [**MOVIE**] (movies only), [**PHOTO**] (photos only), or [**MOVIE/PHOTO**] (movies and photos mixed).

A To go back to the Event View screen

B **◀** / **▶** : Displays the previous/next page (Touching and holding the button scrolls the index screen.)

C Change to the movie/photo recording mode

D Event title



E Switch Image Type button

F Movie

G Photo

- **▶** appears with the movie or photo that was most recently played or recorded. If you touch the movie or photo with **▶**, you can continue playback from the previous time.

Operating the camcorder while playing a movie

You can use the functions shown in the figure below while the camcorder is playing a movie. The figure below will be displayed when you select [ MOVIE/PHOTO] (the default setting) or [ MOVIE] by touching the Switch Image Type button on the Event Index screen.

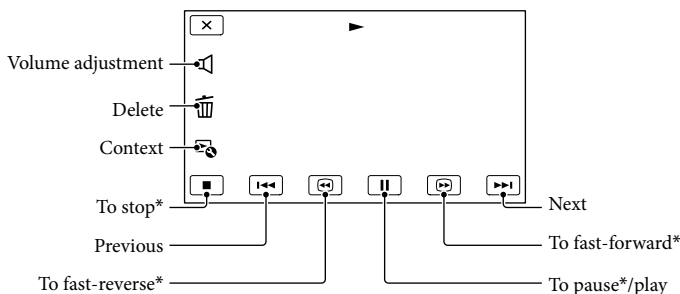







* These buttons can be used only when the camcorder is playing a movie.

Notes

- You may not be able to play back the images with other devices than camcorder.

Tips

- Touching the  button on the playback screen displays functions you can currently use, and allows you to use those functions easily.
- When playback from the selected image reaches the last image, the screen returns to the INDEX screen.
- Touch  /  during pause to play back movies slowly.
- As you repeat touching  /  during playback, movies are played as fast as about 5 times → about 10 times → about 30 times → about 60 times.
- The recording date, time, and shooting conditions are recorded automatically during recording. This information is not displayed during recording, but you can display it during playback by touching **MENU** (MENU) → [Setup] → [ (Playback Settings)] → [Data Code] → a desired setting → **OK** → **X**.
- In the default setting, a protected demonstration movie is pre-recorded (HDR-CX160E/CX180E).

To adjust the sound volume of movies

While playing back movies, touch  → adjust with  /  → **X**.

Viewing photos

You can use the functions shown in the figure below while you are viewing photos. The figure below will be displayed when you select [PHOTO] by touching the Switch Image Type button on the Event Index screen.

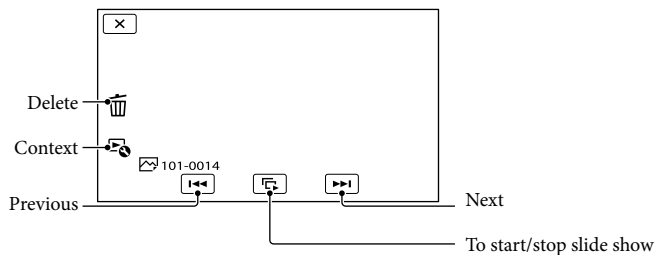

Tips

- To repeat Slideshow, touch  → [Slideshow Set].

Playing images on a TV

Connection methods and the image quality (high definition (HD) or standard definition (STD)) viewed on the TV screen differ depending on what type of TV is connected, and the connectors used.

Output connectors on the camcorder

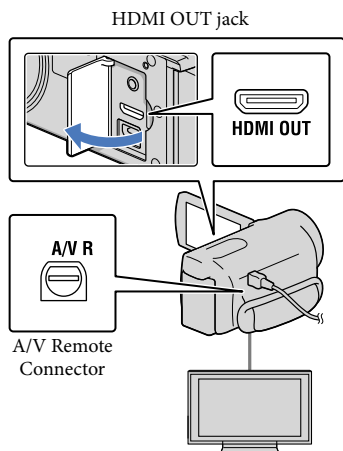

List of connection

Connecting to a high definition TV

When the recording quality is high definition image quality (HD), the movies are played back in high definition image quality (HD). When the recording quality is standard image quality (STD), the movies are played back in standard definition image quality (STD).

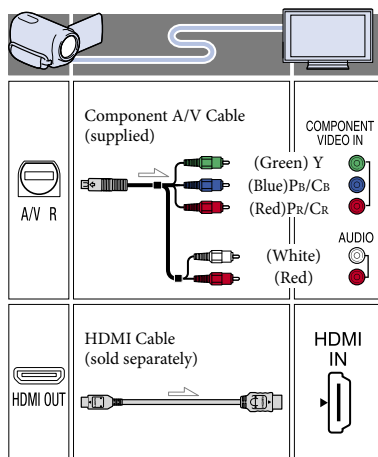

1 Switch the input on the TV to the connected jack.

- Refer to the instruction manuals of the TV.

2 Connect the camcorder to a TV.

- Use the supplied AC Adaptor as the power source (p. 15).

3 Play a movie or a photo on the camcorder (p. 27).

Connecting to a non-high-definition 16:9 (wide) or 4:3 TV

When movies are recorded with high definition image quality (HD), they are played back in standard definition image quality (STD). When movies are recorded with standard image quality (STD), they are played back in standard definition image quality (STD).

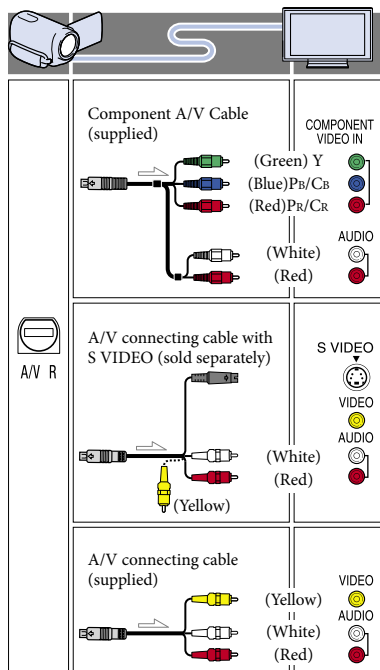

When you connect with component A/V cable

- If you connect only component video plugs, audio signals are not output. Connect the white and red plugs to output audio signals.
- Select the [Component] setting for the component input jack you are using. Touch **MENU** (MENU) → [Setup] → [↔ (Connection)] → [Component] → a desired setting → **OK** to make the setting.

When you connect with HDMI cable

- Use an HDMI cable with the HDMI logo.
- Use an HDMI mini connector on one end (for the camcorder), and a plug suitable for connecting your TV on the other end.
- Copyright-protected images are not output from the HDMI OUT jack of your camcorder.
- Some TVs may not function correctly (e.g., no sound or image) with this connection.
- Do not connect the camcorder HDMI OUT jack to an external device HDMI OUT jack, as malfunction may result.

To set the aspect ratio according to the connected TV (16:9/4:3)

- Set [TV Type] to [16:9] or [4:3] according to your TV (p. 79).

When you connect with A/V connecting cable with S-Video

- When the S VIDEO plug (S VIDEO channel) is connected, audio signals are not output. To output audio signals, connect the white and red plugs to the audio input jack of your TV.
- This connection produces higher resolution images compared with the A/V connecting cable.

When your TV is monaural (When your TV has only one audio input jack)

- Connect the yellow plug of the A/V connecting cable to the video input jack and connect the white (left channel) or red (right channel) plug to the audio input jack of your TV or VCR.

When connecting to your TV via a VCR

- Connect your camcorder to the LINE IN input on the VCR using the A/V connecting cable. Set the input selector on the VCR to LINE (VIDEO 1, VIDEO 2, etc.).

⚡ Notes

- When you play back standard definition image quality (STD) movies on a 4:3 TV that is not compatible with the 16:9 signal, record movies with 4:3 aspect ratio. Touch **MENU** (MENU) → [Image Quality/Size] → [Wide Mode] → [4:3] → **OK** (p. 75).
- When the A/V connecting cable is used to output movies, movies are output with standard definition image quality (STD).

If your TV/VCR has a 21-pin adaptor (EUROCONNECTOR)

Use a 21-pin adaptor (sold separately) to view playback pictures.

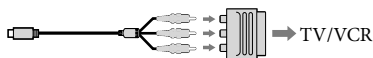

💡 Tips

- If you connect your camcorder to the TV using more than one type of cable to output images, the order of priority of the TV input jacks is as follows:
HDMI → component → S VIDEO → video
- HDMI (High Definition Multimedia Interface) is an interface to send both video/audio signals. The HDMI OUT jack outputs high quality images and digital audio.

Using "BRAVIA" Sync

You can operate your camcorder with the remote commander of your TV by connecting your camcorder to a "BRAVIA" Sync compatible TV launched in 2008 or later with the HDMI cable.

You can operate the menu of your camcorder by pressing the SYNC MENU button of the remote commander of your TV. You can display the camcorder screens such as Event View, play selected movies or display selected photos by pressing up/down/left/right/enter buttons of the remote commander of your TV.

⚡ Notes

- There may be some operations you cannot do with the remote commander.
- To set your camcorder, touch **MENU** (MENU) → [Setup] → [↔ (Connection)] → [CTRL FOR HDMI] → [On] (the default setting) → **OK** → **X**.
- Also set your TV accordingly. Refer to the instruction manual of the TV for details.
- The operation of "BRAVIA" Sync differs according to each model of BRAVIA. Refer to the instruction manual of your TV for details.

💡 Tips

- If you turn off the TV, your camcorder is turned off simultaneously.

Useful functions for recording movies and photos

Zooming

You can magnify images up to 42 times the original size with the power zoom lever. You can magnify images also with the / on the LCD screen.

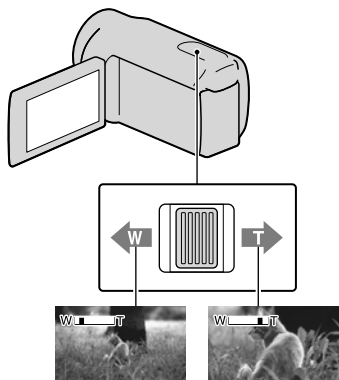



Wider range of view
(Wide angle)

Close view
(Telephoto)

Move the power zoom lever slightly for a slower zoom. Move it further for a faster zoom.

Notes

- Be sure to keep your finger on the power zoom lever. If you move your finger off the power zoom lever, the operation sound of the power zoom lever may also be recorded.
- You cannot change the zoom speed with the / button on the LCD screen.
- The minimum possible distance between camcorder and subject while maintaining sharp focus is about 1 cm (about 13/32 in.) for wide angle and about 80 cm (about 31 1/2 in.) for telephoto.

- You can magnify images up to 30 times using optical zooming, unless [ SteadyShot] is set to [Active].

Tips

- You can set [Digital Zoom] if you want to zoom to a greater level.



Recording better images automatically (Intelligent Auto)

When you turn the camcorder toward the subject, the camcorder records using the optimum combination of the three detection modes: Face detection, Scene detection and Camera-shake detection ([On] is the default setting). When the camcorder detects the subject, the icons that correspond to the detected condition are displayed.

Touch  at the right bottom on the recording screen of movies or photos.









Face detection

 (Portrait),  (Baby)

The camcorder detects faces, and adjusts the focus, color, and exposure.

Scene detection

 (Backlight),  (Landscape),  (Twilight),  (Spotlight),  (Low light),  (Macro)

The camcorder selects the most effective setting automatically, depending on the scene.

Camera-shake detection

歩 (Walk), 足 (Tripod)

The camcorder detects whether camera-shake occurs or not, and makes the optimum compensation.

Notes

- The camcorder may not detect the expected scene or subject, depending on the recording conditions.

Selecting high definition image quality (HD) or standard image quality (STD)

You can select the desired image quality from the high definition image quality (HD) that enables you to record fine images, or the standard definition image quality (STD) that has more compatibility with various playback devices ([**HD**: HD Quality] is the default setting). Change the image quality according to the recording situation or the playback device.

1 Touch **MENU** (MENU) → [Image Quality/Size] → [**HD**:/**STD**] Setting).

2 Touch [**HD**: HD Quality] to record high definition image quality (HD) images, or touch [**STD**: STD Quality] to record standard definition image quality (STD) images.

3 Touch **OK** → **OK**.

Recording image quality is changed.

Tips

- You can record, play, or edit movies in the selected image quality only. To record, play, or edit movies in another image quality, change this setting.

Selecting the recording mode

You can switch the recording mode to select the movie quality when recording high definition image quality (HD) movies ([Standard **HQ**] is the default setting). The recording time of the recording media is changed depending on the recording mode.

1 Touch **MENU** (MENU) → [Image Quality/Size] → [**REC Mode**].

2 Touch the desired recording mode.

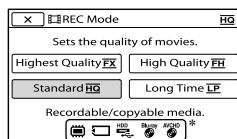

The recording modes available will depend on the selected [**FR**] Frame Rate] (p.74).

- * appears on a medium icon if a movie recorded with the selected recording mode cannot be saved on that medium.

3 Touch **OK**.

Recording modes and the media

Types of media that images can be saved on will depend on the recording mode selected.

For details on a save operation using the external devices, see page 52.

Types of media	Recording mode		
	PS*	FX	FH/ HQ/LP
On this camcorder			
Internal recording media	✓	✓	✓
Memory card	✓	✓	✓
On external devices			
External media (USB storage devices)	✓	✓	✓
Blu-ray discs	—	✓	✓
AVCHD recording discs	—	—	✓

* [PS] can be set only when [Frame Rate] is set to [50p].

Tips

- Movies are recorded with the 1920 × 1080/50p format when the PS mode of high definition image quality (HD) is selected, and with AVCHD 1920 × 1080/50i when the FX or FH mode is selected. When the HQ or LP mode of high definition image quality (HD) is selected, movies are recorded with AVCHD 1440 × 1080/50i format.
- You can select the following high definition image quality (HD) recording mode.
 - [50p Quality **PS**] (AVC HD 28M (PS))
 - [Highest Quality **FX**] (AVC HD 24M (FX))
 - [High Quality **FH**] (AVC HD 17M (FH))
 - [Standard **HQ**] (AVC HD 9M (HQ)) (the default setting)
 - [Long Time **LP**] (AVC HD 5M (LP))

- The recording mode of the standard image quality (STD) is limited to the following value.
 - [Standard **HQ**] (STD 9M (HQ))
- “M,” such as in “24M,” means “Mbps.”

Using the Tracking focus function

If you touch the subject you want to track on the LCD screen, the camcorder tracks that subject and records a movie.

When you touch a face

A double-lined frame appears around the face and the camcorder adjusts the focus, color and exposure automatically.

When you touch a point other than a face

A double-lined frame appears at the point you touch and the camcorder adjusts the focus automatically.



Touch the face or a point you want to track.



The double-lined frame is displayed.

To stop tracking, touch  that appears on the right of the LCD screen.

⚡ Notes

- The subject you touched may not be detected, depending on the surrounding brightness or hairstyle of the subject. In this case, touch the subject again when you record.
- If you want to track a face, set the [Face Detection] setting to other than [Off] ([Auto] is the default setting).

💡 Tips

- The double-lined frame around a face targeted for possible smile detection shot turns orange.
- If the face you touched disappears from the LCD screen, the subject selected in [Face Detection] (p. 72) has priority. If the face you touched returns to the screen, that face has priority.

Capturing smiles automatically (Smile Shutter)

A photo is recorded automatically when the camcorder detects the smile of a person during movie recording ([Dual Capture] is the default setting) (page 72). An orange frame appears around a face targeted for possible smile detection shot.



⚡ Notes

- When the frame rate and the recording mode are set to [50i]/[Highest Quality **FX**] or [50p]/[50p Quality **PS**], you cannot use the Smile Shutter function while recording movies.
- Smiles may not be detected depending on recording conditions, subject conditions, and the setting of your camcorder.

💡 Tips

- You can select the subject that has priority for face detection and smile detection with [Face Detection] (p. 72). When you specify the priority subject by touching the detection frame on the LCD screen, the face with a double-lined frame has priority.
- If a smile is not detected, set [Smile Sensitivity] (p. 73).

Recording high quality photos during movie recording (Dual Rec)

You can record photos during movie recording by pressing PHOTO.

⚡ Notes

- 📷 may appear when the capacity of the recording media is not enough or when you record photos continuously. You cannot record photos while 📷 is displayed.
- Depending on the [📷 REC Mode] or [📷 Frame Rate] selected, 📷 appears on the LCD screen and you may not be able to use the Dual Rec function.

💡 Tips





- When the MODE lamp is set to 📷 (Movie), the size of photos becomes [3.0M] (16:9) or [2.2M] (4:3).
- You can record photos during recording standby in the same way as when the 📷 (Photo) lamp is turned on.

Enjoying a digest of your movies (Highlight Playback)

Your camcorder selects Highlight Playback scenes at random, puts them together, and plays them back as a digest of your high definition image quality (HD) movies and photos with music and visual effects. If you like the Highlight Playback you have just seen, you can save it as a “scenario” and play it back repeatedly. Furthermore, you can share the Highlight Playback scenes or scenarios easily using other media by converting the data format of the Highlight Playback scenes or scenarios, which allows you to upload the data to the Web or create DVDs.

Tips

- Touching the  button on the playback screen displays functions you can currently use, and allows you to use those functions easily.

- 1 Open the LCD screen of your camcorder.
- 2 Press  (View Images).
- 3 Touch  /  (①) to select the desired Event, then touch  [Highlight] (②).

The camcorder starts Highlight Playback of the event that was displayed in the center of the Event View.

Recording in mirror mode

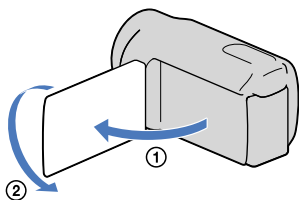

Open the LCD panel 90 degrees to the camcorder (①), then rotate it 180 degrees to the lens side (②).

Tips

- A mirror-image of the subject appears on the LCD screen, but the image will be normal when recorded.

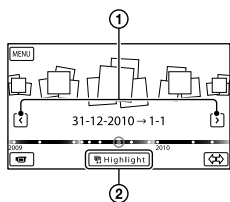

The LCD screen during Highlight Playback

Volume adjustment

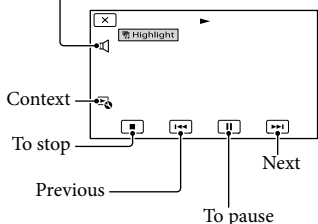

To stop a Highlight Playback

To pause, touch **II**.

To stop, touch **■**.

To watch a Highlight Playback again

Touch [Replay] on the screen after a Highlight Playback has finished.

Notes

- Highlight Playback scenes will change each time you select a Highlight Playback.

Changing the settings for Highlight Playback

You can make various settings for Highlight Playback.

Touch **☰** → [Highlight Setting] during Highlight Playback.

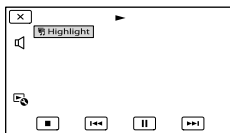

You can set the following items.

- [Playback Range]

Set the range of movies to be played by selecting the range of events from which event and to which event, to be used as the playback range, then touch **OK**.

If no range is set, the camcorder plays images in the date range of the event selected on the Event View as the playback range.
- [Theme]

You can select a theme for Highlight Playback. The music category is selected automatically according to the theme.
- [Music]

You can select and add music.
- [Audio mix]

The original sound is played back with the music.

Touch **<** / **>** to adjust the balance between the original sound and the music.
- [Length]

You can set the length of the Highlight Playback segment.
- [Highlight Point]

You can set the points in a movie or photo that will be used in a Highlight Playback. Play the desired movie or photo, and then do the following.

 - Movie: Play the desired movie, and then touch **II** → **OK** at the point you want to use in a Highlight Playback.

– Photo: Play the photo you want to use in a Highlight Playback, and then touch **OK**.

⚡ Notes

- The audio used for the Highlight Playback will be converted to 2ch stereo.
- The [Playback Range] setting is cleared when the Highlight Playback stops.
- When you connect the camcorder to an external device, such as a TV, and watch Highlight Playback or Highlight Scenario, these images do not appear on the LCD screen of the camcorder.

💡 Tips

- You can select [Highlight Setting] on the screen after a Highlight Playback has finished.

Saving Highlight Playback (Scenario Save)

You can save a Highlight Playback as a “Scenario.”

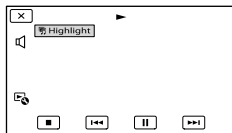

Touch  → [ Scenario Save] during Highlight Playback.



To play back a saved scenario

Touch **MENU** (MENU) → [Playback Function] → [ Scenario], select the desired scenario, and then touch **OK**.

To erase a saved scenario

Touch [ Scenario Erase] on the screen after the scenario playback you want to erase has finished, or touch  while playing the scenario you want to erase, then select [Erase].

Converting and sharing Highlight Playback scenes or Highlight scenarios

You can convert the data format of Highlight Playback or previously saved Highlight scenarios which allows you to share the converted data using other media by creating DVDs or uploading the data to the Web (Highlight Movie).

- 1 Touch [Save and Share] on the screen after Highlight Playback or Highlight scenario playback has finished.

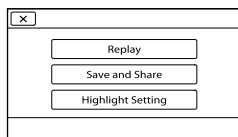

- You can select [Save and Share] by touching the  button on the screen while Highlight Playback scenes or saved Highlight scenarios are played back.

- 2 Touch **OK**.

The camcorder starts converting the data to the target format.

Making good use of your camcorder

To upload a Highlight Movie to the Web

After the conversion process has finished, touch [Share] → [Web Upload], then follow the instructions that appear on the LCD screen.

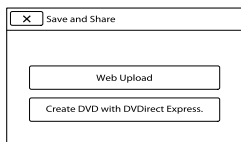

To create a DVD using DVDirect Express

After the conversion process has finished, touch [Share] → [Create DVD with DVDirect Express.], then follow the instructions that appear on the LCD screen.

To watch a Highlight Movie again

Touch [Watch] after the conversion process has finished.



To watch a Highlight Movie by selecting one from a list of "Highlight Movie"

Touch **MENU** (MENU) → [Playback Function] → [Highlight Movie] → touch the desired Highlight Movie.

Notes

- Converted data will be changed to standard image quality (STD).

Deleting movies and photos

You can free media space by deleting movies and photos from recording media.

Notes

- You cannot restore images once they are deleted. Save important movies and photos in advance.
- Do not remove the battery pack or the AC Adaptor from your camcorder while deleting the images. It may damage the recording media.
- Do not eject the memory card while deleting images from the memory card.
- You cannot delete protected movies and photos. Undo the protection of the movies and photos to delete them, before you try to delete them (p. 43).
- The demonstration movie on your camcorder is protected (HDR-CX160E/CX180E).
- If you delete movies/photos that are included in saved scenarios (p. 40), the scenarios will also be deleted.

Tips

- If you start playing back an image by selecting it from the Event Index screen, you can delete the image using  on the playback screen.
- To delete all images recorded in the recording media, and recover all the recordable space of the media, format the media (p. 77).
- Reduced-size images which enable you to view many images at the same time on an index screen are called "thumbnails."

1 Touch **MENU** (MENU) → [Edit/Copy] → [Delete].

2 To select and delete movies, touch [Multiple Images] → [**HD**: MOVIE]/[ PHOTO]/[**STD**: MOVIE/PHOTO].

- When [**HDD** / **STD** Setting] is set to [**STD** STD Quality], **STD** appears instead of **HDD**.

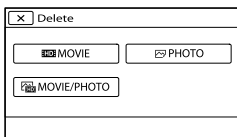

- Touch and display the ✓ mark on the movies or photos to be deleted.

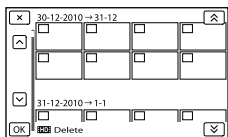

- Touch and hold the desired thumbnail so that you can confirm the image. Touch **X** to return to the previous screen.

- Touch **OK** → **OK** → **OK**.

Protecting recorded movies and photos (Protect)

Protect movies and photos to avoid deleting them by mistake.

ⓧ will be displayed on the protected images.

- Touch **MENU** (MENU) → [Edit/ Copy] → [Protect].

- To select and protect movies, touch [Multiple Images] → [**HDD** MOVIE] / [**PHOTO**] / [**MOVIE/PHOTO**].

- When [**HDD** / **STD** Setting] is set to [**STD** STD Quality], **STD** appears instead of **HDD**.

- Touch the movies and photos to be protected.

✓ is displayed on the selected images.

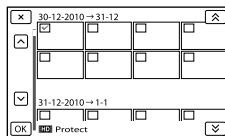

- Touch and hold the desired thumbnail so that you can confirm the image. Touch **X** to return to the previous screen.

- Touch **OK** → **OK** → **OK**.

To delete all movies/photos in an event at one time

- In step 2, touch [All In Event].

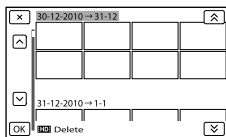

- Touch **^** / **v** to select the desired event, then touch **OK**.
 - Touch and hold the desired thumbnail so that you can confirm the image. Touch **X** to return to the previous screen.
- Touch **OK** → **OK**.

To undo the protection of movies and photos

Touch the movie or photo marked with ✓ in step 3.

✓ disappears.

To protect all movies/photos in an event at one time

① In step 2, touch [Set All In Event].

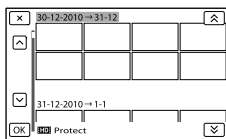

② Touch / to select the desired event, then touch .

- Touch and hold the desired thumbnail so that you can confirm the image. Touch to return to the previous screen.

③ Touch → .

To undo the protection of an event

In step 2 above, touch [Remove All In Event], select the desired movies/photos, then touch → → .

Copying images (HDR-CX160E/CX180E)

You can copy images stored in the internal recording medium of your camcorder to a memory card.

Insert a memory card into your camcorder before the operation.

Notes

- When you record an image on the memory card for the first time, create the image database file by touching (MENU) → [Setup] → (Media Settings) → [Repair Img. DB F.] → [Memory Card].

- Connect your camcorder to the wall outlet (wall socket) using the supplied AC Adaptor to prevent your camcorder from running out of power during dubbing.

Tips

- The original copy of the image will not be deleted after the copy operation has been completed.
- The images recorded by this camcorder and stored onto the recording media are called “original.”

1 Touch (MENU) → [Edit/Copy] → [Copy].

The media selection screen appears.

2 Touch the desired item to select the source and the destination for the images to be copied.

[Int. Memory → Memory Card]
The [Copy] screen appears.

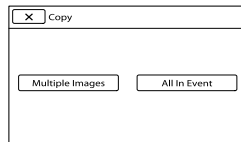

3 Touch the type of copy operation.

[Multiple Images]: To select multiple images and copy them
[All In Event]: To copy all images of a specified event

4 Touch the type of image you want to copy.

5 Select the image to be copied.

[Multiple Images]: Touch the image to be copied, and mark it with ✓. You can select multiple images.



- Touch the desired thumbnail so that you can confirm the image. Touch **✕** to return to the selection screen.

[All In Event]: Select the Event to be copied, then touch **OK**. You cannot select multiple Events.

6 Touch **OK** → **OK** → **OK**.

Tips

- To check the movies or photos after the copy operation is finished, use [Media Select] to select the destination medium, and then play the copied movies/photos (p. 20).
- You can copy images to various types of external media (p. 52).

Dividing a movie

You can divide a movie to delete unnecessary parts.

1 Touch **⏏** → **[Divide]** on the movie playback screen.

2 Touch **⏏** at the point where you want to divide the movie into scenes.

The movie pauses.

3 Touch **⏮**/**⏭** to adjust the dividing point with more precision.

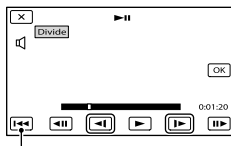

Returns to the beginning of the selected movie

4 Touch **OK** → **OK**.

Notes

- You cannot restore movies once they are divided.
- You cannot divide protected movie. Undo the protection of the movie to divide it, before you try to divide it (p. 43).
- Do not remove the battery pack or the AC Adaptor from your camcorder while dividing the movie. It may damage the recording media.
- Do not eject the memory card while dividing movies on the memory card.
- A slight difference may occur from the point where you touch **⏏** and the actual dividing point, as your camcorder selects the dividing point based on about half-second increments.
- If you divide movies that are included in saved scenarios (p. 40), the scenarios will be deleted.
- Only simple editing is available on the camcorder. Use the supplied software “PMB” for more advanced editing.

Capturing a photo from a movie (HDR-CX160E/CX180E)



You can capture images from movies recorded in the internal recording medium.

- 1 Touch  → [Photo Capture] that appears on the playback screen of a movie.

The [Photo Capture] screen appears.

- 2 Touch  at the point where you want to capture a photo.

The movie pauses.

- 3 Touch  /  to adjust the capturing point with more precision.

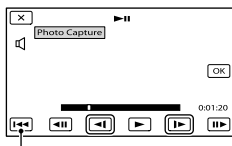

Returns to the beginning of the selected movie

- 4 Touch .







When capturing is finished, the screen returns to pause.

Notes

- The image size is fixed based on the image quality of the movie. If the movie was recorded with one of the following image quality levels, the image size will be set as shown below.
 - High definition image quality (HD): 2.1 M (16:9)
 - Wide aspect ratio (16:9) with standard definition image quality (STD): 0.2 M (16:9)
 - 4:3 aspect ratio with standard definition image quality: 0.3 M (4:3)
- The recording medium where you want to save photos should have enough free space.
- The recording date and time of captured photos is the same as the recording date and time of the movies.
- If the movie you are capturing from has no data code, the recording date and time of the photo will be the date and time you captured from the movie.

Selecting the method for creating a disc (computer)

Several methods for creating a high definition image quality (HD) disc or a standard definition image quality (STD) disc from high definition image quality (HD) movies or photos recorded on your camcorder are described here. Select the method that suits your disc player.

Disc type	Choosing a method	Player
 <p>To save images on a Blu-ray disc with high definition image quality (HD)</p>	<ol style="list-style-type: none"> ① Importing movies and photos to a computer (p. 49) ↓ ② Creating a Blu-ray disc* with high definition image quality (HD) (p. 51) 	<p>Blu-ray disc playback devices (a Sony Blu-ray disc player, PlayStation®3, etc.)</p> 
 <p>To save images on a AVCHD recording disc with high definition image quality (HD)</p>	<p>Creating a disc with one touch (Disc Burn) (p. 48)</p> <hr/> <ol style="list-style-type: none"> ① Importing movies and photos to a computer (p. 49) ↓ ② Creating a AVCHD recording disc with high definition image quality (HD) (p. 50) 	<p>AVCHD format playback devices (a Sony Blu-ray disc player, PlayStation®3, etc.)</p> 
 <p>To copy images on a disc in standard definition image quality (STD) to distribute</p>	<ol style="list-style-type: none"> ① Importing movies and photos to a computer (p. 49) ↓ ② Creating a standard definition image quality (STD) disc (p. 50) 	<p>Ordinary DVD playback devices (a DVD player, a computer that can play DVDs, etc.)</p> 

* To create a Blu-ray disc, the BD Add-on Software for "PMB" must be installed (p. 51).

Discs you can use with “PMB”

You can use 12 cm discs of following type with “PMB.” For Blu-ray disc, see page 51.

Disc type	Features
DVD-R/DVD+R/DVD+R DL	Unrewritable
DVD-RW/DVD+RW	Rewritable

Notes

- Always maintain your PlayStation®3 to use the latest version of the PlayStation®3 system software.
- The PlayStation®3 may not be available in some countries/regions.

Creating a disc with one touch

(Disc Burn)

Movies and photos recorded on your camcorder that have not yet been saved with Disc Burn function can be saved on a disc automatically. Movies and photos are saved on a disc with their recorded image quality.

⚡ Notes

- High definition image quality (HD) movies (the default setting) will make an AVCHD recording disc.
- You cannot create AVCHD recording discs from movies recorded with [HD FX] or [50p Quality PS] mode of [REC Mode].
- Creating a Blu-ray disc is not available with Disc Burn.
- To create a standard definition image quality (STD) disc from high definition image quality (HD) movies, import movies to a computer first (p. 49), and then create a standard definition image quality (STD) disc (p. 35).
- Install "PMB" beforehand, however, do not start "PMB."
- Connect your camcorder to the wall outlet (wall socket) using the supplied AC Adaptor for this operation (p. 15).
- With Disc Burn function on your camcorder, you can save movies and photos recorded on recording medium selected with the [Media Select] menu.

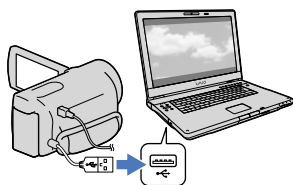

3 Touch [Disc Burn] on the camcorder screen.

4 Follow the instructions on the computer screen.

⚡ Notes

- Movies and photos are not saved on the computer when you perform Disc Burn.

1 Turn on your computer, and place an unused disc on the DVD drive.

- See page 47 for the type of discs you can use.
- If any other software than "PMB" starts automatically, shut it down.

2 Turn on your camcorder, then connect the camcorder to the computer using the Built-in USB Cable.

Importing movies and photos to a computer

Movies and photos recorded on your camcorder can be imported to a computer. Turn on the computer beforehand.

⚡ Notes

- Connect your camcorder to the wall outlet (wall socket) using the supplied AC Adaptor for this operation (p. 15).

- 1 Turn on your camcorder, then connect the camcorder to the computer using the Built-in USB Cable.

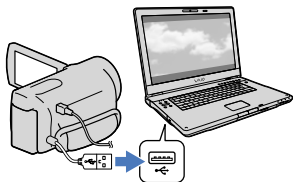

The [USB Select] screen appears on the camcorder screen.

- 2 Touch [USB Connect] on the camcorder screen.

- Prior to the connection, select the recording medium with image data to import to the computer using the [Media Select] menu (HDR-CX160E/CX180E).
- If the [USB Select] screen does not appear, touch **MENU** (MENU) → [Setup] → [↔] (Connection) → [USB Connect].

The window for import appears on the computer screen.

If you want to change the location where imported media files will be saved, click [PMB] → [Tools] → [Settings...] → [Import media files to] → [Browse...], then select the desired location.

- 3 Click [Import].

- Refer to “PMB Help” for details.



Movies and photos are imported to your computer. When the operation is completed, the “PMB” screen appears.

Saving images on a disc

You can select movies that have been imported to a computer and save them on a disc.

1 Turn on your computer, and place an unused disc on the DVD drive.

- See page 46 for the type of discs you can use.
- If any other software than “PMB” starts automatically, shut it down.

2 Start “PMB.”

3 Click [Calendar] or [Index] to select the date or folder, and select the movie you want to save on the disc.

- High definition image quality (HD) movies are marked with **HD**.
- To select plural movies, hold the Ctrl key down and click thumbnails.

4 Click  (Create Disc) to select the type of disc you want to use.

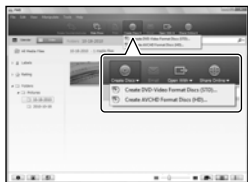

The movie selection window appears. [Create AVCHD Format Discs (HD)]: You can save movies with high definition image quality (HD) on a DVD disc.

[Create DVD-Video Format Discs (STD)]:

You can save movies with standard definition image quality (STD) on a DVD disc. You can select high definition image quality (HD) movies as sources. However, saving such movies will take longer than the actual length of the movies, because the image quality must be converted from high definition (HD) to standard definition (STD) when saving the movie on the disc.

- To add movies to the previously selected ones, select the movies in the main window and drag and drop onto the window for selecting movies.

5 Follow the instructions on the screen to create a disc.

- It may take a long time to create a disc.

Playing an AVCHD recording disc on a computer

You can play back AVCHD recording discs using “Player for AVCHD” that is installed together with “PMB.”

To start “Player for AVCHD”

Click [Start] → [All Programs] → [PMB] → [PMB Launcher] → [View] → [Player for AVCHD].

See the “Player for AVCHD” help on the operation.

- Movies may not be played smoothly depending on the computer environment.

Creating a Blu-ray disc

You can create a Blu-ray disc with a high definition image quality (HD) movie previously imported to a computer (p. 49). To create a Blu-ray disc, the BD Add-on Software for “PMB” must be installed. Click [BD Add-on Software] on the installation screen of “PMB,” and install this plug-in according to the on-screen instructions.

- Connect your computer to the internet when you install [BD Add-on Software].



Place an unused Blu-ray disc in the disc drive, and click  → [Create Blu-ray Disc (HD)] in step 4 of “Saving images on a disc” (p. 50). Other procedures are the same as that for creating an AVCHD disc.

- Your computer must support the creation of Blu-ray discs.
- BD-R (unrewritable) and BD-RE (rewritable) media are available for creating Blu-ray discs. You cannot add contents to either type of disc after creating the disc.



Copying a disc

You can copy a recorded disc to another disc using “Video Disc Copier.” Click [Start] → [All Programs] → [PMB] → [PMB Launcher] → [Disc Creation] → [Video Disc Copier] to start the software. See “Video Disc Copier” help on the operation.

- You cannot copy high definition image quality (HD) movies by converting them to standard definition image quality (STD).
- You cannot copy to a Blu-ray disc.

Selecting a method for saving images with an external device

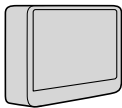
You can save high definition image quality (HD) movies using an external device. Select the method to be used according to the device.

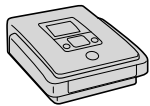
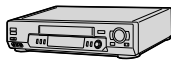
External devices	Connecting cable	Page
 <p>External media device Saving images on an external media device with high definition image quality (HD).</p>	USB Adapter cable VMC-UAM1 (sold separately)	54
 <p>DVDirect Express DVD writer Saving images on a DVD disc with high definition image quality (HD).</p>	Built-in USB cable of the DVDirect Express	57
 <p>DVD writer other than DVDirect Express Saving images on a DVD disc with high definition image quality (HD) or with standard definition image quality (STD).</p>	Built-in USB Cable	60
 <p>Hard disk recorder, etc. Saving images on a DVD disc with standard definition image quality (STD).</p>	A/V connecting cable (supplied)	61

Movies that are recorded with standard definition image quality (STD)

Use the A/V connecting cable to connect the camcorder to an external device in which images are saved.

⚡ Notes

- The AVCHD recording disc can be played back only on AVCHD format compatible devices.
- Discs with high definition image quality (HD) images recorded should not be used in DVD players/recorders. Because DVD players/recorders are not compatible with the AVCHD format, DVD players/recorders may fail to eject the disc.
- Delete the demonstration movie when copying or creating discs. If it is not deleted, the camcorder may not operate correctly. However, you cannot recover the demonstration movie once you delete it.

The types of media on which images are saved

Refer to “Recording modes and the media” on page 36.

The devices on which the created disc can be played back

DVD disc with high definition image quality (HD)

AVCHD format playback devices, such as a Sony Blu-ray disc player or a PlayStation®3.

DVD disc with standard definition image quality (STD)

Ordinary DVD playback devices, such as a DVD player.

Notes

- Always maintain your PlayStation®3 to use the latest version of the PlayStation®3 system software.
- The PlayStation®3 may not be available in some countries/regions.

Saving images on an external media device

You can save movies and photos on an external media device (USB storage devices), such as an external hard disk drive. You can also play back images on the camcorder or another playback device.

⚡ Notes

- For this operation, you need the USB Adaptor Cable VMC-UAM1 (sold separately).
- The USB Adaptor Cable VMC-UAM1 may not be available in some countries/regions.
- Connect your camcorder to the wall outlet (wall socket) using the supplied AC Adaptor (p. 15).
- Refer to the instruction manual supplied with the external media device.

💡 Tips

- You can import images saved on the external media device to your computer by using the supplied software “PMB.”

Functions available after saving images on an external media device

- playback of images through the camcorder (p. 56)
- importing images to “PMB”

Devices that cannot be used as an external media device

- You cannot use the following devices as an external media device.
 - media devices with a capacity exceeding 2 TB
 - ordinary disc drive such as CD or DVD drive
 - media devices connected via a USB hub
 - media devices with built-in USB hub
 - card reader

⚡ Notes

- You may not be able to use external media devices with a code function.
- The FAT file system is available for your camcorder. If the storage medium of the external device was formatted for the NTFS file system, etc., format the external media device using the camcorder before use. The format screen appears when an external media device is connected to your camcorder. Make sure that

important data has not previously been saved on the external media device before you format it using the camcorder.

- Operation is not assured with every device satisfying requirements for operating.
- For details on available external media devices, go to the Sony support website in your country/region.

1 Connect the AC Adaptor and the power cord (mains lead) to the DC IN jack of your camcorder and the wall outlet (wall socket).

2 If the external medium device has the AC power cable, connect it to the wall outlet (wall socket).

3 Connect the USB Adaptor Cable to the external media device.

4 Connect the USB Adaptor Cable to the Ψ (USB) jack of your camcorder.

Make sure not to disconnect the USB cable while [Preparing image database file. Please wait.] is displayed on the LCD screen. If [Repair Img. DB F.] is displayed on the camcorder screen, touch **OK**.

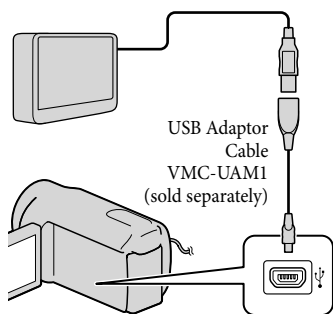

- You cannot use the Built-in USB Cable for this type of connection.

5 Connect the external media device and touch [Copy.] on the camcorder screen.

HDR-CX130E:

Movies and photos that are stored in the memory card (inserted in the camcorder), and that have not yet been saved on to external media device can be saved on the connected media device at this time.

HDR-CX160E/CX180E:

Movies and photos that are stored on one of the camcorder's recording media selected in [Media Select], and that have not yet been saved on external media device can be saved on the connected media device at this time.

- This operation is available only when there are newly recorded images.

6 After operation is completed, touch [OK] on the camcorder screen.

When connecting an external media device

The images saved in the external media device are displayed on the LCD screen. Images saved on the connected external media device appear on the LCD screen. When an external media device is connected, the USB icon will appear on the Event View screen, etc.

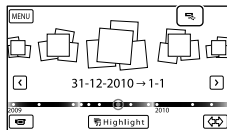

You can make menu settings of the external media device such as deleting images. Touch **MENU** (MENU) → [Edit/Copy] on Event View.

To disconnect the external media device

- 1 Touch  while the camcorder is in the playback standby mode ([Event View] or Event Index is displayed) of the external media device.
- 2 Disconnect the USB Adaptor Cable.

⚙ Notes

- The number of scenes you can save on the external media device are as follows. However, even if the external media device has free space, you cannot save scenes exceeding the following number.
 - High definition image quality (HD) movies: Max. 3,999
 - Standard definition image quality (STD) movies: Max. 9,999
 - Photos: Max. 40,000
- The number of scenes may be smaller depending on the type of images recorded.

Saving desired movies and photos

You can save desired images in the camcorder to the external media device.

- 1 Connect the camcorder to the external media device and touch [Play without copying].

Event View of the external medium is displayed.

- 2 Touch **MENU** (MENU) → [Edit/Copy] → [Copy].

- 3 Follow the instructions that appear on the screen to select the recording media (HDR-CX160E/CX180E), image selection methods and type of the image.

You cannot copy images from an external media device to the internal recording medium on the camcorder.

- 4 When you selected [Multiple Images], touch the image to be saved.

✓ appears.

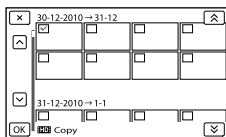

- Press and hold the image down on the LCD screen to confirm the image. Touch **X** to return to the previous screen.

- If you select [All In Event], select the event to copy with **▲** / **▼**. You cannot select multiple events.

- 5 Touch **OK** → **OK** → **OK** on the camcorder screen.

Playing back images in the external media device on the camcorder

- 1 Connect the camcorder to the external media device and touch [Play without copying].

Event View of the external media device is displayed.

- 2 Select the image you want to view and play back the image (p. 27).

- You can also view images on a TV connected to your camcorder (p. 31).
- You can play back the high definition image quality (HD) movies on your computer using [Player for AVCHD]. Start [Player for AVCHD], and select the drive where the external media device is connected with [Settings].

To perform [Direct Copy] manually

You can perform [Direct Copy] manually while the camcorder is connected to an external media device.

- ① Touch **MENU** (MENU) → [Edit/Copy] → [Direct Copy] on the [Event View] screen of the external media device.

Creating a disc with the DVD writer, DVDirect Express

You can create a disc or play back the images on a created disc by using the DVD writer, DVDirect Express (sold separately). Refer also to the instruction manual supplied with the DVD writer.

⚡ Notes

- Connect your camcorder to the wall outlet (wall socket) using the supplied AC Adaptor for this operation (p. 15).
- DVDirect Express is referred to as “DVD writer” in this section.

Discs that can be used

- 12 cm DVD-R
- 12 cm DVD+R

The device does not support two-layered discs.

1 Connect the AC Adaptor and the power cord (mains lead) to the DC IN jack of your camcorder and the wall outlet (wall socket) (p. 15).

2 Turn on your camcorder, and connect the DVD writer to the Ψ (USB) jack of your camcorder with the USB cable of the DVD writer.

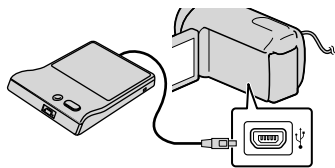

- You cannot use the Built-in USB Cable for this type of connection.

② Touch [Copy images that have not been copied.].

③ Touch **OK** → **OK**.

⚡ Notes

- If your camcorder does not recognize the external media device, try the following operations.
 - Reconnect the USB Adaptor Cable to your camcorder.
 - If the external media device has the AC power cord (mains lead), connect it to the wall outlet (wall socket).

3 Insert an unused disc into the DVD writer, and close the disc tray.

4 Press  (DISC BURN) on the DVD writer.



• **HDR-CX130E**

Movies that are stored in the memory card (inserted in the camcorder), and that have not yet been saved on any disc can be saved on the disc at this time.

• **HDR-CX160E/CX180E**

Movies that are stored on one of the camcorder's recording media selected in [Media Select], and that have not yet been saved on any discs can be saved on the disc at this time.

- When there are unsaved high definition (HD) and standard definition (STD) image quality movies, they will be saved on individual discs according to the image quality.
- If the files you want to copy do not fit onto one disc, replace the disc in the DVD writer with an unused one and repeat the operation.

5 After the operation is completed, touch  →  → (the tray opens) → remove the disc → touch  on the camcorder screen.

6 Touch , then disconnect the USB cable.

 **Tips**

- If the total memory size of movies to be burnt by the DISC BURN operation exceeds that of the disc, disc creation stops when the limit is reached. The last movie on the disc may be cut off.

Performing [DISC BURN OPTION]

Perform this operation in the following cases:

- When copying a desired image
- When creating multiple copies of the same disc

1 Connect the camcorder to the DVD writer and touch [DISC BURN OPTION].

2 Select the recording media containing the movie(s) you want to save (HDR-CX160E/CX180E) and touch [Next].

3 Touch the movie you want to burn on the disc.

✓ appears.

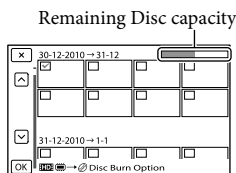

- Touch and hold the desired thumbnail that you can confirm the image. Touch **✕** to return to the previous screen.

4 Touch **OK** → **OK** on the camcorder screen.

To create another disc of the same contents, insert a new disc and touch [CREATE SAME DISC].

5 After the operation is completed, touch [Exit.] → **✕** on the camcorder screen.

6 Disconnect the USB cable from your camcorder.

- Play the created disc to make sure copying was performed correctly before deleting the movies on your camcorder.
- If [Failed.] or [DISC BURN failed.] appears on the screen, insert another disc into the DVD writer and perform the DISC BURN operation again.

Tips

- Disc creation time to copy movies to the limit of the disc is about 20 to 60 minutes. It may take more time depending on the recording mode or the number of scenes.

Playing back a disc on the DVD writer

1 Connect the AC Adaptor and the power cord (mains lead) to the DC IN jack of your camcorder and the wall outlet (wall socket) (p. 15).

2 Turn on your camcorder, and connect the DVD writer to the Ψ (USB) jack of your camcorder with the USB cable of the DVD writer.

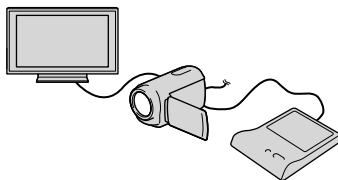

- You can play back movies on the TV screen by connecting the camcorder to a TV (p. 31).

Notes

- Do not do any of the following when creating a disc.
 - Turn off the camcorder
 - Disconnect the USB cable or the AC Adaptor
 - Subject the camcorder to mechanical shock or vibration
 - Eject the memory card from the camcorder

Creating a high definition image quality (HD) disc with a DVD writer, etc., other than DVDirect Express

Use the USB cable to connect your camcorder to a disc creation device, which is compatible with high definition image quality (HD) movies, such as a Sony DVD writer. Refer also to the instruction manuals supplied with the device to be connected.

⚡ Notes

- Connect your camcorder to the wall outlet (wall socket) using the supplied AC Adaptor for this operation (p. 15).
- Sony DVD writer may not be available in some countries/regions.

1 Connect the AC Adaptor and the power cord (mains lead) to the DC IN jack of your camcorder and the wall outlet (wall socket) (p. 15).

2 Turn on your camcorder, and connect a DVD writer, etc. to your camcorder with the Built-in USB Cable.

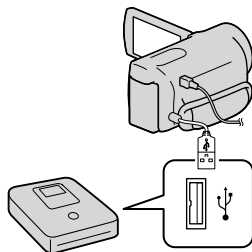

The [USB Select] screen appears on the camcorder screen.

3 Insert a created disc into the DVD writer.

The movies on the disc appear on the index screen on the camcorder.

4 Press the play button on the DVD writer.

- You can also operate by the camcorder screen.

5 After the operation is completed, touch **X** on the camcorder screen and remove the disc when the tray is open.

6 Touch **OK** and disconnect the USB cable.

- If the [USB Select] screen does not appear, touch **MENU** (MENU) → [Setup] → [↔ (Connection)] → [USB Connect].

3 Touch [USB Connect] on the camcorder screen.

- The displayed recording media differ depending on the model.

4 Record movies on the connected device.

- For details, refer to the instruction manuals supplied with the device to be connected.

5 After the operation is completed, touch **X** → **OK** on the camcorder screen.

6 Disconnect the USB cable.

Creating a standard definition image quality (STD) disc with a recorder, etc.

You can copy images played back on your camcorder on a disc or video cassette, by connecting your camcorder to a disc recorder, a Sony DVD writer, etc., other than DVDirect Express, with the A/V connecting cable. Connect the device in either way of **1** or **2**. Refer also to the instruction manuals supplied with the devices to be connected.

⚡ Notes

- Connect your camcorder to the wall outlet (wall socket) using the supplied AC Adaptor for this operation (p. 15).
- Sony DVD writer may not be available in some countries/regions.
- High definition image quality (HD) movies will be copied with standard definition image quality (STD).

A/V Remote Connector

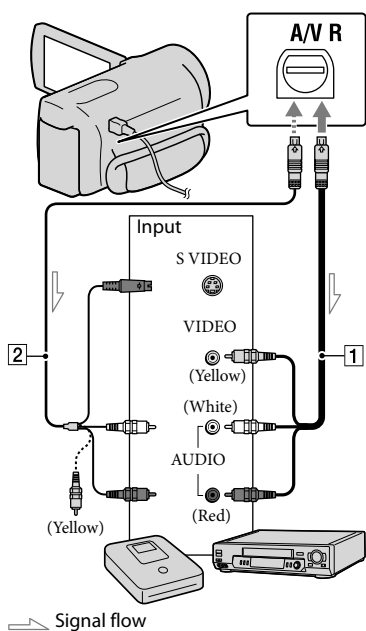

1 A/V connecting cable (supplied)

2 A/V connecting cable with S VIDEO (sold separately)

By using this cable, higher quality images can be produced than with an A/V connecting cable. Connect the white and red plug (left/right audio) and the S VIDEO plug (S VIDEO channel) of the A/V connecting cable with an S VIDEO cable. If you connect the S VIDEO plug only, you will hear no sound. The yellow plug (video) connection is not necessary.

1 Insert the recording media in the recording device.

- If your recording device has an input selector, set it to the input mode.

2 Connect your camcorder to the recording device (a disc recorder, etc.) with the A/V connecting cable **1** (supplied) or an A/V connecting cable with S VIDEO **2** (sold separately).

- Connect your camcorder to the input jacks of the recording device.

3 Start playback on your camcorder, and record it on the recording device.

- Refer to the instruction manuals supplied with your recording device for details.







4 When dubbing is finished, stop the recording device, and then your camcorder.

⚡ Notes

- Since copying is performed via analog data transfer, the image quality may deteriorate.
- You cannot copy images to recorders connected with an HDMI cable.
- To copy date/time information and camera data, touch **MENU** (MENU) → [Setup] → [Playback Settings] → [Data Code] → a desired setting → **OK**.
- When the screen size of display devices (TV, etc.) is 4:3, touch **MENU** (MENU) → [Setup] → [Connection] → [TV Type] → [4:3] → **OK**.
- When you connect a monaural device, connect the yellow plug of the A/V connecting cable to the video input jack, and the white (left channel) or the red (right channel) plug to the audio input jack on the device.

Using menus

You can enjoy using your camcorder more by making good use of menu operations. The camcorder has various menu items under each of 6 menu categories.

-  **Shooting Mode (Items for selecting a shooting mode)** → p. 65
-  **Camera/Mic (Items for customized shooting)** → p. 67
-  **Image Quality/Size (Items for setting up image quality or size)** → p. 74
-  **Playback Function (Items for playback)** → p. 76
-  **Edit/Copy (Items for editing)** → p. 76
-  **Setup (Other setup items)** → p. 77

Operating menus

Follow the procedures explained below to set the menu items.

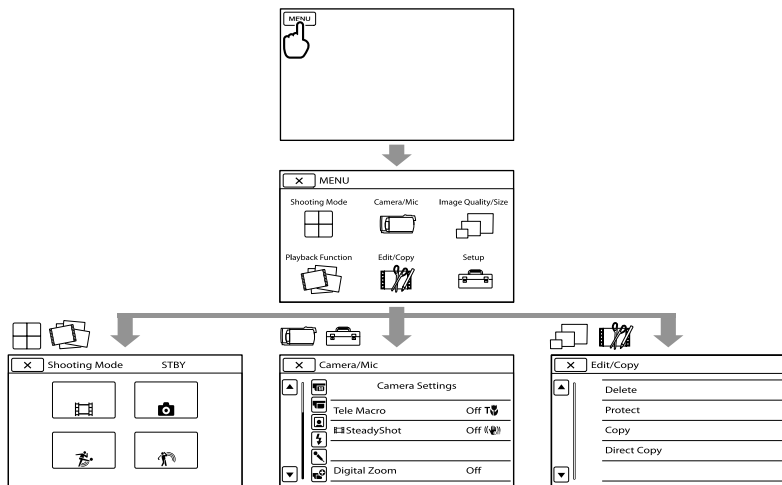

The [Camera/Mic] and [Setup] menus have sub-categories. Touch the sub-category icon, and the screen changes to other sub-category menus.

Grayed out menu items or settings are not available.

Notes

- You may not be able to set some menu items, depending on the recording or playback conditions.
- Touch  to finish setting the menu or to return to the previous menu screen.

Menu lists

Shooting Mode

Movie	65
Photo	65
Smth Slw REC	65
Golf Shot	66

Camera/Mic

















 (Manual Settings)	
White Balance	67
Spot Meter/Fcs	67
Spot Meter	68
Spot Focus	68
Exposure	68
Focus	68
Low Lux	69
 (Camera Settings)	
Scene Selection	69
 Fader	70
 Self-Timer	70
Tele Macro	70
 SteadyShot	71
 SteadyShot	71
Digital Zoom	71
Conversion Lens	71
Auto Back Light	72
 (Face)	
Face Detection	72
Smile Shutter	72
Smile Sensitivity	73
 (Microphone)	
Blt-in Zoom Mic	73
Wind Noise Reduct.	73
Micref Level	73
 (Shooting Assist)	
Guide Frame	73
Display Setting	74

Image Quality/Size

 REC Mode	35
 Frame Rate	74
 HDMI/STBD Setting	35
 Wide Mode	75
 x.v.Color	75
 Image Size	75



Playback Function

Event View	27
Highlight Movie	38
 Scenario	40

Edit/Copy

Delete	41
Protect	42
Copy*	43
Direct Copy	56

Setup

 (Media Settings)	
Media Select*	20
Media Info	77
Format	77
Repair Img. DB F.	88
File Number	78
 (Playback Settings)	
Data Code	78
Volume	79
 (Connection)	
TV Type	79
Component	79
HDMI Resolution	79
CTRL FOR HDMI	80
USB Connect	80
USB Connect Setting	80
USB LUN Setting	81
Disc Burn	48

Shooting Mode (Items for selecting a shooting mode)

See “Using menus” (p. 63) on the operation. The default settings are marked with ►.

Movie

You can record movies.

Photo

You can shoot photos.

Smth Slw REC (Smooth slow rec)

Fast moving subjects and actions, which cannot be captured under the ordinary shooting conditions, can be shot in smooth moving slow-motion for about 3 seconds. Press START/STOP on the [Smth Slw REC] screen.

An about-3-second movie is recorded as a 12-second-slow-motion movie. [Recording...] disappears, when recording is finished.

To change the timing at which the camcorder starts recording

Touch [Timing] to make the setting.

[Timing] (Timing)

Select the recording start point after START/STOP is pressed. The default setting is [3sec After].

The point when START/STOP is pressed.

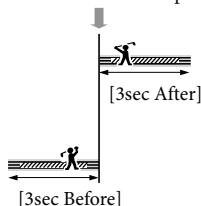

(General Settings)

Beep	81
LCD Brightness	81
A. Shut Off	81
Power On By LCD	81
Language Setting	81
Calibration	100
Battery Info	82
Demo Mode	82

(Clock Settings)

Date & Time Setting	82
Date & Time	82
Summer Time	82
Date & Time Format	82
Area Setting	82

* HDR-CX160E/CX180E

⚡ Notes

- You cannot record sound.
- Image quality is not as good as that of normal recording.
- The [ REC Mode] will be set to [Standard HQ] automatically
- When the standard definition image quality (STD) mode is selected, you cannot record movies using [Smth Slw REC].

Golf Shot

Divides 2 seconds of fast movement into frames which are then recorded as a movie and photos. You can view a series of movement when playing back, which is convenient in cases such as checking golf swing or tennis form.

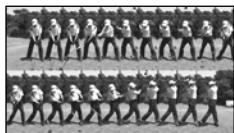

On the [Golf Shot] screen, frame the subject in the white frame in the center of the screen, then press START/STOP right after the subject has taken a swing. When the sound of a club hitting the ball is detected, the recording time period is automatically adjusted according to that moment.

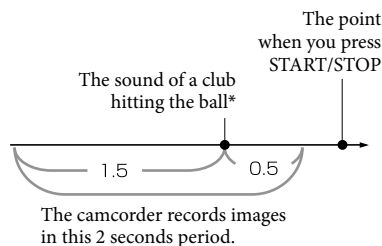



- * The camcorder sets the point when the loudest sound in the past 1 second is detected, as the sound of a club hitting the ball.

⚡ Notes

- If the camcorder cannot detect the sound of a club hitting the ball, the camcorder automatically sets the impact point at 0.5 second before the START/STOP button has been pressed, and records a movie in the time period between 1.5 seconds before the impact point to 0.5 second after the impact point.
- The size of photos becomes $1,920 \times 1,080$.
- You cannot record sound.
- Image quality is not as good as that of normal recording.
- The [ REC Mode] will be set to [Standard HQ] automatically.
- You cannot record movies with [Golf Shot] when you set the image quality to standard definition image quality (STD).

💡 Tips

- To use the self-timer, touch []. With [] set to [On], press START/STOP to start countdown of the timer. The point when countdown reaches 0 is assumed as the moment of impact and motion before and after 0 is recorded.
- If camera shake is excessive, or there are moving objects in the background during recording, image analysis will not be performed effectively, and images may contain noise as a result. It is recommended that you record images under stable conditions (for example, using a tripod).
- Impact sound may be detected by the internal microphone even when an external microphone is attached.

Camera/Mic

(Items for customized shooting)

See “Using menus” (p. 63) on the operation. The default settings are marked with ▶.

White Balance



You can adjust the color balance to the recording environment.



▶ Auto

The white balance is adjusted automatically.

Outdoor (☀)

The white balance is appropriately adjusted for the following recording conditions:

- Outdoors
- Night views, neon signs and fireworks
- Sunrise or sunset
- Under daylight fluorescent lamps

Indoor (☞)

The white balance is appropriately adjusted for the following recording conditions:

- Indoors
- At party scenes or studios where the lighting conditions change quickly
- Under video lamps in a studio, or under sodium lamps or incandescent-like color lamps

One Push (☑)

The white balance will be adjusted according to the ambient light.

- ① Touch [☑].
- ② Frame a white object such as a piece of paper, to fill the screen under the same lighting conditions as you will shoot the subject.
- ③ Touch [SET].

⚡ Notes

- Set [White Balance] to [Auto] or adjust the color in [One Push] under white or cool white fluorescent lamps.
- When you select [One Push], keep framing white objects.
- While the camcorder is recording a movie, [SET] is grayed out and [One Push] cannot be set.
- If you set [White Balance], [Scene Selection] is set to [Auto].

💡 Tips

- If you have changed the battery pack while [Auto] was selected, or taken your camcorder outdoors after inside use (or vice versa), aim your camcorder at a nearby white object for about 10 seconds for better color balance adjustment.
- When the white balance has been set with [One Push], if the lighting conditions changed by bringing your camcorder outdoors from inside the house, or vice versa, you need to redo the [One Push] procedure to readjust the white balance.

Spot Meter/Fcs (Spot meter/focus)



You can adjust the brightness and focus for the selected subject simultaneously. This function enables you to use [Spot Meter] (p. 68) and [Spot Focus] (p. 68) at the same time.



Touch the subject of which you want to adjust the brightness and focus. To adjust the brightness and focus automatically, touch [Auto].

⚡ Notes

- [Exposure] and [Focus] are automatically set to [Manual].

Spot Meter (Flexible spot meter)

You can adjust and fix the exposure to the subject, so that it is recorded in suitable brightness even when there is strong contrast between the subject and the background, such as subjects in the spotlight on stage.



Touch the subject of which you want to adjust the exposure.

To return the setting to automatic exposure, touch [Auto].

⚡ Notes

- [Exposure] is automatically set to [Manual].

Spot Focus

You can select and adjust the focal point to aim it at a subject not located at the center of the screen.



Touch the subject of which you want to adjust the focus.

To adjust the focus automatically, touch [Auto].

⚡ Notes

- [Focus] is automatically set to [Manual].

Exposure

You can fix the brightness of a picture manually. Adjust the brightness when the subject is too bright or too dark.



Touch **-** / **+** to adjust the brightness. To adjust the exposure automatically, touch [Auto].

Focus

You can adjust the focus manually. You can select this function also when you want to focus on a certain subject intentionally.



Touch **👤** (nearby subject) / **🏠** (distant subject) to adjust the focus.

To adjust the focus automatically, touch [Auto].

⚡ Notes

- When you set [Focus] to [Manual], **🔒** appears.
- The minimum possible distance between camcorder and subject while maintaining sharp focus is about 1 cm (about 13/32 in.) for wide angle and about 80 cm (about 31 1/2 in.) for telephoto.

💡 Tips

- **👤** appears when the focus cannot be adjusted any closer, and **🏠** appears when the focus cannot be adjusted farther away.

- It is easier to focus on the subject by moving the power zoom lever towards T (telephoto) to adjust the focus, then towards W (wide angle) to adjust the zoom for recording. When you want to record a subject at close range, move the power zoom lever to W (wide angle), then adjust the focus.
- The focal distance information (distance at which the subject is focused on; used as a guide if it is dark and focus adjustment is difficult) appears for a few seconds in the following cases. (This information will not display correctly if a conversion lens (sold separately) is being used.)
 - When the focus mode is switched from automatic to manual
 - When you set focus manually

Low Lux



You can record bright color images, even in dim light.

▶ Off

The Low Lux function is not used.

On (📷)

The Low Lux function is used.

Scene Selection



You can record images effectively in various situations.

▶ Auto

Records images in average image quality without the [Scene Selection] function.

Twilight * (🌙)

Maintains the darkening atmosphere of the distant surroundings in twilight scenes.



Sunrise&Sunset* (🌅)

Reproduces the atmosphere of scenes such as sunsets or sunrises.



Fireworks* (💣)

Takes spectacular shots of fireworks.



Landscape* (🏞️)

Shoots distant subjects clearly. This setting also prevents your camcorder from focusing on glass or metal mesh in windows between the camcorder and the subject.



Portrait (👤)

Brings out the subject such as people or flowers while creating a soft background.



Spotlight** (🎤)

Prevents people's faces from appearing excessively white when subjects are lit by strong light.



Beach** (🏖️)

Takes the vivid blue of the ocean or a lake.



Snow** (❄️)

Takes bright pictures of a white landscape.



* Adjusted to focus on subjects farther away only.

** Adjusted not to focus on subjects a short distance away.

🔌 Notes

- If you set [Scene Selection], [White Balance] setting is canceled.

Fader

You can record a transition with the following effects adding to the interval between scenes.

Select the desired effect in [STBY] (to fading in) or [REC] (to fading out) mode.

▶ Off

Does not use an effect.

White Fader

Fades in/out with the white effect.

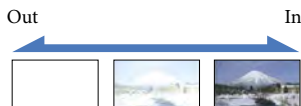

Black Fader

Fades in/out with the black effect.



To cancel the fader before starting the operation, touch [Off].

💡 Tips

- When you press START/STOP the setting is cleared.
- The thumbnails of movie recorded using [Black Fader] may be difficult to see on Event View or other screens.

Self-Timer

Press PHOTO to start the count down. A photo is recorded after about 10 seconds.

▶ Off

Cancels the self-timer.

On (☺)

Starts the self-timer recording. To cancel the recording, touch [Reset].

Tele Macro

This is useful to shoot small subjects, such as flowers or insects. You can blur out backgrounds and the subject stands out clearer.

▶ Off

Cancels Tele Macro. (Tele Macro is also canceled when you move the zoom lever to the W side.)

On (T)

The zoom (p. 34) moves to the top of the T (telephoto) side automatically and allows recording subjects at close range down to about 44 cm (17 3/8 in.).



⚡ Notes

- When recording a distant subject, focusing may be difficult and can take some time.
- Adjust the focus manually ([Focus], p. 68) when it is hard to focus automatically.

SteadyShot



You can compensate for camera shake. Set [SteadyShot] to [Off] () when using a tripod (sold separately), then the image becomes natural.

▶ Active

Provides a more powerful SteadyShot effect.

Standard

Provides a SteadyShot effect, performing wide-angle recording under relatively stable recording conditions.

Off ()

The SteadyShot function is not used.

⚡ Notes

- If you change the setting of [SteadyShot], the imaging field will also change accordingly.
- You can magnify images up to 30 times using optical zooming, unless [SteadyShot] is set to [Active].

SteadyShot



You can compensate for camera shake. Set [SteadyShot] to [Off] () when using a tripod (sold separately), then the image becomes natural.

▶ On

The SteadyShot function is used.

Off ()

The SteadyShot function is not used.

Digital Zoom



You can select the maximum zoom level. Note that the image quality decreases when you use the digital zoom.

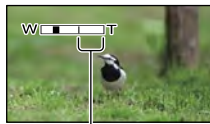

The zooming zone appears when you set the maximum zoom level.

▶ Off

Up to 42× zoom is performed.

350×

Up to 350× zoom is performed digitally.

⚡ Note

- You can magnify images up to 30 times using optical zooming, unless [SteadyShot] is set to [Active].

Conversion Lens



When using a conversion lens (sold separately), use this function to record using the optimum compensation for camera shake and focus for the lens.

▶ Off

Select this when you do not use a conversion lens.

Wide Conversion ()

Select this when you use a wide-conversion lens.

Tele Conversion ()

Select this when you use a tele-conversion lens.

Auto Back Light

Your camcorder adjusts the exposure for backlit subjects automatically.

► On

Adjusts the exposure for backlit subjects automatically.

Off

Does not adjust the exposure for backlit subjects.

Face Detection

You can set the camcorder to detect a face automatically. Furthermore, you can select which faces (children or adults) the camcorder detects with priority.

It adjusts the focus/color/exposure automatically for the face of the selected subject. Also, it adjusts the image quality of face parts more finely, in the case of the high definition image quality (HD) movies.

► Auto

Detects faces without distinction between adults and children.

Child Priority

Gives faces of children priority.

Adult Priority

Gives faces of adults priority.

Off

Does not detect faces.

Notes

- Faces may not be detected depending on recording conditions, subject conditions, and the setting of your camcorder.
- [Face Detection] may not function properly depending on recording conditions. Set [Face Detection] to [Off] in this case.

Tips

- For better face detection performance, shoot the subject(s) under the following conditions:
 - Shoot in a sufficiently bright place
 - The subject(s) does not wear glasses, a hat or mask
 - The subject(s) faces directly towards the camera
- If you select a subject which has priority by touching the frame that has appeared around the subject's face, a double-lined frame will appear and that face has priority.

Smile Shutter

The shutter is released when the camcorder detects a smile.

► Dual Capture

Only during movie recording, the shutter is released automatically, when the camcorder detects a smile.

Always On

The shutter is released when the camcorder detects a smile whenever the camcorder is in recording mode.

Off

Smiles are not detected, so photos are not recorded automatically.

Notes

- Smiles may not be detected depending on recording conditions, subject conditions, and the setting of your camcorder.

Smile Sensitivity



Sets the smile detection sensitivity for using the Smile Shutter function.

Slight Smile

Detects even a slight smile.

▶ Normal Smile

Detects a normal smile.

Big Smile

Detects a big smile.

Blt-in Zoom Mic



You can record a movie with vivid sound appropriate to the zoom position.

▶ Off

The microphone does not record sound following zooming in or out.

On (📶)

The microphone records sound following zooming in or out.

Wind Noise Reduct.



You can record a movie with less wind noise by cutting the low-frequency sound input from the built-in microphone.

▶ Off

Disables wind noise reduction.

On (🔊)

Enables wind noise reduction.

🔊 Notes

- If you turn the [Wind Noise Reduct.] function to [On], the [Blt-in Zoom Mic] function turns off automatically.

Micref Level (Microphone reference level)



You can select the microphone level for recording sound.

▶ Normal

Records various ambient sounds, converting them into the appropriate level.

Low (⬇️)

Records ambient sound faithfully. Select [Low] when you want to record an exciting and powerful sound in a concert hall, etc. (This setting is not suitable for recording conversations.)

Guide Frame



You can display the frame and check that the subject is horizontal or vertical. The frame is not recorded.

▶ Off

Does not display the guide frame.

On

Displays the guide frame.

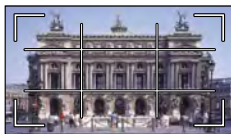

💡 Tips

- Positioning the subject at the cross point of the guide frame makes a balanced composition.
- The outer frame of [Guide Frame] shows the display area of a TV which is not compatible with full pixel display.

Display Setting

You can set the duration of displaying the icons or indicators on the LCD screen.

▶ Auto

Displays for about 3 seconds. The rec & zoom buttons on the LCD screen is displayed.

On

Always displays. The rec & zoom buttons on the LCD screen is not displayed.

Tips

- The icons or indicators are displayed in the following cases.
 - When you turn on your camcorder.
 - The LCD screen is touched (Except rec & zoom buttons on LCD screen).
 - When you switch your camcorder to the movie recording, photo recording, or playback mode.



Image Quality/Size (Items for setting up image quality or size)

See “Using menus” (p. 63) on the operation. The default settings are marked with ▶.

REC Mode

See page 35.

Frame Rate

You can select the frame rate to be used to record high definition image quality (HD) movies. Using [50i] is recommended for standard recording. Set [ Frame Rate] first, before setting [ REC Mode] (p. 35).

▶ 50i

For ordinary recording, this frame rate is recommended.

50p

You can record movies with a volume of data twice that of 50i with this setting, and this will allow you to enjoy clear images. When you play a movie recorded with this setting on a TV, the TV has to be compatible with 50p movie playback. If the TV is not compatible with 50p movie playback, the movie will be output as a 50i movie.

Notes

- The media that the recorded images can be saved on will depend on the recording mode that has been set during recording. For details, see page 36.

Tips

- Frame rate means the number of images that are updated in a certain period of time.

Setting

See page 35.

Wide Mode

When recording standard definition image quality (STD) movies, you can select the horizontal to vertical ratio according to the TV connected. Refer also to the instruction manuals supplied with your TV.

▶ 16:9 WIDE

Records movies to the full screen on a 16:9 (wide) TV screen.

4:3 ()

Records movies to the full screen on a 4:3 TV screen.

Notes

- Set [TV Type] correctly according to the TV connected for playback (p. 79).

x.v.Color

You can capture wider range of colors. Various colors such as the brilliant color of flowers and turquoise blue of the sea can be more faithfully reproduced. Refer to the instruction manuals of the TV.

▶ Off

Records in ordinary color range.

On ()

Records in x.v.Color.

Notes



- Set [ x.v.Color] to [On] when the recorded movie will be played back on an x.v.Color-compliant TV.
- If the movie recorded with this function [On] is played back on a non-x.v.Color-compliant TV, the color may not be reproduced correctly.
- [ x.v.Color] cannot be set to [On]:
 - When the image quality is set to the standard definition image quality (STD)
 - While recording a movie

Image Size

You can select a size for the photos you are going to shot.

▶ 3.3M ()

Records photos clearly (2,112 × 1,584).

2.5M ()

Records photos clearly in the 16:9 (wide) ratio (2,112 × 1,188).

1.9M ()

Allows you to record more photos in relatively clear quality (1,600 × 1,200).

VGA(0.3M) ()

Allows the maximum number of photos to be recorded (640 × 480).

Notes

- The selected image size is effective when the  (Photo) lamp is lit.



Playback Function (Items for playback)

See “Using menus” (p. 63) on the operation.

Event View

See page 27.

Highlight Movie

See page 38.



Scenario

See page 40.



Edit/Copy (Items for editing)

See “Using menus” (p. 63) on the operation.

Delete

See page 41.

Protect

See page 42.

Copy (HDR-CX160E/CX180E)

See page 43.

Direct Copy

See page 56.



Setup

(Other setup items)

See “Using menus” (p. 63) on the operation. The default settings are marked with ▶.

Media Select (HDR-CX160E/ CX180E)



See page 20.

Media Info



You can check the remaining recordable time for each recording mode of the recording media for movies and the approximate free and used media space of the recording media.

To turn off the display

Touch **✕**.

⚡ Notes

- Since there is a management file area, the used space is not displayed as 0 % even if you perform [Format] (p. 77).

💡 Tips

- The camcorder can display the information of the medium selected on [Media Select] (p. 20). Change the medium setting if necessary (HDR-CX160E/CX180E).

Format



Formatting deletes all the movies and photos to recover recordable free space.

HDR-CX130E:

Touch **OK** → **OK**.

HDR-CX160E/CX180E:

Select the recording media to be formatted, touch **OK** → **OK**.

⚡ Notes

- Connect your camcorder to the wall outlet (wall socket) using the supplied AC Adaptor for this operation (p. 15).

- To avoid the loss of important images, you should save them before formatting the recording media.
- Protected movies and photos will also be deleted.
- While [Executing...] is displayed, do not close the LCD screen, operate the buttons on the camcorder, disconnect the AC Adaptor, or eject the memory card from your camcorder. (The access lamp is lit or flashing while formatting memory card.)

To prevent data on the internal recording media from being recovered (HDR-CX160E/CX180E)

[Empty] allows you to write unintelligible data onto the internal recording media of the camcorder. In this way it may become more difficult to recover any original data. When you dispose of or transfer the camcorder, it is recommended that you perform [Empty].

When the internal recording media is selected on the [Format] screen, touch [Empty].

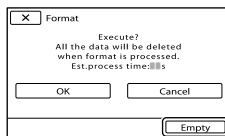

⚡ Notes

- Connect the AC Adaptor to the wall outlet (wall socket). You cannot perform [Empty] unless you connect the AC Adaptor to the wall outlet (wall socket).
- To avoid the loss of important images, they should be saved on a computer or other devices before performing [Empty].
- Disconnect all cables except the AC Adaptor. Do not disconnect the AC Adaptor during the operation.

- While deleting data, do not apply any vibrations or shocks to your camcorder.
- You can check the time that the camcorder will take to delete data on the LCD screen.
- If you stop performing [Empty] while [Executing...] appears, be sure to complete the operation by performing [Format] or [Empty] when you use the camcorder next time.

Repair Img. DB F.



See page 88, 92.

File Number



You can select the way to assign file number of photos.

► Series

Assigns file numbers of photos in sequence. The file number becomes larger each time you record a photo.

Even if the memory card is replaced with another one, the file number is assigned in sequence.

Reset

Assigns file numbers in sequence, following the largest file number existing on the recording medium.

When the memory card is replaced with another one, the file number is assigned for each memory card.

Data Code



During playback, your camcorder displays the information (Date/Time, Camera Data) recorded automatically at the time of recording.

► Off

Data code is not displayed.

Date/Time

Displays the date and time.

Camera Data

Displays camera setting data.

Date/Time

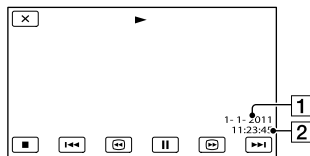

- 1 Date
- 2 Time

Camera Data

Movie

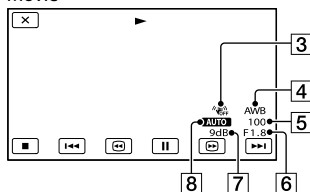

Photo

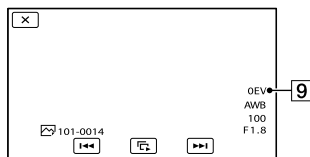

- 3 SteadyShot off
- 4 White Balance
- 5 Shutter Speed
- 6 IRIS (Aperture value)
- 7 Gain
- 8 Brightness
- 9 Exposure

💡 Tips

- The data code is displayed on the TV screen if you connect your camcorder to a TV.
- Depending on the recording media condition, bars [---:---] appear.

Volume



You can adjust the volume of playback sound by touching / .

TV Type



You need to convert the signal depending on the TV connected when playing back movies and photos. The recorded movies and photos are played back as following illustrations.

▶ 16:9

Select this to view your movies on a 16:9 (wide) TV. The recorded movies and photos are played back as shown below.

Movies and photos recorded in 16:9 (wide) mode

Movies and photos recorded in 4:3 mode



4:3

Select this to view your movies and photos on a 4:3 standard TV. The recorded movies and photos are played back as shown below.

Movies and photos recorded in 16:9 (wide) mode

Movies and photos recorded in 4:3 mode



Notes

- Horizontal to vertical ratio of high definition image quality (HD) movies is 16:9.

Component



Select [Component] when connecting your camcorder to a TV with the component input jack.

576i

Select this when connecting your camcorder to a TV with the component input jack.

▶ 1080i/576i

Select this when connecting your camcorder to a TV that has the component input jack and is capable of displaying the 1080i signal.

1080p/576i

Select this when connecting your camcorder to a TV that has the component input jack and is capable of displaying the 1080p signal.

HDMI Resolution



Select the output image resolution when connecting your camcorder to a TV with an HDMI cable (sold separately).

▶ Auto

Normal setting (outputs the signal according to the TV automatically).

1080p/576p

Outputs high definition image quality (HD) movies with a 1080p signal and standard image quality (STD) movies with a 576p signal.

1080i/576i

Outputs high definition image quality (HD) movies with a 1080i signal and standard image quality (STD) movies with a 576i signal.

720p/576p

Outputs high definition image quality (HD) movies with a 720p signal and standard image quality (STD) movies with a 576p signal.

576p

Outputs the 576p signal.

576i

Outputs the 576i signal.

⚡ Notes

- When [Frame Rate] is set to [50p] and [HDMI Resolution] is set to [720p/576p] or [576p], HDMI signals cannot be output during recording.

CTRL FOR HDMI (Control for HDMI)

When connecting your camcorder to a "BRAVIA" Sync compatible TV with a HDMI cable (sold separately), you can play back movies on your camcorder by aiming the TV's Remote Commander at the TV (p. 33).

▶ On

Operates your camcorder using the TV's Remote Commander.

Off

Does not operate your camcorder using the TV's Remote Commander.

USB Connect

Select this item when [USB Select] does not appear on the LCD screen by connecting the camcorder to a computer with the Built-in USB Cable.
See page 61.

USB Connect Setting

You can set the USB transfer mode for connecting the camcorder to a computer or other USB device.

▶ Auto

The camcorder automatically selects the USB transfer mode depending on the connected device.

Mass Storage

This is a USB transfer mode compatible to many types of USB devices.

MTP

This is a USB transfer mode compatible with certain types of computers.

⚡ Notes

- When you connect the camcorder to other devices using the [MTP] mode, movies that have been recorded with the same image quality as the one currently selected (selected with the [HDMI/STD] Setting] menu) can only be displayed on the connected device.
 - When the camcorder is connected to an external device in the [MTP] mode, movie files will be displayed with the recorded date, however, some information, such as area information, included in the movie files cannot be displayed on the connected device. To import images from the camcorder to your computer, use the supplied "PMB" software.
 - If the "Device Stage*" window does not open when you connect the camcorder to a computer equipped with Windows 7, set [USB Connect Setting] to [Auto].
- * "Device Stage" is a menu of Windows 7, that is used to manage devices (camcorder, camera, etc.) that are connected to the computer.

USB LUN Setting

Improves compatibility with external devices by limiting the functions of the USB connection.

► Multi

Use this setting for ordinary operations.

Single

Try this setting only if you cannot connect to an external device.

Notes

- When you use “PMB Portable” to upload images to a service on the Internet, make sure to set [USB LUN Setting] to [Multi].

Disc Burn

See page 48.

Beep

► On

A melody sounds when you start/stop recording, or operate the touch panel.

Off

Cancels the melody.

LCD Brightness

You can adjust the brightness of the LCD screen.

► Normal

Normal setting (normal brightness).

Bright

Select this when the LCD screen is not bright enough.

Tips

- This adjustment does not affect the recorded images in any way.

A. Shut Off (Auto shut off)

You can set your camcorder to turn off automatically when you do not operate your camcorder for more than about 5 minutes.

► On

The camcorder turns off automatically.

Off

The camcorder does not turn off automatically.

Notes

- When you connect your camcorder to a wall outlet (wall socket), the camcorder does not turn off automatically.

Power On By LCD

You can set the power of the camcorder to turn on or off by opening or closing the LCD screen panel.

► On

Turns the power on or off by opening or closing the LCD screen panel.

Off

Does not turn the power on or off by opening or closing the LCD screen panel.

Language Setting

You can select the language to be used on the LCD screen.

Tips

- Your camcorder offers [ENG[SIMP]] (simplified English) for when you cannot find your native tongue among the options.

Calibration

See page 100.

Battery Info



You can check the estimated remaining capacity of the battery.

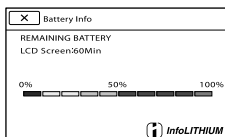

To close the battery information screen

Touch .

Demo Mode



When the camcorder is connected to a wall outlet (wall socket) and no operation is performed for about 10 minutes with the movie recording mode or the Event View mode set, a demonstration movie starts playing.

► On

The demonstration appears.

Off

The demonstration does not appear.

⚡ Notes

- In the default setting, the demonstration movie is in the Event Index. If you delete the demonstration movie, you cannot recover it (HDR-CX160E/CX180E).
- A movie you have recorded will be registered as the demonstration movie if it satisfies all of the following conditions (HDR-CX160E/CX180E).
 - The movie is protected
 - The movie is the first one displayed on the Event Index screen
 - The movie is saved on the internal recording media
 - The movie is recorded with high definition image quality (HD)

💡 Tips

- When you set this item to [On] and touch , the demonstration starts playing.
- If you make one of the following operations, the demonstration will be suspended. (It appears again if no operation is performed for about 10 minutes.)
 - Pressing START/STOP or PHOTO
 - Touching the screen during the demonstration
 - Turning on the (Photo) lamp
 - Pressing (View Images)
 - Pressing MODE

Date & Time Setting



■ Date & Time

See page 17.

■ Summer Time

You can change this setting without stopping the clock. Set to [On] to move the time forward 1 hour.

► Off

Does not set the summertime.

On

Sets the summertime.

■ Date & Time Format

You can select one from 4 types of date and time format.

Area Setting



You can adjust a time difference without stopping the clock. Select your local area when using the camcorder in other time zones. Refer to the world time difference information on page 95.

► Home

Select this item when you are going to use the camcorder in the area where you are living.

Destination (📍)

Select this item when you want to use the camcorder with the area setting set to another place.

Tips

- If you visit a certain place often and want to use the camcorder with the area setting set to that place, it is useful if you set the place to [Destination].

? Troubleshooting

If you run into any problems using your camcorder, follow the steps below.

① Check the list (p. 84 to 93), and inspect your camcorder.

② Disconnect the power source, attach the power source again after about 1 minute, and turn the camcorder on.

③ Press RESET (p. 105) using a pointed object, and turn the camcorder on. If you press RESET, all settings, including the clock setting, are reset.

④ Contact your Sony dealer or local authorized Sony service facility.

- Your camcorder may be required to initialize or change the current internal memory (HDR-CX160E/CX180E) of your camcorder, depending on the problem. In the event of this, the data stored on the internal memory will be deleted. Be sure to save the data on the internal memory on other media (backup) before sending your camcorder for repair. We will not compensate you for any loss of internal memory data.
- During repair, we may check a minimum amount of data stored on the internal memory in order to investigate the problem. However, your Sony dealer will neither copy nor retain your data.

- Overall operations p. 84
- Batteries/power sources p. 85
- LCD screen p. 86
- Memory card p. 86
- Recording..... p. 86
- Playback p. 88

- Playing back images stored on memory card on other devices..... p. 88
- Editing movies/photos on your camcorder. p. 89
- Playback on the TV p. 89
- Copying/Connecting to other devices p. 89
- Connecting to a computer p. 90

Overall operations



The power does not turn on.

- Attach a charged battery pack to the camcorder (p. 13).
- The plug of the AC Adaptor has been disconnected from the wall outlet (wall socket). Connect it to the wall outlet (wall socket) (p. 13).

The camcorder does not operate even when the power is set to on.

- It takes a few seconds for your camcorder to be ready to shoot after the power is turned on. This is not a malfunction.
- Disconnect the AC Adaptor from the wall outlet (wall socket) or remove the battery pack, then reconnect it after about 1 minute. If the functions still do not work, press RESET (p. 105) using a pointed object. (If you press RESET, all settings, including the clock setting, are reset.)
- The temperature of your camcorder is extremely high. Turn off your camcorder and leave it for a while in a cool place.
- The temperature of your camcorder is extremely low. Leave your camcorder with the power of your camcorder on. Turn off your camcorder and take it to a warm place. Leave the camcorder there for a while, then turn on your camcorder.

The menu settings have been changed automatically.

- While Intelligent Auto is active, some menu settings related to image quality will be changed automatically.
- The following menu items return to the default settings when you switch between movie recording and photo recording and playback modes.
 - [ Fader]
 - [ Self-Timer]
 - [Tele Macro]



Your camcorder gets warm.

- Your camcorder may become warm during operation. This is not a malfunction.

A rattling noise can be heard when you shake the camcorder.

- If no noise is heard when the camcorder is turned on and is in the movie/photo recording mode, the noise is produced by the movement of the internal lens. This is not a malfunction.

Intelligent Auto is canceled.

- The Intelligent Auto setting is canceled if you change the following settings:
 - [Smth Slw REC]
 - [Golf Shot]
 - [White Balance]
 - [Spot Meter/Fcs]
 - [Spot Meter]
 - [Spot Focus]
 - [Exposure]
 - [Focus]
 - [Low Lux]
 - [Scene Selection]
 - [Tele Macro]
 - [ SteadyShot]
 - [ SteadyShot]
 - [Auto Back Light]
 - [Face Detection]

Batteries/power sources

The power abruptly turns off.

- Use the AC Adaptor.
- In the default setting, when about 5 minutes have elapsed while you do not operate your camcorder, the camcorder is automatically turned off (A. Shut Off). Change the setting of [A. Shut Off] (p. 81), or turn on the power again.
- Charge the battery pack (p. 13).

The CHG (charge) lamp does not light while the battery pack is being charged.

- Close the LCD screen (p. 13).
- Attach the battery pack to the camcorder correctly (p. 13).
- Connect the power cord (mains lead) to the wall outlet (wall socket) properly.
- The battery charge is completed (p. 13).

The CHG (charge) lamp flashes while the battery pack is being charged.

- If the temperature of the battery pack is too high or too low, you may not be able to charge it (p. 97).
- Attach the battery pack to the camcorder correctly (p. 13). If the problem persists, disconnect the AC Adaptor from the wall outlet (wall socket) and contact your Sony dealer. The battery pack may be damaged.

The remaining battery time indicator does not indicate the correct time.

- The ambient temperature is too high or too low. This is not a malfunction.
- The battery pack has not been charged enough. Fully charge the battery again. If the problem persists, replace the battery pack with a new one (p. 98).
- The indicated time may not be correct depending on the environment of use.

The battery pack is quickly discharged.

- The ambient temperature is too high or low. This is not a malfunction.
- The battery pack has not been charged enough. Fully charge the battery again. If the problem persists, replace the battery pack with a new one (p. 98).

LCD screen

Menu items are grayed out.

- You cannot select grayed items in the current recording/playback situation.
- There are some functions you cannot activate simultaneously.

The buttons do not appear on the touch panel.

- Touch the LCD screen lightly.

The buttons on the touch panel do not work correctly or do not work at all.

- Adjust the touch panel ([Calibration]) (p. 100).

The buttons on the touch panel quickly disappear.

- Set [Display Setting] to [On] (p. 74).

There are dots in the shape of a grid on the screen.

- These points are a normal result of the manufacturing process of the screen and do not affect the recording in any way.

Memory card

Operations using the memory card cannot be performed.

- If you use the memory card formatted on a computer, format it again on your camcorder (p. 77).

Images stored on the memory card cannot be deleted.

- The maximum number of images that you can delete on the index screen at one time is 100.
- You cannot delete the protected images.



The data file name is not indicated correctly or flashes.

- The file is damaged.
- The file format is not supported by your camcorder (p. 97).

Recording



Refer also to “Memory card” (p. 86).

Pressing START/STOP or PHOTO does not record images.

- The playback screen is displayed. Press MODE to turn on the  (Movie) or  (Photo) lamp (p. 24).
- Your camcorder is recording the image you have just shot on the recording media. You cannot make new recording during this period.
- The recording media is full. Delete unnecessary images (p. 41).
- Total number of movie scenes or photos exceeds the recordable capacity of your camcorder. Delete unnecessary images (p. 41).
- The temperature of your camcorder is extremely high. Turn off your camcorder and leave it for a while in a cool place.
- The temperature of your camcorder is extremely low. Turn off your camcorder and take it to a warm place. Leave the camcorder there for a while, then turn on the camcorder.

Photos cannot be recorded.

- You cannot record photos together with:
 - [Smth Slw REC]
 - [Golf Shot]
 - [ Fader]

- The camcorder cannot shoot photos while it is in the movie recording mode, depending on the [ REC Mode] or [ Frame Rate] selected.

The access lamp remains lit or flashing even if recording was stopped.

- Your camcorder is recording the scene you have just shot on the memory card.

The imaging field looks different.

- The imaging field may look different depending on the condition of your camcorder. This is not a malfunction.

The actual recording time for movies is less than the expected recording time of the recording media.

- Depending on the recording conditions, the time available for recording may be shorter, for example when recording a fast moving object, etc.

The camcorder stops operating.

- The temperature of your camcorder is extremely high. Turn off your camcorder and leave it for a while in a cool place.
- The temperature of your camcorder is extremely low. Turn off your camcorder and take it to a warm place. Leave the camcorder there for a while, then turn on the camcorder.
- If you keep applying vibration on the camcorder, recording may stop.

There is a time difference between the point when START/STOP is pressed and the point that the recording movie is started or stopped actually.

- On your camcorder, there may be a slight time difference between the point where you press START/STOP and the actual point that recording movie starts/stops. This is not a malfunction.





The horizontal to vertical ratio of the movie (16:9 (wide)/4:3) cannot be changed.

- The horizontal to vertical ratio of high definition image quality (HD) movies is 16:9 (wide).

The auto focus does not function.

- Set [Focus] to [Auto] (p. 68).
- The recording conditions are not suitable for auto focus. Adjust the focus manually (p. 68).

SteadyShot does not function.

- Set [ SteadyShot] to [Active] or [Standard], [ SteadyShot] to [On] (p. 71).
- Even if [ SteadyShot] is set to [Active] or [Standard], [ SteadyShot] to [On], your camcorder may not be able to compensate for excessive vibrations.

The subjects passing by the screen very fast appear crooked.

- This is called the focal plane phenomenon. This is not a malfunction. Because of the way the image device (CMOS sensor) reads out image signals, the subjects passing by the lens rapidly might appear crooked depending on the recording conditions.

Horizontal stripes appear on the images.

- This occurs when recording images under a fluorescent lamp, sodium lamp, or mercury lamp. This is not a malfunction.

Black bands appear when you record a TV screen or computer screen.

- Set [ SteadyShot] to an option except for [Active] (p. 71).

[LCD Brightness] cannot be adjusted.

- You cannot adjust [LCD Brightness] when:
 - The LCD panel is closed on your camcorder with the LCD screen facing out.
 - The power is supplied from the AC Adaptor.

Sound is not recorded correctly.

- If you disconnect an external microphone, etc. during recording movies, sound may not be recorded correctly.
- Connect the microphone again in the same way as when you start recording movies.

Playback

Images cannot be played back.

- Select the type of recording media you want to play back (p. 20) (HDR-CX160E/CX180E).
- Select the image quality of the movie you want to play back (p. 35).
- Images recorded on other devices may not be played back. This is not a malfunction.

Photos cannot be played back.



- Photos cannot be played back if you have modified files or folders, or have edited the data on a computer. (The file name flashes in that case.) This is not a malfunction.

 is indicated on a thumbnail.

- This may appear on an image recorded on other devices, edited on a computer, etc.
- You removed the AC Adaptor or the battery pack while the recording media icon at the top right corner of the screen flashes, or before the access lamp is turned off after recording. This may damage your image data and  is displayed.

 is indicated on a thumbnail.

- The image data base file may be damaged. Check the data base file by touching .

(MENU) → [Setup] →  (Media Settings) → [Repair Img. DB F.] → the recording medium (HDR-CX160E/CX180E). If it still appears, delete the image with  (p. 41).

No sound or only a quiet sound is heard during playback.

- Turn up the volume (p. 29).
- Sound is quiet when the LCD screen is closed facing out. Open the LCD screen.
- When you record sound with [Micref Level] (p. 73) set to [Low], the recorded sound may be difficult to hear.
- Sounds cannot be recorded while shooting with [Smth Slw REC] or [Golf Shot].

The demonstration movies cannot be played (HDR-CX160E/CX180E).

- Select the internal recording media for the recording media, and the high definition image quality (HD).
- The demonstration movie was deleted.

A movie is played back automatically (HDR-CX160E/CX180E).

- Movies play automatically as a demonstration movie when the filmed movie fulfills a certain condition on your camcorder (p. 82). This is not a malfunction.

Playing back images stored on memory card on other devices

Images cannot be played back or the memory card is not recognized.

- The playback device does not support playing back memory cards (p. 4).

Editing movies/photos on your camcorder

Unable to edit.

- Unable to edit because of the condition of the image.

A movie cannot be divided.

- A movie that is too short cannot be divided.
- A protected movie cannot be divided.

A photo cannot be captured from a movie.

- The recording media where you want to save photos is full.

Playback on the TV

Neither image nor sound is played on the connected TV.

- When you are using the component A/V cable, set [Component] according to the requirements of the connected device (p. 79).
- When you are using the component video plug, make sure the red and white plugs of the A/V connecting cable are connected (p. 31).
- Images are not output from the HDMI OUT jack, if copyright protection signals are recorded in the images.
- When you are using the S VIDEO plug, make sure the red and white plugs of the A/V connecting cable are connected (p. 32).

The top, bottom, right, and left edges of images are trimmed slightly on a connected TV.

- The LCD screen of your camcorder can display recording images across the entire screen (full pixel display). However, this may cause slight trimming of the top, bottom, right, and left edges of images when played back on

a TV which is not compatible with full pixel display.

- It is recommended you record images using the outer frame of [Guide Frame] (p. 73) as a guide.

The image appears distorted on the 4:3 TV.

- This happens when viewing an image recorded in the 16:9 (wide) mode on a 4:3 TV. Set [TV Type] correctly (p. 79) and play back the image.

Black bands appear at the top and bottom of the screen of the 4:3 TV.

- This happens when viewing an image recorded in the 16:9 (wide) mode on a 4:3 TV. This is not a malfunction.

The images being played back do not appear on the LCD screen when you connect the camcorder to a TV and play back images.

- Highlight Playback or a scenario will not appear on the LCD screen of the camcorder while it is connected to a TV and play back images.

Copying/Connecting to other devices

Images are not copied correctly.

- You cannot copy images using the HDMI cable (sold separately).
- The A/V connecting cable is not connected properly. Make sure to connect the cable to the input jack of another device (p. 61).

Self-diagnosis display/ Warning indicators

Connecting to a computer

“PMB” cannot be installed.

- Check the computer environment or installation procedure required to install “PMB.”

“PMB” does not work correctly.

- Quit “PMB” and restart your computer.

The camcorder is not recognized by the computer.

- Disconnect devices from the USB jack of the computer other than the keyboard, mouse, and your camcorder.
- Disconnect the Built-in USB Cable from the computer and your camcorder, and restart the computer, then connect the computer and your camcorder again in the correct order.
- When both the Built-in USB Cable and the USB jack of the camcorder are connected to the external devices at the same time, disconnect one that is not connected to a computer.

If indicators appear on the LCD screen, check the following.

If the problem persists even after you have tried to fix a couple of times, contact your Sony dealer or local authorized Sony service facility. In this case, when you contact them, give them all the numbers of the error code beginning with C or E.

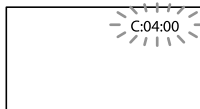

C:(or E:) □□:□□ (Self-diagnosis display)

C:04:□□

- The battery pack is not an “InfoLITHIUM” battery pack (V series). Use an “InfoLITHIUM” battery pack (V series) (p. 97).
- Connect the DC plug of the AC Adaptor to the DC IN jack of your camcorder securely (p. 13).

C:06:□□

- The battery pack temperature is high. Change the battery pack or place it in a cool place.

C:13:□□ / C:32:□□

- Remove the power source. Reconnect it and operate your camcorder again.

E:□□:□□

- Follow the steps from ② on page 84.

⚡ (Battery level warning)

- The battery pack is nearly used up.
- Depending on the operating environment or battery conditions, ⚡ may flash, even if there are about 20 minutes remaining.

⚠ (Warning indicator pertaining to battery pack temperature)

- The battery pack temperature is high. Change the battery pack or place it in a cool place.

 (Warning indicator pertaining to memory card)

Slow flashing

- Free spaces for recording images are running out. For the type of memory card you can use with your camcorder, see page 21.
- No memory card is inserted (p. 21).

Fast flashing

- There are not enough free spaces for recording images. After storing the images on other media (p. 52), delete unnecessary images, or format the memory card (p. 77).
- The image data base file may be damaged. Check the data base file by touching **MENU** (MENU) → [Setup] →  (Media Settings) → [Repair Img. DB F.] → the recording medium (HDR-CX160E/CX180E).
- The memory card is damaged.

 (Warning indicators pertaining to memory card formatting)

- The memory card is damaged.
- The memory card is not formatted correctly (p. 77).

 (Warning indicator pertaining to incompatible memory card)

- Incompatible memory card is inserted (p. 21).

 (Warning indicator pertaining to the write-protect of the memory card)

- The memory card is write-protected.
- Access to the memory card was restricted on another device.

 (Warning indicator pertaining to camera-shake warning)

- The camcorder is unsteady, so camera-shake easily occurs. Hold the camcorder steady with both hands and record the image. However, note that the camera-shake warning indicator does not disappear.

 (Warning indicator pertaining to photo recording)

- The recording media is full.
- Photos cannot be recorded during processing. Wait for a while, then record.
- When [ REC Mode] is set to [Highest Quality **FX**] or [50p Quality **PS**], you cannot capture photos while recording movies.

Tips

- You may hear a melody when some warning indicators appear on the screen.

Description of warning messages

If messages appear on the screen, follow the instructions.

Recording media

 Cannot recognize the internal memory. Format and use again.

- The internal recording medium of the camcorder is set differently from the default format. Performing [Format] (p. 77) may enable you to use your camcorder. This will delete all data in the internal recording medium.

Data error.

- An error occurred during reading or writing the internal recording media of the camcorder.
- This may occur when you keep applying shock on the camcorder.
- Movies recorded on other devices may not be played back.

The Image Database File is damaged. Do you want to create a new file?

HD movie management information is damaged. Create new information?

- The management file is damaged. When you touch [Yes], a new management file is created. The old recorded images on the media cannot be played back (Image files are not damaged). If you execute [Repair Img. DB F.] after creating new information, playing back the old recorded images may become possible. If it does not work, copy the image using the supplied software.

There is no Image Database File Movies cannot be recorded or played Create a new file?

- You cannot record or play back movies because no movie management information exists. If you touch [Yes], new management information is created and you can record or play back movies.

There is no HD movie management information. Create new information?

- You cannot record or play back movies because no high definition image quality (HD) movie management information exists. If you touch [Yes], new management information is created and you can record or play back movies with high definition image quality (HD).
- You can record standard definition image quality (STD) movies or photos.

Inconsistencies found in image database file. Do you want to repair the image database file?

The Image Database File is damaged. Do you want to repair the Image Database File?

Inconsistencies found in image database file. Cannot record or play HD movies. Do you want to repair the image database file?

- You cannot record or play back movies because no movie management information exists. If you touch [OK], new management information is created and you can record or play back movies.

Buffer overflow. Writing to the media was not completed in time.

- You have performed recording and erasing operations repeatedly, or a memory card that has been formatted by other device is used. Copy and take data backup to other device (such as a computer), and then format the memory card on the camcorder (p. 77).
- The size of the inserted memory card is not sufficient for copying the movie(s). Use the recommended memory card (p. 21).

Recovering data.

- Your camcorder tries to recover data automatically if the data writing was not performed properly.

Cannot recover data.

- Writing data onto the media of the camcorder has failed. Attempts were made to recover the data, but they were unsuccessful.

 Reinsert the memory card.

- Reinsert the memory card a few times. If even then the indicator flashes, the memory card could be damaged. Try with another memory card.

 Cannot recognize this memory card.
Format and use again.

- Format the memory card (p. 77). Note that if you format the memory card, all the recorded movies and photos are deleted.

 Still picture folder is full. Cannot record still pictures.

- You cannot create folders exceeding 999MSDCF. You cannot create or delete created folders using your camcorder.
- Format the memory card (p. 77), or delete folders using your computer.

This memory card may not be able to record or play movies.

- Use a memory card recommended for your camcorder (p. 21).

This memory card may not be able to record or play images correctly.

- Use a memory card recommended for your camcorder (p. 21).

Do not eject the memory card during writing. Data may be damaged.

- Reinsert the memory card, and follow the instructions on the LCD screen.
-

Other

Maximum number of images already selected.

- You can select only 100 images at one time for:
 - Deleting movies/photos
 - Protecting movies/photos, or releasing the protection
 - Copying movies/photos

Data protected.

- You tried to delete protected data. Release the protection of the data.
-

Using your camcorder abroad

Power supply

You can use your camcorder in any countries/regions using the AC Adaptor supplied with your camcorder within the AC 100 V to 240 V, 50 Hz/60 Hz range.

Viewing high definition image quality (HD) movies

In countries/regions where 1080/50i is supported, you can view the movies with the same high definition image quality (HD) as that of the recorded movies. You need a PAL-system-based and 1080/50i compatible TV (or monitor) with component and AUDIO/VIDEO input jacks. A component A/V cable or an HDMI cable (sold separately) must be connected.

Viewing standard definition image quality (STD) movies

To view standard definition image quality (STD) movies, you need a PAL-system-based TV with AUDIO/VIDEO input jacks. An A/V connecting cable must be connected.

On TV color systems

Your camcorder is a PAL-system-based camcorder. If you want to view the playback image on a TV, it must be a PAL-system-based TV with an AUDIO/VIDEO input jack.

System	Used in
PAL	Australia, Austria, Belgium, China, Czech Republic, Denmark, Finland, Germany, Holland, Hong Kong, Hungary, Italy, Kuwait, Malaysia, New Zealand, Norway, Poland, Portugal, Singapore, Slovak Republic, Spain, Sweden, Switzerland, Thailand, United Kingdom, etc.
PAL-M	Brazil
PAL-N	Argentina, Paraguay, Uruguay
NTSC	Bahama Islands, Bolivia, Canada, Central America, Chile, Colombia, Ecuador, Guyana, Jamaica, Japan, Korea, Mexico, Peru, Surinam, Taiwan, the Philippines, the USA, Venezuela, etc.
SECAM	Bulgaria, France, Guiana, Iran, Iraq, Monaco, Russia, Ukraine, etc.

Setting to the local time

You can easily set the clock to the local time by setting a time difference when using your camcorder abroad. Touch **MENU** (MENU) → [Setup] → [⌚ (Clock Settings)] → [Date & Time Setting] → [Summer Time] and **MENU** (MENU) → [Setup] → [⌚ (Clock Settings)] → [Area Setting] (p. 82).

World time difference

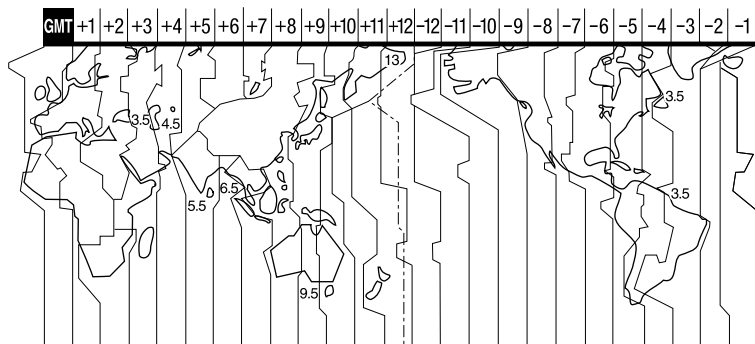

Time-zone differences	Area setting
GMT	Lisbon, London
+01:00	Berlin, Paris
+02:00	Helsinki, Cairo, Istanbul
+03:00	Moscow, Nairobi
+03:30	Tehran
+04:00	Abu Dhabi, Baku
+04:30	Kabul
+05:00	Karachi, Islamabad
+05:30	Calcutta, New Delhi
+06:00	Almaty, Dhaka
+06:30	Yangon
+07:00	Bangkok, Jakarta
+08:00	Hong Kong, Singapore, Beijing
+09:00	Seoul, Tokyo
+09:30	Adelaide, Darwin

Time-zone differences	Area setting
+10:00	Melbourne, Sydney
+11:00	Solomon Is
+12:00	Fiji, Wellington, Niwetok, Kwajalein
-11:00	Samoa
-10:00	Hawaii
-09:00	Alaska
-08:00	Los Angeles, Tijuana
-07:00	Denver, Arizona
-06:00	Chicago, Mexico City
-05:00	New York, Bogota
-04:00	Santiago
-03:30	St. John's
-03:00	Brasilia, Montevideo
-02:00	Fernando de Noronha
-01:00	Azores, Cape Verde Is.

Maintenance and precautions

About the AVCHD format

What is the AVCHD format?

The AVCHD format is a high definition digital video camera format used to record a high definition (HD) signal using efficient data compression coding technology. The MPEG-4 AVC/H.264 format is adopted to compress video data, and the Dolby Digital or Linear PCM system is used to compress audio data.

The MPEG-4 AVC/H.264 format is capable of compressing images at higher efficiency than that of the conventional image compressing format.

- As the AVCHD format uses a compression coding technology, the picture may be disturbed in scenes where picture, field angles or brightness, etc. change drastically, but this is not a malfunction.

Recording and playback on your camcorder

Based on the AVCHD format, your camcorder records with the high definition image quality (HD).

In addition to high definition image quality (HD), your camcorder is capable of recording a standard definition (STD) signal in the conventional MPEG-2 format.

Video signal*: MPEG-4 AVC/H.264 1920 × 1080/50i, 1440 × 1080/50i

Audio signal: Dolby Digital 2ch

Recording media:

HDR-CX130E: Memory card

HDR-CX160E/CX180E: Internal memory, memory card

- * Data recorded in AVCHD format other than the above mentioned cannot be played on your camcorder.

About the memory card

- A memory card formatted by a computer (Windows OS/Mac OS) does not have guaranteed compatibility with your camcorder.
- Data read/write speed may vary depending on the combination of the memory card and memory card compliant product you use.
- Damaged or lost data may occur in the following cases (the data will not be compensated for):
 - If you eject the memory card, or turn off your camcorder while your camcorder is reading or writing image files on the memory card (while the access lamp is lit or flashing)
 - If you use the memory card near magnets or magnetic fields
- It is recommended that you make a back-up of important data on the hard disk of a computer.
- Do not attach a label or the like on memory card or memory card adaptor.
- Do not touch, or allow metallic objects to come into contact with the terminals.
- Do not bend, drop or apply strong force to the memory card.
- Do not disassemble or modify the memory card.
- Do not let the memory card get wet.
- Keep the memory card out of the reach of small children. There is danger that a child might swallow it.
- Do not insert anything other than the compliant size of memory card into the memory card slot. Doing so may cause a malfunction.
- Do not use or keep the memory card in the following locations:
 - Places subject to extremely high temperature, such as a car parked outside in the summer
 - Places under direct sunlight
 - Places with extremely high humidity or subject to corrosive gases

On the memory card adaptor

- When using memory card with memory card compliant device inserting memory card into memory card adaptor, make sure the memory card is inserted facing in the correct direction. Note that improper use may cause a malfunction.

On image data compatibility

- Image data files recorded on memory card by your camcorder conform to the “Design rule for Camera File system” universal standard established by the JEITA (Japan Electronics and Information Technology Industries Association).
- On your camcorder, you cannot play back photos recorded on other devices (DCR-TRV900E or DSC-D700/D770) that do not conform to the universal standard. (These models are not sold in some regions.)
- If you cannot use memory cards that have been used with another device, format it with your camcorder (p. 77). Note that formatting erases all information on the memory card.
- You may not be able to play back images with your camcorder:
 - When playing back image data modified on your computer
 - When playing back image data recorded with other devices

About the “Memory Stick” media

Types of “Memory Stick” media	Recording/Playback
“Memory Stick Duo” media (with MagicGate)	—
“Memory Stick PRO Duo” media (Mark2)	✓
“Memory Stick PRO-HG Duo” media	✓

- This product supports parallel data transfer. However, the transfer speed may differ, depending on the type of media you use.

- This product cannot record or play data that uses “MagicGate” technology. “MagicGate” is a copyright protection technology that records and transfers the contents in an encrypted format.

About the “InfoLITHIUM” battery pack

Your camcorder operates only with an “InfoLITHIUM” V series battery packs. “InfoLITHIUM” V series battery packs have the  mark.

What is an “InfoLITHIUM” battery pack?

- An “InfoLITHIUM” battery pack is a lithium-ion battery pack that has functions for communicating information related to operating conditions between your camcorder and an AC Adaptor/charger (sold separately).
- The “InfoLITHIUM” battery pack calculates the power consumption according to the operating conditions of your camcorder, and displays the remaining battery time in minutes.
- The battery pack NP-FV50 is compatible with “ActiFORCE.”
“ActiFORCE” is a new generation power system. Battery capacity, boost charge, and the speed and accuracy of battery time remaining calculations have been improved when compared with current “InfoLITHIUM” P-series battery.

To charge the battery pack

- Be sure to charge the battery pack before you start using your camcorder.
- We recommend charging the battery pack in an ambient temperature of between 10 °C to 30 °C (50 °F to 86 °F) until the CHG (charge) lamp turns off. If you charge the battery pack outside of this temperature range, you may not be able to charge it efficiently.

To use the battery pack effectively

- Battery pack performance decreases when the ambient temperature is 10 °C (50 °F) or below, and the length of time you can use the battery pack becomes shorter. In that case, do one of the following to use the battery pack for a longer time.
 - Put the battery pack in a pocket to warm it up, and install it on your camcorder right before you start taking shots.
 - Use a large capacity battery pack: NP-FV70/ NP-FV100 (sold separately).
- Frequent use of the LCD screen or a frequent playback, fast forward or reverse operation wears out the battery pack faster. We recommend using a large capacity battery pack: NP-FV70/NP-FV100 (sold separately).
- Be sure to close the LCD screen when not recording or playing back on your camcorder. The battery pack is also consumed when your camcorder is in recording standby or playback pause.
- Have spare battery packs ready for 2 or 3 times the expected recording time, and make trial recordings before making the actual recording.
- Do not expose the battery pack to water. The battery pack is not water resistant.

About the remaining battery time indicator

- When the power goes off even though the remaining battery time indicator indicates that the battery pack has enough power to operate, charge the battery pack fully again. Remaining battery time will be indicated correctly. Note, however, that the battery indication will not be restored if it is used in high temperatures for a long time, or if left in a fully charged state, or when the battery pack is frequently used. Use the remaining battery time indication as a rough guide only.
- The  mark that indicates low battery flashes even if there are still 20 minutes of battery time remaining, depending on the operating conditions or ambient temperature.

About storage of the battery pack

- If the battery pack is not used for a long time, fully charge the battery pack and use it up on your camcorder once a year to maintain proper function. To store the battery pack, remove it from your camcorder and put it in a dry, cool place.
- To discharge the battery pack on your camcorder completely, touch **MENU** (MENU) → [Setup] → [ (General Settings)] → [A. Shut Off] → [Off], and leave your camcorder in recording standby until the power goes off (p. 81).

About battery life

- Battery capacity decreases over time and through repeated use. If decreased usage time between charges becomes significant, it is probably time to replace it with a new one.
- Each battery's life is governed by storage, operating and environmental conditions.

About x.v.Color

- x.v.Color is a more familiar term for the xvYCC standard proposed by Sony, and is a trademark of Sony.
- xvYCC is an international standard for color space in video. This standard can express a wider color range than the currently used broadcast standard.

About handling of your camcorder

On use and care

- Do not use or store the camcorder and accessories in the following locations:
 - Anywhere extremely hot, cold or humid. Never leave them exposed to temperatures above 60 °C (140 °F), such as under direct sunlight, near heaters or in a car parked in the sun. They may malfunction or become deformed.
 - Near strong magnetic fields or mechanical vibration. The camcorder may malfunction.

- Near strong radio waves or radiation. The camcorder may not be able to record properly.
- Near AM receivers and video equipment. Noise may occur.
- On a sandy beach or anywhere dusty. If sand or dust gets in your camcorder, it may malfunction. Sometimes this malfunction cannot be repaired.
- Near windows or outdoors, where the LCD screen, or the lens may be exposed to direct sunlight. This damages the LCD screen.
- Operate your camcorder on DC 6.8 V/7.2 V (battery pack) or DC 8.4 V (AC Adaptor).
- For DC or AC operation, use the accessories recommended in these operating instructions.
- Do not let your camcorder get wet, for example, from rain or sea water. If your camcorder gets wet, it may malfunction. Sometimes this malfunction cannot be repaired.
- If any solid object or liquid gets inside the casing, unplug your camcorder and have it checked by a Sony dealer before operating it any further.
- Avoid rough handling, disassembling, modifying, physical shock, or impact such as hammering, dropping or stepping on the product. Be particularly careful of the lens.
- Keep the LCD screen closed when you are not using your camcorder.
- Do not wrap your camcorder with a towel, for example, and operate it. Doing so might cause heat to build up inside.
- When disconnecting the power cord (mains lead), pull it by the plug and not the cord.
- Do not damage the power cord (mains lead) such as by placing anything heavy on it.
- Do not use a deformed or damaged battery pack.
- Keep metal contacts clean.
- If the battery electrolytic liquid has leaked:
 - Consult your local authorized Sony service facility.
 - Wash off any liquid that may have contacted your skin.
 - If any liquid gets in your eyes, wash with plenty of water and consult a doctor.

When not using your camcorder for a long time

- To keep your camcorder in optimum state for a long time, turn it on and let it run by recording and playing back images about once a month.
- Use up the battery pack completely before storing it.

Moisture condensation

If your camcorder is brought directly from a cold place to a warm place, moisture may condense inside your camcorder. This may cause a malfunction to your camcorder.

- If moisture condensation has occurred
Leave your camcorder for about 1 hour without turning it on.
- Note on moisture condensation
Moisture may condense when you bring your camcorder from a cold place into a warm place (or vice versa) or when you use your camcorder in a humid place as follows:
 - You bring your camcorder from a ski slope into a place warmed up by a heating device.
 - You bring your camcorder from an air conditioned car or room into a hot place outside.
 - You use your camcorder after a squall or a shower.
 - You use your camcorder in a hot and humid place.
- How to prevent moisture condensation
When you bring your camcorder from a cold place into a warm place, put your camcorder in a plastic bag and seal it tightly. Remove the bag when the air temperature inside the plastic bag has reached the surrounding temperature (after about 1 hour).

LCD screen

- Do not exert excessive pressure on the LCD screen, as it may cause uneven color and other damage.
- If your camcorder is used in a cold place, a residual image may appear on the LCD screen. This is not a malfunction.

- While using your camcorder, the back of the LCD screen may heat up. This is not a malfunction.

To clean the LCD screen

- If fingerprints or dust make the LCD screen dirty, it is recommended that you use a soft cloth to clean it.

On adjustment of the touch panel ([Calibration])

The buttons on the touch panel may not work correctly. If this happens, follow the procedure below. It is recommended that you connect your camcorder to the wall outlet (wall socket) using the supplied AC Adaptor during the operation.

- ① **MENU** (MENU) → [Setup] → [General Settings] → [Calibration].

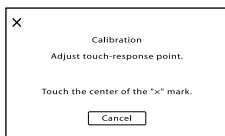

- ② Touch "X" displayed on the screen with the corner of memory card or the like 3 times. Touch [Cancel] to cancel calibration.

⚡ Notes

- If you did not press the right spot, try the calibration again.
- Do not use a sharp-pointed object for calibration. Doing so may damage the LCD screen.
- You cannot calibrate the LCD screen if it is rotated, or closed with the screen facing out.

On handling the casing

- If the casing is soiled, clean the camcorder body with a soft cloth lightly moistened with water, and then wipe the casing with a dry soft cloth.
- Avoid the following to avoid damage to the finish:
 - Using chemicals such as thinner, benzene, alcohol, chemical cloths, repellent, insecticide and sunscreen

- Handling the camcorder with above substances on your hands
- Leaving the casing in contact with rubber or vinyl objects for a long period of time

About care and storage of the lens

- Wipe the surface of the lens clean with a soft cloth in the following instances:
 - When there are fingerprints on the lens surface
 - In hot or humid locations
 - When the lens is exposed to salty air such as at the seaside
- Store in a well-ventilated location subject to little dirt or dust.
- To prevent mold, periodically clean the lens as described above.

On charging the pre-installed rechargeable battery

Your camcorder has a pre-installed rechargeable battery to retain the date, time, and other settings even when the LCD screen is closed. The pre-installed rechargeable battery is always charged while your camcorder is connected to the wall outlet (wall socket) via the AC Adaptor or while the battery pack is attached. The rechargeable battery will be fully discharged in about 3 months if you do not use your camcorder at all. Use your camcorder after charging the pre-installed rechargeable battery. However, even if the pre-installed rechargeable battery is not charged, the camcorder operation will not be affected as long as you are not recording the date.

How to charge the pre-installed rechargeable battery

Connect your camcorder to a wall outlet (wall socket) using the supplied AC Adaptor, and leave it with the LCD screen closed for more than 24 hours.

Note on disposal/transfer of the camcorder (HDR-CX160E/CX180E)

Even if you delete all movies and still images, or perform [Format] (p. 77), data on the internal recording media may not be completely erased. When you transfer the camcorder, it is recommended that you perform [Empty] (p. 77) to prevent the recovery of your data. Also, when you dispose of the camcorder, it is recommended that you destroy the actual body of the camcorder.

Note on disposal/transfer of the memory card

Even if you delete data in the memory card or format the memory card on your camcorder or a computer, you may not delete data from the memory card completely. When you give the memory card to somebody, it is recommended that you delete data completely using data deletion software on a computer. Also, when you dispose of the memory card, it is recommended that you destroy the actual body of the memory card.

On trademarks

- “Handycam” and **HANDYCAM** are registered trademarks of Sony Corporation.
- “AVCHD” and “AVCHD” logotype are trademarks of Panasonic Corporation and Sony Corporation.
- “Memory Stick,” , “Memory Stick Duo,” **“MEMORY STICK DUO,”** “Memory Stick PRO Duo,” **“MEMORY STICK PRO DUO,”** “Memory Stick PRO-HG Duo,” **“MEMORY STICK PRO-HG DUO,”** “MagicGate,” **“MAGIC GATE,”** “MagicGate Memory Stick” and “MagicGate Memory Stick Duo” are trademarks or registered trademarks of Sony Corporation.
- “InfoLITHIUM” is a trademark of Sony Corporation.
- “x.v.Colour” is a trademark of Sony Corporation.
- “BIONZ” is a trademark of Sony Corporation.
- “BRAVIA” is a trademark of Sony Corporation.
- “DVDirect” is a trademark of Sony Corporation.
- “Blu-ray Disc” and the logo are trademarks.
- Dolby and the double-D symbol are trademarks of Dolby Laboratories.
- HDMI, the HDMI logo and High-Definition Multimedia Interface are trademarks or registered trademarks of HDMI Licensing LLC in the United States and other countries.
- Microsoft, Windows, Windows Vista, and DirectX are either registered trademarks or trademarks of Microsoft Corporation in the United States and/or other countries.
- Macintosh and Mac OS are registered trademarks of Apple Inc. in the U.S. and other countries.
- Intel, Intel Core, and Pentium are trademarks or registered trademarks of Intel Corporation or its subsidiaries in the United States and other countries.
-  and “PlayStation” are registered trademarks of Sony Computer Entertainment Inc..
- Adobe, the Adobe logo, and Adobe Acrobat are either registered trademarks or trademarks of Adobe Systems Incorporated in the United States and/or other countries.
- SDXC logo is a trademark of SD-3C, LLC.
- MultiMediaCard is a trademark of MultiMediaCard Association.

All other product names mentioned herein may be the trademarks or registered trademarks of their respective companies. Furthermore, ™ and ® are not mentioned in each case in this Handbook.

Notes on the License

ANY USE OF THIS PRODUCT OTHER THAN CONSUMER PERSONAL USE IN ANY MANNER THAT COMPLIES WITH THE MPEG-2 STANDARD FOR ENCODING VIDEO INFORMATION FOR PACKAGED MEDIA IS EXPRESSLY PROHIBITED WITHOUT A LICENSE UNDER APPLICABLE PATENTS IN THE MPEG-2 PATENT PORTFOLIO, WHICH LICENSE IS AVAILABLE FROM MPEG LA, L.L.C., 250 STEELE STREET, SUITE 300, DENVER, COLORADO 80206.

THIS PRODUCT IS LICENSED UNDER THE AVC PATENT PORTFOLIO LICENSE FOR THE PERSONAL AND NON-COMMERCIAL USE OF A CONSUMER TO

- (i) ENCODE VIDEO IN COMPLIANCE WITH THE AVC STANDARD (“AVC VIDEO”) AND/OR
- (ii) DECODE AVC VIDEO THAT WAS ENCODED BY A CONSUMER ENGAGED IN A PERSONAL AND NON-COMMERCIAL ACTIVITY AND/OR WAS OBTAINED FROM A VIDEO PROVIDER LICENSED TO PROVIDE AVC VIDEO.

NO LICENSE IS GRANTED OR SHALL BE IMPLIED FOR ANY OTHER USE. ADDITIONAL INFORMATION MAY BE OBTAINED FROM MPEG LA, L.L.C. SEE <[HTTP://WWW.MPEGLA.COM](http://www.mpegla.com)>

“C Library,” “zlib,” and “libjpeg” software are provided in your camcorder. We provide this software based on license agreements with their owners of copyright. Based on requests by the owners of copyright of these software applications, we have an obligation to inform you of the following. Please read the following sections.

Read “license3.pdf” in the “License” folder on the CD-ROM. You will find licenses (in English) of “C Library,” “zlib,” and “libjpeg” software.

On GNU GPL/LGPL applied software

The software that is eligible for the following GNU General Public License (hereinafter referred to as “GPL”) or GNU Lesser General Public License (hereinafter referred to as “LGPL”) are included in the camcorder.

This informs you that you have a right to have access to, modify, and redistribute source code for these software programs under the conditions of the supplied GPL/LGPL.

Source code is provided on the web. Use the following URL to download it. When downloading the source code, select HDR-CX180 as the model for your camcorder.

<http://www.sony.net/Products/Linux/>

We would prefer you do not contact us about the contents of source code.

Read “license2.pdf” in the “License” folder on the CD-ROM. You will find licenses (in English) of “GPL,” and “LGPL” software.

To view the PDF, Adobe Reader is needed. If it is not installed on your computer, you can download it from the Adobe Systems web page: <http://www.adobe.com/>

Screen indicators

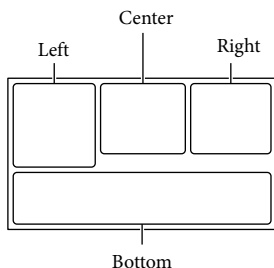

Left

Indicator	Meaning
	MENU button (63)
	Self-timer recording (70)
	Wide Mode (75)
	Fader (70)
	[Face Detection] set to [Off] (72)
	[Smile Shutter] set to [Off] (72)
	Manual focus (68)
	Scene Selection (69)
	White Balance (67)
	SteadyShot off (71)
	Tele Macro (70)
	x.v.Color (75)
	Conversion Lens (71)
	Destination (82)
	Intelligent Auto (face detection/scene detection/camera-shake detection) (34)

Center

Indicator	Meaning
[STBY]/[REC]	Recording status (24)
	Slide show set
	Warning (90)
	Playback mode (29)











Right

Indicator	Meaning
	Recording image quality (HD/STD), frame rate(50p/50i) and recording mode (PS/FX/FH/HQ/LP) (35)
60min	Remaining battery
	Recording/playback/editing media (20)
0:00:00	Counter (hour:minute:second)
00Min	Estimated recording remaining time
	Photo size (75)
9999	Approximate number of recordable photos and photo size
	Playback folder
100/112	Current playing movie or photo/Number of total recorded movies or photos (29)

Parts and controls

Figures in () are reference pages.

Bottom

Indicator	Meaning
	View Images button (27)
	Micref Level low (73)
	Wind Noise Reduct. (73)
	Blt-in Zoom Mic (73)
	Low Lux (69)
	Spot Meter/Fcs (67)/ Spot Meter (68)/ Exposure (68)
	Intelligent Auto (34)
	Slide show button
	101-0005 Data file name (30)
	Protected image (42)

- Indicators and their positions are approximate and may differ from what you actually see.
- Some indicators may not appear, depending on your camcorder model.

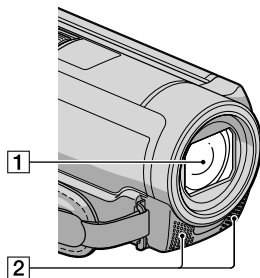

- 1 Lens (G lens)
- 2 Built-in microphone

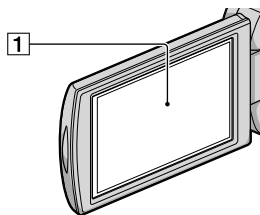

- 1 LCD screen/Touch panel (17, 38)

If you rotate the LCD panel 180 degrees, you can close the LCD panel with the LCD screen facing out. This is convenient during playback operations.

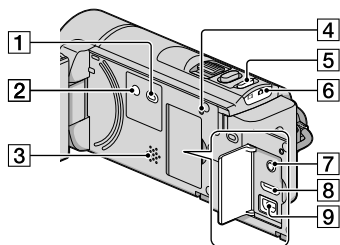

- 1 (View Images) button (27)
- 2 POWER button (17)
- 3 Speaker
- 4 RESET button

Press RESET using a pointed object.

Press RESET to initialize all the settings including the clock setting.

- 5 MODE button (24)
- 6 (Movie)/ (Photo) lamps (24)
- 7 MIC (PLUG IN POWER) jack (HDR-CX160E/CX180E)
- 8 HDMI OUT jack (31)
- 9 (USB) jack (54, 57)

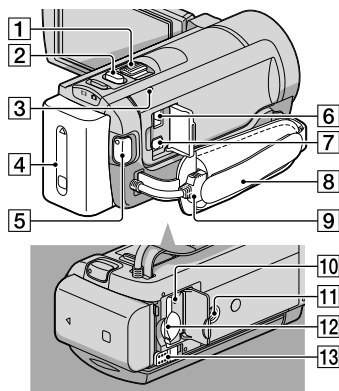

- 1 Power zoom lever (34)
- 2 PHOTO button (26)
- 3 CHG (charge) lamp (13)
- 4 Battery pack (13)
- 5 START/STOP button (24)
- 6 DC IN jack (13)
- 7 A/V Remote Connector (31)
- 8 Grip belt (23)
- 9 Built-in USB Cable (14)
- 10 Memory card access lamp (22)
While the lamp is lit or flashing, the camcorder is reading or writing data.
- 11 Tripod receptacle
Attach a tripod (sold separately) to the tripod receptacle using a tripod screw (sold separately: the length of the screw must be less than 5.5 mm (7/32 in.)).
- 12 Memory card slot (22)
- 13 BATT (battery) release lever (15)

Index

Symbols

1080i/576i.....	79
1080p/576p.....	79
576i.....	79

A

A. Shut Off.....	81
A/V connecting cable.....	32, 62
Abroad.....	94
Area Setting.....	82
Auto Back Light.....	72
AVCHD.....	46
AVCHD format.....	96

B

Battery Info.....	82
Battery pack.....	13
Beach.....	69
Black Fader.....	70
Blt-in Zoom Mic.....	73
Blu-ray disc.....	51
“BRAVIA” Sync.....	33
Built-in USB Cable.....	3, 14

C

Calibration.....	100
Camera/Mic.....	67
Camera Data.....	78
Capturing photos from a movie.....	45
Charging the battery pack.....	13
Charging the battery pack abroad.....	15, 94
Clock Set.....	17
Component.....	79
Connection.....	31
Conversion Lens.....	71
Convert Highlight Playback scenes/scenarios.....	40
Copy.....	43
Copying a disc.....	51
Creating a disc.....	46
Creating AVCHD disc.....	50
CTRL FOR HDMI.....	80

D

Data Code.....	18, 78
Date/Time.....	18
Date & Time Setting.....	82
Delete.....	41
Demo Mode.....	82
Digital Zoom.....	71
Disc Burn.....	48
Disc recorder.....	61
Display Setting.....	74
Divide.....	44
Dual Rec.....	37
DVDirect Express.....	57
DVD writer.....	57, 60

E

Edit/Copy.....	76
Empty.....	77
Event Index.....	27
Exposure.....	68
External media.....	54

F

Face Detection.....	72
Fader.....	70
FH.....	35
File Number.....	78
Fireworks.....	69
Focus.....	68
Format.....	77
Frame Rate.....	74
Fully charged.....	13
FX.....	35

G

Golf Shot.....	66
Guide Frame.....	73

H

HD/STD Set.....	35
HDMI Resolution.....	79
Highlight Playback.....	38
Highlight Setting.....	39
HQ.....	35

I

Image quality.....	35
Image Quality/Size.....	74
Image Size.....	75
Indoor.....	67
“InfoLITHIUM” battery pack... 97	
Intelligent Auto.....	34

L

Landscape.....	69
Language Setting.....	19, 81
LCD Brightness.....	81
Low Lux.....	69
LP.....	35

M

Maintenance.....	96
Media Info.....	77
Media Select.....	20
Media Settings.....	20
Memory card.....	21
“Memory Stick” media..... 21, 96	
“Memory Stick PRO-HG Duo” media.....	21
“Memory Stick PRO Duo” media.....	21
Menus.....	64
Micref Level.....	73
Mirror mode.....	38
Moisture condensation.....	99
Movies.....	24, 29
MPEG-4 AVC/H.264.....	96

O

One Push.....	67
Original.....	43
Outdoor.....	67

P

PAL.....	94
Photo Capture.....	45
Photos.....	26, 30
Playback Function.....	76
Playing.....	27
Playing AVCHD disc.....	50

Portrait	69
Power on	17
Power On By LCD	81
Precautions	96
Protect	42
PS	36

R

Rec Mode	35
Recording	23
Recording media	20
Repair	84
Repair Img.DB F.	88
RESET	105

S

Saving images in external media	54
Scenario	40
Scenario Erase	40
Scenario Save	40
Scene Selection	69
Screen indicators	103
Self-diagnosis display/Warning indicators	90
Self-Timer	70
Setting the date and time	17
Setup	77
Shooting Mode	65
Smile Sensitivity	73
Smile Shutter	37
Smth Slw REC	65
Snow	69
Spot Focus	68
Spotlight	69
Spot Meter	68
Spot Meter/Fcs	67
SteadyShot (Movie)	71
SteadyShot (Photo)	71
SummerTime	82
Sunrise&Sunset	69
Supplied items	3

T

Tele Macro	70
Telephoto	34
Thumbnail	42
Tripod	105
Troubleshooting	84
Turning the power on	17
TV	31
TV color systems	94
TV Type	79
Twilight	69

U

USB cable	57, 60
USB Connect	49
USB Connect Setting	80
USB LUN Setting	81

W

Wall outlet (wall socket)	13
Warning messages	91
White Balance	67
White Fader	70
Wide angle	34
Wide Mode	75
Wind Noise Reduct.	73

X

x.v.Color	98
-----------------	----

Z

Zoom	34
------------	----

Additional information on this product and answers to frequently asked questions can be found at our Customer Support Website.

<http://www.sony.net/>