

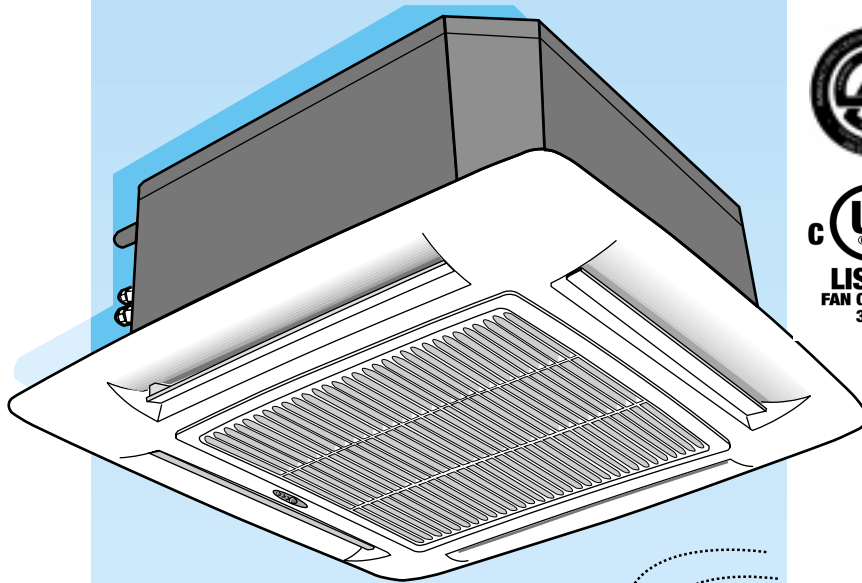

40KMC-----301

40KMQ-----301



UL US
LISTED
FAN COIL UNIT
36N2

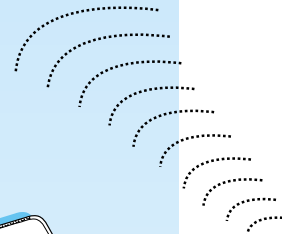
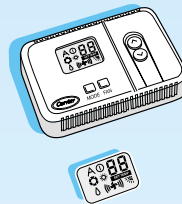
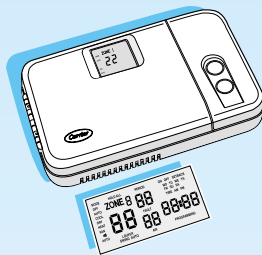

OWNER'S MANUAL

40KMC-----310/ 40KMQ-----310

Split system “Global cassette” indoor unit

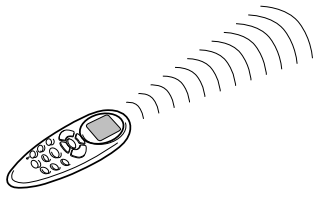

IR Remote Control

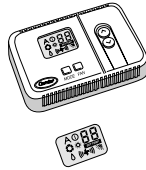

“Room Controller”

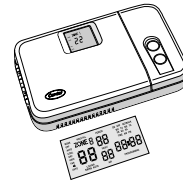

“Zone Manager”

The unit can be used with infrared Remote Control, with the Carrier “Room Controller” or “Zone Manager” remote control.

Carrier “Room controller” control instructions are contained in the present manual. Infrared Remote and “Zone Manager” controls instructions are contained in the relevant manuals.

The installation instructions for both the indoor and the outdoor unit are given in the manuals for each unit.

Contents

	Page
General information	2
System description	2
Unit LEDs and controls	3
Periodical checks	3
Optimum comfort and minimum power consumption	4
Correct cleaning	4
Before a long shutdown period	4
“Room controller” general information and characteristics	5
Unit protection devices	5
“Room controller” wired control	6/7
Troubleshooting	8

40KMC-----310/ 40KMQ-----310

General information

Unit operation and maintenance

Read this instruction manual thoroughly before using the unit.

- This unit complies with UL 1995 directive (Usa and Canada).
- Check that the main power supply voltage and frequency are as required for the unit; the power source must be sufficient to operate all other appliances connected to the same line. Also ensure that local building codes and NEC (National electrical code) requirements have been followed for the main supply circuit.
- To avoid personal injury or damage to unit, do not service until all power sources are shut down, locked out, and tagged out. Failure to do so could result in personal injury or unit damage.

⚠ WARNING:

To prevent fire, explosion or injury, do not operate the unit near dangerous substances or exposed to lighting equipment.

- All operation and maintenance manuals must be carefully looked after and kept with the equipment, should the unit change owners.
- Check that local building codes and NEC (National electrical code) requirements for the installation have been followed. **In particular, ensure that a properly sized and connected ground wire is in place.**
- Only use the unit for factory approved applications: the unit cannot be used in laundry premises.
- Do not use damaged equipment. In case of malfunction, turn the unit OFF and disconnect the main supply.
- Disconnect the main power supply prior to any maintenance operations or prior to handling any internal unit parts.
- The manufacturer declines any liability for damage resulting from modifications or errors in the electrical or refrigerant connections, made during the installation, or from improper use of this equipment. This will invalidate the unit warranty conditions immediately.
- This unit will only work safely and correctly, if installed and tested by qualified personnel.
- Do not open the remote control to avoid possible damage. In case of malfunction contact a qualified service engineer.
- This unit contains moving parts. Ensure that these parts are kept out of the reach of children.
- Maintain the room temperature at general comfort conditions, especially when children, elderly or handicapped persons are present.
- In order to ensure correct use, the air conditioner must operate within the temperature limits indicated in the "Operating Limits" table, included in the Technical manual. Failure to observe these limits may cause unit malfunction or water leakage.
- In order to avoid electric shock, fire or injury, stop the unit and disconnect the safety switch in case of abnormal events (such as

smell of burning) and call Carrier Service for further instructions.

- A routine maintenance should be carried out on the unit to check the correct operation of the electric connections and protection devices.
- Extraordinary maintenance operations must be carried out by specially trained personnel.
- Do not attempt to repair, move, modify or re-install the unit on your own. To avoid electric shock or fire make sure these operations are carried out by qualified personnel only.
- Contact the qualified service if one of the following events takes place:
 - hot or damaged power supply cable;
 - unusual noise during operation;
 - frequent operation of the protection devices;
 - unusual smell (such as smell of burning).

⚠ WARNING:

Never operate unit without a filter or with grille removed. Damage to the unit or personal injury may result.

⚠ WARNING:

If air filter is not replaced in the unit, dust and dirt gather in air conditioner and operation becomes impaired.

- A mist or cloud of vapor may be emitted from the unit, when switching from a cooling operation to a reverse cycle heating operation. This will occur when the unit has been operating in cooling mode for awhile and then is switched to heating. The combination of the evaporated indoor coil condensate and the dry room air, may result in a cloud of vapor being emitted from the unit. There is no need for concern.
- Inspect equipment for damage during transport. In case of damage file an immediate claim with the shipping company.
- Non-routine maintenance of the refrigerant circuit must only be carried out by qualified personnel.
- **All of the manufacturing and packaging materials used for this appliance are biodegradable and recyclable.**
- Dispose of the packaging material and of the remote control batteries in accordance with local requirements.
- This equipment contains refrigerant that must be disposed of correctly. When disposing of the unit at the end of its operational life, take the unit to an authorised waste disposal centre, for correct disposal procedures.

⚠ WARNING:

The unit must always be switched OFF using the Room Controller. Do not switch OFF the split system by disconnecting the electric power supply.

System description

- A. Outdoor unit
- B. Indoor unit
- C. Room Controller (if foreseen)

1. Air return
2. Air filters
3. Air supply
4. Operation indicator light and receiver of remote control signals (if foreseen)
5. Nameplate
6. Interconnecting tubing
7. Condensate drain (open)

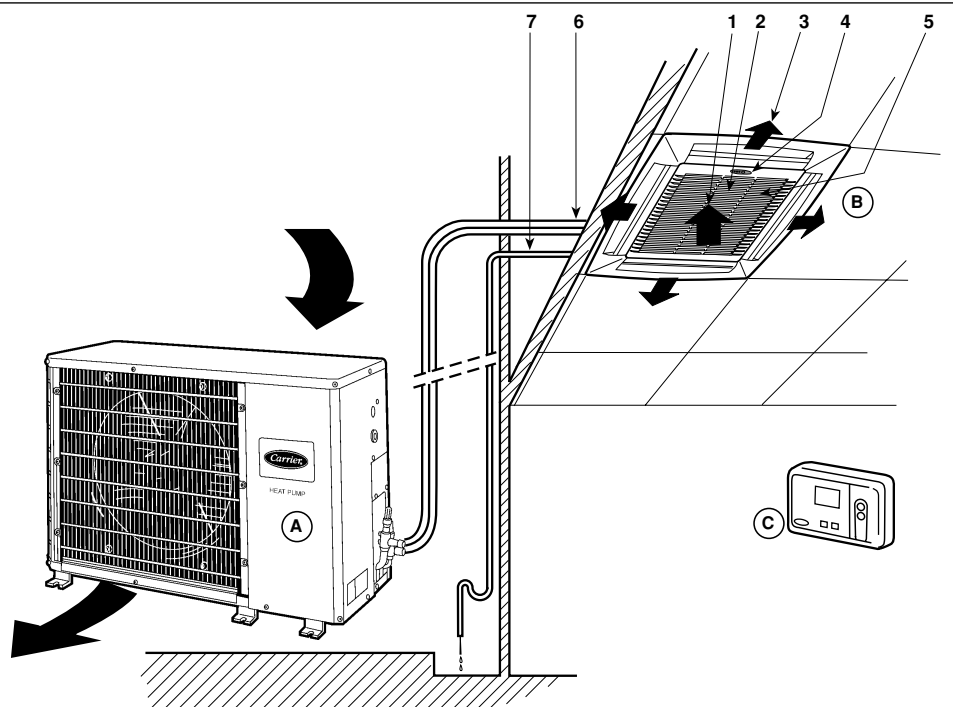

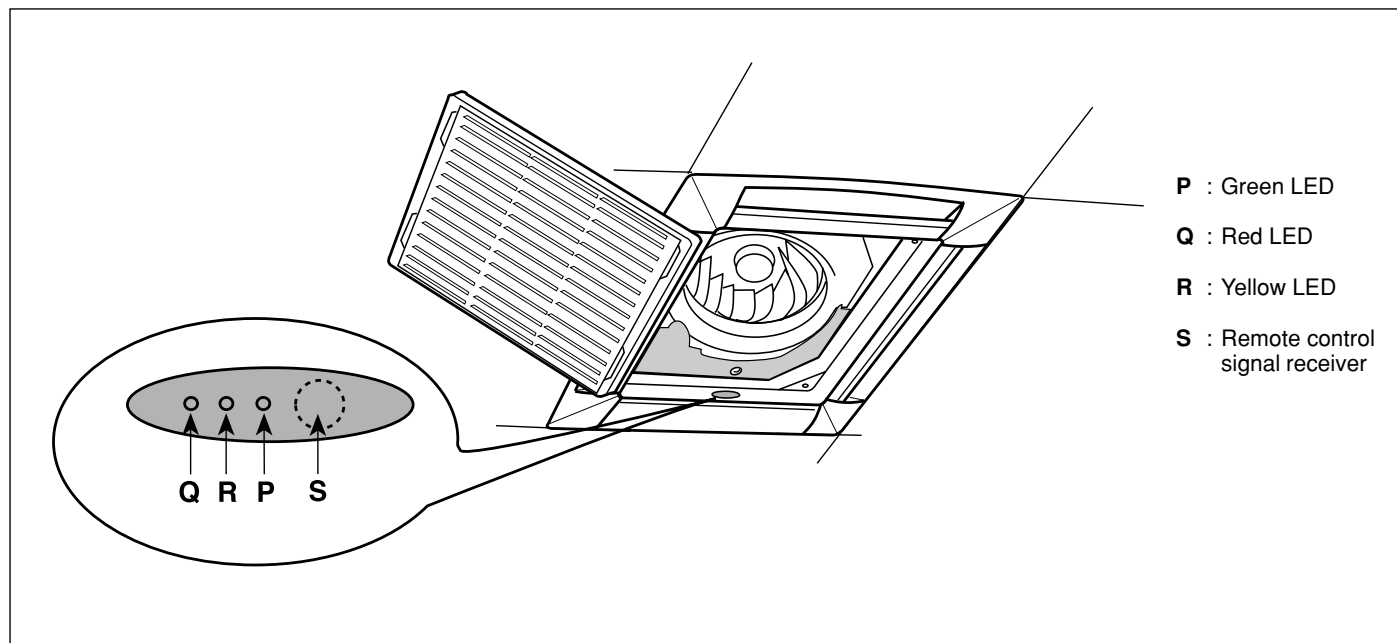

Indoor unit LEDs

Information concerning indoor unit operation, timer status and diagnostic is given by 3 LEDs located on the unit.

• **THE GREEN LED (P)** shows the following conditions:

- Fault codes (diagnostic);
- During normal operation, the LED is lit.

Once a failure occurs, the LED flashes at intervals of 0.5 seconds. The fault code is deduced from the number of times the LED flashes. Between one flash cycle and the next a pause of 5 seconds elapses.

• **THE RED LED (Q)** gives the following information:

- During normal operation, the LED is OFF;
- During defrost the LED is lit;
- During the test for wired connection, the LED flashes at 0.1 second intervals.

• **THE YELLOW LED (R)** shows the operation in timer mode. During this operation the LED is lit.

If the timer mode is active and the unit is immediately restarted after a stop, this LED flashes until a new signal is sent to the unit.

In case the Room Controller is not working, obtain a qualified service personnel.

Fault code

Once a failure occurs with the indoor unit in operation, the green unit LED flashes at intervals of 0.5 seconds. The fault code is deduced from the number of times the green LED flashes, blocking unit operation. Between one flash cycle and the next one, a pause of 5 seconds elapses.

Table IX: Fault code

Code	Description
3	Room air sensor fault
2	Condensate discharge pump
4	Indoor unit coil sensor fault
6*	Filter dirty
7	Outdoor unit failure
10	EEPROM corrupt
11	Card serial number damaged
12	Address / zone incomplete
13	Gas flow distributor corrupt
14	Outdoor air thermistor

* with enabled code

Table II: Periodical checks

Indoor unit	Every month	Every 4 months	Every year	For a good operation of the air conditioner it is recommended to carry out checks and maintenance as indicated. Recommended maintenance intervals may vary depending on the installation environment, e.g. dusty zones, etc.
Clean air filter (2) Clean drain pipe (2)	• ⁽¹⁾	•		
Outdoor unit	Every month	Every 4 months	Every year	
Clean outdoor coil from outside Clean outdoor coil from inside (2) Blow air over electric parts (2) Check electric connection tightening (2) Clean fan wheel (2) Check fan tightening (2) Clean drain pan (2)		•	• • • • •	(1) Increase frequency in dusty zones. (2) Operations to be carried out by qualified service personnel. Refer also to "Installation Manual".

40KMC-----310/ 40KMQ-----310

Optimum comfort... - Correct cleaning - Before a long shutdown period

Optimum comfort and minimum power consumption

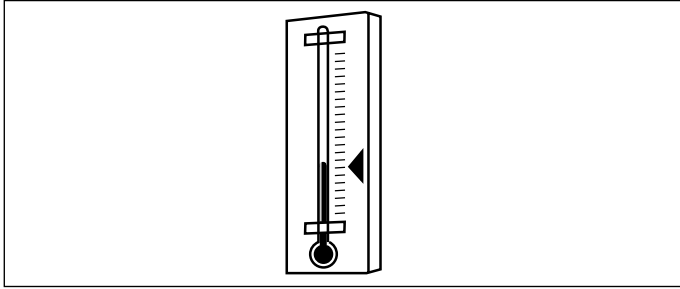

Keep room temperature at a comfortable level.

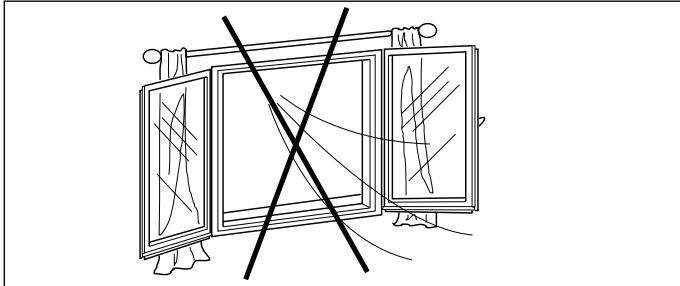

Only open doors and windows when strictly necessary.

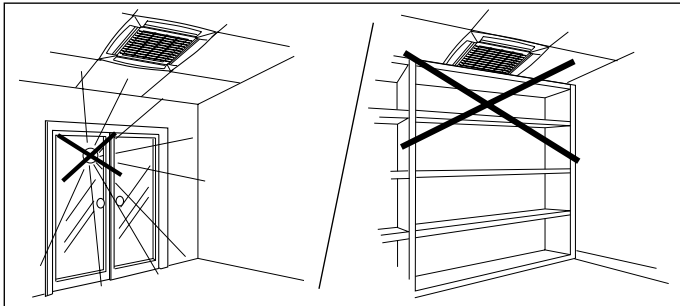

When cooling, avoid direct sunlight in the room: if possible, draw the curtains or close the shades.

Do not obstruct the air intake or outlet of the indoor unit. Obstructions will cause a reduction in the air flow and the conditioning effect, resulting in unit malfunction.

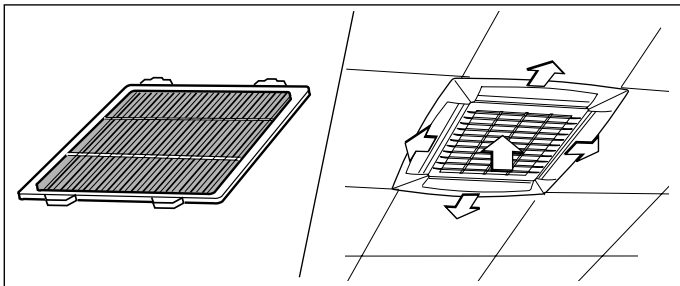

Ensure that the air filters are clean. Ensure that the air distribution in the room is uniform by properly adjusting the air flow direction.

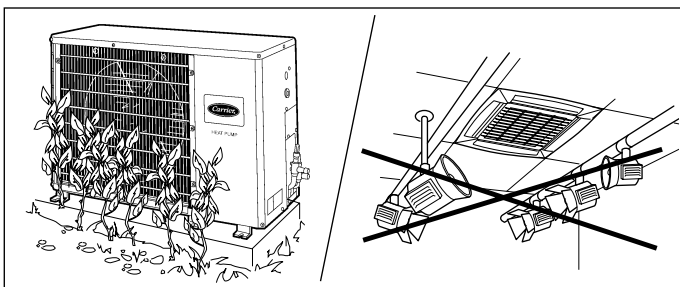

Periodically clean the area surrounding the outdoor unit and the air intake, in order to avoid reduced air circulation. Keep heat sources away from the unit: panels may be damaged.

Correct cleaning

• Turn the unit OFF and switch the main supply OFF.

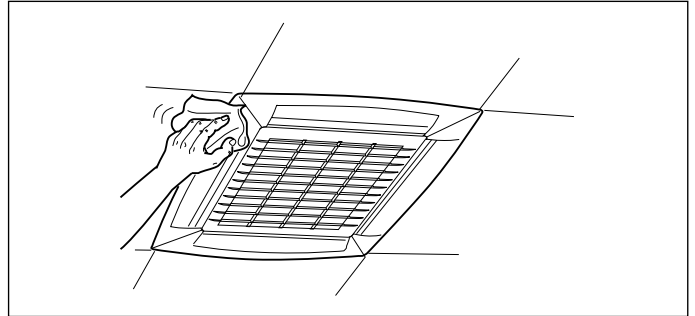

Use only a clean, damp cloth and a mild detergent. Do not use flammable liquids, solvents or abrasive powders that may result in damage to the panels. Use only a dry cloth to clean the remote control.

Before a long shutdown period

Ask to clean the filter and replace it in the unit.

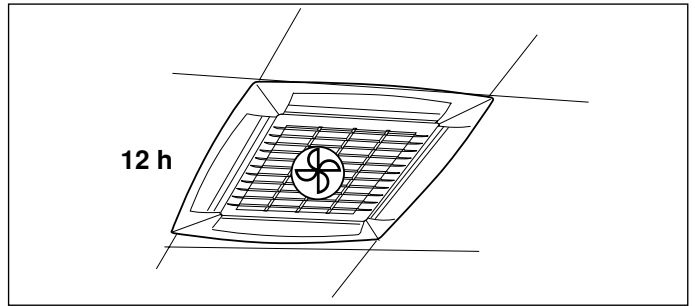

Keep the unit in operation for half a day in the ventilation (fan only) mode in order to dry all internal parts.

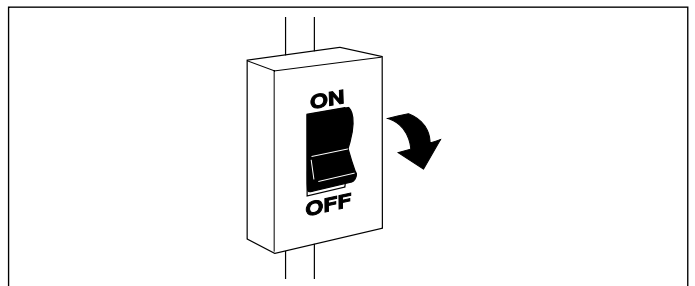

Switch the unit OFF and wait for at least 3 minutes before switching OFF the main electric supply.

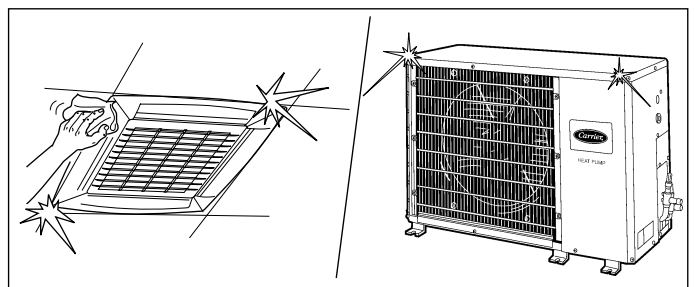

Clean indoor and outdoor units.

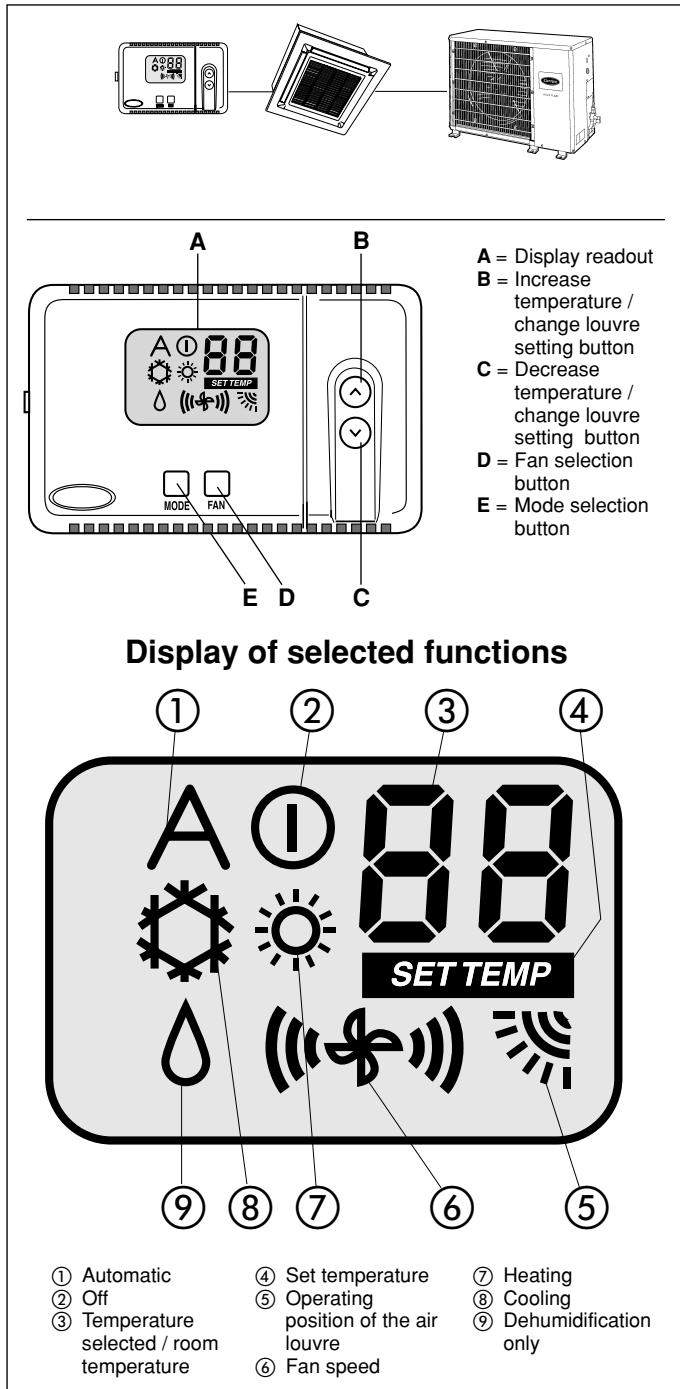

Characteristics

- **Single unit operation:**
Ability to control one unit only.
- **Grouping:**
Ability to control 2 to 6 units with one Room Controller.
- **Operating modes:**
Off, Heat, Cool, Dry, Auto, and Fan only.
- **Fan speeds:**
Low, Medium, High, and Auto.
- **Louver control:**
Auto and swing.
- **Desired temperature:**
Range between 17 and 32 °C (63 and 90 °F).
- **Room Thermistor Override:**
Allows to use air sensor located in the Room Controller instead of the one located into the unit.
- **Diagnostics:**
Detects the fault of air sensor in the Room Controller. “A1” shown on the screen indicates this anomaly.

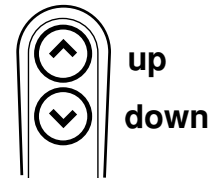

“up” and “down” buttons

Buttons for raising or lowering the temperature or for selecting the “AUTO” or “SWING” louvre mode.

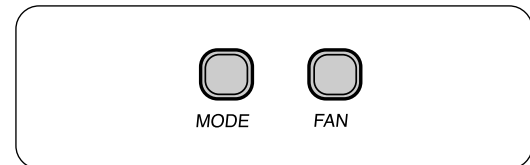

MODE

Button for operation mode selection.

FAN

Button for fan or louvre selection.

Table I: Unit protection devices

System	Type of protection	Effect of protection	Operation mode	When on
Heat pump	Cold draft prevention	Indoor fan off	Heating in heat pump mode	During unit operation
	Defrost cycle	Indoor fan off	Heating in heat pump mode	During unit operation
Cooling only and heat pump	Indoor coil freeze protection	Compressor off	Cooling	During unit operation
	Against frequent compressor cycling	Compressor time delay	Cooling or heating in heat pump mode	At unit start-up or change of operating mode

WARNING:

During heat pump operation the unit will undergo several defrost cycles to remove ice that might collect on the outdoor unit in very low ambient temperatures. In these cycles, the indoor fan will be automatically off and cannot operate until defrost cycle is completed.

40KMC-----310/ 40KMQ-----310

“Room controller” wired control

Power up

All segments of the LCD should be energized for five seconds. The mode, fan, louver, desired temperature and configuration information should be read from the EEPROM. If the EEPROM values are not valid, the following should be used as defaults.

Operating Mode	= AUTO
Fan Speed	= AUTO
Desired Temperature	= 72°F
°F °C	= F
Louver	= AUTO
Room Thermistor Override	= OFF
Cooling only vs Heat/Cool Remote	= Heat/Cool

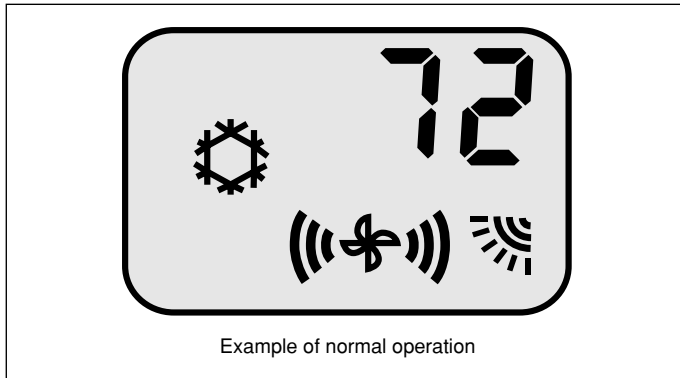

When switched on, the control display appears.

Setting mode operation

“MODE” button



Pressing the “MODE” button will cause the mode to change. The “MODE” button must be released and then pressed again in order to change to the next mode. The active mode will always be lit in normal operation. Available modes to select are:

Heat/Cool Remote:

① OFF, ⚙️ COOL, 💧 DRY, 🌀 FAN ONLY, A AUTO, ☀️ HEAT

Cooling Only Remote:

① OFF, ⚙️ COOL, 💧 DRY and 🌀 FAN ONLY

When the “MODE” button is not pressed for 15 seconds, the next press will always switch the mode to OFF.

OFF Mode:

ICONS Energized:

- OFF Mode
- Room Temperature if configured for Room Thermistor Override, otherwise nothing

Buttons available:

- “MODE” button

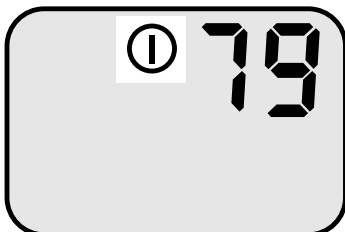

AUTO, HEAT, COOL and DRY Modes:

ICONS Energized:

- Operation Mode ICON.
- Room Temperature if configured for Room Thermistor Override (operated by Room Controller), otherwise user selected temperature with the “SET TEMP” Icon.
- FAN/LOUVER Icon with the user selected Fan and Louver settings.

Buttons available:

- All Buttons are available.

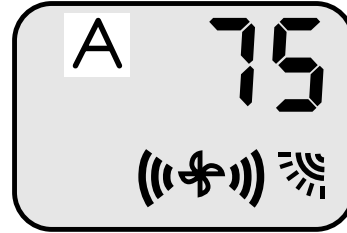

A **AUTO** Automatic operation

NOTE:

The compressor and electric heater must be off for at least 30 Minutes, this time being necessary to pass from Heating to Cooling, or Cooling to Heating. This will prevent the system from switching between Heating and Cooling continuously.

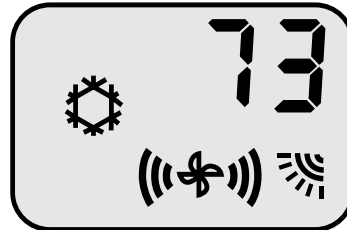

⚙️ **COOL** Cooling operation

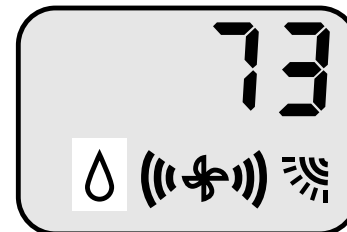

💧 **DRY** Drying operation.

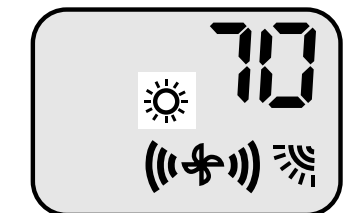

☀️ **HEAT** Heating operation.

“Room controller” wired control

FAN ONLY Mode:

ICONS Energized:

- Room Temperature if configured for Room Thermistor Override (operated by Room Controller), otherwise nothing.
- FAN/LOUVER Icon with the user selected Fan and Louver settings.

Buttons available:

- “MODE” and “FAN” buttons are available.

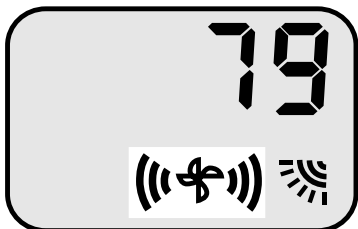

fan only Ventilation operation only.

“UP” and “DOWN” button (Selecting the desired temperature)

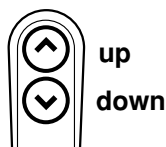

Pressing either the “up” or “down” buttons will modify the desired temperature.

The maximum desired temperature is 32°C (90°F) and the minimum desired temperature is 17°C (63°F).

Whenever the setpoint is being displayed, the “SET TEMP” icon is illuminated.

Whenever the display mode is changed from C to F, the setpoint is set to the default start-up values of 22°C for “C” mode and 72°F for “F” mode.



If the air sensor built in the Room Control is enabled, the display will indicate the room temperature after few seconds.

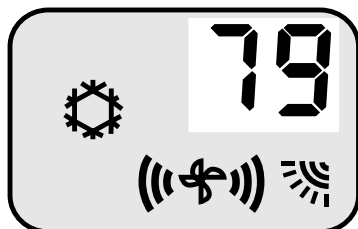

“FAN” button (Adjusting the ventilation speed)



Pressing the “FAN” button will cause the fan speed to change. The “FAN” SPEED button must be pressed and then released to reach the desired speed (Low, Medium, High or Auto). The icon on the display indicates that change has occurred.

Auto mode setting will be displayed by blinking the fan Medium speed and High speed icons in order (Med then Hi then repeat).

- Low
- Medium
- High
- Automatic
(Fan speed will automatically switch to the value required for optimum comfort).
When this function is activated, the dotted symbols will flash.

Louver mode selection



To enter louver mode selection, make sure the Room Controller is on and hold the “FAN” button down for 5 seconds.

After 5 seconds, the selected louver setting will be displayed.

By pressing the up and down buttons the user can modify the louver desired configuration.

The two settings will be displayed in the following way:

“S” with Swing Louver Icon - represents Swing Louver.

“A” with Auto Louver Icon - represents Auto Louver.

Press “FAN” button to exit LOUVER Mode Selection.

This mode will exit automatically after 10 seconds if no buttons are pressed.

The only way to change the operation mode, is to go back to this menu.

NOTE:

- If units are grouped to one Room Controller , all units will end up having the same louver value.
- Louver Mode selection is not available during OFF mode.

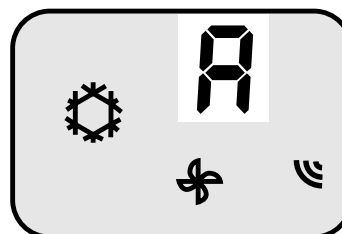

A:AUTO Automatic louvre positioning to the best position for the selected operating mode.



S :SWING Louvres swing continuously.

40KMC-----310/ 40KMQ-----310

Troubleshooting

No Room controller LCD display:

- Mis-wiring of the 12 volt power to Room Controller control; verify that + 12 V and Ground are connected to the proper terminals of the Controller (Reference Installation wiring section for correct connections): after disconnecting the power, correct the wiring problem and re-cycle power.
 - Power not online; check that the units main power is connected.
The main control board should be operating normally: after verifying the wiring to the Room Controller, re-cycle the unit power.
 - No 12 volts between P and G of terminal block; check the installation of the J6 plug on the main control board: after disconnecting the power, correct the wiring problem and re-cycle power.
- Note:** *Those verifications need to be carried out by qualified personnel only.*
-

+12 volts applied to Room Controller at the correct terminals and still does not operate:

- The Room Controller is damaged; change the Room Controller and re-cycle power.
- Note:** *This operation needs to be carried out by qualified personnel only.*
-

Air conditioner will not start:

- The main switch is switched OFF, place the switch in the ON position.
 - The fuses on the main switch are burnt out; replace the fuses. (*this operation need to be carried out by qualified personnel only.*)
 - Wait for 3 minutes: protection against frequent compressor cycling is ON.
 - Selected temperature is higher than the room temperature (or lower in the heating mode).
-

Air conditioner is not supplying enough cooling (or heating):

- Air cannot circulate freely.
 - Dirty filter reduces air quantity circulating.
Filter must be cleaned by skilled personnel only.
 - Doors and/or windows are open.
 - Fan speed has been set to 'low'.
 - Air flow direction is not correct for optimum ventilation.
 - Selected temperature is not correct.
-

A slight mist is emitted from the unit:

- A slight mist, coming out of the unit air outlet, is sometimes noticed during cooling operation. This is due to the cool air coming into contact with the room air.
-

A slight whistling noise is heard when the air conditioner starts or stops:

- This is due to the refrigerant beginning to circulate or an adjustment of the refrigerant pressures. This is a normal operating condition.
-

P (Green LED) indicator is flashing:

System malfunction.

Contact service organisation after having ensured that:

- Air circulation is not obstructed.
- Outdoor unit coil is not obstructed and causing severe reduction of air circulation.
- Condensate drainage tube is not obstructed.

As regards fault codes to be communicated to the after-sales

service, please refer to the installation instructions.

Restart air conditioner after having corrected the faults.

Q (Red LED) indicator is illuminated:

- In the heating mode, the LED switches on to indicate an active defrost condition.
-

The unit emits unpleasant smells:

- Unpleasant smells can accumulate on the air filters and then be dispersed into the room during air conditioner operation. Switch the unit OFF and contact an authorised service centre to have the filters cleaned.
Restart unit in the ventilation (fan only) mode and open windows to change room air.
-

The unit makes strange noises:

- Occasionally the unit makes strange noises at start-up, during operation or when it has stopped.
These are generally due to the effect of temperature changes on the plastic parts.
-

Mist or Vapor Cloud emitted at start-up of Heating operation:

- A mist or cloud of vapor may be emitted from the unit, when switching from a cooling operation to a reverse cycle heating operation. This will occur when the unit has been operating in cooling mode for awhile and then is switched to heating. The combination of the evaporated indoor coil condensate and the dry room air, may result in a cloud of vapor being emitted from the unit. There is no need for concern.
-

WARNING:

(models with electric heaters):

- If the manual reset, thermal trip device cuts out, switch the unit OFF and ON again at the main switch to reset.
If the malfunction persists, contact your local authorised dealer.



Via R. Sanzio, 9 - 20058 Villasanta (MI) Italy - Tel. 039/3636.1

The manufacturer reserves the right to change any product specifications without notice.

March, 2006.

Printed in Italy