

**Fisher-Price®**

**N9326**



[www.fisher-price.com](http://www.fisher-price.com)

## Important!

### **DANGER**

To prevent electric shock, do not immerse in water; wipe clean with damp cloth.

### **WARNING**

To prevent strangulation with power cord, never place transmitter within reach of child.

### **CAUTION**

This product cannot replace responsible adult supervision.

# Important!

- For proper setup and use, please read these instructions.
- Please keep this instruction sheet for future reference, as it contains important information.
- Transmitter operates on AC current. Receiver operates on AC current (use enclosed AC adaptor) or 3.6V NiMH rechargeable battery pack (included).
- Before first time use, charge the rechargeable battery pack for **four hours**.
- Adult assembly is required for wall mounting. Tools needed for assembly: electric drill, ¼" drill bit, hammer, Phillips screwdriver (tools not included).
- This product is not intended to be used as a medical monitor and its use should not replace adult supervision.
- Test sound/audio reception of receiver before first-time use and whenever you change location of the transmitter.
- **Adults Note:** Periodically examine this product for damage to the cord, housing or other parts that may result in the risk of fire, electric shock or injury. If the product is damaged, do not use it.
- Never use extension cords with the AC adaptor.
- Never use transmitter or receiver near water (i.e. bathtub, sink, wet basement, etc.).
- Always use transmitter and receiver where there is adequate ventilation. To prevent overheating, keep away from heat sources such as radiators, heat registers, direct sunlight, stoves, amplifiers, fire, excessive heat or other appliances that produce heat.
- Fisher-Price® does not recommend the use of two monitors in one house.
- Always remember that you are using public airwaves when using your monitor. Conversations, even from rooms near your transmitter, may broadcast to other nursery monitors, radios, cordless telephones or scanners outside your home. To protect the privacy of your home, always turn off the transmitter when not in use.
- Do not connect to more than the recommended number of power supplies.
- The AC adaptor is not a toy.
- Disconnect the AC adaptor from the receiver before cleaning.
- If this product begins to operate erratically, you may need to reset the electronics. Turn the transmitter power/volume dial off and then back on; press the receiver main power/menu button to turn power off and press again to turn power back on.
- Carrier Frequency: 2.4 Ghz
- Product features and decoration may vary from photos.

# Features

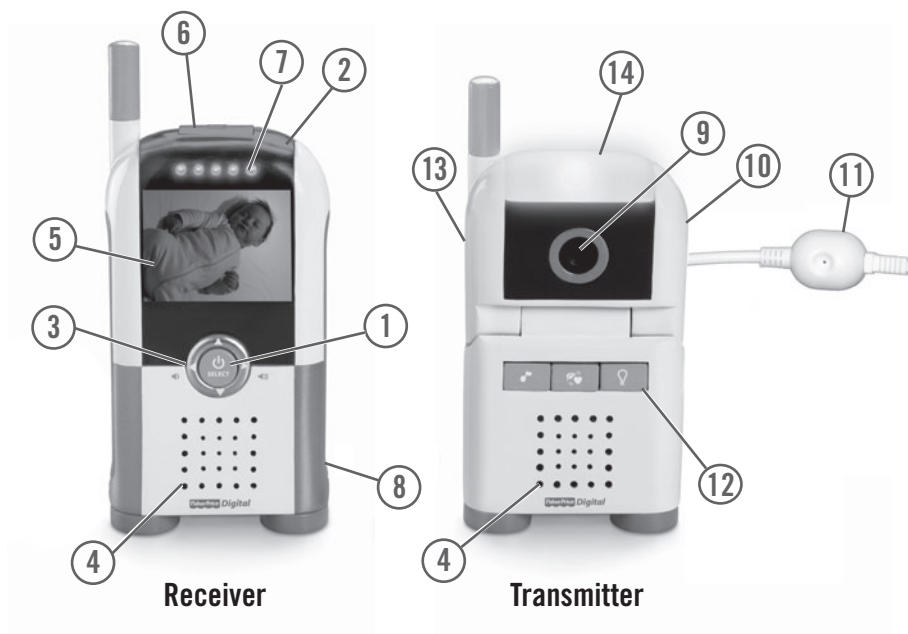



**AC Adaptor/Charger**



**Transmitter Tabletop Stand**

# Features

- ① Main Power/Menu Button – Press to turn receiver main power ON; press again for the main menu; press and hold for approximately five seconds to turn main power OFF.
- ② Power L.E.D. – Turns on when receiver power is ON.
- ③ Menu Navigation/Volume Control Button – Press up, down or side arrows to scroll through menu options. When the menu is not on the screen, press the side arrows to adjust volume.
- ④ Speaker
- ⑤ Video Screen
- ⑥ Video Screen On/Off Button – Press to turn the video screen on; press again to turn it off.
- ⑦ Sound Lights – Shows you baby's sounds.
- ⑧ DC Input Jack – Insert the AC adaptor/charger pin to use AC power/charge the battery.
- ⑨ Camera Lens
- ⑩ Power/Volume Dial – Rotate to turn transmitter power ON and adjust volume to a comfortable level for baby.
- ⑪ Microphone
- ⑫ Music, Sounds and Night Light Buttons
  -  Music – Choose from 5 lullaby songs.
  -  Sounds – Play nature sounds.
  -  Night Light – Turn on night light for baby.
- ⑬ Power L.E.D. – Turns on when transmitter power is ON.
- ⑭ Night Light – Lights room with a soft glow.

# Wall Mount Parts



Wall Mount Bracket

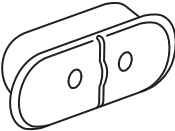

Cord Wrap

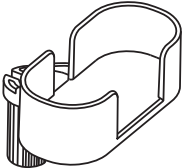

Base Stand

## Fasteners Shown Actual Size

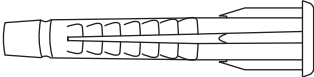

Wall Anchor – 4



#8 x 2" Screw – 4

# Charging the Battery (Inside the Receiver)

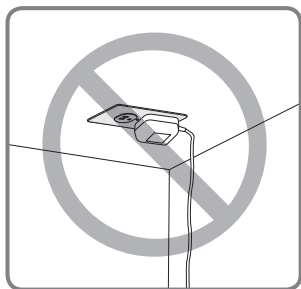

**IMPORTANT!** Fully charge the receiver (with battery pack inside) for **four hours before first-time use**. Use only the included AC adaptor charger! Do not use any other adaptor charger.

- Fit the AC adaptor charger pin into the DC input jack on the receiver.
- Plug the AC adaptor charger into a standard wall outlet.

**Notes:** If power flow to the wall outlet is controlled by a switch, make sure the switch is “ON”. Use the AC adaptor charger only in a wall outlet. Do not plug the AC adaptor charger into a ceiling outlet. To connect to a supply that is not in the United States, use an adaptor (not included and sold separately) with the proper configuration for the power outlet.

- If you are monitoring baby while charging the battery pack, you will see the charging icon  on the video screen.

# Testing Sound/Video Reception

**Test transmitter transmission and receiver reception before installing the wall mount bracket and cord wrap (if used) and each time you change location of use.**



- Place the transmitter in the room where you intend to use it.
- Point the transmitter toward the area you will be monitoring. Adjust the camera angle by rotating the top portion of the transmitter up or down.
- Turn the power/volume dial ON.
- Turn on a radio.



# Testing Sound/Video Reception



- Place the receiver in the room where you intend to use it.
- Press the main power/menu select button on the front of the receiver to turn power ON.
- Adjust the receiver location for best reception.
- When sound is picked up by the receiver, the sound lights will turn on.
  - One or two lights indicate quieter sounds.
  - Three or more lights indicate louder sounds.
- If you cannot see an image on the receiver screen, adjust the transmitter location or camera angle.

# Transmitter Wall Mount Installation



## WARNING

To prevent strangulation with power cord, never place transmitter within reach of child.

**IMPORTANT!** Test the reception of the monitor **before installing the wall mount bracket and cord wrap.** Use the assistance of one adult to hold the transmitter against the wall in the spot you want to install it. Then, test the reception of the receiver in several locations around your house. Please refer to the Testing Sound/Video Reception section of these instructions.

# Transmitter Wall Mount Installation

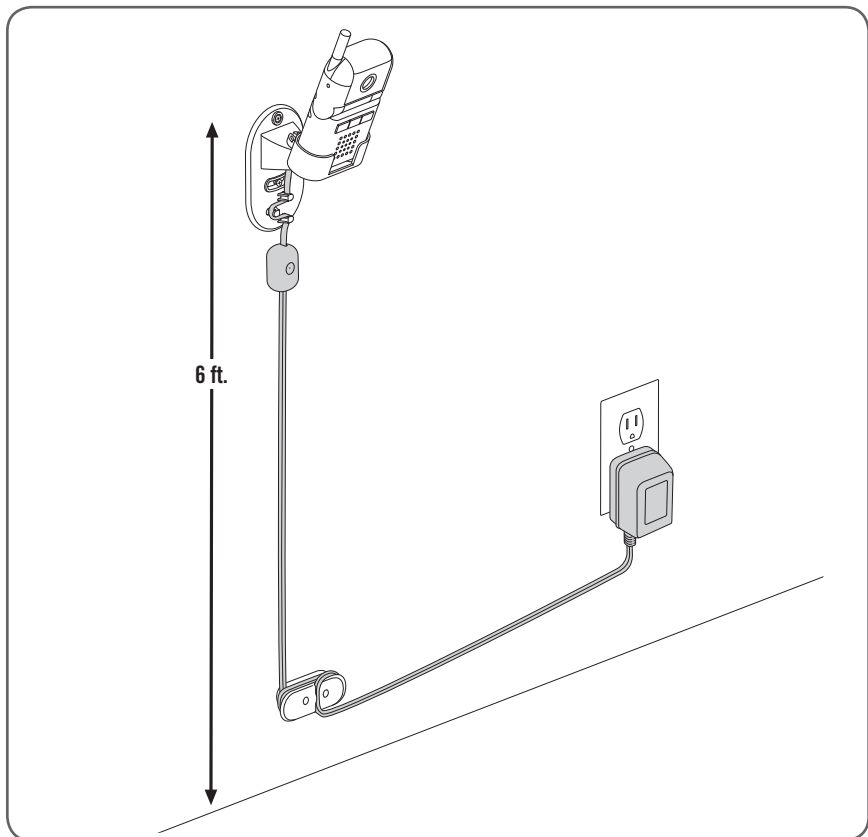

- To provide the greatest viewing range, we recommend you install the wall mount bracket **at least six feet from the floor**.
- Make sure the camera lens does not have an obstructed view of your baby. Adjust the camera up or down.
- Allow adequate ventilation of the transmitter when mounted. **Do not** mount the transmitter above heating vents or other heat producing sources. **Do not** mount the transmitter where it can receive direct sunlight.
- Install the wall mount bracket on a flat section of the wall. The wall mount bracket cannot be corner mounted.
- Make sure the AC adaptor will reach a wall outlet before installing the wall mount bracket. To prevent entanglement, **never** use an extension cord.

# Transmitter Wall Mount Installation

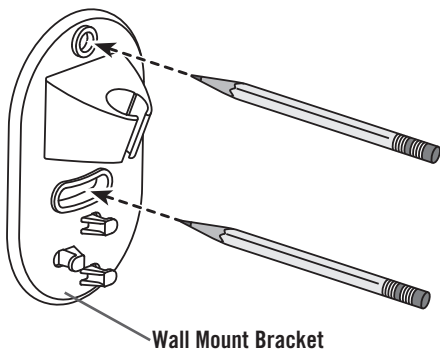

1

- Hold the wall mount bracket against the wall in the location you want to install it. Make sure the wall mount bracket is straight.
- Using a pencil, make a mark on the wall inside the upper hole and lower slot on the wall mount bracket.
- Set the wall mount bracket aside.

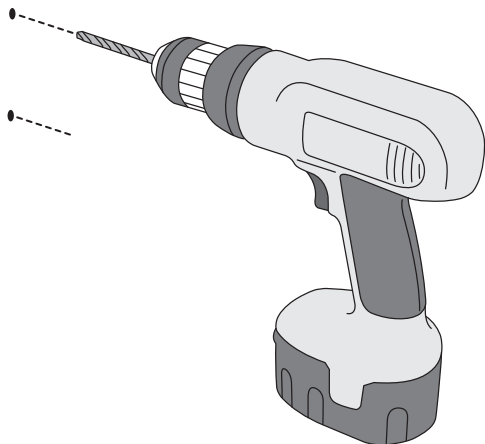

2

- Using a  $\frac{1}{4}$ " drill bit, drill one hole through each pencil mark you made on the wall.

# Transmitter Wall Mount Installation

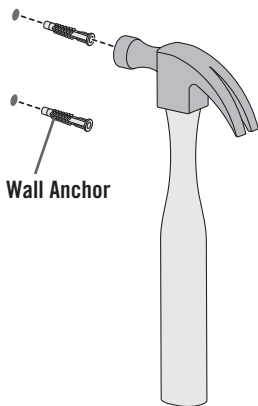

3

- Fit a wall anchor into each of the drilled holes.
- Tap each wall anchor **lightly** with a hammer until the ends of each wall anchor are even with the surface of the wall.

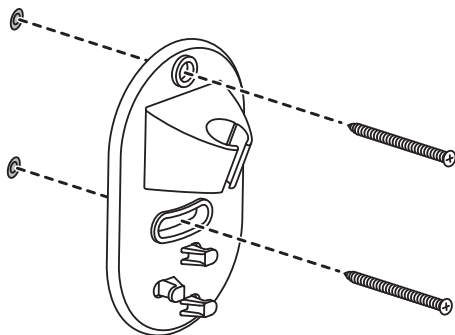

4

- Align the holes on the wall mount bracket with the wall anchors.
- Insert two screws into the holes in the wall mount bracket and tighten with a Phillips screwdriver. Do not over-tighten.

# Transmitter Wall Mount Installation

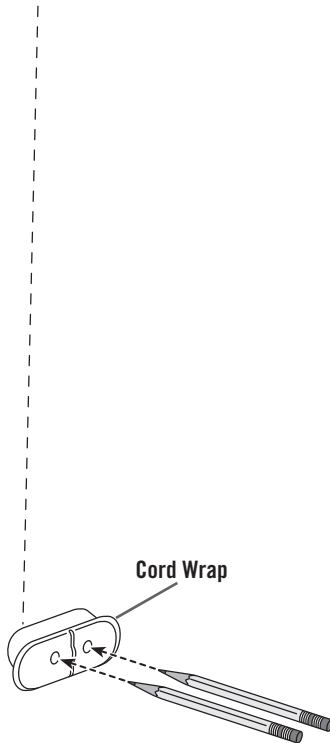
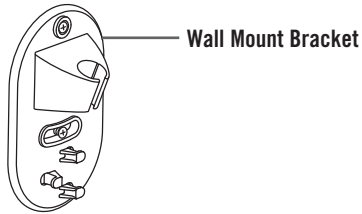

5

- Position the cord wrap against the wall, so that it is centered below the wall mount bracket and as close to the floor as possible.
- Move the cord wrap approximately  $\frac{1}{2}$ " towards the wall outlet.
- Using a pencil, make a mark on the wall inside both holes in the cord wrap.
- Set the cord wrap aside.

# Transmitter Wall Mount Installation

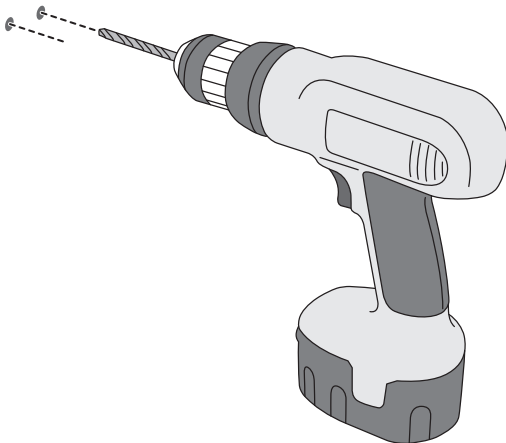

6

- Using a ¼" drill bit, drill one hole through each pencil mark you made on the wall.

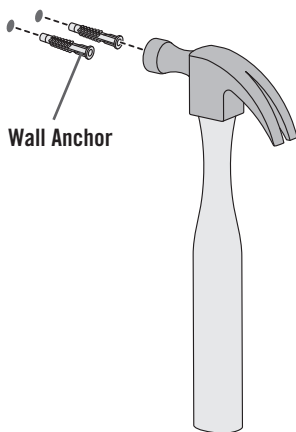

7

- Place a wall anchor into each of the drilled holes.
- Tap each wall anchor **lightly** with hammer until the ends of each wall anchor are even with the surface of the wall.

# Transmitter Wall Mount Installation

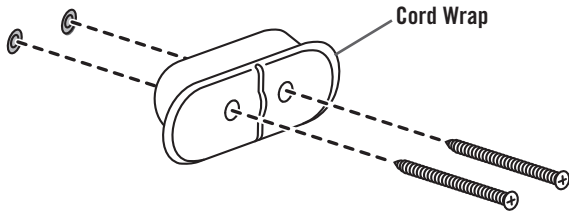

8

- Align the holes on the cord wrap with the wall anchors.
- Insert two screws into the holes in the cord wrap and tighten with a Phillips screwdriver. Do not over-tighten.

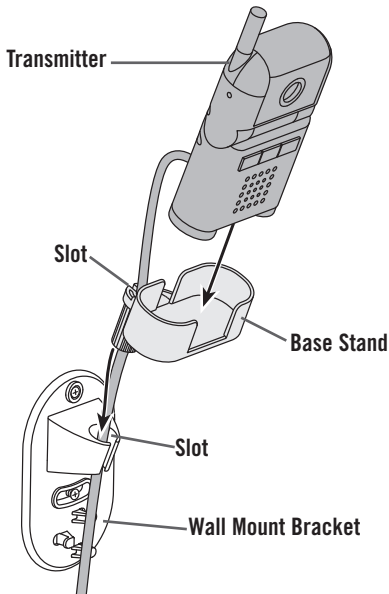

9

- Put the transmitter into the base stand.
- Fit the transmitter cord into the slot in the base stand and the wall mount bracket.
- Slide the stand into the slot on the wall mount bracket.



# Transmitter Wall Mount Installation

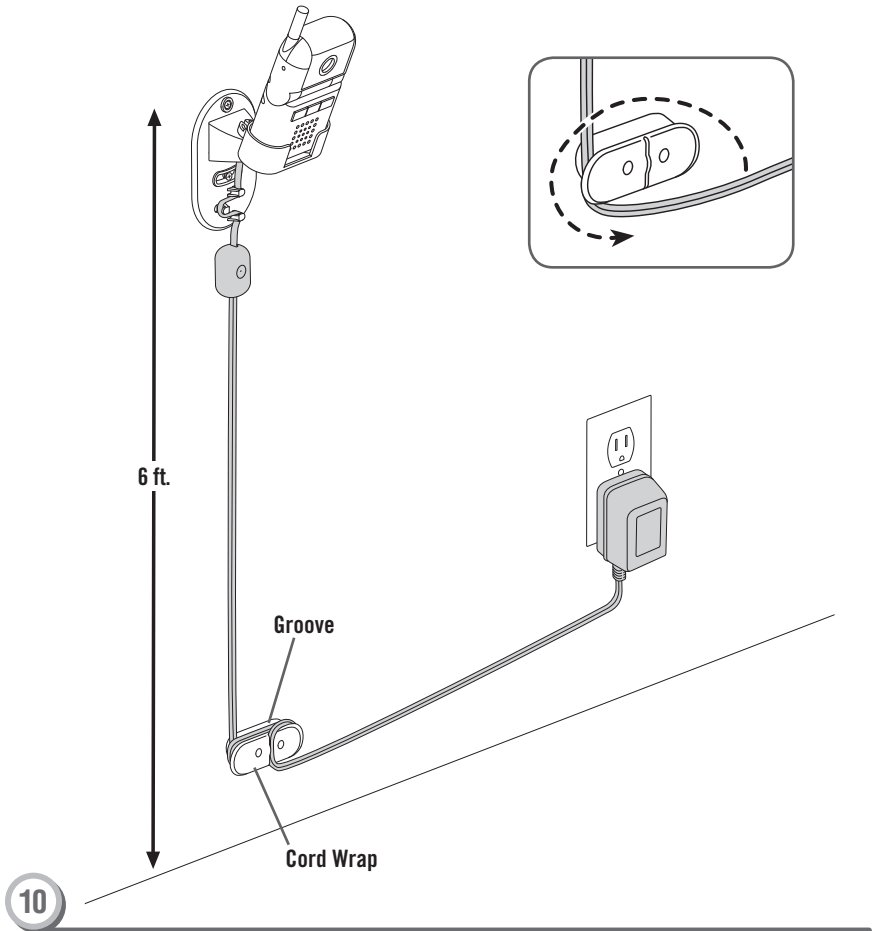

**IMPORTANT!** Make sure the cord is taut between the transmitter and cord wrap. Excess cord can form loops or extend into the crib and present a strangulation hazard.

- Extend the transmitter cord straight down the wall to the cord wrap.
- Wrap the transmitter cord around the cord wrap, leaving just enough to reach the wall outlet. Make sure there is **no slack in the transmitter cord**.
- Thread the transmitter cord through the groove in the front of the cord wrap. Make sure the transmitter cord is fully inserted in the groove.
- Plug the transmitter cord into the wall outlet.

# Setup/On Screen Displays

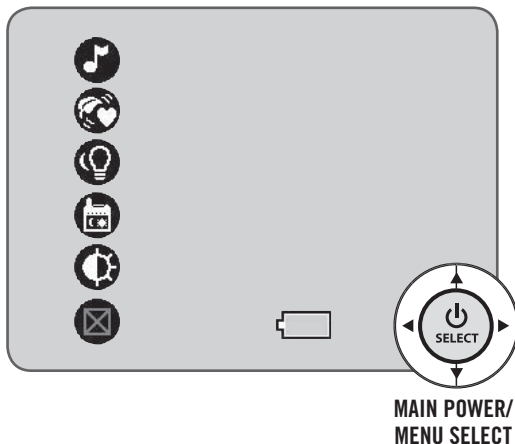

MAIN POWER/  
MENU SELECT

## Main Menu

- First, turn both transmitter and receiver power ON. Then press the main power/menu select button on the receiver to see the main menu.
- Press the up, down or side arrows to scroll through menu options. As you scroll, the menu choices highlight and blink on the screen.
- Press the main power/menu select button to choose:
  - Music
  - Sounds
  - Night Light
  - Voice Activated Screen
  - Contrast/Brightness
  - Turn Main Menu Off

**Hint:** The main menu turns off if you do not scroll through choices or make a selection within approximately 15 seconds. Simply press the main power/menu select button again to return to the main menu.

- You can turn on music or sounds and a night light for baby. You cannot turn on both music and sounds.

# Setup/On Screen Displays

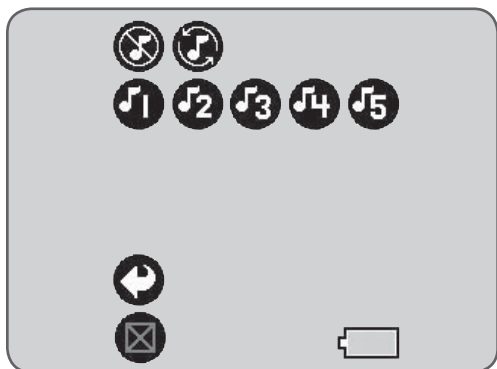

## Music

- Turn music off
- Turn music on and cycle through all five songs
- Select song number one
- Select song number two
- Select song number three
- Select song number four
- Select song number five
- Return to previous menu
- Exit menu

If you turn the music ON the music icons will appear on the bottom of the screen.

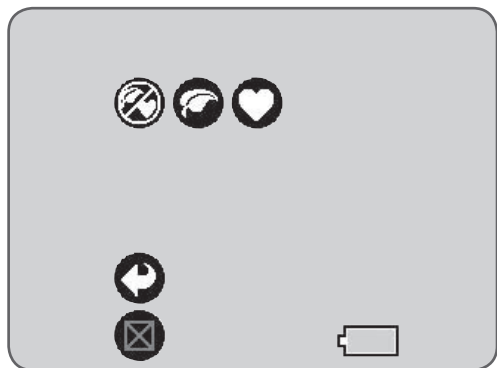

## Sounds



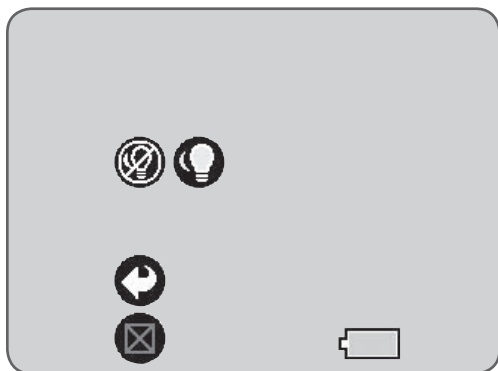

- Turn sounds off
- Select nature sounds
- Select heartbeat sounds
- Return to previous menu
- Exit menu

If you turn sounds ON one of the sound icons or will appear on the bottom of the screen.

# Setup/On Screen Displays







## Night Light

-  Turn night light off
-  Turn night light on
-  Return to previous menu
-  Exit menu

If you turn the night light on the night light  icon will appear on the bottom of the screen.





## Voice Activated (For Nighttime Use)

-  Video screen turns on for 30 seconds and then turns off. When baby makes noise, video screen automatically turns back on. It will remain on and turn off after 30 seconds from the last sound detected. You can also press any button on the receiver to turn video back on.
-  Video screen does not turn on when baby makes noise. Press the video screen on/off button on the top of the receiver to turn the video screen on and off.
-  Return to previous menu
-  Exit menu

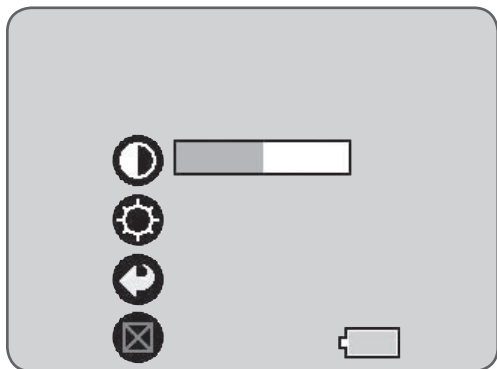

# Setup/On Screen Displays

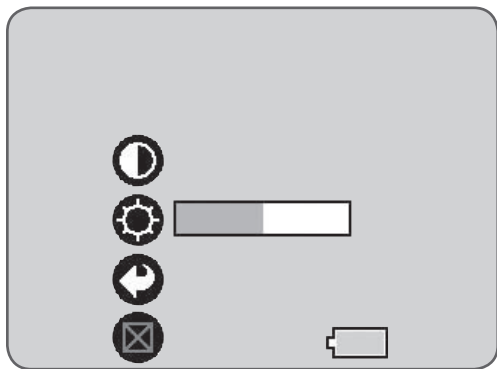

## Contrast/Brightness

-  Press left or right side arrows to adjust contrast on the screen.
-  Return to previous menu
-  Exit menu



-  Press left or right side arrows to adjust brightness on the screen.
-  Return to previous menu
-  Exit menu

# Setup/On Screen Displays



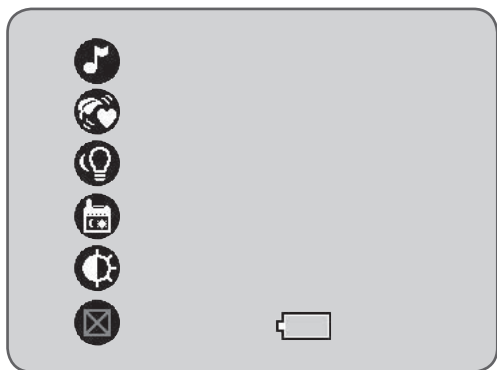

## Out of Range

The out of range warning will flash on the screen and you will hear a tone when the receiver is out of range or the transmitter is turned off.





## Battery Indicators

-  Indicates receiver is using battery power (only on the menu screen).
-  Indicates battery power is low (and you will hear a tone). Plug in the AC adaptor/charger to use AC power and charge the battery.
-  Indicates receiver is charging.

# Use



**IMPORTANT!** Test the sound and video reception of the monitor before first time use and whenever you change the location of the transmitter (see Testing Sound/Video Reception section of these instructions).



- Place the transmitter in the same room with child. Fit the transmitter into the tabletop base. Position the camera lens so it is facing child. For the best viewing range, the transmitter should be approximately five feet away from baby.
  - Unwrap and fully extend the power cord for best transmission. Plug the power cord into a standard wall outlet. Use the power cord only in a wall outlet. Do not plug the power cord into a ceiling outlet.
- Note:** The microphone is located on the power cord. Do not place the transmitter microphone within reach of your child or in front of the transmitter. For best results, allow the cord to extend behind the transmitter.
- Turn the power/volume dial to turn the power ON. The power L.E.D. will light.
  - Press the music  button to play lullaby songs. (Press again to turn off the music.)
  - Press the sound  button to play nature sounds. (Press again to turn off the sounds.)
  - Press the night light button  for a soft, glowing light. (Press again to turn off the night light).

# Use



- To use AC current, unwrap and fully extend the AC adaptor cord (for best reception). Insert the AC adaptor pin into the DC input jack on the receiver and plug into a standard wall outlet.
- Press the main power/menu button on the receiver to turn the power on.
- Press the side menu navigation buttons to turn the receiver volume up  or down .
- To monitor baby without video, press the video on/off button at the top of the receiver. To turn video back on, simply press the button again.
- The receiver can be used to stay in touch with baby around your house or yard. The receiver's range is up to 400 feet (122 meters) away from the transmitter. The out of range warning will flash on the screen and you will hear a tone when the receiver is out of range.
- To turn off the receiver, press and hold the main power/menu button for approximately five seconds.



## Night Vision Mode



When the light in baby's room is too low, the transmitter will automatically switch to night vision mode. The image on the receiver screen will appear in black and white, not color.

# Battery Replacement

If you need to replace your NiMH rechargeable battery pack, please contact Fisher-Price® Consumer Relations at [www.service.fisher-price.com](http://www.service.fisher-price.com) or call 1-800-432-5437.





- Locate the battery compartment door on the back of the receiver.
  - Loosen the screws in the battery compartment door with a Phillips screwdriver. Remove the battery compartment door.
  - Remove the exhausted battery pack and dispose of it properly.
  - Plug the new rechargeable battery pack into the receiver's battery connector. Then, insert the battery pack in the battery compartment.
  - Replace the battery compartment door and tighten the screws with a Phillips screwdriver. Do not over-tighten.
-  • Protect the environment by not disposing of this product with household waste (2002/96/EC). Check your local authority for recycling advice and facilities (Europe only).

## Battery Safety Information

In exceptional circumstances, batteries may leak fluids that can cause a chemical burn injury or ruin your product. To avoid battery leakage:

- If replacing the battery pack, insert it as indicated inside the battery compartment.
- Always remove an exhausted battery pack from the product. Dispose of the battery pack safely. Do not dispose of product in a fire. The battery pack inside may explode or leak. Contact Fisher-Price® Consumer Relations at [service.fisher-price.com](http://service.fisher-price.com) or call 1-800-432-5437 to purchase a battery pack.
- Never short-circuit the battery pack terminals.
- Use only batteries of the same type, as recommended.

# Problems & Solutions

Problem	Solution
No image on receiver screen	Press the video screen on/off button. You can also change the voice activated setting to  . The video screen automatically turns on when baby makes noise.
	Batteries in receiver are weak or dead. Use AC adaptor as power source and to charge the battery.
	Transmitter camera lens is obstructed. Adjust the camera angle on the transmitter.
Receiver beeps and out of range screen displays 	Receiver is out of range of transmitter. Move receiver closer to transmitter. <b>Note:</b> Range varies depending on surrounding conditions such as noise levels, physical obstructions and signal interference. Under optimal conditions, the range is up to 400 feet.
	Transmitter power is off. Turn transmitter power on.
	Loose power cord connection and transmitter power is off. Check transmitter power cord plug-to-outlet connection.
	No power to wall outlet and transmitter power is off. Make sure light switch that controls power flow to wall outlet is on.
	Power is off because circuit breaker for room is off. Make sure house fuses and circuit breakers are on.
Receiver power L.E.D. does not light	Receiver power is off. Turn receiver power on.
	Battery pack in receiver is weak or dead. Use AC adaptor as power source and to charge the battery for four hours.
	Power is off because circuit breaker for room is off. Make sure house fuses and circuit breakers are on.
	No power to wall outlet and power is off. Make sure light switch that controls power flow to wall outlet is on.

# Problems & Solutions

Problem	Solution
Receiver beeps and displays low battery icon  on screen	Battery pack in receiver is weak or dead. Use AC adaptor as power source and to charge the battery for four hours.
Transmitter power L.E.D. does not light	Transmitter power is off. Turn transmitter power on.
	Loose power cord connection and transmitter power is off. Check transmitter power cord plug-to-outlet connection.
	No power to wall outlet and transmitter power is off. Make sure light switch that controls power flow to wall outlet is on.
You can hear conversations or sounds from other homes	There is signal interference due to other nursery monitors on same channel or cordless telephone use. You may need to pair the receiver and transmitter. Remove the receiver battery door and press the pairing button with a paperclip. The power LED will blink when the pairing button is released. Then, turn over the transmitter and press the pairing button with a paperclip. The signal L.E.D. on the receiver will flash and you will hear a confirmation tone.

**Hint:** If, after checking all of these solutions, you believe that your transmitter power cord or AC adaptor are damaged, please contact Fisher-Price®.

# FCC Statement (United States Only)

This equipment has been tested and found to comply with the limits for a Class B digital device, pursuant to part 15 of the FCC rules. These limits are designed to provide reasonable protection against harmful interference in a residential installation. This equipment generates, uses and can radiate radio frequency energy and, if not installed and used in accordance with the instructions, may cause harmful interference to radio communications. However, there is no guarantee that interference will not occur in a particular installation. If this equipment does cause harmful interference to radio or television reception, which can be determined by turning the equipment off and on, the user is encouraged to try to correct the interference by one or more of the following measures:

Reorient or relocate the receiving antenna.

Increase the separation between the equipment and receiver.

Connect the equipment into an outlet on a circuit different from that to which the receiver is connected.

Consult the dealer or an experienced radio/TV technician for help.

Note: Changes or modifications not expressly approved by the manufacturer responsible for compliance could void the user's authority to operate the equipment.

Video Monitor

Model Number: N9326

This device complies with Part 15 of the FCC Rules. Operation is subject to the following two conditions:

(1) This device may not cause harmful interference and (2) this device must accept any interference received, including interference that may cause undesired operation.

Video Monitor

Consumer Relations Department

636 Girard Avenue

East Aurora, New York 14052, U.S.A

To maintain compliance with the FCC's RF exposure guidelines, place the transmitter at least 20 cm from users. Make sure the transmitter is not located near or operated along with any other antenna or transmitter.

# RSS-210 ICES-003 CNR-210 NMB-003

## **RSS-210**

This device complies with RSS-210 of Industry Canada. Operation is subject to the following two conditions: (1) this device may not cause harmful interference and (2) this device must accept any interference received, including interference that may cause undesired operation.

## **ICES-003**

This Class B digital apparatus complies with Canadian ICES-003. Operation is subject to the following two conditions: (1) this device may not cause harmful interference and (2) this device must accept any interference received, including interference that may cause undesired operation.

## **CNR-210**

Ce dispositif est conforme au CNR-210 d'Industrie Canada. L'utilisation de ce dispositif est autorisée seulement aux conditions suivantes : (1) il ne doit pas produire de brouillage et (2) l'utilisateur du dispositif doit être prêt à accepter tout brouillage radioélectrique reçu, même si ce brouillage est susceptible de compromettre le fonctionnement du dispositif.

## **NMB-003**

Cet appareil numérique de la classe B est conforme à la norme NMB-003 du Canada. Cet appareil numérique de la classe B est conforme à la norme NMB-003 du Canada. L'utilisation de ce dispositif est autorisée seulement aux conditions suivantes : (1) il ne doit pas produire de brouillage et (2) l'utilisateur du dispositif doit être prêt à accepter tout brouillage radioélectrique reçu, même si ce brouillage est susceptible de compromettre le fonctionnement du dispositif.

# One (1) Year Limited Warranty (United States Only)

Fisher-Price, Inc., 636 Girard Avenue, East Aurora, New York 14052 warrants to the original owner that this product is free from all defects in material and workmanship when used under normal conditions for a period of one (1) year from the date of purchase.

Should the product fail to perform properly, we will repair or replace it at our option, free of charge. Purchaser is responsible for shipping the product to Consumer Relations at the address indicated above and for all associated freight and insurance cost. Fisher-Price, Inc. will bear the cost of shipping the repaired or replaced item to you. This warranty is void if the owner repairs or modifies the product. This warranty excludes any liability other than that expressly stated above including but not limited to any incidental or consequential damages.

SOME STATES DO NOT ALLOW THE EXCLUSION OR LIMITATION OF INCIDENTAL OR CONSEQUENTIAL DAMAGES, SO THE ABOVE LIMITATION OR EXCLUSION MAY NOT APPLY TO YOU.

THIS WARRANTY GIVES YOU SPECIFIC LEGAL RIGHTS, AND YOU MAY ALSO HAVE OTHER RIGHTS WHICH MAY VARY FROM STATE TO STATE.

## Care

- Excess dirt in transmitter microphone will hamper transmission of sound. Wipe all parts with a damp cloth. Do not immerse any part of this monitor.



**?** **CONSUMER ASSISTANCE**  
Call toll free: 1-800-432-5437 (US & Canada only)  
M-F 9AM to 7PM / SAT 11AM to 5PM (EST)

**service.fisher-price.com**

Write to us at: Fisher-Price® Consumer Relations,  
636 Girard Avenue, East Aurora, New York 14052.

Hearing-impaired consumers using TTY/TDD equipment,  
please call 1-800-382-7470.

---

*In Mexico: 59-05-51-00 Ext. 5206 ó 01-800-46359-89*  
*In Brasil: 0800 550780*

Fisher-Price, Inc., a subsidiary of Mattel, Inc., East Aurora, New York 14052, U.S.A.  
©2008 Mattel, Inc. All Rights Reserved.

® and ™ designate U.S. trademarks of Mattel, Inc