

# CHICAGO

## Electric Generators

### 5500 RATED WATTS/6500 MAX. WATTS

# PORTABLE GENERATOR

## Model 56088

### SET UP, OPERATING, AND SERVICING INSTRUCTIONS



### **⚠ DANGER**

Using a generator indoors **CAN KILL YOU IN MINUTES.**

Generator exhaust contains carbon monoxide. This is a poison you cannot see or smell.



**NEVER** use inside a home or garage, **EVEN IF** doors and windows are open.

Only use **OUTSIDE** and far away from windows, doors, and vents.

### **CAUTION!**

#### **Your Warranty Is Voided If:**

You do not put engine oil in the Engine's crankcase prior to its first use. Before each use, check the oil level. Never run the Engine with low or no engine oil. Running the Engine with low or no oil will permanently damage the unit.

Visit our website at: <http://www.harborfreight.com>



**Read this material before using this product.**  
**Failure to do so can result in serious injury.**  
**SAVE THIS MANUAL.**

Copyright© 2009 by Harbor Freight Tools®. All rights reserved. No portion of this manual or any artwork contained herein may be reproduced in any shape or form without the express written consent of Harbor Freight Tools. Diagrams within this manual may not be drawn proportionally. Due to continuing improvements, actual product may differ slightly from the product described herein. Tools required for assembly and service may not be included.

**For technical questions or replacement parts, please call 1-800-444-3353.**



3. **Keep bystanders, children, and visitors away while operating a power tool.** Distractions can cause you to lose control. Provide barriers or shields as needed.

## **PERSONAL SAFETY**

1. **Stay alert. Watch what you are doing, and use common sense when operating a power tool. Do not use a power tool while tired or under the influence of drugs, alcohol, or medication.** A moment of inattention while operating power tools may result in serious personal injury.
2. **Dress properly. Do not wear loose clothing or jewelry. Contain long hair. Keep your hair, clothing, and gloves away from moving parts.** Loose clothes, jewelry, or long hair can be caught in moving parts.
3. **Avoid accidental starting. Be sure the Engine Ignition (2) is in its “OFF” position before moving the Generator *and* before performing any service, maintenance, or cleaning procedures on the unit.**
4. **Remove adjusting keys or wrenches before turning the Generator on.** A wrench or a key that is left attached to a rotating part of the machine may result in personal injury.
5. **Do not overreach. Keep proper footing and balance at all times.** Proper footing and balance enables better control of the power tool in unexpected situations.
6.  **Use safety equipment. Always wear eye protection.** Always wear ANSI approved safety impact goggles when using this product. ANSI approved hearing protection must also be used.

## **TOOL USE AND CARE**

1. **Do not force the tool. Use the correct tool for your application.** The correct tool will do the job better and safer at the rate for which it is designed.
2. **Do not use the Generator if the Engine’s Ignition (2) does not turn it on or off.** Any tool that cannot be controlled with its power switch is dangerous and must be replaced.
3. **Store idle tools out of reach of children and other untrained persons.** Tools are dangerous in the hands of untrained users.
4. **Maintain tools with care.** Properly maintained tools are less likely to malfunction and are easier to control. Do not use a damaged tool. Tag damaged tools “**Do not use**” until repaired.
5. **Check for misalignment or binding of moving parts, breakage of parts, and any other condition that may affect the tool’s operation. If damaged, have the tool serviced before using.** Many accidents are caused by poorly maintained tools.

6. **Use only accessories that are recommended by the manufacturer for your model.** Accessories that may be suitable for one tool may become hazardous when used on another tool.

7. **CAUTION: This generator is not intended to power sensitive electronic equipment\* without the addition of an appropriate line conditioner and surge protector (both not included).** Sensitive electronic equipment should be operated on approved inverter type generators or pure sine wave generators.

If the plugged in product operates abnormally or unusually slow, immediately stop using the generator as a power source. Always read and adhere to the instruction manual of the product to be powered, to make sure that it can be safely and efficiently powered by a portable generator.

**Note:** When using a generator to provide home standby electricity, a transfer switch (sold separately) is needed to prevent back feeding power into the utility line.

Connections for standby power to a building electrical system must be made by a qualified electrician. The connection must isolate the generator power from utility power, and must comply with all applicable laws and electrical codes.

**WARNING:** Improper connections to a building electrical system can allow electrical current from the generator to backfeed into the utility lines. Such backfeed may electrocute utility company workers or others who contact the lines during a power outage, and the generator may explode, burn, or cause fires when utility power is restored. Consult the utility company or a qualified electrician.

**\*Sensitive electronic equipment includes, but is not limited to, audio/video equipment, some television sets, computers, and printers.**

## **AC APPLICATIONS**

1. Before connecting an appliance or power cord to the generator: Make sure that it is in good working order. Faulty appliances or power cords can create a potential for electrical shock.
2. If an appliance begins to operate abnormally, becomes sluggish or stops suddenly, turn it off immediately. Disconnect the appliance, and determine whether the problem is the appliance, or if the rated load capacity of the generator has been exceeded.
3. Make sure that the electrical rating of the tool or appliance does not exceed that of the generator. Never exceed the maximum power rating of the generator. Power levels between rated and maximum may be used for no more than 30 minutes.
4. Substantial overloading will open the circuit breaker. Exceeding the time limit for maximum power operation or slightly overloading the generator may not switch the circuit breaker or circuit protector OFF, but will shorten the service life of the generator.

## SERVICE

1. **Tool service must be performed only by qualified repair personnel.** Service or maintenance performed by unqualified personnel could result in a risk of injury.
2. **When servicing a tool, use only identical replacement parts. Follow instructions in the “*Inspection, Maintenance, And Cleaning*” section of this manual.** Use of unauthorized parts or failure to follow maintenance instructions may create a risk of electric shock or injury.

---

## **SPECIFIC SAFETY RULES AND PRECAUTIONS**

---

1. **Your Warranty is voided if you do not put engine oil in the Engine’s crankcase prior to its first use.** Before each use, check the oil level. Never run the Engine with low or no engine oil. Running the Engine with low or no oil will permanently damage the unit.
2. **Maintain labels and nameplates on the Generator.** These carry important information. If unreadable or missing, contact Harbor Freight Tools for a replacement.
3. **Make sure the Generator is located on a flat, level, sturdy surface capable of supporting the weight of the Generator and any additional tools and equipment.**
4. **Industrial applications must follow OSHA guidelines.**
5. **Never stand on the Generator.** Serious injury could result if the Generator is tipped.
6. **Never leave the Generator unattended when it is running.** Turn off the Engine before leaving.
7. **Do not allow children and other unauthorized people to handle or play with the Generator.**
8.  **This Generator is designed for outdoor use only.** Do not operate the Generator in a closed area or in a poorly ventilated area. **When running, the Engine of this Generator produces carbon monoxide, a colorless, odorless, toxic fume that, when inhaled, can cause serious personal injury or death. Whenever possible, use a carbon monoxide detector (not included) to detect excessive carbon monoxide fumes in the work area and in the surrounding area.**
9. **Do not force the Generator.** This tool will do the work better and safer at the speed and capacity for which it was designed. Do not overload the generator. Know the total running wattage necessary to power the desired items.

## **FIRE AND EXPLOSION PRECAUTIONS**

1. **Gasoline fuel and fumes are flammable, and potentially explosive.** Use proper fuel storage and handling procedures. Always have multiple ABC class fire extinguishers nearby.
2. **Keep the Generator, its Engine, and surrounding areas clean at all times.**
3. **When spills of fuel or oil occur, they must be cleaned up immediately.** Dispose of fluids and cleaning materials as per any local, state, or federal codes and regulations. Store oil rags in a covered metal container.
4. **Never store fuel or other flammable materials near the Generator.**
5. **Do not smoke, or allow sparks, flames, or other sources of ignition around the Generator.**
6. **Keep grounded conductive objects, such as tools, away from exposed, live electrical parts and connections to avoid sparking or arcing.** These events could ignite fumes or vapors.
7. **Do not refill the Fuel Tank while the Engine is running or while the Engine is still hot.** Do not operate the Generator with known leaks in the fuel system.
8. **Use only Engine manufacturer recommended fuel and oil.**
9. **Operation of this equipment may create sparks that can start fires around dry vegetation.** A spark arrestor may be required. The operator should contact local fire agencies for laws or regulations relating to fire prevention requirements.

## **MECHANICAL PRECAUTIONS**

1. **Prior to performing service, maintenance, or cleaning procedures, always make sure the Engine's Ignition (2) is in its "OFF" position. Allow the Engine and Generator to completely cool. Then, remove the spark plug from the Engine.**
2. **Do not alter or adjust any part of the Generator or Engine that is assembled and supplied by the manufacturer.**
3. **Always follow and complete scheduled Generator and Engine maintenance.**

## **CHEMICAL PRECAUTIONS**

1. **Avoid contact with hot fuel, oil, exhaust fumes, and solid surfaces.**
2. **Avoid body contact with fuels, oils, and lubricants used in the Generator and Engine.** If swallowed, seek medical treatment immediately. Do not induce vomiting if fuel is swallowed. For skin contact, immediately wash with soap and water. For eye contact, immediately flush eyes with clean water.

## **NOISE PRECAUTION**

**Prolonged exposure to high noise levels is hazardous to hearing.** Wear hearing protection when operating or working around the Generator when it is running.

## **ELECTRICAL PRECAUTIONS**

1. **All connections and conduits from the Generator to the load must only be installed by trained and licensed electricians, and in compliance with all relevant local, state, and federal electrical codes and standards, and other regulations where applicable.**
2. **The Generator must be earth-grounded in accordance with all relevant electrical codes and standards before operation.**
3. **If an extension cord (not included) is used, make sure to use only UL listed cords having the correct gauge and length. (See TABLE A, next page.)**
4. **Do not attempt to connect or disconnect load connections while standing in water, or on wet or soggy ground.**
5. **Do not touch electrically energized parts of the Generator and interconnecting cables or conductors with any part of the body, or with any non-insulated conductive object.**
6. **Connect the Generator only to a load or electrical system (120 volt, 240 volt, or 12 volt) that is compatible with the electrical characteristics and rated capacities of the Generator.**
7. **Be sure the Engine's Ignition (2) is in its "OFF" position before moving the Generator *and* before performing any service, maintenance, or cleaning procedures on the unit.**
8. **Keep all electrical equipment clean and dry.** Replace any wiring where the insulation is cracked, cut, abraded, or otherwise degraded. Replace terminals that are worn, discolored, or corroded. Keep terminals clean and tight.
9. **Insulate all connections and disconnected wires.**
10. **Guard against electric shock.** Prevent body contact with grounded surfaces such as pipes, radiators, ranges, and refrigerator enclosures.
11. **Use only Class BC or Class ABC fire extinguishers on electrical fires.**
12. **Unconditioned electrical output can damage sensitive equipment.** Do not use to power sensitive electronic equipment without appropriate line conditioner (sold separately).

<b>RECOMMENDED MINIMUM WIRE GAUGE FOR EXTENSION CORDS*</b> (120 OR 240 VOLT)					
<b>NAMEPLATE AMPERES (at full load)</b>	<b>EXTENSION CORD LENGTH</b>				
	<b>25 Feet</b>	<b>50 Feet</b>	<b>75 Feet</b>	<b>100 Feet</b>	<b>150 Feet</b>
0 – 2.0	18	18	18	18	16
2.1 – 3.4	18	18	18	16	14
3.5 – 5.0	18	18	16	14	12
5.1 – 7.0	18	16	14	12	12
7.1 – 12.0	18	14	12	10	-
12.1 – 16.0	14	12	10	-	-
16.1 – 20.0	12	10	-	-	-

**TABLE A** \* Based on limiting the line voltage drop to five volts at 150% of the rated amperes.

### **MISC. PRECAUTIONS**

1. **WARNING!** People with pacemakers should consult their physician(s) before using this product. Operation of electrical equipment in close proximity to a heart pacemaker could cause interference to or failure of the pacemaker.
2. **WARNING!** The warnings and precautions discussed in this manual cannot cover all possible conditions and situations that may occur. It must be understood by the operator that common sense and caution are factors which cannot be built into this product, but must be supplied by the operator.



---

## UNPACKING

---

When unpacking, check to make sure all the parts shown on the **Parts Lists on pages 20 and 22** are included. If any parts are missing or broken, please call Harbor Freight Tools at the number shown on the cover of this manual as soon as possible.

---

## ASSEMBLY INSTRUCTIONS

---

**CAUTION!** Make sure Engine's Ignition (2) is in its "OFF" position prior to performing any service, maintenance, or cleaning of Generator or Engine. Always wear ANSI- approved **safety impact eye goggles** when assembling and using the Generator.

**To Install The Battery (not included):**

**NOTE: For proper operation, you must install a DC 12V, 18-35 Amp-hour Battery.**

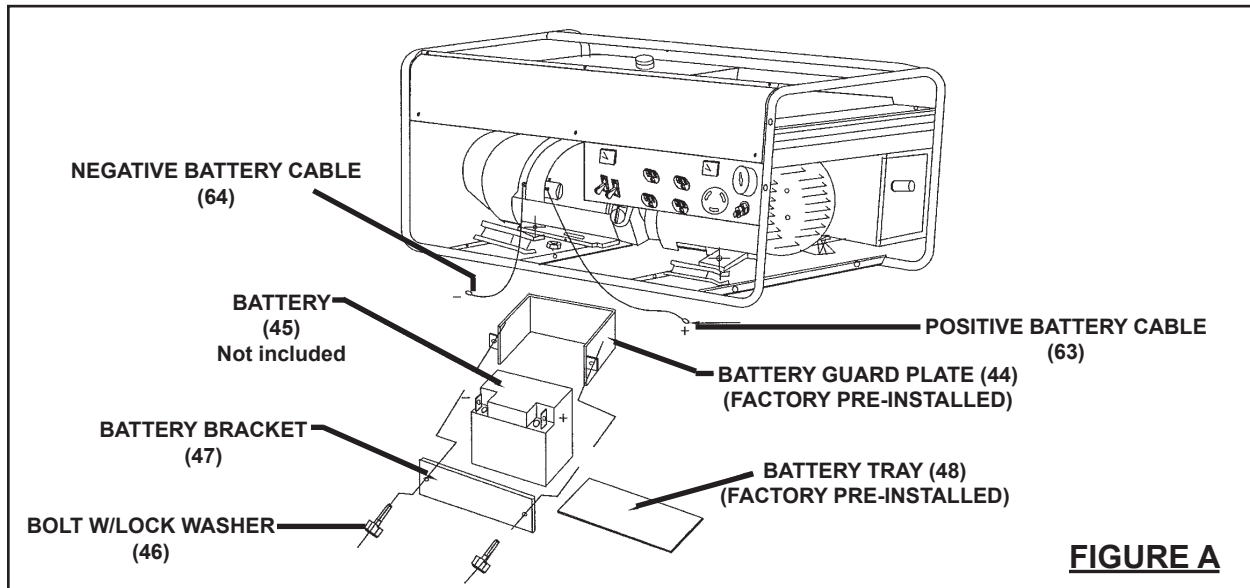

**FIGURE A**

1. Remove the packing from the Battery (45). Then, locate the factory pre-installed Battery Guard Plate (44) and Battery Tray (48) beneath the Control Panel (4) of the Generator unit. **(See Figure A, previous page.)**
2. Slide the Battery (45) into the Battery Guard Plate (44), with the Battery's terminals facing outward *and* with the Battery's negative (-) terminal facing left. **(See Figure A.)**
3. Align the two mounting holes in the Battery Bracket (46) with the two threaded mounting holes in the Battery Guard Plate (44). Then secure the Battery Bracket to the Battery Guard Plate, using two Bolts with Lock Washers (46). **(See Figure A.)**

4. Connect the end of the Positive Battery Cable (63) to the Battery's positive (+) terminal. Then connect the Negative Battery Cable (64) to the Battery's negative (-) terminal. **(See Figure A.)**

---

## **INSTALLATION INSTRUCTIONS**

---

1. Electrical and other permits may be required for the installation of emergency or portable power systems. Investigate the local building and electrical codes before installing this unit.
2. Prior to providing Generator power to tools and equipment, make sure the Generator's rated voltage, wattage, and amperage capacity is adequate to supply all electrical loads the unit will power. If powering exceeds the Generator's capacity, it may be necessary to group one or more of the tools/equipment for connection to a separate Generator.

### **General Location:**

1. It is recommended to locate the Generator (outdoors only) where cooling air is readily available. Locate the Generator so that the air inlets and outlets are not blocked by obstructions such as bushes, trees, or snow drifts. Locating it in the path of heavy winds or snowdrifts may require the placement of a barrier for protection. The air inlet (on Air Filter Cover 18a), in normal weather conditions, should face the prevailing wind direction.
2. Locate the Generator on a concrete slab or other area where rain drainage or flood waters can not reach it.
3. Generator placement should allow four feet of access to all sides for maintenance and for proper air cooling.
4. Place the Generator as close as possible to the electrical tools and equipment being powered to reduce the length of extension cords.

## Grounding The Generator:

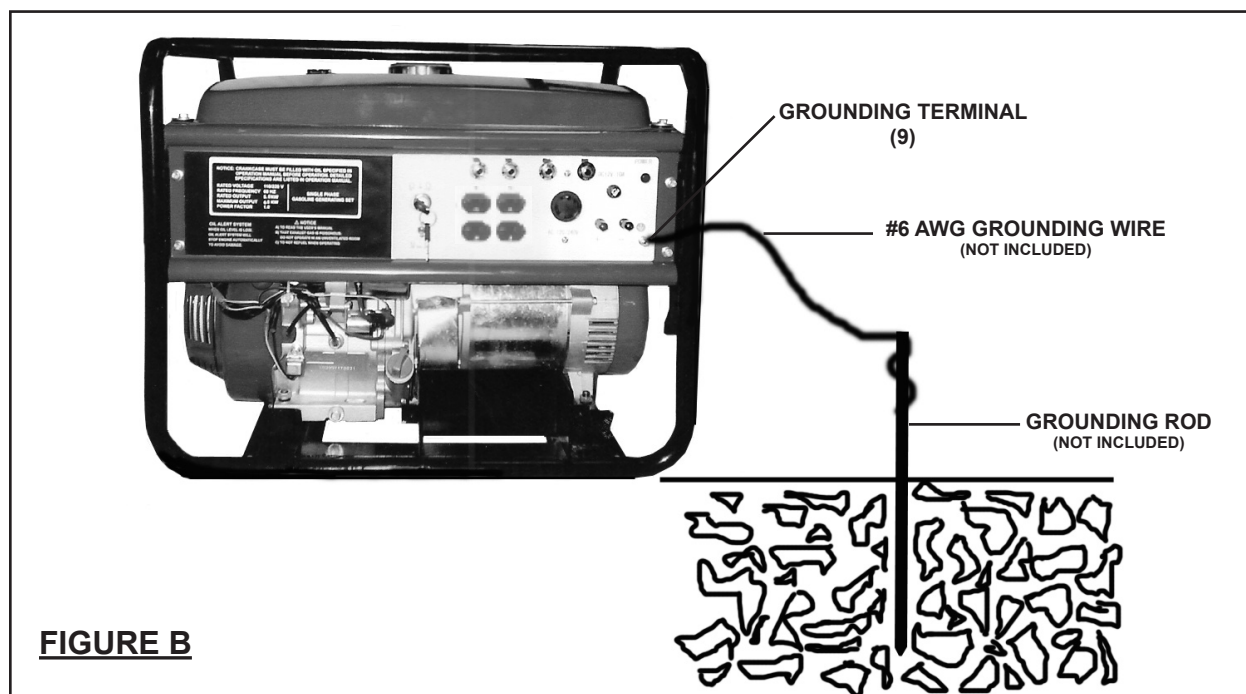

**Note:** It is recommended that only a trained and licensed electrician perform this procedure.

Connect a #6 AWG grounding wire (not included) from the Grounding Terminal (9) on the Generator to a grounding rod (not included) that has been driven at least **24 inches** deep into the earth. The grounding rod must be an earth-driven copper or brass rod (electrode) which can adequately ground the Generator.

(See Figure B.)

---

## CONTROL PANEL FEATURES

---

1. **Engine Ignition (2):** Starts and stops the Gasoline Engine. To start the Engine using power from the Battery (45), insert the Ignition Key (65) and turn the Engine Ignition to its **“START”** position. To start the Engine *manually* using the Starter Rope (40A) and Starter Handle (41A), insert the Ignition Key and turn the Engine Ignition to its **“RUN”** position. Then pull briskly on the Starter Handle. To stop the Engine, turn the Engine Ignition to its **“OFF”** position. **Always remove the Ignition Key when the Generator is not in use.** (See Figure C, next page.)
2. **Fuel Tank Cap (34):** **NEVER** run the Engine with the Fuel Tank Cap removed. (See Figure C.)
3. **120 Volt NEMA AC Outlets (5):** The Generator is equipped with four 3-hole 120 volt AC outlets to power 120 volt tools and equipment. (See Figure C.)

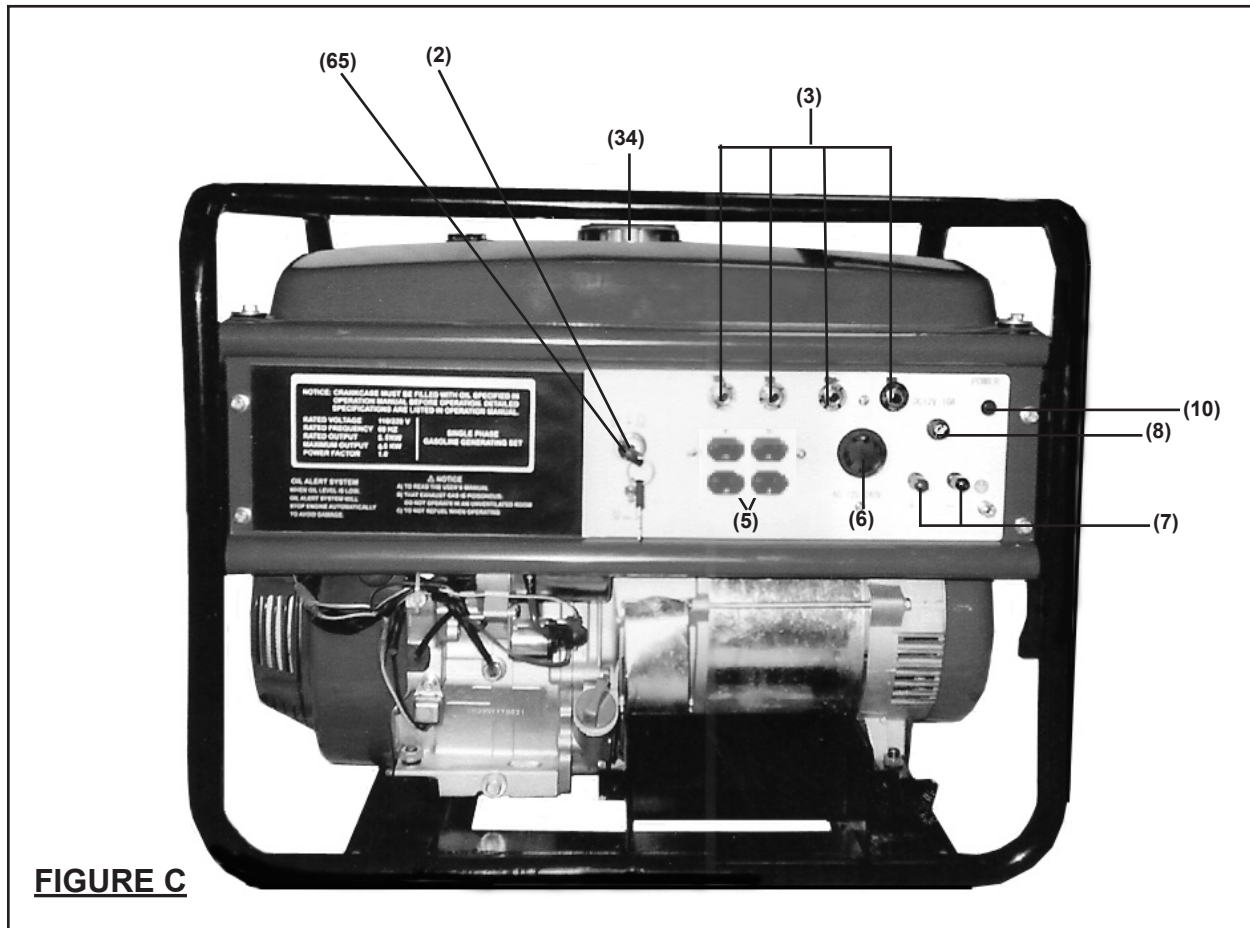

- FIGURE C**
4. **120 Volt AC Circuit Breakers (3):** Each of the four 120 Volt AC Outlets have a Circuit Breaker to protect the Generator from overloading. Should a Circuit Breaker “trip”, unplug all electrical loads from the Generator. Allow the Circuit Breaker to cool down. Then, push the 120 volt Circuit Breakers. **(See Figure C.)**
  5. **240 Volt AC Outlet (6):** The Generator is equipped with *one* 4-blade twist lock 240 Volt AC Outlet to power 240 volt tools and equipment. **(See Figure C.)**
  6. **240 Volt AC Circuit Breaker (3):** The 240 Volt AC Outlet has *two* Circuit Breakers to protect the Generator from overloading. Should the Circuit Breakers “trip”, unplug all electrical loads from the Generator. Allow the Circuit Breakers to cool down. Then, push the 240 volt Circuit Breakers. **(See Figure C.)**
  7. **12 VDC Terminal (7):** Supplies voltage to 12 volt DC appliances such as radios, emergency lights, etc. To power a 12 volt DC appliance, connect the positive (+) lead from the appliance to the positive (**Red +**) 12 VDC Terminal on the Generator. Then connect the negative (–) lead from the appliance to the negative (**Black –**) 12 VDC Terminal on the Generator. **IMPORTANT:** This Outlet is designed for operating 12 volt DC appliances only. Do not attempt to charge batteries with this Outlet. **(See Figure C.)**

8. **12 Volt DC Fuse (8):** The 12 Volt DC Outlet has *one* Fuse (8) to protect the Generator from overloading. The Generator is equipped with the following size and type of Fuse: **F10A250V**. Should a 12 VDC output exceed the fuse's rating, always check to see if the Fuse has "blown" (a melted filament within the Fuse). If necessary, unplug all electrical loads from the Generator, replace with a new Fuse, and reattach a reduced load to the generator. (See Figure C.)
9. **Power-On Light (10):** Indicates voltage is being provided by the Generator. (See Figure C.)

---

## PRE-START INSTRUCTIONS

---

### To Add Engine Oil:

1. **CAUTION!** Your warranty is voided if you do not put engine oil in the Engine's crankcase prior to its first use. Before each use, check the oil level. Never run the Engine with low or no engine oil. Running the engine with low or no oil will permanently damage the Engine.

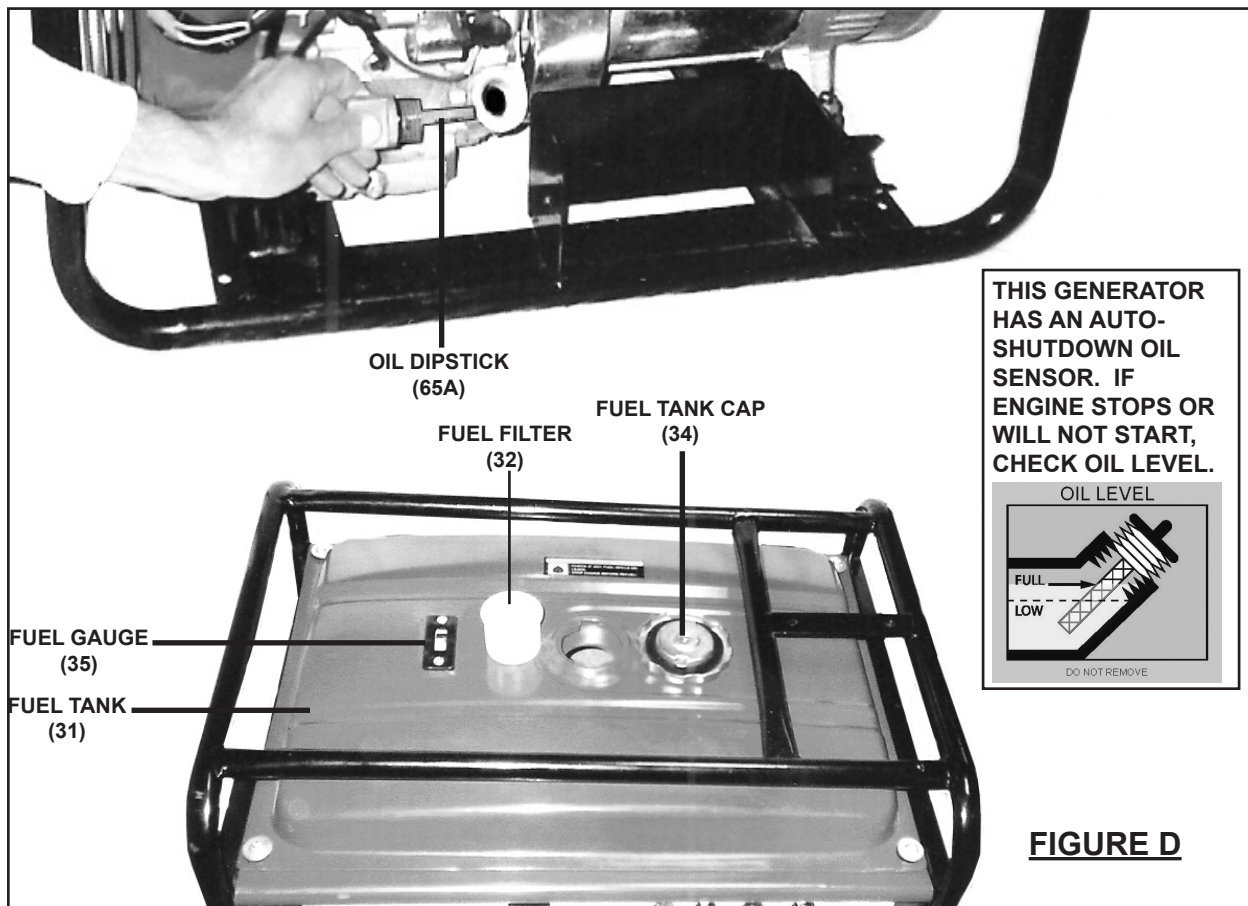

2. The Engine **MUST** be filled with a high quality grade engine oil. If the Engine will be run in temperatures *above* 32 degrees Fahrenheit, use **SAE 10W-30** weight oil.

If the Engine will be run in temperatures *below* 32 degrees Fahrenheit, use **SAE 5W-30** weight oil. **(See Figure D, prior page.)**

3. To do so, *unscrew* and remove the Oil Dipstick (65A). Pour engine oil into the oil fill hole until the level of oil is even with the bottom edge of the oil fill hole (if you cannot see the oil through the oil fill hole, then the oil is too low and more oil must be added). **(See Figure D.)**
4. Make sure to screw the Oil Dipstick (65A) firmly back into its Dipstick Hole. **(See Figure D.)**

**To Fill The Fuel Tank:**

1. Prior to first using the Generator, the Fuel Tank (31) must be filled with high octane **unleaded** gasoline. **(See Figure D.)**
2. To do so, remove the Fuel Tank Cap (34) and fill the Fuel Tank (31) with unleaded gasoline. Then, replace the Fuel Tank Cap. Thereafter, check the Fuel Gauge (35) for the amount of unleaded gasoline. When necessary, refill the Fuel Tank. **(See Figure D.)**

**NOTE:** Periodically, make sure to check the Fuel Filter (32) for excessive dirt and debris. If necessary, remove the Fuel Filter and clean with compressed air. **(See Figure D.)**

---

**THIS UNIT CAN POWER THE FOLLOWING ITEMS**

---

ITEM	RUNNING WATTS	START-UP WATTS
1 HP Air Compressor	1600	4500
Belt Sander	1200	2400
Pressure Washer	1200	3600
Refrigerator/Freezer	700	2200
1/2 HP Sump Pump	1050	2150
1/2 HP Well Pump	1000	2100
Miter Saw	1650	3000
1-1/2 HP Capacitor Start & Run Motor	1400	3100
Central AC-32, 000 BTU	5000	6500
10" Table Saw	1800	4500

**NOTE:** Wattages listed above are estimates. Check nameplate wattages on all loads before connecting to Generator.

---

## OPERATING INSTRUCTIONS

---

1. Check to make sure the Engine Ignition (2) is in its “**OFF**” position. (See Figure C.)
2. **CAUTION!** Make sure to unplug any load from the Generator before starting to prevent permanent damage to any appliances, tools, or equipment.
3. **CAUTION! Engine oil MUST be added to the Engine’s crankcase prior to starting and running the Engine.** Failure to add oil will damage the Engine and void its warranty. (See pages 13 and 14, and Figure D.)
4. Before the first use, the Fuel Tank (31) must be filled with a high octane, unleaded gasoline. (See pages 13 and 14, and Figure D.)
  - a. **WARNING!** Never fill the Fuel Tank (31) completely. Fill the Fuel Tank to 1/2” below the bottom of the filler neck to provide space for fuel expansion. Wipe any fuel spills from the Engine and Generator before starting the Engine.
  - b. **WARNING!** Never fill the Fuel Tank (31) when the Engine is running or hot. Do not smoke when filling the Fuel Tank.

### To Start The Engine/Generator:

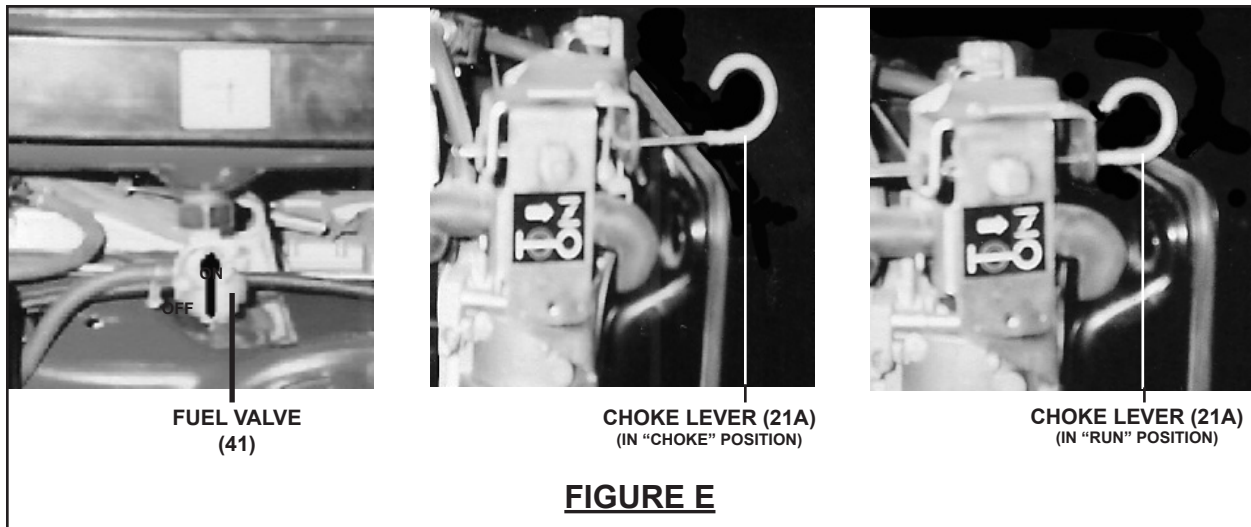

1. Turn the Engine Fuel Valve (41) to its “**OPEN**” position. Then, turn the Engine Choke Lever (21A) to its “**CHOKE**” position. **NOTE:** No choke is required if the Engine is warm. Make sure the Engine Choke Lever is in the “**RUN**” position when starting a warm Engine. (See Figure E.)
2. To start the Engine, using the Battery (45) for cranking power, insert the Ignition Key (65) and turn the Engine Ignition (2) to its “**START**” position. **NOTE:** To prolong starter life, use short starting cycles (5 seconds maximum, then wait one minute before attempting to again start). (See Figure C.)

3. To start the Engine manually, using the Starter Handle (41A) and Starter Rope (40A), insert the Ignition Key (65) and turn the Engine Ignition (2) to its “**RUN**” position. Grasp the Starter Handle (41A) on the Starter Rope (40A) and pull slowly until resistance is felt. Allow the Rope to rewind slowly. Then, pull the Handle with a rapid, full arm stroke. Allow the Rope to rewind slowly. If necessary, repeat this procedure until the Engine starts.
4. When the Engine starts, slowly move the Choke Lever (21A) to its “**RUN**” position. (See Figure E.)
5. **IMPORTANT:** Allow the Generator to run at no load for five minutes after each start-up so that the Engine and Generator can stabilize.

### **To Connect Electrical Loads:**

1. Start the Engine, and allow the Engine and Generator to run and warm up for five minutes after starting with no electrical load.
2. **⚠WARNING!** Connect 120 VAC appliances, tools, and equipment **only** to the four 120 VAC Outlets (5). Connect 240 AC appliances, tools, and equipment **only** to the one 240 VAC Outlet (6). Connect 12 VDC appliances, tools, and equipment **only** to the 12 VDC Terminal (7). (See Figure C.)
3. **⚠CAUTION!** Never exceed the rated capacity for this Generator, as serious damage to the Generator and/or appliances, tools, and equipment could result from an overload. Starting and running wattage requirements should always be calculated when matching this Generator’s wattage capacity to the appliance, tool, or equipment.
4. Most appliances, tools, and equipment will list on the motor nameplate the starting and running voltage and amperage requirements. Use the following formula to convert voltage and amperage to wattage:  
**Volts x Amps = Watts (example: 120 volts x 3 amps = 360 watts)**
5. To determine the approximate wattage requirement for most appliances, tools, and equipment with “inductive” type motors, multiply the wattage that was calculated by 2 times to ensure adequate Generator capacity for motor load starting current.
6. **NOTE:** The starting and running wattage for “resistant” loads are the same. Example: a 100 Watt light bulb requires only 100 Watts to start. Most resistant loads will be listed in wattage.
7. Always power the largest electric motor first. Then, plug in other appliances, tools, and equipment one at a time.
  - a. Connect “inductive” load appliances, tools, and equipment first. Inductive loads consist of small hand tools and some small appliances. Connect the items that require the most wattage first.
  - b. Connect any lights next.



- c. Voltage sensitive appliances, tools, and equipment should be the last to be connected to the Generator and the first to be disconnected. Plug voltage sensitive items such as T.V.'s, VCR's, microwaves, and cordless telephones into a UL listed voltage surge protector (not included). Then, connect the UL Listed surge protector into the Generator.
8. **⚠CAUTION!** Failure to connect and operate appliances, tools, and equipment in this sequence can cause damage to the Generator, appliances, tools, and equipment and will void the warranty on this Generator.
9. Once the Engine is running, simply connect the 120 volt appliances, tools, and equipment into the 120 VAC Outlets (5). Connect a 240 volt appliance, tool, or equipment into the 240 VAC Outlet (6). Or connect a 12 volt appliance, tool, or equipment into the 12 VDC Outlet (8). **(See Figure C.)**
10. **IMPORTANT:** If Engine speed or voltage fluctuates with a load below 250 Watts, move the Engine Choke Lever (21A) to the **"HALF-CHOKE"** position. **(See Figure E.)**
11. When finished using the Generator, disconnect all electrical loads. Turn the Engine Ignition (2) to its **"OFF"** position to stop the Engine. Then, close the Engine Fuel Valve (41). **(See Figures C and E.)**

---

## **INSPECTION, MAINTENANCE, AND CLEANING**

---

1. **⚠WARNING!** Always make sure the Engine's Ignition (2) is in its **"OFF"** position prior to performing any service, maintenance, or cleaning of the Generator or Engine. **(See Figure C.)**
2. **Before each use**, inspect the general condition of the Generator and Engine. Check for loose screws, misalignment or binding of moving parts, cracked or broken parts, loose hose connections, and any other condition that may affect the safe operation of the Generator and Engine. If abnormal noise or vibration occurs, have the problem corrected before further use.  
**Do not use damaged equipment.**
3. **Generator maintenance:**
  - a. Keep the Generator clean and dry at all times.
  - b. The Generator should not be operated or stored in locations that include excessive moisture, dust, flammable or corrosive vapors. If these substances are on the Generator, clean with a cloth or soft brush.
  - c. Do not use a garden hose or anything with liquid to clean the Generator. Liquid may enter the cooling air slots and could damage the interior workings of the Generator.

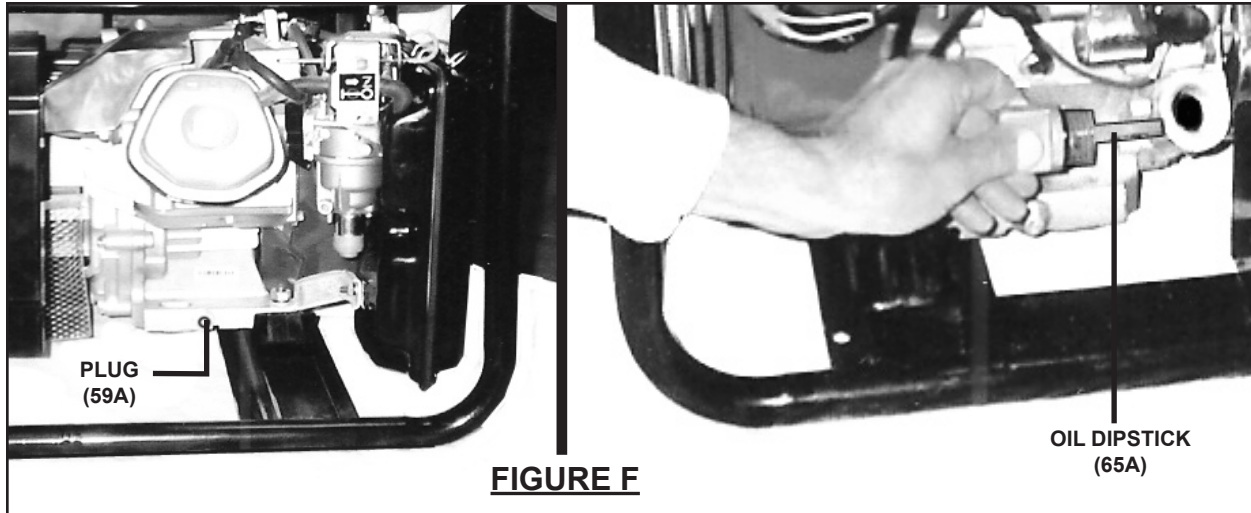

**FIGURE F**

4. **Engine maintenance:**

- a. **After first 5 to 8 hours of use:** Change oil. Then, change oil every 50 hours of use. Change oil every 25 hours of use when operating the Engine under a heavy load or in high temperatures. To change the oil, remove the Plug (59A) and allow the old oil to drain in a proper container. Once drained, replace the Plug. If the Engine will be run in temperatures *above* 32° Fahrenheit, use **SAE 10W-30** weight oil. If the Engine will be run in temperatures *below* 32° Fahrenheit, use **SAE 5W-30** weight oil. To fill the Engine crankcase with new oil, *unscrew* and remove the Oil Dipstick (65A). Pour engine oil into the oil fill hole until the level of oil is even with the bottom edge of the oil fill hole (if you cannot see the oil through the oil fill hole, then the oil is too low and more oil must be added). Make sure to screw the Oil Dipstick (65A) firmly back into its Dipstick Hole. Also, make sure to dispose of the old oil according to local waste disposal requirements. **(See Figure F.)**

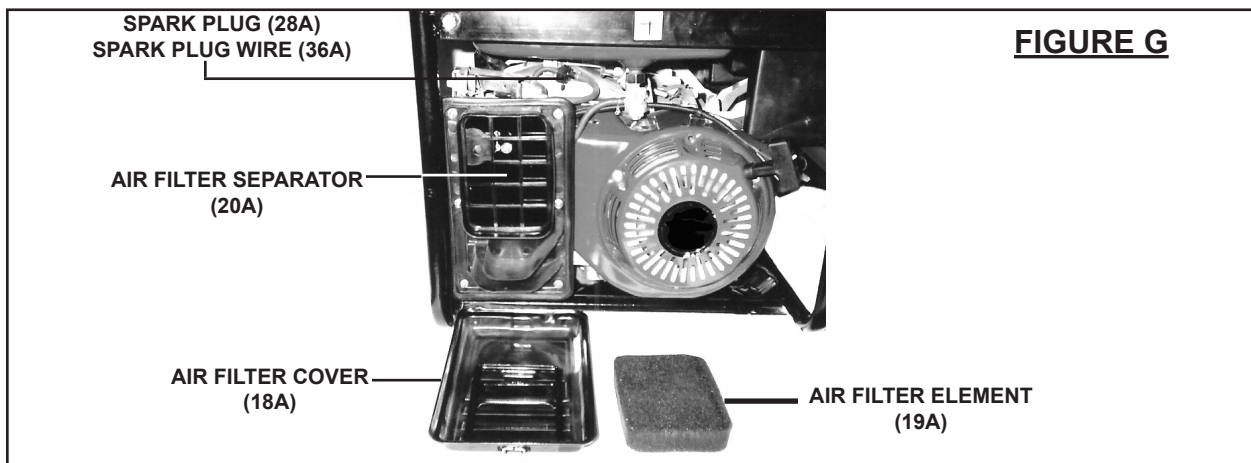

**FIGURE G**

- b. **After every 25 hours of use:** Service the Air Filter Element (19A) and Air Filter Separator (20A). To do so, remove the Air Filter Cover (18A). Remove the Air Filter Element. Immerse the Air Filter Element in a mild solvent and squeeze the Element several times to clean. Remove the Element from the solvent



## TROUBLESHOOTING

Problem	Possible Cause	Possible Solution
<b>Engine will not start.</b>	<ol style="list-style-type: none"> <li>1. Low on fuel or oil.</li> <li>2. Engine power switch is in the OFF position.</li> <li>3. Faulty spark plug.</li> <li>4. Choke in wrong position.</li> <li>5. Fuel valve lever in CLOSED position.</li> <li>6. Generator loaded during start-up.</li> <li>7. Spark plug wire loose.</li> <li>8. Fuel line clogged.</li> <li>9. Faulty ignition system.</li> </ol>	<ol style="list-style-type: none"> <li>1. Add fuel or oil.</li> <li>2. Turn engine power switch to the ON position.</li> <li>3. Replace spark plug.</li> <li>4. Properly adjust choke.</li> <li>5. Turn fuel valve lever to OPEN position.</li> <li>6. Remove load from Generator.</li> <li>7. Attach wire to spark plug.</li> <li>8. Clean fuel line and fuel filter.</li> <li>9. Have a qualified technician check ignition system.</li> </ol>
<b>No electrical output.</b>	<ol style="list-style-type: none"> <li>1. Faulty outlet.</li> <li>2. Circuit breaker tripped.</li> <li>3. Defective capacitor.</li> <li>4. Faulty power cord.</li> </ol>	<ol style="list-style-type: none"> <li>1. Have a qualified technician check outlets.</li> <li>2. Depress circuit breaker and reset.</li> <li>3. Have a qualified technician check capacitor.</li> <li>4. Repair or replace cord.</li> </ol>
<b>Repeated circuit breaker tripping.</b>	<ol style="list-style-type: none"> <li>1. Overload.</li> <li>2. Faulty cords or equipment.</li> </ol>	<ol style="list-style-type: none"> <li>1. Reduce load.</li> <li>2. Check for damaged, bare, or frayed wires on equipment. Repair or replace.</li> </ol>
<b>Generator overheating.</b>	<ol style="list-style-type: none"> <li>1. Generator overloaded.</li> <li>2. Insufficient ventilation.</li> </ol>	<ol style="list-style-type: none"> <li>1. Reduce load.</li> <li>2. Move to adequate supply of fresh air.</li> </ol>

### PLEASE READ THE FOLLOWING CAREFULLY

THE MANUFACTURER AND/OR DISTRIBUTOR HAS PROVIDED THE PARTS LIST AND ASSEMBLY DIAGRAM IN THIS MANUAL AS A REFERENCE TOOL ONLY. NEITHER THE MANUFACTURER OR DISTRIBUTOR MAKES ANY REPRESENTATION OR WARRANTY OF ANY KIND TO THE BUYER THAT HE OR SHE IS QUALIFIED TO REPLACE ANY PARTS OF THE PRODUCT. IN FACT, THE MANUFACTURER AND/OR DISTRIBUTOR EXPRESSLY STATES THAT ALL REPAIRS AND PARTS REPLACEMENTS SHOULD BE UNDERTAKEN BY CERTIFIED AND LICENSED TECHNICIANS, AND NOT BY THE BUYER. THE BUYER ASSUMES ALL RISKS AND LIABILITY ARISING OUT OF HIS OR HER REPAIRS TO THE ORIGINAL PRODUCT OR REPLACEMENT PARTS THERETO, OR ARISING OUT OF HIS OR HER INSTALLATION OF REPLACEMENT PARTS THERETO.

## PARTS LIST - GENERATOR

Part	Description	Qty
1	Bolt w/Lock Washer( M6*12)	4
2	Engine Ignition	1
3	Circuit Breaker	4
4	Control Panel	1
5	AC Outlet (120V)	4
6	AC Outlet (240V)	1
7	DC Terminal(12V)	2
8	Fuse (F10A250V)	1
9	Grounding Terminal	1
10	Power-On Light	1
11	Shock Absorber	4
12	Bolt (M5*215)	2
13	Lock Washer Nut (M8)	12
14	Stator Crust	1
15	Alternator Back Cover	1
16	Automatic Voltage Regulator	1
17	Bolt (M5*12)	7
18	Rectifier	1
19	Bolt (M5*20)	2
20	Cable Sheath	1
21	Carbon Brush	1
22	Bolt (M10*1.25*265)	1
23	Bolt(M6*180)	4
24	Bolt (M5*20)	4
25	Connection Board	1
26	Nut (M5)	4
27	Stator	1
28	Rotor	1

Part	Description	Qty
29	Cooling Fan	1
30	Heat Insulation Board Assembly	1
31	Fuel Tank	1
32	Fuel Filter	1
33	Seal Ring	1
34	Fuel Tank Cap	1
35	Fuel Gauge	1
36	Bolt (M6*12)	2
37	Bolt w/Lock Washer(M6*30)	4
38	Spacer	4
39	Rub Washer	4
40	Bushing	4
41	Fuel Valve	1
42	Frame	1
43	Switch Box Cover	1
44	Battery Guard Plate	1
45	Battery(12V-17AH/20HR)	1
46	Bolt w/lock washer (M6*12)	2
47	Battery Bracket	1
48	Battery Tray	1
58	Connection Board (Muffler)	1
59	Bolt (M8*20)	4
60	Bolt W/ Lock Washer (M6*12)	8
63	Positive Battery Cable	1
64	Negative Battery Cable	1
65	Ignition Key	1
66	Carbon Canister	1

# ASSEMBLY DIAGRAM - GENERATOR

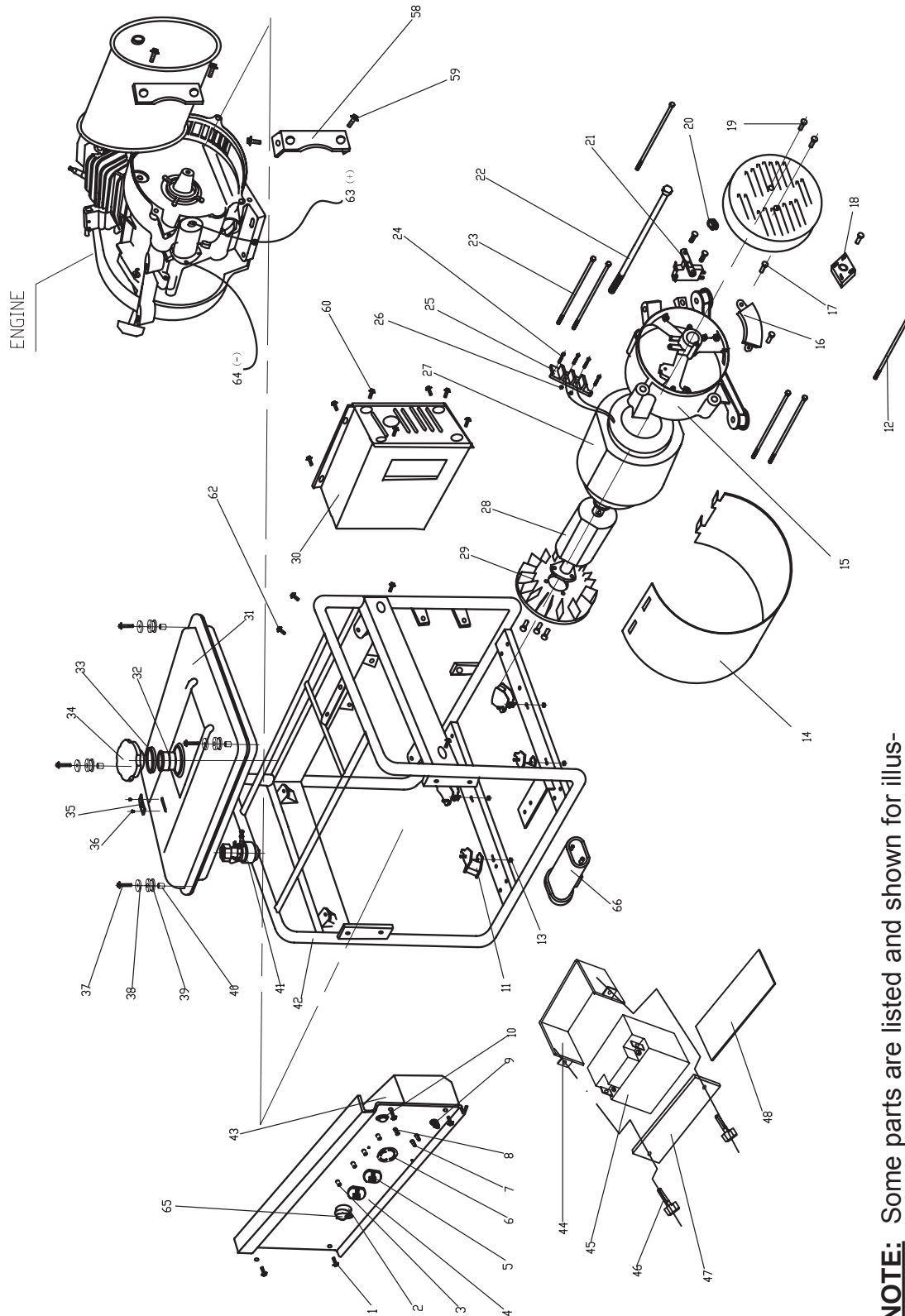

**NOTE:** Some parts are listed and shown for illustration purposes only, and are not available individually as replacement parts.  
 Battery(Part#45) is not included.

## PARTS LIST - ENGINE

Part	Description	Qty	Part	Description	Qty
1A	Muffler	1	44A	Starter Wheel	1
2A	Cylinder Head Bolt	4	45A	Circlip	1
3A	Cylinder Head Cover Bolt	4	46A	Starter Ratchet	2
4A	Cylinder Head Cover	1	47A	Friction Plate Screw	1
5A	Lock Nut	2	48A	Cover	1
6A	Adjusting Screw	2	49A	Starter Pulley	1
7A	Rocker Arm	3	50A	Cooling Fan	1
8A	Rocker Arm Bolt	2	51A	Flywheel Magneto	1
9A	Valve Push Rod Guiding Board	1	52A	Cylinder Block	1
10A	Valve Push Rod	2	53A	Speed Control Lever	1
11A	Cylinder Head	1	54A	Governor Arm	1
12A	Carburetor Shield	1	55A	Governor Spring	1
13A	Carburetor Packing	1	56A	Governor Support	1
14A	Carburetor Assembly	1	57A	Bolt (M6 x 15)	2
15A	Air Filter Case	1	58A	Oil Alert Nut	1
16A	Air Filter Seal	1	59A	Plug (M10 x 15)	2
17A	Bolt (M6)	4	60A	Plug Washer	2
18A	Air Filter Cover	1	61A	Oil Alert	1
19A	Air Filter Element	1	62A	Bolt (M6)	2
20A	Air Filter Separator	1	63A	Crankshaft	1
21A	Choke Lever	1	64A	Crankshaft Gear	1
22A	Carburetor Packing (II)	1	65A	Oil Dipstick	2
23A	Stud Bolt (M6 x 109)	2	66A	Oil Dipstick Seal Ring	2
24A	Intake Valve	1	67A	Gear Casing	1
25A	Exhaust Valve	1	68A	Bolt (M8 x 35)	6
26A	Cylinder Head Gasket	1	69A	Gear Case Packing	2
27A	Exhaust Pipe Stud	2	70A	Bearing	2
28A	Spark Plug	1	71A	Camshaft Assembly	1
29A	Valve Guide	2	72A	Locating Pin	4
30A	Valve Spring	2	73A	Oil Seal	2
31A	Rocker Shaft Circlip	2	74A	Connecting Rod Bolt	2
32A	Anti-Wear Valve Stem Protector	2	75A	Connecting Rod Cap	1
33A	Cylinder Head Cover Packing	1	76A	Connecting Rod	1
34A	Governor Spring	1	77A	Piston	1
35A	Bolt	1	78A	Compression Ring (I)	1
36A	Spark Plug Wire	1	79A	Compression Ring (II)	1
37A	Ignition Coil	1	80A	Oil Scraper Ring	1
38A	Nut (Special 14mm)	1	81A	Piston Pin	1
39A	Starter Ratchet Spring	2	82A	Piston Pin Circlip	1
40A	Starter Rope	1	83A	Starter	1
41A	Starter Handle	1	84A	Gear	1
42A	Starter Case Assembly	1	85A	Fuel Pipe	1
43A	Spiral Spring	1	86A	Spark Plug Wrench Kit	1

# ASSEMBLY DIAGRAM - ENGINE

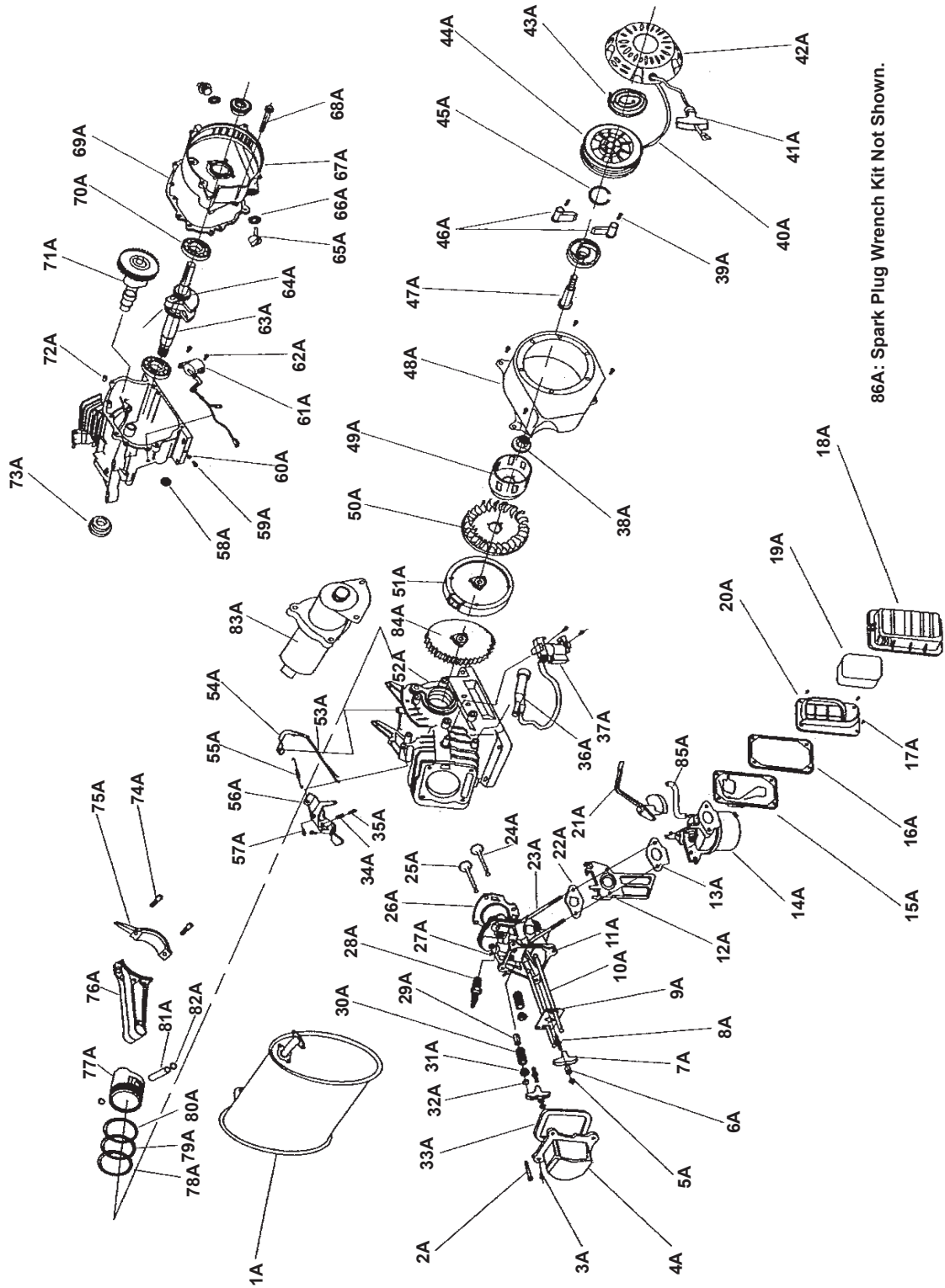

86A: Spark Plug Wrench Kit Not Shown.



---

## LIMITED 1 YEAR WARRANTY

---

Harbor Freight Tools Co. makes every effort to assure that its products meet high quality and durability standards, and warrants to the original purchaser that this product is free from defects in materials and workmanship for the period of one year from the date of purchase (90 days if used by a professional contractor or if used as rental equipment). See engine manufacturer's warranty which covers engine. This warranty does not apply to damage due directly or indirectly, to misuse, abuse, negligence or accidents, repairs or alterations outside our facilities, normal wear and tear, or to lack of maintenance. We shall in no event be liable for death, injuries to persons or property, or for incidental, contingent, special or consequential damages arising from the use of our product. Some states do not allow the exclusion or limitation of incidental or consequential damages, so the above limitation of exclusion may not apply to you. THIS WARRANTY IS EXPRESSLY IN LIEU OF ALL OTHER WARRANTIES, EXPRESS OR IMPLIED, INCLUDING THE WARRANTIES OF MERCHANTABILITY AND FITNESS.

To take advantage of this warranty, the product or part must be returned to us with transportation charges prepaid. Proof of purchase date and an explanation of the complaint must accompany the merchandise. If our inspection verifies the defect, we will either repair or replace the product at our election or we may elect to refund the purchase price if we cannot readily and quickly provide you with a replacement. We will return repaired products at our expense, but if we determine there is no defect, or that the defect resulted from causes not within the scope of our warranty, then you must bear the cost of returning the product.

This warranty gives you specific legal rights and you may also have other rights which vary from state to state.

**3491 Mission Oaks Blvd. • PO Box 6009 • Camarillo, CA 93011 • (800) 444-3353**

## Emission Control System Warranty

### California and United States Emission Control Defects Warranty Statement

The California Air Resources Board (herein CARB), the United States Environmental Protection Agency (herein EPA), and Harbor Freight Tools® (herein HFT) are pleased to explain the emission control system warranty on your 1995 and later Small Off-Road Engine (herein engine). In California, the engine must be designed, built and equipped to meet the State's stringent anti-smog standards. Elsewhere within the United States, new off-road, spark-ignition engines certified for model year 1997 and later, must meet similar standards set forth by the EPA. HFT must warrant the emission control system on your engine for the periods of time described below, provided there has been no abuse, neglect or improper maintenance of your engine.

Your emission control system may include parts such as the carburetor or fuel-injection system, and the ignition system. Also included may be hoses, belts, connectors and other emission-related assemblies.

Where a warrantable condition exists, HFT will repair your engine at no cost to you including diagnosis, parts and labor.

### Manufacturer's Warranty Coverage

The 1995 and later engines are warranted for two (2) years. If any emission-related part on your engine is defective, the part will be repaired or replaced by HFT.

### Harbor Freight Tools Emission Control Defects Warranty Coverage

Engines are warranted for a period of two (2) years relative to emission control parts defects, subject to the provisions set forth below. If any emission related part on your engine is defective, the part will be repaired or replaced by HFT.

#### Owner's Warranty Responsibilities

- As the engine owner, you are responsible for the performance of the required maintenance listed in your Owner's Manual. HFT recommends that you retain all receipts covering maintenance on your engine, but HFT cannot deny warranty solely for the lack of receipts or for your failure to ensure the performance of all scheduled maintenance.
- As the engine owner, you should, however, be aware that HFT may deny you warranty coverage if your engine or a part has failed due to abuse, neglect, improper maintenance, or unapproved modifications.
- You are responsible for shipping your engine to a HFT warranty station as soon as a problem exists. Contact the HFT Customer Service department at the number below to make shipping arrangements. The warranty repairs should be completed in a reasonable amount of time, not to exceed 30 days.

If you have any questions regarding your warranty rights and responsibilities, you should contact the Harbor Freight Tools Customer Service Department at 1-800-444-3353.

# Emission Control System Warranty - continued

## Harbor Freight Tools Emission Control Defects Warranty Provisions

### **1. Length of Coverage**

HFT warrants to a first retail purchaser and each subsequent purchaser that the engine is free from defects in materials and workmanship that cause the failure of warranted parts for a period of two (2) years after the date of delivery to the first retail purchaser.

### **2. No Charge Repair or Replacement**

Repair or replacement of any warranted part will be performed at no charge to the owner if the work is performed through a warranty station authorized by HFT. For emissions warranty service, contact the HFT Customer Service Department at 1-800-444-3353.

### **3. Consequential Damages Coverage**

Coverage under this warranty shall also extend to the failure of any engine components caused by the failure of any warranted part while it is still covered under this warranty.

### **4. Coverage Exclusions**

Warranty claims shall be filed in accordance with the provisions of the HFT warranty policy explained in the box at the top of the previous page. HFT shall not be liable for any loss of use of the engine, for any alternative usage, for any damage to goods, loss of time, or inconvenience. Warranty coverage shall also be excluded for any part which fails, malfunctions, or is damaged due to failure to follow the maintenance and operating instructions set forth in the Owner's Manual including, but not limited to:

- (a) use of parts which are not authorized by HFT
- (b) improper installation, adjustment or repair of the engine or of any warranted part unless performed by an authorized warranty center
- (c) failure to follow recommendations on fuel use contained in the Owner's Manual
- (d) improper or inadequate maintenance of any warranted parts
- (e) repairs performed outside of the authorized warranty service dealers
- (f) alterations by changing, adding to or removing parts from the engine.

### **5. Service and Maintenance**

Component parts which are not scheduled for replacement as required maintenance or are scheduled only for regular inspection to the effect of "repair or replace as necessary" are warranted for the warranty period. Any warranted part which is scheduled for replacement as required maintenance is warranted for the period of time up to the first scheduled replacement point for that part. Any replacement part, provided it is equivalent in durability and performance, may be used in performance of maintenance or repairs. The owner is responsible for commissioning a qualified technician/mechanic to perform all required maintenance, as outlined in the **Inspection, Cleaning, and Maintenance** section on page 17 of this manual.

### **6. Warranted Parts**

- 1) Fuel Metering System**
  - i) Carburetor and its internal parts.
  - ii) Fuel pump (if so equipped).
  - iii) Cold start enrichment system.
- 2) Air Induction System**
  - i) Intake pipe/manifold.
  - ii) Air cleaner.
- 3) Ignition System**
  - i) Spark plug.
  - ii) Magneto ignition system.
- 4) Catalyst System (if so equipped)**
  - i) Exhaust pipe stud.
  - ii) Muffler.
  - iii) Catalytic converter (if so equipped).
- 5) Miscellaneous items Used in Above Systems**
  - i) Vacuum, temperature and time sensitive valves and switches.
  - ii) Hoses, belts, connectors, and assemblies.

# Electrical Diagram

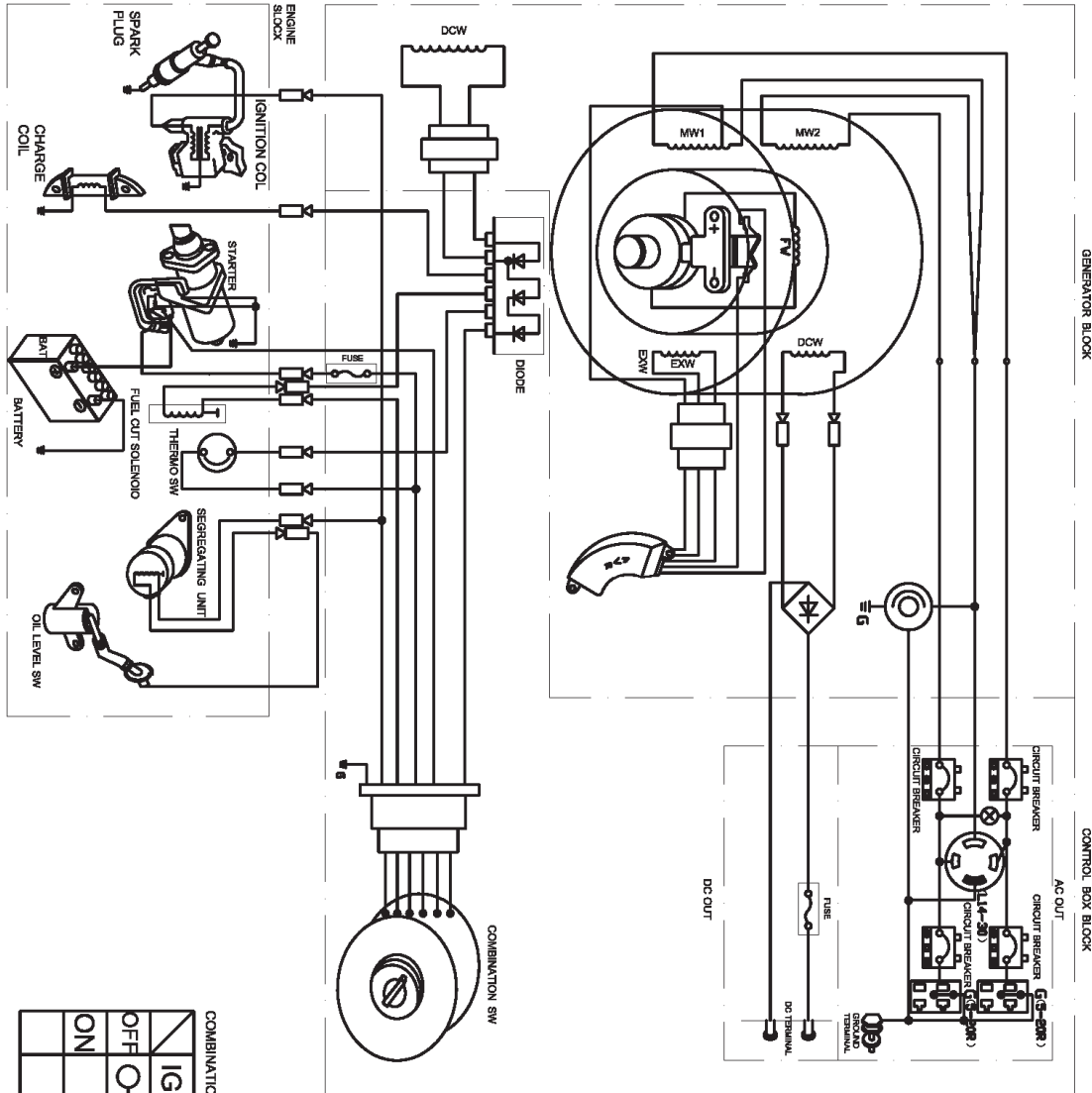

COMBINATION SW

IG	E	BAT	ST	PS	G
OFF	○	○		○	○
ON			○		

Please note: All electrical work should be performed by a qualified service technician.