



TOSHIBA

OWNER'S MANUAL

Color Television

COLORSTREAM®

Important
Safeguards

Welcome to
Toshiba

Connecting
your TV

Using the
Remote Control

Setting up
your TV

Using the TV's
Features

Appendix

Owner's Record

The model number and serial number are on the back of your TV. Record these numbers in the spaces below. Refer to these numbers whenever you communicate with your Toshiba dealer about this TV.

Model number:

Serial number:

27A35C

Dear Customer,

Thank you for purchasing this Toshiba TV. This manual will help you use the many exciting features of your new TV. **Before operating the TV, please read this manual completely, and keep it nearby for future reference.**

Safety Precautions

WARNING

TO REDUCE THE RISK OF FIRE OR ELECTRIC SHOCK, DO NOT EXPOSE THIS APPLIANCE TO RAIN OR MOISTURE.



WARNING: TO REDUCE THE RISK OF ELECTRIC SHOCK, DO NOT REMOVE COVER (OR BACK). NO USER-SERVICEABLE PARTS INSIDE. REFER SERVICING TO QUALIFIED SERVICE PERSONNEL.

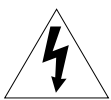

The lightning symbol in the triangle tells you that the voltage inside this product may be strong enough to cause an electric shock. **DO NOT TRY TO SERVICE THIS PRODUCT YOURSELF.**



The exclamation mark in the triangle tells you that important operating and maintenance instructions follow this symbol.

CAUTION: To reduce the risk of electric shock, do not use the polarized plug with an extension cord, receptacle, or other outlet unless the blades can be inserted completely to prevent blade exposure.

NOTE TO CATV INSTALLERS

This is a reminder to call the CATV system installer's attention to Article 820-40 of the NEC, which provides guidelines for proper grounding and, in particular, specifies that the cable ground shall be connected to the grounding system of the building, as close to the point of cable entry as practical. For additional antenna grounding information, see items 25 and 26 on page 4.

NOTICE OF POSSIBLE ADVERSE EFFECTS ON TV PICTURE DISPLAY

If a fixed (non-moving) pattern or image remains on the TV screen for extended periods of time, the image can become permanently ingrained in the cathode ray tube(s) of the TV and cause subtle but permanent ghost images. **This type of damage is NOT COVERED BY YOUR WARRANTY.** See page 4 for details.

Child Safety



It Makes A Difference Where Your TV Stands

Congratulations on your purchase! As you enjoy your new TV, keep these safety tips in mind:

The Issue

- If you are like most consumers, you have a TV in your home. Many homes, in fact, have more than one TV.
- The home theater entertainment experience is a growing trend, and larger TVs are popular purchases; however, they are not always supported on the proper TV stands.
- Sometimes TVs are improperly secured or inappropriately situated on dressers, bookcases, shelves, desks, audio speakers, chests, or carts. As a result, TVs may fall over, causing unnecessary injury.

Toshiba Cares!

- The consumer electronics industry is committed to making home entertainment enjoyable and safe.
- The Consumer Electronics Association formed the Home Entertainment Support Safety Committee, comprised of TV and consumer electronics furniture manufacturers, to advocate children's safety and educate consumers and their families about television safety.

Tune Into Safety

- One size does NOT fit all! Use appropriate furniture large enough to support the weight of your TV (and other electronic components).
- Use appropriate angle braces, straps, and anchors to secure your furniture to the wall (but never screw anything directly into the TV).
- Carefully read and understand the other enclosed instructions for proper use of this product.
- Do not allow children to climb on or play with furniture and TVs.
- Avoid placing any item on top of your TV (such as a VCR, remote control, or toy) that a curious child may reach for.
- Remember that children can become excited while watching a program and can potentially push or pull a TV over.
- Share our safety message about this hidden hazard of the home with your family and friends. Thank you!



2500 Wilson Blvd.
Arlington, VA 22201 U.S.A.
Tel. 703-907-7600 Fax 703-907-7690
www.CE.org
CEA is the Sponsor, Producer and Manager of the International CES®

Important Safety Instructions

- 1) **Read these instructions.**
- 2) **Keep these instructions.**
- 3) **Heed all warnings.**
- 4) **Follow all instructions.**



- 5) **Do not use this apparatus near water.**



- 6) **Clean only with a dry cloth.**



- 7) **Do not block any ventilation openings.** Install in accordance with the manufacturer's instructions.



- 8) **Do not install near any heat sources** such as radiators, heat registers, stoves, or other apparatus (including amplifiers) that produce heat.



- 9) **Do not defeat the safety purpose of the polarized or grounding type plug.** A polarized plug has two blades with one wider than the other. A grounding type plug has two blades and a third grounding prong. The wide blade or the third prong are provided for your safety. If the provided plug does not fit into your outlet, consult an electrician for replacement of the obsolete outlet.

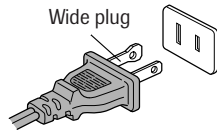

- 10) **Protect the power cord** from being walked on or pinched, particularly at plugs, convenience receptacles, and the point where it exits the apparatus.

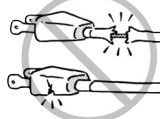

- 11) **Only use attachments/accessories specified by the manufacturer.**

- 12) **Use only with the cart, stand, tripod, bracket, or table specified by the manufacturer, or sold with the apparatus.** When a cart is used, use caution when moving the cart/apparatus combination to avoid injury from tip-over.



- 13) **Unplug this apparatus during lightning storms or when unused for long periods of time.**



- 14) **Refer all servicing to qualified service personnel.**

Service is required when the apparatus has been damaged in any way, such as power supply cord or plug is damaged, liquid has been spilled or objects have fallen into the apparatus, the apparatus has been exposed to rain or moisture, does not operate normally, or has been dropped.



- 15) **CAUTION:** To reduce the risk of electric shock, do not use the polarized plug with an extension cord, receptacle, or other outlet unless the blades can be inserted completely to prevent blade exposure.



Installation, Care, and Service

Installation

Follow these recommendations and precautions and heed all warnings when installing your TV:

- 16) Never modify this equipment. Changes or modifications may void: a) the warranty, and b) the user's authority to operate this equipment under the rules of the Federal Communications Commission.

- 17) **DANGER: RISK OF SERIOUS PERSONAL INJURY, DEATH, OR EQUIPMENT DAMAGE!** Never place the TV on an unstable cart, stand, or table. The TV may fall, causing serious personal injury, death, or serious damage to the TV.



- 18) Never place or store the TV in direct sunlight; hot, humid areas; areas subject to excessive dust or vibration; or locations with temperatures at or below 41°F (5°C).

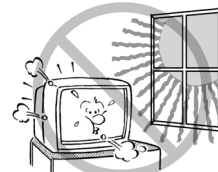

- 19) Always place the TV on the floor or a sturdy, level, stable surface that can support the weight of the unit.



- 20) Never place items such as vases, aquariums, or candles on top of the TV.



- 21) Never block or cover the slots or openings in the TV cabinet back, bottom, and sides. Never place the TV:
 - on a bed, sofa, rug, or similar surface;
 - too close to drapes, curtains, or walls; or
 - in a confined space such as a bookcase, built-in cabinet, or any other place with poor ventilation.



The slots and openings are provided to protect the TV from overheating and to help maintain reliable operation of the TV.



- 22) Never allow anything to rest on or roll over the power cord, and never place the TV where the power cord is subject to wear or abuse.

- 23) Never overload wall outlets and extension cords.



Important
Safeguards

Welcome to
Toshiba

Connecting
your TV

Using the
Remote Control

Setting up
your TV

Using the TV's
Features

Appendix

0303

3

24) Always operate this equipment from a 120V AC, 60 Hz power source only.

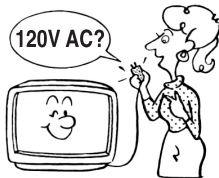

25) Always make sure the antenna system is properly grounded to provide adequate protection against voltage surges and built-up static charges (see Section 810 of the National Electric Code).

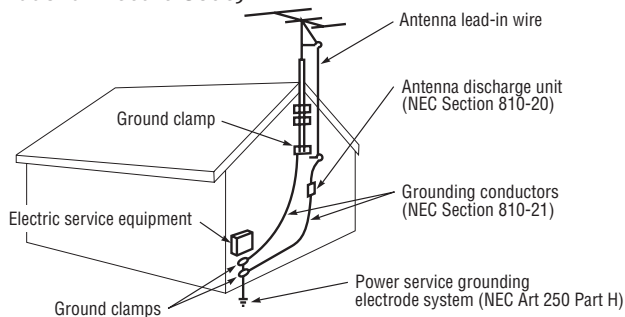

26) **DANGER: RISK OF SERIOUS PERSONAL INJURY OR DEATH!**



- Use extreme care to make sure you are never in a position where your body (or any item you are in contact with, such as a ladder or screwdriver) can accidentally touch overhead power lines. Never locate the antenna near overhead power lines or other electrical circuits.
- Never attempt to install any of the following during lightning activity:
 - a) an antenna system; or
 - b) cables, wires, or any home theater component connected to an antenna or phone system.

Care

For better performance and safer operation of your TOSHIBA TV, follow these recommendations and precautions:

27) Always sit approximately 10–25 feet away from the TV and as directly in front of it as possible. The picture can appear dull if you sit too far to the left or right of the TV, or if sunlight or room lights reflect on the screen. Turn the TV off to check for reflections on the screen, and then remove the source of reflections while viewing the TV.

28) Always unplug the TV before cleaning. Never use liquid or aerosol cleaners.

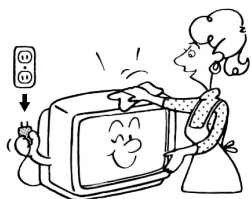

29) **WARNING: RISK OF ELECTRIC SHOCK!** Never spill liquids or push objects of any kind into the TV cabinet slots.



30) [This item applies to projection TVs only.] If the air temperature rises suddenly (for example, when the TV is first delivered), condensation may form on the lenses. This can make the picture appear distorted or the color appear faded. If this happens, turn off the TV for 6 to 7 hours to allow the condensation to evaporate.

31) For added protection of your TV from lightning and power surges, always unplug the power cord and disconnect the antenna from the TV if you leave the TV unattended or unused for long periods of time.

32) During normal use, the TV may make occasional snapping or popping sounds. This is normal, especially when the unit is being turned on or off. If these sounds become frequent or continuous, unplug the power cord and contact a Toshiba Authorized Service Center.

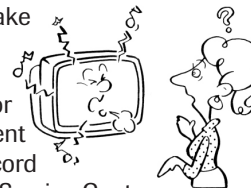

33) **Possible Adverse Effects on TV Picture Display:** If a fixed (non-moving) pattern or image remains on the TV screen for extended periods of time, the image can become permanently ingrained in the cathode ray tube(s) of the TV and cause subtle but permanent ghost images. **This type of damage is NOT COVERED BY YOUR WARRANTY.** Never leave the TV on for extended periods of time while it is displaying the following images or formats:

- **Fixed Images**, including but not limited to PIP/POP windows, closed captions, video game patterns, TV station logos, stock tickers, and websites.
- **Special Formats** that do not use the entire screen, including but not limited to widescreen or letterbox format media viewed on a 4:3 aspect ratio display (with gray or black bars at the top and bottom of the screen); or 4:3 aspect ratio format media viewed on a widescreen/16:9 aspect ratio display (with gray or black bars on the left and right sides of the screen).

Service

34) **WARNING: RISK OF ELECTRIC SHOCK!** Never attempt to service the TV yourself. Opening and removing the covers may expose you to dangerous voltage or other hazards. Refer all servicing to a Toshiba Authorized Service Center.

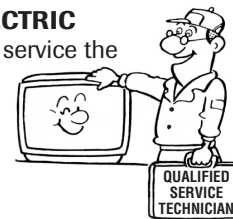

35) If you have the TV serviced:

- Ask the service technician to use only replacement parts specified by the manufacturer.
- Upon completion of service, ask the service technician to perform routine safety checks to determine that the TV is in safe operating condition.

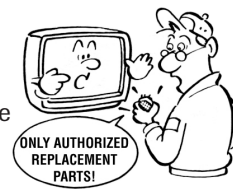

36) When the TV reaches the end of its useful life, ask a qualified service technician to properly dispose of the TV. Improper disposal may result in a picture tube implosion and possible personal injury.



Important Safety Information	2-4
Welcome to Toshiba	6
Exploring your new TV	6
Selecting a location for the TV	6
Connecting your TV	7
Connecting a VCR	7
Connecting a cable converter box	8
Connecting a DVD player/satellite receiver and a VCR	9
Connecting a DVD player with ColorStream® (component video) and a VCR	9
Connecting a camcorder	10
Using the remote control	11
Installing the remote control batteries	11
Learning about the remote control	11
Setting up your TV	12
Changing the on-screen display language	12
Adding channels to the TV's memory	13
Programming channels automatically	13
Adding and erasing channels manually	13
Changing channels	13
Using the TV's features	14
Adjusting the channel settings	14
Switching between two channels	14
Programming your favorite channels	14
Using the LOCK menu	15
Selecting a PIN code	15
Locking channels	16
Locking video input	17
Setting the GameTimer™	17
Labeling channels	18
Setting the clock	19
Setting the ON/OFF timer	19
Setting the ON timer	19
Setting the OFF timer	20
Adjusting the picture quality	21
Watching video input	21
Specifying the ColorStream® setting	21
Displaying TV status information on-screen	21
Setting the sleep timer	22
Using the closed caption feature	22
Adjusting the sound	23
Muting the sound	23
Selecting stereo/SAP broadcasts	23
Adjusting the sound quality	23
Using the surround sound feature	24
Using the StableSound® feature	24
Auto power off	24
Understanding the Power Return feature	24
Appendix	25
Troubleshooting	25
Specifications	26
Limited Canada Warranty	27

Important
Safeguards

Welcome to
Toshiba

Connecting
your TV

Using the
Remote Control

Setting up
your TV

Using the TV's
Features

Appendix



Welcome to
Toshiba

Welcome to Toshiba

Congratulations! You have purchased one of the finest color TVs on the market. The goal of this manual is to guide you through setting up and operating your Toshiba TV as quickly as possible.

You may need to purchase other audio or video cables to connect your equipment. See "Connecting your TV" on page 7 for more information.

Please read all the safety and operating instructions carefully before you begin.

Exploring your new TV

You can operate your TV by using the buttons on the front panel or the remote control. The front and back panels provide all the inputs you will need to connect other equipment to your TV.

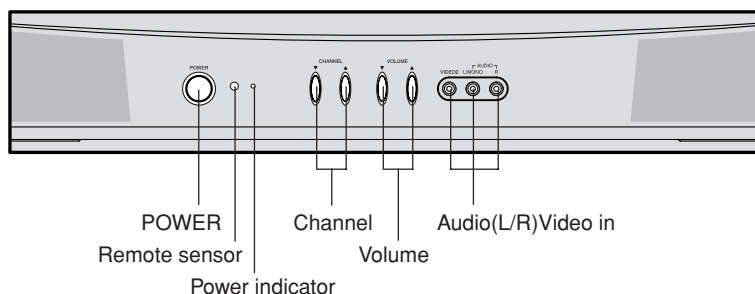

TV front panel

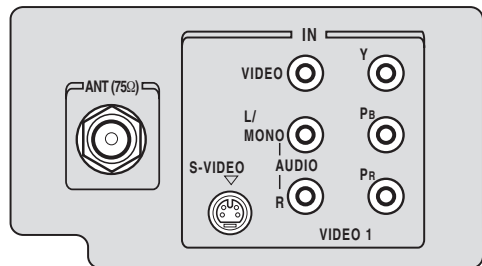

TV back panel

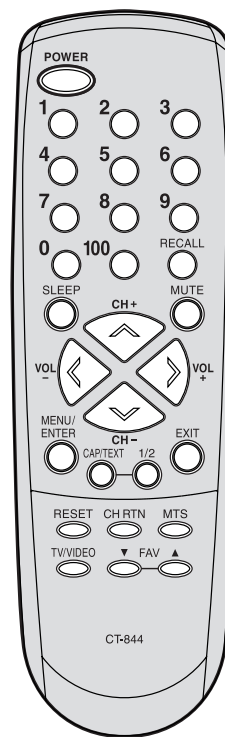

Selecting a location for the TV

- Place the TV on the floor or on a sturdy platform in a location where light does not directly hit the screen.
- Place the TV far enough from the walls to allow proper ventilation. Inadequate ventilation may cause overheating, which may damage the TV.



Connecting your TV

- A coaxial cable is the standard cable that comes in from your antenna or cable converter box. Coaxial cables use “F” connectors.
- Standard A/V (audio/video) cables are usually color coded according to use: yellow for video and red and white for audio. The red audio cable is for the stereo right channel, and the white audio cable is for the stereo left (or mono) channel. If you look at the rear panel of the TV, you will see that the terminals are color coded in the same manner as the cables.
- An S-video cable provides better picture performance than a standard video cable. S-video cables can only be used with S-video compatible components.
- Component video cables come in sets of three and provide the best picture performance. Component video cables can only be used with component video compatible components.

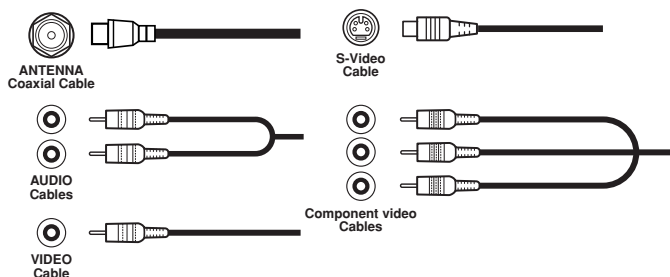

Connecting a VCR

This connection allows you to watch local channels and video programs, play or record on the VCR while watching TV, and record from one channel while watching another channel.

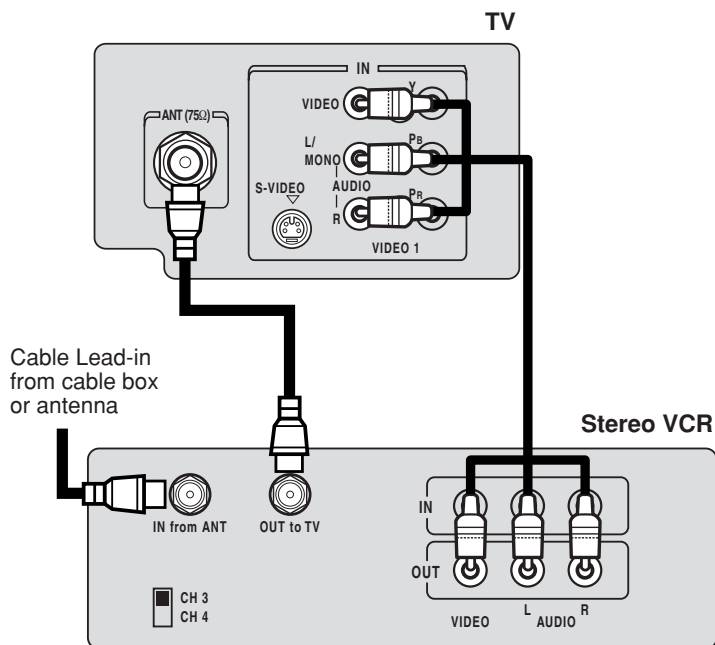

NOTICE: RISK OF EQUIPMENT DAMAGE!

Do not plug in any power cords until you have finished connecting all equipment.

- You will need:
- two coaxial cables
 - one set of standard A/V cables

Note:

If using a mono VCR, connect L/Mono to VCR Audio OUT using only one audio cable. For better picture quality, if your VCR has S-video, you can use an S-video cable instead of the standard video cable. Do not connect a standard video cable and an S-video cable to VIDEO1 simultaneously.

The unauthorized recording, use, distribution or revision of television programs, videotapes, DVDs, and other materials is prohibited under the Copyright Laws of the United States and other countries, and may subject you to civil and criminal liability.





Connecting a cable converter box

This television has an extended tuning range and can tune most cable channels without using a cable company supplied converter box. Some cable companies offer “premium pay channels” in which the signal is scrambled. Descrambling these signals for normal viewing requires the use of a descrambler device, which is generally provided by the cable company.

For Subscribers to Basic Cable TV Service

For basic cable service not requiring a Converter/Descrambler box, connect the CATV 75 ohm Coaxial Cable directly to the Antenna Jack on the back of the television.

For Subscribers to Scrambled Cable TV Service

If you subscribe to a cable service that requires the use of a Converter/Descrambler box, connect the incoming cable to the Converter/Descrambler box and connect the output of the box to the Antenna Jack on the back of the television. Follow the connections shown below. Set the television to the output of the Converter/Descrambler box (usually channel 3 or 4) and use the Converter/Descrambler box to select channels.

For Subscribers to Unscrambled Basic Cable with Scrambled Premium Channels

If you subscribe to a cable service in which basic cable channels are unscrambled and premium channels require the use of a Converter/Descrambler box, you may wish to use a two-set signal splitter (sometimes called a “two-set coupler”) and an A/B Switch box from the cable installer or an electronics supply store. Follow the connections shown below. With the switch in the “B” position, you can directly tune any unscrambled channels on your TV. With the switch in the “A” position, tune your TV to the output of the Converter/Descrambler box (usually channel 3 or 4) and use the box to tune scrambled channels.

Note:

When you use a converter box with your TV, there may be features that you cannot program using the remote control, such as labeling channels, blocking channels, and programming your favorite channels.

Incoming CATV

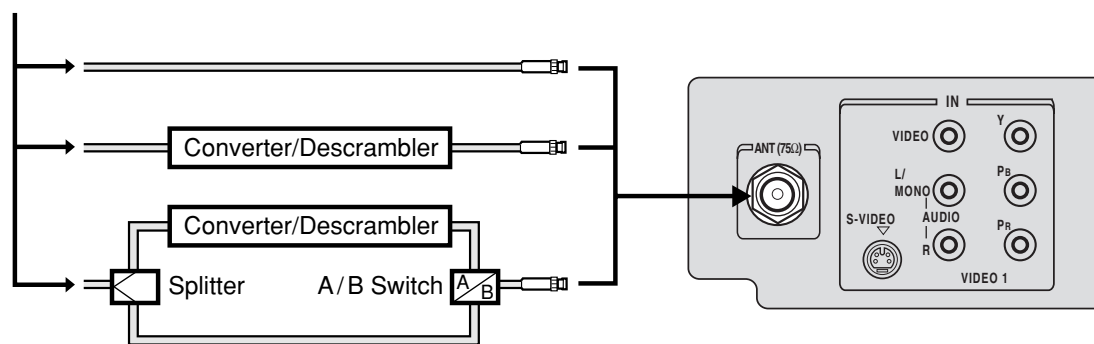

Connecting a DVD player/satellite receiver and a VCR

This connection allows you to watch DVD/satellite, VCR, or TV programs. You can record from the satellite receiver and TV, as well as record one TV channel while watching another channel.

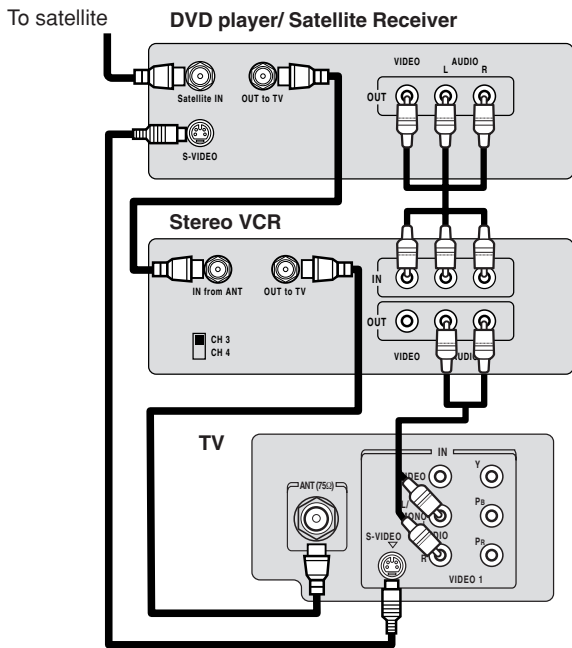

Connecting a DVD player with ColorStream® (component video) and a VCR

This connection allows you to watch DVD, VCR, or TV programs and record TV programs. You can record one TV channel while watching another channel or a DVD. Your TV is capable of using ColorStream (component video). Connecting your TV to a component video compatible DVD player, such as a Toshiba DVD player with ColorStream®, can greatly enhance picture quality and performance.

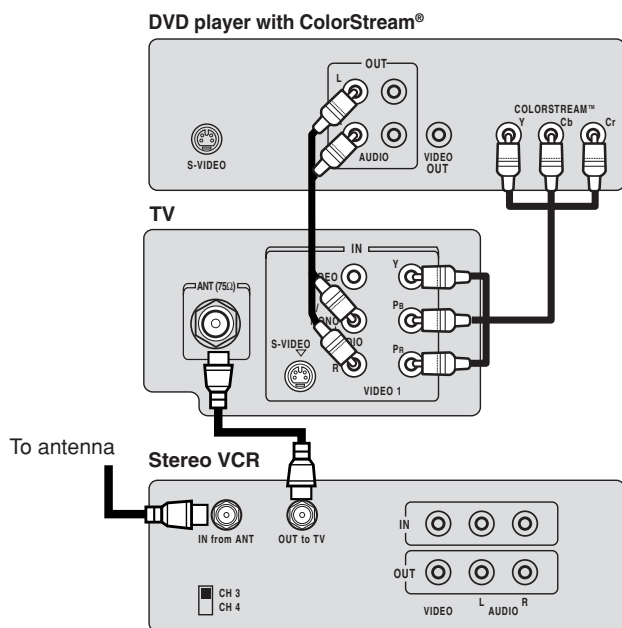

You will need:

- three coaxial cables
- one set of standard A/V cables
- one S-video cable
- one pair of standard audio cables

Note:

You can use a standard video cable instead of the S-video cable, but the picture quality will decrease. If you use an S-video cable between the TV and DVD player/satellite receiver, make the audio connections only and remove the standard video cable.

You will need:

- two coaxial cables
- one set of component video cables
- one pair of standard audio cables

Note:

The ColorStream inputs on this TV are for use with devices that output 480i interlaced signals ONLY. This TV will not accept or display 480p or 720p progressive scan signals or 1080i interlaced high-definition signals. If you connect a high-definition set-top receiver, 480p progressive scan DVD player, or other similar device to the TV's ColorStream inputs, YOU MUST SWITCH THE DEVICE'S OUTPUT TO 480i INTERLACED MODE FIRST. Failure to do this will cause a poor picture or no picture to display.

The unauthorized recording, use, distribution or revision of television programs, videotapes, DVDs, and other materials is prohibited under the Copyright Laws of the United States and other countries, and may subject you to civil and criminal liability.

Important
Safeguards

Welcome to
Toshiba

Connecting
your TV

Using the
Remote Control

Setting up
your TV

Using the TV's
Features

Appendix



Connecting a camcorder

This connection allows you to watch video materials recorded on a camcorder.

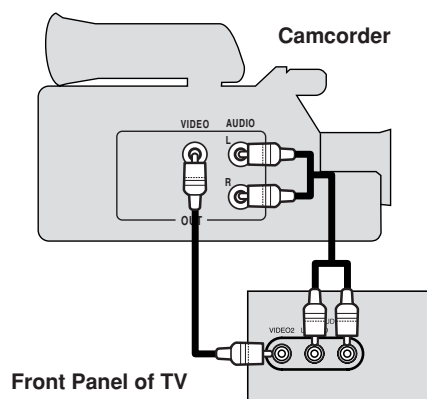

You will need:

- one set of standard A/V cables

Note:

For better picture quality, if your camcorder has S-video, you can connect an S-video (and standard audio cables) to VIDEO1 on the back of the TV. Do not connect a standard video cable and an S-video cable to VIDEO1 simultaneously.

Connecting
your TV

Using the remote control

Installing the remote control batteries

To install the batteries:

1. Open the battery cover on the back of the remote control.

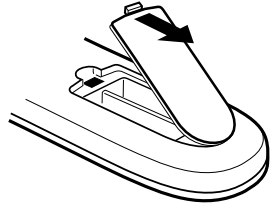

2. Install two "AAA" size batteries. Match the + and - signs on the batteries to the signs on the battery compartment.

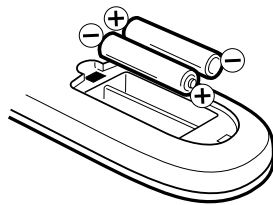

3. Close the battery cover on the remote control until the lock snaps.

Caution:

Never throw batteries into a fire.

Notes:

- Be sure to use AAA size batteries.
- Dispose of batteries in a designated disposal area.
- Batteries should always be disposed of with the environment in mind. Always dispose of batteries in accordance with applicable laws and regulations.
- If the remote control does not operate correctly, or if the operating range becomes reduced, replace batteries with new ones.
- When necessary to replace batteries in the remote control, always replace both batteries with new ones. Never mix battery types or use new and used batteries in combination.
- Always remove batteries from remote control if they are dead or if the remote control is not to be used for an extended period of time. This will prevent battery acid from leaking into the battery compartment.

Learning about the remote control

POWER turns the TV on and off

CHANNEL NUMBERS allow direct access to channels (page 13)

RECALL displays status information on-screen (page 21)

SLEEP programs the TV to turn off at a set time (page 22)

MUTE turns off the sound (page 23)

CH + / - cycles through programmed channels (page 13)

VOLUME + / - adjusts the volume level

MENU/ENTER allows access to programming menus, and sets programmed menu information (page 12)

EXIT exits programming menus (page 12)

CAP/TEXT turns closed captions or text on and off (page 22)

1/2 selects closed caption/text channel 1 or 2 (page 22)

RESET returns settings to preset factory formats (pages 21 and 23)

CH RTN (Channel Return) returns to the last viewed channel (page 14)

MTS switches among STEREO, SAP, and MONO sound (page 23)

TV/VIDEO selects the video input source (page 21)

FAV ▲/ ▼ (Favorite Channels) cycle through favorite channels (page 14)

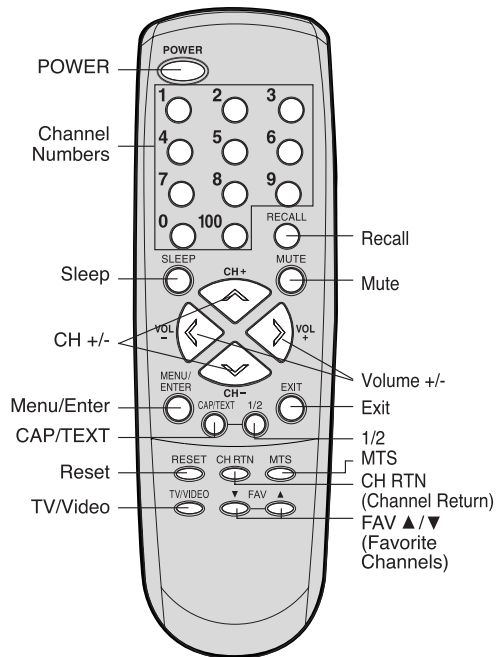

Important
Safeguards

Welcome to
Toshiba

Connecting
your TV

Using the
Remote Control

Setting up
your TV

Using the TV's
Features

Appendix

Setting up your TV

After you have installed the batteries and programmed the remote control, you need to set some preferences on the TV using the menu system. You can access the menu system with the buttons on the remote control.

- When you make a menu selection, your changes occur immediately. You do not have to press MENU or EXIT to see your changes.
- After 15 seconds, the menu screen will automatically close if you do not make a selection. Your changes will still be saved.
- When you are finished programming the menus, press EXIT.

Changing the on-screen display language

You can choose from three different languages (English, French, and Spanish) for the on-screen display of adjustment menus and messages.

To select a language:

1. Press MENU, then press \leftarrow or \rightarrow until the OPTION menu appears.

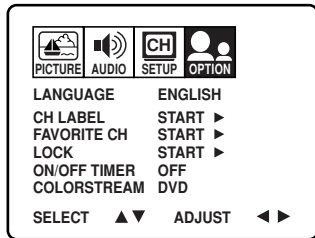

2. Press \wedge or \vee to highlight LANGUAGE.

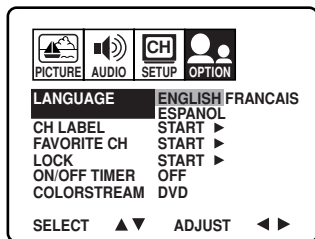

3. Press \leftarrow or \rightarrow to highlight your desired language.

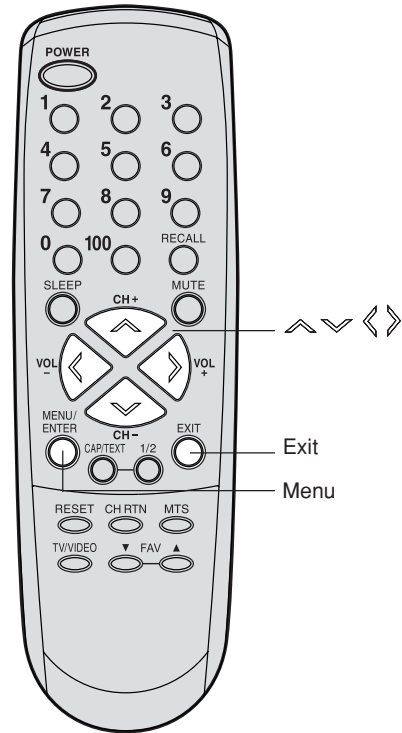

Setting up
your TV

Adding channels to the TV's memory

When you press CH +/- on the remote control or CHANNEL ▼/▲ on the TV front panel, your TV will stop only on the channels stored in the TV's channel memory. Follow the steps below to program channels into the memory.

Programming channels automatically

Your TV can automatically detect all active channels and store them in its memory. After the TV has stored the channels in its memory automatically, you can add or erase specific channels manually.

To add channels automatically:

1. Press MENU, then press ◀ or ▶ to display the SETUP menu.
2. Press ▲ or ▼ until the TV/CABLE selection is highlighted.
3. Press ◀ or ▶ to highlight either TV or CABLE, depending on which you use.

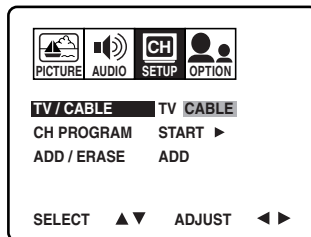

If you use an antenna, choose TV.
If you use cable, choose CABLE.

4. Press ▼ to select CH PROGRAM.
5. Press ◀ or ▶ to start channel programming. The TV will automatically cycle through all the TV or Cable channels (depending on which you selected), and store all active channels in the channel memory. While the TV is cycling through the channels, the message "PROGRAMMING NOW-PLEASE WAIT" appears.
6. When channel programming is complete, the message "COMPLETED" appears.
7. Press CH + or - to view the programmed channels.

Adding and erasing channels manually

After you have programmed the channels automatically, you can add or erase specific channels manually.

To add or erase channels manually:

1. Select the channel you want to add or erase. If you are adding a channel, you must select the channel using the Channel Number buttons.
2. Press MENU, then press ◀ or ▶ to display the SETUP menu.
3. Press ▲ or ▼ to highlight ADD/ERASE.
4. Press ◀ or ▶ to select ADD or ERASE, whichever function you want to perform.
5. Repeat steps 1–4 for other channels you want to add or erase.

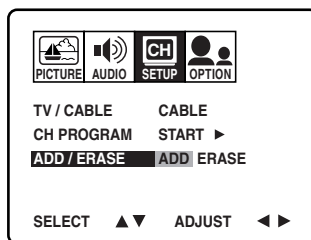

Changing channels

To change to the next programmed channel:

Press CHANNEL ▲/ ▼ on the TV front panel or CH +/- on the remote control.

To change to a specific channel (programmed or unprogrammed):

Press the Channel Number buttons (0–9 and 100) on the remote control.

For example, to select channel 125, press 100, 2, 5.

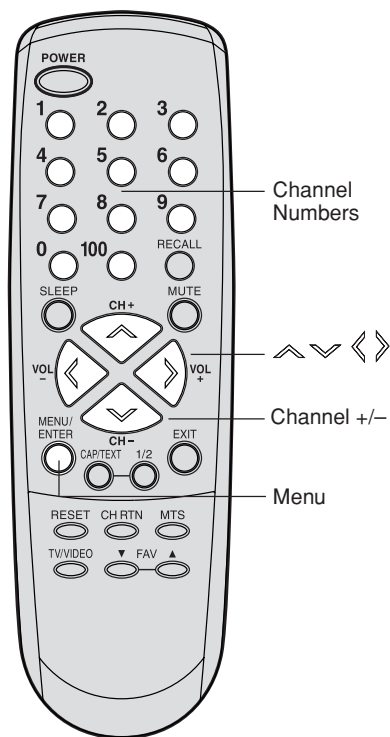

Important
Safeguards

Welcome to
Toshiba

Connecting
your TV

Using the
Remote Control

Setting up
your TV

Using the TV's
Features

Appendix



Using the TV's features

Adjusting the channel settings

Switching between two channels

You can switch between two channels without entering an actual channel number each time.

To switch between two channels:

1. Select the first channel you want to view.
2. Select a second channel using the Channel Number buttons (0–9, 100).
3. Press CH RTN. The previous channel will be displayed.

Each time you press CH RTN, the TV will switch back and forth between the two channels.

Programming your favorite channels

You can preset up to 12 of your favorite channels using the Favorite Channel Programming feature. Because this feature scans through only your favorite channels, it allows you to skip other channels you do not normally watch.

You can still use Channel + / – to scan through all the channels you programmed in the TV's memory.

To program your favorite channels:

1. Select a channel you want to program as a favorite channel.
2. Press MENU, then press \leftarrow or \rightarrow to display the OPTION menu.
3. Press \wedge or \vee to highlight FAVORITE CH.

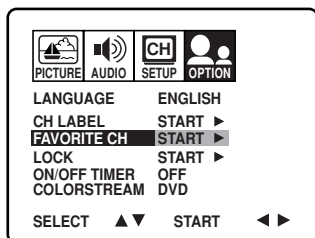

4. Press \leftarrow or \rightarrow to display the FAVORITE CH menu. SET/CLEAR will be highlighted.

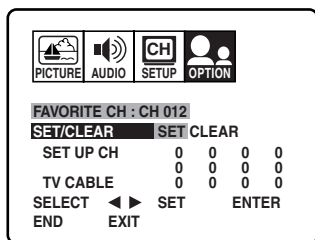

5. Press \leftarrow or \rightarrow to highlight SET and press ENTER.
6. Press EXIT to close the screen.
7. Repeat steps 1–6 for up to 12 channels.

To select your favorite channels:

Press the FAV \blacktriangle \blacktriangledown buttons on the remote control to select your favorite channels.

The FAV \blacktriangle \blacktriangledown buttons will not work until you have programmed your favorite channels.

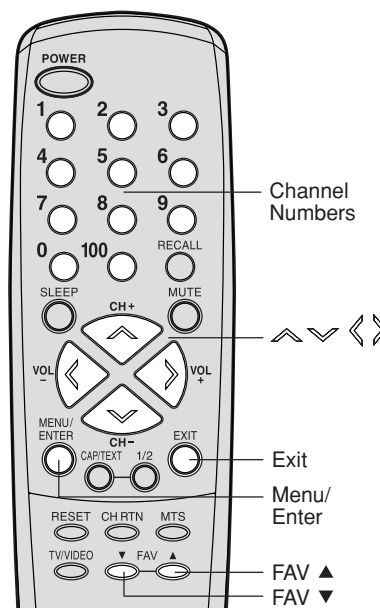
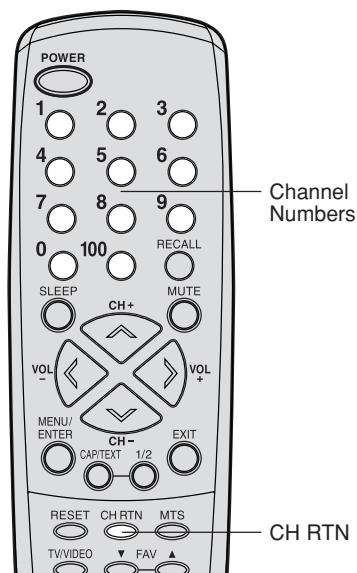

To clear your favorite channels:

1. Select a channel you want to clear.
2. Press MENU, then press \leftarrow or \rightarrow to display the OPTION menu.
3. Press \wedge or \vee to highlight FAVORITE CH.
4. Press \leftarrow or \rightarrow to display the FAVORITE CH menu. SET/CLEAR will be highlighted.

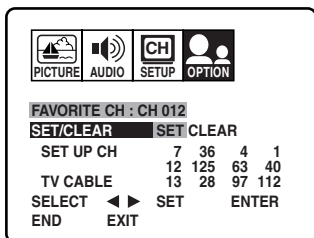

5. Press \leftarrow or \rightarrow to highlight CLEAR.

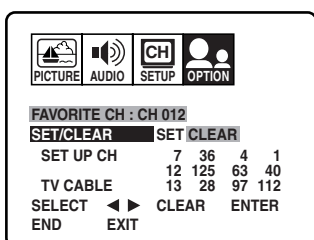

6. Press ENTER until "0" replaces the channel number you want to erase.
7. Press EXIT to clear the screen.
8. Repeat steps 1–6 for the other channels.

Using the LOCK menu

The LOCK menu includes the CH LOCK, VIDEO LOCK, GAMETIMER, and NEW PIN CODE functions.

Selecting a PIN code

You can use these functions after entering the correct PIN code.

To select your PIN code and access the LOCK menus:

1. Press MENU, then press \leftarrow or \rightarrow to highlight the OPTION menu.
2. Press \wedge or \vee to highlight LOCK.

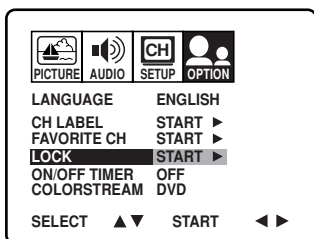

3. Press \leftarrow or \rightarrow to display the BLOCKING menu.

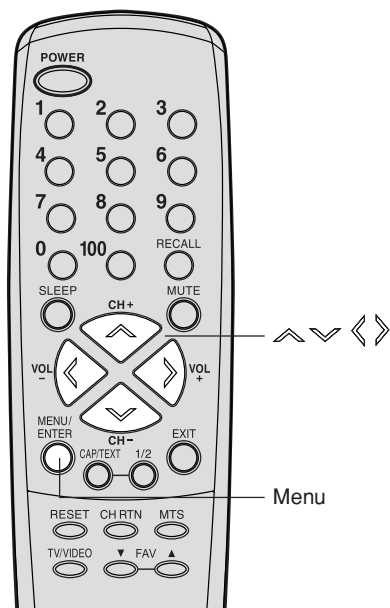
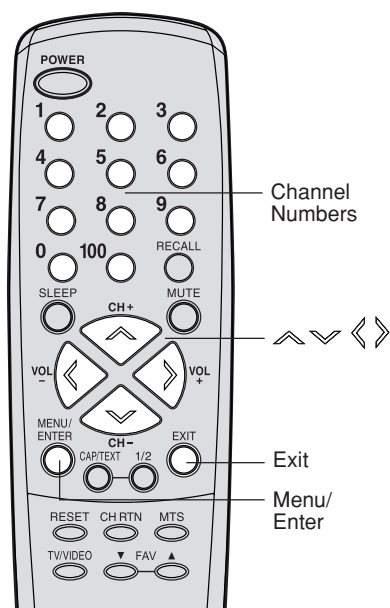
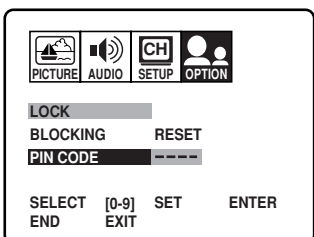

Important Safeguards

Welcome to Toshiba

Connecting your TV

Using the Remote Control

Setting up your TV

Using the TV's Features

Appendix



- Use the Channel Number buttons (0–9) to enter your PIN code. If you are accessing the LOCK menus for the first time, select a four-digit number to be your PIN code. Press ENTER. The BLOCKING menu appears.

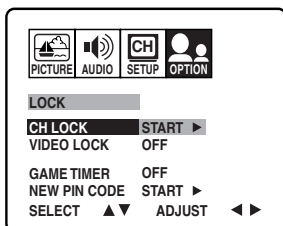

- You may now enable blocking. See “Locking channels” (below), “To change your PIN code” (below), or “Locking video input” (page 17), or “Setting the GameTimer™” (page 17).

To change your PIN code:

- Press MENU, then press \leftarrow or \rightarrow to display the OPTION menu.
- Press \uparrow or \downarrow to highlight LOCK.
- Press \leftarrow or \rightarrow to display the BLOCKING menu.
- Use the Channel Number buttons (0–9) to enter your PIN code. Press ENTER. The BLOCKING menu appears.
- Press \uparrow or \downarrow to highlight NEW PIN CODE and press \leftarrow or \rightarrow to display the NEW PIN CODE menu.
- Use the Channel Number buttons (0–9) to enter a new code. Press ENTER.
- Press EXIT to return to normal viewing.

Note:

If you forget your PIN code, press RECALL four times within five seconds from the BLOCKING menu. This resets your PIN code and allows you to proceed to the BLOCKING menu.

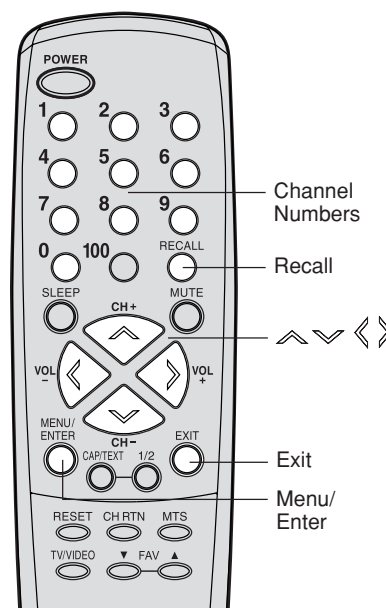

Locking channels

With the CH LOCK feature, you can lock specific channels. You will not be able to tune locked channels unless you clear the setting. You can choose to lock up to nine TV channels and nine cable channels.

To lock channels:

- Use the Channel Number buttons (0–9, 100) to display the television channel you wish to lock.
- Press MENU, then press \leftarrow or \rightarrow to display the OPTION menu.
- Press \uparrow or \downarrow to highlight LOCK.
- Press \leftarrow or \rightarrow to display the LOCK menu.
- Use the Channel Number buttons (0–9) to enter your PIN code, then press ENTER. The LOCK menu appears.
- Press \uparrow or \downarrow to highlight CH LOCK and press \leftarrow or \rightarrow to display the CH LOCK menu.
- Press \leftarrow or \rightarrow to select the following:
 - SET– to set the channel as one to be locked. Then press ENTER.
 - CLEAR– to clear all channels from the list of locked channels. Then press ENTER.
- Repeat steps 1 through 7 to lock other channels. When you are finished locking channels, press EXIT to return to normal viewing. If you try to tune a locked channel, the TV will not display it, but will display the nearest unlocked channel.

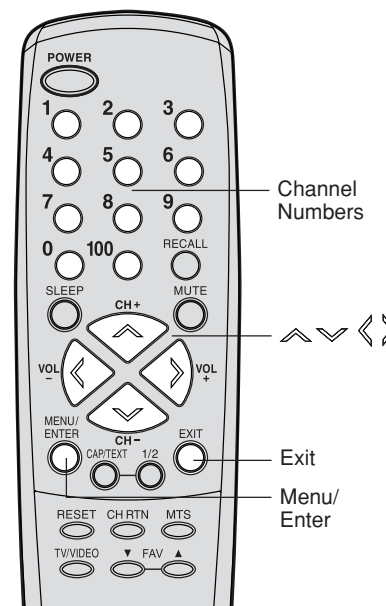
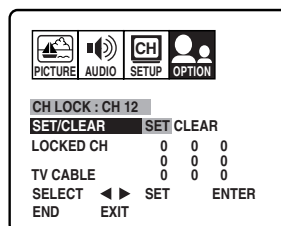
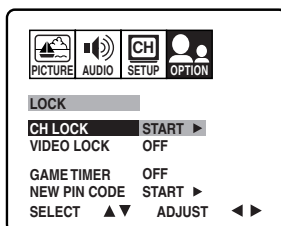

Note:

After programming CH LOCK, change channels before turning off the television.



To unlock channels:

1. Press MENU, then press \leftarrow or \rightarrow to display the OPTION menu.
2. Press \uparrow or \downarrow to highlight LOCK and then press \leftarrow or \rightarrow to display the LOCK menu.
3. Use the Channel Number buttons (0–9) to enter your PIN code, then press ENTER. The LOCK menu appears.
4. Press \uparrow or \downarrow to highlight CH LOCK and press \leftarrow or \rightarrow to display the CH LOCK menu.
5. Press \leftarrow or \rightarrow to highlight CLEAR, and then press ENTER. This clears all channels from the list of locked channels.
6. Press EXIT to return to normal viewing.

Locking video input

With the VIDEO LOCK feature, you can lock out the input sources (VIDEO1, VIDEO2, COLORSTREAM) and channels 3 and 4. You will not be able to select the input sources with the TV/VIDEO button or Channel Numbers unless you clear the setting.

To set up the video lock:

1. Press MENU, then press \leftarrow or \rightarrow to display the OPTION menu.
2. Press \uparrow or \downarrow to highlight LOCK.
3. Press \leftarrow or \rightarrow to display the LOCK menu.
4. Use the Channel Number buttons (0–9) to enter your PIN code, then press ENTER. The LOCK menu appears.
5. Press \uparrow or \downarrow to highlight VIDEO LOCK.
6. Press \leftarrow or \rightarrow to select:
 - OFF: Unlocks all video input sources.
 - VIDEO: Locks VIDEO1, VIDEO2 and COLORSTREAM.
 - VIDEO +: Locks VIDEO1, VIDEO2, COLORSTREAM, channel 3 and channel 4. This option should be used if you use the antenna terminal to play a video tape.
7. Press EXIT to return to normal viewing.

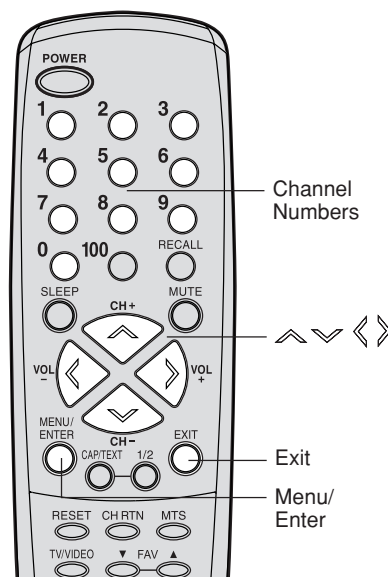
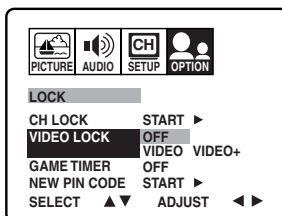

Note:

After programming VIDEO LOCK, change channels or press the TV/VIDEO button before turning off the television.

Setting the GameTimer™

With the GameTimer™ feature, you can automatically activate the VIDEO LOCK feature (VIDEO setting) to set a time limit for playing a TV game (30, 60, 90 or 120 minutes).

To set up the GameTimer:

1. Press MENU, then press \leftarrow or \rightarrow to display the OPTION menu.
2. Press \uparrow or \downarrow to highlight LOCK.
3. Press \leftarrow or \rightarrow to display the LOCK menu.
4. Use the Channel Number buttons (0–9) to enter your PIN code, then press ENTER. The LOCK menu appears.
5. Press \uparrow or \downarrow to highlight GameTimer.
6. Press \leftarrow or \rightarrow to select a time limit (30 minutes, 60 minutes, 90 minutes, 120 minutes or OFF).
7. Press EXIT to return to normal viewing. After the GameTimer is programmed, the display will appear briefly every ten minutes to remind you that the GameTimer is operating. When the programmed time is reached, the TV will change channels automatically.

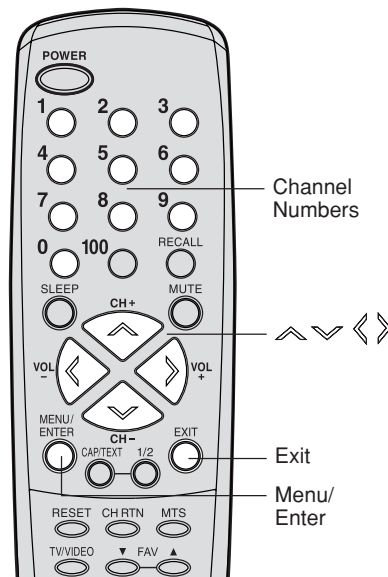
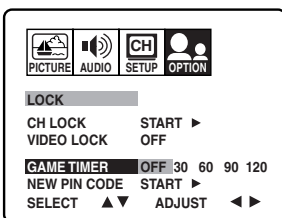

Important Safeguards

Welcome to Toshiba

Connecting your TV

Using the Remote Control

Setting up your TV

Using the TV's Features

Appendix

Labeling channels

Channel labels appear over the channel number display each time you turn on the TV, select a channel, or press the Recall button. You can choose any four characters to identify a channel.

To create channel labels:

1. Select a channel you want to label.
2. Press MENU, then press \leftarrow or \rightarrow until the OPTION menu appears.
3. Press \wedge or \vee to highlight CH LABEL.

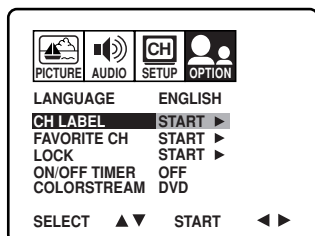

4. Press \leftarrow or \rightarrow to display the CH LABEL menu. SET/CLEAR will be highlighted.

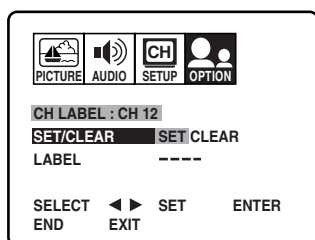

5. Press \leftarrow or \rightarrow to highlight SET.
6. Press \wedge or \vee to highlight LABEL.

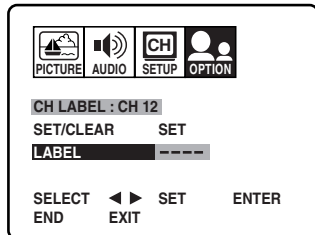

7. Press \leftarrow or \rightarrow to enter a character in the first space. Press the button repeatedly until the character you want appears on the screen. Press ENTER.

8. Repeat step 7 to enter the rest of the characters.

If you would like a blank space in the label name, you must choose a blank space from the list of characters; otherwise, a dash will appear in that space.

9. Repeat steps 1–8 for other channels. You can assign a label to each channel.
10. Press EXIT to clear the screen.

To erase channel labels:

1. Select a channel with a label.
2. Press MENU, then press \leftarrow or \rightarrow until the OPTION menu appears.
3. Press \wedge or \vee to highlight CH LABEL.
4. Press \leftarrow or \rightarrow to display the CH LABEL menu. SET/CLEAR will be highlighted.
5. Press \leftarrow or \rightarrow to highlight CLEAR.
6. Press ENTER.
7. Repeat steps 1–6 to erase other channel labels.

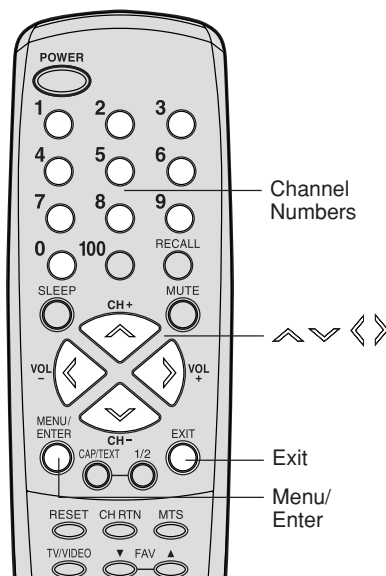
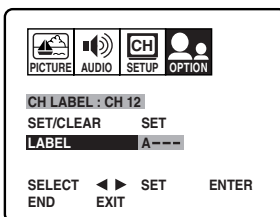

Note:

The character will change as below.

\leftarrow \rightarrow 0 \leftarrow \rightarrow ... \leftarrow \rightarrow 9 \leftarrow \rightarrow A \leftarrow \rightarrow ...
 \leftarrow \rightarrow Z \leftarrow \rightarrow SPACE \leftarrow \rightarrow + \leftarrow \rightarrow -

Setting the clock

You must set the clock before you can program the ON/OFF timer.

To set the clock: (Example: 8:30 AM)

1. Press MENU, then press \leftarrow or \rightarrow to display the OPTION menu.
2. Press \wedge or \vee to highlight ON/OFF TIMER.

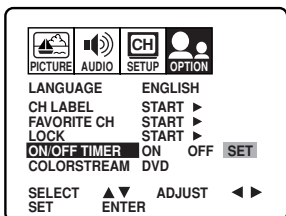

3. Press \leftarrow or \rightarrow to highlight SET, then press ENTER. The ON/OFF TIMER menu appears.
4. Press \wedge or \vee to highlight CLOCK, then press \leftarrow or \rightarrow to highlight the hour position.

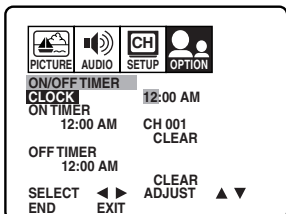

5. Press \wedge or \vee to set the hour, then press \rightarrow to highlight the minute position.

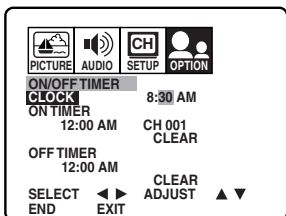

6. Press \wedge or \vee to set the minutes, then press EXIT to return to normal viewing.

Setting the ON/OFF timer

Setting the ON timer

This feature allows you to program the TV to turn on automatically at a set time. If you program the ON timer to "DAILY," the TV will turn on every day at the same time to the same channel until you clear the ON timer.

Note : You must set the clock before you can program the ON timer (see above).

To set the ON timer: (Example: Turning on the TV to channel 12 at 7:00 AM, DAILY)

1. Press MENU, then press \leftarrow or \rightarrow to display the OPTION menu.
2. Press \wedge or \vee to highlight ON/OFF TIMER.
3. Press \leftarrow or \rightarrow to highlight SET, then press ENTER. The ON/OFF TIMER menu appears.
4. Press \wedge or \vee to highlight ON TIMER and press \leftarrow or \rightarrow to highlight the hour position.

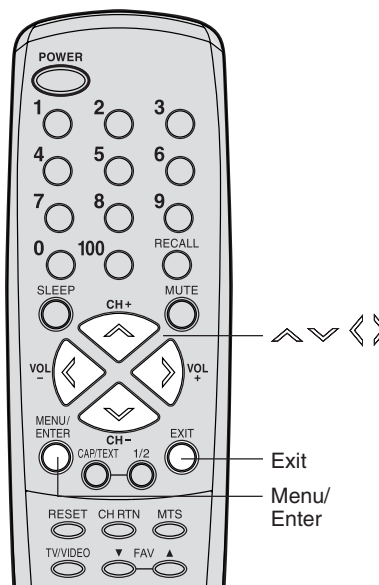
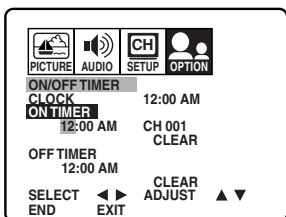

Note:

If the power source for the TV is interrupted (for example, the power cord is unplugged or a power failure occurs), you will need to reset the clock.

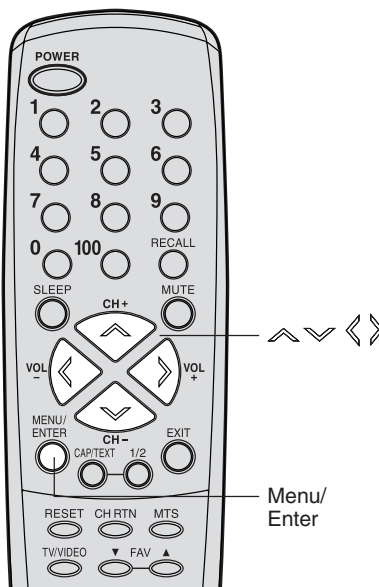

Note:

After a power failure or disconnection of the power, the timer settings will be lost.

Important
Safeguards

Welcome to
Toshiba

Connecting
your TV

Using the
Remote Control

Setting up
your TV

Using the TV's
Features

Appendix



5. Press or to set the desired hour, then press .

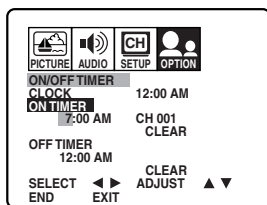

6. Set the desired minutes and channel, as in step 5.
7. Press or to select ONCE or DAILY timer date.

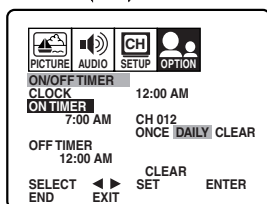

8. Press EXIT to return to normal viewing.

To cancel the ON timer:

Select CLEAR in step 7 above.
Press EXIT to return to normal viewing.

Setting the OFF timer

This feature allows you to program the TV to turn off automatically at a set time. If you program the OFF timer to "DAILY," the TV will automatically turn off every day at the same time.

Note : You must set the clock before you can program the OFF timer (see page 19).

To set the OFF timer: (Example: Turning off the TV at 11:30 PM)

1. Press MENU, then press or to display the OPTION menu.
2. Press or to highlight ON/OFF TIMER.
3. Press or to highlight SET, then press ENTER. The ON/OFF TIMER menu appears.
4. Press or to highlight OFF TIMER, then press or to highlight the hour position.

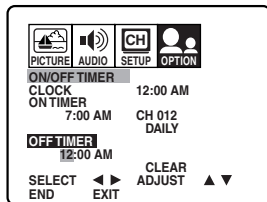

5. Press or to set the desired hour, then press .

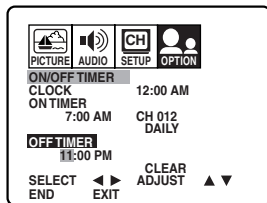

6. Set the desired minutes, as in step 5.
7. Press or to select ONCE or DAILY.

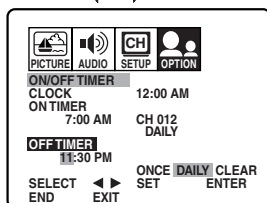

8. Press EXIT to return to normal viewing.

To cancel the OFF timer:

Select CLEAR in step 7 above.
Press EXIT to return to normal viewing.

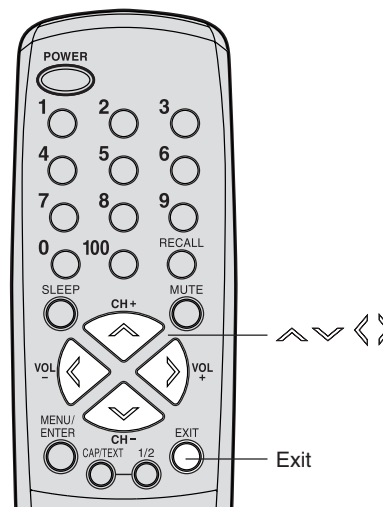

Note:
The ON TIMER has a one-hour automatic shut off. One hour after the ON TIMER has turned on the TV, the TV will turn off automatically unless you press any button.

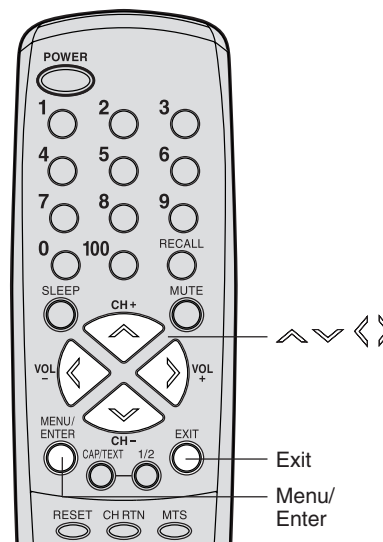

Using the TV's Features



Adjusting the picture quality

You can adjust the picture quality to your personal preferences, including the contrast, brightness, color, tint, and sharpness. The qualities you choose will be stored automatically in your TV's memory.

To adjust the picture quality:

1. Press MENU, then press \langle or \rangle to display the PICTURE menu.

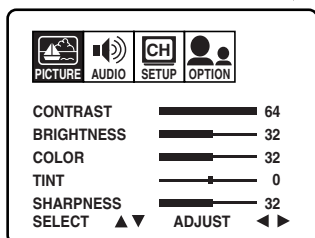

2. Press \wedge or \vee until the item you want to adjust is highlighted.
3. Press \langle or \rangle to adjust the level.

Selection	\langle Pressing	\rangle
contrast	lower	higher
brightness	darker	lighter
color	paler	deeper
tint	reddish	greenish
sharpness	softer	sharper

4. Press EXIT to return to normal viewing.

Watching video input

You can use the TV/VIDEO button on the remote control to view a signal coming from other devices, such as a VCR or video disc player that may be connected to your TV. (See "Connecting your TV" on page 7.)

Specifying the ColorStream® setting

You can use the ColorStream (component video) input for connecting either a DVD player or a DTV receiver.

Note: This TV is **not** HD ready.

1. Press TV/VIDEO to put the TV in ColorStream mode.
2. Press MENU, then press \langle or \rangle until the OPTION menu appears.
3. Press \wedge or \vee to highlight COLORSTREAM.
4. Press \langle or \rangle to highlight DVD or DTV, depending on which device is connected.
5. Press EXIT to return to normal viewing.

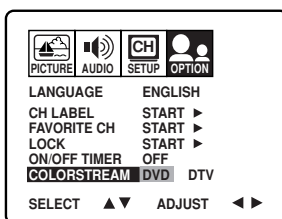

Note: The factory setting is DVD.

Displaying TV status information on-screen

Press RECALL to display the following information on-screen:

- Clock
- Channel number or VIDEO mode selected
- Channel label (if preset)
- Stereo or SAP (second audio program) audio status

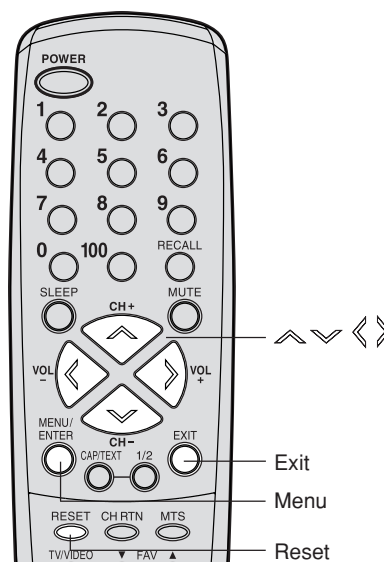
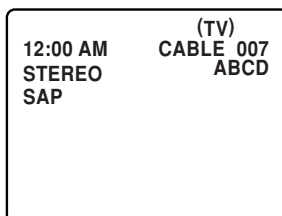

Note:

To reset the picture adjustments to the factory settings, press RESET.

To select the input mode:

Press the TV/VIDEO button repeatedly to select the desired mode. The signal source you are connected to is displayed in light blue.

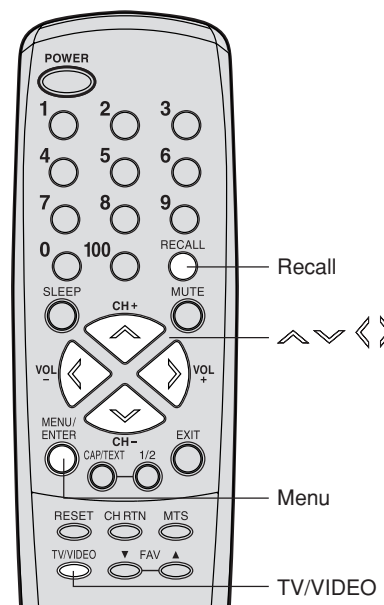
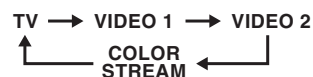

Important
Safeguards

Welcome to
Toshiba

Connecting
your TV

Using the
Remote Control

Setting up
your TV

Using the TV's
Features

Appendix



Setting the sleep timer

You can set the TV so it turns off automatically.

To set the sleep timer:

Repeatedly press SLEEP on the remote control to set the length of time until the TV turns off. The clock will count down 10 minutes for each press of the SLEEP button (120, 110, ...10, 0). After the sleep time is programmed, the display will appear briefly every ten minutes to remind you that the sleep timer is operating.

To confirm the sleep timer setting:

Press SLEEP one time. The remaining time will be momentarily displayed.

To cancel the sleep timer:

Repeatedly press SLEEP until the display turns to 0.

Using the closed caption feature

The closed caption feature has two options: captions or text. A caption is a printed version of the dialogue, narration and/or sound effects of a program. Text is information not related to the program that appears on half of the TV screen when available.

To view captions or text:

1. Select the desired program. Closed captioned programs are usually marked in your local TV listing as "CC."
2. Press CAP/TEXT repeatedly to select caption or text mode.

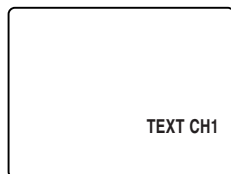
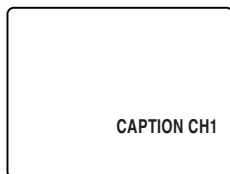

3. Press 1/2 to select the caption or text channel.

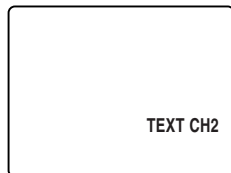
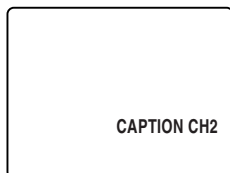

4. To turn off the closed caption feature, press CAP/TEXT repeatedly until captions or text no longer display on-screen.

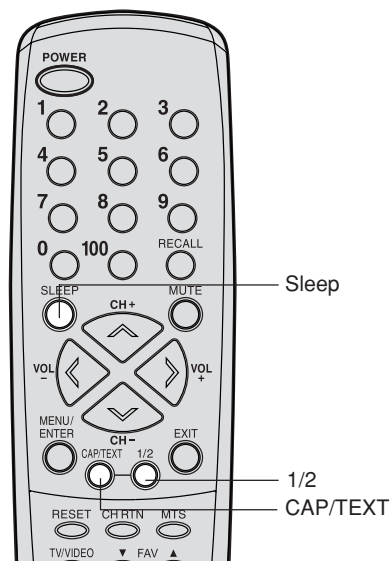

Note:

A closed caption signal may not be decoded in the following situations:

- When a video tape has been dubbed.
- When the signal reception is weak.
- When the signal reception is non-standard.

When you select the text mode, the text screen always appears as a black box. When there is no signal, however, the text screen will not display text characters. Repeatedly press CAP/TEXT until the box disappears.

NOTICE OF POSSIBLE ADVERSE EFFECTS ON TV PICTURE DISPLAY

Avoid displaying stationary images on your TV screen for extended periods of time. Fixed (non-moving) patterns or images (including but not limited to PIP/POP windows, closed captions, video game patterns, TV station logos, stock tickers, websites, and special formats that do not use the entire screen) can become permanently ingrained in the cathode ray tube(s) of the TV and cause subtle but permanent ghost images. **This type of damage is NOT COVERED BY YOUR WARRANTY.** See page 4 for details.

Adjusting the sound

Muting the sound

Press MUTE to temporarily turn off the sound. While the sound is off, the screen will display the word "MUTE" in the lower right-hand corner. To restore the sound, press MUTE again.

Selecting stereo/SAP broadcasts

You can listen to high-fidelity stereo sound with the Multi-channel TV Sound (MTS) feature. MTS can also transmit a second audio program (SAP) containing a second language or other audio information.

When the TV receives a stereo or SAP broadcast, the word STEREO or SAP appears on-screen every time the TV is turned on, the channel is changed, or the RECALL button is pressed. The MTS feature is not available in the VIDEO mode.

You can leave your TV in STEREO mode because it will automatically output stereo or monaural sound, depending on the broadcast type. If the stereo sound is noisy, select MONO to reduce the noise. The word STEREO or SAP is displayed in light blue when the TV receives the signal.

To select the desired MTS setting:

Repeatedly press the MTS button to select either STEREO, SAP, MONO+SAP, or MONO. If the current program is not available in stereo or SAP, the setting will not be available when you press the MTS button.

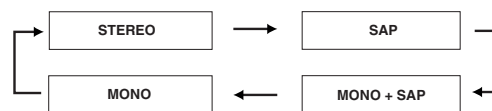
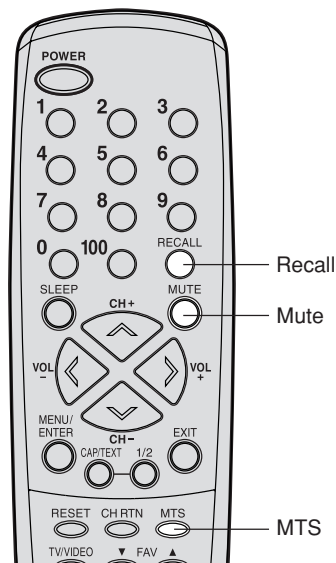

If the current program is not broadcasting either stereo or SAP, those settings will not be available when you press the MTS button.

Adjusting the sound quality

You can change the sound quality of your TV by adjusting the bass, treble, and balance.

To adjust the sound quality:

1. Press MENU, then press \leftarrow or \rightarrow until the AUDIO menu appears.

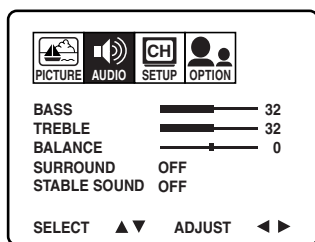

2. Press \wedge or \vee to highlight the item you want to adjust.
3. Press \leftarrow or \rightarrow to adjust the level.

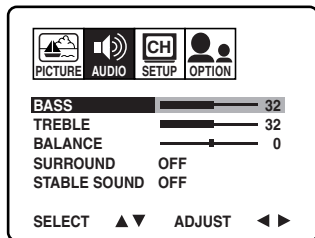

- \leftarrow makes the sound quality weaker or decreases the balance in the right channel, depending on the item selected.
- \rightarrow makes the sound quality stronger or decreases the balance in the left channel, depending on the item selected.

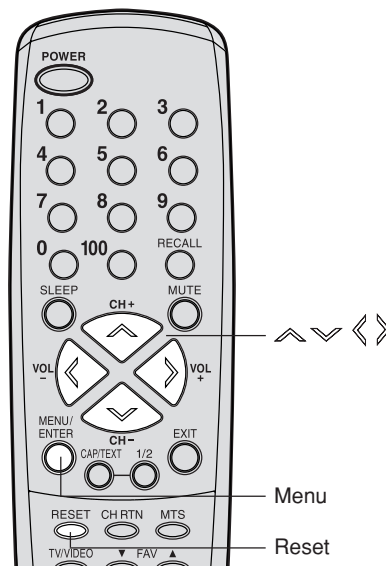

Note:

To reset your audio adjustments to the factory settings, press RESET.



Using the surround sound feature

The surround sound feature expands the audio listening field wider and deeper to create exceptional sound quality from the TV's speakers. The feature uses stereo signals from a TV broadcast or video input.

To turn on the surround sound feature:

1. Select the STEREO mode, if available (see "Selecting stereo/SAP broadcasts" on page 23.)
2. Press MENU, and then press \langle or \rangle until the AUDIO menu appears.
3. Press \wedge or \vee to highlight SURROUND.
4. Press \langle or \rangle to highlight ON.

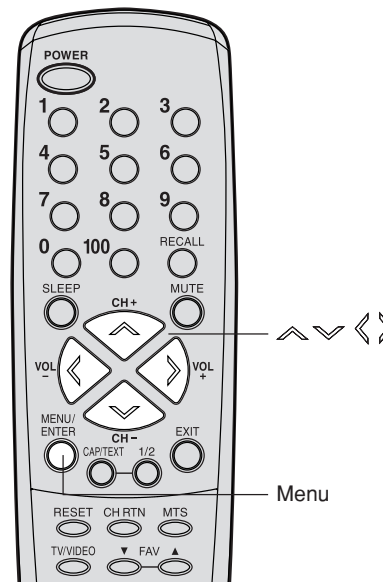
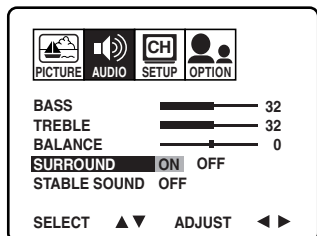

To turn off the surround sound feature:

Highlight OFF in step 4 above.

In general, you can leave your TV in surround mode because it will automatically output the type of sound being broadcast (surround stereo or monaural).

Using the StableSound® feature

The StableSound feature limits the highest volume level to prevent extreme changes in volume when the signal source is changed.

To turn on the StableSound® feature:

1. Press MENU, then press \langle or \rangle until the AUDIO menu appears.
2. Press \wedge or \vee to highlight STABLE SOUND.
3. Press \langle or \rangle to highlight ON.

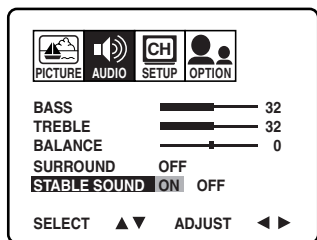

To turn off the StableSound® feature:

Highlight OFF in step 3 above.

Auto power off

The TV will automatically turn off after approximately 15 minutes if it is tuned to a vacant channel or a station that completes its broadcast for the day and stops broadcasting on that channel. This feature does not work in VIDEO mode.

Understanding the Power Return feature

If the power is cut off while you are viewing the TV and the power is resupplied, the Power Return feature will turn the TV on automatically.

If the power is going to be off for a long time or you are going to be away from the TV for a long time, unplug the power cord from the wall outlet to prevent the TV from turning on in your absence.



Appendix

Troubleshooting

Before calling a service technician, please check the following table for a possible cause of the problem and some solutions.

Problem	Solution
TV will not turn on	<ul style="list-style-type: none"> • Make sure the power cord is plugged in, then press POWER. • The remote control batteries may be dead. Replace the batteries.
No picture, no sound	<ul style="list-style-type: none"> • Check the antenna/cable connections. • This TV will not accept or display 480p or 720p progressive scan signals or 1080i interlaced high-definition signals through its ColorStream inputs. Switch the other device's output to 480i interlaced mode first (see page 9).
No sound, picture OK	<ul style="list-style-type: none"> • The sound may be muted. Press VOLUME. • The station may have broadcast difficulties. Try another channel. • The MTS feature may be in SAP mode. Press the MTS button on the remote control until STEREO (or MONO) mode is active.
Poor sound, picture OK	<ul style="list-style-type: none"> • The station may have broadcast difficulties. Try another channel. • The MTS feature may be in SAP mode. Press the MTS button on the remote control until STEREO (or MONO) mode is active.
Poor picture, sound OK	<ul style="list-style-type: none"> • Check the antenna connections. • The station may have broadcast difficulties. Try another channel. • Adjust the PICTURE menu. • This TV will not accept or display 480p or 720p progressive scan signals or 1080i interlaced high-definition signals through its ColorStream inputs. Switch the other device's output to 480i interlaced mode first (see page 9).
Poor reception of broadcast channels	<ul style="list-style-type: none"> • The station may have broadcast difficulties. Try another channel. • Check the antenna connections. • If you are using a VCR, make sure the TV/VCR button is set correctly.
Cannot receive above channel 13	<ul style="list-style-type: none"> • Make sure the TV/CABLE feature in the SETUP menu is set to "CABLE."
Unable to select a certain channel	<ul style="list-style-type: none"> • The channel may be blocked by the CH LOCK feature, or erased with the add/erase feature.
Cannot access signal input sources (Video1, Video2 and ColorStream) and/or Channels 3 and 4	<ul style="list-style-type: none"> • Check the VIDEO LOCK feature.
Multiple images	<ul style="list-style-type: none"> • The station may have broadcast difficulties. Try another channel. • Use a highly directional outdoor antenna.
Poor color or no color	<ul style="list-style-type: none"> • The station may have broadcast difficulties. Try another channel. • Adjust the TINT and/or COLOR in the PICTURE menu. • If you change the direction of the TV while it is turned on, the picture could suffer from color shading. If so, turn off the TV and allow it to cool for several hours before turning it on again.
Black box on screen	<ul style="list-style-type: none"> • Repeatedly press CAP/TEXT to turn off the Closed Caption Text mode.
No stereo or SAP sound from a known MTS broadcast	<ul style="list-style-type: none"> • Make sure the MTS feature is set properly.
The PIN code does not work	<ul style="list-style-type: none"> • Change or reset your PIN code (pages 15 and 16).
The remote control does not operate	<ul style="list-style-type: none"> • Remove all obstructions between the remote control and the TV. • The remote control batteries may be dead. Replace the batteries.

Important Safeguards

Welcome to Toshiba

Connecting your TV

Using the Remote Control

Setting up your TV

Using the TV's Features

Appendix



Specifications

- This model complies with the specifications below.
- Design and specifications are subject to change without notice.
- This model may not be compatible with features and/or specifications that may be added in the future.

Picture Tube	676 mm (27 in.) diagonal (Screen size is approximate.)
Television system	NTSC standard
Channel coverage	VHF: 2–13 UHF: 14–69 Cable TV: 4A, A-5–A-1, A-I, J–W, W+1–W+84
Power source	120V AC, 60 Hz
Power consumption	125 W
Audio power	2.5 W + 2.5 W
Speaker type	50.8 mm x 88.9 mm (2 in. x 3-1/2 in.) x 2 pcs.
Video/Audio terminals	S-VIDEO INPUT Y-INPUT: 1V (p-p), 75 ohm, negative sync. C-INPUT: 0.286V (p-p) (burst signal), 75 ohm VIDEO/AUDIO INPUT VIDEO: 1V (p-p), 75 ohm, negative sync. AUDIO: 150 mV (rms) (30% modulation equivalent, 47k ohm) ColorStream® (component video) INPUT Y : 1V (p-p), 75 ohm PR : 0.7V (p-p), 75 ohm PB : 0.7V (p-p), 75 ohm
Dimensions	Width : 650 mm (25-9/16 in.) Height : 571.5 mm (22-1/2 in.) Depth : 500.5 mm (19-11/16 in.)
Weight	80.5 lbs. (36.5 kg)
Supplied accessories	Remote control with two size "AAA" batteries



Limited Canada Warranty for 27" and All Smaller Television Models

Toshiba of Canada Limited ("TCL") makes the following limited warranties to original consumers in Canada. THESE LIMITED WARRANTIES EXTEND TO THE ORIGINAL CONSUMER PURCHASER OR ANY PERSON RECEIVING THIS TELEVISION AS A GIFT FROM THE ORIGINAL CONSUMER PURCHASER AND TO NO OTHER PURCHASER OR TRANSFEREE.

PRODUCTS PURCHASED IN CANADA AND USED ANYWHERE OUTSIDE OF CANADA, INCLUDING, WITHOUT LIMITATION, THE U.S.A. AND MEXICO, ARE NOT COVERED BY THESE WARRANTIES.

PRODUCTS PURCHASED ANYWHERE OUTSIDE OF CANADA, INCLUDING, WITHOUT LIMITATION, THE U.S.A. AND MEXICO, AND USED IN CANADA, ARE NOT COVERED BY THESE WARRANTIES.

Limited One (1) Year Warranty on Parts and Labor*

TCL warrants this television and its parts against defects in materials or workmanship for a period of one (1) year after the date of original retail purchase. DURING THIS PERIOD, TCL WILL, AT TCL'S OPTION, REPAIR OR REPLACE A DEFECTIVE PART WITH A NEW OR REFURBISHED PART WITHOUT CHARGE TO YOU FOR PARTS OR LABOR. YOU MUST DELIVER THE ENTIRE TELEVISION TO AN AUTHORIZED TCL SERVICE DEPOT. YOU MUST PAY FOR ALL TRANSPORTATION AND INSURANCE CHARGES FOR THE TELEVISION TO AND FROM THE SERVICE DEPOT.

Limited Two (2) Year Warranty on Picture Tube*

TCL further warrants the picture tube in this television against defects in materials or workmanship for a period of two (2) years after the date of original retail purchase. DURING THIS PERIOD, TCL WILL, AT TCL'S OPTION, REPAIR OR REPLACE A DEFECTIVE PICTURE TUBE WITH A NEW OR REFURBISHED PICTURE TUBE WITHOUT CHARGE TO YOU, EXCEPT THAT, IF A DEFECTIVE PICTURE TUBE IS REPAIRED OR REPLACED AFTER ONE (1) YEAR FROM THE DATE OF THE ORIGINAL RETAIL PURCHASE, YOU MUST PAY ALL LABOR CHARGES INVOLVED IN THE REPAIR OR REPLACEMENT. YOU MUST DELIVER THE ENTIRE TELEVISION TO AN AUTHORIZED TCL SERVICE DEPOT. YOU MUST PAY FOR ALL TRANSPORTATION AND INSURANCE CHARGES FOR THE TELEVISION TO AND FROM THE SERVICE DEPOT.

Rental Units

The warranty for rental units begins with the first rental or thirty (30) days from the date of shipment to the rental firm, whichever comes first.

*Limited Warranty for Commercial Units

TCL warrants televisions sold and used for commercial purposes as follows: all parts are warranted against defects in materials or workmanship for a period of ninety (90) days after the date of original purchase. DURING THIS PERIOD, TCL WILL, AT TCL'S OPTION, REPAIR OR REPLACE A DEFECTIVE PART WITH A NEW OR REFURBISHED PART WITHOUT CHARGE TO YOU FOR PARTS OR LABOR. YOU MUST DELIVER THE ENTIRE TELEVISION TO AN AUTHORIZED TCL SERVICE DEPOT. YOU MUST PAY FOR ALL TRANSPORTATION AND INSURANCE CHARGES FOR THE TELEVISION TO AND FROM THE SERVICE DEPOT.

Owner's Manual and Product Registration

Read this owner's manual thoroughly before operating this television. Register your product online at www.toshiba.ca as soon as possible. By registering your product, you will enable TCL to bring you new products specifically designed to meet your needs and help us to contact you in the unlikely event a safety notification is required. Failure to register your product does not diminish your warranty rights.

Your Responsibility

THE ABOVE WARRANTIES ARE SUBJECT TO THE FOLLOWING CONDITIONS:

- (1) You must provide your bill of sale or other proof of purchase.
- (2) All warranty servicing of this television must be performed by an Authorized TCL Service Depot.
- (3) These warranties from TCL are effective only if the television is purchased in Canada from an authorized TCL dealer and operated in Canada.
- (4) Labor charges for installation, setup, adjustment of customer controls, and installation or repair of antenna systems are not covered by these warranties. Reception problems caused by inadequate antenna systems are your responsibility.
- (5) Warranties extend only to defects in materials or workmanship as limited above and do not extend to any television or parts that have been lost or discarded by you or to damage to any television or parts caused by fires, misuse, accident, Acts of God (such as lightning or fluctuations in electric power), improper installation, improper maintenance, or use in violation of instructions furnished by TCL; or to units that have been modified or had the serial number removed, altered, defaced, or rendered illegible.

How to Obtain Warranty Services

If, after following all of the operating instructions in this manual and checking the "Troubleshooting" section, you find that service is needed:

- (1) To find the nearest TCL Authorized Service Depot, visit TCL's web site at www.toshiba.ca.
- (2) Present your bill of sale or other proof of purchase to the Authorized Service Depot. You must deliver the entire television to an Authorized TCL Service Depot. You must pay for all transportation and insurance charges for the television to and from the Service Depot.

**For additional information,
visit TCL's web site: www.toshiba.ca**

ALL WARRANTIES IMPLIED BY THE LAW OF ANY PROVINCE OF CANADA, INCLUDING THE IMPLIED WARRANTIES OF MERCHANTABILITY AND FITNESS FOR A PARTICULAR PURPOSE, ARE EXPRESSLY LIMITED TO THE DURATION OF THE LIMITED WARRANTIES SET FORTH ABOVE. WITH THE EXCEPTION OF ANY WARRANTIES IMPLIED BY THE LAW OF ANY PROVINCE OF CANADA AS HEREBY LIMITED, THE FOREGOING WARRANTY IS EXCLUSIVE AND IN LIEU OF ALL OTHER WARRANTIES, GUARANTEES, AGREEMENTS, AND SIMILAR OBLIGATIONS OF TCL WITH RESPECT TO THE REPAIR OR REPLACEMENT OF ANY PARTS. IN NO EVENT SHALL TCL BE LIABLE FOR CONSEQUENTIAL OR INCIDENTAL DAMAGES (INCLUDING, BUT NOT LIMITED TO, LOST PROFITS, BUSINESS INTERRUPTION, OR MODIFICATION OR ERASURE OF RECORDED DATA CAUSED BY USE, MISUSE, OR INABILITY TO USE THIS PRODUCT).

No person, agent, distributor, dealer, or company is authorized to change, modify, or extend the terms of these warranties in any manner whatsoever. The time within which action must be commenced to enforce any obligation of TCL arising under this warranty or under any law of Canada or of any province thereof is hereby limited to 90 days from the date you discover, or should have discovered, the defect. This limitation does not apply to implied warranties arising under the law of any province of Canada.

THIS WARRANTY GIVES YOU SPECIFIC LEGAL RIGHTS, AND YOU MAY ALSO HAVE OTHER RIGHTS, WHICH MAY VARY FROM PROVINCE TO PROVINCE IN CANADA. SOME PROVINCES OF CANADA DO NOT ALLOW LIMITATIONS ON HOW LONG AN IMPLIED WARRANTY LASTS, WHEN AN ACTION MAY BE BROUGHT, OR THE EXCLUSION OR LIMITATION OF INCIDENTAL OR CONSEQUENTIAL DAMAGES, SO THE ABOVE LIMITATIONS OR EXCLUSIONS MAY NOT APPLY TO YOU UNDER SUCH CIRCUMSTANCES.

Important
Safeguards

Welcome to
Toshiba

Connecting
your TV

Using the
Remote Control

Setting up
your TV

Using the TV's
Features

Appendix



TOSHIBA OF CANADA LIMITED

191 McNabb Street
Markham, Ontario L3R 8H2
TEL.: (905) 470-5400

Service Centers:

TORONTO: 191 McNABB STREET,
MARKHAM, ONTARIO, L3R 8H2, CANADA
TEL.: (905) 470-5400

MONTREAL: 18050 TRANS CANADA, KIRKLAND,
QUEBEC, H9J-4A1, CANADA
TEL.: (514) 390-7766

VANCOUVER: 22171 FRASERWOOD WAY,
RICHMOND, B.C., V62 1J5, CANADA
TEL.: (604) 303-2500

ColorStream® and StableSound® are registered trademarks of Toshiba America Consumer Products, L.L.C.
GameTimer is a trademark of Toshiba America Consumer Products, L.L.C.

PRINTED IN THAILAND

TOSHIBA