

SONY®



Table of
contents

Operation
Search

MENU/Settings
Search

Index

Cyber-shot

Cyber-shot Handbook

DSC-W560

How to use this handbook

Click on a button at upper right to jump to the corresponding page.
This is convenient when searching for a function you want to view.



← Search for information by function.

← Search for information by operation.

← Search for information in a listing of MENU/Settings items.

← Search for information by keyword.

Table of contents

Operation Search

MENU/Settings Search

Index

Marks and notations used in this handbook

In this handbook, the sequence of operations is shown by arrows (→). Operate the camera in the order indicated. Marks are shown as they appear in the camera's default setting.

Red Eye Reduction

The flash strobos two or more times before shooting to reduce the red-eye phenomenon when using the flash.

- 1 Set the camera to shooting mode.
- 2 MENU → (Settings) → (Shooting Settings) → [Red Eye Reduction] → desired mode → ● on the control button

<input checked="" type="checkbox"/>	Auto	When the Face Detection function is activated, the flash strobos automatically to reduce the red-eye phenomenon.
<input type="checkbox"/>	On	The flash always strobos to reduce the red-eye phenomenon.
<input type="checkbox"/>	Off	Does not use Red Eye Reduction.

Notes

- To avoid blurring of images, hold the camera firmly until the shutter is released. It usually takes a second until the shutter is released, and also be sure not to allow the subject to move during this period.
- Red Eye Reduction may not produce the desired effects. It depends on individual differences and conditions, such as distance to the subject, or if the subject looked away from the pre-strobe.
- If you do not use the Face Detection function, Red Eye Reduction does not work, even when you select [Auto].
- [Red Eye Reduction] is set to [Off] in the following situations:
 - When (High Sensitivity) mode is selected in Scene Selection.
 - When the Smile Shutter function is activated.

What causes the red-eye phenomenon?

Pupils become dilated in dark environments. Flash light is reflected off the blood vessels at the back of the eye (retina), causing the "red-eye" phenomenon.

Other ways to reduce red-eye

- Select (High Sensitivity) mode in Scene Selection. (The flash is set to [Off] automatically.)
- When the eyes of the subject turn out red, correct the image with [Retouch] → [Red Eye Correction] on the viewing menu or with the supplied software "PMB".

The default setting is indicated by .

Indicates cautions and limitations relevant to the correct operation of the camera.

Indicates information that is useful to know.

Notes on using the camera

Notes on the types of memory card that you can use (sold separately)

The following memory cards are compatible with this camera: “Memory Stick PRO Duo” media, “Memory Stick PRO-HG Duo” media, “Memory Stick Duo” media, SD memory cards, SDHC memory cards and SDXC memory cards.

MultiMediaCard is not compatible.

In this Handbook, “Memory Stick PRO Duo” media, “Memory Stick PRO-HG Duo” media and “Memory Stick Duo” media are called “Memory Stick Duo” media and SD memory cards, SDHC memory cards and SDXC memory cards are called SD memory cards.

- “Memory Stick Duo” media of up to 32 GB and SD memory cards of up to 64 GB have been tested and proven to operate with your camera.

When recording movies, it is recommended that you use the following memory cards:

- MEMORY STICK PRO DUO (Mark2) (“Memory Stick PRO Duo” (Mark2) media)
- MEMORY STICK PRO-HG DUO (“Memory Stick PRO-HG Duo” media)
- SD memory card, SDHC memory card or SDXC memory card (Class 4 or faster)

For details on “Memory Stick Duo” media, see page 128.

When using a “Memory Stick Duo” media with standard sized “Memory Stick” media slot

You can use the “Memory Stick Duo” media by inserting it into the “Memory Stick Duo” media Adaptor (sold separately).



“Memory Stick Duo” media Adaptor

Notes on the battery pack

- Charge the battery pack (supplied) before using the camera for the first time.
- You can charge the battery pack even if it is not completely discharged. In addition, even if the battery pack is not fully charged, you can use the partially charged capacity of the battery pack as is.

- If you do not intend to use the battery pack for a long time, use up the existing charge and remove it from the camera, then store it in a cool, dry place. This is to maintain the battery pack functions.
- For details on the usable battery pack, see page 130.

Notes on the LCD screen and lens

- The LCD screen is manufactured using extremely high-precision technology so over 99.99% of the pixels are operational for effective use. However, some tiny black and/or bright dots (white, red, blue or green) may appear on the LCD screen. These dots are a normal result of the manufacturing process and do not affect the recording.

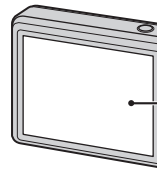

Black, white, red, blue or green dots

- Exposing the LCD screen or the lens to direct sunlight for long periods may cause malfunctions. Be careful when placing the camera near a window or outdoors.
- Do not press against the LCD screen. The screen may be discolored and that may cause a malfunction.
- Images may trail across on the LCD screen in a cold location. This is not a malfunction.
- Be careful not to bump the movable lens, and be careful not to apply force to it.

On moisture condensation

- If the camera is brought directly from a cold to a warm location, moisture may condense inside or outside the camera. This moisture condensation may cause a malfunction of the camera.
- If moisture condensation occurs, turn off the camera and wait about an hour for the moisture to evaporate. Note that if you attempt to shoot with moisture remaining inside the lens, you will be unable to record clear images.

The images used in this Handbook

The images used as examples in this Handbook are reproduced images, and are not actual images shot using this camera.

Table of contents

Notes on using the camera

How to use this handbook	2
Notes on using the camera	3
Operation Search	7
MENU/Settings Search	10
Identifying parts	15
List of icons displayed on the screen	16
Using the internal memory	18
In-Camera Guide	19

Shooting

Using the mode switch	20
Intelligent Auto	21
Easy Mode	22
Program Auto	23
Sweep Panorama	24
Scene Selection	26
Movie Mode	28
Zoom	29
DISP (Screen Display Settings)	30
Flash	31
Smile Shutter	32
Self-Timer	33

Viewing

Viewing still images	34
Playback Zoom	35
Image Index	36
Delete	37
Viewing movies	38

MENU (Shooting)

MENU items (Shooting)	10
-----------------------------	----

MENU (Viewing)

MENU items (Viewing)	12
----------------------------	----

Settings

Setting items	13
---------------------	----

TV

Viewing images on a TV	105
------------------------------	-----

Computer

Using with your computer	108
Using the software	109
Connecting the camera to the computer	111
Uploading images to a media service	113

Printing

Printing still images	115
-----------------------------	-----

Troubleshooting

Troubleshooting	116
Warning indicators and messages	123

Others

Using the camera abroad.....	127
Memory card	128
Battery pack	130
Battery charger.....	131
Intelligent Pantiler.....	132
Number of still images and recordable time of movies.....	133
Precautions	135
Trademarks	137

Index

Index	138
-------------	-----

Operation Search

Table of
contents

Operation
Search

MENU/Settings
Search

Index

Leaving the settings to the camera	Intelligent Auto.....	21
	Scene Selection.....	26
	Scene Recognition.....	55
Shooting movies	Movie Mode.....	28
Shooting portraits	Soft Skin.....	26
	Soft Snap.....	26
	Twilight Portrait.....	26
	Smile Shutter.....	32
	Scene Recognition.....	55
	Face Detection.....	59
	Anti Blink.....	62
Red Eye Reduction.....	80	
Shooting panoramic images	Sweep Panorama.....	24
Shooting best shots of your pet	Pet.....	26
Shooting moving objects	Movie Mode.....	28
	Burst Settings.....	46
Shooting without blur	High Sensitivity.....	26
	2-second delay self-timer.....	33
	ISO.....	48
Shooting with backlight	Forced Flash.....	31
	Scene Recognition.....	55
	DRO.....	61

Shooting in dark places	High Sensitivity.....	26
	Slow Synchro.....	31
	ISO.....	48
Adjusting exposure	EV	47
Changing focus position	Focus	52
	Selecting the priority face (Tracking focus)	60
Changing image size	Image Size/Panorama Image Size.....	43
Changing screen display	DISP (Screen Display Settings)	30
	Function Guide.....	84
Deleting images	Delete.....	37, 70
	Format	97
Displaying enlarged images	Playback Zoom	35
	Trimming (Resize).....	69
Editing images	Retouch	69
Playing back a series of images in order	Slideshow	65
Shooting/Viewing with easy-to-see indicators	Easy Mode	22, 64
Printing images with the date	Using the “PMB (Picture Motion Browser)”	109
Changing date and time settings	Area Setting	103
	Date & Time Setting.....	104
Initializing settings	Initialize.....	87

In-Camera Guide	In-Camera Guide	19, 63
Printing images	Printing still images	115
Viewing on TVs	Viewing images on a TV	105

Table of contents

Operation Search

MENU/Settings Search

Index

MENU/Settings Search

MENU items (Shooting)





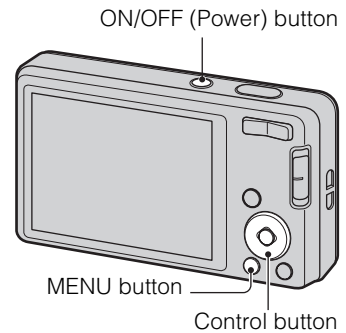









You can select the various shooting functions easily from the MENU button.

- 1 Press the ON/OFF (Power) button and set the camera to shooting mode.
- 2 Press the MENU button to display the Menu screen.
- 3 Select the desired menu item with ▲/▼/◀/▶ on the control button.
- 4 Press the MENU button to turn off the Menu screen.



In the table below, ✓ indicates a user-changeable function, while — indicates an unchangeable one. The icons below SCN indicate the changeable modes. Depending on the recording mode, function settings may be fixed or limited. For details, see the page of each item.

Mode switch	📷			📺		🎞️	
REC Mode	i📷	P	SCN	📺	📹	🎞️	🎞️📹
Menu items							
REC Mode	✓	✓	✓	—	—	—	—
Scene Selection	—	—	✓	—	—	—	—
Easy Mode	✓	✓	✓	—	—	—	—
Movie shooting scene	—	—	—	—	—	✓	✓
Panorama Shooting Scene	—	—	—	✓	✓	—	—
Shooting Direction	—	—	—	✓	✓	—	—
Image Size/Panorama Image Size	✓	✓	✓	✓	✓	✓	✓
Burst Settings	✓	✓	📷👤📷📷📷📷📷	—	—	—	—
EV	✓	✓	✓	✓	✓	✓	✓
ISO	—	✓	📷	—	—	—	—
White Balance	—	✓	ISO 📷 🐱	✓	—	✓	—
Underwater White Balance	—	—	🐟	—	✓	—	✓
Focus	—	✓	—	✓	✓	—	—
Metering Mode	—	✓	—	✓	✓	✓	✓
Scene Recognition	✓	—	—	—	—	—	—
Soft Skin Effect	—	—	📷👤👤👤	—	—	—	—
Smile Detection Sensitivity	✓	✓	📷👤👤👤 ISO 📷📷📷	—	—	—	—
Face Detection	✓	✓	📷👤👤👤 ISO 📷📷📷	—	—	—	—
DRO	—	✓	—	—	—	—	—
Anti Blink	—	—	📷👤	—	—	—	—

Mode switch							
REC Mode		P	SCN				
Menu items		P	SCN				
In-Camera Guide	✓	✓	✓	✓	✓	✓	✓
 (Settings)	✓	✓	✓	✓	✓	✓	✓







Note

- Only the items that are available for each mode are displayed on the screen.

- Table of contents
- Operation Search
- MENU/Settings Search
- Index







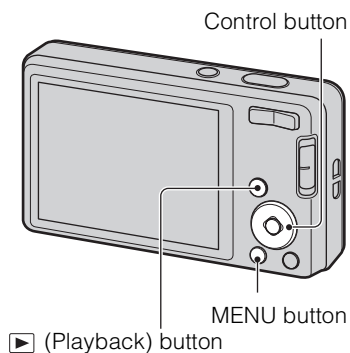



MENU items (Viewing)

You can select the various viewing functions easily from the MENU button.

- 1 Press the  (Playback) button to switch to playback mode.
- 2 Press the MENU button to display the Menu screen.
- 3 Select the desired menu item with  on the control button.
- 4 Press  on the center of the control button.



In the table below, ✓ indicates a user-changeable function, while — indicates an unchangeable one.









View Mode \ Menu items	Memory card			Internal Memory
	 Date View	 Folder view (Still)	 Folder view (Movie)	Folder View
EASY (Easy Mode)	✓	✓	✓	✓
 (Slideshow)	✓	✓	—	✓
 (View Mode)	✓	✓	✓	—
 (Retouch)	✓	✓	—	✓
 (Delete)	✓	✓	✓	✓
 (Protect)	✓	✓	✓	✓
DPOF	✓	✓	—	—
 (Rotate)	✓	✓	—	✓
 (Select Folder)	—	✓	✓	—
? (In-Camera Guide)	✓	✓	✓	✓
 (Settings)	✓	✓	✓	✓

Note



- Only the items that are available for each mode are displayed on the screen.

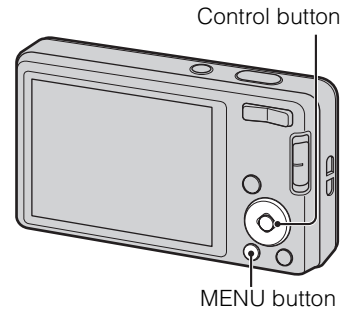

Setting items

You can change the settings on the  (Settings) screen.

- 1 Press the MENU button to display the Menu screen.
- 2 Select  (Settings) with  on the control button, then press  on the center of the control button to display the setup screen.
- 3 Select the desired category with /, then press  to select each item, then .
- 4 Select the desired setting, then press .



Categories	Items
 Shooting Settings	AF Illuminator
	Grid Line
	Disp. Resolution
	Digital Zoom
	Auto Orientation
	Red Eye Reduction
	Blink Alert
 Main Settings	Beep
	Language Setting
	Function Guide
	Display color
	Demo Mode
	Initialize
	COMPONENT
	Video Out
	USB Connect
	LUN Setting
	Download Music
	Empty Music
	Power Save
	Eye-Fi*
 Memory Card Tool	Format
	Create REC. Folder
	Change REC. Folder
	Delete REC. Folder
	Copy
	File Number

Categories	Items
 Internal Memory Tool	Format
	File Number
 Clock Settings	Area Setting
	Date & Time Setting

* [Eye-Fi] appears only when an Eye-Fi card (commercially available) is inserted in the camera.

Notes

- [Shooting Settings] appears only when settings have been entered from shooting mode.
- [Memory Card Tool] appears only when a memory card is inserted in the camera, while [Internal Memory Tool] appears only when a memory card is not inserted.

Identifying parts

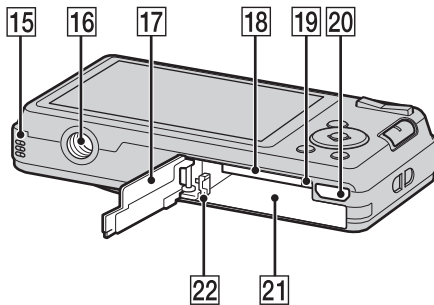
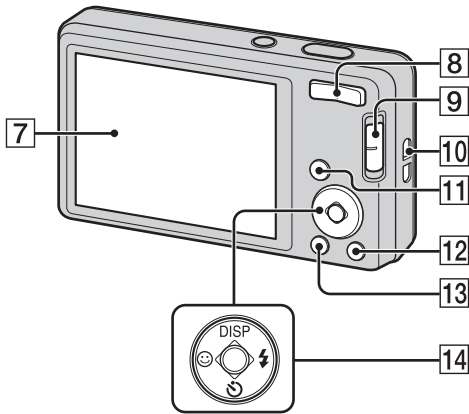
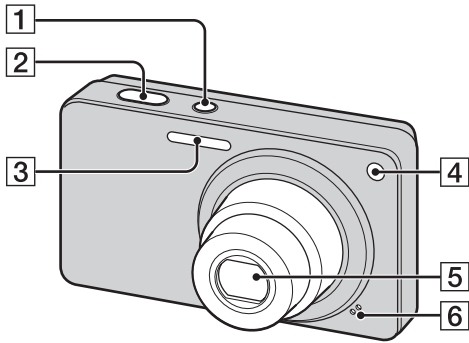

- 1 ON/OFF (Power) button
- 2 Shutter button
- 3 Flash
- 4 Self-timer lamp/Smile Shutter lamp/
AF illuminator
- 5 Lens
- 6 Microphone
- 7 LCD screen
- 8 For shooting: W/T (zoom) button (29)
For viewing: Q (Playback Zoom) button/
■ (Index) button (35, 36)
- 9 Mode switch (20)

- 10 Hook for wrist strap*
- 11 ▶ (Playback) button (34)
- 12 ?/⏏ (In-Camera Guide/Delete) button
(19, 37)
- 13 MENU button (10)
- 14 Control button
Menu on: ▲/▼/◀/▶/●
Menu off: DISP/☺/☹/⚡
- 15 Speaker
- 16 Tripod receptacle
- 17 Battery/Memory card cover
- 18 Memory card slot
- 19 Access lamp
- 20 Multi connector (Type3a)
- 21 Battery insertion slot
- 22 Battery eject lever

* Using the wrist strap

Attach the strap and place your hand through the loop to prevent the camera from being dropped.

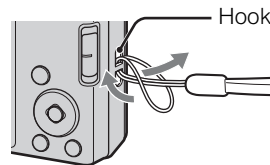

List of icons displayed on the screen

Icons are displayed on the screen to indicate the camera status.

You can change the screen display using DISP (Screen Display Settings) on the control button.

When shooting still images

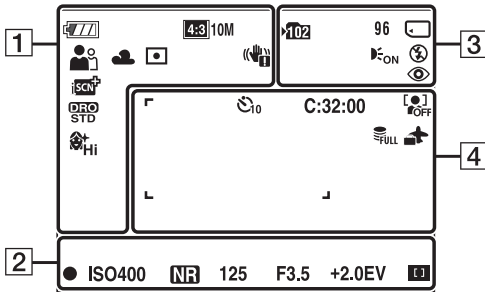

When shooting movies

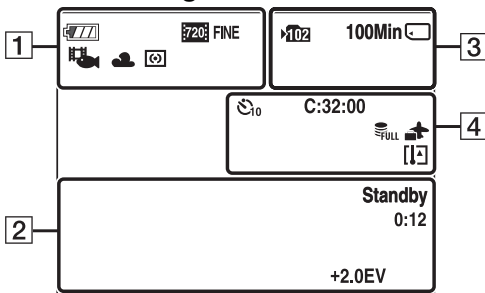

When playing back

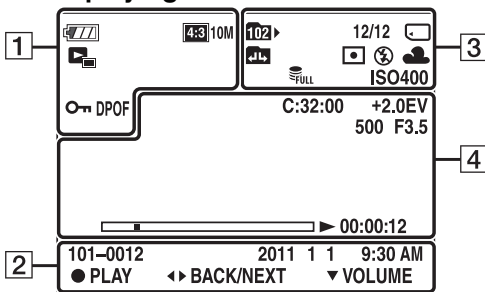

1

Display	Indication
	Battery remaining
	Low battery warning
	Image Size/Panorama Image Size
	Scene Selection
	Shooting mode (Intelligent Auto/Program Auto/Sweep Panorama)
	Movie shooting scene
	Panorama Shooting Scene
	Scene Recognition icon
	White Balance
	Metering Mode
	Vibration warning
	Anti Blink
	Scene Recognition
	Burst Settings
	DRO
	Soft Skin Effect
	Smile Detection Sensitivity indicator

Display	Indication
x1.4 s Q P Q	Zoom scaling
	Protect
DPOF	Print order (DPOF)
Qx2.0	Playback Zoom
	View Mode

2

Display	Indication
	AE/AF lock
ISO400	ISO number
NR	NR slow shutter
125	Shutter speed
F3.5	Aperture value
+2.0EV	Exposure Value
	AF range finder frame indicator
REC Standby	Recording a movie/Standby a movie
0:12	Recording time (m:s)
101-0012	Folder-file number
2011 1 1 9:30 AM	Recorded date/time of the playback image
STOP PLAY	Function guide for playing image
	Selecting images
	Adjusting volume

3

Display	Indication
	Recording folder
	Playback folder
96	Number of recordable images
12/12	Image number/Number of images recorded in date range, selected folder
100Min	Recordable time
	Recording/Playback Media (Memory card/Internal memory)
	Eye-Fi Mode display
	Changing folder
	AF Illuminator
	Red-eye reduction
	Metering Mode
	Flash mode

Display	Indication
	Flash charging
AWB	White Balance
ISO 400	ISO number
	Database file full/Database file error

4

Display	Indication
	Self-timer
C:32:00	Self-diagnosis display
	Face Detection
	Database file full/Database file error
	Destination
	Overheating warning
	AF range finder frame
	Spot metering cross hair
+2.0EV	Exposure value
500	Shutter speed
F3.5	Aperture value
	Playback
	Playback bar
00:00:12	Counter
	Volume

Using the internal memory

The camera has approximately 27 MB of internal memory. This memory is not removable. You can record images on the internal memory when there is no memory card inserted in the camera.

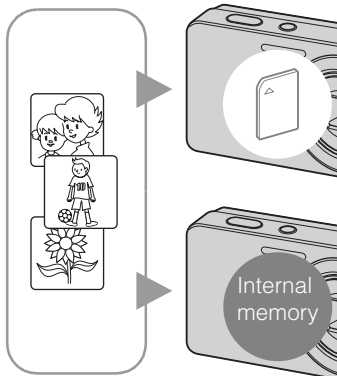

When a memory card is inserted

- [Recording]:** Images are recorded on the memory card.
- [Playback]:** Images on the memory card are played back.
- [Menu, Settings, etc.]:** Various functions can be performed on images on the memory card.

When there is no memory card inserted

- [Recording]:** Images are recorded using the internal memory.
 - You cannot record movies to the internal memory when the movie image size is [1280×720(Fine)] or [1280×720(Standard)].
- [Playback]:** Images stored in the internal memory are played back.
- [Menu, Settings, etc.]:** Various functions can be performed on images in the internal memory.

On image data stored in the internal memory

We recommend that you copy (back up) data without error using one of the following methods.

To copy (back up) data on a hard disk of your computer

Perform the procedure on page 111 without a memory card inserted in the camera.

To copy (back up) data on a memory card

Prepare a memory card with sufficient free capacity, then perform the procedure explained in [Copy] (page 101).

Notes

- You cannot transfer image data on a memory card to the internal memory.
- By making a USB connection between the camera and a computer with a cable for multi-use terminal, you can transfer data stored in the internal memory to a computer. However you cannot transfer data on a computer to the internal memory.

In-Camera Guide

This camera contains an internal function guide. This allows you to search the camera's functions according to your needs.

You can use the selected function after reading the guide.

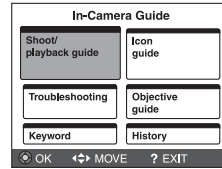
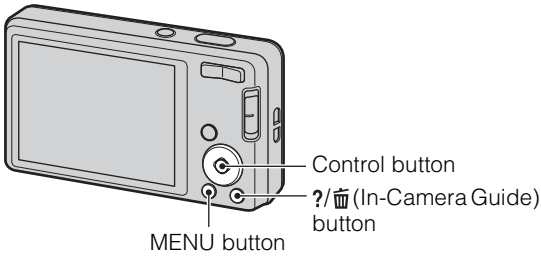

An operation guide is displayed so that you can operate the camera following the instructions on the screen.

1 Push the ?/In-Camera Guide button.

When shooting images: [In-Camera Guide] search methods are displayed.

When viewing images: [Delete/In-Camera Guide] is displayed.

Select [In-Camera Guide].

2 Select a search method.

This is explained in [Shoot/playback guide].

3 Select the desired mode.

Functions available in the selected function is displayed.

4 Select the desired function, then press ● on the control button.

The operation guide for the selected function is displayed.

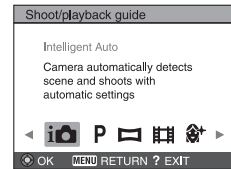

5 Use ◀▶ to switch the display from summary to operation to details.

- The operation guide and details may not be displayed, depending on the selected function.
- When you select [Use this function], the camera switches to the selected mode automatically.

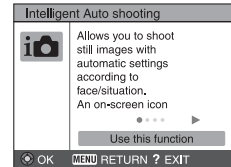

Search method	Description
Shoot/playback guide	Search for various operation functions in shooting/viewing mode.
Icon guide	Search the function and meaning of displayed icons.
Troubleshooting	Search common problems and their solution.
Objective guide	Search functions according to your needs.
Keyword	Search functions by key words.
History	Display the last 12 items displayed in [In-Camera Guide].



Notes

- When recording movies and shooting panoramic images, the ?/In-Camera Guide button is not available.
- [Use this function] may not be available, depending on the selected functions.

Using the mode switch

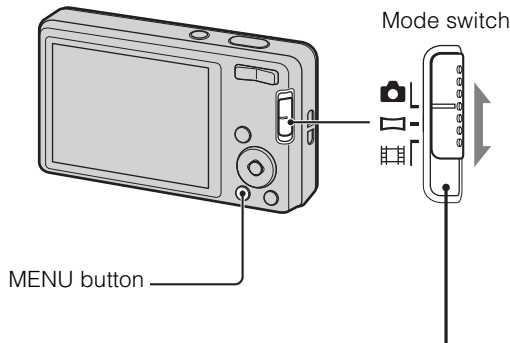
Sets the mode switch to the desired function.



 (Still Image)	Allows you to shoot still images (page 21, 23, 26). MENU → [REC Mode] → desired mode.
 (Sweep Panorama)	Allows you to shoot a panoramic image after composing images (page 24).
 (Movie)	Allows you to record movies (page 28).

Intelligent Auto

Allows you to shoot still images with the setting adjusted automatically.

- 1 Set the mode switch to  (Still Image).
- 2 MENU →  (REC Mode) →  (Intelligent Auto) → ● on the control button
- 3 Shoot with the shutter button.

Note









- Flash mode is set to [Auto] or [Off].

On Scene Recognition

Scene Recognition operates in Intelligent Auto mode. This function lets the camera automatically recognize the shooting conditions and shoot the image.



Scene Recognition icon and guide

The camera recognizes  (Twilight),  (Twilight Portrait),  (Twilight using a tripod),  (Backlight),  (Backlight Portrait),  (Landscape),  (Macro) or  (Portrait), and displays the corresponding icon and guide on the LCD screen when the scene is recognized. For details, see page 55.

If you shoot a still image of a subject that is difficult to focus on

- The shortest shooting distance is approximately 4 cm (1 5/8 inches) (W)/60 cm (23 5/8 inches) (T) (from the lens).
- When the camera cannot focus on the subject automatically, the AE/AF lock indicator changes to slowly flashing and the beep does not sound. Either recompose the shot or change the focus setting (page 52).
- Focusing may be difficult in the following situations:
 - It is dark and the subject is distant.
 - The contrast between the subject and the background is poor.
 - The subject is seen through glass.
 - The subject is moving quickly.
 - There is reflective light or shiny surfaces.
 - The subject is backlit or there is a flashing light.

Easy Mode



Allows you to shoot still images using the minimum necessary functions.
The text size increases and indicators become easier to see.

- 1 Set the mode switch to  (Still Image).
- 2 MENU → **EASY** (Easy Mode) → [OK] → ● on the control button
- 3 Shoot with the shutter button.

Notes

- The battery charge is used up more quickly because the screen brightness increases automatically.
- When the  (Playback) button is pressed, the playback mode also changes to [Easy Mode].

Functions available in Easy Mode (Shooting)









- Image Size:** MENU → [Image Size] → ● on the control button → desired mode → ●
Select between [Large] or [Small] size.
- Self-Timer:**  on the control button → desired mode
Select between [10sec] or [Off] mode.
- Flash:**  on the control button → desired mode
Select between [Auto] or [Off] mode.
- Smile Shutter:**  on the control button
- Exit Easy Mode:** MENU → [Exit Easy Mode] → [OK] → ●

On Scene Recognition

Scene Recognition operates in Easy Mode. This function lets the camera automatically recognize the shooting conditions and shoot the image.





Scene Recognition icon

The camera recognizes  (Twilight),  (Twilight Portrait),  (Twilight using a tripod),  (Backlight),  (Backlight Portrait),  (Landscape),  (Macro) or  (Portrait), and displays an icon on the LCD screen when the scene is recognized.

For details, see page 55.

Program Auto

Allows you to shoot with the exposure adjusted automatically (both the shutter speed and the aperture value). Also you can select various settings using the menu.

- 1 Set the mode switch to  (Still Image).
- 2 MENU →  (REC Mode) → P (Program Auto) → ● on the control button
- 3 Shoot with the shutter button.

Sweep Panorama

Allows you to create a panoramic image from composed images.



- 1 Set the mode switch to  (Sweep Panorama).
- 2 Point the camera at the edge of the subject, then press the shutter button fully down.



This part will not be taken

- 3 Pan the camera to the end, following the guidance on the LCD screen.



Notes

- If you cannot pan the camera across the entire subject within the given time, a gray area occurs in the composed image. If this happens, move the camera fast to record a full panoramic image.
- Since several images are stitched together, the stitched part will not be recorded smoothly.
- Under low light conditions, panoramic images may be blurred, or the shooting may not be successful.
- Under lights that flicker such as fluorescent light, the brightness or color of the combined image is not always the same.
- When the whole angle of panoramic shooting and the angle in which you fixed the focus and exposure with AE/AF lock are extremely different in brightness, color and focus, the shooting will not be successful. If this happens, change the lock angle and shoot again.
- Sweep Panorama is not suitable for the following situations:
 - Objects are moving
 - Objects are too close to the camera
 - Image with a repeating pattern such as tiles and image with little contrast such as sky, sandy beach, or lawn
 - Image with constant change such as waves or water falls
- You cannot create panoramic images in the following situations:
 - You pan the camera too fast or too slow
 - There is too much camera shake

💡 Changing the shooting direction or image size of a panoramic image

Shooting Direction: MENU → [Shooting Direction] → select [Right], [Left], [Up] and [Down] → ●

Panorama Image Size: MENU → [Panorama Image Size] → select [Standard] or [Wide] → ●

💡 Tips for shooting a panoramic image

Pan the camera in an arc with a constant velocity and in the same direction as the indication on the LCD screen. Sweep Panorama is better suited for still subjects, rather than moving ones.

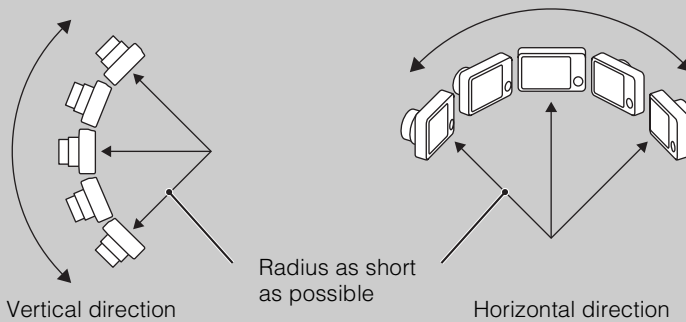

- First, press the shutter button halfway so that you can lock the focus, exposure and white balance. Then, press the shutter button fully down and pan or tilt the camera.
- If a section with greatly varied shapes or scenery is concentrated along a screen edge, the image composition may fail. In such case, adjust the frame composition so that the section is in the center of the image, then shoot again.

💡 Playing back scrolling panoramic images

You can scroll panoramic images by pressing ● on the control button while panoramic images are being displayed. Press the W (zoom) button to display the whole image again.





Shows the displayed area of the whole panoramic image

Operation button	Description
●	Plays back scrolling images/Stops
◀/▶/▲/▼	Scrolls images
W	Displays the whole image





- Panoramic images are played back with the supplied software “PMB” (page 109).
- Panoramic images shot with other cameras may not be scrolled correctly.

Scene Selection



Allows you to shoot with preset settings according to the scene.

- 1 Set the mode switch to  (Still Image).
- 2 MENU →  (REC Mode) → SCN (Scene Selection) → ● on the control button → desired mode

 (Soft Skin)	Allows you to shoot faces for smoothness.	
 (Soft Snap)	Allows you to shoot images with a softer atmosphere for portraits and flowers, etc.	
 (Landscape)	Allows easy shooting of distant scenes by focusing in the distance. Shoots vivid blue sky and flora colors.	
 (Twilight Portrait)	Allows you to shoot sharp images of people with the night view in the background without compromising the atmosphere.	
 (Twilight)	Allows you to shoot night scenes at far distance without losing the dark atmosphere of the surroundings.	
 (High Sensitivity)	Allows you to shoot images without a flash under low light conditions, reducing blur.	
 (Gourmet)	Shifts to Macro mode, allowing you to shoot food arrangements in delicious and bright color.	
 (Pet)	Allows you to shoot images of your pet with the best settings.	
 (Beach)	Allows you to record the blue of the water clearly when shooting seaside or lakeside scenes.	

 (Snow)	Allows you to record clear images preventing sunken colors in snowy scenes or other places where the whole screen appears white.	
 (Underwater)	Allows you to shoot underwater in natural colors in housing (Marine pack, etc.).	































Note

- When you shoot images using  (Twilight Portrait) or  (Twilight) mode, the shutter speed is slower and the images tend to blur. To prevent blurring, the use of a tripod is recommended.

Functions you can use in Scene Selection

For shooting an image appropriately according to the scene condition, a combination of functions is determined by the camera. In the table below, ✓ indicates a user-changeable function, while — indicates an unchangeable one.

For “Flash” and “Self-Timer,” the icons indicate modes that are available. Some functions are not available, depending on the Scene Selection mode.

											
Flash	✓	✓									
Self-Timer	✓	✓	 	✓	 	✓	 	 	✓	✓	 
Face Detection/Smile Shutter	✓* ¹	✓* ¹	—	✓	—	✓	—	—	✓	✓	—
Burst Settings	✓	✓	✓	—	—	—	—	—	✓	✓	✓
White Balance	—	—	—	—	—	✓* ²	✓	✓	—	—	✓* ³
Soft Skin Effect	✓* ⁴	✓	—	✓	—	—	—	—	—	—	—
Anti Blink	✓	✓	—	—	—	—	—	—	—	—	—

*¹ [Off] for [Face Detection] cannot be selected.

*² [Flash] for [White Balance] cannot be selected.

*³ You can use [Underwater White Balance] instead of [White Balance].

*⁴ [Off] for [Soft Skin Effect] cannot be selected.

Movie Mode

Allows you to record movies with audio.

- 1 Set the mode switch to  (Movie).
- 2 Press the shutter button fully down.
- 3 To stop recording, press the shutter button fully down again.

Zoom

You can enlarge the image when shooting. The camera's optical zoom function can enlarge images up to 4x.

1 Press the W/T (zoom) button.

Press the T button to zoom in, and the W button to zoom out.

- When the zoom scale exceeds 4x, see page 78.

T button



W button











Notes

- Zoom is fixed to the W side when shooting in Sweep Panorama mode.
- The operating sound of the lens is recorded when the zoom function operates while shooting a movie.

DISP (Screen Display Settings)

- 1 Press DISP (Screen Display Settings) on the control button.
- 2 Select the desired mode with the control button.

	 (Bright + Image Only)	Sets screen brighter and displays only images.	
	 (Bright + Exposure Data) (Playback mode only)	Sets screen brighter and displays the information. Exif data for the recorded image is also displayed.	
	 (Bright)	Sets screen brighter and displays the information.	
✓	 (Normal)	Sets screen to standard brightness and displays the information.	





Note

- If you view images in bright outside light, adjust the screen brightness up. However, the battery power may decrease faster under such condition.

- Table of contents
- Operation Search
- MENU/Settings Search
- Index

Flash

- 1 Press  (Flash) on the control button.
- 2 Select the desired mode with the control button.

✓	 AUTO (Auto)	Flash automatically operates in dark locations or when there is backlight.
	 (On)	Flash always operates.
	 SL (Slow Synchro)	Flash always operates. The shutter speed is slow in a dark place to clearly shoot the background that is out of flash light.
	 (Off)	Flash does not operate.

Notes

- The flash strobos twice. The first flash adjusts the light quantity.
- While charging the flash,  is displayed.
- You cannot use the flash during burst shooting.
- In Intelligent Auto mode, Easy Shooting mode, you can select only [Auto] or [Off].
- In Sweep Panorama, [Flash] is set to [Off].
- When shooting with the flash and the zoom is set to W, the shadow of the lens may appear at the bottom left of the screen, depending on the shooting conditions. If this happens, set the zoom to T and shoot with the flash again.

When the “White circular spots” appears in flash photos

This is caused by particles (dust, pollen, etc.) floating close to the lens. When they are accentuated by the camera’s flash, they appear as white circular spots.

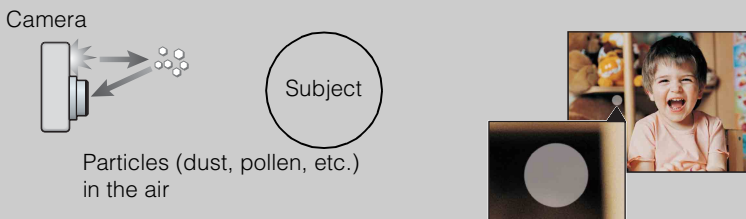

How can the “White circular spots” be reduced?

- Light the room and shoot the subject without a flash.
- Select  (High Sensitivity) mode in Scene Selection. ([Off] is automatically selected.)

Smile Shutter

When the camera detects a smile, the shutter is released automatically.

1 Press ☺ (Smile) on the control button.

2 Wait for a smile to be detected.

When the smile level exceeds the ◀ point on the indicator, the camera records images automatically.

If you press the shutter button during Smile Shutter, the camera shoots the image, then returns to Smile Shutter mode.

3 To stop shooting, press ☺ (Smile) again.

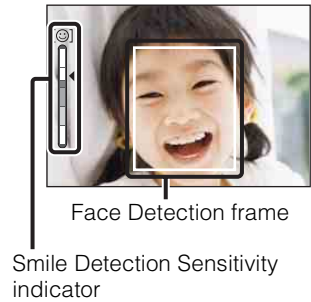

Notes

- Shooting using the Smile Shutter ends automatically when either the memory card or internal memory becomes full.
- Smiles may not be detected correctly depending on the conditions.
- You cannot use the Digital Zoom function.
- If Sweep Panorama or Movie Mode is selected, you cannot use the [Smile Shutter] function.

💡 Hints for better capturing of smiles

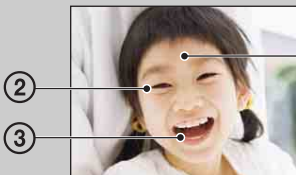







- ① Do not cover the eyes with the bangs.
Do not obscure the face by hat, masks, sunglasses, etc.
- ② Try to orient the face in front of the camera and be as level as possible. Keep the eyes narrowed.
- ③ Give a clear smile with an open mouth. The smile is easier to detect when the teeth are shown.

- The shutter operates when any person whose face is being detected smiles.
- You can select the priority subject for face detection with [Face Detection]. To perform smile detection for a different face, change the priority face with ● on the control button (page 59).
- If a smile is not detected, set the [Smile Detection Sensitivity] in setting menu.

Self-Timer

- 1 Press  (Self-Timer) on the control button.
- 2 Select the desired mode with the control button.

✓	 OFF (Off)	Does not use the self-timer.
	 10 (10sec)	Sets the 10-second delay self-timer. When you press the shutter button, the self-timer lamp flashes and a beep sounds until the shutter operates. To cancel, press  again.
	 2 (2sec)	Sets the 2-second delay self-timer.
	 (Self-portrait One Person)	Set the self-timer to Self-portrait timer. When the camera detects the specified number of faces, a beep sounds, and the shutter operates 2 seconds later. Do not move the camera during this while.
	 (Self-portrait Two People)	

Notes

- In Easy Shooting mode, you can select only [10sec] or [Off].
- In Movie Mode, [Self-portrait One Person] or [Self-portrait Two People] cannot be selected.
- The self-timer is not valid when shooting in Sweep Panorama mode.

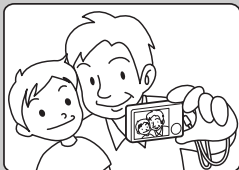

Automatic shooting with Self-portrait timer

Point the lens at yourself so your face is reflected in the LCD screen. The camera detects the subjects, and then the shutter operates. The camera determines the optimal composition and prevents faces from being cut out of the LCD screen.



- You can also shoot an image by pressing the shutter button during this operation.

Hints for preventing blur

If your hands or body moves while holding the camera and pressing the shutter button, “Camera shake” occurs. Camera shake occurs frequently under low-light or slow shutter speed conditions, such as those encountered in  (Twilight Portrait) or  (Twilight) mode. In such a case, shoot with the below tips in mind.

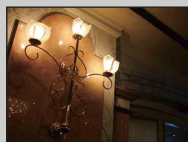
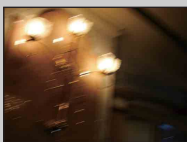

- Shoot with a 2-second delay self-timer and stabilize the camera by holding your arms firmly at your side after pressing the shutter button.
- Use a tripod or place the camera on a flat surface to hold the camera steady.

Viewing still images

- 1 Press the  (Playback) button to switch to playback mode.
- 2 Select an image with the control button.



Viewing images taken with a different camera

This camera creates a database file in a memory card and registers every shot image to it for later playback. If the camera detects images that have not been registered to the database file in the memory card, the registration screen “Files found which were not recognized Import files” appears.

If you want to view unregistered images, select [OK] to register the images.

- For registration, use a fully charged battery pack. If you attempt to register unregistered files using a battery pack with little remaining charge, the battery pack may run out, causing copying to fail or possibly corrupting the data.

Playback Zoom

Plays back the enlarged image.

- 1 Press **Q** (Playback Zoom) button during still image playback.

The image is enlarged to twice the previous size, at the center of the image.

- 2 Adjust the position with the control button.
- 3 Change the zoom scale with **W/T** (zoom) button.

Press **Q** button (**T**) to zoom in, **W** side to zoom out.

Press **●** to cancel playback zoom.



Shows the displayed area of the whole image



To save enlarged images

You can save an enlarged image by using the trimming function.

Press **MENU** → [Retouch] → [Trimming (Resize)].

Image Index

Displays multiple images at the same time.



- 1 Press the  (Playback) button to switch to playback mode.
- 2 Press the  (Index) button to display the image index screen.
Press the button again to display an index screen with more images. Press the button yet again to view images with the Calendar while playing back in [Date View].
- 3 To return to the single-image screen, select an image with the control button, then press .

Note

- If you select Easy Viewing mode while viewing images in index mode, it switches to single-image mode. In Easy Viewing mode, you cannot view images in index mode.

Displaying images of the desired date/folder





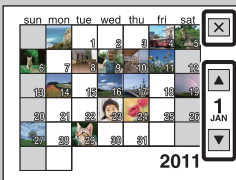

Select the left side bar with the control button, then select the desired date/folder with /.

Viewing images with the Calendar



When [View Mode] is set to [Date View], press the  (Index) button to view images with the Calendar, while the index displays more images.



- To select the month you want to display, select / with the control button, then the desired month.
- To view images in selected date in index mode, select the date with the control button and press .
- To exit the Calendar, select  with the control button, then press .

Delete

Allows you to select unwanted images for deletion. You can also delete images from the MENU button (page 70).

- 1 Press the  (Playback) button to switch to playback mode.
- 2  (Delete) button → desired mode → ● on the control button

All Images on This Date All in This Folder	Deletes all images in date range, the selected folder at once. Press [OK] → ● after step 2.
Multiple Images	Allows you to select and delete multiple images. Do as the following after step 2. ① Select an image then press ●. Repeat the above steps until there are no more images to be deleted. Select an image with a ✓ mark again to release the ✓ mark. ② MENU → [OK] → ●
This Image	Deletes the currently displayed image in single-image mode.
Cancel	Cancels the deletion.

Note

- When the internal memory is used to record images, View Mode is set to Folder View and still images and movies are displayed in the same folder.



 You can switch between index and single-image mode when selecting images









Press the Q button (T) of the W/T (zoom) button in index mode to return to single-image mode, and press the  (Index) button (W) in single-image mode to return to index mode.

- You can also switch between index and single-image mode in [Protect] or [DPOF].

Viewing movies



- 1 Press the  (Playback) button to switch to playback mode.
 - 2 Select a movie with the control button.
 - 3 Press .
- Movie playback starts.

Control button	Playback feature
	Stop
	Fast forward
	Fast rewind
	Displays the volume control screen. <ul style="list-style-type: none">• Adjust the volume with / on the control button, then press .

Note





- You may not be able to play back some images shot using other cameras.

On the movie viewing screen

Select the image you want to display using / on the control button, and press . The Playback bar appears, you can check a playback position of a movie.



Playback bar

 FINE,  FINE,  STD or  VGA appears on the movie viewing screen. The icon displayed may vary depending on image size and quality.

REC Mode

1 Set the mode switch to  (Still Image).



2 MENU →  (REC Mode) → desired mode

✓	 (Intelligent Auto)	Allows you to shoot with the settings adjusted automatically (page 21).
	P (Program Auto)	Allows you to shoot with the exposure adjusted automatically (both the shutter speed and the aperture value) (page 23). You can set various functions using the menu.
	SCN (Scene Selection)	Allows you to shoot with preset settings according to the scene (page 26).

Movie shooting scene

Allows you to shoot movies with preset settings according to the scene.



1 MENU →  (Movie shooting scene) → desired mode

✓	 (Auto)	Adjusts the setting automatically.
	 (Underwater)	Shoots underwater in natural colors when using a water proof housing (Marine pack, etc.).

Panorama Shooting Scene

Allows you to shoot with preset settings according to the scene when the camera is in Sweep Panorama mode.

1 MENU →  (Panorama Shooting Scene) → desired mode

✓	 (Sweep Panorama)	Allows you to shoot panoramic images (page 24).
	 (Underwater Sweep Panorama)	Allows you to shoot underwater panoramic images in natural colors when using a water proof housing (Marine pack, etc.).

Shooting Direction

Sets the direction to pan the camera when you shoot Sweep Panorama images.

1 MENU →  (Shooting Direction) → desired direction

















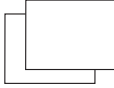

✓	 (Right)	Pan from left to right.
	 (Left)	Pan from right to left.
	 (Up)	Pan from down to up.
	 (Down)	Pan from up to down.

Image Size/Panorama Image Size

The image size determines the size of the image file that is recorded when you take a image. The larger the image size, the more detail will be reproduced when the image is printed on large-format paper. The smaller the image size, the more images can be recorded.

1 MENU →  (Image Size) or  (Panorama Image Size) → desired size

When shooting still images

	Image size	Usage guidelines	No. of images	Printing
✓	 (4320×3240) 14M	For prints up to A3+ size	Less 	Fine 
	 (3648×2736) 10M		↑	↑
	 (2592×1944) 5M	For prints from 10 × 15 cm up to A4 size	↓	↓
	 (640×480) VGA	For e-mail attachments	More 	Rough 
	 (4320×2432) 11M	For viewing on a high-definition TV, and for prints up to A3 size	Less 	Fine 
	 (1920×1080) 2M	For viewing on a high-definition TV	More 	Rough 



Note

- When you print still images recorded with 16:9 aspect ratio or panoramic images, both edges may be cut off.

In Easy Shooting mode

✓	Large	Shoots images in [14M] size.
	Small	Shoots images in [5M] size.



When shooting Sweep Panorama images

✓	 (Standard) <small>STD</small> (Horizontal: 4912×1080) (Vertical: 3424×1920)	Shoots images using standard size.
	 (Wide) <small>WIDE</small> (Horizontal: 7152×1080) (Vertical: 4912×1920)	Shoots images using wide size.

When shooting movies

The larger the image size, the higher the image quality. The higher the amount of data used per second (average bit-rate), the smoother the playback image.

The movies shot with this camera will be recorded in MPEG-4, Approx. 30fps, Progressive, AAC, mp4 format.

	Movie image size	Average bit rate	Usage guidelines
✓	 1280×720(Fine) <small>FINE</small>	9 Mbps	Shoots highest quality movie for display on HDTV.
	 1280×720(Standard) <small>STD</small>	6 Mbps	Shoots standard quality movie for display on HDTV.
	 VGA	3 Mbps	Shoots at an image size suitable for WEB upload.

Note

- A telephoto image results when the [VGA] image size is selected for movies.

💡 On “image quality” and “image size”

A digital image is made up of a collection of small dots called pixels. If it contains a large number of pixels, the image becomes large, it takes up more memory, and the image is displayed in fine detail. “Image size” is shown by the number of pixels. Although you cannot see the differences on the screen of the camera, the fine detail and data processing time differ when the image is printed or displayed on a computer screen.

Description of the pixels and the image size

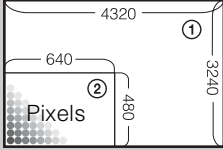

- ① Image size: 14M
 $4320 \text{ pixels} \times 3240 \text{ pixels} = 13,996,800 \text{ pixels}$
- ② Image size: VGA
 $640 \text{ pixels} \times 480 \text{ pixels} = 307,200 \text{ pixels}$

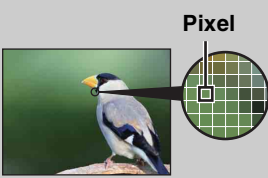

Many pixels
(Fine image quality and large file size)





Few pixels
(Rough image quality but small file size)

Burst Settings

You can select single-image mode or burst mode.

1 MENU →  (Burst Settings) → desired mode

✓	 (Single)	Shoots a single image.
	 (Burst)	<p>Shoots up to 100 images in succession when you press and hold down the shutter button.</p>  <p>Notes</p> <ul style="list-style-type: none">• The Burst mode is not available in Easy Shooting mode, Sweep Panorama, Movie Mode, or smile shutter.• The [Flash] is set to [Off].• When recording with the self-timer, only a single image can be shot.• The recording interval becomes longer, depending on the setting for the image size.• When the battery level is low, or when the internal memory or the memory card is full, the Burst stops.• [Focus], [White Balance] and [EV] are adjusted for the first image, and these settings are also used for the other images.

EV

You can adjust the exposure manually in 1/3 EV steps in a range of -2.0 EV to +2.0 EV.

1 MENU → 0EV (EV) → desired EV setting

Notes

- In Easy Shooting mode, the EV setting cannot be adjusted.
- If you shoot a subject in extremely bright or dark conditions, or when you use the flash, the exposure adjustment may not be effective.

Adjusting the exposure for better looking images



Overexposure = too much light
Whitish image



Lower EV setting -



Correct exposure



Higher EV setting +



Underexposure = too little light
Darker image

ISO

Adjusts the luminous sensitivity when the camera is set to Program Auto or  (Underwater) mode in Scene Selection.

1 MENU →  (ISO) → desired mode

✓	ISO AUTO (Auto)	Sets the ISO sensitivity automatically.
	ISO / ISO / ISO / ISO / 80 / 100 / 200 / 400 / ISO / ISO / ISO 800 / 1600 / 3200	You can reduce image blurring in dark locations or moving subjects by increasing ISO sensitivity (select a larger number).

Note

- ISO settings other than [ISO AUTO], [ISO 80] to [ISO 800] cannot be selected when the recording mode is set to Burst mode, or when [DRO] is set to [DRO plus].

Adjusting ISO Sensitivity (Recommended Exposure Index)

ISO sensitivity is a speed rating for recording media that incorporates an image sensor that receives light. Even when the exposure is the same, images differ depending on the ISO sensitivity.



High ISO sensitivity

Records a bright image even in dark locations while increasing shutter speed to reduce blur. However, the image tends to become noisy.



Low ISO sensitivity

Records a smoother image. However, when the exposure is insufficient, the image may become darker.

Hints for preventing blur

Even though the camera is steady, the subject moves during the exposure and is captured blurred when the shutter button is pressed. Camera shake is reduced automatically, however, the function does not effectively reduce subject blur.

Subject blur occurs frequently under low-light or slow shutter speed conditions.

In such a case, shoot with the below tips in mind.



- Select a higher ISO sensitivity so that the shutter speed is faster.
- Select  (High Sensitivity) mode in Scene Selection.

White Balance

Adjusts color tones according to the surrounding light conditions. Use this function if image color appears unnatural.

1 MENU → $\frac{WB}{AUTO}$ (White Balance) → desired mode

✓	$\frac{WB}{AUTO}$ (Auto)	Adjusts the white balance automatically so that the colors appear natural.
	☀ (Daylight)	Adjusts for outdoors conditions on a fine day, evening views, night scenes, neon signs, etc.
	☁ (Cloudy)	Adjusts for a cloudy sky or a shady location.
	☼ ₁ (Fluorescent White Balance 1)	[Fluorescent White Balance 1]: Adjusts for white fluorescent lighting.
	☼ ₂ (Fluorescent White Balance 2)	[Fluorescent White Balance 2]: Adjusts for natural white fluorescent lighting.
	☼ ₃ (Fluorescent White Balance 3)	[Fluorescent White Balance 3]: Adjusts for day white fluorescent lighting.
	💡 (Incandescent)	Adjusts for places under incandescent lamp, or under bright lighting, such as in a photo studio.
	⚡ _{WB} (Flash)	Adjusts for the flash conditions.
	📷 (One Push)	Adjusts the white balance depending on the light source. The white color memorized in [One Push Set] mode becomes the basic white color. Use this mode when [Auto] or other modes cannot be set the color properly.
	📷 ^{SET} (One Push Set)	Memorizes the basic white color which will be used in [One Push] mode.

Notes

- [White Balance] cannot be adjusted in Intelligent Auto or Easy Shooting mode.
- [Flash] in [White Balance] cannot be adjusted in the following situations:
 - In Sweep Panorama
 - In Movie Mode
 - When Scene Selection is set to \uparrow ISO (High Sensitivity) mode.
- Under fluorescent lights that flicker, the white balance function may not work correctly even though you select [Fluorescent White Balance 1], [Fluorescent White Balance 2] or [Fluorescent White Balance 3].
- When shooting with a flash in other than [Flash] mode, [White Balance] is set to [Auto].
- When [Flash] is [On] or [Slow Synchro], the white balance can only be adjusted to [Auto], [Flash], [One Push] or [One Push Set].
- [One Push Set] is unable to be selected while charging the flash.

To capture the basic white color in [One Push Set] mode

- 1 Frame a white object such as a piece of paper filling the screen under the same lighting conditions as you will shoot the subject.
- 2 MENU → $\frac{WB}{AUTO}$ (White Balance) → [One Push Set] → ● on the control button

The screen momentarily turns black, and when the white balance has been adjusted and stored in the memory, the recording screen is displayed again.





Notes

- If the  indicator flashes while shooting, the white balance is either not set or cannot be set. Use automatic white balance.
- Do not shake or strike the camera while [One Push Set] is in progress.
- When [Flash] mode is set to [On] or [Slow Synchro], the white balance is adjusted to the condition with the flash emitting.
- The white references loaded using [White Balance] and [Underwater White Balance] are stored separately.



Effects of lighting conditions

The apparent color of the subject is affected by the lighting conditions.







The color tones are adjusted automatically, but you can adjust color tones manually using the White Balance function.

Weather/lighting	Daylight	Cloudy	Fluorescent	Incandescent
Characteristics of light	White (standard) 	Bluish 	Green-tinged 	Reddish 

Underwater White Balance

Adjusts the color tone when the camera is set to  (Underwater) mode in [Scene Selection],  (Underwater) mode in [Movie shooting scene] or  (Underwater Sweep Panorama) mode in [Panorama Shooting Scene].

1 MENU →  (Underwater White Balance) → desired mode

	 (Auto)	Automatically adjusts color tones underwater so they appear natural.
	 (Underwater 1)	Adjusts for underwater conditions where blue is strong.
	 (Underwater 2)	Adjusts for underwater conditions where green is strong.
	 (One Push)	Adjusts the white balance depending on the light source. The white color memorized in [One Push Set] mode becomes the basic white color. Use this mode when [Auto] or other modes cannot be set the color properly.
	 (One Push Set)	Memorizes the basic white color which will be used in [One Push] mode (page 50).

Notes









- Depending on the color of the water, the Underwater White Balance may not work correctly even though you select [Underwater 1] or [Underwater 2].
- When [Flash] is [On], the underwater white balance can only be adjusted to [Auto], [One Push], or [One Push Set].
- [One Push Set] is unable to be selected while charging the flash.
- The white references loaded using [White Balance] and [Underwater White Balance] are stored separately.

Focus

You can change the focus method. Use the menu when it is difficult to get the proper focus in auto focus mode.

AF stands for “Auto Focus,” a function that adjusts the focus automatically.

1 MENU →  (Focus) → desired mode

	 (Multi AF)	<p>Focuses on a subject in all ranges of the finder frame automatically. When you press the shutter button halfway down in still image shooting mode, a green frame is displayed around the area that is in focus.</p> <ul style="list-style-type: none"> • When the Face Detection function is active, AF operates with priority on faces. • When Scene Selection is set to  (Underwater) mode, focus operation is suited to underwater shooting. When focus is achieved by half-pressing the shutter button, a large green frame is displayed in green. 	 <p>AF range finder frame</p>
	 (Center AF)	<p>Focuses on a subject in the center of the finder frame automatically. Using the AF lock function together, you can compose the image the way you want.</p>	 <p>AF range finder frame</p>
	 (Spot AF)	<p>Focuses on an extremely small subject or a narrow area automatically. Using the AF lock function together, you can compose the image the way you want. Hold the camera steady so as not to misalign the subject and the AF range finder frame.</p>	 <p>AF range finder frame</p>

Notes

- When you use [Digital Zoom] or [AF Illuminator], the AF range finder frame is disabled and appears in a dotted line. In this case, the camera works to focus on the subjects at the center of the screen.
- When the focus mode is set to other than [Multi AF], you cannot use the Face Detection function.
- The focus mode is fixed to [Multi AF] in the following situations:
 - In Intelligent Auto
 - In Easy shooting mode
 - In Movie Mode
 - When the Smile Shutter function is activated
 - When the self-timer is set to [Self-portrait One Person] or [Self-portrait Two People]

Focusing on subjects near the edge of the screen

If the subject is out of focus, do as follows:

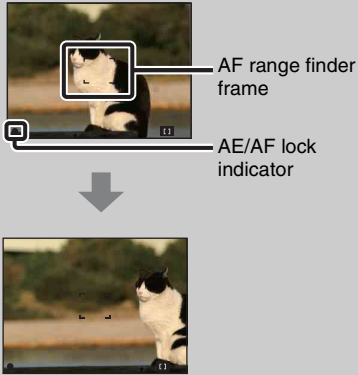





- ① Recompose the shot so that the subject is centered in the AF range finder, and press the shutter button halfway to focus on the subject (AF lock).
 - ② When the AE/AF lock indicator stops flashing and remains on, return to the fully composed shot, and press the shutter button fully down.
- As long as you do not press the shutter button fully down, you can retry the procedure as many times as necessary.

Metering Mode

Selects the metering mode that sets which part of the subject to measure to determine the exposure.

1 MENU →  (Metering Mode) → desired mode

✓	 (Multi)	Divides into multiple regions and measures each region. The camera determines a well-balanced exposure (Multi-pattern metering).
	 (Center)	Measures the center of the image, and determines the exposure based on the brightness of the subject there (Center-weighted metering).
	 (Spot)	Measures only a part of the subject (Spot metering). This function is useful when the subject is backlit or when there is strong contrast between the subject and the background.  Spot metering cross hairs Positions on the subject

Notes

- In Movie Mode, [Spot] cannot be selected.
- If you set Metering Mode to other than [Multi], the Face Detection function cannot be used.
- Metering Mode is fixed to [Multi] in the following situations:
 - In Intelligent Auto
 - In Easy shooting mode
 - When the Smile Shutter function is activated
 - When the self-timer is set to [Self-portrait One Person] or [Self-portrait Two People]

Scene Recognition

In Intelligent Auto mode, the camera automatically detects shooting conditions, and then takes the shot. When motion is detected, the ISO sensitivity is increased according to the movement to reduce subject blur (Motion Detection).











Example of an image where  (Backlight) has activated.











Scene Recognition icon and guide



The camera recognizes the following types of scenes. When the camera determines the optimal scene, it displays the corresponding icon and guide.

-  (Twilight),  (Twilight Portrait),  (Twilight using a tripod),  (Backlight),  (Backlight Portrait),  (Landscape),  (Macro),  (Portrait)

1 MENU →  (Scene Recognition) → desired mode

✓	 (Auto)	When the camera recognizes the scene, it switches to the optimal settings and shoots the image.
	 (Advanced)	<p>When the camera recognizes the scene, it switches to the optimal settings. If the camera recognizes  (Twilight),  (Twilight Portrait),  (Twilight using a tripod),  (Backlight) or  (Backlight Portrait), it automatically changes the setting and shoots another image.</p> <ul style="list-style-type: none"> • When you shoot two images consecutively, the + mark on the  icon will turn green. • When two frames are shot, the two images are displayed side by side immediately after shooting. • When [Anti Blink] is displayed, 2 images are taken automatically and the image with eyes are open is selected automatically. For details on the Anti Blink function, see “What is the Anti Blink function?”.

Notes

- Scene Recognition does not function when using digital zoom.
- Scene Recognition is fixed to [Auto] in the following situations:
 - When Burst mode is selected
 - When the Smile Shutter function is activated
 - When the self-timer is set to [Self-portrait One Person] and [Self-portrait Two People]
- The available flash settings are [Auto] and [Off].
-  (Twilight using a tripod) scenes sometimes cannot be recognized in an environment where vibrations are transferred to the camera even though it is fixed on a tripod.
- Sometimes a slow shutter results when a scene is recognized as a  (Twilight using a tripod). Keep the camera still during shooting.
- These scenes may not be recognized depending on the situation.



Shooting two images with different settings and selecting the one you like (Advanced mode)

In [Advanced], when the camera recognizes a difficult-to-shoot scene (☾ (Twilight), 👤 (Twilight Portrait), 📷 (Twilight using a tripod), 📷 (Backlight) and 👤 (Backlight Portrait)), it changes the settings as follows and shoots two images with different effects, allowing you to select the one you like.

	First Image*	Second Image
☾	Shoot in Slow Synchro	Shoots with sensitivity increased and shake reduced
👤	Shoot in Slow Synchro with the face which the flash strobos on as guide	Shoots with sensitivity increased with the face as guide and shake reduced
📷	Shoot in Slow Synchro	Shoots with even slower shutter speed without increasing sensitivity
📷	Shoots with the flash	Shoots with the brightness and contrast of the background adjusted (DRO plus)
👤	Shoots with the face which the flash strobos on as guide	Shoots with the brightness and contrast of the face and the background adjusted (DRO plus)

* When [Flash] is set to [Auto].



What is the Anti Blink function?





When set to [Advanced], the camera automatically shoots two images consecutively* when it recognizes 👤 (Portrait). The camera will select, display, and record the image which the eyes are not blinked automatically. If the eyes are closed in both images, the message “Blinked eye detected” is displayed.

* except when the flash strobos/when the shutter speed is slow

Soft Skin Effect

When the Face Detection function is activated, sets whether to use the Soft Skin effect, and the effect level.

1 MENU →  (Soft Skin Effect) → desired mode

✓	 OFF (Off)	Does not use the Soft Skin Effect.
	 Lo (Low)	Adds light Soft Skin Effect.
	 Mid (Mid)	Adds moderate Soft Skin Effect.
	 Hi (High)	Adds strong Soft Skin Effect.

Notes

- [Off] is not available when Scene Selection is set to  (Soft Skin) mode.
- The [Soft Skin Effect] may not be visible depending on the subject.

Smile Detection Sensitivity

Sets the sensitivity of the Smile Shutter function for detecting smiles.

1 MENU → 😊 (Smile Detection Sensitivity) → desired mode

	😊 (Big Smile)	Detects a big smile.
✓	😊 (Normal Smile)	Detects a normal smile.
	😊 (Slight Smile)	Detects even a slight smile.

Notes

- Smiles may not be detected correctly depending on the conditions.
- [Smile Detection Sensitivity] cannot be adjusted in the following situations:
 - In Easy Shooting mode
 - In Sweep Panorama
 - In Movie Mode

Face Detection

Detects the faces of your subjects and adjusts the focus, flash, exposure, white balance and red-eye reduction settings automatically.







Face Detection frame (Orange)

When the camera detects more than one subject, the camera will judge which is the main subject and set focus by priority. The Face Detection frame for the main subject will turn orange. The frame for which the focus is set will turn green by pressing the shutter button halfway down.

Face Detection frame (White)

1 MENU →  (Face Detection) → desired mode

	 (Off)	Does not use Face Detection function.
✓	 (Auto)	Selects the face the camera is to automatically focus on.
	 (Child Priority)	Detects and shoots with priority on child's face.
	 (Adult Priority)	Detects and shoots with priority on adult's face.

Notes

- [Face Detection] cannot be selected in the following situations:
 - In Easy Shooting mode
 - In Sweep Panorama
 - In Movie Mode
- You cannot select [Off] when the self-timer is set to [Self-portrait One Person] or [Self-portrait Two People].
- You can select [Face Detection] only when the focus mode is set to [Multi AF] or the metering mode is set to [Multi].
- The Face Detection function does not work when using the digital zoom.
- Up to 8 faces of your subjects can be detected.
- Adults and children may not be recognized correctly depending on the conditions.
- During Smile Shutter shooting, [Face Detection] is automatically set to [Auto] even if it is set to [Off].

💡 Selecting the priority face (Tracking focus)

Normally the camera automatically selects the face to focus on according to the [Face Detection] setting, but you can also select a face to be given priority.



- ① Press ● on the control button during Face Detection.
The target frame appears.
- ② Place the target frame over the detected face, and press ●.
The frame changes to an orange □.
- ③ To cancel face priority, press ● again.



- It may not be possible to detect the selected face correctly depending on the surrounding brightness, the subject's hairstyle, etc. In this case, select the face again under the conditions where the image will be shot.
- When the Smile Shutter function is used with the Face Detection frame selected, Smile Detection is performed only on the selected face.
- You cannot select the priority face in Easy Shooting mode or when the self-timer is set to [Self-portrait One Person] or [Self-portrait Two People].

DRO

In Program Auto, the camera analyzes the shooting scene and automatically corrects the brightness and contrast to improve the image quality.

DRO stands for “Dynamic Range Optimizer,” a function that automatically optimizes the difference between light and dark parts of an image.



1 MENU →  (DRO) → desired mode

	 (Off)	Does not adjust.
✓	 (DRO standard)	Adjusts the brightness and contrast of the images automatically.
	 (DRO plus)	Adjusts image brightness and contrast automatically and strongly.



Notes

- Depending on shooting conditions, it may not be possible to obtain correction effects.
- Only [ISO AUTO] or values from [ISO 80] to [ISO 800] can be set for the ISO value when [DRO plus] is set.

Anti Blink

When Scene Selection is set to  (Soft Skin) or  (Soft Snap) while you are shooting an image, the camera automatically shoots two images consecutively. The camera will select, display and record the image which the eyes are not blinked automatically.

1 MENU →  (Anti Blink) → desired mode

	 (Auto)	When Face Detection is active, the Anti Blink function operates so that images with the subject's eyes open are recorded.
	 (Off)	Does not use the Anti Blink function.

Notes

- [Anti Blink] does not function in the following situations:
 - When using the flash
 - When Burst mode is selected
 - When the Face Detection function does not work
 - When the Smile Shutter function is activated
- Sometimes the Anti Blink function does not work depending on the situation.
- When the Anti Blink function is set to [Auto] but only images with the subject's eyes closed are recorded, the message "Blinked eye detected" is displayed on the LCD screen. Shoot again as necessary.

In-Camera Guide

This camera contains an internal function guide. This allows you to search the camera's functions according to your needs.

You can use the selected function after reading the guide.

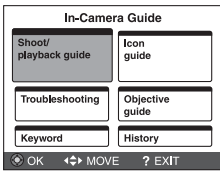

1 MENU → ? (In-Camera Guide)

2 Select a search method from [In-Camera Guide].

Search method	Description
Shoot/playback guide	Search for various operation functions in shooting/viewing mode.
Icon guide	Search the function and meaning of displayed icons.
Troubleshooting	Search common problems and their solution.
Objective guide	Search functions according to your needs.
Keyword	Search functions by key words.
History	Display the last 12 items displayed in [In-Camera Guide].

Easy Mode

When you see still images, the text size increases and indicators become easier to see.

- 1 Press the  (Playback) button to set to playback mode.
- 2 MENU → **EASY** (Easy Mode) → [OK] → ● on the control button

Notes

- The battery charge is used up more quickly because the screen brightness increases automatically.
- The shooting mode also changes to [Easy Mode].

On Easy Viewing mode

In Easy Mode, only the deletion function is available.



 **(Delete) button** You can delete the currently displayed image.
Select [OK] → ●.



MENU button You can delete the currently displayed image with [1 image] and delete all images in the selected date range or the internal memory (if selected) with [All].
Select [Exit Easy Mode] → [OK] to exit Easy Mode.

- [View Mode] is set to [Date View] when using a memory card.

Slideshow

Images are automatically played back in succession.

- 1 Press the  (Playback) button to switch to playback mode.
- 2 MENU →  (Slideshow) → desired slideshow → ● on the control button

 (Continuous Playback)	Plays back all the images in succession from the displayed image to the very last image.
 (Slideshow with music)	Plays back still images in succession along with effects and music.

Continuous Playback

- 1 Select the desired image for playing with the control button.
- 2 MENU →  (Slideshow) → [Continuous Playback] → ●

Control button	Playback feature
●	Pause
▲	Sets the display settings.
▼	Displays the volume control screen. <ul style="list-style-type: none">• Adjust the volume with ▲/▼ on the control button, then press ●.
◀	Rewinds image.
▶	Forwards image.

Viewing panoramic images during continuous playback

The whole panoramic image is displayed for 3 seconds.
You can scroll a panoramic image by pressing ●.

Slideshow with music

- 1 MENU →  (Slideshow) → [Slideshow with music] → ● on the control button
Displays the setting screen.
- 2 Select a desired setting.
- 3 [Start] → ●
- 4 Press ● to end the slideshow.

Note

- You cannot play back movies or panoramic images.

Image		
Selects the group of images to be shown.		
✓	All	Plays a slideshow of all the still images in order.
	This Date	Plays a slideshow of still images with the currently selected date range when View Mode is [Date View].
	Folder	Plays a slideshow of still images in the currently selected folder when View Mode is Folder View.

Note

- This setting is fixed to [Folder] when the internal memory is used to record images.

Effects		
Selects the playback speed and mood for slideshows.		
✓	Simple	A simple slideshow switching still images at a preset interval. The playback interval is adjustable in [Interval] and you can thoroughly enjoy your images.
	Nostalgic	A moody slideshow reproducing the atmosphere of a movie scene.
	Stylish	A stylish slideshow proceeding at a middle tempo.
	Active	A high-tempo slideshow suitable for active scenes.

Music		
Specifies the music to be played during slideshows. You can select more than one background music track. Press ▼ on the control button to display the volume control screen, then press ▲/▼ to adjust the volume.		
✓	Music1	The default setting for a [Simple] slideshow.
	Music2	The default setting for a [Nostalgic] slideshow.
	Music3	The default setting for a [Stylish] slideshow.
	Music4	The default setting for a [Active] slideshow.
	Mute	Does not use BGM.

Interval

Sets the screen switching interval. The setting is fixed to [Auto] when [Simple] is not selected as the [Effects].

	1 sec	Sets the display interval of images for a [Simple] slideshow.
✓	3 sec	
	5 sec	
	10 sec	
	Auto	The interval is set to suit the selected [Effects] item.

Repeat

Turns slideshow repeat on or off.

✓	On	Plays back images in a continuous loop.
	Off	After all the images have been played back, the slideshow ends.





Selecting background music



You can transfer a desired music file from your CDs or MP3 files to the camera to play back during slideshow. To transfer music, install the “Music Transfer” software (supplied) to your computer. For details, see pages 109 and 110.

- You can record up to four pieces of music on the camera (The 4 preset pieces (Music1 – Music4) can be replaced with the ones you transferred).
- A maximum length of each music file for music playback of the camera is about 5 minutes.
- If you cannot play back a music file due to damage or other malfunctions of the file, execute [Empty Music] (page 93) and transfer the music again.

View Mode

Allows you to select the display format for images.



- 1 Press the  (Playback) button to switch to playback mode.
- 2 MENU →  (View Mode) → desired mode → ● on the control button

✓	 (Date View)	Displays images by the date.
	 (Folder view (Still))	Displays only still images.
	 (Folder view (Movie))	Displays only movie files.

Note

- When using the internal memory, the View Mode is set to Folder View and still images and movies are played from the same folder.

Displaying the Calendar

- 1 MENU →  (View Mode) → [Date View] → ● on the control button
- 2 Press the  (Index) button repeatedly until the Calendar is displayed.
Use the control button to select , then select the month you want to display. Select the date and press ● to view images of the selected date in index mode.

Viewing images taken with a different camera



This camera creates a database file in a memory card and registers every shot image to it for later playback. If the camera detects images that have not been registered to the database file in the memory card, the registration screen “Files found which were not recognized Import files” appears.





If you want to view unregistered images, select [OK] to register the images.

- For registration, use a fully charged battery pack. If you attempt to register unregistered files using a battery pack with little remaining charge, the battery pack may run out, causing copying to fail or possibly corrupting the data.

Retouch

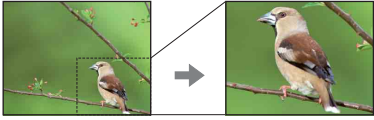
Retouches a recorded image and saves it as a new file. The original image is retained.

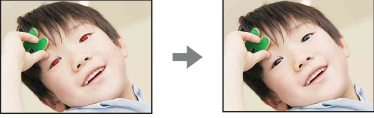
- 1 Press the  (Playback) button to switch to playback mode.
- 2 MENU →  (Retouch) → desired mode → ● on the control button
- 3 Perform retouching according to the operation method in each mode.

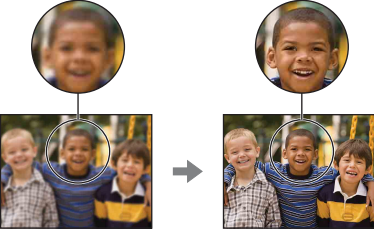
 (Trimming (Resize))	<p>Records the zoomed playback image.</p> <ol style="list-style-type: none"> ① Press the Q button (T) to zoom in and press W to zoom out. ② Set the zoom point with the control button. ③ MENU → select an image size to save → ● ④ [OK] → ● <ul style="list-style-type: none"> • The quality of trimmed images may deteriorate. • The image size that you can trim may vary depending on the image. 	
 (Red Eye Correction)	<p>Corrects the red-eye phenomenon caused by flash.</p> <ol style="list-style-type: none"> ① Select [OK] with the control button → ● <ul style="list-style-type: none"> • You may not be able to correct the red-eye phenomenon depending on the image. 	
 (Unsharp masking)	<p>Sharpens the image within a chosen frame.</p> <ol style="list-style-type: none"> ① Select the area (frame) of the desired image to retouch with the control button → MENU. ② [OK] → ● <ul style="list-style-type: none"> • Depending on the image, sufficient correction may not be applied and the image quality may deteriorate. 	





Note

- You cannot retouch movies or panoramic images.

Delete

Allows you to select unwanted images for deletion. You can also delete images using the ?/🗑️ (Delete) button (page 37).

- 1 Press the ▶️ (Playback) button to switch to playback mode.
- 2 MENU → 🗑️ (Delete) → desired mode → ● on the control button
- 3 [OK] → ●

 (This Image)	Deletes the currently displayed image in single-image mode.
 (Multiple Images)	You can select and delete multiple images. Do as the following after step 2. ① Select an image then press ●. Repeat the above steps until there are no more images to be deleted. Select an image with a ✓ mark to release the ✓ mark. ② MENU → [OK] → ●
 (All Images on This Date)  (All in This Folder)	Deletes all images in date range, or the selected folder at once.



Note







- In Easy Viewing mode, you can select from [1 image] or [All] to delete images.

Protect

Protects recorded images against accidental erasure.

The  mark is displayed for registered images.

- 1 Press the  (Playback) button to switch to playback mode.
- 2 MENU →  (Protect) → desired mode →  on the control button

 (This Image)	Protects the currently displayed image in single-image mode.
 (Multiple Images)	<p>You can select and protect multiple images. Do as the following after step 2.</p> <p>① Select an image then press .</p> <p>Repeat the above steps until there are no more images to be protected. Select an image with a  mark to release the  mark.</p> <p>② MENU → [OK] → </p>



To cancel the protection

Select the image for which you want to cancel protection, and unlock it by pressing  on the control button as the same procedure to protect it.

The  indicator disappears, and the protection is released.



DPOF

DPOF (Digital Print Order Format) is a function that allows you to specify the images of the memory card that you want to print out later.

The **DPOF** (Print order) mark is displayed for registered images.

1 Press the  (Playback) button to switch to playback mode.

2 MENU → **DPOF** → desired mode → ● on the control button

DPOF  (This Image)	Orders printing the currently displayed image in single-image mode.
DPOF  (Multiple Images)	You can select and order printing multiple images. Do as the following after step 2. ① Select an image then press ●. Repeat the above steps until there are no more images to be printed. Select an image with a ✓ mark to release the ✓ mark. ② MENU → [OK] → ●

Notes

- The **DPOF** (Print order) mark cannot be added to movies or to images in the internal memory.
- You can add a **DPOF** (Print order) mark to a maximum 999 images.

Clearing the DPOF mark





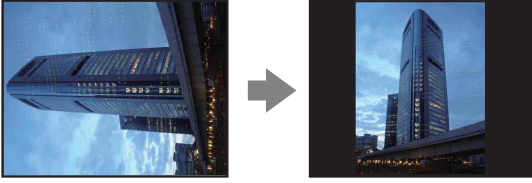

Select the image to clear the DPOF registration, then press ● on the control button in the same procedure as when making a **DPOF** mark.

The **DPOF** mark disappears and the DPOF registration is cleared.

Rotate

Rotates a still image. Use this to display a horizontal orientation image in vertical orientation.





- 1 Press the  (Playback) button to switch to playback mode.
- 2 MENU →  (Rotate) → ● on the control button
- 3 Rotate the image with [/] → /.
- 4 [OK] → ●

Notes

- You cannot rotate movies or protected still images.
- You may not be able to rotate images shot with other cameras.
- When viewing images on a computer, the image rotation information may not be reflected depending on the software.

Select Folder

When multiple folders are created in a memory card, this selects the folder containing the image you want to play back.

- 1 Press the  (Playback) button to switch to playback mode.
- 2 MENU →  (View Mode) → [Folder view (Still)] or [Folder view (Movie)] → ● on the control button
- 3 MENU →  (Select Folder) → ●
- 4 Select the folder with ◀/▶.
- 5 [OK] → ●



Note

- This item is not displayed when the internal memory is used to record images.





Viewing images across multiple folders

When multiple folders are created, the following indicators appear on the first and last images in the folder.

- : Moves to the previous folder
- : Moves to the next folder
- : Moves to either the previous or next folders



AF Illuminator

The AF illuminator supplies fill light to focus more easily on a subject in dark surroundings. The AF illuminator emits red light allowing the camera to focus easily when the shutter button is pressed halfway, until the focus is locked. The **AF-ON** indicator appears at this time.

- 1 Set the camera to shooting mode.
- 2 MENU →  (Settings) →  (Shooting Settings) → [AF Illuminator] → desired mode → ● on the control button



✓	Auto	Uses the AF illuminator.
	Off	Does not use the AF illuminator.

Notes

- Focus is achieved as long as the AF illuminator light reaches the subject, regardless of whether light fails to reach the center of the subject.
- You cannot use the AF illuminator when:
 - Shooting in Sweep Panorama mode
 -  (Landscape),  (Twilight) or  (Pet) mode is selected in Scene Selection.
 - The self-timer is set to [Self-portrait One Person] or [Self-portrait Two People].
- When you use the AF illuminator, the normal AF range finder frame is disabled and a new AF range finder frame is displayed by a dotted line. AF operates with priority on subjects located near the center of the frame.
- The AF illuminator emits very bright light. Although there is no health hazard, do not look directly into the AF illuminator emitter at close range.

Grid Line



With reference to the grid lines, you can easily set a subject in a horizontal/vertical position.

- 1 Set the camera to shooting mode.
- 2 MENU →  (Settings) →  (Shooting Settings) → [Grid Line] → desired mode → ● on the control button

	On	Displays the grid lines. The grid lines are not recorded.
✓	Off	Does not display the grid lines.

Disp. Resolution

Selects the display quality on the LCD screen for shooting.

- 1 Set the camera to shooting mode.
- 2 MENU →  (Settings) →  (Shooting Settings) → [Disp. Resolution] → desired mode → ● on the control button



✓	Standard	Displays a standard-quality image for shooting.
	High	Displays a high-quality image for shooting.

Notes

- The battery charge is used up more quickly when [Disp. Resolution] is set to [High].
- In Sweep Panorama and Movie Mode, [Disp. Resolution] is set to [High].

Digital Zoom

Selects the digital zoom mode. The camera enlarges the image using optical zoom (up to 4×). When the zoom scale is exceeded, the camera uses either smart or precision digital zoom.

- 1 Set the camera to shooting mode.
- 2 MENU →  (Settings) →  (Shooting Settings) → [Digital Zoom] → desired mode → ● on the control button

✓	Smart (SQ)	Enlarges the image digitally within the range where the image will not be distorted, according to the image size (Smart zoom).
	Precision (PQ)	Enlarges all image sizes by the total zoom scale of approximately 8×, including the optical zoom 4×. However, note that the image quality deteriorates when the optical zoom scale is exceeded (Precision digital zoom).
	Off	Does not use the digital zoom.

Notes

- The Digital Zoom function does not operate in the following situations:
 - In Movie Mode
 - In Sweep Panorama
 - When the Smile Shutter function is activated
 - When the self-timer is set to [Self-portrait One Person] or [Self-portrait Two People]
- The smart zoom is not available when the image size is set to [14M], or [16:9(11M)].
- The Face Detection function does not work when using the digital zoom.



Total zoom scale when using Smart zoom (including optical zoom 4×)

The supported zoom ratio differs depending on the image size.

Size	Total zoom scale
10M	Approx. 4.7×
5M	Approx. 6.7×
VGA	Approx. 27×
16:9(2M)	Approx. 9×

Auto Orientation

When the camera is rotated to shoot a portrait (vertical) image, the camera records its position change and displays the image in the portrait position.

- 1 Set the camera to shooting mode.
- 2 MENU →  (Settings) →  (Shooting Settings) → [Auto Orientation] → desired mode → ● on the control button

<input checked="" type="checkbox"/>	On	Records the image with the correct orientation.
<input type="checkbox"/>	Off	Does not use Auto Orientation.

Notes



- Black is displayed to the left and right of vertical orientation images.
- Depending on the shooting angle of the camera, the orientation of the image may not be recorded correctly.
- You cannot use [Auto Orientation] when  (Underwater) mode is selected in the Scene Selection or in Movie Mode.

Rotating images after recording

If the orientation of an image is incorrect, you can use the [Rotate] on the Menu screen to display the image in portrait position.

Red Eye Reduction

The flash strobescs two or more times before shooting to reduce the red-eye phenomenon when using the flash.

- 1 Set the camera to shooting mode.
- 2 MENU →  (Settings) →  (Shooting Settings) → [Red Eye Reduction] → desired mode → ● on the control button

✓	Auto	When the Face Detection function is activated, the flash strobescs automatically to reduce the red-eye phenomenon.
	On	The flash always strobescs to reduce the red-eye phenomenon.
	Off	Does not use Red Eye Reduction.

Notes

- To avoid blurring of images, hold the camera firmly until the shutter is released. It usually takes a second until the shutter is released, and also be sure not to allow the subject to move during this period.
- Red Eye Reduction may not produce the desired effects. It depends on individual differences and conditions, such as distance to the subject, or if the subject looked away from the pre-strobe.
- If you do not use the Face Detection function, Red Eye Reduction does not work, even when you select [Auto].
- [Red Eye Reduction] is set to [Off] in the following situations:
 - When  (High Sensitivity) mode is selected in Scene Selection.
 - When the Smile Shutter function is activated.

What causes the red-eye phenomenon?

Pupils become dilated in dark environments. Flash light is reflected off the blood vessels at the back of the eye (retina), causing the “red-eye” phenomenon.

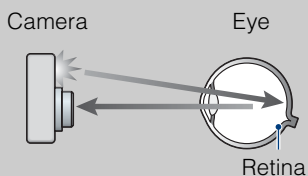



Other ways to reduce red-eye

- Select  (High Sensitivity) mode in Scene Selection. (The [Flash] is set to [Off] automatically.)
- When the eyes of the subject turn out red, correct the image with [Retouch] → [Red Eye Correction] on the viewing menu or with the supplied software “PMB”.

Blink Alert



When an image with the subject's eyes closed is recorded while Face Detection is activated, the message "Blinked eye detected" is displayed.

- 1 Set the camera to shooting mode.
- 2 MENU →  (Settings) →  (Shooting Settings) → [Blink Alert] → desired mode → ● on the control button

✓	Auto	Displays the "Blinked eye detected" message.
	Off	Does not display the message.

Beep



Selects or turns off the sound produced when you operate the camera.

- 1 MENU →  (Settings) →  (Main Settings) → [Beep] → desired mode → ● on the control button

	Shutter	Turns on the shutter sound when you press the shutter button.
✓	High	Turns on the beep/shutter sound when you press the control/shutter button.
	Low	If you want to lower the volume, select [Low].
	Off	Turns off the beep/shutter sound.



Language Setting

Selects the language to be used in the menu items, warnings and messages.

- 1 MENU →  (Settings) →  (Main Settings) → [Language Setting] → desired mode → ● on the control button

Function Guide



You can select whether or not the function guide is displayed when you operate the camera.

1 MENU →  (Settings) →  (Main Settings) → [Function Guide] → desired mode → ● on the control button

✓	On	Displays the function guide.
	Off	Does not display the function guide.

Display color



Sets the color of the screen display.

1 MENU →  (Settings) →  (Main Settings) → [Display color] → desired mode → ● on the control button

✓	Black	Sets the background color of the LCD screen.
	White	
	Pink	

Demo Mode

You can set whether to use a demonstration of Smile Shutter or other functions. When there is no need to view a demonstration, set to [Off].

1 MENU →  (Settings) →  (Main Settings) → [Demo Mode] → desired mode → ● on the control button

	Demo Mode1	A demonstration of the shooting functions will be performed.
	Demo Mode2	Automatically starts the Smile Shutter demonstration when no operation is performed for 15 seconds.
✓	Off	Does not perform a demonstration.



Notes

- Pressing the shutter button during the Smile Shutter demonstration operates the shutter, but no image is recorded.
- During a demonstration, if the number of images saved in the internal memory increases, the camera may automatically delete the images.

Initialize

Initializes the setting to the default setting.

Even if you execute this function, the images are retained.



- 1 MENU →  (Settings) →  (Main Settings) → [Initialize] → [OK] → ● on the control button

Note

- Be sure not to turn off the camera while initializing.

COMPONENT

Selects the video output signal type from SD and HD(1080i) when you connect the camera and TV using an HD Output Adaptor Cable (sold separately), according to the TV connected. Use a Type3a-compliant HD Output Adaptor Cable (sold separately).

1 MENU →  (Settings) →  (Main Settings) → [COMPONENT] → desired mode → ● on the control button

✓	HD(1080i)	Select this item to connect the camera to a 1080i-capable High Definition TV.
	SD	Select this item to connect the camera to a TV that is not compatible with an HD(1080i) signal.



Note

- When shooting movies in the condition with the camera and a TV connected using an HD Output Adaptor Cable (sold separately), the image being shot is not displayed in the TV side.

Video Out

Sets the video signal output according to the TV color system of the connected video equipment. The TV color systems differ depending on the country and region.



To view images on a TV screen, check the TV color system of the country or region of use (page 107).

1 MENU →  (Settings) →  (Main Settings) → [Video Out] → desired mode → ● on the control button

NTSC	Sets the video output signal to NTSC mode (e.g., for the USA, Japan).
PAL	Sets the video output signal to PAL mode (e.g., for Europe, China).

USB Connect

Sets the mode when the camera is connected to a computer or a USB device using the cable for multi-use terminal.

1 MENU →  (Settings) →  (Main Settings) → [USB Connect] → desired mode → ● on the control button

✓	Mass Storage	Establishes a Mass Storage connection between the camera and a computer or other USB device.
	PTP/MTP	When you connect the camera to a computer, the AutoPlay Wizard appears, and the still images in the recording folder on the camera are imported to the computer. (with Windows 7/Vista/XP, Mac OS X)

Note

- When [USB Connect] is set to [PTP/MTP], you cannot export movies to a computer. To export movies to a computer, set [USB Connect] to [Mass Storage].

LUN Setting

Sets the display method for the recording media displayed on a computer screen or other monitor when the camera is connected with a computer or AV component using a USB connection.

1 MENU →  (Settings) →  (Main Settings) → [LUN Setting] → desired mode → ● on the control button



✓	Multi	The images both on the memory card and in the internal memory are displayed. Select this setting when you connect the camera to a computer.
	Single	When the memory card is inserted into the camera, the images on the memory card are displayed; when it is not inserted, the images in the internal memory are displayed. Select this setting in cases where the images of both the memory card and the internal memory are not displayed when the camera is connected to a device other than a computer.

Note

- You must always select [Multi] in [LUN Setting] when uploading images to a media service using “PMB Portable”.



Download Music

You can use “Music Transfer” in the CD-ROM (supplied) to change background music tracks.

- 1 MENU →  (Settings) →  (Main Settings) → [Download Music] → ● on the control button
The message “Connect to PC” appears.
- 2 Make a USB connection between the camera and a computer, then start “Music Transfer”.
- 3 Follow the instructions on the screen to change music files.

Empty Music

You can delete all the background music files stored in the camera. It can be used in cases such as when the background music files are damaged and cannot be played.

1 MENU →  (Settings) →  (Main Settings) → [Empty Music] → [OK] → ● on the control button





Restoring the music preset at the factory to the camera

You can use “Music Transfer” in the CD-ROM (supplied) to reset music files to the preset ones.

- ① Execute [Download Music] and make a USB connection between the camera and a computer.
- ② Start “Music Transfer”, then restore the default music.
 - For details on using “Music Transfer”, see the help in “Music Transfer”.

Power Save

Sets the time until the screen darkens, and the camera turns off. If you do not operate the camera running on a battery pack for a certain amount of time, the brightness level on the LCD screen becomes dark, and then the camera automatically turns off to prevent wearing down the battery pack (Auto Power off).

1 MENU →  (Settings) →  (Main Settings) → [Power Save] → desired mode → ● on the control button



	Stamina	Proactively saves the battery power. If the camera is not operated for a certain period of time, the power turns off automatically. In shooting mode, the LCD screen automatically goes dark before the power turns off.
✓	Standard	If the camera is not operated for a certain period of time, the power turns off automatically. In shooting mode, the LCD screen automatically goes dark before the power turns off. It takes longer before the power turns off than when set to [Stamina].
	Off	Does not use the Auto power-off function.





Note

- The camera does not turn off automatically in the following situations:
 - During slideshow
 - When playing back movies
 - During Eye-Fi connection

Eye-Fi

Sets whether to use the upload function of an Eye-Fi card (commercially available), when you use the Eye-Fi card with this camera. [Eye-Fi] is displayed only when the Eye-Fi card is inserted in the camera.

1 MENU →  (Settings) →  (Main Settings) → [Eye-Fi] → desired mode → ● on the control button

✓	On	Uses the upload function. The Eye-Fi mode display icon on the LCD screen will change depending on the communication mode of the Eye-Fi card.  Eye-Fi card is in standby mode. There is no image to be sent.  Eye-Fi card is in upload standby mode.  Eye-Fi card is in connecting mode.  Eye-Fi card is uploading images.  An error has occurred.
	Off	Does not use the upload function.

Notes

- As of March 2010, Eye-Fi cards are sold in the U.S.A., Canada, Japan and some countries in the European Union.
- For more information on the Eye-Fi card, contact the manufacturer or seller of Eye-Fi cards directly.
- Eye-Fi cards are permitted only in the countries and regions in which they were purchased. You may be held liable due to local restrictions.
- The Eye-Fi card has a wireless LAN function. Do not insert the Eye-Fi card where wireless LAN is prohibited, such as while aboard an airplane. If the Eye-Fi card is inserted, set [Eye-Fi] to [Off]. When the uploading function of the Eye-Fi card is set to [Off],  is displayed on the LCD screen.

Transferring image data using the Eye-Fi card



1 Set the wireless LAN access point settings or the transferring direction settings of the Eye-Fi card.

For details, refer to the operating instructions supplied with the Eye-Fi card.

2 After the settings are finished, insert the Eye-Fi card into the camera, and shoot the images.



The recorded images are automatically transferred via the wireless LAN to the PC, etc.

Notes

- When you use a new Eye-Fi card for the first time, copy the install file of the PC application written in the Eye-Fi card first, then format the card.
- Before using the Eye-Fi card, upgrade the firmware of the Eye-Fi card to the latest version. For details on version upgrades, refer to the operating instructions supplied with the Eye-Fi card.
- When uploading image data, [Power Save] is not available.
- If the  (error) icon is displayed, eject and re-insert the Eye-Fi card, or turn the power of the camera off and on again. If the  (error) icon is still displayed, the Eye-Fi card may be corrupted. For details, contact Eye-Fi, Inc.
- Wireless LAN communication may be interrupted by the other communication devices. If data reception is insufficient, move the camera closer to the access point.
- For details on content that can be uploaded, refer to the operating instructions supplied with the Eye-Fi card.
- Some Eye-Fi cards have an “Endless Memory Mode.” This product does not support “Endless Memory Mode.” Make sure that Eye-Fi cards that you insert into this product have “Endless Memory Mode” turned off. For details on setting “Endless Memory Mode”, refer to the operating instructions supplied with the Eye-Fi card.

Format

Formats the memory card or the internal memory. When you use a memory card with this camera for the first time, it is recommended to format the card using the camera for stable performance of the memory card before shooting. Note that formatting permanently erases all data on the memory card, and is unrecoverable. Save precious data on a computer, etc.

1 MENU →  (Settings) →  (Memory Card Tool) or  (Internal Memory Tool) → [Format] → [OK] → ● on the control button



Note

- Note that formatting permanently erases all data including even protected images.

Create REC. Folder

Creates a folder in the memory card for recording images.

Images are recorded in the newly created folder until you create another folder or select another recording folder.

1 MENU →  (Settings) →  (Memory Card Tool) → [Create REC. Folder] → [OK] → ● on the control button

Notes

- This item is not displayed when the internal memory is used to record images.
- When you insert a memory card that was used with other equipment into the camera and shoot images, a new folder may be automatically created.
- Up to 4,000 images can be stored in one folder. When the folder capacity is exceeded, a new folder is automatically created.





On the folders

After a new folder is created, you can change the storage destination folder (page 99) and select the folder for viewing images (page 74).

Change REC. Folder

Changes the folder in the memory card that is currently used for recording images.



- 1 MENU →  (Settings) →  (Memory Card Tool) → [Change REC. Folder]
- 2 Select a folder with ◀/▶ on the control button.
- 3 [OK] → ●

Notes

- This item is not displayed when the internal memory is used to record images.
- The following folder cannot be selected as a recording folder.
 - “100” folder
 - A folder with a number that has only either “□□□MSDCF” or “□□□MNV01”.
- You cannot move recorded images to another folder.

Delete REC. Folder

Deletes a folder for recording images in the memory card.



- 1 MENU →  (Settings) →  (Memory Card Tool) → [Delete REC. Folder]
- 2 Select a folder with ◀/▶ on the control button.
- 3 [OK] → ●

Notes

- This item is not displayed when the internal memory is used to record images.
- If you delete the folder set as the recording folder using [Delete REC. Folder], the folder that has the largest folder number is selected as the next recording folder.
- You can delete only empty folders. If a folder contains images, or files that cannot be played back by the camera, first delete these images and files, and then delete the folder.

Copy

Copies all images in the internal memory to a memory card.



- 1 Insert a memory card with sufficient free capacity into the camera.
- 2 MENU →  (Settings) →  (Memory Card Tool) → [Copy] → [OK] → ● on the control button

Notes

- Use a fully charged battery pack. If you attempt to copy image files using a battery pack with little remaining charge, the battery pack may run out, causing copying to fail or possibly corrupting the data.
- Images cannot be copied individually.
- The original images in the internal memory are retained even after copying. To delete the contents of the internal memory, remove the memory card after copying, then format the internal memory ([Format] in [Internal Memory Tool]).
- A new folder is created on the memory card and all the data will be copied to it. You cannot choose a specific folder and copy images to it.

File Number



Selects the method used to assign file numbers to images.

- 1 MENU →  (Settings) →  (Memory Card Tool) or  (Internal Memory Tool) → [File Number] → desired mode → ● on the control button

✓	Series	Assigns numbers to files in sequence even if the recording folder or the memory card is changed. (When the replaced memory card contains a file with a number higher than the last assigned number, a number one higher than the largest number is assigned.)
	Reset	Starts from 0001 each time the folder is changed. (When the recording folder contains a file, a number one higher than the largest number is assigned.)

Area Setting

Adjusts the time to the local time of a selected area.

1 MENU →  (Settings) →  (Clock Settings) → [Area Setting] → desired setting → ● on the control button

✓	Home	You use the camera in your area. When the currently set area differs from your home area, you must make the Area Setting.
	Destination	You use the camera set to the time at your destination. Set the destination area.

Changing Area Setting



Setting a frequently visited destination lets you easily adjust the time when you visit that destination.



- ① Select the area part for [Destination], then press ● on the control button.
- ② Select an area with ◀▶ on the control button, and select Daylight Savings time with ▲▼.

Date & Time Setting

Sets the date and time again.

- 1 MENU →  (Settings) →  (Clock Settings) → [Date & Time Setting] → desired setting → ● on the control button
- 2 Set the numeric value and desired settings with ▲/▼/◀/▶.
- 3 [OK] → ●

Date & Time Format	You can select the date and time display format.
Daylight Savings	You can select Daylight Savings [On]/[Off].
Date & Time	You can set the date and time.

Note

- The camera does not have a feature for superimposing dates on images. By using “PMB” in the CD-ROM (supplied), you can print or save images with the date.

Viewing images on a TV

You can view images on a TV by connecting the camera to a TV.
The connection varies according to the type of TV the camera is connected to.
Refer also to the operating instructions supplied with the TV.

Viewing images by connecting the camera to a TV with the supplied cable for multi-use terminal

- 1 Turn off both the camera and the TV.
- 2 Connect the camera to the TV with the cable for multi-use terminal (supplied).

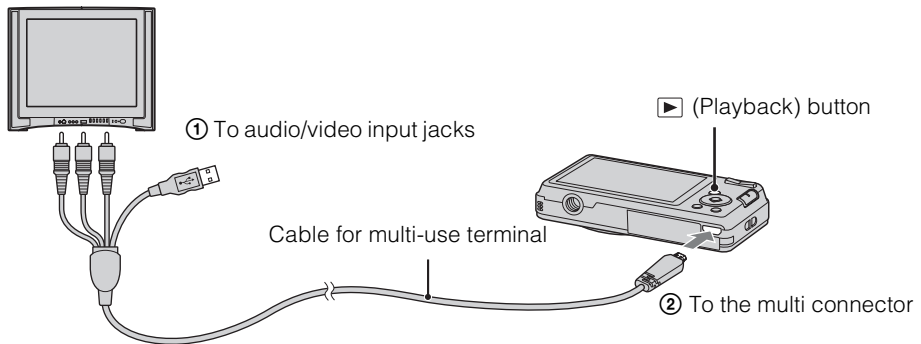

- 3 Turn on the TV and set the input.
- 4 Press  (Playback) button to turn on the camera.

Images shot with the camera appear on the TV. Select the desired image with the control button.

Notes

- When using the camera abroad, it may be necessary to switch the video signal output to match that of your TV system (page 89).
- The shooting image will not be displayed on the TV when the movie is shot under the condition of the camera and TV connected.
- When output to TV, Easy Viewing mode is invalid.

Viewing an image by connecting the camera to an HD TV

You can view an image recorded on the camera by connecting the camera to an HD (High Definition) TV with the HD Output Adaptor Cable (sold separately). Use a Type3a-compliant HD Output Adaptor Cable (sold separately).

- 1 Turn off both the camera and the TV.
- 2 Attach a conversion adaptor to an HD Output Adaptor Cable (sold separately) and connect the camera to an HD (High Definition) TV with the appropriate cable.

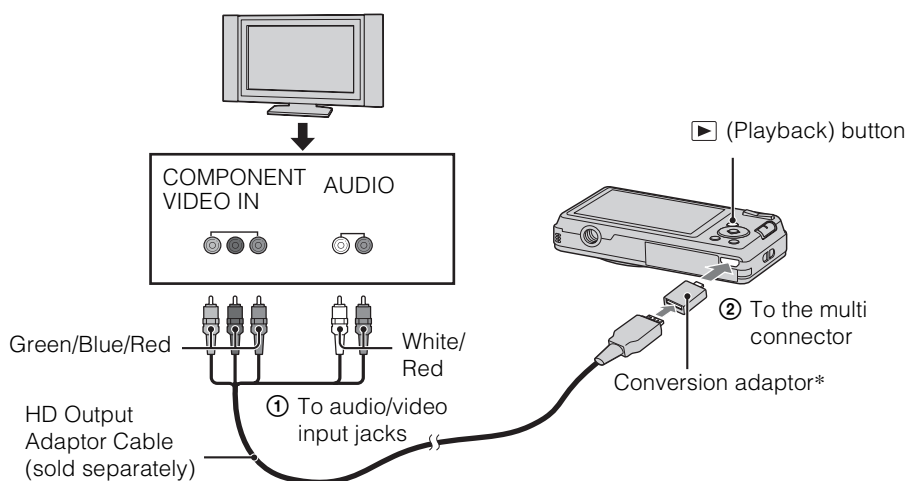

*The conversion adaptor is supplied with a Type3a-compliant HD Output Adaptor Cable (sold separately).

- 3 Turn on the TV and set the input.
- 4 Press  (Playback) button to turn on the camera.

Images shot with the camera appear on the TV. Select the desired image with the control button.

Notes

- Set [COMPONENT] to [HD(1080i)] (page 88).
- Images shot in [VGA] image size cannot be played back in HD format.
- When shooting movies in the condition with the camera and a TV connected using an HD Output Adaptor Cable (sold separately), the image being shot is not displayed in the TV side.
- When using the camera abroad, it may be necessary to switch the video signal output to match that of your TV system (page 89).
- When output to TV, Easy Viewing mode is invalid.

"PhotoTV HD"

This camera is compatible with the "PhotoTV HD" standard.

By connecting Sony PhotoTV HD-compatible devices using an HD Output Adaptor Cable (sold separately), whole new world of photos can be comfortably enjoyed in breathtaking Full HD quality.

- PhotoTV HD allows for a highly-detailed, photo-like expression of subtle textures and colors.
- The settings are also required to be made on the TV. For details, refer to the operating instruction of the TV.

On TV color systems

If you want to view images on a TV screen, you need a TV with a video input jack and the cable for multi-use terminal. The color system of the TV must match that of the digital still camera. Check the following lists for the TV color system of the country or region where the camera is used.

NTSC system

Bahama Islands, Bolivia, Canada, Central America, Chile, Colombia, Ecuador, Jamaica, Japan, Korea, Mexico, Peru, Surinam, Taiwan, the Philippines, the U.S.A., Venezuela, etc.

PAL system

Australia, Austria, Belgium, China, Croatia, Czech Republic, Denmark, Finland, Germany, Holland, Hong Kong, Hungary, Indonesia, Italy, Kuwait, Malaysia, New Zealand, Norway, Poland, Portugal, Rumania, Singapore, Slovak Republic, Spain, Sweden, Switzerland, Thailand, Turkey, United Kingdom, Viet Nam, etc.

PAL-M system

Brazil

PAL-N system

Argentina, Paraguay, Uruguay

SECAM system

Bulgaria, France, Greece, Guiana, Iran, Iraq, Monaco, Russia, Ukraine, etc.

Using with your computer

“PMB” and other applications are contained on the CD-ROM (supplied) to allow more versatile use of images shot with your Cyber-shot camera.

Recommended computer environment (Windows)

The following computer environment is recommended when using the supplied software “PMB”, “Music Transfer” or “PMB Portable” and importing images via a USB connection.

OS (pre-installed)	Microsoft Windows XP* ¹ SP3/Windows Vista* ² SP2/Windows7
Others	CPU: Intel Pentium III 800 MHz or faster (For playing/editing the High Definition movies: Intel Core Duo 1.66 GHz or faster/ Intel Core 2 Duo 1.20 GHz or faster) Memory: 512 MB or more (For playing/ editing the High Definition movies: 1 GB or more) Hard Disk: Disk space required for installation—approximately 500 MB Display: Screen resolution: 1,024 × 768 dots or more

*¹ 64-bit editions and Starter (Edition) are not supported.

*² Starter (Edition) is not supported.

Recommended computer environment (Macintosh)

The following computer environment is recommended when using the supplied software, “Music Transfer” or “PMB Portable” and importing images via a USB connection.

OS (pre-installed)	USB Connection: Mac OS X (v10.3 to v10.6) Music Transfer/PMB Portable: Mac OS X* (v10.4 to v10.6)
---------------------------	--

* Equipped with Intel Processor

Notes

- Operation is not assured in an environment based on an upgrade of the operating systems described above or in a multi-boot environment.
- If you connect two or more USB devices to a single computer at the same time, some devices, including the camera, may not operate, depending on the types of USB devices you are using.
- Connecting the camera using a USB interface that is compatible with Hi-Speed USB (USB 2.0) allows advanced transfer (high speed transfer), as the camera is compatible with Hi-Speed USB (USB 2.0).
- When your computer resumes activity from suspend or sleep mode, communication between the camera and your computer may not recover at the same time.

Using the software

Installing “PMB (Picture Motion Browser)” and “Music Transfer” (Windows)

- 1 Turn on your computer, and insert the CD-ROM (supplied) into the CD-ROM drive.

The installation menu screen appears.

- If it does not appear, double-click [Computer] (in Windows XP, [My Computer]) →  (SONYPMB).
- If the AutoPlay screen appears, select “Run Install.exe.” and follow the instructions that appear on the screen to proceed with the installation.

- 2 Click [Install].

The “Choose Setup Language” screen appears.

- 3 Select the desired language, then proceed to the following screen.

The “License Agreement” screen appears.





- 4 Carefully read the agreement, click the radio button (→) to accept the terms of the agreement, and then click [Next].

- 5 Follow the instructions on the screen to complete the installation.

- For the installation, connect the camera to the computer during the procedure (page 111).
- When the restarting confirmation message appears, restart the computer following the instructions on the screen.
- DirectX may be installed depending on the system environment of your computer.

- 6 Remove the CD-ROM after the installation is complete.

- 7 Start up the software.

- To start up “PMB”, click  (PMB) on the desktop.
For the detailed operation method, see the following PMB support page (English only):
<http://www.sony.co.jp/pmb-se/>
or click  (PMB Help).
- To start up “PMB” from the Start menu, select [Start] → [All Programs] →  (PMB).
- If “PMB” is already installed in your computer, by installing “PMB” from the CD-ROM (supplied), you can start up all of the application from “PMB Launcher”.
To start up “PMB Launcher”, double-click  (PMB Launcher) on the desktop.

Notes

- Log on as Administrator.
- When “PMB” is started up for the first time, the confirmation message of the Information tool appears on the screen. Select [Start].
- If “PMB” has been already installed on your computer and that “PMB” version number is lower than that of the supplied CD-ROM, re-install “PMB” using the supplied CD-ROM.
- If the version number is higher than that of the supplied CD-ROM, you do not need to re-install “PMB”. When you connect the camera and the computer via USB cable, the available “PMB” function is activated.
- If “PMB” has already been installed on your computer and that “PMB” version number is lower than 5.0, some functions may become invalid after you install “PMB” using the supplied CD-ROM. Also, you can start up “PMB” or other various software from “PMB Launcher” installed at the same time. To start up “PMB Launcher,” double-click  (PMB Launcher) on the desktop.

Installing “Music Transfer” (Macintosh)

- 1 Turn on your Macintosh computer, and insert the CD-ROM (supplied) into the CD-ROM drive.
- 2 Double-click  (SONYPMB).
- 3 Double-click the [MusicTransfer.pkg] file in the [Mac] folder.
The installation of the software starts.

Notes

- “PMB” is not compatible with Macintosh computers.
- Shut down all other application software before you install “Music Transfer”.
- For installation, you need to log on as Administrator.

Introduction to “PMB”

- “PMB” allows you to import images shot with the camera to a computer for display. Make a USB connection between the camera and your computer, and click [Import].
- Images on a computer can be exported to a memory card, and displayed on the camera. Make a USB connection between the camera and your computer, click [Export] → [Easy Export (PC Sync)] in the [Manipulate] menu, and click [Export].
- You can save and print images with the date.
- You can display images stored on a computer by shooting date in a calendar display.
- You can correct (Red Eye Correction, etc.) still images, and change the shooting date and time.
- You can upload images to media services. (An internet connection environment is required.)
- For other details, see  (PMB Help).

Introduction to “Music Transfer”

“Music Transfer” allows you to replace the Music files provided in the camera at the factory with your favorite tracks, and to delete and add Music files.
You can also restore the tracks stored at the factory to your camera.

The following track types can be imported using “Music Transfer”.

- MP3 files stored on the hard disk of your computer
- Music CD tracks
- Preset-music saved on the camera
- Before starting up “Music Transfer”, perform MENU →  (Settings) → [Main Settings] → [Download Music], and connect the camera to a computer.

For other details, see the help in “Music Transfer”.

Connecting the camera to the computer

1 Insert a sufficiently charged battery pack into the camera, or connect the camera to a wall outlet (wall socket) using the AC-LS5 AC Adaptor (sold separately) and the USB/AV/DC IN Cable for multi-use terminal (sold separately).

- Use a Type3a-compliant USB/AV/DC IN Cable (sold separately).

2 Turn on the computer, then press  (Playback) button.

3 Connect the camera to your computer.

- When a USB connection is established for the first time, your computer automatically runs a program to recognize the camera. Wait for a while.

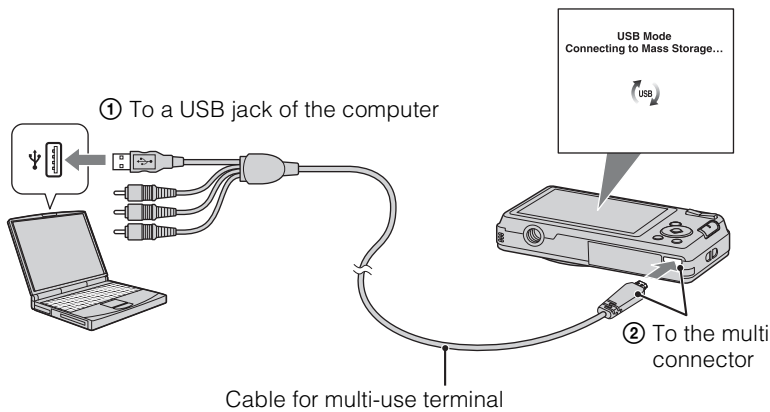

Importing images to a computer (Windows)

“PMB” allows you to easily import images.

For details on “PMB” functions, see the “PMB Help”.

Importing images to a computer without using “PMB”

When the AutoPlay Wizard appears after making a USB connection between the camera and a computer, click [Open folder to view files] → [OK] → [DCIM] or [MP_ROOT] → copy the desired images to the computer.

Importing images to a computer (Macintosh)

- 1 Connect the camera to your Macintosh computer first. Double-click the newly recognized icon on the desktop → the folder where the images you want to import are stored.
- 2 Drag and drop the image files to the hard disk icon.
The image files are copied to the hard disk.
- 3 Double-click the hard disk icon → the desired image file in the folder containing the copied files.
The image is displayed.

Deleting the USB connection

Perform the procedures from step 1 to 3 below before:

- Disconnecting the cable for multi-use terminal.
- Removing a memory card.
- Inserting a memory card into the camera after copying images from the internal memory.
- Turning off the camera.

- 1 Double-click the disconnect icon on the tasktray.
- 2 Click  (USB Mass Storage Device) → [Stop].
- 3 Confirm the device on the confirmation window, then click [OK].

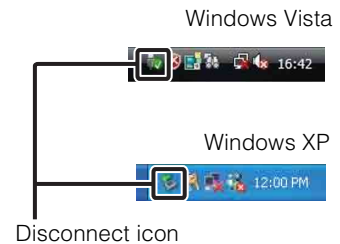

Note

- Drag and drop the icon of the memory card or the drive icon to the “Trash” icon beforehand when you use a Macintosh computer, and the camera is disconnected from the computer.

Uploading images to a media service

This camera has a built-in application “PMB Portable”.

You can use this application to do the following:

- You can easily upload images to a blog or other media service.
- You can upload images from a computer connected to the Internet even when you are away from home or the office.
- You can easily register the media services (such as blogs) you use frequently.

For details on “PMB Portable”, see the “PMB Portable” help.

Start “PMB Portable” (Windows)

When using “PMB Portable” for the first time, you must select the language. Follow the procedure below to make the selection. Once the language selection has been made, steps 3 to 5 are unnecessary the next time you use “PMB Portable”.

1 Make a USB connection between the camera and a computer.

When you connect the camera and your computer, AutoPlay Wizard appears.

Click [×] to close the AutoPlay Wizard for any unnecessary drives.

- If the desired AutoPlay Wizard does not appear, click [Computer] (in Windows XP, [My Computer]) → [PMBPORTABLE], then double-click “PMBP_Win.exe”.

2 Click “PMB Portable”.

(in Windows XP, click “PMB Portable” → [OK])

- If [PMB Portable] is not displayed within the AutoPlay Wizard, click [Computer] → [PMBPORTABLE], then double-click “PMBP_Win.exe”.

The Language Selection screen appears.

3 Select the desired language, then click [OK].

The Region Selection screen appears.

4 Select the appropriate [Region] and [Country/Area], and then click [OK].

The User Agreement screen appears.

5 Read the agreement carefully. If you accept the terms of the agreement, click [I Agree].

“PMB Portable” starts up.

Start “PMB Portable” (Macintosh)

- 1 Make a USB connection between the camera and a Macintosh computer.
When you connect the camera and your computer, [PMB Portable] appears on the desktop.
Click [×] to close any unnecessary drives.
- 2 Click [PMBPORTABLE] folder, then click [PMBP_Mac].
The Region Selection screen appears.
- 3 Select the appropriate [Region] and [Country/Area], and then click [OK].
The User Agreement screen appears.
- 4 Read the agreement carefully. If you accept the terms of the agreement, click [I Agree].
“PMB Portable” starts up.

Notes

- Set [LUN Setting] in [Main Settings] to [Multi].
- Always connect to a network when using “PMB Portable”.
- When uploading images over the Internet, the cache may remain in the computer being used depending on the service provider. This is also true when this camera is used for this purpose.
- When a bug occurs in “PMB Portable” or you delete “PMB Portable” by mistake, you can repair “PMB Portable” by downloading the PMB Portable installer from the web site.

Notes on “PMB Portable”

“PMB Portable” makes it possible to download the URLs of a number of websites from the server administered by Sony (the “Sony server”).

In order to use “PMB Portable” to enjoy the benefits of the image uploading service or other services (the “services”) provided by these and other websites, you must consent to the following.

- Some websites require registration procedures and/or fees to use their services. In using such services, you must comply with the terms and conditions established by the websites concerned.
- Services may be terminated or changed in accordance with the convenience of the website operators. Sony will not be held responsible for any trouble occurring between the users and third parties or any inconvenience caused to users relating to the utilization of the services inclusive of the termination or changes to such services.
- To view a website, you will be redirected to it by the Sony server. There may be times when you cannot access the website because of server maintenance or for other reasons.
- If the operation of the Sony server is to be terminated, you will be notified of the termination ahead of time on Sony’s website, etc.
- The URLs to which you are redirected by the Sony server and other information may be recorded for the purposes of improving Sony’s future products and services. However, no personal data will be recorded on such occasions.

Printing still images

You can print still images using the following methods.

- Printing directly using a printer which supports your memory card type
For details, see the operating instructions supplied with the printer.
- Printing using a computer
You can import images to a computer using the supplied “PMB” software and print the images.
You can insert the date on the image and print it. For details, see the “PMB Help”.
- Printing at a shop

Notes

- When you print still images shot in [16:9] mode, both edges may be cut off.
- You cannot print panoramic images depending on the printer.

Printing at a shop

You can take a memory card containing images shot with the camera to a photo printing service shop. As long as the shop supports photo printing services conforming to DPOF, you can make a **DPOF** (Print order) mark on images in advance in the playback mode so that you do not have to reselect them when you print them out at the shop.

Notes

- You cannot print images stored in the internal memory at a print shop directly from the camera. Copy the images to a memory card (page 101), then take the memory card to the print shop.
- Consult your photo printing service shop as to what types of memory card they handle.
- A memory card adaptor (sold separately) may be necessary. Consult your photo printing service shop.
- Before you take image data to a shop, always copy (back up) your data to a disk.
- You cannot set the number of prints.
- If you want to superimpose dates on images, consult your photo printing service shop.

Troubleshooting

If you experience trouble with the camera, try the following solutions.

❶ Check the items on pages 116 to 122.

If a code such as “C/E:□□:□□” appears on the screen, see page 123.

❷ Remove the battery pack, wait for about one minute, re-insert the battery pack, then turn on the power.

❸ Initialize the settings (page 87).

❹ Consult your Sony dealer or local authorized Sony service facility.

Be aware that by sending the camera for repair, you give consent that the contents of the internal memory, music files may be checked.

Additional information on this product and answers to frequently asked questions can be found at our Customer Support Website.
<http://www.sony.net/>

Battery pack and power

Cannot insert the battery pack.

- Make sure the direction of the battery is correct, and insert it until the battery eject lever is locked.

Cannot turn on the camera.

- After inserting the battery pack into the camera, it may take a few moments for the camera to power up.
- Insert the battery pack correctly.
- The battery pack is discharged. Insert a charged battery pack.
- The terminal section of the battery is dirty. Wipe any dust with a soft cloth lightly to clean the battery.
- Use a recommended battery pack.

The power turns off suddenly.

- Depending on the camera and battery temperature, the power may turn off automatically to protect the camera. In this case, a message is displayed on the LCD screen before the power turns off.
- When [Power Save] is set to [Standard] or [Stamina], if you do not operate the camera for a certain period of time while the power is on, the camera turns off automatically to prevent wearing down the battery pack. Turn on the camera again.

The remaining charge indicator is incorrect.

- This phenomenon occurs when you use the camera in an extremely hot or cold location.
- A discrepancy arose between the remaining charge indicator and the actual remaining battery charge. Fully discharge the battery pack once, then charge it to correct the indication. The indicator may not be accurate depending on the conditions of use.
- Battery capacity decreases over time and through repeated use. If decreased usage time between charges becomes significant, it is probably time to replace it with a new one.

Cannot charge the battery pack.

- You cannot charge the battery pack using the AC Adaptor (sold separately). Use the battery charger to charge the battery.

The CHARGE lamp flashes while charging the battery.

- Check that the battery pack type is NP-BN1.
- The CHARGE lamp flashes infrequently when you use a battery pack that has not been used for a long time.
- The CHARGE lamp (on the supplied battery charger) has two flash patterns, fast flash (approx. 0.15-second intervals) and slow flash (approx. 1.5-second intervals). If the lamp flashes quickly, remove the battery pack being charged, and then insert the same battery pack into the battery charger again (until it clicks). If the lamp flashes quickly again, this may indicate a battery pack problem. If the lamp flashes slowly, the charger is in standby mode and charging has temporarily stopped. Charging stops temporarily and standby mode results when the temperature is outside the range suitable for charging. Charging resumes and the CHARGE lamp lights when the temperature returns to the range suitable for charging. It is recommended to charge the battery pack within the proper charging temperature range between 10°C to 30°C (50°F to 86°F).
- Refer to page 131 for details.

Shooting still images/movies

Cannot record images.

- Images are recorded on the internal memory even when a memory card is inserted into the camera. Make sure that the memory card is fully inserted into the camera.
- Check the free capacity of the internal memory or the memory card. If it is full, do one of the following:
 - Delete unnecessary images (page 37).
 - Change the memory card.
- You cannot record images while charging the flash.
- When recording movies, it is recommended that you use the following memory cards:
 - “Memory Stick PRO Duo” (Mark2) media, “Memory Stick PRO-HG Duo” media
 - SD memory card, SDHC memory card or SDXC memory card (Class 4 or faster)
- Set [Demo Mode] to [Off] (page 86).

Smile Shutter function does not work.

- No image is shot if a smiling face is not detected.
- Set [Demo Mode] to [Off] (page 86).



Anti-blur function does not work.

- The anti-blur function may not work properly when shooting night scenes.
- Shoot after pressing the shutter button halfway down.

Recording takes a long time.

- When the shutter speed becomes slower than a certain speed in low light conditions, the NR (Noise Reduction) slow shutter function is activated automatically to reduce the image noise. Under such conditions, recording takes a long time.

The image is out of focus.

- The subject is too close. When shooting, make sure to position the lens farther away from the subject than the shortest shooting distance (approximately 4 cm (1 5/8 inches) (W)/60 cm (23 5/8 inches) (T) from the lens).
-  (Twilight) or  (Landscape) mode is selected in the Scene Selection when shooting still images.









Zoom does not work.

- You cannot use the optical zoom when shooting in Sweep Panorama.
- You cannot use the Smart zoom depending on the image size (page 78).
- You cannot use the digital zoom when:
 - Shooting movies.
 - The Smile Shutter is working.

Cannot select the Face Detection function.

- You can select Face Detection only when the focus mode is set to [Multi AF] and the metering mode is set to [Multi].



The flash does not work.

- You cannot use the flash when:
 - Burst mode is selected (page 46).
 -  (Twilight) or  (High Sensitivity) mode is selected in Scene Selection.
 - In Sweep Panorama
 - In Movie Mode
- Set the flash to  (On) (page 31) when the Scene Selection mode is set to  (Landscape),  (Gourmet),  (Pet),  (Beach),  (Snow) or  (Underwater) mode.

Fuzzy white circular spots appear in images shot using the flash.

- Particles (dust, pollen, etc.) in the air reflected the flash light and appeared in the image. This is not a malfunction.

The close-up shoot function (Macro) does not work.

- The camera automatically adjusts the focus. Press and hold the shutter button halfway down. Focus adjustment may take some time when shooting a close subject.
-  (Landscape) or  (Twilight) mode is selected in the Scene Selection.

The date and time are not displayed on the LCD screen.

- While shooting, the date and time are not displayed. They are displayed only during playback.

Cannot insert dates on images.

- This camera does not have a feature for superimposing dates on images. By using “PMB”, you can print or save images with the date (page 109).

The F value and shutter speed flash when you press and hold the shutter button halfway down.

- The exposure is incorrect. Correct the exposure (page 47).

The image colors are not correct.

- Adjust the White Balance (page 49).

White or purple streaks appear in bright areas of the subject, or the whole screen of the image becomes reddish.

- This phenomenon is called smearing. This is not a malfunction. Smearing is not recorded on still images, but is recorded as streaks or uneven colors on Sweep Panorama images or movies. (“Bright areas” refers to the sun or electric lights which are much brighter than surroundings.)

Noise appears in the image when you view the screen in a dark place.

- The camera is attempting to increase the visibility of the screen by temporarily brightening the image under conditions of low illumination. There is no effect on the recorded image.

The eyes of the subject come out red.

- Set [Red Eye Reduction] to [Auto] or [On] (page 80).
- Shoot the subject at a distance closer than the flash range using the flash.
- Light the room and shoot the subject.
- Retouch the image using [Retouch] → [Red Eye Correction] in viewing menu (page 69), or correct using “PMB”.

Dots appear and remain on the screen.

- This is not a malfunction. These dots are not recorded.

Cannot shoot images in succession.

- The internal memory or memory card is full. Delete unnecessary images (page 37).
- The battery level is low. Insert a charged battery pack.

The same image is shot several times.

- [Burst Settings] is set to [Burst] (page 46).
- [Scene Recognition] is set to [Advanced] (page 55).

Viewing images

Cannot play back images.

- Make sure that the memory card is fully inserted into the camera.
- The folder/file name has been changed on your computer.
- No guarantees are made for playing back, on this camera, files containing images which were processed on a computer or images which were shot using other cameras.
- The camera is in USB mode. Delete the USB connection (page 112).
- This is caused by copying images on your computer to the memory card without using the “PMB”. Register the unregistered images to the database file on the registration screen (page 34), or play such images in Folder view (page 68).

The date and time are not displayed.

- The screen display is set to display images only. Press the DISP (Screen Display Settings) button to display information (page 30).

Left and right sides of the screen are shown in black.

- [Auto Orientation] is set to [On] (page 79).

Cannot display images in index mode.

- Cancel the Easy Viewing mode if activated.

Cannot hear music during slideshow.

- Transfer music files to the camera with “Music Transfer” (pages 109, 110).
- Confirm that the volume setting and slideshow setting are correct (page 65).
- Slideshow is played back with [Continuous Playback]. Select [Slideshow with music] and play back.

The image does not appear on the TV.

- Check [Video Out] to see if the video output signal of the camera is set to the color system of your TV (page 89).
- Check whether the connection is correct (page 105).
- If the USB connector of the cable for multi-use terminal is connected to another device, disconnect it (page 112).
- When shooting movies with the camera and a TV connected, the image being shot is not displayed on the TV.

Deleting

Cannot delete an image.

- Cancel the protection (page 71).

Computers

A “Memory Stick PRO Duo” media is not recognized by a computer with a “Memory Stick” media slot.

- Check that the computer and the “Memory Stick” media Reader/Writer support “Memory Stick PRO Duo” media. Users of computers and “Memory Stick” media Readers/Writers made by manufacturers other than Sony should contact those manufacturers.
- If “Memory Stick PRO Duo” media is not supported, connect the camera to the computer (pages 111, 112). The computer recognizes the “Memory Stick PRO Duo” media.

Your computer does not recognize the camera.

- When the battery level is low, insert the charged battery pack or use the AC adaptor (sold separately).
- Set [USB Connect] to [Mass Storage] (page 90).
- Use the cable for multi-use terminal (supplied).
- Disconnect the cable for multi-use terminal from both the computer and the camera, and connect it again firmly.
- Disconnect all equipment other than the camera, the keyboard and the mouse from the USB connectors of your computer.
- Connect the camera directly to your computer without passing through a USB hub or other device.

Cannot import images.

- Connect the camera and your computer correctly making a USB connection (page 111).
- When you shoot images with a memory card formatted by a computer, you may not be able to import the images to a computer. Shoot using a memory card formatted by the camera (page 97).

After making a USB connection, “PMB” does not start automatically.

- Make the USB connection after the computer is turned on.

After making a USB connection, “PMB Portable” does not start.

- Set [LUN Setting] to [Multi].
- Set [USB Connect] to [Mass Storage].
- Connect the computer to the network.

Cannot play back images on your computer.

- If you are using “PMB”, refer to “PMB Help” (page 109).
- Consult the computer or software manufacturer.

The image and sound are interrupted by noise when you view a movie on a computer.

- You are playing back the movie directly from the internal memory or the memory card. Import the movie to your computer using “PMB” and play it back.

Images once exported to a computer cannot be viewed on the camera.

- Export them to a folder recognized by the camera, such as “101MSDCF”, then play back in Folder view (page 68).
- Register the image to the image database file, then play back in [Date View] (page 68).
- Event View is not available on this camera.

Memory card

Cannot insert a memory card.

- Insert the memory card in the correct direction.

You have formatted a memory card by mistake.

- All the data on the memory card is deleted by formatting. You cannot restore it.

Images are recorded on the internal memory even when a memory card is inserted into the camera.

- Make sure that the memory card is fully inserted into the camera.

Internal memory

Cannot play back or record images using the internal memory.

- There is a memory card inserted in the camera. Remove it.

Cannot copy the data stored in the internal memory to a memory card.

- The memory card is full. Copy to a memory card with sufficient capacity.

Cannot copy the data on the memory card or the computer to the internal memory.

- This feature is not available.

Printing

Cannot print an image.

- Refer to the operation manual of the printer.

Images are printed with both edges cut off.

- Depending on your printer, all the edges of the image may be cut off. Especially when you print an image shot with the image size set to [16:9], the lateral end of the image may be cut off.
- When printing images using your printer, cancel the trimming or borderless settings. Consult the printer manufacturer as to whether the printer provides these functions or not.
- When having images printed at a digital print shop, ask the shop whether they can print the images without cutting off both edges.

Cannot print images with the date.

- Using “PMB”, you can print images with date (page 109).
- The camera does not have a feature for superimposing dates on images. However, because the images shot with the camera include information on the recording date, you can print images with the date superimposed if the printer or the software can recognize Exif information. For compatibility with Exif information, consult the manufacturer of the printer or the software.
- If you use a photo printing service, ask them to superimpose the dates on images.

Others

The lens gets fogged.

- Moisture condensation has occurred. Turn off the camera and leave it for about an hour before using it.

The camera turns off with the lens portion extended.

- The battery pack is discharged. Replace it with a charged battery pack, then turn the camera on again.
- Do not attempt to force the lens that has stopped moving.

The camera becomes warm when you use it for a long time.

- This is not a malfunction.

The Clock Set screen appears when you turn on the camera.

- Set the date and time again (page 104).
- The internal rechargeable backup battery has discharged. Insert a charged battery, and set aside for 24 hours or more with the power left off.

The date or time is incorrect.

- The Area Setting is set to a different location than your current location. Change the setting by MENU →  (Settings) → [Clock Settings] → [Area Setting].

Warning indicators and messages

Self-diagnosis display

If a code starting with a letter of the alphabet appears, the self-diagnosis function on the camera is working. The last two digits (indicated by □□) will differ depending on the state of the camera.

If you cannot solve the problem even after trying the following corrective actions a few times, the camera may need repair.

Contact your Sony dealer or local authorized Sony service facility.

C:32:□□

- There is trouble with the camera's hardware. Turn the power off and on again.

C:13:□□

- The camera cannot read or write data on the memory card. Try turning off and on the camera again, or taking out and inserting the memory card several times.
- The internal memory has experienced a format error, or an unformatted memory card is inserted. Format the internal memory or the memory card (page 97).
- The inserted memory card cannot be used with the camera, or the data is damaged. Insert a new memory card.

E:61:□□

E:62:□□

E:91:□□

- A camera malfunction has occurred. Initialize the camera (page 87), then turn the power on again.

E:94:□□

- A malfunction that you cannot service has occurred. Contact your Sony dealer or local authorized Sony service facility. Inform them of the 5-digit code, which starts from "E".

Messages

If the following messages appear, follow the instructions.



- The battery level is low. Charge the battery pack immediately. Depending on the conditions of use or the type of battery pack, the indicator may flash even though there are still 5 to 10 minutes of remaining battery time left.

For use with compatible battery only

- The battery inserted is not an NP-BN1 (supplied) battery pack.

System error

- Turn the power off and then on again.

Camera overheating

Allow it to cool

- The camera temperature has risen. The power may turn off automatically, or you may be unable to record movies. Leave the camera in a cool location until the temperature goes down.

Internal memory error

- Turn the power off and then on again.

Reinsert the memory card

- The inserted memory card cannot be used in the camera (page 3).
- The terminal section of the memory card is dirty.
- The memory card is damaged.

Memory card type error

- The inserted memory card cannot be used in the camera (page 3).

This memory card may not record or play

- The inserted memory card cannot be used in the camera (page 3).

Error formatting internal memory

Error formatting memory card

- Format the media again (page 97).

Memory card locked

- You are using the memory card with the write-protect switch, and the switch is set to the LOCK position. Set the switch to the recording position.

Read only memory card

- The camera cannot record or delete images on this memory card.

No images

- No images that can be played back have been recorded in the internal memory.
- No images that can be played back have been recorded in this folder of the memory card.

No still images

- The selected folder or date does not contain a file that can be played back in a slideshow.

File found which was not recognized

- You tried to delete a folder containing a file that cannot be played on this camera. Delete the file with a computer and then delete the folder.

Folder error

- A folder with the same first three digit number already exists on the memory card (for example: 123MSDCF and 123ABCDE). Select another folder, or create a new folder (pages 98, 99).

Cannot create more folders

- The folder with a name beginning with “999” exists on the memory card. You cannot create any folders if this is the case.

Empty folder contents

- You tried to delete a folder containing one or more files. Delete all of the files and then delete the folder.

Folder protected

- You tried to delete a folder that was made read-only by PC or an other device.

Cannot display file

- An error occurred while the image was playing back.
No guarantees are made for playing back, on this camera, files containing images which were processed on a computer or images which were shot using other cameras.

Read only folder

- You have selected a folder that cannot be set as a recording folder on the camera. Select another folder (page 99).

File protected

- Release the protection (page 71).

Image size over limit

- You are playing back an image with size that cannot be played back on the camera.

Unable to detect face for retouch

- You may not be able to retouch the image depending on the image.

(Vibration warning indicator)

- Camera shake may occur due to insufficient light. Use the flash, or mount the camera on a tripod to secure the camera.

1280×720 (Fine) is not supported with this memory card

1280×720 (Standard) is not supported with this memory card

- For recording movies, it is recommended that you use a memory card of 1 GB or larger.

Turn the power off and on again

- The lens malfunction.

Maximum number of images already selected

- Up to 100 files can be selected when using [Multiple Images].
- You can add **DPOF** (Print order) marks to up to 999 files. Cancel the selection.

Error Playing Music

- Delete the Music file, or replace it with an uncorrupted Music file.
- Execute [Empty Music], then download a new Music files.

Error Formatting Music

- Execute [Empty Music].

Operation cannot be executed in unsupported files

- Processing and other editing functions of the camera cannot be performed on image files that have been processed using a computer or images that were recorded with other cameras.

Preparing Image Database File Please wait

- The camera restores the date information etc. in cases where images have been deleted on a PC, etc.
- The camera creates the necessary database files after the memory card is formatted.



- The number of images exceeds that for which date management in a database file by the camera is possible. To register new image files to the database file, delete unnecessary images from [Date View].



- Unable to register to the database file or play back in [Date View]. Import all the images to a computer using “PMB” and recover the memory card or internal memory.

Image Database File error Cannot recover

- Import all of the images to the computer with “PMB”, and format the memory card or the internal memory (page 97).
To view the images again with the camera, export the imported images to the camera with “PMB”.

Recording function unavailable due to high internal temperature

- The camera temperature has risen. You cannot record images until the temperature has dropped.

Recording has stopped due to increased camera temperature

- Recording has stopped due to a rise in temperature while recording a movie. Please wait until the temperature goes down.



- When you record movies for a long time, the camera temperature rises. In this case, stop recording movies.

Using the camera abroad

You can use the battery charger (supplied), and the AC-LS5 AC Adaptor (sold separately) in any country or region where the power supply is within 100 V to 240 V AC, 50/60 Hz.

Note

- An electronic voltage transformer is unnecessary and its use may cause a malfunction.

On TV color systems

If you want to view images on a TV screen, you need a TV with a video input jack and the cable for multi-use terminal. The color system of the TV must match that of the digital still camera. Check the following lists for the TV color system of the country or region where the camera is used.

NTSC system

Bahama Islands, Bolivia, Canada, Central America, Chile, Colombia, Ecuador, Jamaica, Japan, Korea, Mexico, Peru, Surinam, Taiwan, the Philippines, the U.S.A., Venezuela, etc.

PAL system

Australia, Austria, Belgium, China, Croatia, Czech Republic, Denmark, Finland, Germany, Holland, Hong Kong, Hungary, Indonesia, Italy, Kuwait, Malaysia, New Zealand, Norway, Poland, Portugal, Romania, Singapore, Slovak Republic, Spain, Sweden, Switzerland, Thailand, Turkey, United Kingdom, Viet Nam, etc.

PAL-M system

Brazil

PAL-N system

Argentina, Paraguay, Uruguay

SECAM system

Bulgaria, France, Greece, Guiana, Iran, Iraq, Monaco, Russia, Ukraine, etc.

Memory card

The types of memory cards that can be used with the camera are “Memory Stick PRO Duo” media, “Memory Stick PRO-HG Duo” media, “Memory Stick Duo” media, SD memory card, SDHC memory card and SDXC memory card. MultiMediaCard cannot be used.

Notes

- When you use a memory card with this camera for the first time, it is recommended to format the card using the camera for stable performance of the memory card before shooting. Note that formatting permanently erases all data on the memory card, and is unrecoverable. Save precious data on a computer, etc.
- A memory card formatted with a computer is not guaranteed to operate with the camera.
- Data read/write speeds differ depending on the combination of the memory card and the equipment used.
- Data may be corrupted in the following cases:
 - When the memory card is removed or the camera is turned off during a read or write operation
 - When the memory card is used in locations subject to static electricity or electrical noise
- We recommend backing up important data.
- Do not attach a label on the memory card itself nor on a memory card adaptor.
- Do not touch the terminal section of the memory card with your hand or a metal object.
- Do not strike, bend or drop the memory card.
- Do not disassemble or modify the memory card.
- Do not expose the memory card to water.
- Do not leave the memory card within the reach of small children. They might accidentally swallow it.
- Insert a memory card that fits the memory card slot size. Otherwise, it will cause a malfunction.
- Do not use or store the memory card under the following conditions:
 - High temperature locations such as the hot interior of a car parked in direct sunlight
 - Locations exposed to direct sunlight
 - Humid locations or locations with corrosive substances present

Note on using the memory card adaptor (sold separately)

- When inserting a memory card into a memory card adaptor, make sure the memory card is inserted facing in the correct direction, then insert it all the way in. Incorrect insertion may result in a malfunction.

“Memory Stick” media

The types of “Memory Stick Duo” media that can be used with the camera are listed in the table below. However, proper operation cannot be guaranteed for all “Memory Stick Duo” media functions.

“Memory Stick” media type	Recording/Playback
Memory Stick Duo (without MagicGate)	○*1
Memory Stick Duo (with MagicGate)	○*2
MagicGate Memory Stick Duo	○*1*2
Memory Stick PRO Duo	○*2*3
Memory Stick PRO-HG Duo	○*2*3*4

*1 High-speed data transfer using a parallel interface is not supported.

*2 “Memory Stick Duo” media, “MagicGate Memory Stick Duo” media, “Memory Stick PRO Duo” media and “Memory Stick PRO-HG Duo” media are equipped with MagicGate functions. MagicGate is copyright protection technology that uses encryption technology. Data recording/playback that requires MagicGate functions cannot be performed with the camera.

*3 [1280×720] size movies can be recorded.

*4 This camera does not support 8-bit parallel data transfer. It performs the same 4-bit parallel data transfer as the “Memory Stick PRO Duo” media.

Notes on using a “Memory Stick Micro” media (sold separately)

- This product is compatible with “Memory Stick Micro” media (“M2”). “M2” is an abbreviation for “Memory Stick Micro” media.
- To use a “Memory Stick Micro” media with the camera, be sure to insert the “Memory Stick Micro” media into an “M2” Adaptor as large as of Duo size. If you insert a “Memory Stick Micro” media into the camera without an “M2” Adaptor as large as of Duo size, you might not be able to remove it from the camera.
- Do not leave the “Memory Stick Micro” media within the reach of small children. They might accidentally swallow it.

Battery pack

On charging the battery pack

We recommend charging the battery pack in an ambient temperature of between 10 °C to 30 °C (50 °F to 86 °F). The battery pack may not be effectively charged in temperatures outside this range.

Effective use of the battery pack

- Battery performance decreases in low temperature surroundings. So in cold places, the operational time of the battery pack is shorter. We recommend the following to ensure longer battery pack use:
 - Put the battery pack in a pocket close to your body to warm it up, and insert it in the camera immediately before you start shooting.
- The battery pack will run out quickly if you use the flash or zoom frequently.
- We recommend having spare battery packs handy for two or three times the expected shooting time, and making trial shots before taking the actual shots.
- Do not expose the battery pack to water. The battery pack is not water-resistant.
- Do not leave the battery pack in extremely hot places, such as in a car or under direct sunlight.
- You may not be able to turn on the camera or the battery pack may not be effectively charged if the terminal section of the battery is dirty. In this case, wipe any dust with a soft cloth lightly to clean the battery.

Checking the remaining battery charge

- A remaining charge indicator appears on the LCD screen.



- It takes about one minute until the correct remaining charge indicator appears.
- The remaining charge indicator may not be correct under certain circumstances.
- When [Power Save] is set to [Standard] or [Stamina], if you do not operate the camera running on a battery pack for a certain amount of time, the brightness level on the LCD screen becomes dark, and then the camera automatically turns off to prevent wearing down the battery pack (Auto Power off).

How to store the battery pack

- Fully discharge the battery pack before storing and store it in a cool, dry place. To maintain the battery pack's function, fully charge the battery pack and then fully discharge it on the camera at least once a year while storing.
- To use the battery pack up, leave the camera in slideshow playback mode until the power goes off.
- To prevent staining the terminal, short-circuiting, etc., be sure to use a plastic bag to keep away from metal materials when carrying or storing.

On battery life

- The battery life is limited. Battery capacity decreases over time and through repeated use. If decreased usage time between charges becomes significant, it is probably time to replace it with a new one.
- The battery life varies according to how it is stored and the operating conditions and environment in which each battery pack is used.

Compatible battery pack

- The NP-BN1 (supplied) can be used only in N type compatible Cyber-shot models.

Battery charger

- Only NP-BN type battery packs (and no others) can be charged in the battery charger (supplied). Batteries other than the specified kind may leak, overheat, or explode if you attempt to charge them, posing a risk of injury from electrocution and burns.
- Remove the charged battery pack from the battery charger. If you leave the charged battery pack in the charger, battery life may be shortened.
- The CHARGE lamp of the supplied battery charger flashes in either way:
 - Fast flashing: Turns the light on and off repeatedly at the interval of 0.15 seconds.
 - Slow flashing: Turns the light on and off repeatedly at the interval of 1.5 seconds.
- When the CHARGE lamp flashes fast, remove the battery pack being charged, and then insert the same battery pack into the battery charger securely again. When the CHARGE lamp flashes fast again, this may indicate a battery error or that a battery pack other than the specified type has been inserted. Check that the battery pack is the specified type. If the battery pack is the specified type, remove the battery pack, replace it with a new one or another one and check if the battery charger operates correctly. If the battery charger operates correctly, a battery error may have occurred.
- When the CHARGE lamp flashes slowly, it indicates that the battery charger stops charging temporarily on standby. The battery charger stops charging and enters the standby status automatically when the temperature is outside of the recommended operating temperature. When the temperature gets back within the appropriate range, the battery charger resumes charging and the CHARGE lamp lights up again. We recommend charging the battery pack in an ambient temperature of between 10 °C to 30 °C (50 °F to 86 °F).

Intelligent Pantilter

Intelligent Pantilter (sold separately) allows you to take pictures, by having the camera detect people's faces.

For details, see the operating instructions supplied with Intelligent Pantilter.

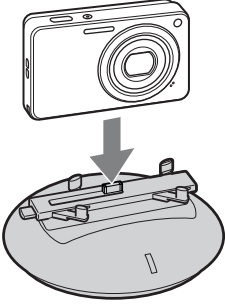

Note

- The Intelligent Pantilter may not be available in all countries or regions.

Table of contents

Operation Search

MENU/Settings Search

Index

Number of still images and recordable time of movies

The number of still images and recordable time may vary depending on the shooting conditions and the memory card.

Still images

(Units: Images)

Capacity Size	Internal memory	Memory card formatted with this camera				
	Approx. 27 MB	2 GB	4 GB	8 GB	16 GB	32 GB
14M	4	295	590	1150	2400	4800
10M	5	395	790	1600	3200	6400
5M	8	570	1100	2300	4650	9300
VGA	165	11500	23000	46500	93000	188000
16:9(11M)	5	360	720	1450	2900	5800
16:9(2M)	26	1800	3600	7300	14500	29000

Notes

- When the number of remaining shootable images is greater than 99,999, the “>99999” indicator appears.
- When an image shot with other cameras is played back on this camera, the image may not appear in the actual image size.

Movies

The table below shows the approximate maximum recording times. These are the total times for all movie files. Continuous shooting is possible for approximately 29 minutes at one time. The maximum size of a movie file is up to approximately 2 GB.

(h (hour), m (minute), s (second))

Capacity Quality/Size	Internal memory	Memory card formatted with this camera				
	Approx. 27 MB	2 GB	4 GB	8 GB	16 GB	32 GB
1280×720(Fine)	—	25m (20m)	55m (40m)	1h 50m (1h 20m)	3h 40m (2h 45m)	7h 25m (5h 30m)
1280×720(Standard)	—	40m (25m)	1h 20m (55m)	2h 40m (1h 50m)	5h 25m (3h 40m)	10h 50m (7h 25m)
VGA	1m (45s)	1h 20m (1h)	2h 40m (2h)	5h 25m (4h)	10h 50m (8h 5m)	21h 45m (16h 20m)

The number in () is the minimum recordable time.

Note

- The recordable time of movies varies because the camera is equipped with VBR (Variable Bit Rate), which automatically adjusts image quality depending on the shooting scene. When you record a fast-moving subject, the image is clearer but the recordable time is shorter because more memory is required for recording. The recordable time also varies depending on the shooting conditions, the subject or the image size settings.

Table of
contents

Operation
Search

MENU/Settings
Search

Index

Precautions

Internal memory and memory card back up

Do not turn off the camera, remove the battery pack, or remove the memory card while the access lamp is lit. Otherwise, the internal memory data or the memory card may be damaged. Be sure to make a backup copy to protect your data.

On database files

When you insert a memory card without a database file into the camera and turn on the power, part of the memory card capacity is used to automatically create a database file. It may take some time until you can perform the next operation.

On image data compatibility

- The camera conforms with DCF (Design rule for Camera File system) universal standard established by JEITA (Japan Electronics and Information Technology Industries Association).
- Sony does not guarantee that the camera will play back images recorded or edited with other equipment, or that other equipment will play back images recorded with the camera.

Do not use/store the camera in the following places

- In an extremely hot, cold or humid place
In places such as in a car parked in the sun, the camera body may become deformed and this may cause a malfunction.
- Under direct sunlight or near a heater
The camera body may become discolored or deformed, and this may cause a malfunction.
- In a location subject to rocking vibration
- Near strong magnetic place
- In sandy or dusty places
Be careful not to let sand or dust get into the camera. This may cause the camera to malfunction, and in some cases this malfunction cannot be repaired.

On carrying

Do not sit down in a chair or other place with the camera in the back pocket of your trousers or skirt, as this may cause malfunction or damage the camera.

On cleaning

Cleaning the LCD screen

Wipe the screen surface with an LCD cleaning kit (sold separately) to remove fingerprints, dust, etc.

Cleaning the lens

Wipe the lens with a soft cloth to remove fingerprints, dust, etc.

Cleaning the flash surface

Clean the flash surface before use. The heat of flash emission may cause dirt on the flash surface to become discolored or to stick to the flash surface, resulting in insufficient light emission.

Cleaning the camera surface

Clean the camera surface with a soft cloth slightly moistened with water, then wipe the surface with a dry cloth. To prevent damage to the finish or casing:

- Do not expose the camera to chemical products such as thinner, benzine, alcohol, disposable cloths, insect repellent, sunscreen or insecticide.
- Do not touch the camera with any of the above on your hand.
- Do not leave the camera in contact with rubber or vinyl for a long time.

On operating temperatures

Your camera is designed for use under the temperatures between 0°C and 40°C (32°F and 104°F). Shooting in extremely cold or hot places that exceed this range is not recommended.

On the internal rechargeable backup battery

This camera has an internal rechargeable battery for maintaining the date and time and other settings regardless of whether the power is on or off.

This rechargeable battery is continually charged as long as you are using the camera. However, if you use the camera for only short periods, it discharges gradually, and if you do not use the camera at all for about one month it becomes completely discharged. In this case, be sure to charge this rechargeable battery before using the camera.

However, even if this rechargeable battery is not charged, you can still use the camera, but the date and time will not be indicated.

Charging method of the internal rechargeable backup battery

Insert charged battery pack in the camera, and then leave the camera for 24 hours or more with the power off.

Trademarks

- The following marks are trademarks of Sony Corporation.
Cyber-shot, “Cyber-shot,” “Memory Stick,” , “Memory Stick PRO,” **MEMORY STICK PRO**, “Memory Stick Duo,” **MEMORY STICK DUO**, “Memory Stick PRO Duo,” **MEMORY STICK PRO DUO**, “Memory Stick PRO-HG Duo,” **MEMORY STICK PRO-HG DUO**, “Memory Stick Micro,” “MagicGate,” **MAGICGATE**, “PhotoTV HD”
- Microsoft, Windows, DirectX and Windows Vista are either registered trademarks or trademarks of Microsoft Corporation in the United States and/or other countries.
- Macintosh and Mac OS are trademarks or registered trademarks of Apple Inc.
- Intel, Pentium and Intel Core are trademarks or registered trademarks of Intel Corporation.
- SDXC logo is a trademark of SD-3C, LLC.
- MultiMediaCard is a trademark of MultiMediaCard Association.
- Adobe and Reader are either trademarks or registered trademarks of Adobe Systems Incorporated in the United States and/or other countries.
- In addition, system and product names used in this manual are, in general, trademarks or registered trademarks of their respective developers or manufacturers. However, the TM or ® marks are not used in all cases in this manual.

Table of
contents

Operation
Search

MENU/Settings
Search

Index

Index

A

AF Illuminator	75
AF range finder frame	52
Anti Blink	62
Area Setting	103
Auto Orientation	79

B

Battery charger	131
Battery pack	130
Beach	26
Beep	82
Blink Alert	81
Burst	46

C

Calendar	68
CD-ROM	109
Center AF	52
Center-weighted metering	54
Change REC. Folder	99
Clock Settings	104
COMPONENT	88
Computer	
Importing images	111, 112
Macintosh	110
Recommended computer environment	108
Windows	109
Connecting	
Computer	111
TV	105
Continuous Playback	65
Control button	15
Copy	101
Create REC. Folder	98

D

Date & Time Setting	104
Delete	37, 70
Delete REC. Folder	100
Demo Mode	86
Digital Zoom	78
DISP	30
Disp. Resolution	77
Display color	85
Download Music	92
DPOF	72
DRO	61

E

Easy Mode	22, 64
Easy Viewing	64
Empty Music	93
EV	47
Exposure	47
Eye-Fi	95

F

Face Detection	59
File Number	102
Flash	31
Focus	52
Folder	
Changing	99
Creating	98
Deleting	100
Selecting	74
Format	97
Function Guide	84

G

Gourmet	26
Grid Line	76

H

HD(1080i)	88
High Sensitivity	26

I

Identifying parts	15
Image Index	36
Image Size	43
In-Camera Guide	19, 63
Initialize	87
Install	109
Intelligent Auto.....	21
Intelligent Pantiler	132
Internal memory	18
ISO	48

L

Landscape	26
Language Setting	83
LUN Setting.....	91

M

Macintosh computer.....	108
Mass Storage	90
Memory card	3, 128
MENU	10
Metering Mode.....	54
Mode switch.....	20
Movie Mode.....	28
Movie shooting scene	40
MTP.....	90
Multi AF.....	52
Multi connector	105, 106, 111
Multi-pattern metering	54
Music Transfer.....	109, 110

N

NTSC	89
Number of still images	133

O

Optical zoom	29, 78
OS.....	108

P

PAL.....	89
Panorama.....	24
Panorama Image Size	43
Panorama Shooting Scene	41
PC.....	108
Pet.....	26
Pixel.....	45
Playback	
Movies.....	38
Still images.....	34
Playback Zoom.....	35
PMB	109
PMB Portable	113
Power Save.....	94
Precision digital zoom.....	78
Print	72, 115
Print order mark	72, 115
Program Auto.....	23
Protect.....	71
PTP	90

R

REC Mode.....	39
Red Eye Correction	69
Red Eye Reduction	80
Retouch.....	69
Rotate.....	73

S

Scene Recognition.....	55
Scene Selection.....	26
Screen Display Settings	30
SD.....	88
Select Folder	74
Self-diagnosis display.....	123
Self-portrait	33
Self-Timer.....	33
Settings.....	13
Shooting	
Movie.....	28
Still Image	21
Shooting Direction.....	42
Slideshow.....	65
Slideshow with music.....	66
Slow Synchro.....	31

Smart zoom	78
Smile Detection Sensitivity	58
Smile Shutter	32
Snow	27
Soft Skin	26
Soft Skin Effect	57
Soft Snap	26
Software	109
Spot AF	52
Spot metering	54
Sweep Panorama	24

T

Tracking focus	60
Trademarks	137
Trimming (Resize)	69
Troubleshooting	116
TV	105
Twilight	26
Twilight Portrait	26

U

Underwater	27
Underwater Sweep Panorama	41
Underwater White Balance	51
Unsharp masking	69
USB Connect	90
Using the camera abroad	127

V

VGA	43
Video Out	89
View Mode	68

W

Warning indicators and messages	123
White Balance	49
Windows computer	108

Z

Zoom	29
------------	----

Notes on the License

“C Library”, “Expat”, “zlib”, “dtoa”, “pcre” and “libjpeg” software are provided in the camera. We provide this software based on license agreements with their owners of copyright. Based on requests by the owners of copyright of these software applications, we have an obligation to inform you of the following. Please read the following sections.

Read “license1.pdf” in the “License” folder on the CD-ROM. You will find licenses (in English) of “C Library”, “Expat”, “zlib”, “dtoa”, “pcre” and “libjpeg” software.

THIS PRODUCT IS LICENSED UNDER THE MPEG-4 VISUAL PATENT PORTFOLIO LICENSE FOR THE PERSONAL AND NON-COMMERCIAL USE OF A CONSUMER FOR (i) ENCODING VIDEO IN COMPLIANCE WITH THE MPEG-4 VISUAL STANDARD (“MPEG-4 VIDEO”)

AND/OR

(ii) DECODING MPEG-4 VIDEO THAT WAS ENCODED BY A CONSUMER ENGAGED IN A PERSONAL AND NON-COMMERCIAL ACTIVITY AND/OR WAS OBTAINED FROM A VIDEO PROVIDER LICENSED BY MPEG LA TO PROVIDE MPEG-4 VIDEO.

NO LICENSE IS GRANTED OR SHALL BE IMPLIED FOR ANY OTHER USE. ADDITIONAL INFORMATION INCLUDING THAT RELATING TO PROMOTIONAL, INTERNAL AND COMMERCIAL USES AND LICENSING MAY BE OBTAINED FROM MPEG LA, LLC.

SEE

[HTTP://WWW.MPEGLA.COM](http://www.mpegla.com)

On GNU GPL/LGPL applied software

The software that is eligible for the following GNU General Public License (hereinafter referred to as “GPL”) or GNU Lesser General Public License (hereinafter referred to as “LGPL”) are included in the camera.

This informs you that you have a right to have access to, modify, and redistribute source code for these software programs under the conditions of the supplied GPL/LGPL.

Source code is provided on the web. Use the following URL to download it.

<http://www.sony.net/Products/Linux/>

We would prefer you do not contact us about the contents of source code.

Read “license2.pdf” in the “License” folder on the CD-ROM. You will find licenses (in English) of “GPL”, and “LGPL” software.

To view the PDF, Adobe Reader is needed. If it is not installed on your computer, you can download it from the Adobe Systems web page:

<http://www.adobe.com/>

Regarding the license for “Music Transfer” included on the CD-ROM (supplied)

MPEG Layer-3 audio coding technology and patents licensed from Fraunhofer IIS and Thomson.