

Video Camera Recorder Hi8

Operating Instructions

Before operating the unit, please read this manual thoroughly, and retain it for future reference.

Owner's Record

The model and serial numbers are located on the bottom. Record the serial number in the space provided below. Refer to these numbers whenever you call upon your Sony dealer regarding this product.

Model No. **CCD-TRV** _____ Model No. **AC**- _____

Serial No. _____ Serial No. _____

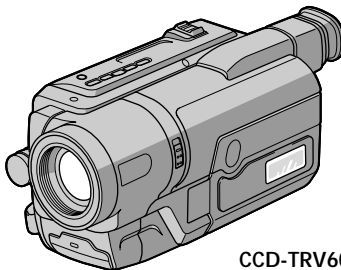

CCD-TRV608

Handycam Vision™



video **Hi8**

CCD-TRV107/TRV108/TRV308/
TRV408/TRV608 **Hi8**

Welcome!

Congratulations on your purchase of this Sony Handycam Vision™. With your Handycam Vision™, you can capture life's precious moments with superior picture and sound quality. Your Handycam Vision™ is loaded with advanced features, but at the same time it is very easy to use. You will soon be producing home video that you can enjoy for years to come.

WARNING

To prevent fire or shock hazard, do not expose the unit to rain or moisture.

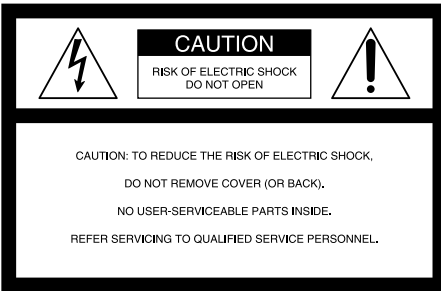

This symbol is intended to alert the user to the presence of uninsulated "dangerous voltage" within the product's enclosure that may be of sufficient magnitude to constitute a risk of electric shock to persons.



This symbol is intended to alert the user to the presence of important operating and maintenance (servicing) instructions in the literature accompanying the appliance.

Never expose the battery pack to temperatures above 60°C (140°F) such as in a car parked in the sun or under direct sunlight.

For the customers in the U.S.A. and Canada

RECYCLING LITHIUM-ION BATTERIES

Lithium-Ion batteries are recyclable. You can help preserve our environment by returning your used rechargeable batteries to the collection and recycling location nearest you.



For more information regarding recycling of rechargeable batteries, call toll free 1-800-822-8837, or visit <http://www.rbrc.org/>.

Caution: Do not handle damaged or leaking Lithium-Ion batteries.

For the customers in the U.S.A.

If you have any questions about this product, you may call:
Sony Customer Information Center 1-800-222-SONY (7669).
The number below is for the FCC related matters only.

Regulatory Information

Declaration of Conformity

Trade Name: SONY
Model No.: CCD-TRV608
Responsible Party: Sony Electronics Inc.
Address: 680 Kinderkamack Road,
Oradell, NJ 07649 U.S.A.
Telephone No.: 201-930-6972

This device complies with Part 15 of the FCC Rules. Operation is subject to the following two conditions.: (1) This device may not cause harmful interference, and (2) this device must accept any interference received, including interference that may cause undesired operation.

CAUTION

You are cautioned that any changes or modifications not expressly approved in this manual could void your authority to operate this equipment.

Note:

This equipment has been tested and found to comply with the limits for a Class B digital device, pursuant to Part 15 of the FCC Rules. These limits are designed to provide reasonable protection against harmful interference in a residential installation. This equipment generates, uses, and can radiate radio frequency energy and, if not installed and used in accordance with the instructions, may cause harmful interference to radio communications. However, there is no guarantee that interference will not occur in a particular installation. If this equipment does cause harmful interference to radio or television reception, which can be determined by turning the equipment off and on, the user is encouraged to try to correct the interference by one or more of the following measures:

- Reorient or relocate the receiving antenna.
- Increase the separation between the equipment and receiver.
- Connect the equipment into an outlet on a circuit different from that to which the receiver is connected.
- Consult the dealer or an experienced radio/TV technician for help.

The supplied interface cable must be used with the equipment in order to comply with the limits for a digital device pursuant to Subpart B of Part 15 of FCC Rules.

For the customers in CANADA

CAUTION

TO PREVENT ELECTRIC SHOCK, MATCH WIDE BLADE OF PLUG TO WIDE SLOT, FULLY INSERT.

Main Features

Taking moving images, and playing them back

- Recording a picture (p. 19)
- Playing back a tape (p. 29)

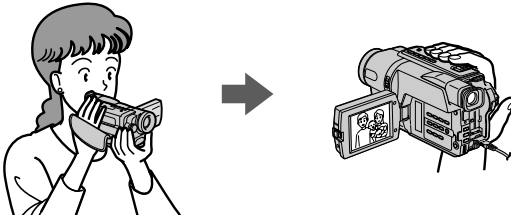

Capturing images on your computer*1)

- Viewing images recorded on a tape (p. 59)
- Viewing images live from your camcorder (p. 59)

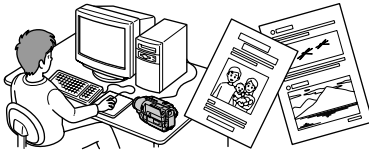

Others

Functions to adjust exposure in the recording mode

- BACK LIGHT (p. 25)
- NightShot (p. 26)
- PROGRAM AE (p. 38)
- Built-in light**2) (p. 46)
- Manual exposure (p. 40)

Functions to give images more impact

- Digital zoom (p. 22)
The default setting is set to OFF. (To zoom greater than 20 \times , select the digital zoom power in D ZOOM in the menu settings.)
- FADER (p. 35)
- Picture effect (p. 37)
- TITLE (p. 42)

Function to give a natural appearance to your recordings

- Manual focus (p. 41)

Functions to use in editing in the recording mode

- Wide mode (p. 33)
- Date and time (p. 16)
- ORC [MENU] (p. 70)

Function to use after recording

- Easy Dubbing (p. 51)

Function to make transition smooth

- END SEARCH (P.28)

*1) CCD-TRV608 only

**2) CCD-TRV107/TRV308/TRV408/TRV608 only

Table of contents

Main Features	4
---------------------	---

Quick Start Guide	6
--------------------------------	---

Getting started

Using this manual	8
Checking supplied accessories	10
Step 1 Preparing the power supply ...	11
Installing the battery pack	11
Charging the battery pack	12
Connecting to a wall outlet	15
Step 2 Setting the date and time	16
Step 3 Inserting a cassette	18

Recording – Basics

Recording a picture	19
Shooting backlit subjects	
– BACK LIGHT	25
Shooting in the dark	
– NightShot	26
Superimposing the date and time	
on pictures	27
Checking the recording	
– END SEARCH	28

Playback – Basics

Playing back a tape	29
Viewing the recording on TV	32

Advanced Recording Operations

Using the wide mode	33
Using the fader function	35
Using special effects – Picture effect ..	37
Using the PROGRAM AE function	38
Adjusting the exposure manually	40
Focusing manually	41
Superimposing a title	42
Making your own titles	44
Using the built-in light	
(CCD-TRV107/TRV308/TRV408/ TRV608 only)	46

Editing

Dubbing a tape	49
Dubbing a tape easily	
– Easy dubbing	51

PC Connection (CCD-TRV608 only)

Viewing images using your computer	
– USB Streaming	
(Windows users only)	59

Customizing Your Camcorder

Changing the menu settings	67
----------------------------------	----

Troubleshooting

Types of trouble	
and their solutions	73
Self-diagnosis display	77
Warning indicators and messages	78

Additional Information

About video cassettes	80
About the “InfoLITHIUM”	
battery pack	81
Using your camcorder abroad	83
Maintenance information and	
precautions	84
Specifications	89

Quick Reference

Identifying the parts and controls	91
Index	98

Quick Start Guide



This chapter introduces you to the basic features of your camcorder. See the page in parentheses “()” for more information.

1 Connecting the power cord (p. 15)

Use the battery pack when using your camcorder outdoors (p. 11).

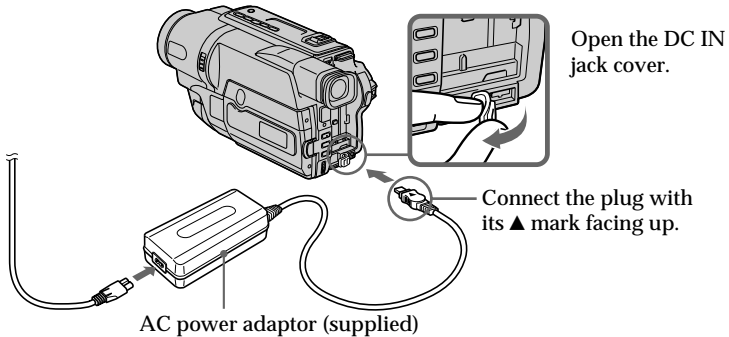

2 Inserting a cassette (p. 18)

1 Open the lid of the cassette compartment, and press **EJECT**. The cassette compartment opens automatically.



2 Insert a cassette into the cassette compartment with its window facing out and the write-protect tab on the cassette up.

3 Close the cassette compartment by pressing the **(PUSH)** mark on the cassette compartment. The cassette compartment automatically goes down. Close the lid of the cassette compartment.

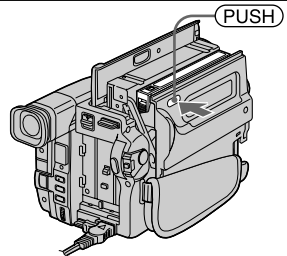
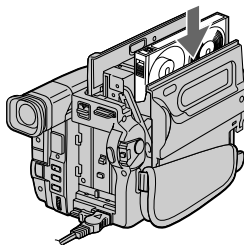
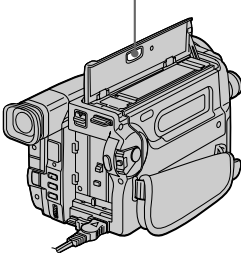

3 Recording a picture (p. 19)

- 1 Remove the lens cap.

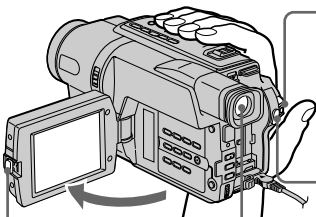

- 2 Set the POWER switch to CAMERA while pressing the small green button.

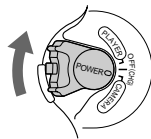

- 3 Open the LCD panel while pressing OPEN. The picture appears on the LCD screen.

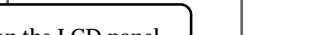

Viewfinder

When the LCD panel is closed, use the viewfinder placing your eye against its eyecup. The picture in the viewfinder is black and white. Adjust the viewfinder lens to your eyesight (p. 23).

- 4 Press START/STOP. Your camcorder starts recording. To stop recording, press START/STOP again.

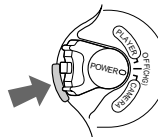

When you purchase your camcorder, the clock setting is set to off. If you want to record the date and time for a picture, set the clock setting before recording (p. 16).

4 Monitoring the playback picture on the LCD screen (p. 29)

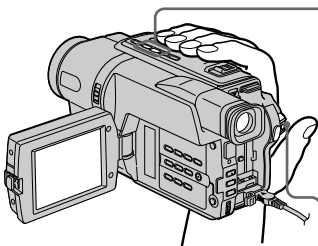

- 2 Press ◀◀ to rewind the tape.



- 3 Press ▶▶ to start playback.



- 1 Set the POWER switch to PLAYER while pressing the small green button.

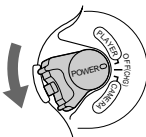

Note

Do not pick up your camcorder by the viewfinder, the LCD panel, or the battery pack.

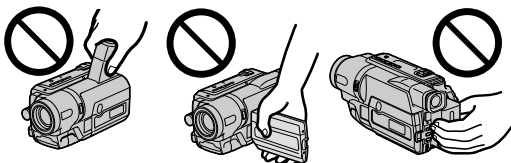

Using this manual

The instructions in this manual are for the five models listed in the table below. Before you start reading this manual and operating your camcorder, check the model number by looking at the bottom of your camcorder. The CCD-TRV608 is the model used for illustration purposes. Otherwise, the model name is indicated in the illustrations. Any differences in operation are clearly indicated in the text, for example, “CCD-TRV608 only.”

As you read through this manual, buttons and settings on your camcorder are shown in capital letters.

e.g. Set the POWER switch to CAMERA.

When you carry out an operation, you can hear a beep sound to indicate that the operation is being carried out.

Types of differences

CCD-	TRV107	TRV108	TRV308	TRV408	TRV608
Digital Zoom	450×	460×	460×	560×	560×
LCD Screen	6.2 cm (2.5 type)	6.2 cm (2.5 type)	6.2 cm (2.5 type)	6.2 cm (2.5 type)	7.5 cm (3 type)
Built-in light	●	—	●	●	●
Remote sensor	●	—	—	●	—
SteadyShot	—	—	●	●	●
USB Streaming	—	—	—	—	●
VF B.L. (Viewfinder backlight)	●	—	●	●	●

● Provided

— Not provided

Note on TV color systems

TV color systems differ from country to country. To view your recordings on a TV, you need an NTSC system-based TV.

Precautions on camcorder care

Lens and LCD screen/finder (on mounted models only)

- The LCD screen and the finder are manufactured using extremely high-precision technology so over 99.99% of the pixels are operational for effective use. However, there may be some tiny black points and/or bright points (white, red, blue or green in color) that constantly appear on the LCD screen and the finder. These points are normal in the manufacturing process and do not affect the recording in any way.
- Do not let your camcorder get wet. Keep your camcorder away from rain and sea water. Letting your camcorder get wet may cause your camcorder to malfunction. Sometimes this malfunction cannot be repaired [a].
- Never leave your camcorder exposed to temperatures above 60°C (140°F), such as in a car parked in the sun or under direct sunlight [b].
- Be careful when placing the camera near a window or outdoors. Exposing the LCD screen, the finder or the lens to direct sunlight for long periods may cause malfunctions [c].
- Do not directly shoot the sun. Doing so might cause your camcorder to malfunction. Take pictures of the sun in low light conditions such as dusk [d].

[a]



[b]

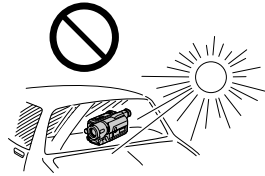

[c]

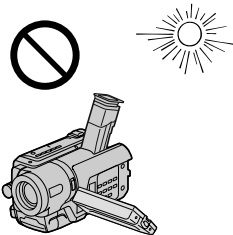

[d]

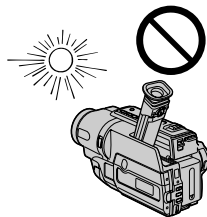

Checking supplied accessories

Make sure that the following accessories are supplied with your camcorder.

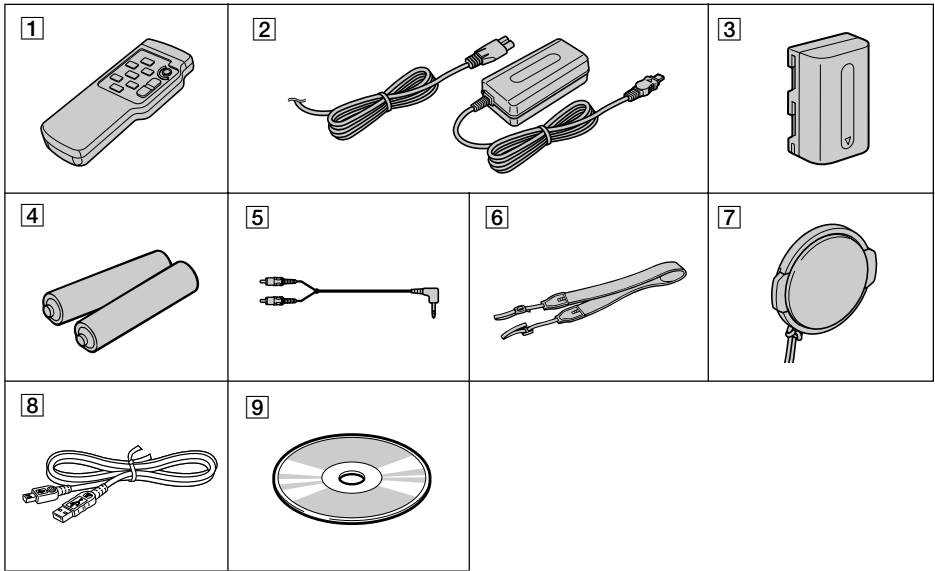

1 Wireless Remote Commander (CCD-TRV107/TRV408 only) (1) (p. 96)

2 AC-L10A/L10B/L10C AC power adaptor (1), Power cord (1) (p. 15)

3 NP-FM30 battery pack (1) (p. 11, 12)

4 Size AA (R6) battery for Remote Commander (CCD-TRV107/TRV408 only) (2) (p. 96)

5 A/V connecting cable (1) (p. 32)

6 Shoulder strap (1) (p. 91)

7 Lens cap (1) (p. 19, 95)

8 USB Cable (CCD-TRV608 only) (1) (p. 59)

9 CD-ROM (SPVD-008 USB Driver) (CCD-TRV608 only) (1) (p. 60)

Contents of the recording cannot be compensated if recording or playback is not made due to a malfunction of the camcorder, storage media, etc.

Step 1 Preparing the power supply

Installing the battery pack

Slide the battery pack down until it clicks.

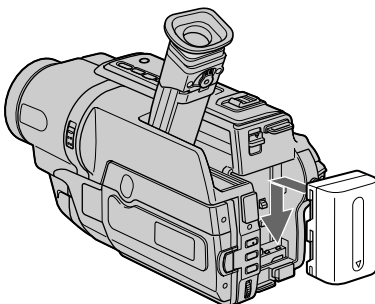

To remove the battery pack

Slide the battery pack out in the direction of the arrow while pressing ▼ BATT down.

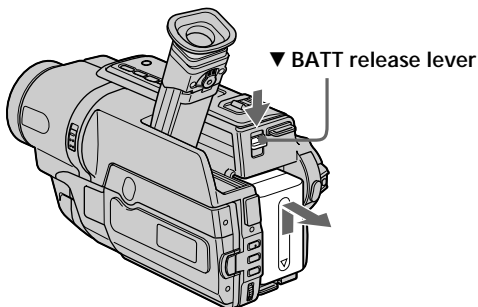

Step 1 Preparing the power supply

Charging the battery pack

Use the battery pack after charging it for your camcorder.

Your camcorder operates only with the "InfoLITHIUM" battery pack (M series).

See page 81 for details of the "InfoLITHIUM" battery pack.

(1) Open the DC IN jack cover and connect the AC power adaptor supplied with your camcorder to the DC IN jack with the plug's ▲ mark facing up.

(2) Connect the power cord to the AC power adaptor.

(3) Connect the power cord to a wall outlet.

(4) Set the POWER switch to OFF (CHG). Charging begins. The remaining battery time is indicated in minutes on the display window.

When the remaining battery indicator changes to , normal charge is completed. To fully charge the battery (full charge), leave the battery pack attached for about one hour after normal charge is completed until "FULL" appears in the display window. Fully charging the battery allows you to use the battery longer than usual.

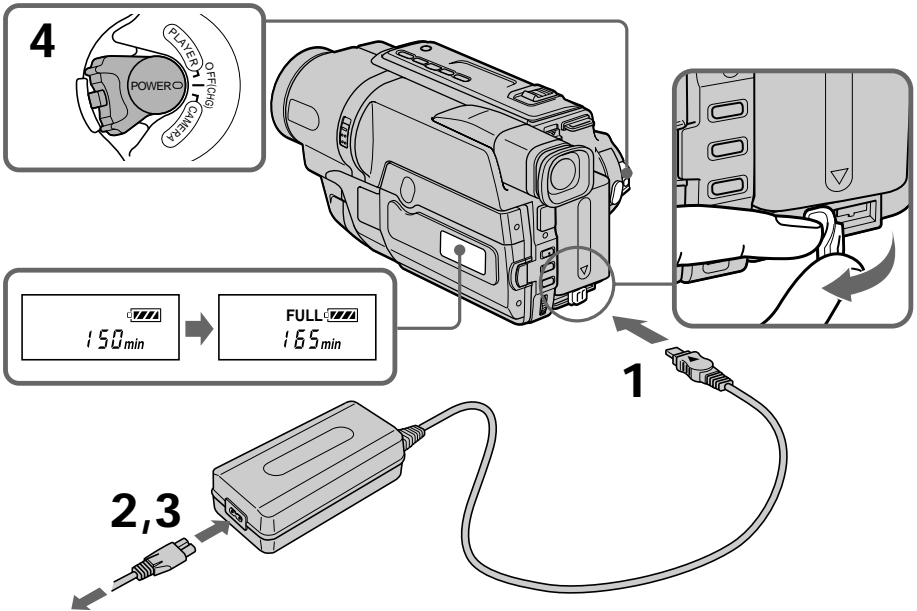

The number in the illustration of the display window may differ from that on your camcorder.

After charging the battery pack

Disconnect the AC power adaptor from the DC IN jack on your camcorder.

Step 1 Preparing the power supply

Note

Prevent metallic objects from coming into contact with the metal parts of the DC plug of the AC power adaptor. This may cause a short-circuit, damaging the AC power adaptor.

Remaining battery time indicator

The remaining battery time you record with the viewfinder is displayed. The remaining battery time indicator in the display window roughly indicates the recording time with the viewfinder.

Until your camcorder calculates the actual remaining battery time “---- min” appears in the display window.

While charging the battery pack, no indicator appears or the indicator flashes in the display window in the following cases:

- The AC power adaptor is disconnected.
- The battery pack is not installed properly.
- Something is wrong with the battery pack.

We recommend charging the battery pack in an ambient temperature of between 10°C to 30°C (50°F to 86°F).

If the power goes off although the battery remaining indicator indicates that the battery pack has enough power to operate

Charge the battery pack fully again so that the indication on the battery remaining indicator is correct.

Charging time

Battery pack	Full charge (normal charge)
NP-FM30 (supplied)	145 (85)
NP-FM50	150 (90)
NP-FM70	240 (180)
NP-QM71	260 (200)
NP-FM90	330 (270)
NP-FM91/QM91	360 (300)

Approximate number of minutes to charge an empty battery pack at 25°C (77°F)

Recording time

CCD-TRV107/TRV108/TRV308/TRV408

Battery pack	Recording with the viewfinder		Recording with the LCD screen	
	Continuous*	Typical**	Continuous*	Typical**
NP-FM30 (supplied)	165	90	120	65
NP-FM50	265	145	195	105
NP-FM70	540	295	400	220
NP-QM71	640	350	465	255
NP-FM90	820	450	600	330
NP-FM91/QM91	955	525	695	380

Step 1 Preparing the power supply

CCD-TRV608

Battery pack	Recording with the viewfinder		Recording with the LCD screen	
	Continuous*	Typical**	Continuous*	Typical**
NP-FM30 (supplied)	165	90	100	55
NP-FM50	265	145	160	90
NP-FM70	540	295	335	185
NP-QM71	640	350	390	215
NP-FM90	820	450	505	275
NP-FM91/QM91	955	525	585	320

Approximate number of minutes when you use a fully charged battery pack

* Approximate continuous recording time at 25°C (77°F). The battery life will be shorter if you use your camcorder in a cold environment.

** Approximate number of minutes when recording while you repeat recording start/stop, zooming and turning the power on/off. The actual battery life may be shorter.

Playing time

CCD-TRV107/TRV108/TRV308/TRV408

Battery pack	Playing time on LCD screen	Playing time with LCD closed
NP-FM30 (supplied)	120	175
NP-FM50	195	280
NP-FM70	400	570
NP-QM71	465	675
NP-FM90	600	865
NP-FM91/QM91	695	1010

CCD-TRV608

Battery pack	Playing time on LCD screen	Playing time with LCD closed
NP-FM30 (supplied)	100	175
NP-FM50	160	280
NP-FM70	335	570
NP-QM71	390	675
NP-FM90	505	865
NP-FM91/QM91	585	1010

Approximate number of minutes when you use a fully charged battery pack

Approximate continuous playing time at 25°C (77°F). The battery life will be shorter if you use your camcorder in a cold environment.

The recording and playing time of a normally charged battery are about 90% of those of a fully charged battery.

What is the "InfoLITHIUM"?

The "InfoLITHIUM" is a lithium ion battery pack which can exchange data such as battery consumption with compatible electronic equipment. This unit is compatible with the "InfoLITHIUM" battery pack (M series). Your camcorder operates only with the "InfoLITHIUM" battery pack. "InfoLITHIUM" M series battery packs have the

 mark.

"InfoLITHIUM" is a trademark of Sony Corporation.

Step 1 Preparing the power supply

Connecting to a wall outlet

When you use your camcorder for a long time, we recommend that you power it from a wall outlet using the AC power adaptor.

- (1) Open the DC IN jack cover, and connect the AC power adaptor to the DC IN jack on your camcorder with the plug's ▲ mark facing up.
- (2) Connect the power cord to the AC power adaptor.
- (3) Connect the power cord to a wall outlet.

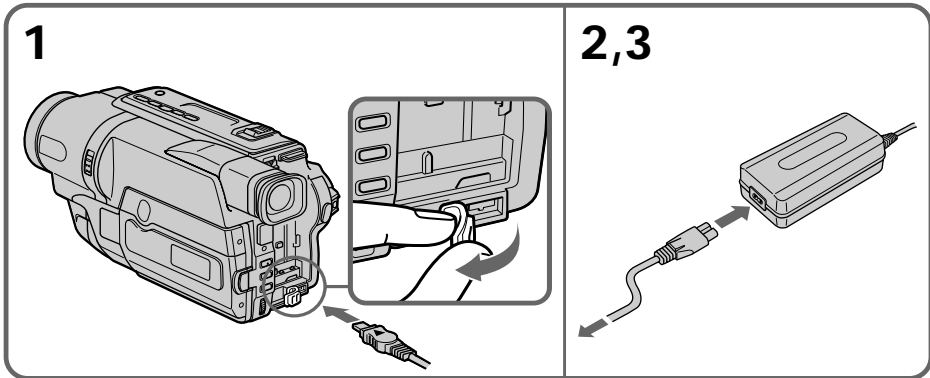

PRECAUTION

The set is not disconnected from the AC power source (wall outlet) as long as it is connected to the wall outlet, even if the set itself has been turned off.

Notes

- The AC power adaptor can supply power even if the battery pack is attached to your camcorder.
- The DC IN jack has "source priority." This means that the battery pack cannot supply any power if the power cord is connected to the DC IN jack, even when the power cord is not plugged into a wall outlet.
- Place the AC power adaptor near a wall outlet.
While using the AC power adaptor, if any trouble occurs with this unit, disconnect the plug from the wall outlet as soon as possible to cut off the power.

Using a car battery

Use Sony DC Adaptor/Charger (optional). Refer to the operating instructions of the DC Adaptor /Charger for further information.

Step 2 Setting the date and time

Set the date and time settings when you use your camcorder for the first time. "CLOCK SET" will be displayed each time when you set the power switch to CAMERA unless you set the date and time settings.

If you do not use your camcorder for about 6 months, the date and time settings may be released (bars may appear) because the built-in rechargeable battery in your camcorder will have been discharged.

First, set the year, then the month, the day, the hour and then the minute.

- (1) While your camcorder is in CAMERA mode, press MENU to display the menu.
- (2) Turn the SEL/PUSH EXEC dial to select , then press the dial.
- (3) Turn the SEL/PUSH EXEC dial to select CLOCK SET, then press the dial.
- (4) Turn the SEL/PUSH EXEC dial to adjust the desired year, then press the dial.
- (5) Set the month, day and hour by turning the SEL/PUSH EXEC dial and pressing the dial.
- (6) Set the minute by turning the SEL/PUSH EXEC dial and pressing the dial by the time signal. The clock starts to operate.
- (7) Press MENU to make the menu disappear. The time indicator appears.

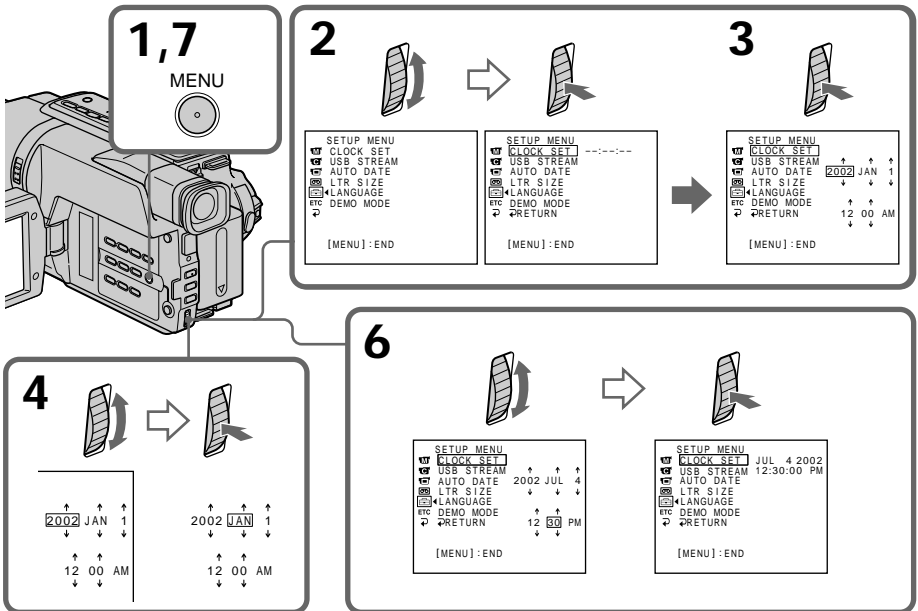

Step 2 Setting the date and time

To check the preset date and time

Press DATE to display the date indicator.

Press TIME to display the time indicator.

Press DATE (or TIME) and then press TIME (or DATE) to simultaneously display the date and time indicator.

Press DATE and/or TIME again. The date and/or time indicator disappears.

The year changes as follows:



Auto date function

When you use your camcorder for the first time, turn it on and set the date and time to your local time before you start recording (p. 16). The date is automatically recorded for 10 seconds after you start recording (**Auto date function**). This function works only once a day.

Note on the time indicator

The internal clock of your camcorder operates on a 12-hour cycle.

- 12:00 AM stands for midnight.
- 12:00 PM stands for noon.

Note on the auto date function

You can change the AUTO DATE setting by selecting ON or OFF in the menu settings. The auto date function automatically displays the date once a day.

However, the date may automatically appear more than once a day if:

- you set the date and time.
- you eject and insert the tape again.
- you stop recording within 10 seconds.
- you set AUTO DATE to OFF once and set it back to ON in the menu settings.

Step 3 Inserting a cassette

When you want to record in the Hi8 Hi8 system, use Hi8 Hi8 video cassettes.

- (1) Prepare the power supply (p. 11).
- (2) Open the lid of the cassette compartment, and press **EJECT**. The cassette compartment opens automatically.
- (3) Insert a cassette into the cassette compartment with its window facing out and the write-protect tab on the cassette up.
- (4) Close the cassette compartment by pressing the **(PUSH)** mark on the cassette compartment. The cassette compartment automatically goes down.
- (5) Close the lid of the cassette compartment.

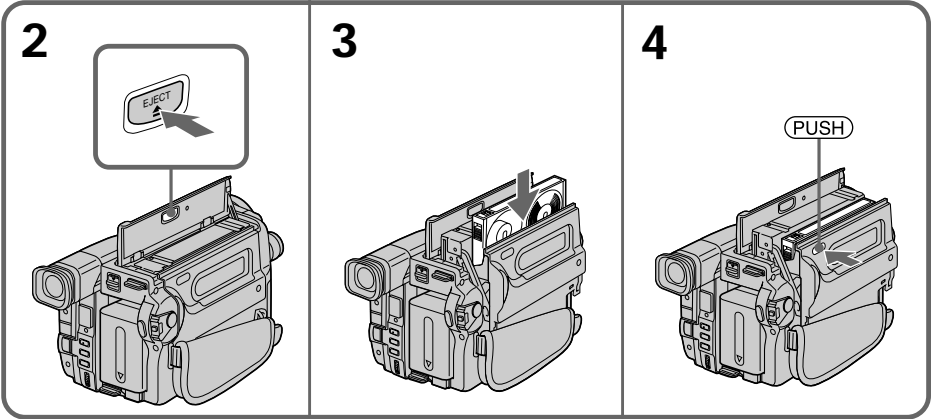

To eject a cassette

Follow the procedure above, and eject the cassette in step 3.

Notes

- Do not press the cassette compartment down. Doing so may cause a malfunction.
- The cassette compartment may not be closed when you press any part of the cassette compartment other than the **(PUSH)** mark.
- Do not pick up your camcorder by the lid of the cassette compartment.

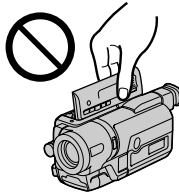

To prevent accidental erasure

Slide the write-protect tab on the cassette to expose the red mark.

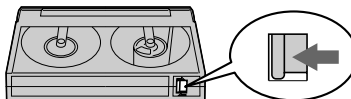

Recording a picture

Your camcorder automatically focuses for you.

- (1) Remove the lens cap by pressing both knobs on its sides and attach the lens cap to the grip strap.
- (2) Install the power source and insert a cassette. See “Step 1” to “Step 3” for more information (p. 11 to 18).
- (3) Set the POWER switch to CAMERA while pressing the small green button. Your camcorder is set to the standby mode.
- (4) Open the LCD panel while pressing OPEN. The viewfinder automatically turns off.
- (5) Press START/STOP. Your camcorder starts recording. The REC indicator appears. The recording lamp located on the front of your camcorder lights up. To stop recording, press START/STOP again. The recording lamp lights up in the viewfinder when you record with the viewfinder.

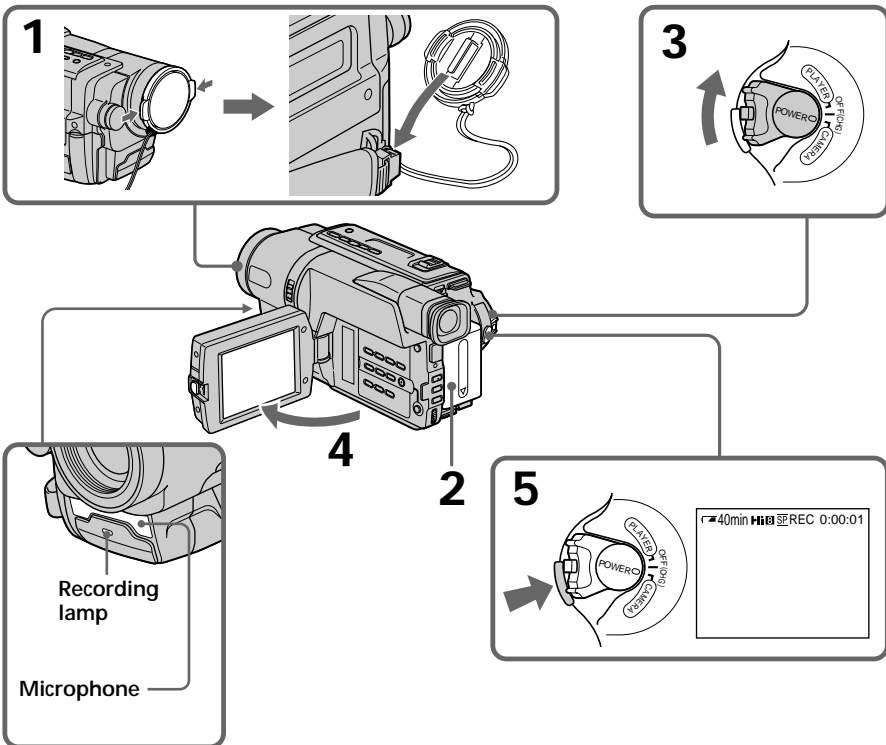

Notes

- Fasten the grip strap firmly.
- Do not touch the built-in microphone during recording.

Note on Recording mode

Your camcorder records and plays back in the SP (standard play) mode and in the LP (long play) mode. Select SP or LP in the menu settings (p. 70). In the LP mode, you can record twice as long as in the SP mode. When you record a tape in the LP mode on your camcorder, we recommend that you play back the tape on your camcorder.

Recording a picture

To enable smooth transition

You can make the transition between the last scene you recorded and the next scene smooth as long as you do not eject the cassette even if you turn off your camcorder. When you change the battery pack, set the POWER switch to OFF (CHG).

If you leave your camcorder in the standby mode for 5 minutes while the cassette is inserted

Your camcorder automatically turns off. This is to save battery power and to prevent battery and tape wear. To resume the standby mode for recording, set the POWER switch to OFF (CHG) once, then turn it to CAMERA, or press START/STOP without changing the POWER switch again to start recording. If your camcorder is in the standby mode, with no cassette inserted, it does not turn off automatically.

When you record in the SP and LP modes on one tape or you record some scenes in the LP mode

The playback picture may be distorted.

To set the counter to 0:00:00

Press COUNTER RESET (p. 94).

Adjusting the LCD screen

The LCD panel moves about 90 degrees to the viewfinder side and about 180 degrees to the lens side.

If you turn the LCD panel over so that it faces the other way, the ☺ indicator appears on the screen (Mirror mode).

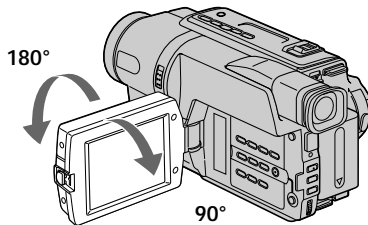

When closing the LCD panel, set it vertically until it clicks, and swing it into the camcorder body.

Note

When using the LCD screen except in the mirror mode, the viewfinder automatically turns off.

When you use the LCD screen outdoors in direct sunlight

The LCD screen may be difficult to see. If this happens, we recommend that you record with the viewfinder.

When you adjust angles of the LCD panel

Be sure to open the LCD panel up to 90 degrees.

Picture in the mirror mode

The picture on the LCD screen is a mirror-image. However, the picture will be normal when recorded.

Recording a picture

During recording in the mirror mode
DATE and TIME on your camcorder do not work.

Indicators in the mirror mode

- The STBY indicator appears as **II●** and REC as **●**. Some of other indicators appear mirror-reversed and others are not displayed.
- The date appears mirror-reversed when the auto date function is working. However, the date will be normal when recorded.

Adjusting the brightness of the LCD screen

- (1) In CAMERA mode, select LCD BRIGHT in  in the menu settings (p. 69).
- (2) Turn the SEL/PUSH EXEC dial to adjust the brightness of the LCD screen.

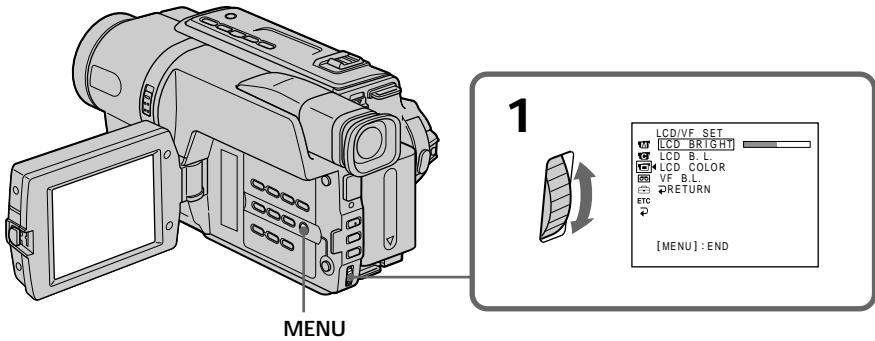

LCD screen backlight

You can adjust the brightness of the backlight. Select LCD B.L. in the menu settings (p. 69).

Even if you adjust the LCD screen backlight

The recorded picture will not be affected.

After recording

- (1) Set the POWER switch to OFF (CHG).
- (2) Close the LCD panel.
- (3) Eject the cassette.
- (4) Attach the lens cap.

After using your camcorder (CCD-TRV107/TRV308/TRV408/TRV608 only)

Remove the battery pack from your camcorder to avoid turning on the built-in light accidentally.

Recording a picture

Using the zoom feature

Move the power zoom lever a little for a slower zoom. Move it further for a faster zoom. Using the zoom function sparingly results in better-looking recordings.

“T” side: for telephoto (subject appears closer)

“W” side: for wide-angle (subject appears farther away)

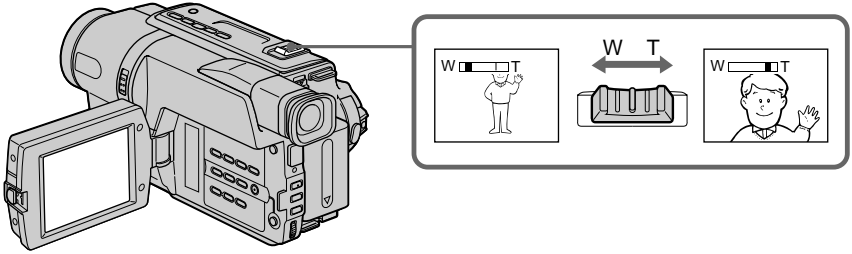

To use zoom greater than 20×

Zoom greater than 20× is performed digitally. To activate digital zoom, select the digital zoom power in D ZOOM in the menu settings. The digital zoom function is set to OFF as a default setting (p. 68).

The picture quality deteriorates as the picture is processed digitally.

The right side of the bar shows the digital zooming zone.
The digital zooming zone appears when you select the digital zoom power in D ZOOM in the menu settings.

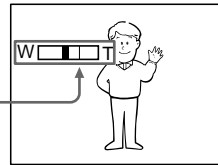

Notes on digital zoom

- Digital zoom starts to function when zoom exceeds 20×.
- The picture quality deteriorates as you go toward the “T” side.

When you shoot close to a subject

If you cannot get a sharp focus, move the power zoom lever to the “W” side until the focus is sharp. You can shoot a subject that is at least about 80 cm (about 2 feet 5/8 in.) away from the lens surface in the telephoto position, or about 1 cm (about 1/2 in.) away in the wide-angle position.

To record pictures with the viewfinder - Adjusting the viewfinder

If you record pictures with the LCD panel closed, check the picture with the viewfinder. Adjust the viewfinder lens to your eyesight so that the indicators in the viewfinder come into sharp focus.

Lift up the viewfinder and move the viewfinder lens adjustment lever.

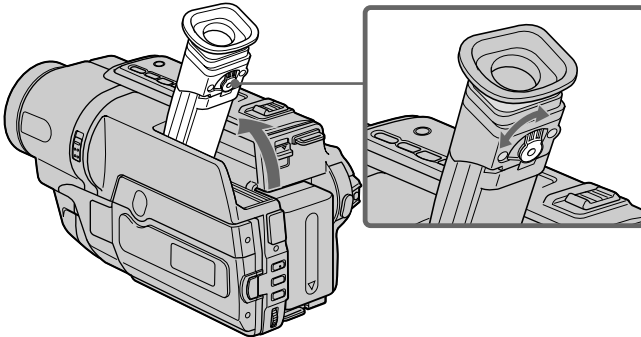

Viewfinder backlight (CCD-TRV107/TRV308/TRV408/TRV608 only)

You can change the brightness of the backlight. Select VF B.L. in the menu settings (p. 69).

Recording a picture

Indicators displayed in the recording mode

The indicators are not recorded on tape.

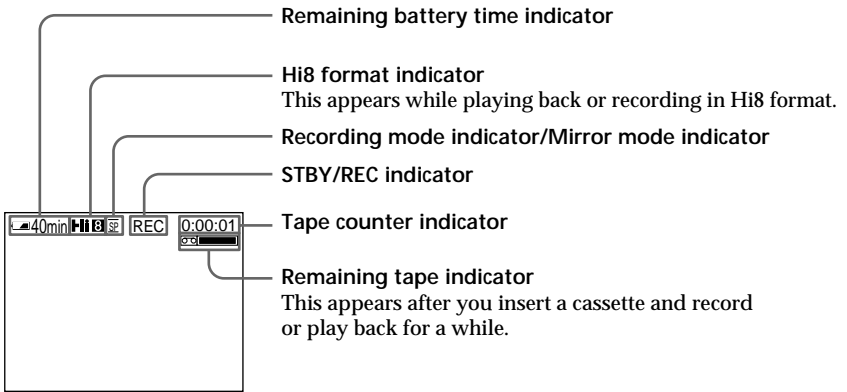

Remaining battery time indicator

The remaining battery time indicator indicates the approximate recording time. The indicator may not be correct, depending on the conditions in which you are recording. When you close the LCD panel and open it again, it takes about 1 minute for the correct remaining battery time in minutes to be displayed.

Shooting backlit subjects - BACK LIGHT

When you shoot a subject with the light source behind the subject or a subject with a light background, use the backlight function.

Press BACK LIGHT in CAMERA mode.

The  indicator appears on the screen.

To cancel, press BACK LIGHT again.

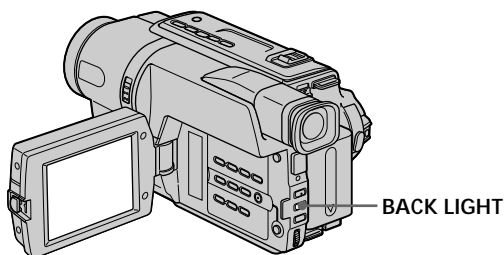

If you press EXPOSURE when shooting backlit subjects

The backlight function will be canceled.

Recording a picture

Shooting in the dark – NightShot

The NightShot function enables you to shoot a subject in a dark place. For example, you can satisfactorily record the environment of nocturnal animals for observation when you use this function.

While your camcorder is in CAMERA mode, slide NIGHTSHOT to ON.

☑ and “NIGHTSHOT” indicators flash on the screen.

To cancel the NightShot function, slide NIGHTSHOT to OFF.

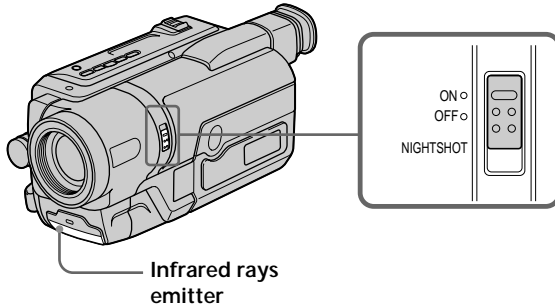

Using the NightShot Light

The picture will be clearer with the NightShot Light on. To enable the NightShot Light, set N.S.LIGHT to ON in the menu settings (p. 68).

Notes

- Do not use the NightShot function in bright places (ex. outdoors in the daytime). This may cause your camcorder to malfunction.
- When you keep NIGHTSHOT setting to ON in normal recording, the picture may be recorded in incorrect or unnatural colors.
- If focusing is difficult with the autofocus mode when using the NightShot function, focus manually.

While using the NightShot function, you cannot use the following functions:

- Exposure
- PROGRAM AE

NightShot Light

NightShot Light rays are infrared and so are invisible. The maximum shooting distance using the NightShot Light is about 3 m (10 feet).

Superimposing the date and time on pictures

You can record the date and/or time displayed on the screen superimposed on the picture.

Carry out the following operations in CAMERA mode.

Press DATE to record the date.

Press TIME to record the time.

Press DATE (or TIME), then press TIME (or DATE) to record the date and time.

Press DATE and/or TIME again. The date and/or time indicator disappears.

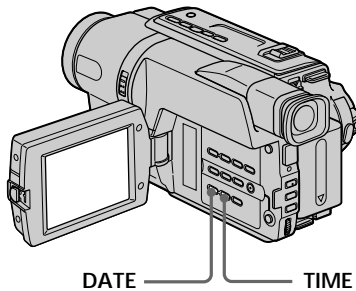

When you purchase your camcorder, the clock setting is set to off. Set the date and time to your local time before using (p. 16).

Note

The date and time indicators recorded manually cannot be deleted.

If you do not record the date and time in the picture

Record the date and time in the black screen as the background for about 10 seconds, then erase the date and time indicators before starting actual recording.

Checking the recording – END SEARCH

You can use this button to record a picture from the last recorded scene successively.

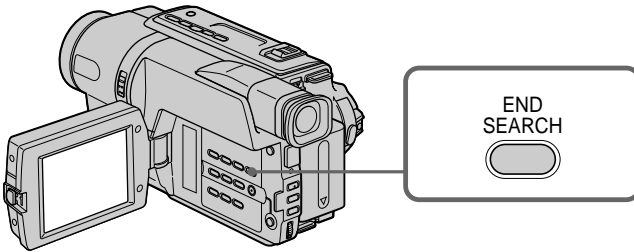

You can go to the end of the recorded section after you record.

Press END SEARCH in CAMERA mode.

The last 5 seconds of the recorded section are played back and returns to the standby mode. You can monitor the sound from the speaker.

Notes

- If you start recording after using the end search function, occasionally, the transition between the last scene you recorded and the next scene may not be smooth.
- Once you eject the cassette after you have recorded on the tape, the end search function does not work.

Playing back a tape

You can monitor the playback picture on the LCD screen. If you close the LCD panel, you can monitor the playback picture in the viewfinder.

- (1) Install the power source and insert the recorded tape.
- (2) Set the POWER switch to PLAYER while pressing the small green button.
- (3) Open the LCD panel while pressing OPEN.
- (4) Press ◀◀ to rewind the tape.
- (5) Press ▶ to start playback.
- (6) To adjust the volume, press either of the two VOLUME buttons. The speaker on your camcorder is silent when the LCD panel is closed.

You can control playback using the Remote Commander supplied with your camcorder. (CCD-TRV107/TRV408 only)

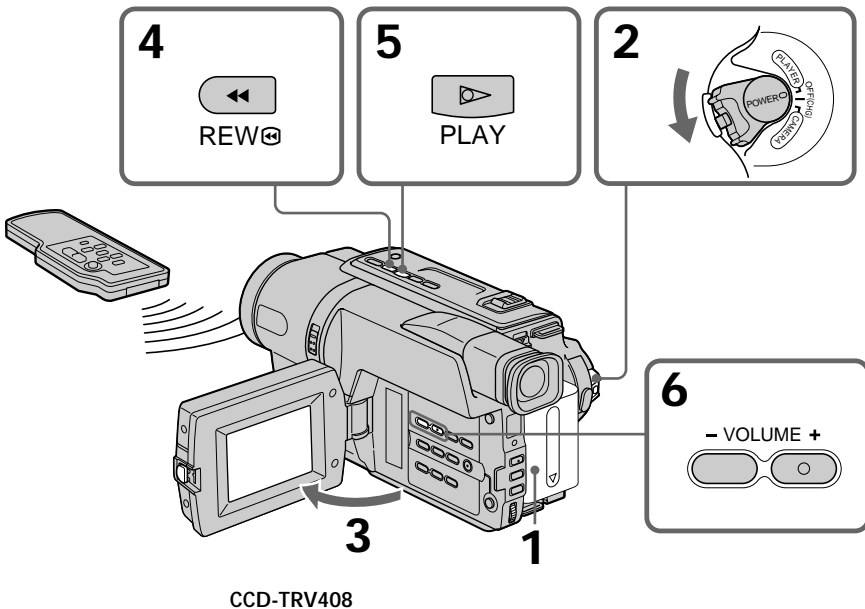

To stop playback

Press ■.

Playing back a tape

When monitoring on the LCD screen

You can turn the LCD panel over and move it back to the camcorder body with the LCD screen facing out [a]. You can adjust the angle of the LCD panel by lifting the LCD panel up by 7 degrees [b].

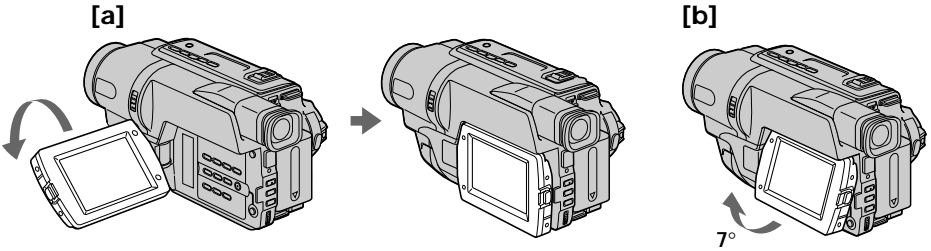

To display the screen indicators – Display function

Press DISPLAY on your camcorder or the Remote Commander (CCD-TRV107/TRV408 only) supplied with your camcorder.

The indicators appear on the screen.

To make the indicators disappear, press DISPLAY again.

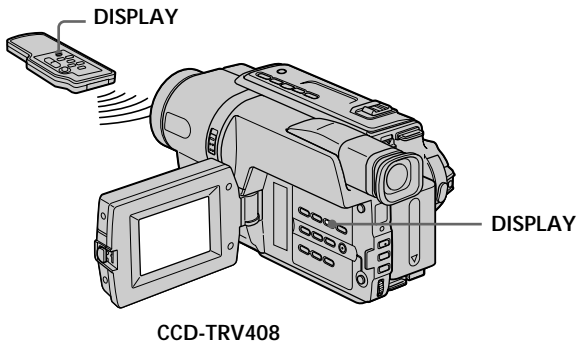

Various playback modes

To operate video control buttons, set the POWER switch to PLAYER.

To view a still image (playback pause)

Press **II** during playback. To resume playback, press **II** or **▶**.

To advance the tape

Press **▶▶** in the stop mode. To resume normal playback, press **▶**.

To rewind the tape

Press **◀◀** in the stop mode. To resume normal playback, press **▶**.

To locate a scene monitoring the picture (picture search)

Keep pressing **◀◀** or **▶▶** during playback. To resume normal playback, release the button.

To monitor the high-speed picture while advancing or rewinding the tape (skip scan)

Keep pressing **◀◀** while rewinding or **▶▶** while advancing the tape. To resume rewinding or advancing, release the button.

To view the picture at slow speed (slow playback) (CCD-TRV107/TRV408 only)

Press **▶** on the Remote Commander during playback. To resume normal playback, press **▶**.

To search the last scene recorded (END SEARCH)

Press END SEARCH in the stop mode. The last 5 seconds of the recorded section are played back and the playback stops.

In the various playback modes

Sound is muted.

When the playback pause mode lasts for 5 minutes

Your camcorder automatically enters the stop mode. To resume playback, press **▶**.

If slow playback lasts for about 1 minute (CCD-TRV107/TRV408 only)

Your camcorder automatically returns to normal speed.

When you play back a tape recorded in the LP mode

Noise may appear during playback pause mode, slow playback* or picture search.

When you play back a tape in reverse

Horizontal noise may appear at the center or top and bottom of the screen. This is not a malfunction.

* CCD-TRV107/TRV408 only

Viewing the recording on TV

Connect your camcorder to your TV with the A/V connecting cable supplied with your camcorder to watch the playback picture on the TV screen. You can operate the playback control buttons in the same way as when you monitor playback pictures on the LCD screen. We recommend that you power your camcorder from a wall outlet using the AC power adaptor, when monitoring the playback picture on the TV screen (p. 15). Refer to the operating instructions of your TV.

Open the jack cover. Connect your camcorder to the TV using the A/V connecting cable. Then, set the TV/VCR selector on the TV to VCR.

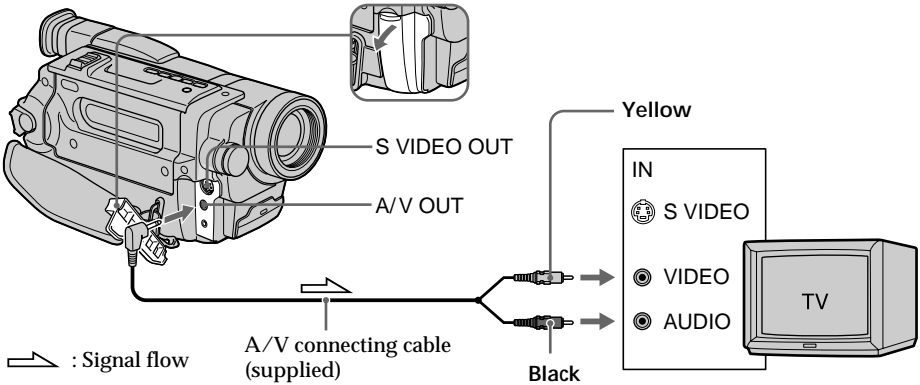

If your TV is already connected to a VCR

Connect your camcorder to the LINE IN input on the VCR by using the A/V connecting cable supplied with your camcorder. Set the input selector on the VCR to LINE.

To connect to a TV without Video/Audio input jacks

Use an NTSC system RFU adaptor (optional). Refer to the operating instructions of your TV and the RFU adaptor.

If your TV is a stereo type

Connect the audio plug of the A/V connecting cable supplied to the left (white) input jack of your TV.

If your TV has an S video jack

Connect using an S video cable (optional) to obtain optimum quality screen images. With this connection, you do not need to connect the yellow (video) plug of the A/V connecting cable.

Connect an S video cable (optional) to the S video jacks on both your camcorder and the TV.

To display the screen indicators on TV

Set DISPLAY to V-OUT/LCD in the menu settings (p. 72). Then press DISPLAY on your camcorder. To turn off the screen indicators, press DISPLAY on your camcorder again.

Using the wide mode

You can record a cinema-like picture (CINEMA) or a 16:9 wide picture to watch on the 16:9 wide-screen TV (16:9FULL). Refer to the operating instructions of your TV.

CINEMA

Black bands appear on the screen during recording in the CINEMA mode [a], playing back on a normal TV [b] or a wide-screen TV [c]. If you set the screen mode of the wide-screen TV to the zoom mode, a picture without black bands appears [d].

16:9FULL

The picture during recording in the 16:9FULL mode [e], or playing back on a normal TV [f] or a wide-screen TV [g] is horizontally compressed. If you set the screen mode of the wide-screen TV to the full mode, you can watch correctly proportioned images in wide-screen format [h].

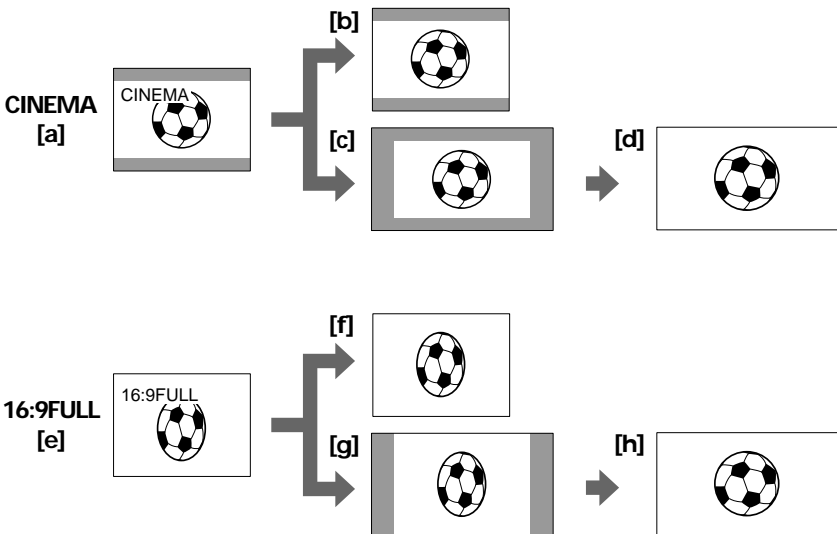

Using the wide mode

In CAMERA mode, set 16:9WIDE to CINEMA or 16:9FULL in  in the menu settings (p. 68).

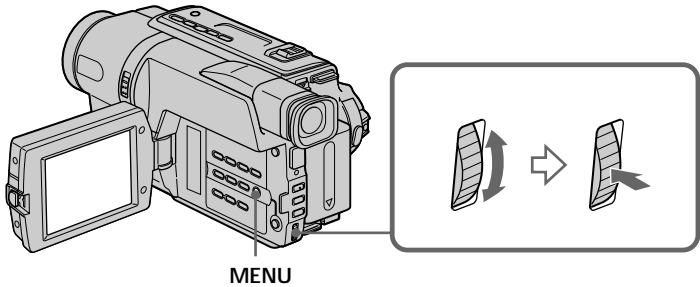

To cancel the wide mode

Set 16:9WIDE to OFF in the menu settings.

If the wide mode is set to 16:9FULL (CCD-TRV308/TRV408/TRV608 only)

The SteadyShot function does not work. If you select 16:9FULL in the menu settings when the SteadyShot function is working,  flashes and the SteadyShot function does not function.

In the wide mode

You cannot select the bounce function with FADER.

Date or time indicator

When you record in the 16:9FULL mode, the date or time indicator will be widened on wide-screen TVs.

During recording

You cannot select or cancel the wide mode. When you cancel the wide mode, set your camcorder to the standby mode and then set 16:9WIDE to OFF in the menu settings.

Using the fader function

You can fade in or out to give your recording a professional appearance.

[a] STBY REC

FADER



M.FADER
(mosaic)



STRIPE

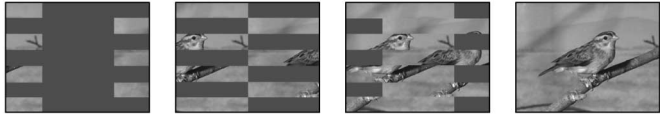

BOUNCE
(Fade in only)

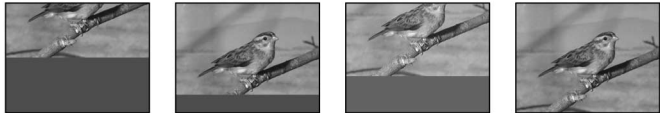

[b] STBY REC

MONOTONE

When fading in, the picture gradually changes from black-and-white to color.
When fading out, the picture gradually changes from color to black-and-white.

Using the fader function

(1) When fading in [a]

In the standby mode, press FADER until the desired fader indicator flashes.

When fading out [b]

In the recording mode, press FADER until the desired fader indicator flashes.

The indicator changes as follows:

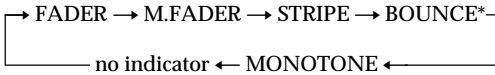

The last selected fader mode is indicated first of all.

* Fade in only

(2) Press START/STOP. The fader indicator stops flashing.

After the fade in/out is carried out, your camcorder automatically returns to the normal mode.

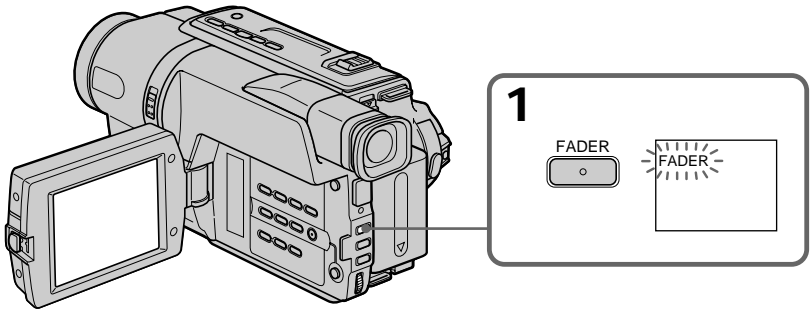

To cancel the fader function

Before pressing START/STOP, press FADER until the indicator disappears.

The date, time indicator and title do not fade in or fade out

Erase them before operating the fader function if they are not needed.

While using the bounce function, you cannot use the following functions:

- Focus
- Zoom
- Picture effect

Note on the bounce function

The BOUNCE indicator does not appear in the following mode or functions:

- D ZOOM is activated in the menu settings
- Wide mode
- Picture effect
- PROGRAM AE

Using special effects – Picture effect

You can digitally process images to obtain special effects like those in films or on the TV.

- PASTEL [a]** : The contrast of the picture is emphasized, and the picture looks like an animated cartoon.
- NEG.ART [b]** : The color and brightness of the picture are reversed.
- SEPIA** : The picture is sepia.
- B&W** : The picture is monochrome (black-and-white).
- SOLARIZE [c]** : The light intensity is clearer, and the picture looks like an illustration.
- MOSAIC [d]** : The picture is mosaic.
- SLIM [e]** : The picture expands vertically.
- STRETCH [f]** : The picture expands horizontally.

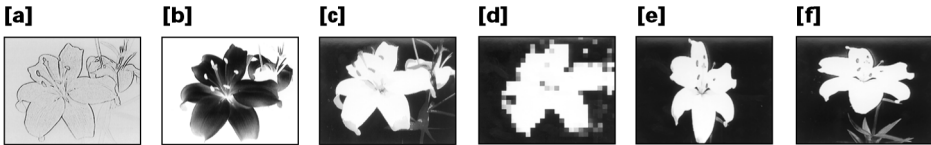

- (1) In CAMERA mode, select P EFFECT in  in the menu settings (p. 68).
- (2) Select the desired picture effect mode in the menu settings, then press the SEL/PUSH EXEC dial.

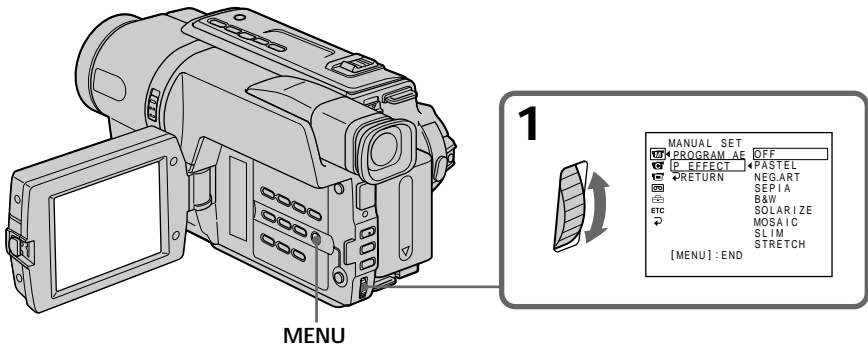

To cancel the picture effect function

Set P EFFECT to OFF in the menu settings.

When you set the POWER switch to OFF (CHG)

Your camcorder automatically returns to the normal mode.

Using the PROGRAM AE function

You can select the PROGRAM AE (Auto Exposure) mode to suit your specific shooting requirements.

 **SPOTLIGHT (Spotlight)**

This mode prevents people's faces, for example, from appearing excessively white when shooting subjects lit by strong light in the theater.

 **PORTRAIT (Soft portrait)**

This mode brings out the subject while creating a soft background for subjects such as people or flowers.

 **SPORTS (Sports lesson)**

This mode minimizes shake on fast-moving subjects such as in tennis or golf.

 **BEACH&SKI (Beach & ski)**

This mode prevents people's faces from appearing dark in strong light or reflected light, such as at a beach in midsummer or on a ski slope.

 **SUNSETMOON (Sunset & moon)**

This mode allows you to maintain atmosphere when you are recording sunsets, general night views, fireworks displays and neon signs.

 **LANDSCAPE (Landscape)**

This mode is for when you are recording distant subjects such as mountains and prevents your camcorder from focusing on glass or metal mesh in windows when you are recording a subject behind glass or a screen.



Using the PROGRAM AE function

- (1) In CAMERA mode, select PROGRAM AE in  in the menu settings (p. 68).
- (2) Select the desired PROGRAM AE mode in the menu settings, then press the SEL/PUSH EXEC dial.

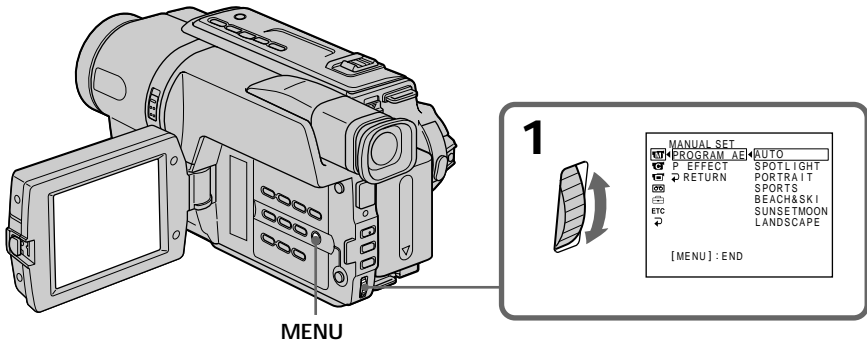

MENU

To cancel the PROGRAM AE function

Set PROGRAM AE to AUTO in the menu settings.

Notes

- In the spotlight, sports lesson and beach & ski modes, you cannot take close-ups. This is because your camcorder is set to focus only on subjects in the middle to far distance.
- In the sunset & moon and landscape modes, your camcorder is set to focus only on distant subjects.
- While using the PROGRAM AE function, you cannot select the bounce function with FADER.
- While setting NIGHTSHOT to ON, the PROGRAM AE function does not work. (The indicator flashes.)

Even if the PROGRAM AE function is selected

You can adjust the exposure manually.

If you are recording under a discharge tube such as a fluorescent lamp, sodium lamp or mercury lamp

Flickering or changes in color may occur in the following modes. If this happens, turn the PROGRAM AE function off:

- Soft portrait mode
- Sports lesson mode

Adjusting the exposure manually

You can manually adjust and set the exposure.

Adjust the exposure manually in the following cases:

- The subject is backlit
- Bright subject and dark background
- To record dark pictures (e.g. night scenes) faithfully

(1) In CAMERA mode, press EXPOSURE.

The exposure indicator appears on the screen.

(2) Turn the SEL/PUSH EXEC dial to adjust the brightness.

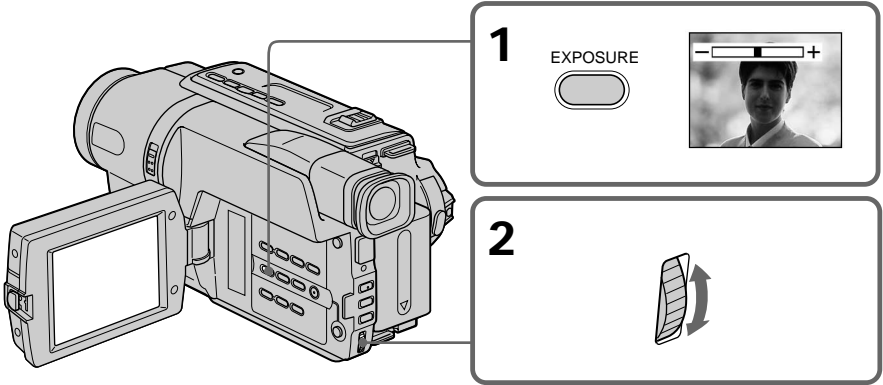

To return to the automatic exposure mode

Press EXPOSURE.

Note

When you adjust the exposure manually, the backlight function does not work in CAMERA mode.

Your camcorder automatically returns to the automatic exposure mode:

- if you change the PROGRAM AE mode
- if you slide NIGHTSHOT to ON

Focusing manually

You can gain better results by manually adjusting the focus in the following cases:

- The autofocus mode is not effective when shooting:
 - subjects through glass coated with water droplets.
 - horizontal stripes.
 - subjects with little contrast with backgrounds such as walls and sky.
- When you want to change the focus from a subject in the foreground to a subject in the background.
- Shooting a stationary subject when using a tripod.

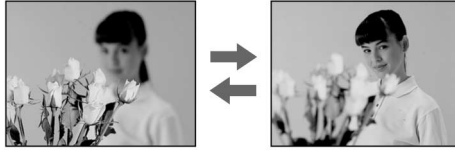

- (1) In CAMERA mode, press FOCUS. The  indicator appears on the screen.
- (2) Turn the SEL/PUSH EXEC dial to sharpen focus.

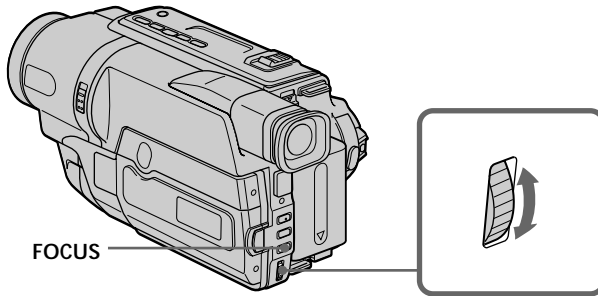

To return to the autofocus mode

Press FOCUS.

To focus precisely

Adjust the zoom by first focusing at the “T” (telephoto) position and then shooting at the “W” (wide-angle) position. This makes focusing easier.

When you shoot close to the subject

Focus at the end of the “W” (wide-angle) position.

 changes to the following indicators:

- ▲ when recording a distant subject.
- when the subject is too close to focus on.

Superimposing a title

You can select one of eight preset titles and two custom titles (p. 44). You can also select the language, color, size, and position of titles.



- (1) In CAMERA mode, press TITLE to display the title menu.
- (2) Turn the SEL/PUSH EXEC dial to select , and then press the dial.
- (3) Select the desired title in the menu settings, then press the SEL/PUSH EXEC dial. The titles are displayed in the language you selected.
- (4) Change the color, size, or position, if necessary.
 - ① Turn the SEL/PUSH EXEC dial to select the color, size, or position, then press the dial. The item appears.
 - ② Turn the SEL/PUSH EXEC dial to select the desired item, then press the dial.
 - ③ Repeat steps ① and ② until the title is laid out as desired.
- (5) Press the SEL/PUSH EXEC dial again to complete the setting.
- (6) Press START/STOP to start recording.
- (7) When you want to stop recording the title, press TITLE.

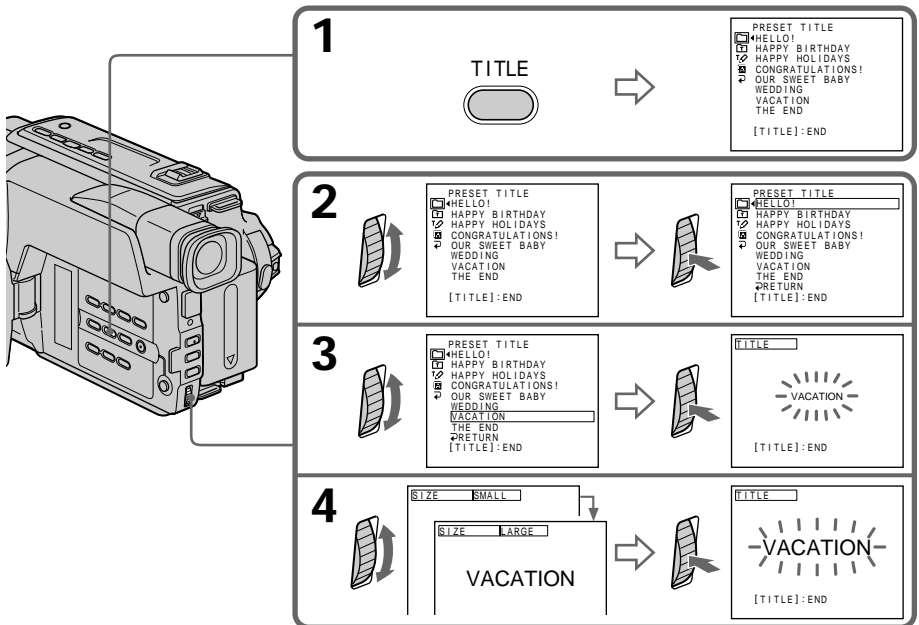

Superimposing a title

To superimpose the title while you are recording

Press TITLE while you are recording, and carry out steps 2 to 5. When you press the SEL/PUSH EXEC dial at step 5, the title is superimposed.

To select the language of a preset title

If you want to change the language, select  before step 2. Then select the desired language and return to step 2.

Note

Both the date and time or either of them may not be displayed depending on the size or position of the title.

If you display the menu or title menu while superimposing a title

The title is not recorded while the menu or title menu is displayed.

To use the custom title

If you want to use the custom title, select  in step 2.

Title setting

- The title color changes as follows:
WHITE ↔ YELLOW ↔ VIOLET ↔ RED ↔ CYAN ↔ GREEN ↔ BLUE
- The title size changes as follows:
SMALL ↔ LARGE
You cannot input 13 characters or more in LARGE size. If you input more than 12 characters, the title size returns to SMALL even if you select LARGE.
- The title position changes as follows:
1 ↔ 2 ↔ 3 ↔ 4 ↔ 5 ↔ 6 ↔ 7 ↔ 8 ↔ 9
The larger the position number, the lower the title is positioned.
When you select the title size "LARGE," you cannot choose position 9.
When you select the title size "LARGE" in the CINEMA mode, you cannot choose position 8 nor 9.

When you are selecting and setting the title

You cannot record the title displayed on the screen.

When you superimpose a title while you are recording

The beep does not sound.

While you are playing back

You can superimpose a title. However, the title is not recorded on tape.

You can record a title when you dub a tape connecting your camcorder to the VCR with the A/V connecting cable.

Making your own titles

You can make up to two titles and store them in your camcorder. Each title can have up to 20 characters.

- (1) In CAMERA or PLAYER mode, press TITLE.
- (2) Turn the SEL/PUSH EXEC dial to select , then press the dial.
- (3) Turn the SEL/PUSH EXEC dial to select the first line (CUSTOM1 SET) or the second line (CUSTOM2 SET), then press the dial.
- (4) Turn the SEL/PUSH EXEC dial to select the column of the desired character, then press the dial.
- (5) Turn the SEL/PUSH EXEC dial to select the desired character, then press the dial.
- (6) Repeat steps 4 and 5 until you have selected all characters and completed the title.
- (7) To finish making your own titles, turn the SEL/PUSH EXEC dial to select [SET], then press the dial. The title is stored in memory.
- (8) Press TITLE to make the title menu disappear.

1

TITLE



PRESET TITLE

HELLO!

HAPPY BIRTHDAY

HAPPY HOLIDAYS

CONGRATULATIONS!

OUR SWEET BABY

WEDDING

VACATION

THE END

[TITLE]:END

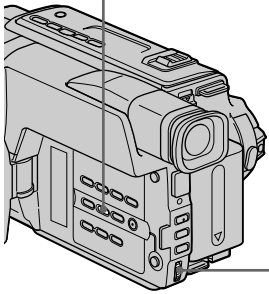

2



TITLE SET	SET
CUSTOM1 SET	SET
CUSTOM2 SET	SET
[TITLE]:END	



TITLE SET	SET
CUSTOM1 SET	SET
CUSTOM2 SET	RETURN
[TITLE]:END	

3



TITLE SET	SET
CUSTOM1 SET	SET
CUSTOM2 SET	RETURN
[TITLE]:END	



TITLE SET	P1
[ABCD] 12345 67890	[←] [→]
FHIJ 67890	[←] [→]
KLMNO AEIOU	[←] [→]
PQRST AEIOU	[←] [→]
UVWXY AEIJS [SET]	
Z& ?! AONGS	
"/- AIOQA	
[TITLE]:END	

4



TITLE SET	P1
ABCDE 12345 67890	[←] [→]
FHIJ 67890	[←] [→]
KLMNO AEIOU	[←] [→]
PQRST AEIOU	[←] [→]
UVWXY AEIJS [SET]	
Z& ?! AONGS	
"/- AIOQA	
[TITLE]:END	



TITLE SET	P1
ABCDE 12345 67890	[←] [→]
FHIJ 67890	[←] [→]
KLMNO AEIOU	[←] [→]
PQRST AEIOU	[←] [→]
UVWXY AEIJS [SET]	
Z& ?! AONGS	
"/- AIOQA	
[TITLE]:END	

6



TITLE SET	P1
ABCDE 12345 67890	[←] [→]
FHIJ 67890	[←] [→]
KLMNO AEIOU	[←] [→]
PQRST AEIOU	[←] [→]
UVWXY AEIJS [SET]	
Z& ?! AONGS	
"/- AIOQA	
[TITLE]:END	



TITLE SET	P1
S	
ABCDE 12345 67890	[←] [→]
FHIJ 67890	[←] [→]
KLMNO AEIOU	[←] [→]
PQRST AEIOU	[←] [→]
UVWXY AEIJS [SET]	
Z& ?! AONGS	
"/- AIOQA	
[TITLE]:END	

44

Making your own titles

To change a title you have stored

In step 3, select CUSTOM1 SET or CUSTOM2 SET, depending on which title you want to change, then press the SEL/PUSH EXEC dial. Turn the SEL/PUSH EXEC dial to select [←], then press the dial to delete the title. The last character is erased. Enter the new title as desired.

If you take 5 minutes or longer to enter characters in the standby mode while a cassette is in your camcorder

The power automatically turns off. The characters you have entered remain stored in memory. Set the POWER switch to OFF (CHG) once, and turn it to CAMERA again, then proceed from step 1.

We recommend setting the POWER switch to PLAYER or removing the cassette so that your camcorder does not automatically turn off while you are entering title characters.

If you select [→P2]

The menu for selecting alphabet and Russian characters appears. Select [→P1] to return to the previous screen.

To erase a character

Select [←]. The last character is erased.

To enter a space

Select [Z& ?!], then select the blank part.

Using the built-in light

- CCD-TRV107/TRV308/TRV408/TRV608 only

You can use the built-in light to suit your shooting situation. The recommended distance between the subject and camcorder is about 1.5 m (5 feet).

Press LIGHT repeatedly, until the  indicator appears on the screen while your camcorder is in CAMERA mode. The built-in light turns on.
If you turn the POWER switch to OFF (CHG), the built-in light turns off simultaneously. You cannot turn the built-in light on by turning the POWER switch to CAMERA again. To turn on the built-in light again, press LIGHT again in CAMERA mode.

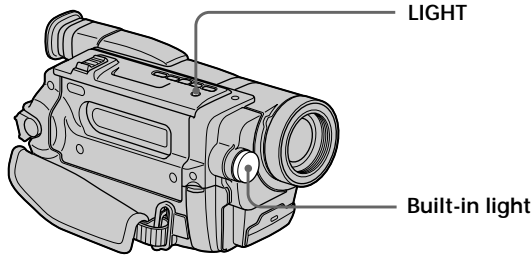

To turn off the built-in light

Press LIGHT repeatedly, until no indicator appears on the screen.

To turn on the built-in light automatically

Press LIGHT repeatedly, until the  indicator appears on the screen. The built-in light automatically turns on and off according to the ambient brightness.

CAUTION

Be careful not to touch the lighting section, because the plastic window and surrounding surfaces are hot while the light is on. It remains hot for a while after the light is turned off.

DANGER

Not to be handled by children.
Emits intense heat and light.
Use with caution to reduce the risk of fire or injury to persons.
Do not directly aim the light at persons or materials from less than 1.22 m (4 feet) during use and until cool.
Turn the built-in light off when not in use.

When you press LIGHT
The indicator changes as follows:



Using the built-in light

Notes

- The built-in light turns off automatically in the following cases:
 - When it stays on in the AUTO mode (📷📷), for more than 5 minutes.
 - When you leave it on for more than 5 minutes with no cassette inserted or after the tape has run out.To turn the built-in light on again, press LIGHT again.
- The battery pack discharges quickly while the built-in light is turned on. Turn it off when not in use.
- When you do not use your camcorder, turn the built-in light off and remove the battery pack to avoid turning on the built-in light accidentally.
- When flickering occurs while shooting in the AUTO mode (📷📷), press LIGHT until the 📷📷 indicator appears.
- The built-in light may turn on/off when you use the PROGRAM AE or backlight function while shooting in the AUTO mode (📷📷).
- The built-in light may turn off when inserting or ejecting a cassette.
- While the end search function is working, the built-in light is turned off.
- When you use the conversion lens (optional), the built-in light is blocked and may not illuminate the subject properly.

Replacing the bulb

Use the Sony XB-3D halogen lamp (optional). The supplied halogen lamp is not commercially available. Purchase the Sony XB-3D halogen lamp. Remove the power source before replacing the bulb.

- (1) Remove the built-in light unit while pushing the hole under the built-in light unit using a wire.
- (2) Turn the bulb housing counterclockwise and detach from the built-in light unit.
- (3) Replace the bulb using a dry cloth.
- (4) Attach the bulb housing by turning it clockwise, then replace the built-in light unit.

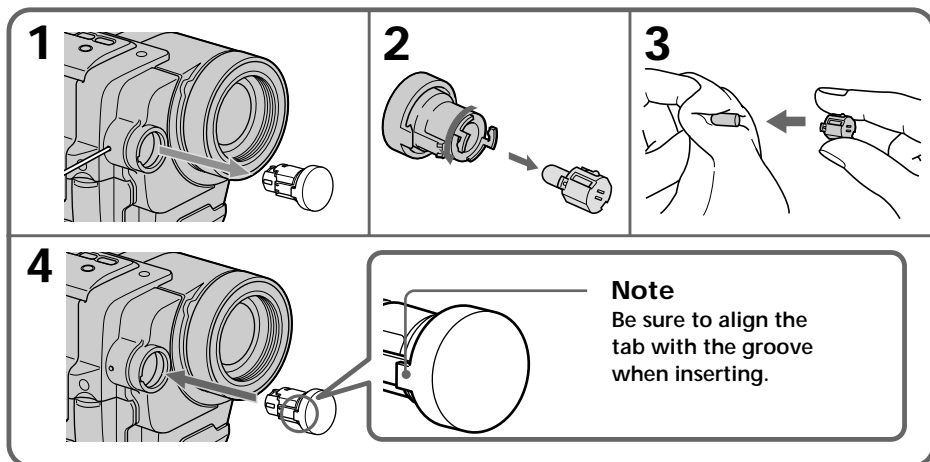

Using the built-in light

CAUTION

- When replacing the bulb, use only the Sony XB-3D halogen lamp (optional) to reduce the risk of fire.
- To prevent possible burn hazard, disconnect the power source before replacing and do not touch the bulb until the bulb becomes cool enough to handle (for about 30 minutes or more).

Note

To prevent the bulb from being smudged with finger prints, handle it with a dry cloth, etc. If the bulb is smudged, wipe it completely.

Dubbing a tape

Using the A/V connecting cable

Connect your camcorder to the VCR using the A/V connecting cable supplied with your camcorder.

You can record and edit a picture with the connected VCR by using your camcorder as a player.

Set DISPLAY to LCD in $\boxed{\text{ETC}}$ in the menu settings (The default setting is set to LCD.)

If you do not make the indicators disappear, they are recorded on tapes.

Make the indicators disappear by pressing the following buttons:

- DISPLAY on your camcorder
- DISPLAY on the Remote Commander (CCD-TRV107/TRV408 only)

- (1) Insert a blank tape (or a tape you want to record over) into the VCR, and insert the recorded tape into your camcorder.
- (2) Set the input selector on the VCR to LINE. Refer to the operating instructions of your VCR for more information.
- (3) Set the POWER switch to PLAYER.
- (4) Play back the recorded tape on your camcorder.
- (5) Start recording on the VCR.

Refer to the operating instructions of your VCR for more information.

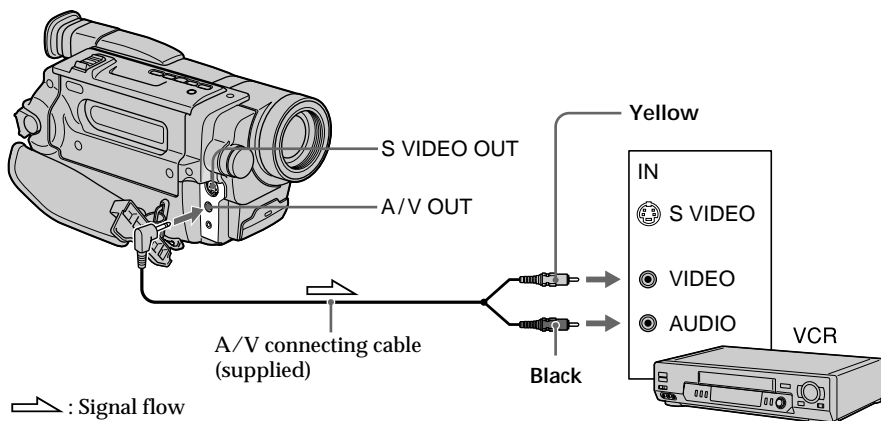

Dubbing a tape

When you have finished dubbing a tape

Press ■ on both your camcorder and the VCR.

To prevent deterioration of pictures when dubbing

Set EDIT to ON in the menu settings before dubbing.

You can edit on VCRs that support the following systems:

8 mm **8**, Hi8 **Hi8**, Digital 8 **D8**, VHS **VHS**, S-VHS **S-VHS**, VHSC **VHSC**, S-VHSC **S-VHSC**, Betamax **B**, ED Betamax **ED Beta**, mini DV ^{Mini} **DV**, or DV **DV**

If your VCR is a stereo type

Connect the audio plug of the A/V connecting cable supplied to the left (white) input jack of your VCR.

If your VCR has an S video jack

Connect using an S video cable (optional) to obtain optimum quality screen images. With this connection, you do not need to connect the yellow (video) plug of the A/V connecting cable.

Connect an S video cable (optional) to the S video jacks of both your camcorder and the VCR.

Dubbing a tape easily – Easy Dubbing

VCR operation for dubbing can be controlled easily by using your camcorder when the VCR is connected.

You can select one of eight preset titles and two custom titles stored in your camcorder as instructed in “Making your own titles” (p. 44). Select the desired color, size, and background color of titles.

Using the Easy Dubbing function

Step 1 Connecting the VCR (p. 51).

Step 2 Setting the VCR to operate with your camcorder (p. 52 to 55).

Step 3 Selecting the title (p. 56).

Step 4 Selecting the dubbing mode (p. 57).

Step 5 Performing Easy Dubbing (p. 58).

If you dub using the same VCR again, you can skip step 2.

If you do not need to put in a title, you can skip step 3.

Step 1: Connecting the VCR

Connect the devices as illustrated in page 49.

You can edit on VCRs that support the following systems:

8 mm **8**, Hi8 **Hi8**, Digital 8 **D8**, VHS **VHS**, S-VHS **S-VHS**, VHSC **VHSC**, S-VHSC **S-VHSC**, Betamax **B**, ED Betamax **ED Beta**, mini DV ^{Mini} **DV**, or DV **DV**

If your VCR has an S video jack

Connect using an S video cable (optional) to obtain optimum quality screen images.

With this connection, you do not need to connect the yellow (video) plug of the A/V connecting cable.

Connect an S video cable (optional) to the S video jacks of both your camcorder and the VCR.

Dubbing a tape easily – Easy Dubbing

Step 2: Setting the VCR to operate with your camcorder

You can control the VCR by wireless remote control.

(1) Setting the modes to cancel recording pause on the VCR

- ① Set the POWER switch to PLAYER on your camcorder.
- ② Turn the power of the connected VCR on, then set the input selector to LINE.

When you connect a video camera recorder, set its power switch to VTR/VCR.

- ③ Press EASY DUBBING to display the menu.
- ④ Turn the SEL/PUSH EXEC dial to select SETUP, then press the dial.
- ⑤ Turn the SEL/PUSH EXEC dial to select PAUSE MODE, then press the dial.
- ⑥ Turn the SEL/PUSH EXEC dial to select the mode to cancel recording pause on the VCR, then press the dial.

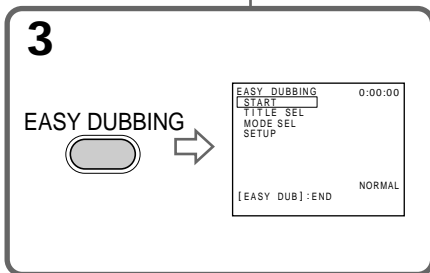
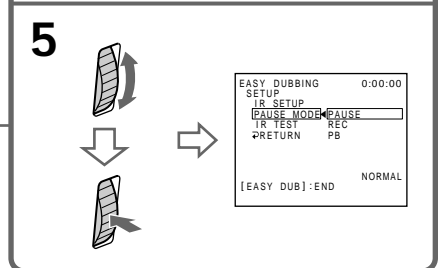
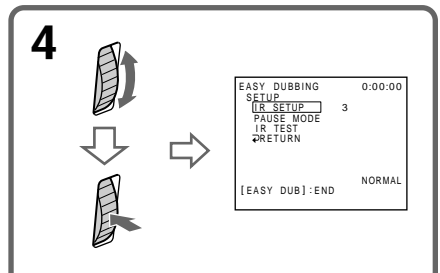
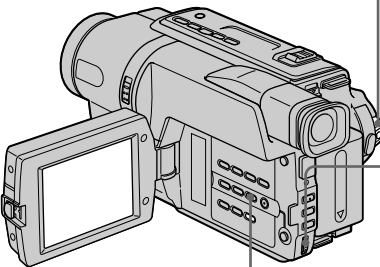
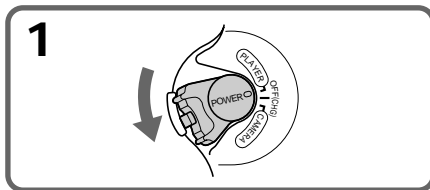

Buttons for canceling recording pause on the VCR

The buttons vary depending on your VCR. To cancel recording pause:

- Select PAUSE if the button to cancel recording pause is **II**.
- Select REC if the button to cancel recording pause is **●**.
- Select PB if the button to cancel recording pause is **▶**.

Dubbing a tape easily – Easy Dubbing

(2) Setting the IR SETUP code

- ① Turn the SEL/PUSH EXEC dial to select IR SETUP, then press the dial.
- ② Turn the SEL/PUSH EXEC dial to select the IR SETUP code of your VCR, then press the dial.

Check the code in “About the IR SETUP code” (p. 54).

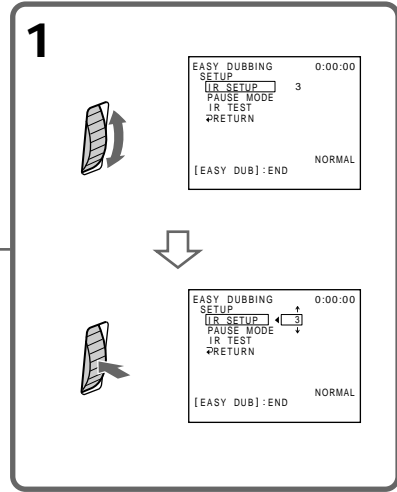
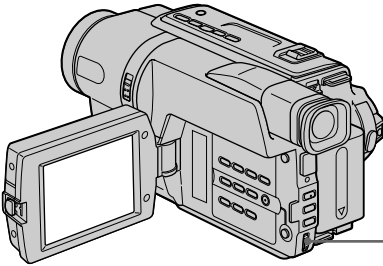

Dubbing a tape easily – Easy Dubbing

About the IR SETUP code

The IR SETUP code is stored in the memory of your camcorder. Be sure to set the correct code depending on your VCR. The default setting is Code number 3.

Brand	IR SETUP code
Sony	1, 2, 3, 4, 5, 6
Admiral (M. Wards)	89
Aiwa	80, 47, 54
Akai	49, 51
Audio Dynamic	21, 35
Bell&Howell (M. Wards)	36
Brocsonic	70, 82, 21
Canon	77, 78
Citizen	47
Craig	73, 47
Curtis Mathis	8, 80, 77
Daewoo	26, 40, 77
DBX	21, 33, 35
Dimensia	8
Emerson	26, 82, 59, 48, 70, 81, 80
Fisher	36, 45, 37, 44
Funai	80
General Electric	8, 77, 32*, 94*, 101
Goldstar/LG	47
GO VIDEO	71
Hitachi	78, 8, 42
HQ	40
Instant Replay	77, 78
JC Penny	77, 42, 8, 36, 21, 33, 35
JVC	21, 12, 13, 14, 33, 35
Kenwood	21, 33, 47, 35
LXI (Sears)	80, 47, 42, 44, 45, 36, 37, 49
Magnavox	83, 78, 77, 17
Marantz	21, 33, 35
Marta	47
Memorex	77, 37
Minolta	42, 8

Brand	IR SETUP code
Mitsubishi/MGA	28, 22, 23, 24, 29
Multitech	23, 80, 32
NEC	21, 33, 35
Olympic	77, 78
Optimus	22
Orion	60
Panasonic	16, 17, 78, 77
Pentax	42, 8
Philco	78, 77, 26, 70
Philips	47, 83, 78, 77
Pioneer	78
Quasar	78, 77, 16, 17, 6
RCA/PROSCAN	8, 42, 16, 77, 83, 7, 40, 41, 78, 78*, 101
Realistic	77, 36, 88, 37, 22, 80
Sansui	21
Singer	73
Samsung	94, 41, 32, 24, 32*, 94*, 24*
Sanyo	36, 37, 26, 36, 47
Scott	40, 41, 32, 37, 28, 22, 23, 24
Sharp	89, 88
Shintom	73
Signature 2000 (M. Wards)	80, 89
Sylvania	83, 78, 77, 80
Symphonic	80
Tashiro	47
Tatung	21, 33, 35
Teac	21, 33, 80, 35
Technics	77, 78
Toshiba	40, 7, 49
Wards	89, 88, 37, 95, 47
Yamaha	36, 21, 33, 35
Zenith	95

* TV/VCR component

Note on IR SETUP code

The Easy Dubbing is not possible if the VCR does not support IR SETUP codes.

Dubbing a tape easily – Easy Dubbing

(3) Setting your camcorder and the VCR to face each other

Locate the Infrared rays emitter of your camcorder and face it towards the remote sensor of the VCR.

Set the devices about 30 cm (12 in.) apart, and remove any obstacles between the devices.

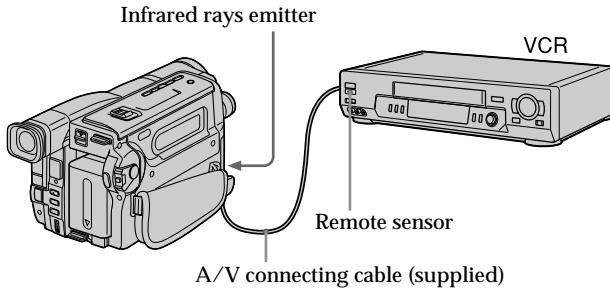

(4) Confirming the VCR operation

- ① Insert a recordable tape into the VCR, then set to recording pause.
- ② Turn the SEL/PUSH EXEC dial to select IR TEST, then press the dial.
- ③ Turn the SEL/PUSH EXEC dial to select EXECUTE, then press the dial.

If the VCR starts recording, the setting is correct.

When finished, the indicator changes to COMPLETE.

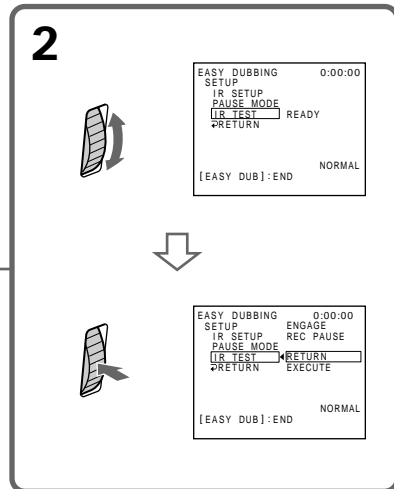
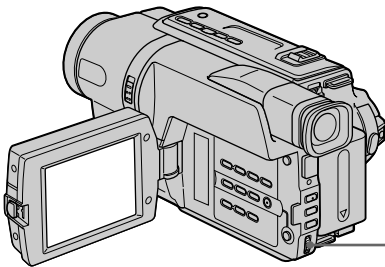

When the VCR does not operate correctly

- After checking the code in “About the IR SETUP code,” set IR SETUP or PAUSE MODE again.
- Place your camcorder at least 30 cm (12 in.) away from the VCR.
- Refer to the operating instructions of your VCR.

Dubbing a tape easily – Easy Dubbing

Step 3: Selecting the title

You can select title, color, size, and background color.

CUSTOM1 and CUSTOM2 are custom titles stored in your camcorder as instructed in “Making your own titles” (p. 44).



- (1) Press EASY DUBBING to display the menu.
- (2) Turn the SEL/PUSH EXEC dial to select TITLE SEL, then press the dial.
- (3) Select the desired title in the menu settings, then press the dial. The title is displayed.
- (4) Change the color, size, or background color, if necessary.
 - ① Turn the SEL/PUSH EXEC dial to select the color, size, or background color, then press the dial. The item appears.
 - ② Turn the SEL/PUSH EXEC dial to select the desired item, then press the dial.
 - ③ Repeat steps ① and ② until the title is laid out as desired.
 - ④ Press the SEL/PUSH EXEC dial again to complete the setting.

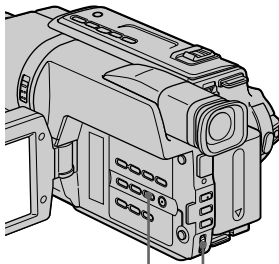

EASY DUBBING

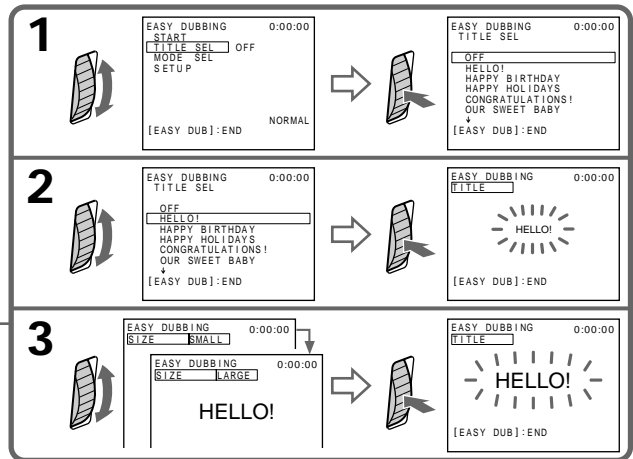

Note

You can put a title only into the tape of the VCR.

Title setting

- The title color changes as follows:
WHITE ↔ YELLOW ↔ VIOLET ↔ RED ↔ CYAN ↔ GREEN ↔ BLUE
- The title size changes as follows:
SMALL ↔ LARGE
- The background color changes as follows:
FADE ↔ WHITE ↔ YELLOW ↔ VIOLET ↔ RED ↔ CYAN ↔ GREEN ↔
BLUE ↔ BLACK

Dubbing a tape easily – Easy Dubbing

Step 4: Selecting the dubbing mode

You can choose either normal recording (NORMAL) or interval recording (PREVIEW).

- (1) Turn the SEL/PUSH EXEC dial to select MODE SEL, then press the dial.
- (2) Turn the SEL/PUSH EXEC dial to select the mode to dub, then press the dial.
 - NORMAL: you can record into the VCR normally.
 - PREVIEW: you can make a time-lapse dubbing by setting the camcorder to automatically playback and standby sequentially.

- [a]: Recording (VCR)
- [b]: Waiting time (VCR)
- [c]: Playback time (camcorder)

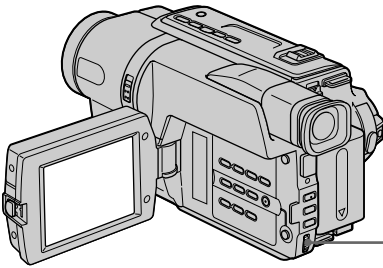
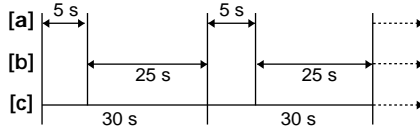

1

The diagram shows the SEL/PUSH EXEC dial being turned to the right, indicated by a curved arrow.

EASY DUBBING	0:00:00
START	
TITLE SEL	
MODE SEL	NORMAL
SETUP	
[EASY DUB]:END	NORMAL

↓

The diagram shows the SEL/PUSH EXEC dial being turned to the right, indicated by a curved arrow.

EASY DUBBING	0:00:00
START	
TITLE SEL	
MODE SEL	PREVIEW
SETUP	
[EASY DUB]:END	NORMAL

Step 5: Performing Easy Dubbing

Make sure that your camcorder and VCR are connected, and that the VCR is set to recording pause.

When you use a video camera recorder, set its POWER switch to VTR/VCR. Set the POWER switch of your camcorder to PLAYER.

(1) Turn the SEL/PUSH EXEC dial to select START, then press the dial.

(2) Turn the SEL/PUSH EXEC dial to select EXECUTE, then press the dial.

When dubbing ends, your camcorder and VCR stop automatically.

To stop dubbing during editing

Press ■ on your camcorder.

To quit the Easy Dubbing function

Your camcorder stops when dubbing is complete. Then the display returns to START in the menu settings.

Press EASY DUBBING to quit the Easy Dubbing function.

Note

If you set the background color to FADE in step 3, the picture may not appear properly depending on the connected VCR.

You cannot record on the VCR when:

- The tape has run out.
- The write-protect tab is set to expose the red mark.
- The IR SETUP code is not correct.
- The button used to cancel recording pause is not correct.

NOT READY appears on the screen when:

START is not carried out.

Viewing images using your computer – USB Streaming (Windows users only)

– CCD-TRV608 only

If you connect your camcorder and computer by the supplied USB cable, you can view images live from your camcorder and images recorded on a tape on your computer. Furthermore, if you capture images live from your camcorder and images recorded on a tape to your computer, you can process or edit it by computer software and append it to e-mail.

Using the USB Streaming function

- Installing the USB driver (p. 60 to 63).
- Installing “PIXELA ImageMixer Ver.1.0 for Sony” (p. 63).
- Capturing images with “PIXELA ImageMixer Ver.1.0 for Sony” (p. 63 to 66).

Recommended computer environment

OS:

Microsoft Windows 98 SE, Windows Me, Windows 2000 Professional, Windows XP Home Edition or Windows XP Professional (standard installation)

However, operation is not assured if the above environment is an upgraded OS.

If you are using Windows 98, you cannot capture sounds.

CPU:

Minimum 500 MHz Intel Pentium III or faster (800 MHz or faster recommended)

Application:

DirectX 8.0a or later

Sound system:

16 bit stereo sound card and speakers

Memory:

64 MB or more

Hard disk:

Minimum 200 MB available hard disk space for installation

1 GB hard disk space or more recommended for working area (depending on the file size of editing the images)

Display:

4 MB VRAM video card, Minimum 800 × 600 dot High color (16 bit color, 65 000 colors), Direct Draw display driver capability (At 800 × 600 dot or less, 256 colors and less, this product will not operate correctly.)

Others:

This product is compatible with DirectX technology, so it is necessary to install DirectX.

The USB connector is provided as standard.

This function is not available on Macintosh.
--

Viewing images using your computer – USB Streaming (Windows users only)

Notes

- Operations are not guaranteed if you connect 2 or more pieces of USB equipment to a single computer at the same time or when using a hub.
 - Depending on the type of USB equipment used simultaneously, some equipment may not operate.
 - Operations are not guaranteed for all the recommended computer environments mentioned above.
-
- Microsoft and Windows are registered trademarks of Microsoft Corporation in the United States and/or other countries.
 - Pentium is either registered trademark or trademark of Intel Corporation.
 - All other product names mentioned herein may be the trademarks or registered trademarks of their respective companies.
 - Furthermore, “™” or “®” are not mentioned in this manual.

Installing the USB driver

Before connecting your camcorder to your computer, install the USB driver to the computer. The USB driver is contained together with application software for viewing images on the CD-ROM supplied with your camcorder.

Be sure to follow the steps before connecting the USB cable to your computer.
Connect the USB cable in step 8.

If the USB driver has been registered incorrectly because your computer was connected to your camcorder before installing the USB driver, reinstall the USB driver following the procedure on page 61.

For Windows 98 SE, Windows Me, Windows 2000 Professional and Windows XP users

Log in with permission of Administrator. (for Windows 2000 Professional and Windows XP users)

- (1) Turn on your computer and allow Windows to load.
- (2) Insert the supplied CD-ROM into the CD-ROM drive of your computer. The application software screen appears.
- (3) Move the cursor to “USB Driver” and click. The USB driver installation starts.



Viewing images using your computer – USB Streaming (Windows users only)

- (4) Follow the on-screen messages to install the USB driver.
- (5) Connect the AC power adaptor to your camcorder and then to a wall outlet.
- (6) Set the POWER switch to CAMERA or PLAYER.
- (7) Select USB STREAM to ON in  in the menu settings (p. 71).
- (8) With the CD-ROM inserted, connect the USB jack on your camcorder to the USB connector on your computer using the supplied USB cable.
Your computer recognises the camcorder, and the Windows Add Hardware Wizard starts.

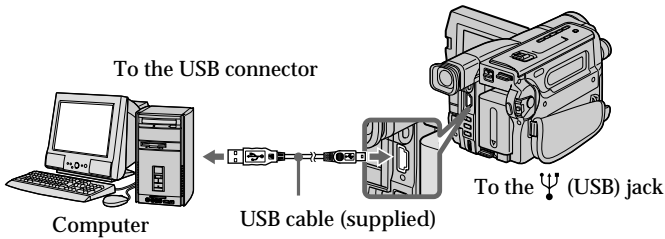

- (9) Follow the on-screen messages so that the Add Hardware Wizard recognizes that the USB drivers have been installed. The Add Hardware Wizard starts three times because three different USB drivers are installed. Be sure to allow the installation to complete without interrupting it.

If the “Files Needed” screen appears (Windows 2000 Professional and Windows XP users)

Set the CD-ROM on the CD-ROM driver then select “Browse...” → “My Computer” → “ImageMixer” → “sonyhcb.sys”, and click the “OK” button.

The installation is completed, proceed to Installing “PIXELA ImageMixer Ver.1.0 for Sony” on page 63.

If you cannot install the USB driver

The USB driver has been registered incorrectly as your computer was connected to your camcorder before installing the USB driver. Perform the following procedure to correctly install the USB driver.

Step 1 Uninstall the incorrect USB driver

- ① Turn on your computer and allow Windows to load.
- ② Connect the USB jack on your camcorder to the USB connector on your computer using the supplied USB cable.

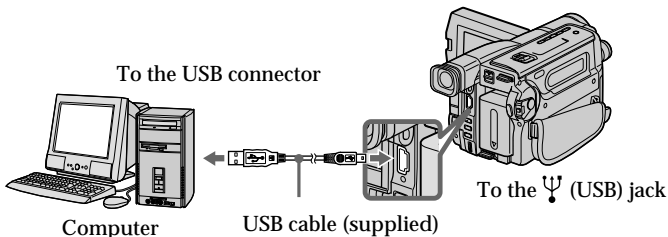

Viewing images using your computer – USB Streaming (Windows users only)

- ③ Connect the AC power adaptor, and set the POWER switch to CAMERA or PLAYER.
- ④ Open your computer’s “Device Manager.”
Windows XP:
Select “Start” → “Control Panel” → “System” → “Hardware” tab, and click the “Device Manager” button.
If “System” is not in the control panel, the “Pick a Category” screen appears. In this case, click “Switch to Classic View” instead.
Windows 2000 Professional:
Select “My Computer” → “Control Panel” → “System” → “Hardware” tab, and click the “Device Manager” button.
Windows 98 SE/Windows Me:
Select “My Computer” → “Control Panel” → “System,” and click the “Device Manager” tab.
- ⑤ Select the devices underlined in the illustrations below, and delete them.

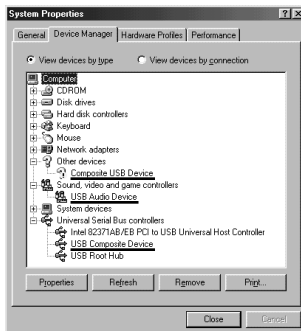

Windows 98 SE

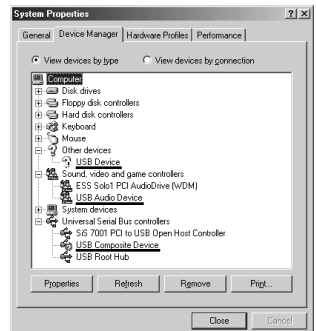

Windows Me

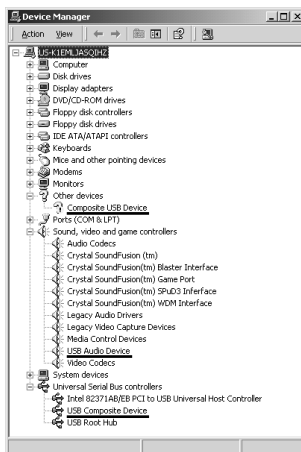

Windows 2000 Professional

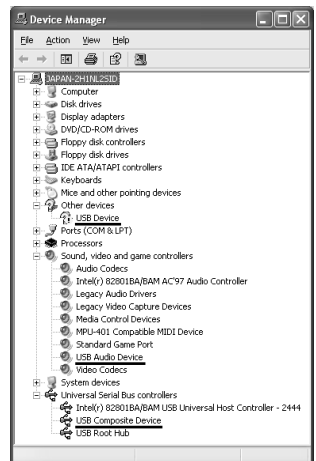

Windows XP

Viewing images using your computer – USB Streaming (Windows users only)

- ⑥ Set the POWER switch to OFF (CHG), and then disconnect the USB cable.
- ⑦ Reboot your computer.

Step 2 Install the USB driver

Perform the entire procedure listed in “Installing the USB driver” on the page 60.

Installing “PIXELA ImageMixer Ver.1.0 for Sony”

Install “PIXELA ImageMixer Ver.1.0 for Sony” to your computer. “PIXELA ImageMixer Ver.1.0 for Sony” is contained on the CD-ROM supplied with your camcorder. You can view video images easily on your camcorder, using your computer with “PIXELA ImageMixer Ver.1.0 for Sony”.

For Windows 2000 Professional users

Log in with permission of Power Users or Administrator.

For Windows XP users

Log in with permission of Administrator.

- (1) Turn on your computer and allow Windows to load.
While using your computer, close all running applications.
- (2) Insert the supplied CD-ROM into the CD-ROM drive of your computer.
The application software screen appears.
If the application software screen does not appear, double-click “My Computer” and then “ImageMixer” (CD-ROM Drive). The application software screen appears after a while.



- (3) Move the cursor to “PIXELA ImageMixer” and click.
The language selection dialogue box appears.
- (4) Select the language for installation.
- (5) Follow the on-screen messages.

Follow the directions on the screen to install DirectX. DirectX 8.0 will be installed.

Capturing images with “PIXELA ImageMixer Ver.1.0 for Sony”

For Windows 2000 Professional users

Log in with permission of Power Users or Administrator.

For Windows XP users

Log in with permission of Administrator.

Viewing images using your computer – USB Streaming (Windows users only)

Viewing images

Viewing images recorded on a tape

- (1) Turn on your computer and allow Windows to load.
- (2) Connect one end of the USB cable to the USB jack on the camcorder and the other end to the USB connector on your computer using the supplied USB cable.

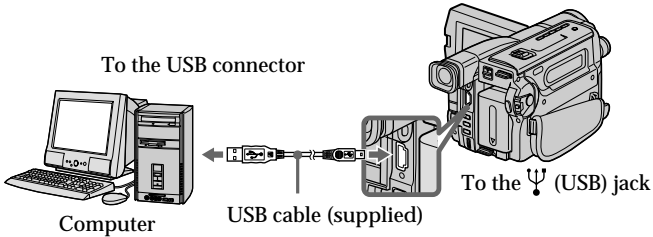

- (3) Connect the AC power adaptor and insert a cassette to your camcorder.
- (4) Set the POWER switch to PLAYER.
- (5) Select USB STREAM to ON in  in the menu settings (p. 71).
- (6) Select “Start” → “Program” → “Pixela” → “ImageMixer” → “PIXELA ImageMixer Ver.1.0 for Sony” on Windows.
- (7) Click the input mode button in the left side of Start-up screen.



- (8) Select .

Preview window

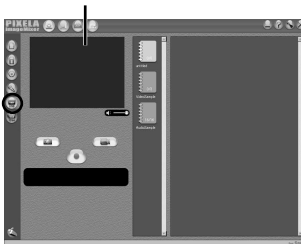

- (9) Start playing back a tape on your camcorder. The images recorded on a tape appears in the preview window.

Viewing images using your computer – USB Streaming (Windows users only)

Viewing images live from your camcorder



- (1) Follow the procedure (1) - (2) on page 64, and then connect the AC power adaptor to your camcorder and then to a wall outlet.
- (2) Set the POWER switch to CAMERA.
- (3) Follow the procedure (5) - (8) on page 64.

The images live from your camcorder appears in the preview window.

Capturing images

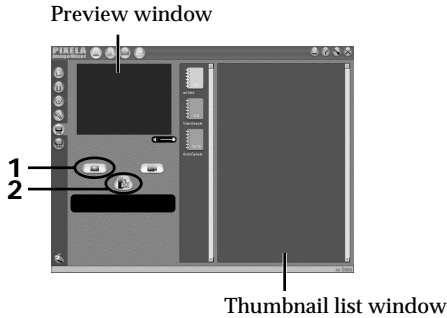

Capturing still images

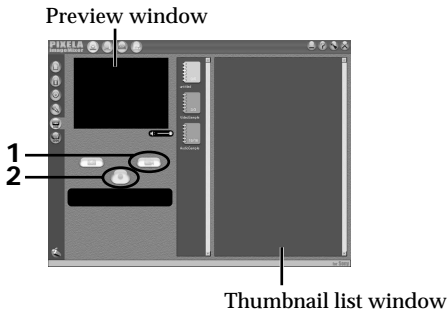

- (1) Select .
- (2) Click  at the point to capture using the preview window. The captured image appears on the thumbnail list window.

Capturing moving images



- (1) Select .
- (2) Click  at the start point to capture and click  at the stop point to capture using the preview window. The captured image appears on the thumbnail list window.

Viewing images using your computer – USB Streaming (Windows users only)

Notes

- When you view images using your computer with the USB connection, the following conditions may occur, but do not indicate malfunction:
 - The image may fluctuate.
 - The image may contain noise, etc.
 - The image does not appear properly if the image signal is of a different TV color system from your camcorder.
- When your camcorder is in the standby mode with a cassette inserted, it turns off automatically after 5 minutes.
- We recommend setting DEMO MODE to OFF in the menu settings when your camcorder is in the standby mode, and no cassette is inserted.
- Indicators in the camcorder LCD screen do not appear on images that are captured into your computer.

If image data cannot be transferred by the USB connection

The USB driver has been registered incorrectly as your computer was connected to your camcorder before installing the USB driver. Perform the procedure to correctly install the USB driver (p. 60).

If any trouble occurs

Close all running applications, then restart it.

Carry out the following operations after quitting the application:

- disconnect the USB cable
- turn on/off the power

Seeing the on-line help (operation manual) of “PIXELA ImageMixer Ver.1.0 for Sony”

“PIXELA ImageMixer Ver.1.0 for Sony” is provided with on-line help (operation manual).

(1) Click  button located in the upper-right corner of the screen.

The ImageMixer’s Manual screen appears.

(2) You can access the desired topics from the contents.

To close the on-line help

Click  located in the upper right corner of the “ImageMixer’s Manual” screen.

If you have any questions about “PIXELA ImageMixer Ver1.0 for Sony”

ImageMixer Ver.1.0 for Sony is a trademark of PIXELA corporation. Refer to the information web site at: “<http://www.imagemixer.com>”.

Notes on using your computer

Communications with your computer

Communications between your camcorder and your computer may not recover after recovering from Suspend, Resume, or Sleep.

Changing the menu settings

To change the mode settings in the menu settings, select the menu items with the SEL/PUSH EXEC dial. The default settings can be partially changed. First, select the icon, then the menu item and then the mode.

- (1) In CAMERA or PLAYER mode, press MENU.
- (2) Turn the SEL/PUSH EXEC dial to select the desired icon, then press the dial to set.
- (3) Turn the SEL/PUSH EXEC dial to select the desired item, then press the dial to set.
- (4) Turn the SEL/PUSH EXEC dial to select the desired mode, and press the dial to set.
- (5) If you want to change other items, select ↶ RETURN and press the dial, then repeat steps from 2 to 4.

For details, see “Selecting the mode setting of each item” (p. 68).

1

CAMERA	PLAYER
MANUAL SET PROGRAM AE P EFFECT ETC ↶	EDIT TBC DNR ETC ↶
[MENU] : END	[MENU] : END

2

MANUAL SET	PROGRAM AE	P EFFECT
OTHERS	WORLD TIME	BEEP
COMMANDER	DISPLAY	REC LAMP
ETC	↶	↷
OTHERS	WORLD TIME	0 HR
BEEP	COMMANDER	DISPLAY
REC LAMP	RETURN	
ETC	↶	↷

3

OTHERS	WORLD TIME	0 HR
BEEP	COMMANDER	ON
DISPLAY	REC LAMP	
RETURN		
ETC	↶	↷
OTHERS	WORLD TIME	
BEEP	COMMANDER	ON
DISPLAY	REC LAMP	OFF
RETURN		
ETC	↶	↷







4

OTHERS	WORLD TIME	
BEEP	COMMANDER	ON
DISPLAY	REC LAMP	OFF
RETURN		
ETC	↶	↷
OTHERS	WORLD TIME	
BEEP	COMMANDER	OFF
DISPLAY	REC LAMP	
RETURN		
ETC	↶	↷

To make the menu display disappear
Press MENU.

Changing the menu settings

Menu items are displayed as the following icons:

-  MANUAL SET
-  CAMERA SET
-  PLAYER SET
-  LCD/VF SET
-  TAPE SET
-  SETUP MENU
-  OTHERS



Depending on your camcorder model

The menu display may be different from that in this illustration.

Selecting the mode setting of each item ● is the default setting.

Menu items differ according to the position of the POWER switch.

The screen shows only the items you can operate at the moment.

Icon/item	Mode	Meaning	POWER switch
 PROGRAM AE	---	To suit your specific shooting requirement. (p. 38)	CAMERA
	P EFFECT	To add special effects like those in films or on the TV to images. (p. 37)	CAMERA
 D ZOOM	● OFF	If you set to OFF, digital zoom is deactivated and up to 20× is carried out.	CAMERA
	40× 560×	If you set to 40×/560×, digital zoom is activated and more than 20× to 40×/560× is performed digitally. (p. 22) (CCD-TRV408/TRV608 only)	
	● OFF	If you set to OFF, digital zoom is deactivated and up to 20× is carried out.	
	40× 460×	If you set to 40×/460×, digital zoom is activated and more than 20× to 40×/460× is performed digitally. (p. 22) (CCD-TRV108/TRV308 only)	
	● OFF	If you set to OFF, digital zoom is deactivated and up to 20× is carried out.	
	40× 450×	If you set to 40×/450×, digital zoom is activated and more than 20× to 40×/450× is performed digitally. (p. 22) (CCD-TRV107 only)	
16:9WIDE	● OFF	—	CAMERA
	CINEMA	To record in the CINEMA mode. (p. 33)	
	16:9FULL	To record in the 16:9FULL mode.	
STEADYSHOT*	● ON	To compensate for camera-shake.	CAMERA
	OFF	To cancel the SteadyShot function. Natural pictures are produced when shooting a stationary object with a tripod.	
N.S.LIGHT	● ON	To use the NightShot Light function. (p. 26)	CAMERA
	OFF	To cancel the NightShot Light function.	

Changing the menu settings

Notes on the SteadyShot function*

- The SteadyShot function will not correct excessive camera-shake.
- Attachment of a conversion lens (optional) may influence the SteadyShot function.
- SteadyShot does not operate in the 16:9FULL mode. If you set STEADYSHOT to ON in the menu settings, the  indicator flashes.

If you cancel the SteadyShot function*

The SteadyShot off indicator  appears. Your camcorder prevents excessive compensation for camera-shake.



* CCD-TRV308/TRV408/TRV608 only

Icon/item	Mode	Meaning	POWER switch
 EDIT	● OFF	—	PLAYER
	ON	To minimize picture deterioration when editing.	
TBC	● ON	To correct jitter.	PLAYER
	OFF	To not correct jitter. Set TBC to OFF when playing back a tape on which you have dubbed over and recorded the signal of a TV game or similar machine.	
TBC stands for "Time Base Corrector."			
DNR	● ON	To reduce picture noise.	PLAYER
	OFF	To reduce a conspicuous afterimage when the picture has a lot of movement.	
DNR stands for "Digital Noise Reduction."			

In more than 5 minutes after removing the power source

The "EDIT" item is returned to their default settings.

The other menu items are held in memory even when the battery is removed.



Icon/item	Mode	Meaning	POWER switch
 LCD BRIGHT	---	To adjust the brightness on the LCD screen with the SEL/PUSH EXEC dial to adjust the following bar.	PLAYER CAMERA
			
LCD B.L.	● BRT NORMAL	To set the brightness on the LCD screen normal.	PLAYER CAMERA
	BRIGHT	To brighten the LCD screen.	
LCD COLOR	---	To adjust the color on the LCD screen, turn the SEL/PUSH EXEC dial to adjust the following bar.	PLAYER CAMERA
			
VF B.L.*	● BRT NORMAL	To set the brightness in the viewfinder normal.	PLAYER CAMERA
	BRIGHT	To brighten the viewfinder.	

Changing the menu settings

Notes on VF B.L.* and LCD B.L.

- When you select BRIGHT, battery life is reduced by about 10 percent during recording.
- When you use power sources other than the battery pack, BRIGHT is automatically selected.

* CCD-TRV107/TRV308/TRV408/TRV608 only

Icon/item	Mode	Meaning	POWER switch
 REC MODE	<input checked="" type="radio"/> SP	To record in the SP (Standard Play) mode.	CAMERA
	LP	To increase the recording time to twice the SP mode.	
ORC TO SET	----	To automatically adjust the recording condition to get the best possible recording. Press START/STOP to start adjustment. Your camcorder takes about 10 seconds to check the tape condition and then returns to the standby mode. ORC stands for "Optimizing the Recording Condition."	CAMERA
 REMAIN	<input checked="" type="radio"/> AUTO	To display the remaining tape bar: – for about 8 seconds after your camcorder is turned on and calculates the remaining amount of tape. – for about 8 seconds after a cassette is inserted and your camcorder calculates the remaining amount of tape. – for about 8 seconds after ► is pressed in PLAYER mode. – for about 8 seconds after DISPLAY is pressed to display the screen indicators. – for the period of tape rewinding, forwarding or picture search in PLAYER mode.	PLAYER CAMERA
	ON	To always display the remaining tape bar.	

Notes on the LP mode

- When you record a tape in the LP mode on your camcorder, we recommend playing back the tape on your camcorder. When you play back the tape on other camcorders or VCRs, noise may occur in images or sound.
- When you record in the LP mode, we recommend using a Sony video cassette so that you can get the most out of your camcorder.
- When you record in both the SP and LP modes on one tape, or you record some scenes in the LP mode, the playback image may be distorted.
- Noise may occur also when you play back on your camcorder tapes recorded in the LP mode on other camcorders or VCRs.
- When you record a tape in the LP mode on your camcorder, recording is carried out in the standard 8 mm system.

Changing the menu settings

Notes on ORC setting

- Each time you eject the cassette, the ORC setting will be canceled. If necessary, set the setting.
- You cannot use this setting on a tape with the red mark on the cassette exposed. (i. e. the tape is write-protected)
- When you set ORC TO SET, a non-recorded section of about 0.1 second appears on the tape. However, note that this non-recorded section disappears from the tape when you continue recording from this section.
- To check if you have already set the ORC setting, select ORC TO SET in the menu settings. “ORC ON” is displayed if ORC TO SET is already set.

Icon/item	Mode	Meaning	POWER switch
 CLOCK SET	---	To set the date or time. (p. 16)	CAMERA
AUTO DATE	● ON	To record the date for 10 seconds after recording has started.	CAMERA
	OFF	To cancel the auto date function.	
USB STREAM	● OFF	To deactivate the USB Streaming function.	PLAYER CAMERA
	ON	To activate the USB Streaming function.	
LTR SIZE	● NORMAL	To display selected menu items in normal size.	PLAYER CAMERA
	2×	To display selected menu items at twice the normal size.	
LANGUAGE	● ENGLISH	To display the following information indicators in English: min, STBY, REC, VOL, END SEARCH and START.	PLAYER CAMERA
	FRANÇAIS	To display the information indicators in French.	
	ESPAÑOL	To display the information indicators in Spanish.	
	PORTUGUÊS	To display the information indicators in Portuguese.	
	中文	To display the information indicators in Chinese.	
	한국어	To display the information indicators in Korean.	
DEMO MODE	● ON	To make the demonstration appear.	CAMERA
	OFF	To cancel the demonstration mode.	

Notes on DEMO MODE

- You cannot select DEMO MODE when a cassette is inserted in your camcorder.
- DEMO MODE is set to STBY (Standby) at the factory and the demonstration starts about 10 minutes after you have set the POWER switch to CAMERA without a cassette inserted.
To cancel the demonstration, insert a cassette, set the POWER switch to other than CAMERA, or set DEMO MODE to OFF.
- When NIGHTSHOT is set to ON,  “NIGHTSHOT” indicator appears on the screen and you cannot select DEMO MODE in the menu settings.

Changing the menu settings

Icon/item	Mode	Meaning	POWER switch
 WORLD TIME	---	To set the clock to the local time. Turn the SEL/PUSH EXEC dial to set the time difference. The clock changes by the time difference you set here. If you set the time difference to 0, the clock returns to the originally set time.	CAMERA
BEEP	● MELODY	To output the melody when you start/stop recording or when an unusual condition occurs on your camcorder	PLAYER CAMERA
	NORMAL	To output the beep instead of the melody	
	OFF	To cancel the melody and beep sound	
COMMANDER*	● ON	To activate the Remote Commander supplied with your camcorder	PLAYER CAMERA
	OFF	To deactivate the Remote Commander to avoid unintentional operations caused by other VCR's remote controls.	
DISPLAY	● LCD	To show the display on the LCD screen and in the viewfinder	PLAYER CAMERA
	V-OUT/LCD	To show the display on the TV screen, LCD screen, and in the viewfinder	
REC LAMP	● ON	To light up the recording lamp at the front of your camcorder when recording	CAMERA
	OFF	To turn the recording lamp off so that the subject is not aware of the recording	

In more than 5 minutes after removing the power source

The "COMMANDER"* item is returned to the default setting.

The other menu items are held in memory even when the battery is removed.

Recording a close-up picture

When REC LAMP is set to ON, the red recording lamp on the front of the camcorder may reflect on the subject if it is close. In this case, we recommend you set REC LAMP to OFF.

* CCD-TRV107/TRV408 only

Types of trouble and their solutions

If you run into any problem using your camcorder, use the following table to troubleshoot the problem. If the problem persists, disconnect the power source and contact your Sony dealer or local authorized Sony service facility. If “C:□□:□□” appears on the screen, the self-diagnosis display function has worked. See page 77.

In the recording mode

Symptom	Cause and/or Corrective Actions
START/STOP does not operate.	<ul style="list-style-type: none"> • The POWER switch is set to OFF (CHG) or PLAYER. → Set it to CAMERA. (p. 19) • The tape has run out. → Rewind the tape or insert a new one. (p. 18, 29) • The write-protect tab is set to expose the red mark. → Use a new tape or slide the tab. (p. 18) • The tape is stuck to the drum (moisture condensation). → Remove the cassette and leave your camcorder for at least 1 hour to acclimate. (p. 84)
The power goes off.	<ul style="list-style-type: none"> • While being operated in CAMERA mode, your camcorder has been in the standby mode for more than 5 minutes. → Set the POWER switch to OFF (CHG) and then to CAMERA again. (p. 19) • The battery pack is dead or nearly dead. → Install a fully charged battery pack. (p. 11, 12)
The image on the viewfinder screen is not clear.	<ul style="list-style-type: none"> • The viewfinder lens is not adjusted. → Adjust the viewfinder lens. (p. 23)
The SteadyShot function does not work.*	<ul style="list-style-type: none"> • STEADYSHOT is set to OFF in the menu settings. → Set it to ON. (p. 68) • The wide mode is set to 16:9FULL. → Set it to OFF. (p. 68)
The autofocusing function does not work.	<ul style="list-style-type: none"> • The setting is the manual focus mode. → Press FOCUS to return to the autofocus mode. (p. 41) • Shooting conditions are not suitable for autofocus. → Adjust to focus manually. (p. 41)
The  indicator flashes in the viewfinder.	<ul style="list-style-type: none"> • The video heads may be dirty. → Clean the heads using the Sony V8-25CLD cleaning cassette (optional). (p. 85)
The picture does not appear in the viewfinder.	<ul style="list-style-type: none"> • The LCD panel is open. → Close the LCD panel. (p. 20)
A vertical band appears when you shoot a subject such as lights or a candle flame against a dark background.	<ul style="list-style-type: none"> • The contrast between the subject and background is too high. This is not a malfunction.
A vertical band appears when you shoot a very bright subject.	<ul style="list-style-type: none"> • This is not a malfunction.

(continued on the following page)

Types of trouble and their solutions

Symptom	Cause and/or Corrective Actions
An unknown picture is displayed on the screen.	<ul style="list-style-type: none"> • If 10 minutes elapse after you set the POWER switch to CAMERA or DEMO MODE is set to ON in the menu settings without a cassette inserted, your camcorder automatically starts the demonstration. → Insert a cassette and the demonstration stops. You can also cancel DEMO MODE. (p. 71)
The picture is recorded in incorrect or unnatural colors.	<ul style="list-style-type: none"> • NIGHTSHOT is set to ON. → Set it to OFF. (p. 26)
The picture appears too bright, and the subject does not appear on the screen.	<ul style="list-style-type: none"> • NIGHTSHOT is set to ON in a bright place. → Set it to OFF or use the NightShot function in a dark place. (p. 26) • The backlight function is working. → Cancel it. (p. 25)
A horizontal black band appears when shooting a TV screen or computer screen.*	<ul style="list-style-type: none"> • Set STEADYSHOT to OFF in the menu setting. (P. 68)

* CCD-TRV308/TRV408/TRV608 only



In the playback mode

Symptom	Cause and/or Corrective Actions
The tape does not move when a video control button is pressed.	<ul style="list-style-type: none"> • The POWER switch is set to CAMERA or OFF (CHG). → Set it to PLAYER. (p. 29)
The playback button does not work.	<ul style="list-style-type: none"> • The tape has run out. → Rewind the tape. (p. 29)
The playback picture is not clear or does not appear.	<ul style="list-style-type: none"> • The television's video channel is not adjusted correctly. → Adjust it. (p. 32) • EDIT is set to ON in the menu settings. → Set it to OFF. (p. 69) • The video head may be dirty. → Clean the heads using the Sony V8-25CLD cleaning cassette (optional). (p. 85)
No sound or only a low sound is heard when playing back a tape.	<ul style="list-style-type: none"> • The volume is turned to minimum. → Open the LCD panel and press VOLUME +. (p. 29)

In the recording and playback modes

Symptom	Cause and/or Corrective Actions
The power does not turn on.	<ul style="list-style-type: none"> • The battery pack is not installed, or is dead or nearly dead. → Install a charged battery pack. (p. 11, 12) • The AC power adaptor is not connected to a wall outlet. → Connect the AC power adaptor to a wall outlet. (p. 15)

Types of trouble and their solutions

Symptom	Cause and/or Corrective Actions
The end search function does not work.	<ul style="list-style-type: none"> The tape was ejected after recording. You have not recorded on the cassette yet.
The battery pack discharges quickly.	<ul style="list-style-type: none"> The operating temperature is too low. The battery pack is not fully charged. <ul style="list-style-type: none"> → Charge the battery pack fully again. (p. 11, 12) The battery pack is completely dead, and cannot be recharged. <ul style="list-style-type: none"> → Replace with a new battery pack. (p. 11)
The remaining battery time indicator does not indicate the correct time.	<ul style="list-style-type: none"> You have used the battery pack in an extremely hot or cold environment for a long time. The battery pack is completely dead, and cannot be recharged. <ul style="list-style-type: none"> → Replace with a new battery pack. (p. 11) The battery pack is not fully charged. A deviation has occurred in the remaining battery time. <ul style="list-style-type: none"> → Charge the battery pack fully again. (p. 11, 12)
The power goes off although the remaining battery time indicator indicates that the battery pack has enough power to operate.	<ul style="list-style-type: none"> A deviation has occurred in the remaining battery time. <ul style="list-style-type: none"> → Charge the battery pack fully again so that the indication on the battery remaining indicator is correct. (p. 11, 12)
The cassette cannot be removed from the holder.	<ul style="list-style-type: none"> The power source is disconnected. <ul style="list-style-type: none"> → Connect it firmly. (p. 11, 15) The battery pack is dead. <ul style="list-style-type: none"> → Use a charged battery pack. (p. 11, 12)
The  and  indicators flash and no functions except for cassette ejection work.	<ul style="list-style-type: none"> Moisture condensation has occurred. <ul style="list-style-type: none"> → Remove the cassette and leave your camcorder for at least 1 hour to acclimate. (p. 84)
The remaining tape indicator is not displayed.	<ul style="list-style-type: none"> The  REMAIN is set to AUTO in the menu settings. <ul style="list-style-type: none"> → Set it to ON to always display the remaining tape indicator. (p. 70)

Others

Symptom	Cause and/or Corrective Actions
Easy Dubbing does not function.	<ul style="list-style-type: none"> Your VCR and/or video camera recorder is not set correctly. <ul style="list-style-type: none"> → Make sure the input selector of the VCR is set to LINE. Also, make sure the power switch of the video camera is set to VTR/VCR. (p. 51) The IR SETUP code or PAUSE MODE is not set correctly. <ul style="list-style-type: none"> → Select the correct IR SETUP code and PAUSE MODE, according to your VCR. Then confirm VCR operation with the IR TEST function. (p. 52 to 55)

(continued on the following page)

Types of trouble and their solutions

Symptom	Cause and/or Corrective Actions
You cannot install the USB driver.* ¹⁾	<ul style="list-style-type: none"> Your camcorder was connected to your computer with the USB cable before installing the USB driver, so the driver was not recognized by the computer. <ul style="list-style-type: none"> → Uninstall the unrecognized driver, and then reinstall the driver. (p. 60)
USB Streaming function does not work* ¹⁾	<ul style="list-style-type: none"> The USB driver is not installed correctly. <ul style="list-style-type: none"> → Uninstall the unrecognized driver, and then reinstall the driver. (p. 61 to 63) Your computer's operating system is Windows 98 or earlier. The USB cable was not connected before starting up the application software. <ul style="list-style-type: none"> → Connect the USB cable before starting up the application software. (p. 63)
The Remote Commander supplied with your camcorder does not work.* ²⁾	<ul style="list-style-type: none"> COMMANDER is set to OFF in the menu settings. <ul style="list-style-type: none"> → Set it to ON. (p. 72) Something is blocking the infrared rays. <ul style="list-style-type: none"> → Remove the obstacle. The batteries are inserted in the battery holder with the + - polarities incorrectly matching the + - marks. <ul style="list-style-type: none"> → Insert the batteries with the correct polarity. (p. 96) The batteries are dead. <ul style="list-style-type: none"> → Insert new ones. (p. 96)
The date or time indicator does not appear, and the bars "--:--:--" appear.	<ul style="list-style-type: none"> Set the date and time. (p. 16)
The melody or beep sounds for 5 seconds.	<ul style="list-style-type: none"> Moisture condensation has occurred. <ul style="list-style-type: none"> → Remove the cassette and leave your camcorder for at least 1 hour to acclimate. (p. 84) Some troubles have occurred in your camcorder. <ul style="list-style-type: none"> → Remove the cassette and insert it again, then operate your camcorder.
No function works though the power is on.	<ul style="list-style-type: none"> Disconnect the power cord of the AC power adaptor or remove the battery pack, then reconnect it after about 1 minute. Turn the power on. (p. 19) If the functions still do not work, press RESET using a sharp-pointed object. (If you press RESET, all the settings including the date and time return to the default.) (p. 95)
While charging the battery pack, no indicator appears or the indicator flashes in the display window.	<ul style="list-style-type: none"> The AC power adaptor is disconnected. <ul style="list-style-type: none"> → Connect it firmly. (p. 15) The battery pack is not installed properly. <ul style="list-style-type: none"> → Install it properly. Something is wrong with the battery pack. <ul style="list-style-type: none"> → Contact your Sony dealer or local authorized Sony service facility.
You cannot charge the battery pack installed to your camcorder.	<ul style="list-style-type: none"> The POWER switch is not set to OFF (CHG). <ul style="list-style-type: none"> → Set it to OFF (CHG).

*¹⁾ CCD-TRV608 only

*²⁾ CCD-TRV107/TRV408 only

Self-diagnosis display

Your camcorder has a self-diagnosis display function.

This function displays the current condition of your camcorder as a 5-digit code (a combination of a letter and figures) on the LCD screen, in the viewfinder or in the display window.

If a 5-digit code is displayed, check the following code chart. The last two digits (indicated by □□) will differ depending on the state of your camcorder.

LCD screen, viewfinder or display window

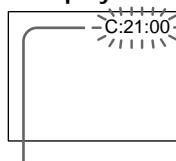

Self-diagnosis display

- C:□□:□□
You can service your camcorder yourself.
- E:□□:□□
Contact your Sony dealer or local authorized Sony service facility.

Five-digit display	Cause and/or Corrective Actions
C:04:□□	<ul style="list-style-type: none"> • You are using a battery pack that is not an "InfoLITHIUM" battery pack. → Use an "InfoLITHIUM" battery pack. (p. 81)
C:21:□□	<ul style="list-style-type: none"> • Moisture condensation has occurred. → Remove the cassette and leave your camcorder for at least 1 hour to acclimate. (p. 84)
C:22:□□	<ul style="list-style-type: none"> • The video heads are dirty. → Clean the heads using the Sony V8-25CLD cleaning cassette (optional). (p. 85)
C:31:□□ C:32:□□	<ul style="list-style-type: none"> • A malfunction other than the above that you can service has occurred. → Remove the cassette and insert it again, then operate your camcorder. → Disconnect the power cord of the AC power adaptor or remove the battery pack. After reconnecting the power source, operate your camcorder.
E:20:□□ E:61:□□ E:62:□□	<ul style="list-style-type: none"> • A malfunction that you cannot service has occurred. → Contact your Sony dealer or local authorized Sony service facility and inform them of the 5-digit code. (example: E:61:10)

If you are unable to rectify the problem even if you try corrective actions a few times, contact your Sony dealer or local authorized Sony service facility.

Warning indicators and messages

If indicators and messages appear on the screen or in the display window, check the following:

See the page in parentheses “ () ” for more information.

Warning indicators

The video heads are dirty

Slow flashing:

- You need to clean the heads using the Sony V8-25CLD cleaning cassette (optional). (p. 85)

The battery pack is dead or nearly dead

Slow flashing:

- The battery pack is nearly dead. (P. 12)

Depending on conditions, the environment or the battery pack, the warning indicator may flash, even if there are 5 to 10 minutes battery remaining.

Fast flashing:

- The battery pack is dead.
- The battery pack is completely dead, and cannot be charged.

Tape warning indicator

Slow flashing:

- The tape is near the end.
- No tape is inserted.*¹⁾
- The write-protect tab on the cassette is out (red).*¹⁾ (p. 18)

Fast flashing:

- The tape has run out.*¹⁾

Self-diagnosis display (p. 77)

Moisture condensation has occurred*¹⁾

Fast flashing:

- Eject the cassette, turn off your camcorder, and leave it for about 1 hour with the cassette compartment open. (p. 84)

You need to eject the cassette*¹⁾

Slow flashing:

- The write-protect tab on the cassette is out (red). (p. 18)

Fast flashing:

- Moisture condensation has occurred. (p. 84)
- The tape has run out.
- The self-diagnosis display function is activated. (p. 77)

Tape/Battery pack warning indicator*²⁾

Slow flashing:

- The battery pack is nearly dead.
- The tape is near the end.

Fast flashing:



- The battery pack is dead.
- The tape has run out.*¹⁾

*¹⁾ You hear the melody or beep sound.

*²⁾ This indicator appears in the viewfinder only.

Warning indicators and messages

Warning messages

- **CLOCK SET** Set the date and time. (p. 16)
- **FOR “InfoLITHIUM”
BATTERY ONLY** Use an “InfoLITHIUM” battery pack. (p. 81)
-  **NO TAPE*1)** Insert a cassette tape.
-  **TAPE END*1)** The tape has reached the end.
-  **CLEANING CASSETTE*2)** The video heads are dirty. (p. 85)
- **START/STOP KEY** Press START/STOP to activate the ORC setting. This message is displayed in white. (p. 70)
- **ORC** The ORC setting is working. This message is displayed in white. (p. 70)

*1) You hear the melody or beep sound.

*2) The  indicator and “ CLEANING CASSETTE” message appear one after another on the screen.

About video cassettes

Selecting the cassette type

You can use both Hi8 **Hi8** and standard 8 mm **8** video cassettes on your camcorder. When you use a Hi8 **Hi8** video cassette, recording and playback are carried out in the Hi8 **Hi8** system. When you use a standard 8 mm **8** video cassette, recording and playback are carried out in the standard 8 mm **8** system.

However, if you record on a Hi8 **Hi8** video cassette in the LP mode, recording is carried out in the standard 8 mm **8** system.

If you play back a tape recorded on a different video recorder on your camcorder, the playback mode is automatically selected according to the format in which the tape has been recorded.

This Hi8 **Hi8** system is an extension of the standard 8 mm **8** system, and was developed to produce higher quality pictures.

You cannot play back a tape recorded in the Hi8 **Hi8** system correctly on video recorders/players other than a Hi8 video recorder/player.

8 is a trademark.

Hi8 is a trademark.

When you play back

The playback mode (SP/LP) and system, Hi8 **Hi8**, or standard 8 mm **8** are automatically selected according to the format in which the tape has been recorded. The quality of the recorded picture in the LP mode, however, will not be as good as the SP mode.

Foreign 8 mm video

Because TV color systems differ from country to country, you may not be able to play back foreign pre-recorded tapes. Refer to “Using your camcorder abroad” (p. 83) to check the TV color systems used in foreign countries.

About the “InfoLITHIUM” battery pack

What is the “InfoLITHIUM” battery pack?

The “InfoLITHIUM” battery pack is a lithium-ion battery pack that has functions for communicating information related to operating conditions between your camcorder and the AC adaptor/charger (optional).

The “InfoLITHIUM” battery pack calculates the power consumption according to the operating conditions of your camcorder, and displays the remaining battery time in minutes.

Charging the battery pack

- Be sure to charge the battery pack before you start using your camcorder.
- We recommend charging the battery pack in an ambient temperature of between 10°C to 30°C (50°F to 86°F) until FULL appears indicating that the battery pack is fully charged, in the display window. If you charge the battery pack outside of this temperature range, you may not be able to efficiently charge the battery pack.
- After charging is completed, either disconnect the cable from the DC IN jack on your camcorder or remove the battery pack.

Effective use of the battery pack

- Battery performance decreases in low-temperature surroundings. So, the time that the battery pack can be used is shorter in cold places. We recommend the following to use the battery pack longer:
 - Put the battery pack in a pocket to warm it up, and insert it in your camcorder immediately before you start taking shots.
 - Use a large capacity battery pack (NP-FM50/FM70/QM71/FM90/FM91/QM91, optional).
- Frequently using the LCD panel or frequently operating playback, fast forward or rewind wears out the battery pack faster. We recommend using a large capacity battery pack (NP-FM50/FM70/QM71/FM90/FM91/QM91, optional).
- Be certain to turn the POWER switch to OFF (CHG) when not taking shots or playing back on your camcorder. Battery pack power is also consumed when your camcorder is in the standby mode or playback is paused.
- Have spare battery packs handy for two or three times the expected recording time, and make a trial recording before the actual recording.
- Do not expose the battery pack to water. The battery pack is not water-resistant.

Remaining battery time indicator

- If the power goes off although the remaining battery time indicator indicates that the battery pack has enough power to operate, charge the battery pack fully again so that the indication on the remaining battery time indicator is correct. Note, however, that the correct battery indication sometimes will not be restored if it is used in high temperatures for a long time or left in a fully charged state, or the battery pack is frequently used. Regard the remaining battery time indication as approximate.
- The  mark, indicating there is little remaining battery time, sometimes flashes depending on the operating conditions or ambient temperature and environment even if the remaining battery time is 5 to 10 minutes.

How to store the battery pack

- If the battery pack is not used for a long time, do the following once a year to maintain proper function.
 1. Fully charge the battery pack.
 2. Discharge on your camcorder.
 3. Remove the battery pack from your camcorder and store it in a dry, cool place.
- To discharge the battery pack on your camcorder, leave your camcorder in CAMERA (standby) mode without a cassette inserted until the power goes off.

About “InfoLITHIUM” battery pack

Battery life

- The battery life is limited. Battery capacity drops little by little as you use it more and more, and as time passes. When the available battery time is shortened considerably, a probable cause is that the battery pack has reached the end of its life. Please buy a new battery pack.
- The battery life varies according to storage and operating conditions, and environment for each battery pack.

Using your camcorder abroad

Using your camcorder abroad

You can use your camcorder in any country or area with the AC power adaptor supplied with your camcorder within 100 V to 240 V AC, 50/60 Hz.

When charging the battery pack, use a commercially available AC plug adaptor [a], if necessary, depending on the design of the wall outlet [b].

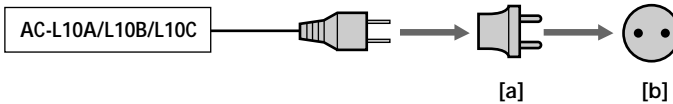

Your camcorder is an NTSC system based camcorder. If you want to view the playback picture on a TV, it must be an NTSC system based TV with Video/Audio input jack. The following shows TV color systems used overseas.

NTSC system

Bahama Islands, Bolivia, Canada, Central America, Chile, Colombia, Ecuador, Guyana, Jamaica, Japan, Korea, Mexico, Peru, Surinam, Taiwan, the Philippines, the U.S.A., Venezuela, etc.

PAL system

Australia, Austria, Belgium, China, Czech Republic, Denmark, Finland, Germany, Holland, Hong Kong, Hungary, Italy, Kuwait, Malaysia, New Zealand, Norway, Poland, Portugal, Singapore, Slovak Republic, Spain, Sweden, Switzerland, Thailand, United Kingdom, etc.

PAL-M system

Brazil

PAL-N system

Argentina, Paraguay, Uruguay

SECAM system



Bulgaria, France, Guiana, Iran, Iraq, Monaco, Russia, Ukraine, etc.

Simple setting of clock by time difference

You can easily set the clock to the local time by setting a time difference. Select WORLD TIME in the menu settings. See page 72 for more information.

Maintenance information and precautions

Moisture condensation

If your camcorder is brought directly from a cold place to a warm place, moisture may condense inside your camcorder, on the surface of the tape, or on the lens. In this condition, the tape may stick to the head drum and be damaged or your camcorder may not operate correctly. If there is moisture inside your camcorder, the beep sounds and the  indicator flashes. When the  indicator flashes at the same time, the cassette is inserted in your camcorder. If moisture condenses on the lens, the indicator will not appear.

If moisture condensation occurs

None of the functions except cassette ejection will work. Eject the cassette, turn off your camcorder, and leave it for about 1 hour with the cassette compartment open. Your camcorder can be used again if the  indicator does not appear when the power is turned on again.

Note on moisture condensation

Moisture may condense when you bring your camcorder from a cold place into a warm place (or vice versa) or when you use your camcorder in a hot place as follows:

- You bring your camcorder from a ski slope into a place warmed up by a heating device.
- You bring your camcorder from an air-conditioned car or room into a hot place outside.
- You use your camcorder after a squall or a shower.
- You use your camcorder in a high temperature and humid place.

How to prevent moisture condensation

When you bring your camcorder from a cold place into a warm place, put your camcorder in a plastic bag and tightly seal it. Remove the bag when the air temperature inside the plastic bag has reached the surrounding temperature (after about 1 hour).

Maintenance information and precautions

Maintenance information



Cleaning the LCD screen

If fingerprints or dust make the LCD screen dirty, we recommend using a LCD Cleaning Kit (optional) to clean the LCD screen.

Cleaning the video head

To ensure normal recording and clear pictures, clean the video heads.

The video head may be dirty when:

- the  indicator and "CLEANING CASSETTE" message appear one after another on the screen or the  indicator flashes on the screen.
- playback pictures contain noise.
- playback pictures are hardly visible.
- playback pictures do not appear.



[a] Slightly dirty

[b] Very dirty

If the above problem occurs, clean the video heads with the Sony V8-25CLD cleaning cassette (optional). Check the picture and if the above problem persists, repeat cleaning.

Note on video heads

When the playback pictures still contain noise even if you have cleaned the video heads with a cleaning cassette, the video heads may have worn down due to long use. If this is the case, they must be replaced with new heads. Contact your Sony dealer or local authorized Sony service facility.

Charging the built-in rechargeable battery in your camcorder

A built-in rechargeable battery is supplied with your camcorder so as to retain the date and time, etc., regardless of the setting of the POWER switch. The rechargeable battery is always charged as long as you are using your camcorder. The battery, however, will get discharged in about 6 months if you do not use your camcorder at all. Even if the rechargeable battery is not charged, it will not affect the camcorder operation. To retain the date and time, etc., charge the battery pack if the battery pack is discharged.

Charging the built-in rechargeable battery:

- Connect your camcorder to the wall outlet using the AC power adaptor supplied with your camcorder, and leave your camcorder with the POWER switch turned off for more than 24 hours.
- Or install the fully charged battery pack in your camcorder, and leave your camcorder with the POWER switch turned off for more than 24 hours.

Precautions

Camcorder operation

- Operate your camcorder on 7.2 V (battery pack) or 8.4 V (AC power adaptor).
- For DC or AC operation, use the accessories recommended in these operating instructions.
- If any solid object or liquid get inside the casing, unplug your camcorder and have it checked by a Sony dealer before operating it any further.
- Avoid rough handling or mechanical shock. Be particularly careful with the lens.
- Keep the POWER switch set to OFF (CHG) when you are not using your camcorder.
- Do not wrap your camcorder with a towel, for example, and operate it. Doing so might cause heat to build up inside.
- Keep your camcorder away from strong magnetic fields or mechanical vibration. Noise may occur on images.
- Do not touch the LCD screen with your fingers or a sharp-pointed object.
- If your camcorder is used in a cold place, a residual image may appear on the LCD screen. This is not a malfunction.
- While using your camcorder, the back of the LCD screen may heat up. This is not a malfunction.

Built-in light (CCD-TRV107/TRV308/TRV408/TRV608 only)

- Do not knock or jolt the built-in light while it is turned on as it may damage the bulb or shorten the life of the bulb.
- Do not leave the built-in light on while it is resting on or against something; it may cause a fire or damage the built-in light.

On handling tapes

Do not insert anything into the small holes on the rear of the cassette. These holes are used to sense the type and thickness of the tape and if the recording tab is in or out.

Camcorder care

- Remove the tape, and periodically turn on the power, operate the CAMERA and PLAYER sections and play back a tape for about 5 minutes when your camcorder is not to be used for a long time.
- Clean the lens with a soft brush to remove dust. If there are fingerprints on the lens, remove them with a soft cloth.
- Clean the camcorder body with a dry soft cloth, or a soft cloth lightly moistened with a mild detergent solution. Do not use any type of solvent which may damage the finish.
- Do not let sand get into your camcorder. When you use your camcorder on a sandy beach or in a dusty place, protect it from the sand or dust. Sand or dust may cause your camcorder to malfunction, and sometimes this malfunction cannot be repaired.

AC power adaptor

- Unplug the unit from the wall outlet when you are not using the unit for a long time. To disconnect the power cord, pull it out by the plug. Never pull the power cord itself.
- Do not operate the unit with a damaged cord or if the unit has been dropped or damaged.
- Do not bend the power cord forcibly, or place a heavy object on it. This will damage the cord and may cause fire or electrical shock.
- Prevent metallic objects from coming into contact with the metal parts of the connecting section. If this happens, a short may occur and the unit may be damaged.
- Always keep metal contacts clean.
- Do not disassemble the unit.
- Do not apply mechanical shock or drop the unit.
- While the unit is in use, particularly during charging, keep it away from AM receivers and video equipment. AM receivers and video equipment disturb AM reception and video operation.
- The unit becomes warm during use. This is not a malfunction.
- Do not place the unit in locations that are:
 - Extremely hot or cold
 - Dusty or dirty
 - Very humid
 - Vibrating

Maintenance information and precautions

About care and storage of the lens

- Wipe the surface of the lens with a soft cloth in the following instances:
 - When there are fingerprints on the lens surface
 - In hot or humid locations
 - When the lens is used in environments susceptible to salt such as the seaside
- Store the lens in a well-ventilated location subject to little dirt or dust.

To prevent mold from growing on the lens, periodically perform the above. We recommend turning on and operating your camcorder at least once per month to keep your camcorder in an optimum state for a long time.

Battery pack

- Use only the specified charger or video equipment for the charging function.
- To prevent an accidental short circuit, do not allow metal objects to come into contact with the battery terminals.
- Keep the battery pack away from fire.
- Never expose the battery pack to temperatures above 60°C (140°F), such as in a car parked in the sun or under direct sunlight.
- Keep the battery pack dry.
- Do not expose the battery pack to any mechanical shock.
- Do not disassemble nor modify the battery pack.
- Attach the battery pack to the video equipment securely.
- Charging while some capacity remains does not affect the original battery capacity.

Note on dry batteries (CCD-TRV107/TRV408 only)

To avoid possible damage from battery leakage or corrosion, observe the following:

- Be sure to insert the batteries with the + - polarities matched to the + - marks
- Dry batteries are not rechargeable
- Do not use a combination of new and old batteries
- Do not use different types of batteries
- Current drains from batteries when you are not using them for a long time
- Do not use leaking batteries

If batteries are leaking

- Wipe off the liquid in the battery compartment carefully before replacing the batteries.
- If you touch the liquid, wash it off with water.
- If the liquid get into your eyes, wash your eyes with a lot of water and then consult a doctor.

If any problem occurs, unplug your camcorder and contact your nearest Sony dealer.

Specifications

Video camera recorder

System

Video recording system

2 rotary heads

Helical scanning

FM system

Audio recording system

Rotary heads, FM system

Video signal

NTSC color, EIA standards

Usable cassette

8mm video format cassette

Hi8 or standard 8

Recording/playback time (using 120 min. Standard 8/Hi8 video cassette)

SP mode: 2 hours

LP mode: 4 hours

Fastforward/rewind time (using 120 min. Standard 8/Hi8 video cassette)

Approx. 5 min.

Viewfinder

Electric Viewfinder (monochrome)

Image device

CCD-TRV107/TRV108:

3.0 mm (1 / 6 type) CCD

(Charge Coupled Device)

Approx. 270 000 pixels

(Effective: Approx. 250 000 pixels)

CCD-TRV308/TRV408/TRV608:

4.5mm (1/4 type) CCD

(Charge Coupled Device)

Approx. 320 000 pixels

(Effective: Approx. 200 000 pixels)

Lens

Combined power zoom lens

Filter diameter 37 mm (1 7/16 in.)

CCD-TRV107:

20× (Optical), 450× (Digital)

CCD-TRV108/TRV308:

20× (Optical), 460× (Digital)

CCD-TRV408/TRV608:

20× (Optical), 560× (Digital)

Focal length

3.6 - 72 mm (5/32 - 2 7/8 in.)

When converted to a 35 mm still camera

CCD-TRV107/TRV108:

51.8 - 1 036 mm (2 - 40 6 / 8 in.)

CCD-TRV308/TRV408/TRV608:

41 - 820 mm (1 5 / 8 - 32 3 / 8 in.)

Color temperature

Auto

Minimum illumination

CCD-TRV308/TRV408/TRV608:

0.4 lx (lux) (F 1.4)

CCD-TRV107/TRV108:

1 lx (lux) (F 1.4)

0 lx (lux) (in the NightShot mode)*

* Objects unable to be seen due to the dark can be shot with infrared lighting.

Input/output connectors

S video output

4-pin mini DIN

Luminance signal: 1 Vp-p,

75 Ω (ohms), unbalanced

Chrominance signal: 0.286 Vp-p,

75 Ω (ohms), unbalanced

Audio/Video output

AV MINIJACK, 1 Vp-p, 75 Ω

(ohms), unbalanced, sync negative

327 mV, (at output impedance

more than 47 kΩ (kilohms))

Output impedance with less than

2.2 kΩ (kilohms)/Monaural

minijack

(ø 3.5 mm)

RFU DC OUT

Mini-mini jack (ø 2.5 mm)

DC 5V

⚡ USB jack (CCD-TRV608 only)

mini-B

LCD screen

Picture

CCD-TRV107/TRV108/TRV308/
TRV408:

6.2 cm (2.5 type)

50.3 × 37.4 mm (2 × 1 1/2 in.)

CCD-TRV608:

7.5 cm (3 type)

61.0 × 43.8 mm (2 1/2 × 1 3/4 in.)

Total dot number

CCD-TRV107/TRV108/TRV308/
TRV408:

61 600 (280 × 220)

CCD-TRV608:

123 200 (560 × 220)

General

Power requirements

7.2 V (battery pack)

8.4 V (AC power adaptor)

Average power consumption (when using the battery pack)

During camera recording using LCD

CCD-TRV107/TRV108/TRV308/
TRV408: 2.6 W

CCD-TRV608: 3.1 W

Viewfinder

1.9 W

Operating temperature

0 °C to 40 °C (32 °F to 104 °F)

Recommended charging temperature

10 °C to 30 °C (50 °F to 86 °F)

Storage temperature

-20 °C to +60 °C (-4 °F to +140 °F)

Dimensions (Approx.)

90 × 102 × 197 mm

(3 5/8 × 4 1/8 × 7 7/8 in.)

(w/h/d)

Mass (approx.)

CCD-TRV107/TRV108/TRV308/
TRV408:

850 g (1 lb 14 oz)

CCD-TRV608:

870 g (1 lb 14 oz)

main unit only

CCD-TRV107/TRV108/TRV308:

990 g (2 lb 3 oz)

CCD-TRV408/TRV608:

1.0 kg (2 lb 3 oz)

including the battery pack

NP-FM30, 120 min. Hi8 cassette,

lens cap and shoulder strap

Supplied accessories

See page 10.

AC power adaptor

Power requirements

100 - 240 V AC, 50/60 Hz

Power consumption

23 W

Output voltage

DC OUT: 8.4 V, 1.5 A in the

operating mode

Operating temperature

0 °C to 40 °C (32 °F to 104 °F)

Storage temperature

-20 °C to +60 °C (-4 °F to +140 °F)

Dimensions (approx.)

125 × 39 × 62 mm

(5 × 1 9/16 × 2 1/2 in.)

(w/h/d)

excluding projecting parts

Mass (approx.)

280 g (9.8 oz)

excluding power cord

Specifications

Battery pack

Maximum output voltage

DC 8.4 V

Output voltage

DC 7.2 V

Capacity

5.0 Wh (700 mAh)

Operating temperature

0 °C to 40 °C (32 °F to 104 °F)

Dimensions (approx.)

38.2 × 20.5 × 55.6 mm

(1 9/16 × 13/16 × 2 1/4 in.)

(w/h/d)

Mass (approx.)

65 g (2.3 oz)

Type

Lithium ion

Design and specifications are subject to change without notice.

Identifying the parts and controls

Camcorder

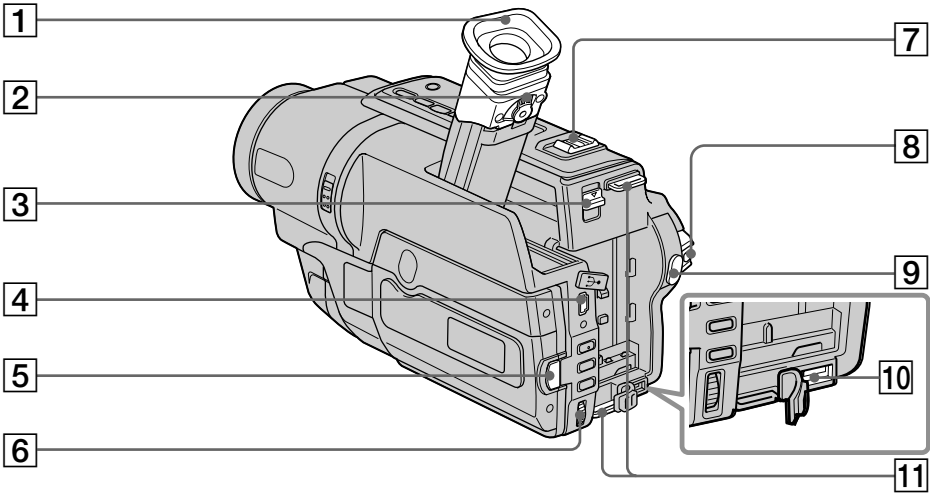

- | | |
|---|--|
| 1 Eyecup | 6 SEL/PUSH EXEC dial (p. 16, 67) |
| 2 Viewfinder lens adjustment lever (p. 23) | 7 Power zoom lever (p. 22) |
| 3 ▼ BATT release lever (p. 11) | 8 POWER switch (p. 19) |
| 4 USB connector (p. 61)
(CCD-TRV608 only) | 9 START/STOP button (p. 19) |
| 5 OPEN button (p. 19) | 10 DC IN jack (p. 12, 15) |
| | 11 Hooks for shoulder strap (p. 91) |

Attaching the shoulder strap

Attach the shoulder strap supplied with your camcorder to the hooks for the shoulder strap.



Identifying the parts and controls

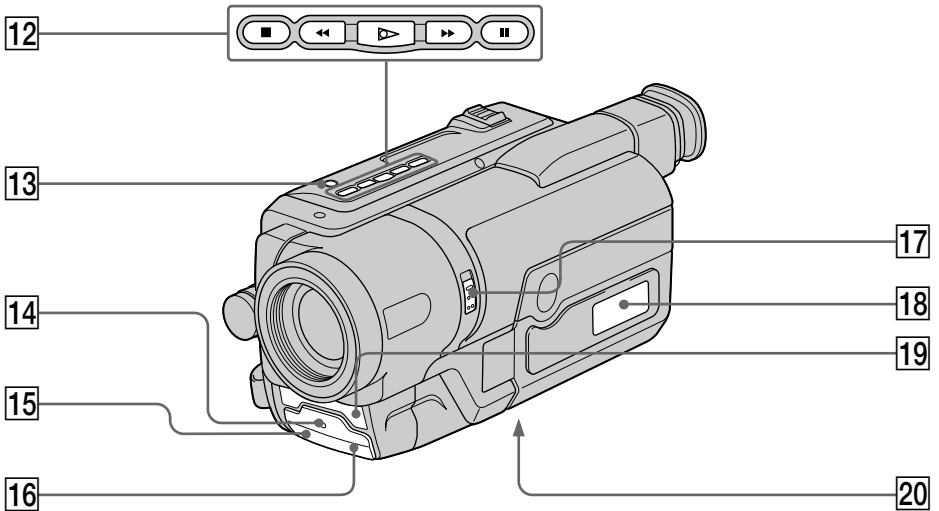

12 Video control buttons (p. 29, 31)

- STOP (stop)
- ◀◀ REW (rewind)
- ▶ PLAY (playback)*
- ▶▶ FF (fastforward)
- ▬▬ PAUSE (pause)

13 LIGHT button (p. 46)
(CCD-TRV107/TRV308/TRV408/
TRV608 only)

14 Recording lamp (p. 19)

15 Infrared rays emitter (p. 38)

16 Remote sensor (p. 96)
(CCD-TRV107/TRV408 only)

17 NIGHTSHOT switch (p. 26)

18 Display window (p. 97)

19 Microphone (p. 19)

20 Tripod receptacle (base)
Make sure that the length of the tripod
screw is less than 5.5 mm (7/32 in.).
Otherwise, you cannot attach the tripod
securely and the screw may damage
your camcorder.

* This button has a tactile dot.

Identifying the parts and controls

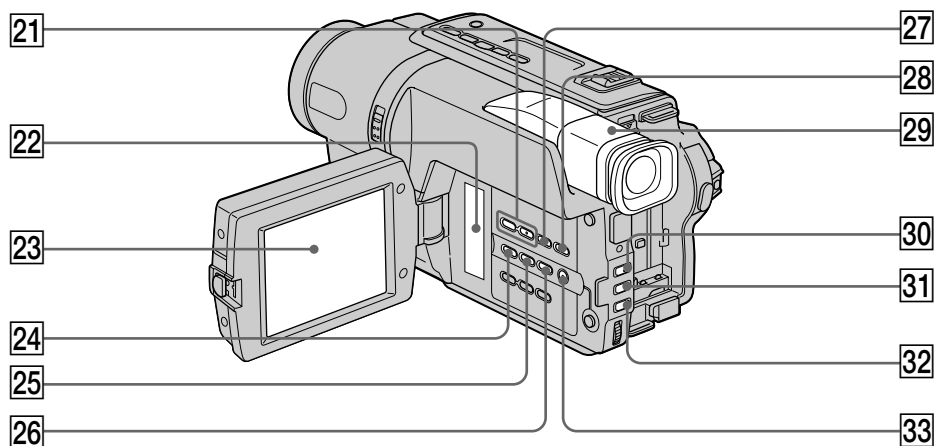

21 VOLUME +*/- buttons (p. 29)

22 Speaker

23 LCD screen (p. 19)

24 EXPOSURE button (p. 40)

25 TITLE button (p. 42, 44)

26 EASY DUBBING button (p. 51)

27 DISPLAY button (p. 30)

28 END SEARCH button (p. 28)

29 Viewfinder (p. 23)

30 FADER button* (p. 35)

31 BACK LIGHT button (p. 25)

32 FOCUS button (p. 41)

33 MENU button* (p. 67)

* This button has a tactile dot.

Identifying the parts and controls

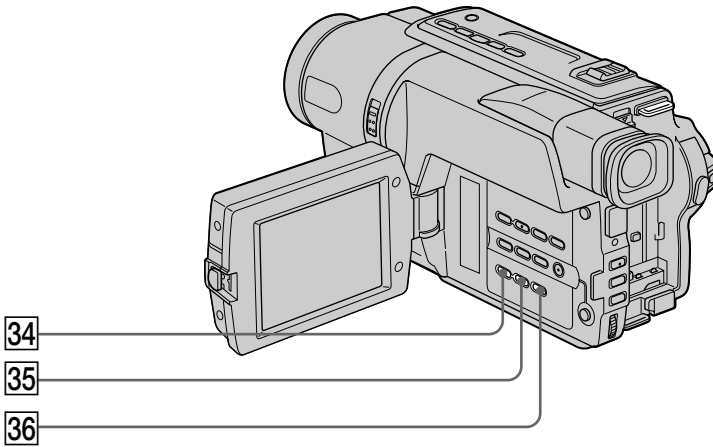

34 DATE button (p. 27)

35 TIME button* (p. 27)

36 COUNTER RESET button (p. 20)

* This button has a tactile dot.

Identifying the parts and controls

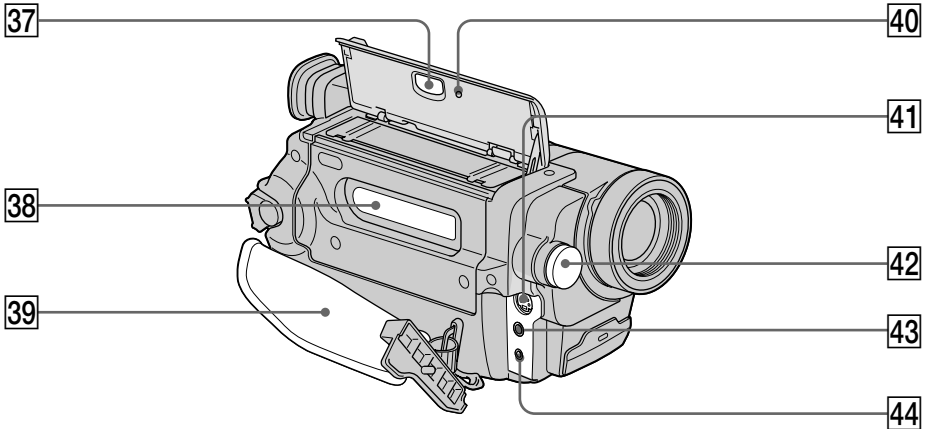

37 ▲ EJECT button (p. 18)

38 Cassette compartment (p. 18)

39 Grip strap

40 RESET button (p. 76)

41 S VIDEO OUT jack (p. 32, 49, 51)

42 Built-in light (p. 46)

(CCD-TRV107/TRV308/TRV408/
TRV608 only)

43 A/V OUT jack (p. 32, 49)

44 RFU DC OUT (RFU adaptor DC output)
jack (p. 32)

Fastening the grip strap
Fasten the grip strap firmly.

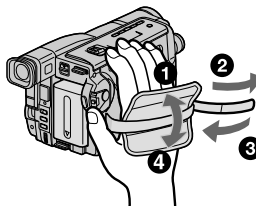

Attaching the lens cap
Attach the lens cap to the grip strap as illustrated.

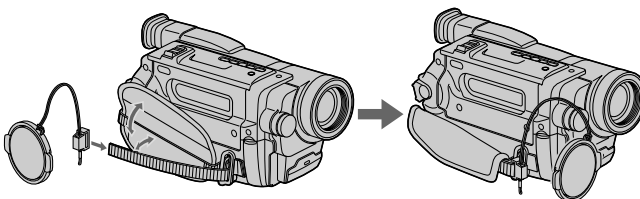

Identifying the parts and controls

Remote Commander

— CCD-TRV107/TRV408 only

The buttons that share the same name on the Remote Commander and your camcorder function identically to the buttons on your camcorder.

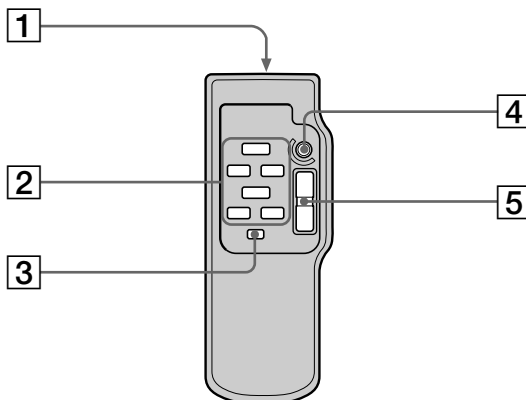

1 Transmitter

Point toward the remote sensor to control the camcorder after turning on the camcorder.

3 DISPLAY button (p. 30)

4 START/STOP button (p. 19)

5 Power zoom button (p. 22)

2 Tape transport buttons (p. 31)

To prepare the Remote Commander

Insert 2 size AA (R6) batteries by matching the + and - polarities on the batteries to the + - marks inside the battery compartment.

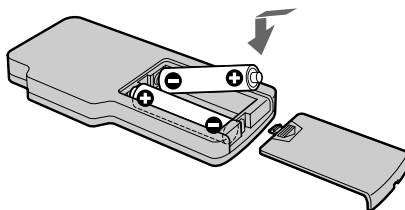

Notes on the Remote Commander

- Point the remote sensor away from strong light sources such as direct sunlight or overhead lighting. Otherwise, the Remote Commander may not function properly.
- Your camcorder works in the commander mode VTR 2. The commander modes 1, 2 and 3 are used to distinguish your camcorder from other Sony VCRs to avoid remote control unintentional operations. If you use another Sony VCR in the commander mode VTR 2, we recommend changing the commander mode or covering the sensor of the VCR with black paper.

Identifying the parts and controls

Operation indicators

LCD screen and Viewfinder

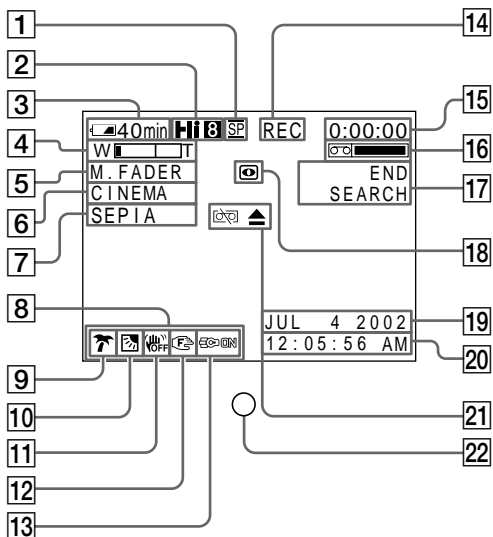

Display window

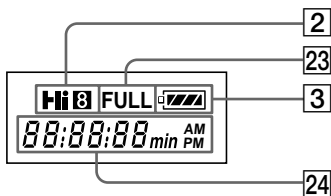

- 1 Recording mode indicator (p. 70)/
Mirror mode indicator (p. 20)
- 2 Hi8 format indication (p. 24)
- 3 Remaining battery time indicator
(p. 24)
- 4 Zoom indicator (p. 22)/
Exposure indicator (p. 40)
- 5 Fader indicator (p. 35)
- 6 Wide mode indicator (p. 33)
- 7 Picture effect indicator (p. 37)
- 8 Volume indicator (p. 29)
- 9 PROGRAM AE indicator (p. 38)
- 10 Backlight indicator (p. 25)
- 11 SteadyShot off indicator*¹⁾ (p. 69)
- 12 Manual focusing indicator (p. 41)
- 13 Built-in light indicator*²⁾ (p. 46)
- 14 STBY/REC indicator (p. 19)/
Video control mode indicator (p. 31)
- 15 Tape counter indicator (p. 24)/
Self-diagnosis display indicator
(p. 77)
- 16 Remaining tape indicator (p. 24)
- 17 END SEARCH indicator (p. 28)
- 18 NIGHTSHOT indicator (p. 26)
- 19 AUTO DATE indicator (p. 17)/
Date indicator (p. 16, 27)
- 20 Time indicator (p. 16, 27)
- 21 Warning indicators (p. 78)
- 22 Recording lamp (p. 19)
This indicator appears in the viewfinder
only.
- 23 FULL charge indicator (p. 12)
- 24 Tape counter indicator (p. 24)/
DATE or TIME indicator (p. 16, 27)/
Self-diagnosis display indicator
(p. 77)

*¹⁾ CCD-TRV308/TRV408/TRV608 only

*²⁾ CCD-TRV107/TRV308/TRV408/
TRV608 only

Index

A, B

AC power adaptor	15
Adjusting viewfinder	23
A/V connecting cable	32, 49, 55
BACK LIGHT	25
Battery pack	11
BEEP	72
BOUNCE	35

C, D

Charging battery	12
Charging the built-in rechargeable battery	86
Clock set	16
DEMO	71
DISPLAY	30
Dubbing a tape	49
DNR	69

E

Easy Dubbing	51
EDIT	69
END SEARCH	28
Exposure	40

F, G, H

Fade in/out	35
FADER	35
FOCUS	41
Grip strap	95
Heads	85
Hi8 system	80

I, J, K, L

“InfoLITHIUM” battery	81
Infrared rays emitter	26
LCD screen	20
LP mode	70

M, N

Manual focus	41
Menu settings	67
Mirror mode	20
Moisture condensation	84
MONOTONE	35
Mosaic fader	35
NightShot	26
NTSC system	83

O, P, Q

Operation indicators	97
ORC	70
Picture effect	37
Picture search	31
Playback pause	31
PROGRAM AE	38

R

Recording and playback systems	80
Recording mode	70
Recording time	13
Remaining battery time indicator	24
Remaining tape indicator	24
Remote Commander	96
Remote sensor	92
RESET	95
RFU adaptor	32

S

Self-diagnosis display	77
Shoulder strap	91
Skip scan	31
Slow playback	31
Standard 8 mm system	80
SteadyShot	68
STRIPE	35
Superimposing the date and time	27
S VIDEO OUT jack ...	32, 49, 51

T, U, V

Tape counter indicator	24
TBC	69
Telephoto	22
Title	42
Transition	20
TV color systems	83
USB Streaming	59
VF B.L.	23

W, X, Y, Z

Warning indicators	78
Wide-angle	22
Wide mode	33
WORLD TIME	72
Write-protect tab	18
Zoom	22

Printed on 100% recycled paper using VOC
(Volatile Organic Compound)-free vegetable
oil based ink.

<http://www.sony.net/>

Sony Corporation Printed in Japan

