

*Digital Video Camera Recorder*

## HANDYCAM®

### Operating Guide

**DCR-SR35E/SR36E/SR45E/SR46E/SR55E/  
SR65E/SR75E/SR85E**

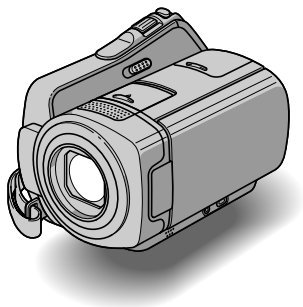

For details on the advanced operations, please refer to  
“Handycam Handbook” (PDF).



# Read this first

Before operating the unit, please read this manual thoroughly, and retain it for future reference.

## WARNING

**To reduce fire or shock hazard, do not expose the unit to rain or moisture.**



**Do not expose the batteries to excessive heat such as sunshine, fire or the like.**

## CAUTION

**Replace the battery with the specified type only. Otherwise, fire or injury may result.**

## Notice for customers in the United Kingdom

A moulded plug complying with BS1363 is fitted to this equipment for your safety and convenience.

Should the fuse in the plug supplied need to be replaced, a fuse of the same rating as the supplied one and approved by ASTA or BSI to BS1362 (i.e., marked with  or  mark) must be used. If the plug supplied with this equipment has a detachable fuse cover, be sure to attach the fuse cover after you change the fuse. Never use the plug without the fuse cover.

If you should lose the fuse cover, please contact your nearest Sony service station.

## FOR CUSTOMERS IN EUROPE

## ATTENTION

The electromagnetic fields at the specific frequencies may influence the picture and sound of this unit.

This product has been tested and found compliant with the limits set out in the EMC Directive for using connection cables shorter than

3 meters (9.8 feet).

## Notice

If static electricity or electromagnetism causes data transfer to discontinue midway (fail), restart the application or disconnect and connect the USB cable again.



**Disposal of Old Electrical & Electronic Equipment (Applicable in the European Union and other European countries with separate collection systems)**

This symbol on the product or on its packaging indicates that this product shall not be treated as household waste. Instead it shall be handed over to the applicable collection point for the recycling of electrical and electronic equipment. By ensuring this product is disposed of correctly, you will help prevent potential negative consequences for the environment and human health, which could otherwise be caused by inappropriate waste handling of this product. The recycling of materials will help to conserve natural resources. For more detailed information about recycling of this product, please contact your local Civic Office, your household waste disposal service or the shop where you purchased the product. Applicable Accessories: Remote Commander (DCR-SR55E/SR65E/SR75E/SR85E)



**Disposal of waste batteries (applicable in the European Union and other European countries with separate collection systems)**

This symbol on the battery or on the packaging indicates that the battery provided with this product shall not be treated as household waste.

By ensuring these batteries are disposed of correctly, you will help prevent potentially

negative consequences for the environment and human health which could otherwise be caused by inappropriate waste handling of the battery. The recycling of the materials will help to conserve natural resources.

In case of products that for safety, performance or data integrity reasons require a permanent connection with an incorporated battery, this battery should be replaced by qualified service staff only. To ensure that the battery will be treated properly, hand over the product at end-of-life to the applicable collection point for the recycling of electrical and electronic equipment.

For all other batteries, please view the section on how to remove the battery from the product safely. Hand the battery over to the applicable collection point for the recycling of waste batteries.

For more detailed information about recycling of this product or battery, please contact your local Civic Office, your household waste disposal service or the shop where you purchased the product.

#### **Notice for the customers in the countries applying EU Directives**

The manufacturer of this product is Sony Corporation, 1-7-1 Konan Minato-ku Tokyo, 108-0075 Japan. The Authorized Representative for EMC and product safety is Sony Deutschland GmbH, Hedelfinger Strasse 61, 70327 Stuttgart, Germany. For any service or guarantee matters please refer to the addresses given in separate service or guarantee documents.

#### **For customers in the U.S.A.**

If you have any questions about this product, you may call:  
Sony Customer Information Center 1-800-222-SONY (7669).

The number below is for the FCC related matters only.

## **Regulatory Information**

### **Declaration of Conformity**

Trade Name: SONY  
Model No.: DCR-SR45E, DCR-SR46E  
Responsible Party: Sony Electronics Inc.  
Address: 16530 Via Esprillo, San Diego, CA 92127 U.S.A.

Telephone number: 858-942-2230  
This device complies with Part 15 of the FCC Rules. Operation is subject to the following two conditions: (1) This device may not cause harmful interference, and (2) this device must accept any interference received, including interference that may cause undesired operation.

### **Declaration of Conformity**

Trade Name: SONY  
Model No.: DCR-SR65E, DCR-SR85E  
Responsible Party: Sony Electronics Inc.  
Address: 16530 Via Esprillo, San Diego, CA 92127 U.S.A.

Telephone number: 858-942-2230  
This device complies with Part 15 of the FCC Rules. Operation is subject to the following two conditions: (1) This device may not cause harmful interference, and (2) this device must accept any interference received, including interference that may cause undesired operation.

### **⚡ Note**

- DCR-SR65E/SR85E is to be used with the Handycam Station Model DCRA-C200 and AC Adaptor Model AC-L200/L200B.

### **CAUTION**

You are cautioned that any changes or modifications not expressly approved in this manual could void your authority to operate this equipment.

## Note

This equipment has been tested and found to comply with the limits for a Class B digital device, pursuant to Part 15 of the FCC Rules.

These limits are designed to provide reasonable protection against harmful interference in a residential installation. This equipment generates, uses, and can radiate radio frequency energy and, if not installed and used in accordance with the instructions, may cause harmful interference to radio communications. However, there is no guarantee that interference will not occur in a particular installation. If this equipment does cause harmful interference to radio or television reception, which can be determined by turning the equipment off and on, the user is encouraged to try to correct the interference by one or more of the following measures:

- Reorient or relocate the receiving antenna.
- Increase the separation between the equipment and receiver.
- Connect the equipment into an outlet on a circuit different from that to which the receiver is connected.
- Consult the dealer or an experienced radio/TV technician for help.

The supplied interface cable must be used with the equipment in order to comply with the limits for a digital device pursuant to Subpart B of Part 15 of FCC Rules.

## Battery pack

This device complies with Part 15 of the FCC Rules. Operation is subject to the following two conditions: (1) This device may not cause harmful interference, and (2) this device must accept any interference received, including interference that may cause undesired operation.

## Notes on use

### Supplied items

The numbers in ( ) are the supplied quantity.

- AC Adaptor (1)
- Power cord (Mains lead) (1)
- Handycam Station (1) **A** (DCR-SR55E/SR65E/SR75E/SR85E)
- A/V connecting cable (1) **B**
- USB cable (1) **C**
- Wireless Remote Commander (1) (DCR-SR55E/SR65E/SR75E/SR85E)  
A button-type lithium battery is already installed.
- Rechargeable battery pack NP-FH40 (1)
- 21-pin adaptor (1) (DCR-SR55E/SR65E/SR75E/SR85E)

For the models with the **CE** mark printed on their bottom surfaces only.

- CD-ROM "Handycam Application Software" (1) (p. 25)
  - Picture Motion Browser (Software)
  - PMB Guide
  - Handycam Handbook (PDF)
- "Operating Guide" (This manual) (1)

**A**





**B**

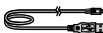

**C**



### Using the camcorder

- The camcorder is not dustproofed, dripproofed or waterproofed. See "Precautions" (p. 31).
- Do not do any of the following when the  (movie) or  (still image) lamps (p. 11) or ACCESS lamps (p. 13, 18) is lit or flashing. Otherwise the media may be damaged, recorded images may be lost or other malfunctions could occur.
  - Remove the "Memory Stick PRO Duo."
  - Remove the battery pack or AC Adaptor from the camcorder.
  - Apply mechanical shock or vibration to the camcorder.
- When connecting your camcorder to another device with a cable, be sure to insert the connector plug in the correct way. Pushing the plug forcibly into the terminal will damage the

terminal and may result in a malfunction of your camcorder.

- Do not apply shock or vibration to your camcorder. The hard disk of the camcorder may not be recognized, or recording or playback may not be possible.
- Do not use your camcorder in very loud areas. The hard disk of the camcorder may not be recognized, or recording may not be possible.
- To protect the internal hard disk from shock by dropping, the camcorder has drop sensor function\*. When a drop occurs, or under a non-gravity condition, the block noise made when this function is activated by the camcorder may also be recorded. If the drop sensor catches a drop repeatedly, recording/play back may be stopped.
- When the temperature of the camcorder becomes extremely high or extremely low, you may not be able to record or play back on the camcorder, due to the protection features of the camcorder being activated in such situations. In this case, an indicator appears on the LCD screen (p. 29).
- Do not turn on the camcorder in a low-pressure area, where the altitude is more than 3,000 meters (9,800 feet). Doing so may damage the hard disk drive of your camcorder.
- If you repeat recording/deleting images for a long time, fragmentation of data occurs on the media. Images cannot be saved or recorded. In such a case, save your images on some type of external media first, and then perform [MEDIA FORMAT]\*.
- Fasten the grip belt and hold your camcorder correctly while recording.

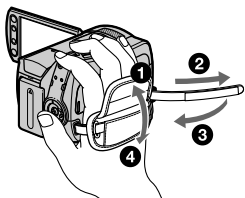

- To adjust the LCD panel, open the LCD panel 90 degrees to the camcorder (①), then rotate it to the best angle to record or play (②). You can rotate the LCD panel 180 degrees to the lens side (②) to record in mirror mode.

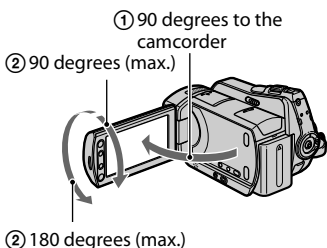

- The LCD screen is manufactured using extremely high-precision technology, so over 99.99% of the pixels are operational for effective use. However, there may be some tiny black points and/or bright points (white, red, blue, or green in color) that appear constantly on the LCD screen. These points are normal results of the manufacturing process and do not affect the recording in any way.
- Remove the insulation sheet before using the Remote Commander. (DCR-SR55E/SR65E/SR75E/SR85E)

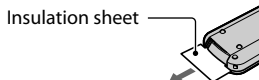

### Types of "Memory Stick" you can use with your camcorder

- For recording movies, it is recommended that you use a "Memory Stick PRO Duo" of 512 MB or larger marked with:
  - **MEMORY STICK PRO DUO** ("Memory Stick PRO Duo")\*
  - **MEMORY STICK PRO-HG DUO** ("Memory Stick PRO-HG Duo")
- \* Marked with Mark2 or not are available.
- A "Memory Stick PRO Duo" of up to 8 GB has been confirmed to operate correctly with this camcorder.
- See page 12 for the recordable time of a "Memory Stick PRO Duo."
- "Memory Stick PRO Duo" and "Memory Stick PRO-HG Duo" are both called as "Memory Stick PRO Duo" in this manual.

## On recording

- Before starting to record, test the recording function to make sure the image and sound are recorded without any problems.
- Compensation for failure or loss of recording cannot be provided, even if recording or playback is not possible due to a malfunction of the camcorder, recording media, etc.
- TV color systems differ depending on the country/region. To view your recordings on a TV, you need a PAL system-based TV.
- Television programs, films, video tapes, and other materials may be copyrighted. Unauthorized recording of such materials may be contrary to the copyright laws.

## Save all your recorded image data

- To prevent your image data from being lost, save all your recorded images on external media periodically. It is recommended that you save the image data on a disc such as a DVD-R using your computer\*. Also, you can save your image data using a VCR, or a DVD/HDD recorder\*.

## When the camcorder is connected to a computer

- Do not try to format the hard disk of the camcorder using a computer. If you do so, your camcorder may not operate correctly.

## Note on disposal/transfer

- If you perform [MEDIA FORMAT]\* to format the hard disk of the camcorder, data may not be completely deleted from the hard disk. When you transfer the camcorder, it is recommended that you perform [EMPTY]\* to prevent the recovery of your data.  
In addition to the above, when you dispose of the camcorder, it is recommended that you destroy the actual body of the camcorder.

## About language setting

- The on-screen displays in each local language are used for illustrating the operating procedures. Change the screen language before using your camcorder if necessary (p. 11).

## About this manual

- The LCD screens and indicators shown in this manual were taken with a digital still camera, and may look different from what you actually see.
- In this Operating Guide, the hard disk and "Memory Stick PRO Duo" are called "media."
- Unless otherwise specifically indicated, illustrations in this manual are based on DCR-SR85E.
- The screenshots are from Windows Vista, and may vary depending on the operating system of the computer.
- \* Refer also to "Handycam Handbook" (PDF) and "PMB Guide."



# Table of contents

Read this first .....	2
-----------------------	---

## Getting Started

Step 1: Charging the battery pack .....	8
Step 2: Turning the power on, and setting the date and time .....	11
Changing the language setting .....	11
Step 3: Selecting the media .....	12

## Recording/Playback

Recording .....	14
Playback .....	15
Playing the image on a TV .....	16
Other parts and functions of the camcorder .....	17
Indicators displayed during recording/ playback .....	19
Performing various functions - “  HOME” and “  OPTION” .....	21
Saving images .....	23
Deleting images .....	24

## Enjoying with a computer

Performing with a computer .....	25
Handbook/software to be installed .....	25
Installing “Picture Motion Browser” .....	25

## Troubleshooting

Troubleshooting .....	28
Self-diagnosis display/Warning indicators .....	29

## Additional Information

Precautions .....	31
Specifications .....	33

# Step 1: Charging the battery pack

DCR-SR55E/SR65E/SR75E/SR85E

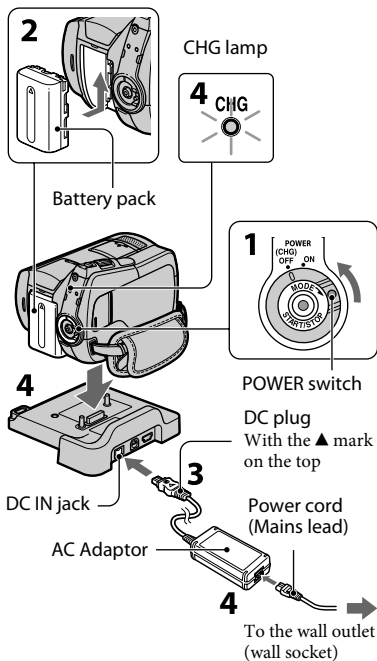

You can charge the “InfoLITHIUM” battery pack (H series) after attaching it to your camcorder.

## Notes

- Your camcorder operates only with an “InfoLITHIUM” battery pack (H series).

**1** Turn the POWER switch in the direction of the arrow to OFF (CHG) (the default setting).

**2** Attach the battery pack by sliding it in the direction of the arrow until it clicks.

**3** For DCR-SR55E/SR65E/SR75E/SR85E:  
Connect the AC Adaptor to the DC IN jack on the Handycam Station.

For DCR-SR35E/SR36E/SR45E/SR46E:  
Connect the AC Adaptor to the DC IN jack on your camcorder.

Open the jack cover and connect the DC plug of the AC Adaptor to the DC IN jack.

DCR-SR35E/SR36E/SR45E/SR46E

DC plug

With the ▲ mark on the right

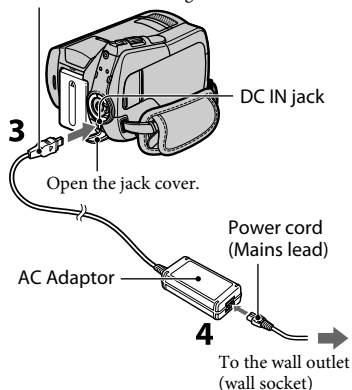

**4** For DCR-SR55E/SR65E/SR75E/SR85E:  
Connect the power cord (mains lead) to the AC Adaptor and the wall outlet (wall socket). Insert the camcorder into the Handycam Station securely, all the way to the bottom.

- When setting the camcorder onto the Handycam Station, close the DC IN jack cover.



**For DCR-SR35E/SR36E/SR45E/SR46E:**  
**Connect the power cord (mains lead) to the AC Adaptor and the wall outlet (wall socket).**

The CHG (charge) lamp lights up and charging starts.

The CHG (charge) lamp turns off when the battery is fully charged.

Disconnect the AC Adaptor from the DC IN jack holding both the DC plug and the Handycam Station (DCR-SR55E/SR65E/SR75E/SR85E) or your camcorder (DCR-SR35E/SR36E/SR45E/SR46E).

**Tips**

- For DCR-SR55E/SR65E/SR75E/SR85E: Same as DCR-SR35E/SR36E/SR45E/SR46E, you can charge the battery pack by connecting the AC Adaptor to your camcorder.

**To remove the battery pack**

Turn the POWER switch to OFF (CHG). Slide the BATT (battery) release lever and remove the battery pack.

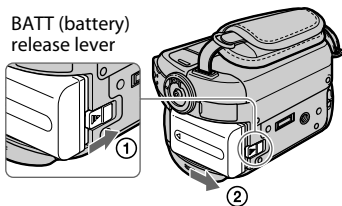

**Available running time for the supplied battery pack**

**Charging time:**  
 Approximate time (min.) required to fully charge a completely exhausted battery pack.

**Recording/Playback time:**  
 Approximate time (min.) available when

you use a fully charged battery pack.



	(Unit:min.)	
	DCR-SR35E/SR36E/ SR45E/SR46E	DCR-SR55E/SR65E/ SR75E/SR85E
Charging time	125	125
Recording time		
Continuous recording time	100 110	90 105
Typical recording time	50 50	45 50
Playback time	120 140	120 140

Top: When the media is set to the hard disk  
 Bottom: When the media is set to the "Memory Stick PRO Duo"

**Notes**

- All times measured under the following settings:
  - Recording mode: [SP]
  - The LCD backlight turns: [ON]
- Typical recording time shows the time when you repeat recording start/stop, turning the power on/off and zooming.

**On the battery pack**

- Before changing the battery pack or removing the AC Adaptor from the camcorder, turn the POWER switch to OFF (CHG) and make sure that the  (Movie) lamp/  (Still) lamp (p. 11)/ACCESS lamps (p. 13, 18) is turned off.
- The power will not be supplied from the battery as long as the AC Adaptor is connected to the DC IN jack of your camcorder or the Handycam Station (DCR-SR55E/SR65E/SR75E/SR85E), even when the power cord (mains lead) is disconnected from the wall outlet (wall socket).

**On the charging/recording/playback time**

- Times measured when using the camcorder at 25°C (77 °F) (10°C to 30°C (50 °F to 86 °F) is recommended).
- The available recording and playback time will be shorter when you use your camcorder in low temperatures.

- The available recording and playback time will be shorter depending on the conditions under which you use your camcorder.

**On the AC Adaptor**

- Use the nearby wall outlet (wall socket) when using the AC Adaptor. Disconnect the AC Adaptor from the wall outlet (wall socket) immediately if any malfunction occurs while using your camcorder.
- Do not use the AC Adaptor placed in a narrow space, such as between a wall and furniture.
- Do not short-circuit the DC plug of the AC Adaptor or battery terminal with any metallic objects. This may cause a malfunction.
- Even if your camcorder is turned off, AC power source (mains) is still supplied to it while connected to the wall outlet (wall socket) via the AC Adaptor.

## Step 2: Turning the power on, and setting the date and time

↑ (HOME) (p. 21)

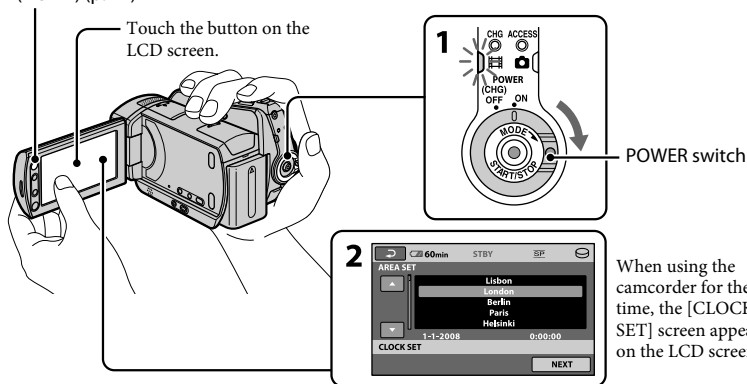

When using the camcorder for the first time, the [CLOCK SET] screen appears on the LCD screen.

**1** While pressing the green button, turn the POWER switch repeatedly in the direction of the arrow until the respective lamp lights up.

**🎬 (Movie):** To record movies

**📷 (Still):** To record still images

Go to step 3 when you turn on your camcorder for the first time.

- When you turn on the **📷 (Still)** lamp, the screen aspect ratio is changed to 4:3 automatically.

**2** Touch ↑ (HOME) → **⚙️ (SETTINGS)** → [CLOCK/🌐 LANG] → [CLOCK SET].

The [CLOCK SET] screen appears.

**3** Select the desired geographical area with ▲ / ▼, then touch [NEXT].

**4** Set [SUMMERTIME], [Y] (year), [M] (month), [D] (day), hour and minute, then touch [OK].



The clock starts.

### 💡 Tips

- The date and time do not appear during recording, but they are automatically recorded on the media, and can be displayed during playback.
- You can turn off the operation beeps by touching ↑ (HOME) → **⚙️ (SETTINGS)** → [SOUND/DISP SET] → [BEEP] → [OFF].

### Changing the language setting

You can change the on-screen displays to show messages in a specified language. Touch ↑ (HOME) → **⚙️ (SETTINGS)** → [CLOCK/🌐 LANG] → [🌐 LANGUAGE SET], then select the desired language.

## Step 3: Selecting the media

You can select the hard disk or “Memory Stick PRO Duo” as the recording/playback/editing media on your camcorder. Select the media for movies and still images separately.

The default setting is hard disk for movies and still images.

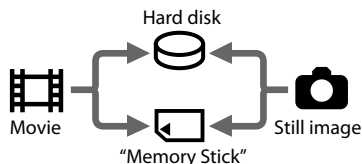

### Notes

- You can do recording/playback/editing operations for the selected media only. When you want to change, reselect the media.
- The recordable time with [SP] recording mode (the default setting) is as follows (approx):
  - The internal hard disk:
    - DCR-SR35E/SR45E: 10 hours 40 minutes
    - DCR-SR36E/SR46E/SR55E/SR65E: 14 hours 30 minutes
    - DCR-SR75E/SR85E: 21 hours 50 minutes
  - “Memory Stick PRO Duo” (4 GB) made by Sony Corporation: 80 minutes
- Check the number of recordable still images on the LCD screen of your camcorder (p. 19).

### 1 Touch **↑** (HOME) → **MANAGE MEDIA** tab on the screen.



### 2 Touch [MOVIE MEDIA SET] to select the media for movies, and touch [PHOTO MEDIA SET] to select the media for still images.

The media setting screen appears.

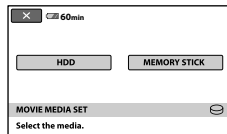

### 3 Select the media you want to set.

### 4 Touch [YES] → [OK].

The media is changed.

### To confirm the recording media setting

- Turn the POWER switch repeatedly to light up the (Movie)/ (Still) lamp, depending on which media setting you want to check.
- Check the media icon on the screen.

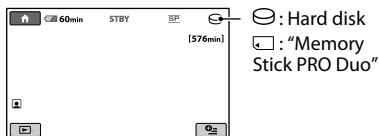

### Inserting the “Memory Stick PRO Duo”

Prepare a “Memory Stick PRO Duo” if [MEMORY STICK] has been selected as the media.

For types of “Memory Stick” you can use in your camcorder, see page 5.

### 1 Insert a “Memory Stick PRO Duo.”

- Open the Memory Stick Duo cover in the direction of the arrow.
- Insert a “Memory Stick PRO Duo” into the Memory Stick Duo slot in the right orientation until it clicks.
- Close the Memory Stick Duo cover.

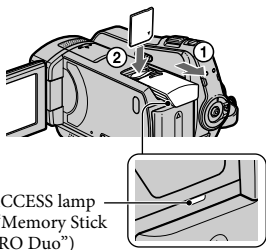

## 2 If you have selected [MEMORY STICK] as the movie media, turn the POWER switch until the (Movie) lamp lights up.

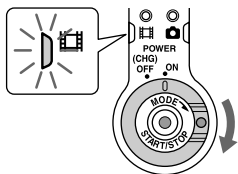

The [Create a new Image Database File.] screen appears on the LCD screen when you insert a new “Memory Stick PRO Duo.”

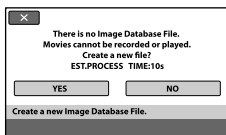

## 3 Touch [YES].

To record only still images on a “Memory Stick PRO Duo,” touch [NO].

### To remove the “Memory Stick PRO Duo”

Open the Memory Stick Duo cover and lightly push on the “Memory Stick PRO Duo.”

### Notes

- Do not open the Memory Stick Duo cover while recording.
- Inserting a “Memory Stick PRO Duo” forcibly in the wrong direction may cause a malfunction to the “Memory Stick PRO Duo,” Memory Stick Duo slot or image data.
- If [Failed to create a new Image Database File. It may be possible that there is not enough free space.] appears in step 3, format the “Memory Stick PRO Duo.” All recorded data on the “Memory Stick PRO Duo” will be deleted when you format.
- Be careful not to allow the “Memory Stick PRO Duo” to pop out and fall when you push on and remove it.

# Recording

The images are recorded on the media selected on the media setting (p. 12).  
The default setting is hard disk for both movies and still images.

## 1 LENS COVER switch

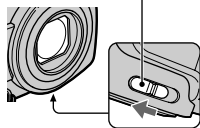

## 2 POWER switch

- : To record movies
- : To record still images

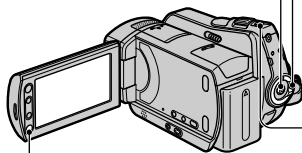

START/STOP **B**

## 3

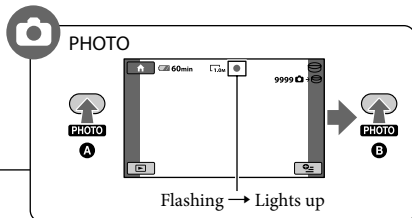
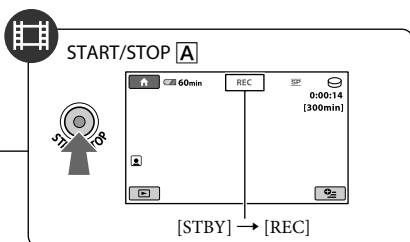

## 1 Slide the LENS COVER switch to open.

## 2 Turn the POWER switch until the respective lamp lights up.

Press the green button only when the POWER switch is in the OFF (CHG) position.

## 3 Start recording.

### Movies



Press **START/STOP A** (or **B**).

To stop recording, press **START/STOP B** again.

### Still Images



Press **PHOTO** lightly to adjust the focus

**A** (a beep sounds), then press it fully **B** (a shutter click sounds).

appears beside or . When disappears, the image has been recorded.

### Tips

- You can check the free media space by touching (HOME) → (MANAGE MEDIA) → [MEDIA INFO].

- The maximum continuous recordable time of movies is approximately 13 hours.
- When a movie file exceeds 2 GB, the next movie file is created automatically.

# Playback

You can play back images recorded on the media selected in the media setting (p. 12). The default setting is the hard disk.

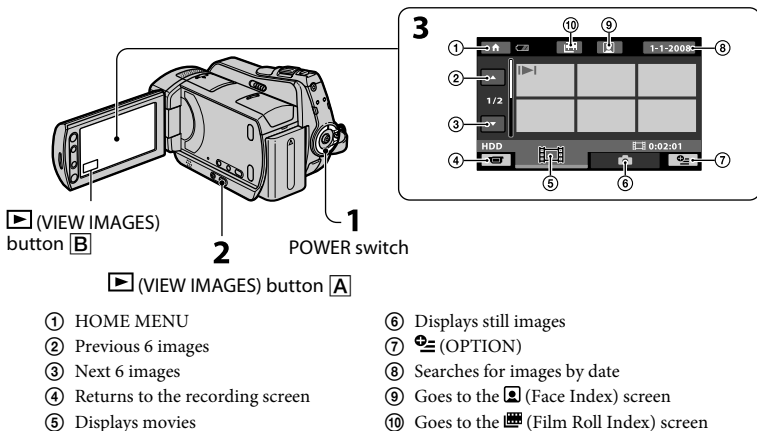

**1 Turn the POWER switch to turn on your camcorder.**

**2 Press the (VIEW IMAGES) [A] (or [B]) button.**

The VISUAL INDEX screen appears on the LCD screen. (It may take some seconds.)

**3 Start playback.**

## Movies



Touch the [tab], and the movie to be played back.

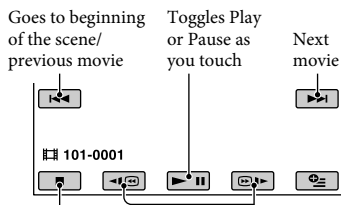

## Still Images



Touch the [tab], and the still image to be played back.

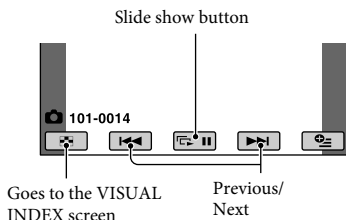

## To adjust the volume of movies

When playing back a movie, touch  $\text{⏮}$  (OPTION) →  $\text{▶}$  tab → [VOLUME], then adjust the volume with  $\text{[-]}$ / $\text{[+]}$ .

### 💡 Tips

- ▶|/▶ appears with the image on each of the tab that was lastly played back/recorded. When you touch image marked with ▶|/▶, you can play it back from the point you have stopped previously.

## Playing the image on a TV

Connect your camcorder to the input jack of a TV or VCR using the A/V connecting cable **1** (supplied) or an A/V connecting cable with S VIDEO **2** (optional). For details, see “Handycam Handbook” (PDF).

DCR-SR35E/SR36E/SR45E/SR46E

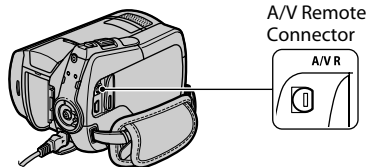

DCR-SR55E/SR65E/SR75E/  
SR85E

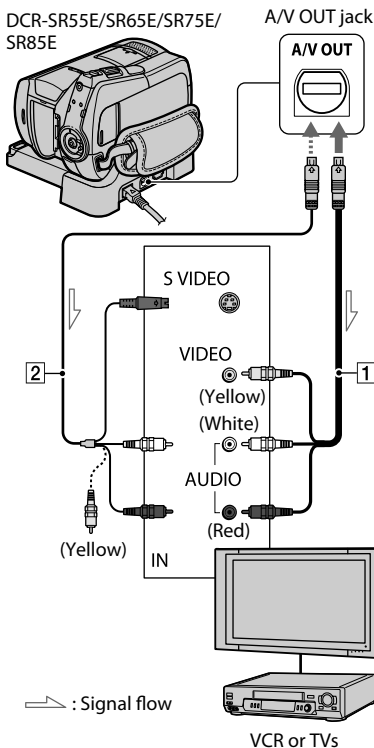



# Other parts and functions of the camcorder

Buttons, jacks, etc., which are not explained in other chapters, are explained here.

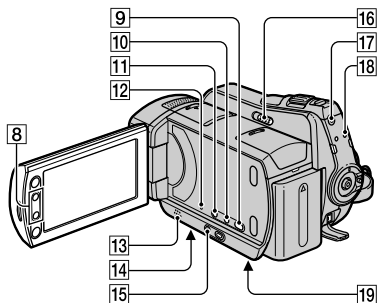
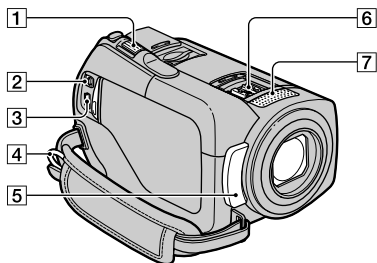

Handycam Station  
(DCR-SR55E/SR65E/SR75E/SR85E)

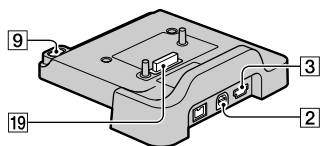

## Recording/Playback

- 1** Power zoom lever  
Move the power zoom lever slightly for a slower zoom. Move it further for a faster zoom.  
You can magnify still images from about 1.1 to 5 times the original size (Playback zoom).  
• When you touch the screen during



playback zoom, the point you touched will be displayed in the center of the displayed frame.

- 4** Hook for a shoulder belt  
Attach the shoulder belt (optional).
- 5** Remote sensor (DCR-SR55E/SR65E/SR75E/SR85E)/Infrared port  
Receives the signal from the Remote Commander.
- 7** Built-in microphone
- 8** Zoom buttons  
Press for zooming in/out.  
You can magnify still images from about 1.1 to 5 times the original size (Playback zoom).  
• When you touch the screen during playback zoom, the point you touched will be displayed in the center of the LCD screen.
- 9** (DISC BURN) button  
Create a disc by connecting the camcorder to a computer. For details, see "PMB Guide" (p. 25).
- 10** DISP/BATT INFO button  
You can switch the screen display when you press while the power is set to on. When you press while the power is set to OFF (CHG), you can check the remaining battery.
- 11** (back light) button  
Press (back light) to display for adjusting the exposure for backlit subjects. Press (back light) again to cancel the backlight function.
- 12** RESET button  
Press RESET to initialize all the settings, including the clock setting.
- 13** Speaker
- 14** Tripod receptacle (Bottom surface)  
Attach the tripod (optional: the length of the screw must be less than 5.5 mm (7/32 in.)) to the tripod receptacle using a tripod screw.
- 15** EASY button  
Press EASY to display and most

of the settings are set automatically for easy recording/playback. To cancel, press EASY again.

- 16** NIGHTSHOT PLUS switch  
Set the NIGHTSHOT PLUS switch to ON ( appears) to record in dark places.
- 17** QUICK ON button  
The QUICK ON lamp flashes and your camcorder goes to power saving mode (sleep mode). Press QUICK ON again to start recording next time. Your camcorder returns to recording standby in approximately 1 second.  
With [QUICK ON STBY], you can set the time when the camcorder turns off in sleep mode.
- 18** ACCESS lamp (Hard disk)  
When the ACCESS lamp is lit or flashing, your camcorder is writing/reading data.

## Connecting to the devices

- 2** A/V Remote Connector / A/V OUT jack  
Connect with the A/V connecting cable.
- 3**  (USB) jack  
(DCR-SR35E/SR36E/SR55E/SR75E: output only)  
Connect with the USB cable.
- 6** Active Interface Shoe  (DCR-SR55E/SR65E/SR75E/SR85E)  
The Active Interface Shoe supplies power to optional accessories such as a video light, a flash, or a microphone. The accessory can be turned on or off as you operate the POWER switch on your camcorder.
- 19** Interface connector  
Connect your camcorder and the Handycam Station.  
(DCR-SR55E/SR65E/SR75E/SR85E)

# Indicators displayed during recording/playback

## Recording movies

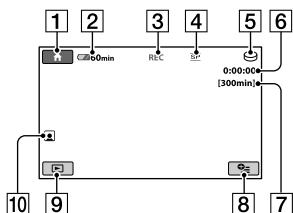

## Recording still images

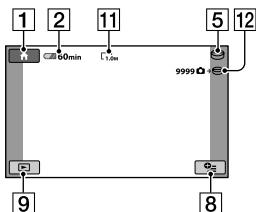

## Viewing movies

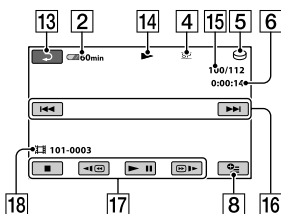

## Viewing still images

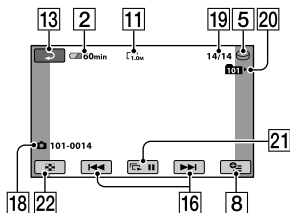

- 1 HOME button
- 2 Remaining battery (approx.)
- 3 Recording status ([STBY] (standby) or [REC] (recording))
- 4 Recording mode (HQ/SP/LP)
- 5 The recording/playback media
- 6 Counter (hour/minute/second)
- 7 Recording remaining times
- 8 OPTION button
- 9 VIEW IMAGES button
- 10 Face Index set
- 11 Image size
- 12 Approximate number of recordable still images/Recording media
- 13 Return button
- 14 Playback mode
- 15 Currently playing movie number/  
Number of total recorded movies
- 16 Previous/Next button
- 17 Video operation buttons
- 18 Data file name
- 19 Currently playing still image number/  
Number of total recorded still images
- 20 Playback folder  
Displays only when the recording  
media of still images is a "Memory Stick  
PRO Duo."
- 21 Slide show button
- 22 VISUAL INDEX button

## Indicators when you made changes

Following indicators appear during recording/playback to indicate the settings of your camcorder.

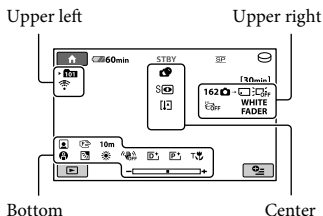

### Upper left

Indicator	Meaning
	Self-timer recording
	Flash/REDEYE REDUC
	MICREF LEVEL low
	WIDE SELECT
	BLT-IN ZOOM MIC

### Upper right

Indicator	Meaning
WHITE BLACK FADER FADER	Fader
	LCD backlight off
	Drop sensor off
	Drop sensor activated
	The media selected for still images

### Center

Indicator	Meaning
	IMAGE SIZE
	Slide show set
	NightShot plus
	Super NightShot plus
	Color Slow Shutter
	PictBridge connecting
	Warning

### Bottom

Indicator	Meaning
	Picture effect
	Digital effect
	Manual focus
	SCENE SELECTION
	Back light
	White balance
	SteadyShot off
	EXPOSURE / SPOT METER
	TELE MACRO
	Face Index

### 💡 Tips

- Indicators and their positions are approximate and differ from what you actually see. See "Handycam Handbook" (PDF) for details.
- The recording date and time is recorded automatically on the media. They are not displayed while recording. However, you can check them as [DATA CODE] during playback.

# Performing various functions - “HOME” and “OPTION”

You can display the menu screen by pressing **HOME** (A) (or B)/**OPTION** (OPTION). For details on the menu items, see “Handycam Handbook” (PDF) (p. 25).

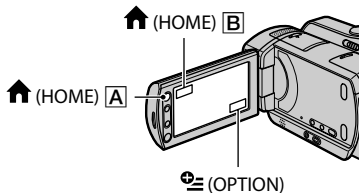

## Using the HOME MENU

You can change the operating settings for your convenience. Press **HOME** (A) (or B) to display the menu screen.



**1** Touch the desired category then item to change the setting.

**2** Follow the guide on the screen for further operation.

### Tips

- If the item is not on the screen, touch **▲** / **▼** to change the page.
- To hide the HOME MENU screen, touch **✕**.
- You cannot select or activate simultaneously the grayed items in the current recording/playback situation.

To see the explanation of the HOME MENU (HELP)

① Press **HOME** (A) (or B).

② Touch **?** (HELP).  
The bottom of the **?** (HELP) button turns orange.



③ Touch the item you want to know about.  
When you touch an item, its explanation appears on the screen.  
To apply the selected item, touch [YES].

## Using the OPTION MENU

The **OPTION** menu appears like the pop-up window that appears when you right-click the mouse on a computer. Touch **OPTION**, then the menu items you can set at that moment appears.

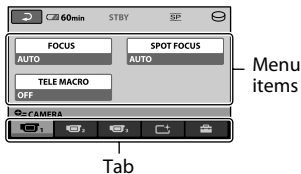

**1** Touch the desired tab then item to change the setting.

**2** After completing the setting, touch **OK**.

### Notes

- When the item you want is not on the screen, touch another tab. If you cannot find the item anywhere, the function is not available under the current situation.
- The **OPTION** menu cannot be used during Easy Handycam operation.

## Items of the HOME MENU

### (CAMERA) category

MOVIE\*<sup>1</sup>

PHOTO\*<sup>1</sup>

### (VIEW IMAGES) category

VISUAL

INDEX\*<sup>1</sup>

 INDEX\*<sup>1</sup>

 INDEX\*<sup>1</sup>

PLAYLIST

### (OTHERS) category

DELETE\*<sup>1</sup> [ DELETE], [ DELETE]

PHOTO  
CAPTURE









MOVIE DUB [DUB by select], [DUB by date], [ DUB ALL]

PHOTO COPY [COPY by select], [COPY by date]

EDIT [ DELETE], [ DELETE], [DIVIDE]

PLAYLIST EDIT [ ADD], [ ADD by date], [ ERASE], [ ERASE ALL], [ MOVE]

PRINT

USB CONNECT [ USB CONNECT], [ USB CONNECT], [DISC BURN]

### (MANAGE MEDIA) category

MOVIE MEDIA SET\*<sup>1</sup> [HDD], [MEMORY STICK]

PHOTO MEDIA SET\*<sup>1</sup> [HDD], [MEMORY STICK]

MEDIA  
INFO

MEDIA FORMAT\*<sup>1</sup> [HDD], [MEMORY STICK]

REPAIR [HDD], [MEMORY STICK]

IMG.DB F.

### (SETTINGS) category







MOVIE SETTINGS [REC MODE], [NIGHTSHOT LIGHT], [WIDE SELECT], [DIGITAL ZOOM], [STEADYSHOT], [AUTO SLW SHUTTR], [GUIDEFAME], [ REMAINING SET], [ INDEX SET]\*<sup>1</sup>

PHOTO SETTINGS [ IMAGE SIZE]\*<sup>1</sup>, [FILE NO.], [NIGHTSHOT LIGHT], [GUIDEFAME], [FLASH MODE]\*<sup>1+2</sup>, [FLASH LEVEL]\*<sup>2</sup>, [REDEYE REDUC]\*<sup>2</sup>

VIEW IMAGES SET [DATA CODE], [ DISPLAY]

SOUND/ DISP SET\*<sup>3</sup> [VOLUME]\*<sup>1</sup>, [BEEP]\*<sup>1</sup>, [LCD BRIGHT], [LCD BL LEVEL], [LCD COLOR]

OUTPUT SETTINGS [TV TYPE], [DISP OUTPUT]

CLOCK/ LANG [ CLOCK SET]\*<sup>1</sup>, [AREA SET], [SUMMERTIME], [ LANGUAGE SET]\*<sup>1</sup>

GENERAL SET [DEMO MODE], [CALIBRATION], [A.SHUT OFF], [QUICK ON STBY], [REMOTE CTRL]\*<sup>2</sup>, [DROP SENSOR]

\*<sup>1</sup> You can set the item during Easy Handycam operation.

\*<sup>2</sup> DCR-SR55E/SR65E/SR75E/SR85E

\*<sup>3</sup> The menu name is changed to [SOUND SETTINGS] during Easy Handycam operation.

## Items of the OPTION MENU

Items you can set only on the OPTION MENU will be described below.

### tab

[FOCUS], [SPOT FOCUS], [TELE MACRO], [EXPOSURE], [SPOT METER], [SCENE SELECTION], [WHITE BAL.], [COLOR SLOW SHTR], [S. NIGHTSHOT PLS]

### tab

[FADER], [D.EFFECT], [PICT.EFFECT]

### tab

[BLT-IN ZOOM MIC], [MICREF LEVEL], [SELF-TIMER]

### - (A tab depends on the situation/No tab)

[SLIDE SHOW], [SLIDE SHOW SET], [COPIES], [DATE/TIME], [SIZE]

## Saving images

Due to the limited capacity of the media, make sure that you save the image data to some type of external media such as a DVD-R or a computer.

You can save the images recorded on the camcorder as described below.

### Using a computer

By using “Picture Motion Browser” on the supplied CD-ROM, you can save images recorded on your camcorder. For details, see “PMB Guide” on the supplied CD-ROM.

### Creating a DVD with One Touch (One Touch Disc Burn)

You can save images recorded on the hard disk of the camcorder directly to a DVD with ease by pressing  (DISC BURN) button.

### Saving images on a computer (Easy PC Back-up)

You can save images recorded on the camcorder on the hard disk of a computer.

### Creating a DVD with selected images

You can save images imported to your computer on a DVD. You can also edit those images.

### Connecting your camcorder to other devices

For details, see “Handycam Handbook” (PDF).

### Connecting with the A/V connecting cable



You can dub to VCRs, DVD/HDD recorders.

### Connecting with the USB cable

You can dub to movie dubbing compatible DVD writers, etc.

# Deleting images



## Tips

- You can dub movies or copy still images from the hard disk to a “Memory Stick PRO Duo.”  
Touch  (HOME) →  (OTHERS) → [MOVIE DUB]/[PHOTO COPY].

Select the media which contains the images you want to delete before the operation (p. 12).

## Deleting movies

---

**1** Touch  (HOME) →  (OTHERS) → [DELETE].

---

**2** Touch [] [DELETE].

---

**3** Touch [] [DELETE].

---

**4** Touch the movie to be deleted.

The selected movie is marked with .

---

**5** Touch [OK] → [YES] → [OK].

### To delete all movies at one time

In step **3**, touch [] [DELETE ALL] → [YES] → [YES] → [OK].

### To delete the still images

① In step **2**, touch [] [DELETE].

② Touch [] [DELETE], then touch the still image to be deleted.

The selected still image is marked with .

③ Touch [OK] → [YES] → [OK].

## Tips

- To delete all still images on the media, in step ②, touch [] [DELETE ALL] → [YES] → [YES] → [OK].



# Performing with a computer

## Handbook/software to be installed

### “Handycam Handbook” (PDF)

“Handycam Handbook” (PDF) explains in detail about your camcorder and its practical use.

### “Picture Motion Browser” (only for Windows users)

“Picture Motion Browser” is the supplied software. You can enjoy the following operations.

- Creating a DVD with one touch operation
- Importing images to a computer
- Editing the imported images
- Creating a DVD

### Notes

- The supplied software “Picture Motion Browser” is not supported by Macintosh computers. To use a Macintosh computer connected to your camcorder, see the following website for details.  
<http://guide.d-imaging.sony.co.jp/mac/ms/us/>

## Installing and viewing “Handycam Handbook” (PDF)

To view “Handycam Handbook” (PDF), you need to install Adobe Reader on your computer.

Continue with the installation, even if a confirmation screen of an unknown publisher appears.

- ① Turn on the computer.
- ② Place the CD-ROM (supplied) in the disc drive of your computer.

The select screen for installation appears.



- ③ Click [Handycam Handbook].  
The installation screen for “Handycam Handbook” (PDF) appears.

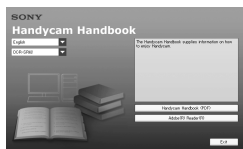

- ④ Select the desired language and the model name of your Handycam, then click [Handycam Handbook (PDF)].  
Installation starts. When the installation is completed, the short-cut icon of “Handycam Handbook” (PDF) appears on the desktop of your computer.
  - The model name of your Handycam is printed on its bottom surface.
- ⑤ Click [Exit] → [Exit], then remove the CD-ROM from the disc drive of your computer. To view “Handycam Handbook” (PDF), double click the short-cut icon.

### Tips

- For Macintosh users, follow the steps below.
  - ① Turn on the computer.
  - ② Place the CD-ROM (supplied) in the disc drive of your computer.
  - ③ Open the [Handbook] folder in the CD-ROM, double-click the [GB] folder and then drag-and-drop the “Handycam Handbook” on the computer.  
To view “Handycam Handbook” (PDF), double click “Handbook.pdf.”

## Installing “Picture Motion Browser”

### System requirements

For more information, refer to the support web site.

**OS:** Microsoft Windows 2000 Professional SP4, Windows XP SP2\*, Windows Vista\*

\* 64-bit editions and Starter (Edition) are not supported.

Standard installation is required. Operation is not assured if the above OS has been upgraded or in a multi-boot environment.

**CPU:** Intel Pentium III 1 GHz or faster

**Memory:** 256 MB or more

**Hard disk:** Disk volume required for installation: Approximately 500 MB (5 GB or more may be necessary when creating DVD-Videos.)

**Display:** Minimum 1,024 × 768 dots

**Others:**  $\Psi$  USB port (this must be provided as standard, Hi-Speed USB (USB 2.0 compatible) is recommended), DVD burner (CD-ROM drive is necessary for installation)

## ■ Installing software

You need to install the software to your Windows computer **before connecting your camcorder to the computer**. The installation is required only for the first time.

Contents to be installed and procedures may differ depending on your OS.

① Confirm that your camcorder is not connected to the computer.

② Turn on the computer.

### ⚡ Notes

- Log on as an Administrator for installation.
- Close all applications running on the computer before installing the software.

③ Place the supplied CD-ROM in the disc drive of your computer.

The installation screen appears.



If the screen does not appear

① Click [Start], then click [My Computer]. (For Windows 2000, double-click [My Computer].)

② Double-click [SONYPICTUTIL (E:)] (CD-ROM) (disc drive).\*

\* Drive names (such as (E:)) may vary depending on the computer.

④ Click [Install] on the installation screen of the computer.

⑤ Select the language for the application to be installed, then click [Next].

⑥ As the screen to confirm the connection appears, connect your camcorder to the computer following the steps below.

For DCR-SR55E/SR65E/SR75E/SR85E:

① Connect the AC Adaptor to the Handycam Station and a wall outlet (wall socket).

② Set the camcorder onto the Handycam Station, then turn the POWER switch to turn on.

③ Connect the  $\Psi$ (USB) jack of the Handycam Station to the  $\Psi$ (USB) jack of the computer using the supplied USB cable. The [USB SELECT] screen appears automatically on the LCD screen of your camcorder.

④ Touch [⊕ USB CONNECT] or [⊖ USB CONNECT] on the [USB SELECT] screen of your camcorder.

For DCR-SR35E/SR36E/SR45E/SR46E:

① Connect the AC Adaptor to the camcorder and a wall outlet (wall socket), then turn the POWER switch to turn on.

② Connect the  $\Psi$ (USB) jack of the camcorder to the  $\Psi$ (USB) jack of the computer using the supplied USB cable. The [USB SELECT] screen appears automatically on the LCD screen of your camcorder.

③ Touch [⊕ USB CONNECT] or [⊖ USB CONNECT] on the [USB SELECT] screen of your camcorder.



⑦ Click [Continue].

⑧ Read [License Agreement], select [I accept the terms of the license agreement] if you agree, then click [Next].

⑨ Confirm the installation settings, then click

[Install].

### Notes

- Even if a screen prompting you to restart your computer appears, you do not need to restart it at this time. Restart your computer after completing the installation.
  - It may take some time for the authentication.
- ⑩ Follow the on-screen instructions to install the software.
    - Depending on the computer, you may need to install third party software. If the installation screen appears, follow the instructions to install the required software.
  - ⑪ Restart the computer if required to complete the installation.
  - ⑫ Remove the CD-ROM from the disc drive of your computer.

### To disconnect the USB cable

- ① Click the  icon → [Safely remove USB Mass Storage Device] → [OK] (Windows 2000 only) on the task tray on the bottom right of the desktop of your computer.
- ② Touch [END] → [YES] on the screen of your camcorder.
- ③ Disconnect the USB cable.



### ■ Operating “Picture Motion Browser”

To start “Picture Motion Browser,” click [Start] → [All Programs] → [Sony Picture Utility] → [PMB - Picture Motion Browser].

For the basic operation of “Picture Motion Browser,” see “PMB Guide.”

To display “PMB Guide,” click [Start] → [All Programs] → [Sony Picture Utility] → [Help] → [PMB Guide].

### Tips

- If the [USB SELECT] screen does not appear, touch  (HOME) →  (OTHERS) → [USB CONNECT].

# Troubleshooting

If you run into any problems using your camcorder, use the following table to troubleshoot the problem. If the problem persists, disconnect the power source and contact your Sony dealer.

## Notes before sending your camcorder for repair

- Your camcorder may require initializing or change the current hard disk of the camcorder, depending on the problem. In the event of this, the data stored on the hard disk will be deleted. Be sure to save the data on the internal hard disk (see “Handycam Handbook” (PDF)) on other media (backup) before sending your camcorder for repair. We will not compensate you for any loss of hard disk data.
- During repair, we may check a minimum amount of data stored on the hard disk in order to investigate the problem. However, your Sony dealer will neither copy nor retain your data.
- For the symptoms of your camcorder, see “Handycam Handbook” (PDF) and for connecting to the computer, see “PMB Guide.”

## The power does not turn on.

- Attach a charged battery pack to the camcorder (p. 8).
- Connect the plug of the AC Adaptor to the wall outlet (wall socket) (p. 8).

## The camcorder does not operate even when the power is set to on.

- It takes a few seconds for your camcorder to be ready to shoot after the power is turned on. This is not a malfunction.
- Disconnect the AC Adaptor from the wall outlet (wall socket) or remove the battery pack, then reconnect it after about 1 minute. If the functions still do not work, press the RESET button (p. 17) using a sharp-pointed object. (If you press the RESET button, all settings, including the clock setting, are reset.)
- The temperature of your camcorder is extremely high. Turn off your camcorder and leave it for a while in a cool place.
- The temperature of your camcorder is extremely low. Turn off the camcorder

and take it to a warm place. Leave the camcorder there for a while, then turn on the camcorder.



## Your camcorder gets warm.

- This is because the power has been turned on for a long time. This is not a malfunction.

## The power abruptly turns off.

- Use the AC Adaptor.
- Turn on the power again.
- Charge the battery pack (p. 8).

## Pressing START/STOP or PHOTO does not record images.

- Set the POWER switch to  (Movie) or  (Still) (p. 11).
- You cannot record images in sleep mode. Press the QUICK ON button (p. 18).
- Your camcorder is recording the image you have just shot on the media. You cannot make new recording during this period.
- The media of the camcorder is full. Delete unnecessary images (p. 24).
- Total number of movies or still images exceeds the recordable capacity of the media. Delete unnecessary images (p. 24).

## The recording stops.

- The temperature of your camcorder is extremely high/low. Turn off your camcorder and leave it for a while in a cool/warm place.

## You cannot install “Picture Motion Browser.”

- Check the computer environment required to install “Picture Motion Browser.”
- Install “Picture Motion Browser” in an orderly manner (p. 25).

## “Picture Motion Browser” does not work correctly.

- Quit “Picture Motion Browser” and restart

your computer.

### Your camcorder is not recognized by the computer.









- Disconnect devices from the USB jack of the computer other than the keyboard, mouse, and your camcorder.
- Disconnect the USB cable from the computer and the Handycam Station, and restart the computer, then connect the computer and your camcorder again in an orderly manner.





### Self-diagnosis display/Warning indicators

If indicators appear on the LCD screen, check the following.

If the problem persists even after you have tried a couple of times, contact your Sony dealer or local authorized Sony service facility.

Indicators/Messages	Causes/Solutions
C:04:□□	<ul style="list-style-type: none"> <li>• The battery pack is not an “InfoLITHIUM” battery pack (H series). Use an “InfoLITHIUM” battery pack (H series)(p. 8).</li> <li>• Connect the DC plug of the AC Adaptor to the DC IN jack of the Handycam Station or your camcorder securely (p. 8).</li> </ul>
C:13:□□ / C:32:□□	<ul style="list-style-type: none"> <li>• Remove the power source. Reconnect it and operate your camcorder again.</li> </ul>
E:20:□□ / E:31:□□ / E:61:□□ / E:62:□□ / E:91:□□ / E:94:□□	<ul style="list-style-type: none"> <li>• A malfunction that you cannot service has occurred. Contact your Sony dealer or local authorized Sony service facility. Inform them of the 5-digit code, which starts from “E.”</li> </ul>

Indicators/Messages	Causes/Solutions
101-0001	<ul style="list-style-type: none"> <li>• The file is damaged or unreadable.</li> </ul>
	<ul style="list-style-type: none"> <li>• An error may have occurred with the hard disk drive in your camcorder.</li> </ul>
	<ul style="list-style-type: none"> <li>• Delete unnecessary images.</li> </ul>
	<ul style="list-style-type: none"> <li>• Battery power is low.</li> </ul>
	<ul style="list-style-type: none"> <li>• The temperature of your camcorder is getting higher or extremely high. Turn off your camcorder and leave it for a while in a cool place.</li> </ul>
	<ul style="list-style-type: none"> <li>• The temperature of your camcorder is extremely low. Make the camcorder warm.</li> </ul>
	<ul style="list-style-type: none"> <li>• When the indicator flashes slowly, free space for recording images are running out.</li> <li>• No “Memory Stick PRO Duo” is inserted (p. 12).</li> <li>• When the indicator flashes quickly, there are not enough free space for recording images. Delete unnecessary images, or format the “Memory Stick PRO Duo” after storing the images on other media (p. 23).</li> <li>• The Image Database File is damaged.</li> </ul>
	<ul style="list-style-type: none"> <li>• The “Memory Stick PRO Duo” is damaged.</li> <li>• The “Memory Stick PRO Duo” is not formatted correctly.</li> </ul>
	<ul style="list-style-type: none"> <li>• An incompatible “Memory Stick PRO Duo” is inserted.</li> </ul>

Indicators/Messages	Causes/Solutions
	<ul style="list-style-type: none"> <li>• Access to the “Memory Stick PRO Duo” was restricted on another device.</li> </ul>
	<ul style="list-style-type: none"> <li>• There is something wrong with the flash. (DCR-SR55E/SR65E/SR75E/SR85E)</li> </ul>
	<ul style="list-style-type: none"> <li>• The amount of light is not sufficient, so camera-shake easily occurs. Use the flash. (DCR-SR55E/SR65E/SR75E/SR85E)</li> <li>• The camcorder is unsteady, so camera-shake easily occurs. Hold the camcorder steady with both hands and record the image. However, note that the camera-shake warning indicator does not disappear.</li> </ul>
	<ul style="list-style-type: none"> <li>• The media is full.</li> <li>• Still images cannot be recorded during processing. Wait for a while, then record.</li> </ul>
	<ul style="list-style-type: none"> <li>• Drop sensor activated. Recording/playback may be disabled.</li> </ul>

## Precautions

### On use and care

- Do not use or store the camcorder and accessories in the following locations:
  - Anywhere extremely hot, cold or humid. Never leave them exposed to temperatures above 60°C (140 °F), such as under direct sunlight, near heaters or in a car parked in the sun. They may malfunction or become deformed.
  - Near strong magnetic fields or mechanical vibration. The camcorder may malfunction.
  - Near strong radio waves or radiation. The camcorder may not be able to record properly.
  - Near AM receivers and video equipment. Noise may occur.
  - On a sandy beach or anywhere dusty. If sand or dust gets in your camcorder, it may malfunction. Sometimes this malfunction cannot be repaired.
  - Near windows or outdoors, where the LCD screen or the lens may be exposed to direct sunlight. This damages the LCD screen.
- Operate your camcorder on DC 6.8 V/7.2 V (battery pack) or DC 8.4 V (AC Adaptor).
- For DC or AC operation, use the accessories recommended in these operating instructions.
- Do not let your camcorder get wet, for example, from rain or sea water. If your camcorder gets wet, it may malfunction. Sometimes this malfunction cannot be repaired.
- If any solid object or liquid gets inside the casing, unplug your camcorder and have it checked by a Sony dealer before operating it any further.
- Avoid rough handling, disassembling, modifying, physical shock, or impact such as hammering, dropping or stepping on the product. Be particularly careful of the lens.
- Keep the POWER switch setting to OFF (CHG) when you are not using your camcorder.
- Do not wrap your camcorder with a towel, for example, and operate it. Doing so might cause heat to build up inside.
- When disconnecting the power cord (mains lead), pull it by the plug and not the cord.
- Do not damage the power cord (mains lead) such as by placing anything heavy on it.
- Keep metal contacts clean.
- Keep the Remote Commander and button-type battery out of children's reach. If the battery

is accidentally swallowed, consult a doctor immediately (DCR-SR55E/SR65E/SR75E/SR85E).

- If the battery electrolytic liquid has leaked:
  - consult your local authorized Sony service facility.
  - wash off any liquid that may have contacted your skin.
  - if any liquid gets in your eyes, wash with plenty of water and consult a doctor.

### ■ When not using your camcorder for a long time

- Periodically turn it on and let it run such as by playing back or recording images for about 3 minutes.
- Use up the battery pack completely before storing it.

### LCD screen

- Do not exert excessive pressure on the LCD screen, as it may cause damage.
- If your camcorder is used in a cold place, a residual image may appear on the LCD screen. This is not a malfunction.
- While using your camcorder, the back of the LCD screen may heat up. This is not a malfunction.

### ■ To clean the LCD screen

If fingerprints or dust make the LCD screen dirty, it is recommended you use a soft cloth to clean it. When you use the LCD Cleaning Kit (optional), do not apply the cleaning liquid directly to the LCD screen. Use cleaning paper moistened with the liquid.

### On handling the casing

- If the casing is soiled, clean the camcorder body with a soft cloth lightly moistened with water, and then wipe the casing with a dry soft cloth.
- Avoid the following to avoid damage to the finish:
  - Using chemicals such as thinner, benzene, alcohol, chemical cloths, repellent, insecticide and sunscreen.
  - Handling the camcorder with above substances on your hands.
  - Leaving the casing in contact with rubber or vinyl objects for a long period of time.

## About care and storage of the lens

- Wipe the surface of the lens clean with a soft cloth in the following instances:
  - When there are fingerprints on the lens surface.
  - In hot or humid locations.
  - When the lens is exposed to salty air such as at the seaside.
- Store in a well-ventilated location subject to little dirt or dust.
- To prevent mold, periodically clean the lens as described above. It is recommended that you operate your camcorder about once a month to keep it in optimum state for a long time.

## On charging the pre-installed rechargeable battery

Your camcorder has a pre-installed rechargeable battery to retain the date, time, and other settings even when the POWER switch is set to OFF (CHG). The pre-installed rechargeable battery is always charged while your camcorder is connected to the wall outlet (wall socket) via the AC Adaptor or while the battery pack is attached. The rechargeable battery will be fully discharged in **about 3 months** if you do not use your camcorder at all. Use your camcorder after charging the pre-installed rechargeable battery.

However, even if the pre-installed rechargeable battery is not charged, the camcorder operation will not be affected as long as you are not recording the date.

### ■ Procedures

Connect your camcorder to a wall outlet (wall socket) using the supplied AC Adaptor, and leave it with the POWER switch set to OFF (CHG) for more than 24 hours.

## To change the battery of the Remote Commander (DCR-SR55E/SR65E/SR75E/SR85E)

- ① While pressing on the tab, inset your fingernail into the slit to pull out the battery case.
- ② Place a new battery with the + side facing up.

- ③ Insert the battery case back into the Remote Commander until it clicks.

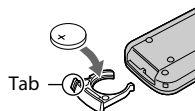

### WARNING

Battery may explode if mistreated. Do not recharge, disassemble or dispose of in fire.

- When the lithium battery becomes weak, the operating distance of the Remote Commander may shorten, or the Remote Commander may not function properly. In this case, replace the battery with a Sony CR2025 lithium battery. Use of another battery may present a risk of fire or explosion.



# Specifications

## System

Video compression format: MPEG2/JPEG (Still images)

Audio compression format: Dolby Digital 2ch  
Dolby Digital Stereo Creator

Video signal: PAL color, CCIR standards

### Hard Disk

DCR-SR35E/SR45E: 30 GB

DCR-SR36E/SR46E/SR55E/SR65E: 40 GB

DCR-SR75E/SR85E: 60 GB

When measuring media capacity, 1GB equals 1 billion bytes, a portion of which is used for data management.

### Recording format

Movie: MPEG2-PS

Still image: Exif\*1 Ver.2.2

### Image device

DCR-SR35E/SR36E/SR45E/SR46E

2.25 mm (1/8 type) CCD (Charge Coupled Device)

Gross: Approx. 800 000 pixels

Effective (Movie, 16:9): Approx. 490 000 pixels

Effective (Still, 16:9): Approx. 310 000 pixels

Effective (Still, 4:3): Approx. 410 000 pixels

DCR-SR55E/SR65E/SR75E/SR85E

3.0 mm (1/6 type) CCD (Charge Coupled Device)

Gross: Approx. 1 070 000 pixels

Effective (Movie, 16:9): Approx. 670 000 pixels

Effective (Still, 16:9): Approx. 750 000 pixels

Effective (Still, 4:3): Approx. 1 000 000 pixels

### Lens

DCR-SR35E/SR36E/SR45E/SR46E

Carl Zeiss Vario-Tessar

Optical: 40 ×, Digital: 80 ×, 2 000 ×

Filter diameter: 30 mm (1 3/16 in.)

DCR-SR55E/SR65E/SR75E/SR85E

Carl Zeiss Vario-Tessar

Optical: 25 ×, Digital: 50 ×, 2 000 ×

Filter diameter: 30 mm (1 3/16 in.)

### Focal length

DCR-SR35E/SR36E/SR45E/SR46E

F=1.8 - 4.1

f=1.9 - 76.0 mm (3/32 - 3 in.)

When converted to a 35 mm still camera

For movies: 41 - 1 640 mm (1 5/8 - 64 5/8 in.) (16:9)\*2

For still images: 48 - 1 920 mm (1 15/16 - 75 5/8 in.) (4:3)

DCR-SR55E/SR65E/SR75E/SR85E

F=1.8 - 3.2

f=2.5 - 62.5 mm (1/8 - 2 1/2 in.)

When converted to a 35 mm still camera

For movies: 41 - 1 189 mm (1 5/8 - 46 7/8 in.) (16:9)\*2

For still images: 36 - 900 mm (1 7/16 - 35 1/2 in.) (4:3)

Color temperature: [AUTO], [ONE PUSH], [INDOOR] (3 200 K), [OUTDOOR] (5 800 K)

### Minimum illumination

DCR-SR35E/SR36E/SR45E/SR46E

6 lx (lux) (when [AUTO SLW SHUTTR] is set to [ON], Shutter speed 1/25 second)

0 lx (lux) (during NightShot plus function)

DCR-SR55E/SR65E/SR75E/SR85E

8 lx (lux) (when [AUTO SLW SHUTTR] is set to [ON], Shutter speed 1/25 second)

0 lx (lux) (during NightShot plus function)

\*1 "Exif" is a file format for still images, established by the JEITA (Japan Electronics and Information Technology Industries Association). Files in this format can have additional information such as your camcorder's setting information at the time of recording.

\*2 The focal length figures are actual figures resulting from wide angle pixel readout.

• Manufactured under license from Dolby Laboratories.

## Input/Output connectors

A/V Remote Connector: Video/audio output jack

USB jack: mini-B

(DCR-SR35E/SR36E/SR55E/SR75E: output only)

## LCD screen

Picture: 6.7 cm (2.7 type, aspect ratio 16:9)

Total number of pixels: 123 200 (560 × 220)

## General

Power requirements: 6.8 V/7.2 V (battery pack)  
8.4 V (AC Adaptor)

Average power consumption: During camera recording with normal brightness.

DCR-SR35E/SR36E/SR45E/SR46E: 2.8 W

DCR-SR55E/SR65E/SR75E/SR85E: 3.0 W

Operating temperature: 0°C to + 40°C (32 °F to 104 °F)

Storage temperature: -20°C to + 60°C (-4 °F to + 140 °F)

Dimensions (Approx.): 76.3 × 76.6 × 112.8 mm (3 × 3 1/8 × 4 1/2 in.)

(w×h×d) including the projecting parts with supplied battery pack attached

Mass (Approx.)

DCR-SR35E/SR36E/SR45E/SR46E

350 g (12 oz) main unit only

400 g (14 oz) including the supplied rechargeable battery pack

DCR-SR55E/SR65E/SR75E/SR85E

360 g (12 oz) main unit only

410 g (14 oz) including the supplied rechargeable battery pack

## Handycam Station DCRA-C200 (DCR-SR55E/SR65E/SR75E/SR85E)

### Input/Output connectors

A/V OUT jack: Video/audio output jack

USB jack: mini-B

(DCR-SR55E/SR75E: output only)

### AC Adaptor AC-L200/L200B

Power requirements: AC 100 V - 240 V, 50/60 Hz

Current consumption: 0.35 - 0.18 A

Power consumption: 18 W

Output voltage: DC 8.4 V\*

Operating temperature: 0°C to + 40°C (32 °F to 104 °F)

Storage temperature: -20°C to + 60°C (-4 °F to + 140 °F)

Dimensions (Approx.): 48 × 29 × 81 mm (1 15/16 × 1 3/16 × 3 1/4 in.) (w×h×d) excluding the projecting parts

Mass (Approx.): 170 g (6.0 oz) excluding the power cord (mains lead)

\* See the label on the AC Adaptor for other specifications.

## Rechargeable battery pack

### NP-FH40

Maximum output voltage: DC 8.4 V

Output voltage: DC 7.2 V

Capacity: 4.9 wh (680 mAh)

Type: Li-ion

Design and specifications are subject to change without notice.

## On trademarks

- “Handycam” and **HANDYCAM** are registered trademarks of Sony Corporation.
- “Memory Stick,”  “Memory Stick Duo,” “**MEMORY STICK DUO**,” “Memory Stick PRO Duo,” “**MEMORY STICK PRO DUO**,” “Memory Stick PRO-HG Duo,” “**MEMORY STICK PRO-HG DUO**,” “Memory Stick Micro,” “MagicGate,” “**MAGICGATE**,” “MagicGate Memory Stick” and “MagicGate Memory Stick Duo” are trademarks or registered trademarks of Sony Corporation.
- “InfoLITHIUM” is a trademark of Sony Corporation.
- Dolby and the double-D symbol are trademarks of Dolby Laboratories.
- Microsoft, Windows, Windows Media, Windows Vista, and DirectX are either registered trademarks or trademarks of Microsoft Corporation in the United States and/or other countries.
- Macintosh and Mac OS are registered trademarks of Apple Inc. in the U.S. and other countries.
- Intel, Intel Core, and Pentium are trademarks or registered trademarks of Intel Corporation or its subsidiaries in the United States and other countries.
- Adobe, the Adobe logo, and Adobe Acrobat are either registered trademarks or trademarks of Adobe Systems Incorporated in the United States and/or other countries.

All other product names mentioned herein may be the trademarks or registered trademarks of their respective companies. Furthermore, <sup>TM</sup> and “®” are not mentioned in each case in this manual.

Additional information on this product and answers to frequently asked questions can be found at our Customer Support Website.

<http://www.sony.net/>



Printed on 70% or more recycled paper.

Printed in China



4 109555 110