

# SONY®

## Handycam Handbook DCR-SR37E/SR38E/SR47E/SR48E/SR57E/ SR67E/SR77E/SR87E



Table of Contents

Useful Recording Techniques

Index

# HANDYCAM®

# Using the Handycam Handbook

You will find information on using your camcorder to its fullest in this Handycam Handbook. Read the Handycam Handbook in addition to the Operating Guide (a separate volume). Information on using your camcorder connected to a computer will be found in the Operating Guide and the PMB Guide that is the Help of the supplied “PMB (Picture Motion Browser)” software.

## Searching for information quickly

Click an item on the right edge of each page, and you will jump to the page for that item.

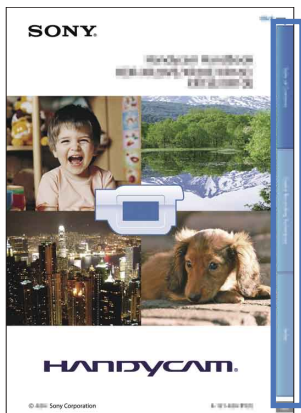

← Click here.

- You can search for an item by keyword using Adobe Reader. Refer to the Help of Adobe Reader for tips on how to use Adobe Reader.
- You can print out the Handycam Handbook.

## About this Handycam Handbook

- The example images used in this Handycam Handbook for illustration purposes are captured using a digital still camera, and therefore may appear different from images and screen indicators that actually appear on your camcorder.
- The DCR-SR87E is used for illustrations in this book, unless otherwise mentioned.
- In this Handycam Handbook, the internal hard disk of your camcorder and “Memory Stick PRO Duo” media are called “recording media.”
- “Memory Stick PRO Duo” media and “Memory Stick PRO-HG Duo” media are both referred to as “Memory Stick PRO Duo” media in this manual.
- Design and specifications of your camcorder and accessories are subject to change without notice.

# Table of contents

Using the Handycam Handbook .....	2
Searching for information quickly .....	2
Useful recording techniques .....	6
Parts and controls .....	7
Screen indicators .....	8
“ <b>HOME</b> ” and “ <b>OPTION</b> ” - Taking advantage of two types of menus .....	10
Using the <b>HOME</b> MENU .....	10
Using the <b>OPTION</b> MENU .....	10
Menu lists .....	11
List of the <b>HOME</b> MENU .....	11
List of the <b>OPTION</b> MENU .....	12
Read this before operating your camcorder .....	13
Notes on using the Hard Disk Drive Handycam .....	14

## Getting started

Step 1: Charging the battery pack .....	16
Step 2: Turning the power on, and setting the date and time .....	19
Changing the language setting .....	20

## Recording/Playback

Five pieces of advice for successful recording .....	21
Recording and playing movies and photos easily ( <b>EASY</b> Easy Handycam Operation) .....	22
Recording movies .....	22
Shooting photos .....	23
Playing movies .....	25
Viewing photos .....	26
Recording .....	28
Recording movies .....	28
Shooting photos .....	30
Useful functions for recording movies and photos .....	32
Zooming .....	32
Recording sound with more presence (5.1ch surround recording) (DCR-SR57E/SR67E/SR77E/SR87E) .....	33
Adjusting the exposure for backlit subjects .....	33
Recording in mirror mode .....	34
Switching the screen display .....	34
Playback on the camcorder .....	35
Playing movies .....	35

Viewing photos .....	36
Useful functions for playing movies and photos .....	38
Searching for desired scene by pinpoint (Film Roll Index) .....	38
Searching for desired scene by face (Face Index) .....	38
Searching for desired images by date (Date Index) .....	39
Using PB zoom with photos .....	40
Playing back a series of photos (Slide show) .....	41
Playing images on a TV .....	42

## Editing

Deleting movies and photos .....	44
Capturing a photo from a movie .....	46
Dubbing/copying movies and photos from the internal hard disk to "Memory Stick PRO Duo" media .....	47
Dubbing movies .....	47
Copying photos .....	48
Protecting recorded movies and photos (Protect) .....	49
Dividing a movie .....	50
Using the Playlist of movies .....	51
Creating the Playlist .....	51
Playing the Playlist .....	52
Creating a disc with a DVD writer, recorder .....	53
Creating a disc with the dedicated DVD writer, DVDirect Express .....	53
Creating a disc with a DVD writer, etc., other than DVDirect Express .....	55
Creating a disc with a recorder, etc. ....	56
Checking the battery information .....	58

## Utilizing recording media

Changing the recording media .....	59
Selecting the recording media .....	59
Selecting the recording media for photos .....	59
Inserting "Memory Stick PRO Duo" media .....	59
Checking the media information .....	61
Deleting all movies and photos (Formatting) .....	62
Preventing data on the internal hard disk from being recovered .....	63

## Customizing your camcorder

MOVIE SETTINGS (Items for recording movies) .....	64
PHOTO SETTINGS (Items for recording photos) .....	68
VIEW IMAGES SET (Items to customize the display) .....	70
SOUND/DISP SET (Items to adjust the sound and the screen) .....	72
OUTPUT SETTINGS (Items for when connected to a TV) .....	74
CLOCK/  LANG (Items to set clock and language) .....	75

GENERAL SET (Other setup items) .....	76
Functions set in the  OPTION MENU .....	78

## Troubleshooting

 Troubleshooting .....	85
Self-diagnosis display/Warning indicators .....	89

## Additional information

Recording time of movies/number of recordable photos .....	93
Expected time of recording and playback with each battery pack .....	93
Expected recording time of movies .....	94
Expected number of recordable photos .....	95
Using your camcorder abroad .....	96
File/folder structure on the internal hard disk and "Memory Stick PRO Duo" media .....	98
Maintenance and precautions .....	99
About the "Memory Stick" media .....	99
About the "InfolITHIUM" battery pack .....	100
About handling of your camcorder .....	101
Index .....	105

# Useful recording techniques

## Checking your golf swing



▶ SPORTS .....	81
----------------	----

## Getting a good shot of a ski slope or beach



▶ Backlight .....	33
▶ BEACH .....	81
▶ SNOW .....	81

## Flowers in close-up



▶ PORTRAIT .....	81
▶ FOCUS .....	80
▶ TELE MACRO .....	79

## A child on the stage under a spot light



▶ SPOTLIGHT .....	81
-------------------	----

## Focusing on the dog on the left side of the screen

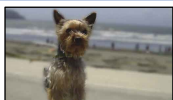

▶ FOCUS .....	80
▶ SPOT FOCUS .....	79
▶ SPOT MTR/FCS .....	78

## Fireworks with all its splendor



▶ FIREWORKS .....	81
▶ FOCUS .....	80

# Parts and controls

Figures in ( ) are reference pages.

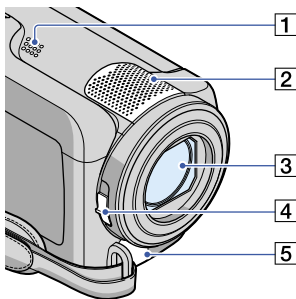

- 1 Speaker
- 2 Built-in microphone (33)
- 3 Lens (Carl Zeiss lens) (15)
- 4 LENS COVER switch (22, 23, 28, 30)
- 5 A/V Remote Connector (42, 56)

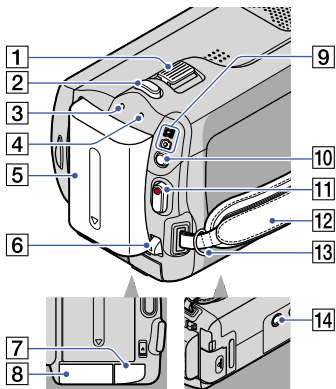

- 1 Power zoom lever (32, 40)
- 2 PHOTO button (24, 30)
- 3 CHG (charge) lamp (16)
- 4 ACCESS lamp (Hard disk) (16)

While the lamp is lit or flashing, the

camcorder is reading or writing data.

- 5 Battery pack (16)
- 6 BATT (battery) release lever (17)
- 7 DC IN jack (16)
- 8 "Memory Stick Duo" media slot (60)
- 9 (Movie)/Photo lamps (19)
- 10 MODE button (24, 30)
- 11 START/STOP button (23, 29)
- 12 Grip belt (22, 28)
- 13 Hook for a shoulder belt
- 14 Tripod receptacle

Attach a tripod (sold separately) to the tripod receptacle using a tripod screw (sold separately: the length of the screw must be less than 5.5 mm (7/32 in.)).

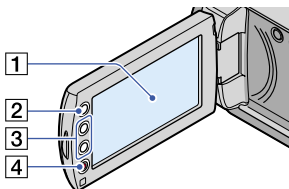

- 1 LCD screen/Touch panel (10, 34)  
If you rotate the LCD panel 180 degrees, you can close the LCD panel with the LCD screen facing out. This is convenient during playback operations.
- 2 (HOME) button\* (10)
- 3 Zoom buttons\* (32, 40)
- 4 START/STOP button\* (23, 29)  
\* DCR-SR38E/SR48E/SR57E/SR67E/SR77E/SR87E

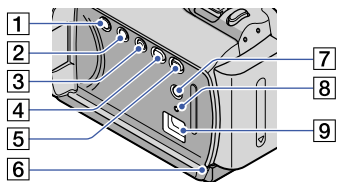

- 1 POWER button (19)
- 2 DISP (display) button (34)
- 3 EASY button (23)
- 4 (DISC BURN) button (see Operating Guide)
- 5 (VIEW IMAGES) button (25, 35)
- 6 Access lamp ("Memory Stick PRO Duo" media) (60)  
While the lamp is lit or flashing, the camcorder is reading or writing data.
- 7 (Back light) button (33)
- 8 RESET button  
Press RESET to initialize all the settings including the clock setting.
- 9 (USB) jack (55)  
DCR-SR37E/SR38E/SR57E/SR77E: Output only

## Screen indicators

Upper left                      Center                      Upper right

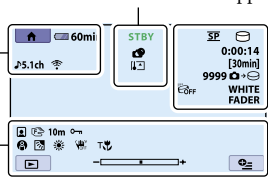

Bottom

Upper left

Indicator	Meaning
	HOME button (10)
	AUDIO MODE* (64)
	Self-timer recording (84)
	BLT-IN ZOOM MIC (83)
	MICREF LEVEL low (84)
	WIDE SELECT (65)
	Remaining battery
	Return button (10)

Center

Indicator	Meaning
	Recording status (23, 29)
	Photo size (68)
	Slide show set (41)
	Warning (89)
	Playback mode (26, 36)









Upper right

Indicator	Meaning
	Recording mode (HQ/SP/LP) (64)
	Recording/playback/editing media (59)
	Counter (hour:minute:second) (22, 28, 35)
	Estimated recording remaining time (22, 28)
	FADER (83)
	Drop sensor off (77)
	Drop sensor activated (77)
	Approximate number of recordable photos and recording media (24, 30)
	Playback folder (37)
	Current playing movie or photo/Number of total recorded movies or photos (25, 26, 35, 36)

Bottom

Indicator	Meaning
	Face Index (38)
	Manual focus (80)
	SCENE SELECTION (81)
	White balance (82)
	SteadyShot off (66)
	SPOT MTR/FCS (78)/EXPOSURE (80)/SPOT METER (78)
	TELE MACRO (79)



Indicator	Meaning
	Back light (33)
	OPTION button (10)
	VIEW IMAGES button (25, 35)
	Slide show button (41)
 101-0001	Data file name (26, 36)
 101-0005	
	Protected image (49)
	VISUAL INDEX button (26, 36)

\* DCR-SR57E/SR67E/SR77E/SR87E

- Indicators and their positions are approximate and may differ from what you actually see.
- Some items may not appear, depending on your camcorder model.

# “HOME” and “OPTION” - Taking advantage of two types of menus

## Using the HOME MENU

When you press **HOME** (HOME), the HOME MENU appears. You can change the settings of your camcorder, etc.

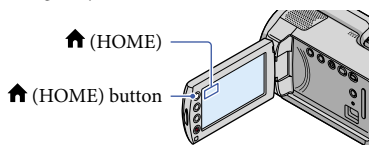

- 1 Touch the desired category → the menu item to be changed.

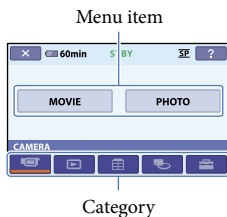

- 2 Follow the instructions on the screen.

- 3 After completing the setting, touch **OK**.

- When the item is not on the screen, touch **▲**/**▼**.
- To return to the previous screen, touch **◀**.
- To hide the HOME MENU screen, touch **X**.
- You cannot select the grayed items or settings.

## Using the HELP function

To see the descriptions on the HOME MENU, touch **?** (HELP) on the HOME MENU screen. (The bottom of **?** turns orange.) Then, touch the item you want to know about.

## Using the OPTION MENU

The **OPTION** MENU appears just like the pop-up window that appears when you right-click the mouse on a computer. The menu items you can change in the context appear.

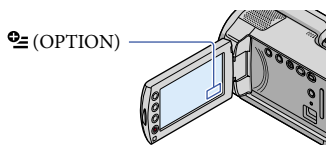

- 1 Touch the desired tab → the item to change the setting.

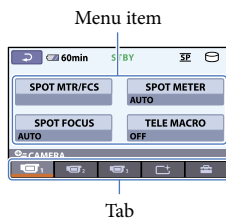

- 2 After completing the setting, touch **OK**.

## Notes

- When the item you want is not on the screen, touch another tab. (There may be no tab.)
- You cannot use the OPTION MENU during Easy Handycam operation.
- The tabs and items that appear on the screen depend on the recording/playback status of your camcorder at the time.

# Menu lists

## List of the HOME MENU



### (CAMERA) category

MOVIE* <sup>1</sup>	p. 28
PHOTO* <sup>1</sup>	p. 30



### (VIEW IMAGES) category

VISUAL INDEX* <sup>1</sup>	p. 36
FILM ROLL* <sup>1</sup>	p. 38
FACE* <sup>1</sup>	p. 38
PLAYLIST	p. 52



### (OTHERS) category

DELETE* <sup>1</sup>	
DELETE	p. 44
DELETE	p. 44
PHOTO CAPTURE	p. 46
MOVIE DUB	
DUB by select	p. 47
DUB by date	p. 47
DUB ALL	p. 47
PHOTO COPY	
COPY by select	p. 48
COPY by date	p. 48
EDIT	
DELETE	p. 44
DELETE	p. 44
PROTECT	p. 49
PROTECT	p. 49
DIVIDE	p. 50
PLAYLIST EDIT	
ADD	p. 51
ADD by date	p. 51
ERASE	p. 52
ERASE ALL	p. 52
MOVE	p. 52
USB CONNECT	
USB CONNECT	p. 55
USB CONNECT	p. 55
DISC BURN	Operating Guide
BATTERY INFO	p. 58



### (MANAGE MEDIA) category

MOVIE MEDIA SET* <sup>1</sup>	p. 59
PHOTO MEDIA SET* <sup>1</sup>	p. 59
MEDIA INFO	p. 61
MEDIA FORMAT* <sup>1</sup>	p. 62
REPAIR IMG.DB F.	p. 88



### (SETTINGS) category

MOVIE SETTINGS	
REC MODE	p. 64
AUDIO MODE* <sup>2</sup>	p. 64
WIDE SELECT	p. 65
DIGITAL ZOOM	p. 65
STEADYSHOT	p. 66
AUTO SLW SHUTTR	p. 66
GUIDEFAME	p. 66
REMAINING SET	p. 67
FACE SET* <sup>1</sup>	p. 67
PHOTO SETTINGS	
IMAGE SIZE* <sup>1</sup>	p. 68
FILE NO.	p. 68
AUTO SLW SHUTTR	p. 69
GUIDEFAME	p. 69
VIEW IMAGES SET	
DATA CODE	p. 70
SOUND/DISP SET	
VOLUME* <sup>1</sup>	p. 26, 36
BEEP* <sup>1</sup>	p. 72
LCD BRIGHT	p. 72
LCD BL LEVEL	p. 72
LCD COLOR	p. 73
OUTPUT SETTINGS	
TV TYPE	p. 74
DISP OUTPUT	p. 74
CLOCK/ LANG	
CLOCK SET* <sup>1</sup>	p. 19
AREA SET	p. 75
SUMMERTIME	p. 75
LANGUAGE SET* <sup>1</sup>	p. 75
GENERAL SET	
DEMO MODE	p. 76
CALIBRATION	p. 102
A.SHUT OFF	p. 76
POWER ON BY LCD	p. 77
DROP SENSOR	p. 77

- [SOUND/DISP SET] is changed to [SOUND SETTINGS] during Easy Handycam operation.

\*1 You can set this item during Easy Handycam operation.

\*2 DCR-SR57E/SR67E/SR77E/SR87E

## List of the OPTION MENU

Following items are available on the OPTION MENU only.

### tab

SPOT MTR/FCS	p. 78
SPOT METER	p. 78
SPOT FOCUS	p. 79
TELE MACRO	p. 79
EXPOSURE	p. 80
FOCUS	p. 80
SCENE SELECTION	p. 81
WHITE BAL.	p. 82

### tab

FADER	p. 83
-------	-------

### tab

BLT-IN ZOOM MIC	p. 83
MICREF LEVEL	p. 84
SELF-TIMER	p. 84

### The tab depends on the situation/no tab

SLIDE SHOW	p. 41
SLIDE SHOW SET	p. 41

# Read this before operating your camcorder

## Supplied items

The numbers in ( ) are the supplied quantity.

- AC Adaptor (1)
- Power cord (Mains lead) (1)
- A/V connecting cable (1) **A**
- USB cable (1) **B**
- Rechargeable battery pack
  - Only for DCR-SR37E/SR38E/SR47E/SR48E/SR57E/SR67E: NP-FH30 (1)
  - Only for DCR-SR77E/SR87E: NP-FH50 (1)
- CD-ROM “Handycam Application Software” (1)
  - “PMB (Picture Motion Browser)” including “PMB Guide”
  - “Handycam Handbook” (PDF)
- “Operating Guide” (1)

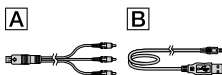

- See page 59 for the “Memory Stick” media you can use with this camcorder.

## Using the camcorder



- Do not hold the camcorder by the following parts, and also do not hold the camcorder by the jack covers.

### LCD screen

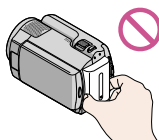

### Battery pack



- The camcorder is not dustproofed, dripproofed or waterproofed. See “About handling of your camcorder” (p. 101).
- Do not do any of the following when the  (Movie) or  (Photo) mode lamps (p. 19) or the ACCESS/access lamps (p. 16, 60) are lit or flashing. Otherwise, the recording media may be damaged, recorded images may be lost or other malfunctions could occur.
  - Ejecting the “Memory Stick PRO Duo” media from the camcorder
  - Removing the battery pack or AC Adaptor from the camcorder
  - Applying mechanical shock or vibration to the camcorder
- When connecting your camcorder to another device with a cable, be sure to insert the connector plug in the correct way. Pushing the plug forcibly into the terminal will damage the terminal and may result in a malfunction of your camcorder.
- Disconnect the AC Adaptor from the camcorder, holding both the camcorder and the DC plug.

## Menu items, LCD panel, and lens

- A menu item that is grayed out is not available under the current recording or playback conditions.
- The LCD screen is manufactured using extremely high-precision technology, so over 99.99% of the pixels are operational for effective use. However, there may be some tiny black points and/or bright points (white, red, blue, or green in color) that appear constantly on the LCD screen. These points are normal results of the manufacturing process and do not affect the recording in any way.

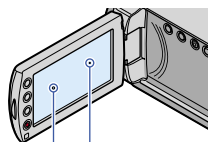

Black points

White, red, blue or green points

- Exposing the LCD screen, or the lens to direct sunlight for long periods of time may cause malfunctions.
- Do not aim at the sun. Doing so might cause your camcorder to malfunction. Take images of the sun only in low light conditions, such as at dusk.

### About changing the language setting

- The on-screen displays in each local language are used for illustrating the operating procedures. Change the screen language before using your camcorder if necessary (p. 75).

### Recording

- Before starting to record, test the recording function to make sure that the image and sound are recorded without any problems.
- Compensation for the contents of recordings cannot be provided, even if recording or playback is not possible due to a malfunction of the camcorder, storage media, etc.
- TV color systems differ depending on the country/region. To view your recordings on a TV, you need a PAL system-based TV.
- Television programs, films, video tapes, and other materials may be copyrighted. Unauthorized recording of such materials may be contrary to the copyright laws.

### Notes on using the Hard Disk Drive Handycam

#### Save all your recorded image data

- To prevent your image data from being lost, save all your recorded images on external media periodically. It is recommended that you save the image data on a disc such as a DVD-R using your computer (see Operating Guide). Also, you can save your image data using a DVD writer, a VCR, or a DVD/HDD recorder (p. 53).

### Do not apply shock or vibration to your camcorder

- The hard disk of the camcorder may not be recognized, or recording or playback may not be possible.
- Especially, during recording/playback, do not apply shock. After recording, do not apply vibration or shock to the camcorder, while the ACCESS lamp is lit.
- When using a shoulder belt (sold separately), do not crash the camcorder against an object.
- Do not use your camcorder in very loud areas.

### On the drop sensor

- To protect the internal hard disk from shock by dropping, the camcorder has a drop sensor function (p. 77). When a drop occurs, or under a non-gravity condition, the block noise made when this function is activated by the camcorder may also be recorded. If the drop sensor catches a drop repeatedly, recording/playback may be stopped.

### Notes on battery pack/AC Adaptor

- Be sure to remove the battery pack or the AC Adaptor after turning off the camcorder.

### Note on operating temperatures

- When the temperature of the camcorder becomes extremely high or extremely low, you may not be able to record or play back on the camcorder, due to the protection features of the camcorder being activated in such situations. In this case, an indicator appears on the LCD screen (p. 89).



### When the camcorder is connected to a computer

- Do not try to format the hard disk or music file storage area of the camcorder using a computer. If you do so, your camcorder may not operate correctly.

### Note on using the camcorder at high altitudes

- Do not turn on the camcorder in a low-pressure area, where the altitude is more than 5,000 meters (16,000 feet). Doing so may damage the hard disk drive of your camcorder.

## Note on disposal/transfer

- Even if you perform [  DELETE ALL ], [  DELETE ALL ] or [ MEDIA FORMAT ], some data might not be entirely deleted from the hard disk. When you transfer the camcorder, it is recommended that you perform [  EMPTY ] (p. 63) to prevent the recovery of your data. Also, when you dispose of the camcorder, it is recommended that you destroy the actual body of the camcorder.

## If you cannot record/play back images, perform [ MEDIA FORMAT ]

- If you repeat recording/deleting images for a long time, fragmentation of data occurs on the recording media. Images cannot be saved or recorded. In such a case, save your images on some type of external media first (p. 53, see Operating Guide too), and then perform [ MEDIA FORMAT ] (p. 62).

## Carl Zeiss lens

Your camcorder is equipped with a Carl Zeiss lens, which was developed jointly by Carl Zeiss, in Germany, and Sony Corporation, and produces superior images. It adopts the MTF measurement system for video cameras and offers a quality typical of a Carl Zeiss lens.

MTF= Modulation Transfer Function. The number value indicates the amount of light from a subject coming into the lens.

## Step 1: Charging the battery pack

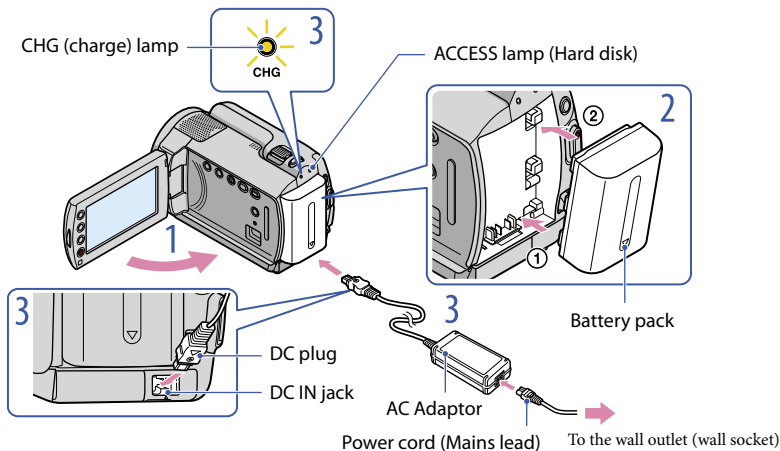

You can charge the “InfoLITHIUM” battery pack (H series) after attaching it to your camcorder.

- You cannot attach any “InfoLITHIUM” battery pack other than the H series to your camcorder.

- 1 Turn off your camcorder by closing the LCD screen.
- 2 Attach the battery pack by sliding it in the direction of the arrow until it clicks.
- 3 Connect the AC Adaptor and the power cord (mains lead) to your camcorder and the wall outlet (wall socket).
  - Be sure that the ▲ mark on the DC plug is facing down.

The CHG (charge) lamp lights up and charging starts. The CHG (charge) lamp turns off when the battery pack is fully charged.
- 4 When the battery is charged, disconnect the AC Adaptor from the DC IN jack of your camcorder.

- See page 93 on recording and playing time.
- When your camcorder is on, you can check the approximate amount of remaining battery power with the remaining battery indicator at the upper left on the LCD screen.



## Charging time

Approximate time (min.) required when you fully charge a fully discharged battery pack.

DCR-SR37E/SR38E/SR47E/SR48E/SR57E/SR67E

Battery pack	Charging time
NP-FH30 (supplied)	115
NP-FH50	135
NP-FH70	170
NP-FH100	390

DCR-SR77E/SR87E

Battery pack	Charging time
NP-FH50 (supplied)	135
NP-FH70	170
NP-FH100	390

- When the battery pack is charged at 25 °C (77 °F) (10 °C to 30 °C (50 °F to 86 °F) is recommended)

## To remove the battery pack

Close the LCD screen. Slide the BATT (battery) release lever ① and remove the battery pack ②.

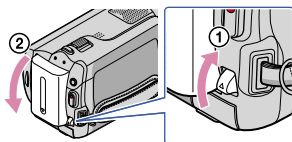

## To use a wall outlet (wall socket) as a power source



Make the same connections as “Step 1: Charging the battery pack.” Even if the battery pack is attached, the battery pack is not discharged.

## Charging the battery pack abroad

You can charge the battery pack in any countries/regions using the AC Adaptor supplied with your camcorder within the AC 100 V - 240 V, 50 Hz/60 Hz range.

- Do not use an electronic voltage transformer.

## Notes on the battery pack

- When you remove the battery pack or disconnect the AC Adaptor, close the LCD screen and make sure that the  (Movie) lamp/ (Photo) lamp (p. 19)/ACCESS lamp (p. 16)/access lamp (p. 60) are turned off.
- The CHG (charge) lamp flashes during charging under the following conditions:
  - The battery pack is not attached correctly.
  - The battery pack is damaged.
- In the default setting, the power turns off automatically if you leave your camcorder without any operation for about 5 minutes, to save battery power ([A.SHUT OFF]).

## Notes on the AC Adaptor

- Use the nearby wall outlet (wall socket) when using the AC Adaptor. Disconnect the AC Adaptor from the wall outlet (wall socket) immediately if any malfunction occurs while using your camcorder.
- Do not use the AC Adaptor placed in a narrow space, such as between a wall and furniture.
- Do not short-circuit the DC plug of the AC Adaptor or battery terminal with any metallic objects. This may cause a malfunction.

## Step 2: Turning the power on, and setting the date and time

### 1 Open the LCD screen of your camcorder.

Your camcorder is turned on.

- To turn on your camcorder when the LCD screen is open, press POWER.

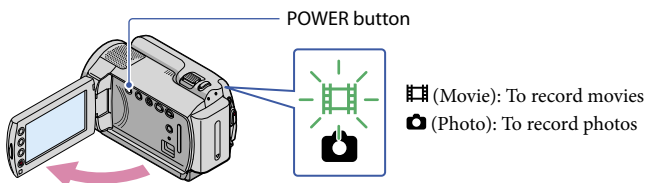

### 2 Select the desired geographical area with / , then touch [NEXT].

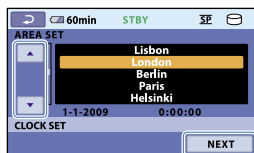
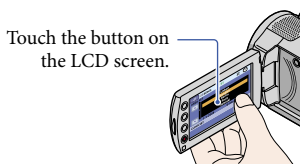

- To set the date and time again, touch (HOME) → (SETTINGS) → [CLOCK/ LANG] → [CLOCK SET]. When an item is not on the screen, touch / until the item appears.

### 3 Set [SUMMERTIME], date and time, then touch [OK].

The clock starts.

- If you set [SUMMERTIME] to [ON], the clock advances 1 hour.

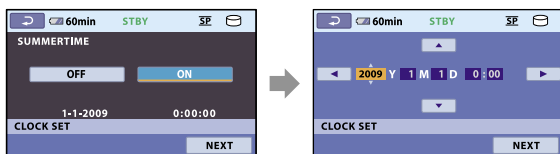

- The date and time does not appear during recording, but they are automatically recorded on the recording media, and can be displayed during playback. To display the date and time, touch (HOME) → (SETTINGS) → [VIEW IMAGES SET] → [DATA CODE] → [DATE/TIME] → [OK] → → [X].
- You can turn off the operation beeps by touching (HOME) → (SETTINGS) → [SOUND/DISP SET] → [BEEP] → [OFF] → [OK] → → [X].

- If the button you touch does not react correctly, calibrate the touch panel (p. 102).

## To turn off the power



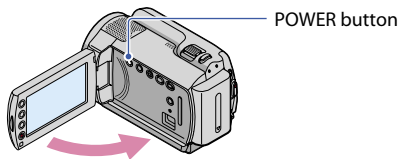



Close the LCD screen. The  (Movie) lamp flashes for a few seconds and the power is turned off.



- You can turn off your camcorder also by pressing POWER.
- When [POWER ON BY LCD] (p. 77) is set to [OFF], turn off your camcorder by pressing POWER.

## Changing the language setting

You can change the on-screen displays to show messages in a specified language.

Touch  (HOME) →  (SETTINGS) → [CLOCK/LANG] → [LANGUAGE SET] → a desired language →  →  → .



## Five pieces of advice for successful recording



### ★ Stabilizing your camcorder

When you hold the camcorder, keep your upper body upright, and hold your arms close to your body. The SteadyShot function is effective against camera-shake, however, it is essential that you not move the camcorder.

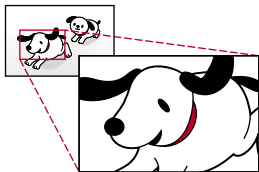

### ★ Zooming smoothly

Zoom in and out slowly and smoothly. And, use zooming sparingly. Excessive zooming will make movies that may make the viewer feel tired when viewing them.

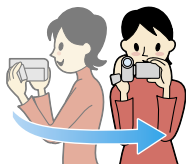

### ★ Evoking a feeling of spaciousness

Use the panning technique. Stabilize yourself, move your camcorder horizontally as you turn your upper body slowly. Stay still at the end of panning for a while to make the scene look stable.

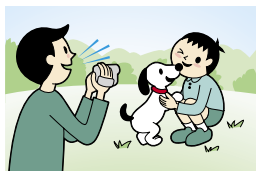

### ★ Accentuating movies with narration

Consider the sound to be recorded with your movies. Narrate the subject, or talk to the subject during shooting. Aim for a balanced volume of voices, since the recording person is closer to the microphone than the recorded person.



### ★ Using accessories

Make good use of camcorder accessories. For example, using a tripod, you can make a time-lapse recording or record subjects in dim light, such as scenes of fireworks, or night views. By always carrying spare batteries, you can continue recording without worrying about battery power shortages.

# Recording and playing movies and photos easily (**EASY** Easy Handycam Operation)

Simply press EASY. You can record or play movies and photos easily (Easy Handycam operation).

During Easy Handycam operation, you can set basic options, such as changing the image size or deleting images, among the setting and adjustment items. Other items are set automatically.

- When Easy Handycam operation is started, nearly all menu settings are reset to the default settings automatically. (Some menu items retain the settings that were made before Easy Handycam operation.)

## Recording movies

In the default setting, movies are recorded on the hard disk (p. 59).

- 1** Fasten the grip belt.

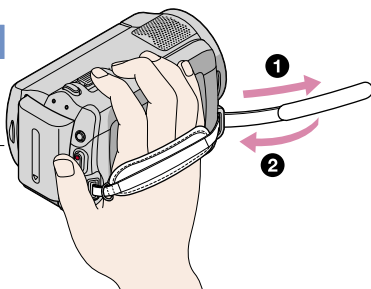

- 2** Open the lens cover.

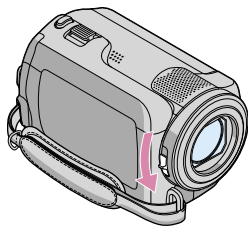

- 3** Open the LCD screen of your camcorder.

Your camcorder is turned on.

- To turn on your camcorder when the LCD screen is already open, press POWER (p. 19).

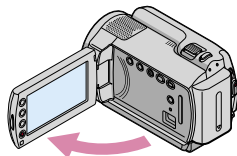

#### 4 Press EASY.

**EASY** appears on the LCD screen.

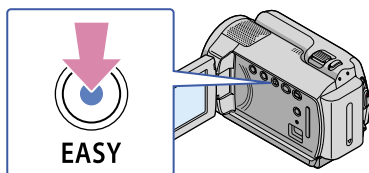

#### 5 Press START/STOP to start recording.

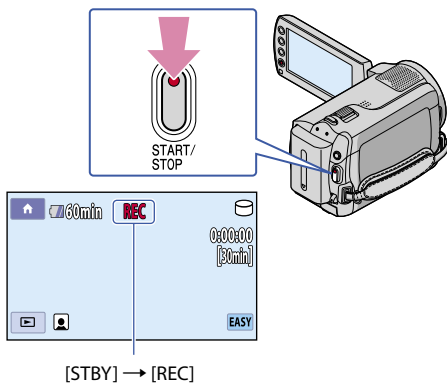

To stop recording, press START/STOP again.

#### Tips

- The [REC MODE] is fixed to [SP] (p. 64).

## Shooting photos

#### 1 Open the lens cover.

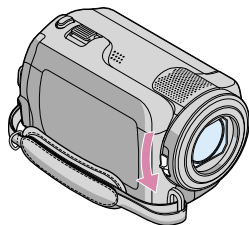

## 2 Open the LCD screen of your camcorder.

Your camcorder is turned on.

- To turn on your camcorder when the LCD screen is already open, press POWER (p. 19).

## 3 Press EASY.

**EASY** appears on the LCD screen.

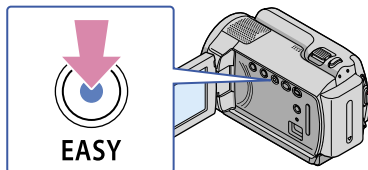

## 4 Press MODE to turn on the (Photo) lamp.

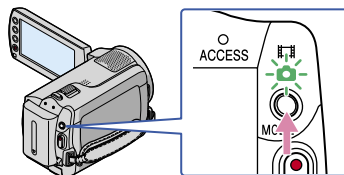

## 5 Press PHOTO lightly to adjust the focus, then press it fully.

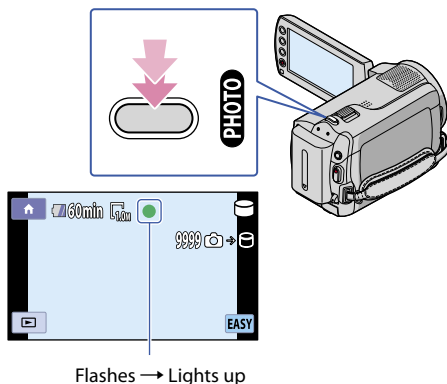

Flashes → Lights up

When  disappears, the photo is recorded on the internal hard disk.



### 1 Open the LCD screen of your camcorder.

Your camcorder is turned on.

- To turn on your camcorder when the LCD screen is already open, press POWER (p. 19).

### 2 Press (VIEW IMAGES).

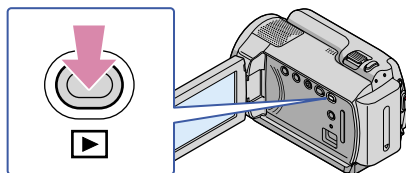

The VISUAL INDEX screen appears after some seconds.

### 3 Touch the (Movie) tab (①) → a desired movie (②).

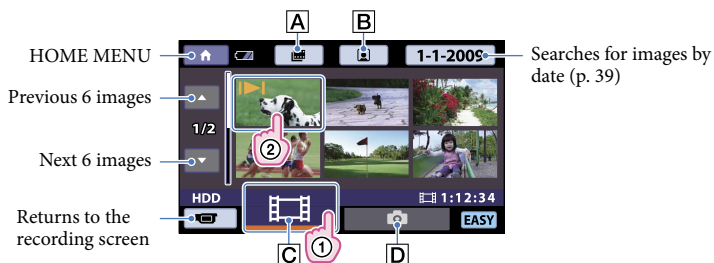



**A**  : Displays the Film Roll Index screen (p. 38).

**B**  : Displays the Face Index screen (p. 38).

**C**  : Displays movies.

**D**  : Displays photos.

-  appears with the movie or photo that was most recently played or recorded. If you touch the movie or photo with , you can continue playback from the previous time. ( appears on the photo recorded on “Memory Stick PRO Duo” media.)

Your camcorder starts playing the selected movie.

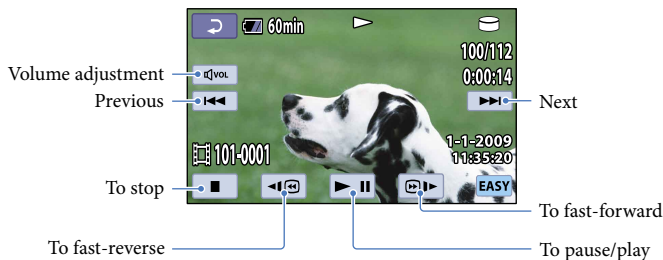

### Tips

- When playback from the selected movie reaches the last movie, the screen returns to the VISUAL INDEX screen.
- You can slow down the playback speed by touching [◀|@|▶] during pause.
- You can adjust the volume by touching [VOL] → adjust with [◀] / [▶] during playback.
- The setting of [DATA CODE] is fixed to [DATE/TIME] (p. 70).
- To change the recording media, select the recording media on [MOVIE MEDIA SET] (p. 59).

## Viewing photos

On the VISUAL INDEX screen, touch the (Photo) tab (①) → a desired photo (②).

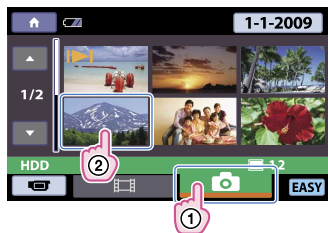

Your camcorder starts playing the selected photo.

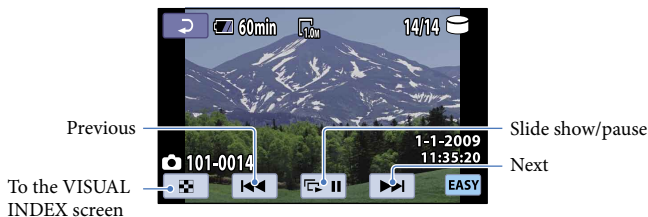

### Tips

- The setting of [DATA CODE] is fixed to [DATE/TIME] (p. 70).
- To change the recording media, select the recording media on [PHOTO MEDIA SET] (p. 59).

### To cancel Easy Handycam operation

After you finish recording, or close menu setting screen, press EASY again. **EASY** disappears from the LCD screen.

### Menu settings during Easy Handycam operation

Press  (HOME) to display the menu items available for setup changes. See “Menu lists” (p. 11) on the available menu items.

### Notes

- You cannot use the  OPTION MENU.
- Cancel Easy Handycam operation if you want to add effects to images or change settings.

### Invalid buttons during Easy Handycam operation

You cannot use some buttons/functions during Easy Handycam operation since they are automatically set. If you set an invalid operation, [Invalid during Easy Handycam operation.] may appear.

# Recording

## Recording movies

In the default setting, movies are recorded on the internal hard disk (p. 59).

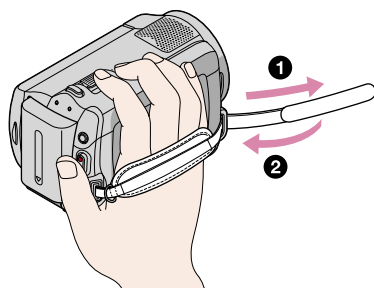

- 1 Fasten the grip belt.

- 2 Open the lens cover.

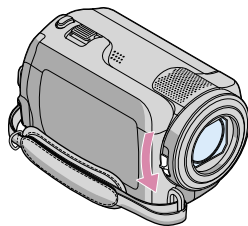

- 3 Open the LCD screen of your camcorder.

Your camcorder is turned on.

- To turn on your camcorder when the LCD screen is already open, press POWER (p. 19).

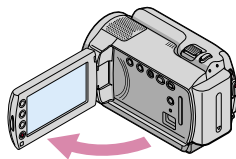

#### 4 Press START/STOP to start recording.

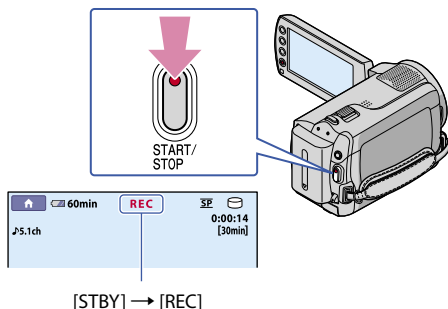

To stop recording, press START/STOP again.

- See page 94 on the recordable time of movies.
- The maximum continuous recordable time of movies is about 13 hours.
- When a movie file exceeds 2 GB, the next movie file is created automatically.
- You can change the recording media and recording mode (p. 59, 64).
- [STEADYSHOT] is set to [ON] in the default setting.
- It will take several seconds until you can start recording after you turn on the camcorder. You cannot operate your camcorder during this time.
- If you close the LCD screen while recording movies, the camcorder stops recording.
- If the ACCESS/access lamp is lit or flashing after recording is finished, it means that data is still being written onto the recording media. Do not apply shock or vibration to your camcorder, and do not remove the battery or AC Adaptor.
- You can check the recordable time and the remaining capacity, etc., by touching **HOME** → **MANAGE MEDIA** → [MEDIA INFO] (p. 61).
- To adjust the angle of the LCD panel, first open the LCD panel 90 degrees to the camcorder ①, and then adjust the angle ②. If you rotate the LCD panel 180 degrees to the lens side ②, you can record movies/photos in mirror mode.

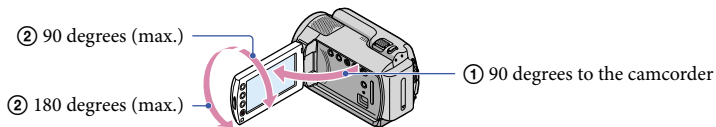

- When you open or close the LCD screen, or adjust the angle, be careful not to press the buttons on the side of the LCD screen by mistake (DCR-SR38E/SR48E/SR57E/SR67E/SR77E/SR87E).

#### Tips

- When a face is detected during movie recording, **FACE** flashes and the detected face is stored in the index. You can search for a desired scene by a face image when playing back ([Face Index], p. 38).
- You can capture photos from recorded movies (p. 46).
- You can switch the shooting mode by touching **HOME** → **CAMERA** → [MOVIE].

## Data code during recording

The recording date, time and condition are recorded automatically on the recording media. They are not displayed during recording. However, you can check them as [DATA CODE] during playback (p. 70).

## Shooting photos

In the default setting, photos are recorded on the internal hard disk (p. 59).

### 1 Open the lens cover.

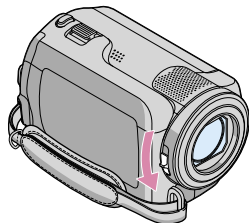

### 2 Open the LCD screen of your camcorder.

Your camcorder is turned on.

- To turn on your camcorder when the LCD screen is already open, press POWER (p. 19).

### 3 Press MODE to turn on the 📷 (Photo) lamp.

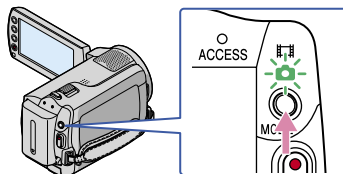

- 
- 4 Press PHOTO lightly to adjust the focus, then press it fully.

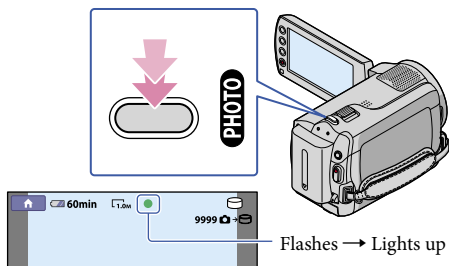

When ■■■■■ disappears, the photo is recorded.

---

- See page 95 on the recordable number of photos.
- To change the image size, touch **HOME** → **SETTINGS** → [PHOTO SETTINGS] → [IMAGE SIZE] → a desired setting → **OK** → **OK** → **X** (p. 68).
- You cannot record photos while  is displayed.

# Useful functions for recording movies and photos

## Zooming

You can magnify images with the power zoom lever.

You can also magnify images with the zoom buttons on the LCD frame (DCR-SR38E/SR48E/SR57E/SR67E/SR77E/SR87E).

The magnifying level of your camcorder is as follows:

DCR-SR37E/SR38E/SR47E/SR48E/SR57E/SR67E: 60 times the original size

DCR-SR77E/SR87E: 25 times the original size

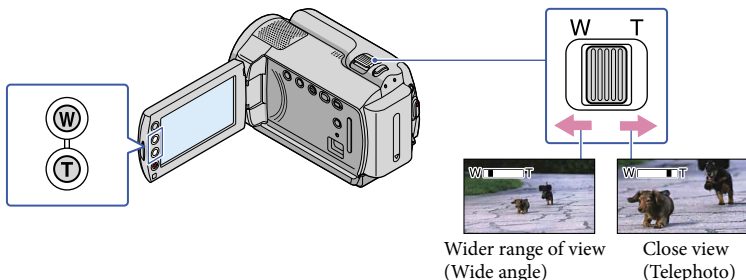

Move the power zoom lever slightly for a slower zoom. Move it further for a faster zoom.

### ⚡ Notes

- SteadyShot may not reduce image blurring as desired when the power zoom lever is set to the T (Telephoto) side.
- Be sure to keep your finger on the power zoom lever. If you move your finger off the power zoom lever, the operation sound of the power zoom lever may also be recorded.
- You cannot change the zoom speed with the zoom buttons on the LCD frame (DCR-SR38E/SR48E/SR57E/SR67E/SR77E/SR87E).
- The minimum possible distance between camcorder and subject while maintaining sharp focus is about 1 cm (about 13/32 in.) for wide angle and about 150 cm (about 59 1/8 in.) for telephoto (DCR-SR37E/SR38E/SR47E/SR48E/SR57E/SR67E).
- The minimum possible distance between camcorder and subject while maintaining sharp focus is about 1 cm (about 13/32 in.) for wide angle and about 80 cm (about 31 1/2 in.) for telephoto (DCR-SR77E/SR87E).

### 💡 Tips

- You can set [DIGITAL ZOOM] (p. 65) if you want to zoom to a greater level.



## Recording sound with more presence (5.1ch surround recording) (DCR-SR57E/SR67E/SR77E/SR87E)

Dolby Digital 5.1ch surround sound can be recorded with the built-in microphone. You can enjoy realistic sound when playing the movie on devices that support 5.1ch surround sound.



Built-in microphone

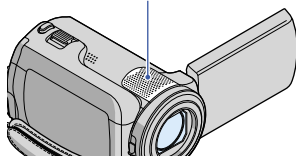

### Notes



- If you play back 5.1ch sound on your camcorder, 5.1ch sound is automatically converted and output in 2ch.

### Tips

- You can select the recording sound from [5.1ch SURROUND] (▶5.1ch) or [2ch STEREO] (▶2ch) ([AUDIO MODE], p. 64).
- You can create a disc, which contains the movies recorded on your camcorder, on a computer using the supplied software. If you play the disc on a 5.1ch surround system, you can enjoy realistic sound.

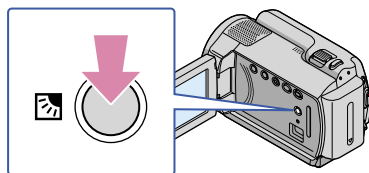
## Adjusting the exposure for backlit subjects



To adjust the exposure for backlit subjects, press  (back light) to display . To cancel the back light function, press  (back light) again.

## Recording in mirror mode

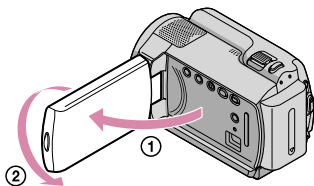

Open the LCD panel 90 degrees to the camcorder ①, then rotate it 180 degrees to the lens side ②.

### Tips

- A mirror-image of the subject appears on the LCD screen, but the image will be normal when recorded.

## Switching the screen display

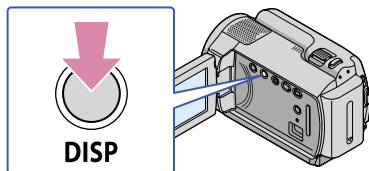

Information (remaining battery capacity, etc.) toggles off and on each time you press DISP.

# Playback on the camcorder

In the default setting, movies and photos that are recorded on the internal hard disk are played (p. 59).

## Playing movies

### 1 Open the LCD screen of your camcorder.

Your camcorder is turned on.

- To turn on your camcorder when the LCD screen is already open, press POWER (p. 19).

### 2 Press (VIEW IMAGES).

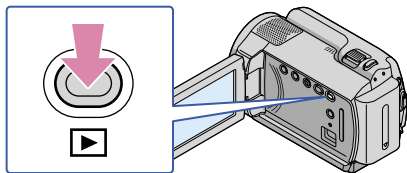

The VISUAL INDEX screen appears after some seconds.

- You can display the VISUAL INDEX screen by pressing  (VIEW IMAGES) on the LCD screen as well.

### 3 Touch the (Movie) tab (①) → a desired movie (②).

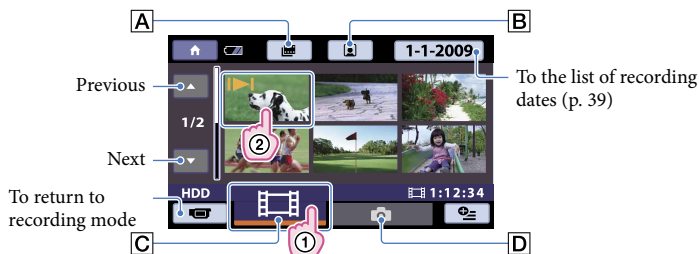



**A** : Displays the Film Roll Index screen (p. 38).

**B** : Displays the Face Index screen (p. 38).

**C** : Displays movies.

**D** : Displays photos.

-  appears with the movie or photo that was most recently played or recorded. If you touch the movie or photo with , you can continue playback from the previous time. ( appears on the photo recorded on “Memory Stick PRO Duo” media.)

Your camcorder starts playing the selected movie.

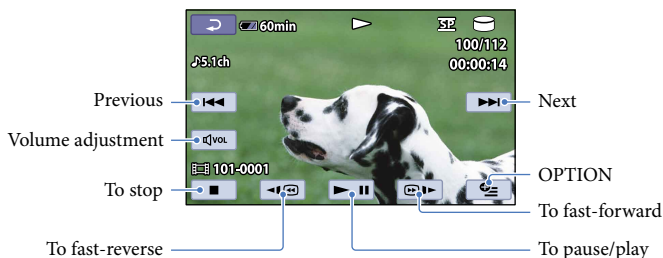

### Tips

- When playback from the selected movie reaches the last movie, the screen returns to the VISUAL INDEX screen.
- Touch [◀|Ⓜ|▶] during pause to play back movies slowly.
- As you repeat touching [◀|Ⓜ|▶] during playback, movies are played as fast as about 5 times → about 10 times → about 30 times → about 60 times.
- You can display the VISUAL INDEX by touching **⬆** (HOME) → **📷** (VIEW IMAGES) → [VISUAL INDEX].
- The recording date, time, and shooting conditions are recorded automatically during recording. This information is not displayed during recording, but you can display it during playback by touching **⬆** (HOME) → **⚙** (SETTINGS) → [VIEW IMAGES SET] → [DATA CODE] → a desired setting → **OK** → **⏪** → **⏩**.

### To adjust the sound volume of movies

While playing back movies, touch **🔊** → adjust with **◀**/**▶** → **⏪**.

- You can adjust the sound volume from the OPTION MENU.

## Viewing photos

Touch the **📷** (Photo) tab **①** → a desired photo **②** on the VISUAL INDEX screen.



Your camcorder displays the selected photo.

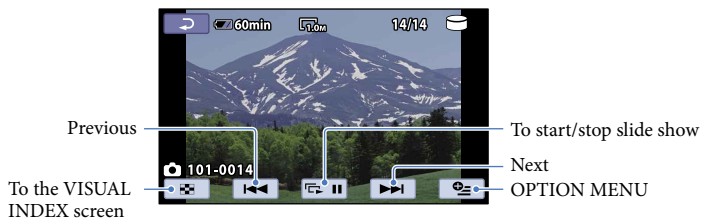

#### Tips

- When viewing photos recorded on “Memory Stick PRO Duo” media, **101** ▶ (playback folder) appears on the screen.

# Useful functions for playing movies and photos

## Searching for desired scene by pinpoint (Film Roll Index)

Movies can be divided by a set time and the first scene of each division is displayed on the INDEX screen. You can start playing back a movie from the selected thumbnail.

Select the recording media which contains the movie you want to play back before the operation (p. 59).

### 1 Press (VIEW IMAGES).

The VISUAL INDEX screen appears.

### 2 Touch (Film Roll Index).

Returns to the VISUAL INDEX screen





Sets the interval at which to create thumbnails of scenes in a movie.

### 3 Touch to select the desired movie.

### 4 Touch to search for the desired scene, then touch the scene you want to play back.

Playback starts from the selected scene.

#### Tips

- You can also display the [Film Roll Index] screen by touching  (HOME) →  (VIEW IMAGES) →  [FILM ROLL].

## Searching for desired scene by face (Face Index)

The face images detected during movie recording are displayed on the INDEX screen. You can play back the movie from the selected face image.

Select the recording media which contains the movie you want to play back before the operation (p. 59).

**1** Press  (VIEW IMAGES).

The VISUAL INDEX screen appears.

**2** Touch  (Face Index).

Returns to the VISUAL INDEX screen



**3** Touch  to select the desired movie.**4** Touch  to search for the desired face image, then touch the desired face image to view the scene.

Playback starts from the beginning of the scene with the selected face image.

 Notes

- Faces may not be detected depending on recording conditions.  
Example: People wearing glasses or hats, or who do not face towards the camera.

 Tips

- You can also display the [Face Index] screen by touching  (HOME) →  (VIEW IMAGES) →  [FACE].

## Searching for desired images by date (Date Index)

You can search for desired images by date efficiently.



Select the recording media which contains the image you want to play back before the operation (p. 59).

 Notes

- You cannot use the Date Index function for photos on the “Memory Stick PRO Duo” media.

**1** Press  (VIEW IMAGES).

The VISUAL INDEX screen appears.



- To search for movies, touch the  (Movie) tab. To search for photos, touch the  (Photo) tab.

- Touch date on the screen.

The recording dates of images are displayed on the screen.

Returns to the VISUAL INDEX screen



- Touch / to select the date of the desired image, then touch .

The images of the selected date are displayed on the VISUAL INDEX screen.

#### Tips

- On the [Film Roll Index]/[Face Index] screen, you can use the Date Index function by following the steps 3 to 4.

## Using PB zoom with photos

You can magnify photos from about 1.1 to 5 times the original size.

Magnification can be adjusted with the power zoom lever.

For DCR-SR38E/SR48E/SR57E/SR67E/SR77E/SR87E:

You can also magnify images with the zoom buttons on the LCD frame.

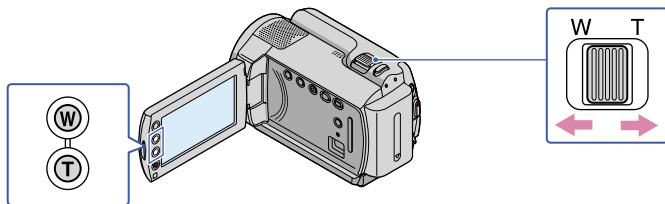

- Play back the photo you want to magnify.

- Magnify the photo with T (Telephoto).

The screen is framed.



- 3 Touch the screen at the point you want to display in the center of the displayed frame.

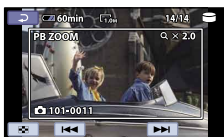

- 4 Adjust the magnification with W (Wide angle)/T (Telephoto).

To cancel, touch

### Playing back a series of photos (Slide show)

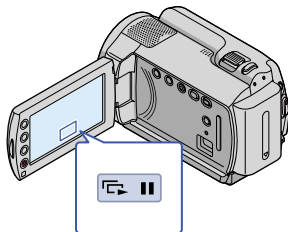

Touch

The slide show begins from the selected photo.

To stop the slide show

Touch

To restart the slide show

Touch

#### Notes

- You cannot operate playback zoom during slide show.

#### Tips

- You can also play back the slide show by touching (OPTION) → tab → [SLIDE SHOW] on the VISUAL INDEX screen.
- You can set continuous slide show playback by selecting (OPTION) → tab → [SLIDE SHOW SET] while playing photos. The default setting is [ON] (continuous playback).

# Playing images on a TV

Connect your camcorder to the input jack of a TV or VCR using the A/V connecting cable **1** or an A/V connecting cable with S VIDEO **2**. Connect your camcorder to the wall outlet (wall socket) using the supplied AC Adaptor for this operation (p. 17). Refer also to the instruction manuals supplied with the devices to be connected.

## **1** A/V connecting cable (supplied)

Connecting to another device via the A/V jack using an A/V connecting cable.

## **2** A/V connecting cable with S VIDEO (sold separately)

When connecting to another device via the S VIDEO jack, by using an A/V connecting cable with an S VIDEO cable (sold separately), higher quality images can be produced than with an A/V connecting cable. Connect the white and red plugs (left/right audio) and the S VIDEO plug (S VIDEO channel) of the A/V connecting cable with an S VIDEO cable (sold separately). The yellow plug connection is not necessary. Connecting only the S VIDEO plug will not output audio.

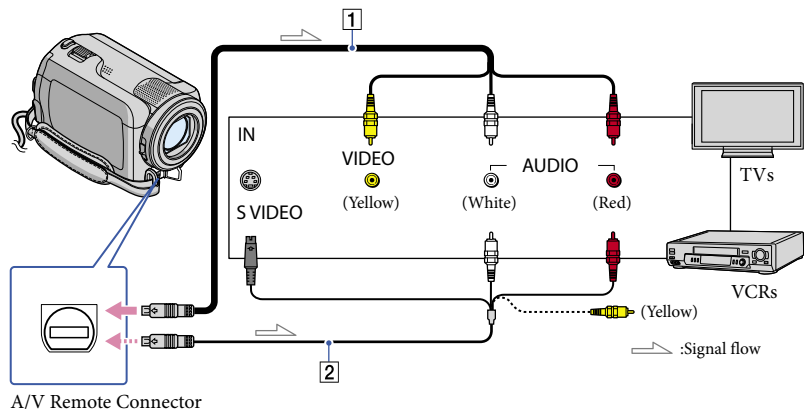

## **1** Set the input selector of the TV to the input your camcorder will be connected to.

For details, refer to the instruction manuals supplied with the TV.

## **2** Connect your camcorder to a TV with the A/V connecting cable (**1**), supplied or an A/V connecting cable with S VIDEO (**2**), sold separately).

Connect your camcorder to the input jack of the TV.

### 3 Play back movies and photos on your camcorder (p. 35).

To set the aspect ratio according to the connected TV (16:9/4:3)

Touch **HOME** → **SETTINGS** → [OUTPUT SETTINGS] → [TV TYPE] → [16:9] or [4:3] → **OK** → **RECALL** → **X**.

#### Tips

- To check information (counter, etc.) on the screen of the monitor, touch **HOME** → **SETTINGS** → [OUTPUT SETTINGS] → [DISP OUTPUT] → [V-OUT/PANEL] (default setting) → **OK** → **RECALL** → **X**.

#### When connecting to your TV via a VCR

Connect your camcorder to the LINE IN input on the VCR using the A/V connecting cable. Set the input selector on the VCR to LINE (VIDEO 1, VIDEO 2, etc.).

#### When your TV is monaural (When your TV has only one audio input jack)

Connect the yellow plug of the A/V connecting cable to the video input jack and connect the white (left channel) or red (right channel) plug to the audio input jack of your TV or VCR.

#### If your TV/VCR has a 21-pin adaptor (EUROCONNECTOR)

Use a 21-pin adaptor (sold separately) to view playback pictures.

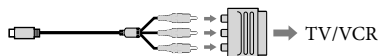

#### Notes

- When you set [TV TYPE] to [4:3], the image quality may deteriorate. Also, when the recorded image's aspect ratio switches between 16:9 (wide) and 4:3, the image may jitter.
- On some 4:3 TVs, the still images recorded in 4:3 aspect ratio may not be displayed full screen. This is not a malfunction.



- When you play back an image recorded in 16:9 (wide) aspect ratio on a 4:3 TV not compatible with the 16:9 (wide) signal, set [TV TYPE] to [4:3].

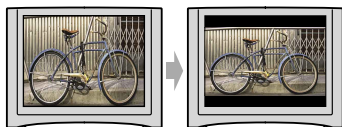

## Deleting movies and photos

You can free media space by deleting movies and photos from recording media. Select the recording medium that contains the movies and photos you want to delete before starting the operation (p. 59).

### Notes

- You cannot restore images once they are deleted.
- Do not remove the battery pack or the AC Adaptor from your camcorder while deleting the images. It may damage the recording media.
- Do not eject "Memory Stick PRO Duo" media while deleting images from the "Memory Stick PRO Duo" media.
- You cannot delete protected movies and photos. Undo the protection of the movies and photos to delete them, before you try to delete them (p. 49).
- If the deleted movie is included in the Playlist (p. 51), the movie added to the Playlist is deleted also from the Playlist.
- Save important movies and photos in advance (p. 53).

### Tips

- You can select up to 100 images at one time.
- You can delete an image on the playback screen from **OPTION MENU**.
- To delete all images recorded in the recording media, and recover all the recordable space of the media, format the media (p. 62).
- Reduced-size images which enable you to view many images at the same time on an index screen are called "thumbnails."

1 Touch **HOME** → **OTHERS** → [DELETE].

2 To delete movies, touch [DELETE] → [DELETE].

- To delete photos, touch [DELETE] → [DELETE].

3 Touch and display the ✓ mark on the movies or photos to be deleted.



### Tips

- Press and hold the image down on the LCD screen to confirm the image. Touch **RETURN** to return to the previous screen.

4 Touch [OK] → [YES] → [OK] → [X].

To delete all movies/photos at one time

In step 2, touch [DELETE] → [DELETE ALL] → [YES] → [YES] → [OK] → [X].

- To delete all photos at one time, touch [DELETE] → [DELETE ALL] → [YES] → [YES] → [OK] → [X].

To delete all the movies/photos recorded on the same day at one time

- You can delete photos by selecting recording dates only when photos are recorded on the internal hard disk.

① In step 2, touch [DELETE] → [DELETE by date].

- To delete all photos on the same day at one time, touch [DELETE] → [DELETE by date].



② Touch **UP**/**DOWN** to select the recording date

of the desired movies/photos, then touch .

The movies/photos recorded on the selected date are displayed on the screen.

 Tips



- Touch the image down on the LCD screen to confirm the image. Touch  to return to the previous screen.

③ Touch  → [YES] →  → .

# Capturing a photo from a movie

You can save a selected frame from a recorded movie as a photo.

Select the recording media which contains movies, and the recording media where you want to save photos before the operation (p. 59).

1 Touch  (HOME) →  (OTHERS) → [PHOTO CAPTURE].

The [PHOTO CAPTURE] screen appears.

2 Touch the movie to be captured.

The selected movie starts playback.

3 Touch  at the point where you want to capture.

The movie pauses. Play and pause toggles as you press .

Adjust the capturing point with more precision after you selected the point with .

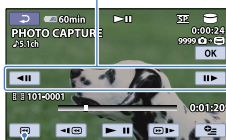





Returns to the beginning of the selected movie

4 Touch .

The captured photo is saved on the recording media selected in [PHOTO MEDIA SET] (p. 59).

When capturing is finished, the screen returns to pause.

- To continue capturing, touch , then repeat steps from step 3.
- To capture a photo from another movie, touch , then repeat steps from step 2.

5 Touch  → .

## Notes

- The image size is fixed depending on the aspect ratio of the movie:
  - [0.2M] in the aspect ratio 16:9
  - [VGA(0.3M)] in the aspect ratio 4:3
- The recording medium where you want to save photos should have enough free space.
- The recording date and time of captured photos is the same as the recording date and time of the movies.
- If the movie you are capturing from has no data code, the recording date and time of the photo will be the date and time you captured from the movie.
- You cannot capture a photo from a movie recorded on “Memory Stick PRO Duo” media (DCR-SR37E/SR38E/SR57E/SR77E).

# Dubbing/copying movies and photos from the internal hard disk to “Memory Stick PRO Duo” media

## Dubbing movies

You can dub movies recorded on the internal hard disk of your camcorder to “Memory Stick PRO Duo” media. Insert “Memory Stick PRO Duo” media into your camcorder before the operation.

### Notes

- When you record a movie on the “Memory Stick PRO Duo” media for the first time, create the image database file by touching **HOME** → **MANAGE MEDIA** → **[REPAIR IMG. DB F.]** → **[MEMORY STICK]**.
- Connect your camcorder to the wall outlet (wall socket) using the supplied AC Adaptor to prevent your camcorder from running out of power during dubbing.

### Tips

- The original movie will not be deleted after dubbing.
- All included images in a Playlist will be dubbed.
- The images recorded by this camcorder and stored onto the recording media are called “original.”

- 1 Touch **HOME** → **OTHERS** → **[MOVIE DUB]**.

The **[MOVIE DUB]** screen appears.

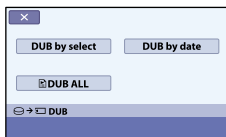

- 2 Touch the type of dubbing.

**[DUB by select]:** To select movies and dub

**[DUB by date]:** To dub all movies of a specified date

**[DUB ALL]:** To dub the Playlist

When you select the Playlist as the source of dubbing, follow the on-screen instructions to dub the Playlist.

- 3 Select the movie to be dubbed.

**[DUB by select]:** Touch the movie to be dubbed, and mark it with ✓. You can select multiple movies.



Remaining capacity of the “Memory Stick PRO Duo” media

### Tips

- Press and hold the image down on the LCD screen to confirm the image. Touch **PREVIEW** to return to the previous screen.

**[DUB by date]:** Select the recording date of the movie to be dubbed, then touch **[OK]**. You cannot select multiple dates.



- 4 Touch **[OK]** → **[YES]** → **[OK]** → **[X]**.

### Tips

- To check the dubbed movies after dubbing is finished, select [MEMORY STICK] on [MOVIE MEDIA SET] and play them back (p. 59).



## Copying photos

You can copy photos from the internal hard disk of the camcorder to “Memory Stick PRO Duo” media.

Insert “Memory Stick PRO Duo” media into your camcorder before the operation.

### Notes

- Connect your camcorder to the wall outlet (wall socket) using the supplied AC Adaptor to prevent your camcorder from running out of power during copying.

- 1 Touch  (HOME) →  (OTHERS) → [PHOTO COPY].

The [PHOTO COPY] screen appears.

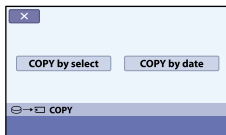

- 2 Touch the type of copying.

[COPY by select]: To copy selected photos

[COPY by date]: To copy all photos of a specified date

- 3 Select the photo to be copied.

[COPY by select]: Touch the photo to be copied, and mark with ✓. You can select multiple photos.





### Tips

- Press and hold the image down on the screen to confirm the image. Touch  to return to the previous screen.

[COPY by date]: Select the recording date of the photo to be copied, then touch . You cannot select multiple dates.



- 4 Touch  → [YES] →  → .

### Tips

- To check the copied photos after copying is finished, select [MEMORY STICK] on [PHOTO MEDIA SET] and play them back (p. 59).



# Protecting recorded movies and photos (Protect)

Protect movies and photos to avoid deleting them by mistake.

Select the recording medium that contains the movies and photos you want to protect before starting the operation (p. 59).

## Tips

- You can protect movies and photos on the playback screen from **OPTION MENU**.

1 Touch **HOME** → **(OTHERS)** → **[EDIT]**.

2 To protect movies, touch **[PROTECT]** → **[PROTECT]**.

- To protect photos, touch **[PROTECT]** → **[PROTECT]**.

3 Touch the movies and photos to be protected.

**LOCK** is displayed on the selected images.



## Tips

- Press and hold the image down on the LCD screen to confirm the image. Touch **[RETURN]** to return to the previous screen.
- You can select up to 100 images at one time.

4 Touch **[OK]** → **[YES]** → **[OK]** → **[X]**.

### To undo the protection of movies and photos

Touch the movie or photo marked with **LOCK** in step 3.

**LOCK** disappears.

### To protect all the movies and photos recorded on the same day at one time

- You can protect photos recorded on the internal hard disk by selecting their recording date.

① In step 2, touch **[PROTECT]** → **[PRT. by date]**.

- To protect all photos on the same day at one time, touch **[PROTECT]** → **[PRT. by date]**.



② Touch **[UP]**/**[DOWN]** to select the recording date of the desired movies/photos, then touch **[OK]**.

## Tips

- Touch the image down on the LCD screen to confirm the image. Touch **[RETURN]** to return to the previous screen.

③ Touch **[OK]** → **[ON]** → **[OK]** → **[X]**.

### To undo the protection of movies and photos recorded on the same day at one time

In step ② above, select the recording date of the desired movies/photos, then touch **[OK]** → **[OFF]** → **[OK]** → **[X]**.

# Dividing a movie

Select the recording medium which contains the movie you want to divide before the operation (p. 59).

1 Touch **HOME** → **(OTHERS)**  
→ **[EDIT]** → **[DIVIDE]**.

2 Touch the movie to be divided.

The selected movie starts playback.

3 Touch **⏸** at the point where you want to divide the movie into scenes.

The movie pauses. Play and pause toggles as you press **⏸**.

Adjusts the dividing point with more precision after you selected the dividing point with **⏸**.

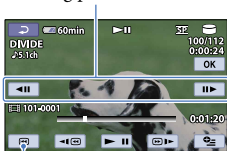

Returns to the beginning of the selected movie

4 Touch **[OK]** → **[YES]** → **[OK]** → **[X]**.

- A slight difference may occur from the point where you touch **⏸** and the actual dividing point, as your camcorder selects the dividing point based on about half-second increments.
- If you divide the original movie, the movie added to the Playlist will also be divided.

## Tips

- You can divide a movie on the playback screen from **[OPTION MENU]**.

## Notes

- You cannot restore movies once they are divided.
- Do not remove the battery pack or the AC Adaptor from your camcorder while dividing the movie. It may damage the recording media. Also, do not eject the "Memory Stick PRO Duo" media while dividing movies on the "Memory Stick PRO Duo" media.

# Using the Playlist of movies

The Playlist is a list showing thumbnails of the movies that you have selected.

The original movies are not changed even if you edit or delete the movies added to the Playlist.

Select the recording media you want to create, play, or edit a Playlist before the operation (p. 59).

## Creating the Playlist

1 Touch (HOME) → (OTHERS) → [PLAYLIST EDIT].

2 Touch [] ADD].

3 Touch the movie to be added to the Playlist.



The selected movie is marked with ✓.

### Tips

- Press and hold the image down on the LCD screen to confirm the image. Touch to return to the previous screen.

4 Touch [OK] → [YES] → [OK] → .

To add all the movies recorded on the same day at one time

① In step 2, touch [] ADD by date].

The recording dates of movies are displayed on the screen.



② Touch / to select the recording date of the desired movie, then touch [OK]. The movies recorded on the selected date are displayed on the screen.

### Tips

- Touch the image on the LCD screen to confirm the image. Touch to return to the previous screen.

③ Touch [OK] → [YES] → [OK] → .

### Notes

- Do not remove the battery pack or the AC Adaptor from your camcorder while adding movies to the Playlist. It may damage the recording media. Also, do not eject the “Memory Stick PRO Duo” media while editing movies on the “Memory Stick PRO Duo” media.
- You cannot add photos to the Playlist.

### Tips

- You can add a maximum of 99 movies to the Playlist.
- You can add a movie on the playback screen or the INDEX screen by touching (OPTION).
- You can copy the Playlist to a disc as it is, by using the supplied software.

## Playing the Playlist

Select the recording media you want to play a Playlist before the operation (p. 59).

- 1 Touch **HOME** → **VIEW IMAGES** → [PLAYLIST].

Movies added to the Playlist appear.

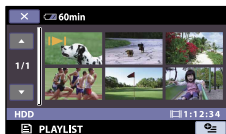

- 2 Touch the movie you want to play back.

The Playlist is played back from the selected movie to the end, then the screen returns to the Playlist screen.

To erase unnecessary movies from the Playlist

- 1 Touch **HOME** → **(OTHERS)** → [PLAYLIST EDIT].

- 2 Touch [ERASE].

To erase all the movies from the Playlist, touch [ERASE ALL] → [YES] → [YES] → [OK].

- 3 Select the movie to be erased from the list.



The selected movie is marked with ✓.

### Tips

- Press and hold the image down on the LCD screen to confirm the image. Touch **PREVIEW** to return to the previous screen.

- 4 Touch [OK] → [YES] → [OK] → [X].

### Tips

- Even if you erase a movie from a Playlist, the original movie is not erased.

To change the order within the Playlist

- 1 Touch **HOME** → **(OTHERS)** → [PLAYLIST EDIT].

- 2 Touch [MOVE].

- 3 Select the movie to be moved.



The selected movie is marked with ✓.

### Tips

- Touch the image on the LCD screen to confirm the image. Touch **PREVIEW** to return to the previous screen.

- 4 Touch [OK].

- 5 Select the destination with **LEFT**/**RIGHT**.



Destination bar

- 6 Touch [OK] → [YES] → [OK] → [X].

### Tips

- When you select multiple movies, the movies are moved following the order appearing in the Playlist.

# Creating a disc with a DVD writer, recorder

## Creating a disc with the dedicated DVD writer, DVDirect Express

Operating on the camcorder screen, you can save movies on a disc when using the dedicated DVD writer, DVDirect Express (sold separately). You can also play back images on a created disc.

Refer also to the instruction manual supplied with the DVD writer.

- DVDirect Express is referred to as “DVD writer” in this section.
- Only unused discs of the following types can be used:
  - 12cm DVD-R
  - 12cm DVD+R
- The device does not support two-layered discs.
- Sony DVD writer may not be available in some countries/regions.

- 1 Turn on your camcorder, and connect the DVD writer to the  $\Psi$  (USB) jack of your camcorder with the USB cable of the DVD writer.

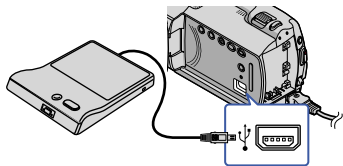

The [EXTERNAL DRIVE] screen appears on the camcorder screen.

### ⚡ Notes

- Use the supplied AC Adaptor as the power source (p. 17). When using battery power, the DVD writer does not work.

- 2 Insert an unused disc into the DVD writer, and close the disc tray.

The [DISC BURN] screen appears on the camcorder screen.

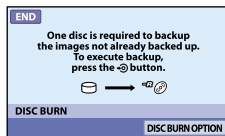

- 3 Press  $\Psi$  (DISC BURN) on the DVD writer.

Movies recorded on the internal hard disk that have not been saved on any discs will be recorded onto the disc. After the disc has been created, the disc tray on the DVD writer opens and you can remove the disc.

- You can also operate with  $\Psi$  (DISC BURN) on your camcorder.

- 4 Repeat steps 2 and 3 when the total memory size of movies to be burnt exceeds that of the disc.

- 5 After the operation is completed, touch [OK] → [END] on the camcorder screen.

- Touch [EJECT DISC] and remove any inserted disc.

- 6 Close the disc tray on the DVD writer, and disconnect the USB cable.

To create a disc with the selected images

To dub a desired image onto the disc or to create many of the same discs, perform this operation.

- 1 Touch [DISC BURN OPTION] in step 3 above.

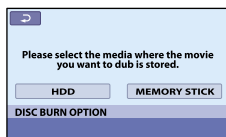

- 2 Select the recording media containing the movie(s) you want to save. Movie thumbnails appear on the camcorder screen.

- 3 Touch the movie you want to burn on the disc.  
✓ appears.



Remaining Disc capacity

**Tips**

- Press and hold the image down on the LCD screen to confirm the image. Touch  to return to the previous screen.
- By touching date, you can search for images by date.

- 4 Touch **[OK]** → **[YES]** on the camcorder screen.

The disc tray on the DVD writer opens after creating the disc.

- 5 Remove the disc from the DVD writer, and close the disc tray.
  - To create another disc of the same contents, insert a new disc and touch **[CREATE SAME DISC]**.

- 6 After the operation is completed, touch **[EXIT]** → **[END]** on the camcorder screen.

- 7 Close the disc tray on the DVD writer, and disconnect the USB cable from your camcorder.

To play back a disc on the DVD writer

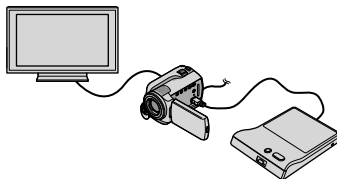

- 1 Turn on your camcorder, and connect the DVD writer to the  $\Psi$  (USB) jack of your camcorder with the USB cable of the DVD writer. The **[EXTERNAL DRIVE]** screen appears.

**Tips**

- You can play back movies on the TV screen by connecting the camcorder to a TV (p. 42).

- 2 Insert a created disc into the DVD writer.

The movies on the disc appear as **VISUAL INDEX** on the camcorder screen.

- 3 Press the play button on the DVD writer. The movie plays back on the camcorder screen.

- You can also operate by the camcorder screen (p. 35).

- 4 Touch **[END]** → **[EJECT DISC]** on the camcorder screen and remove the disc after the operation is completed.

- 5 Press **[OK]** and disconnect the USB cable.

**Notes**

- Be sure to turn on the camcorder. The DVD writer is powered from the camcorder.
- You can use **[DISC BURN OPTION]** to create many of the same disc.

- Do not do any of the following when creating a disc.
  - Turn off the camcorder
  - Disconnect the USB cable or the AC adaptor
  - Subject the camcorder to mechanical shock or vibration
  - Eject the “Memory Stick PRO Duo” media from the camcorder
- You cannot add movies to a created disc.
- Play the created disc to make sure dubbing was performed correctly before deleting the movies on your camcorder.
- If [Failed.] or [DISC BURN failed.] appears on the screen, insert another disc into the DVD writer and touch  (DISC BURN) again.

#### Tips

- If the total memory size of movies to be burnt by the DISC BURN operation exceeds that of the disc, disc creation stops when the limit is reached. The last movie on the disc may be cut off.
- Disc creation time to dub movies to the limit of the disc is about 20 to 60 minutes. It may take more time depending on the recording mode or the number of scenes.
- You can play back created discs on a general DVD player. If playback is not possible for any reason, connect the camcorder to the DVD writer, and then play back.
- The disc mark appears on the camcorder screen.

### Creating a disc with a DVD writer, etc., other than DVDirect Express

You can save movies on a disc by connecting your camcorder to disc creation devices, such as a Sony DVD writer other than DVDirect Express, with the USB cable. Refer also to the instruction manuals supplied with the devices to be connected. The method used to create a disc by connecting your camcorder to a Sony DVD writer with the USB cable is described here.



- Connect your camcorder to the wall outlet (wall socket) using the supplied AC Adaptor for this operation (p. 17).

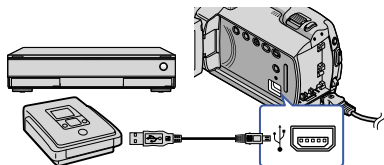

- Sony DVD writer may not be available in some countries/regions.

- 1 Turn on your camcorder, and connect a DVD writer, etc., to the  (USB) jack of your camcorder with the USB cable (supplied).



The [USB SELECT] screen appears on the camcorder screen.

- If the [USB SELECT] screen does not appear, touch  (HOME) →  (OTHERS) → [USB CONNECT].

- 2 Touch  [USB CONNECT] when movies are recorded on the internal hard disk, or  [USB CONNECT] when movies are recorded on “Memory Stick PRO Duo” media on the camcorder screen.

- 3 Record movies on the connected device.

- For details, refer to the instruction manuals supplied with the device to be connected.

- 4 After the operation is completed, touch [END] → [YES] on the camcorder screen.

- 5 Disconnect the USB cable.

## Creating a disc with a recorder, etc.

You can dub images played back on your camcorder to a disc or video cassette, by connecting your camcorder to a disc recorder, a Sony DVD writer other than DVDirect Express, etc., with the A/V connecting cable. Connect the device in either way of **1** or **2**. Refer also to the instruction manuals supplied with the devices to be connected. Select the recording medium that contains movies you want to dub before starting the operation (p. 59).

- Sony DVD writer may not be available in some countries/regions.

### ⚡ Notes

- Connect your camcorder to the wall outlet (wall socket) using the supplied AC Adaptor for this operation (p. 17).

**1** A/V connecting cable (supplied)  
Connect the A/V connecting cable to the input jack of another device.

**2** A/V connecting cable with S VIDEO  
(sold separately)

When connecting to another device via the S VIDEO jack, by using an A/V connecting cable with an S VIDEO cable (sold separately), higher quality images can be produced than with an A/V connecting cable. Connect the white and red plug (left/right audio) and the S VIDEO plug (S VIDEO channel) of the A/V connecting cable with an S VIDEO cable. If you connect the S VIDEO plug only, you will hear no sound. The yellow plug (video) connection is not necessary.

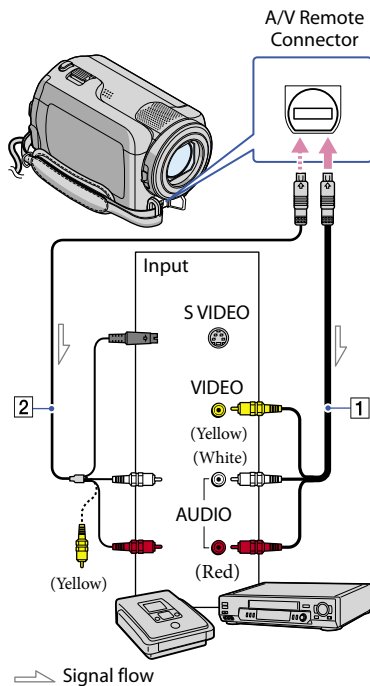

➤ Signal flow

**1** Insert the recording media in the recording device.

- If your recording device has an input selector, set it to the input mode.

**2** Connect your camcorder to the recording device (a disc recorder, etc.) with the A/V connecting cable **1** (supplied) or an A/V connecting cable with S VIDEO **2** (sold separately).

- Connect your camcorder to the input jacks of the recording device.



---

**3** Start playback on your camcorder, and record it on the recording device.





















- Refer to the instruction manuals supplied with your recording device for details.

---

**4** When dubbing is finished, stop the recording device, and then your camcorder.



---

 Notes

- Since dubbing is performed via analog data transfer, the image quality may deteriorate.
- To hide the screen indicators (such as a counter, etc.) on the screen of the monitor device connected, touch  (HOME) →  (SETTINGS) → [OUTPUT SETTINGS] → [DISP OUTPUT] → [LCD PANEL] (the default setting) →  →  → .
- To record the date/time or camera settings data, touch  (HOME) →  (SETTINGS) → [VIEW IMAGES SET] → [DATA CODE] → a desired setting →  →  → . In addition, touch  (HOME) →  (SETTINGS) → [OUTPUT SETTINGS] → [DISP OUTPUT] → [V-OUT/PANEL] →  →  → .
- When the screen size of display devices (TV, etc.) is 4:3, touch  (HOME) →  (SETTINGS) → [OUTPUT SETTINGS] → [TV TYPE] → [4:3] →  →  → .
- When you connect a monaural device, connect the yellow plug of the A/V connecting cable to the video input jack, and the white (left channel) or the red (right channel) plug to the audio input jack on the device.

# Checking the battery information

You can check the estimated remaining capacity of the battery.

Touch  (HOME) →  (OTHERS) → [BATTERY INFO].

The remaining battery capacity is shown.

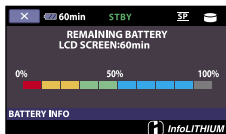

To close the battery information screen

Touch .

## Changing the recording media

You can select the internal hard disk or “Memory Stick PRO Duo” media as the recording, playback, or editing medium on your camcorder. Select the medium to be used for movies and photos separately. In the default setting, both movies and photos are recorded on the internal hard disk.

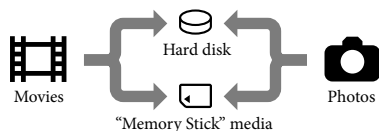

- You can do recording, playback, and editing operations on the selected medium.
- See page 94 for the recordable time of movies.
- See page 95 for the number of recordable photos.

### Selecting the recording media

- 1 Touch (HOME) → (MANAGE MEDIA) → [MOVIE MEDIA SET].

The [MOVIE MEDIA SET] screen appears.

- 2 Touch the desired medium.

- 3 Touch [YES] → .

The recording medium is changed.

### Selecting the recording media for photos

- 1 Touch (HOME) → (MANAGE MEDIA) → [PHOTO MEDIA SET].

The [PHOTO MEDIA SET] screen appears.

- 2 Touch the desired recording medium.

- 3 Touch [YES] → .

The recording medium is changed.

To check the recording media settings Light up the (Movie) lamp to check the recording medium used for movies, or the (Photo) lamp for photos. The media icon is displayed at the top right corner of the screen.



: Internal hard disk

: “Memory Stick PRO Duo” media

### Inserting “Memory Stick PRO Duo” media

- Set the recording medium to [MEMORY STICK] to record movies and/or photos on “Memory Stick PRO Duo” media (p. 59).

Types of “Memory Stick” media you can use with your camcorder

- For recording movies, it is recommended that you use “Memory Stick PRO Duo” media of 512 MB or larger marked with:
  - **MEMORY STICK PRO DUO** (“Memory Stick PRO Duo” media)\*

– **MEMORY STICK PRO-HG Duo** (“Memory Stick PRO-HG Duo” media)

\* Marked with Mark2 or not, either can be used.

- See page 94 for the recordable time of “Memory Stick PRO Duo” media.

“Memory Stick PRO Duo” media/“Memory Stick PRO-HG Duo” media

(This size can be used with your camcorder.)



“Memory Stick” media

(You cannot use it in your camcorder.)



- You cannot use any type of memory card other than those mentioned above.
- “Memory Stick PRO Duo” media can be used only with “Memory Stick PRO” media compatible equipment.
- Do not attach a label or the like on “Memory Stick PRO Duo” media or “Memory Stick Duo” media adaptor.
- Insert the “Memory Stick PRO Duo” media into the “Memory Stick Duo” media adaptor when using “Memory Stick PRO Duo” media with “Memory Stick” media compatible equipment.

**1** Open the “Memory Stick Duo” media cover, and insert the “Memory Stick PRO Duo” media into the “Memory Stick Duo” media slot until it clicks.

- Confirm the direction of the “Memory Stick PRO Duo” media. If you forcibly insert the “Memory Stick PRO Duo” media in the wrong direction, the “Memory Stick PRO Duo” media, “Memory Stick Duo” media slot, or image data may be damaged.
- Close the “Memory Stick Duo” media cover after inserting the “Memory Stick PRO Duo” media.

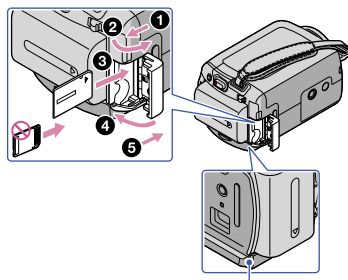

Access lamp

(“Memory Stick PRO Duo” media)

The [Create a new Image Database File.] screen appears if you insert new “Memory Stick PRO Duo” media when the  (Movie) lamp is lit.

**2** Touch [YES].

- To record only photos on “Memory Stick PRO Duo” media, touch [NO].

### Notes

- If [Failed to create a new Image Database File. It may be possible that there is not enough free space.] is displayed in step 2, format the “Memory Stick PRO Duo” media (p. 62).

To eject the “Memory Stick PRO Duo” media

Open the “Memory Stick Duo” media cover and lightly push the “Memory Stick PRO Duo” media in once.

- Do not open the “Memory Stick Duo” media cover during recording.
- When inserting or ejecting the “Memory Stick PRO Duo” media, be careful so that the “Memory Stick PRO Duo” media does not pop out and drop.



# Checking the media information

You can check the remaining recordable time for each recording mode of the recording media selected on [MOVIE MEDIA SET] (p. 59), and the approximate free and used media space of the recording media.

## ⚡ Notes

- During Easy Handycam operation, you cannot check the media information. Cancel Easy Handycam operation.

---

Touch  (HOME) →  (MANAGE MEDIA) → [MEDIA INFO].

The remaining recordable time for each recording mode is displayed.

## 💡 Tips

- You can check the recordable free space, etc., by touching  at the lower right on the screen.

## To turn off the display

Touch .

## ⚡ Notes

- The calculation for recording media space is 1 MB = 1,048,576 bytes. The fractions less than MB are discarded when the recording media space is displayed. The displayed size of the whole hard disk space will be slightly smaller than the size shown below despite displaying both free and used hard disk space.
  - DCR-SR37E/SR47E: 60,000 MB
  - DCR-SR38E/SR48E: 70,000 MB
  - DCR-SR57E/SR67E/SR77E/SR87E: 80,000 MB
- Since there is a management file area, the used space is not displayed as 0 MB even if you perform [MEDIA FORMAT] (p. 62).

## 💡 Tips

- Only the information of the medium selected on [MOVIE MEDIA SET] (p. 59) is displayed. Change the medium setting if necessary.



# Deleting all movies and photos (Formatting)

Formatting deletes all the movies and photos to recover recordable free space.

## ⚡ Notes

- Connect your camcorder to the wall outlet (wall socket) using AC Adaptor supplied for this operation (p. 17).
- To avoid the loss of important images, you should save them (p. 53, see Operating Guide too) before formatting the recording media.
- Protected movies and photos will also be deleted.

---

1 Touch  (HOME) →   
(MANAGE MEDIA) → [MEDIA  
FORMAT].

---

2 Touch the recording media to be  
formatted ([HDD] or [MEMORY  
STICK]).

---

3 Touch [YES] → [YES] → .

---

## ⚡ Notes

- While [Executing...] is displayed, do not close the LCD screen, operate the buttons on the camcorder, disconnect the AC Adaptor, or eject the “Memory Stick PRO Duo” media from your camcorder (The ACCESS/access lamp is lit or flashing while formatting the medium.).

# Preventing data on the internal hard disk from being recovered

[⊖EMPTY] allows you to write unintelligible data onto the internal hard disk of the camcorder. In this way, it may become more difficult to recover any original data. When you dispose of or transfer the camcorder, it is recommended that you perform [⊖EMPTY].

## ⚡ Notes

- If you perform [⊖EMPTY], all the images are deleted. To avoid the loss of important images, they should be saved (p. 53, see Operating Guide too) before performing [⊖EMPTY].
- You cannot perform [⊖EMPTY] unless you connect the AC Adaptor to the wall outlet (wall socket).
- Disconnect all cables except the AC Adaptor. Do not disconnect the AC Adaptor during the operation.
- While performing [⊖EMPTY], do not apply any vibrations or shocks to your camcorder.

1 Connect the AC Adaptor to the DC IN jack on the camcorder and the wall outlet (wall socket).

2 Open the LCD screen to turn on your camcorder.

3 Touch  (HOME) →  (MANAGE MEDIA) → [MEDIA FORMAT] → [HDD].

The [⊖FORMAT] screen appears.

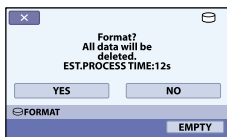

4 Touch [⊖EMPTY].

The [⊖EMPTY] screen appears.

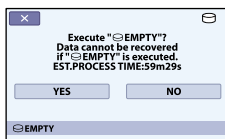

5 Touch [YES] → [YES] → .

## ⚡ Notes

- The actual performing time for [⊖EMPTY] is as follows:
  - DCR-SR37E/SR47E: about 60 minutes
  - DCR-SR38E/SR48E: about 70 minutes
  - DCR-SR57E/SR67E/SR77E/SR87E: about 80 minutes
- If you stop performing [⊖EMPTY] while [Executing...] appears, be sure to complete the operation by performing [MEDIA FORMAT] or [⊖EMPTY] when you use the camcorder next time.

## MOVIE SETTINGS (Items for recording movies)

The default settings are marked with ►.

### REC MODE (Recording mode)

#### Steps

(HOME) → (SETTINGS) → [MOVIE SETTINGS] → [REC MODE] → a desired setting  
 → → →

You can select a recording mode to record movies from 3 levels.

	HQ (HQ)	Records in high quality mode (9M (HQ)).
►	SP (SP)	Records in standard quality mode (6M (SP)).
	LP (LP)	Increases the recording time (Long Play) (3M (LP)).

#### ⚡ Notes

- If you record in the LP mode, the quality of movies may be degraded, or scenes with quick movements may appear with block noise when you play back the image.

#### 💡 Tips

- See page 93 for the expected recording time of each recording mode.
- You can select the [REC MODE] for each recording media separately.
- Figures such as 9M in the table show the average bit rate. M stands for Mbps.

### AUDIO MODE (DCR-SR57E/SR67E/SR77E/SR87E)

You can change the recording sound format.

#### Steps

(HOME) → (SETTINGS) → [MOVIE SETTINGS] → [AUDIO MODE] → a desired setting  
 → → →

►	5.1ch SURROUND (5.1ch)	Records sound in 5.1ch surround.
	2ch STEREO (2ch)	Records sound in 2ch stereo.



## WIDE SELECT

You can select the horizontal to vertical ratio according to the TV connected. Refer also to the instruction manuals supplied with your TV.

### Steps

🏠 (HOME) → ⚙️ (SETTINGS) → [MOVIE SETTINGS] → [WIDE SELECT] → a desired setting → **OK** → **⏪** → **✖**

▶ 16:9 WIDE	Records movies to the full screen on a 16:9 (wide) TV screen.
4:3 <b>4:3</b>	Records movies to the full screen on a 4:3 TV screen.

### 🔔 Notes

Set [TV TYPE] correctly according to the TV connected for playback (p. 74).

## DIGITAL ZOOM

You can select the maximum zoom level in case you want to zoom to a level greater than following optical zoom during recording. Note that the image quality decreases when you use the digital zoom.

– DCR-SR37E/SR38E/SR47E/SR48E/SR57E/SR67E: 60 ×

– DCR-SR77E/SR87E: 25 ×

### Steps

🏠 (HOME) → ⚙️ (SETTINGS) → [MOVIE SETTINGS] → [DIGITAL ZOOM] → a desired setting → **OK** → **⏪** → **✖**

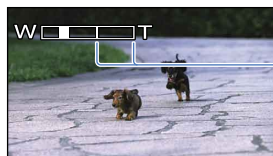

The right side of the bar shows the digital zooming factor. The zooming zone appears when you select the zooming level.

### DCR-SR37E/SR38E/SR47E/SR48E/SR57E/SR67E

▶ OFF	Up to 60 × zoom is performed optically.
120 ×	Up to 60 × zoom is performed optically, and after that, up to 120 × zoom is performed digitally.
2000 ×	Up to 60 × zoom is performed optically, and after that, up to 2000 × zoom is performed digitally.

### DCR-SR77E/SR87E

▶ OFF	Up to 25 × zoom is performed optically.
50 ×	Up to 25 × zoom is performed optically, and after that, up to 50 × zoom is performed digitally.
2000 ×	Up to 25 × zoom is performed optically, and after that, up to 2000 × zoom is performed digitally.

## STEADYSHOT

You can compensate for camera shake.

Set [STEADYSHOT] to [OFF] (OFF) when using a tripod (sold separately), then the image becomes natural.

### Steps

HOME (HOME) → SETTINGS (SETTINGS) → [MOVIE SETTINGS] → [STEADYSHOT] → a desired setting → OK → [ ] → X

▶ ON	The SteadyShot function is used.
OFF (OFF)	The SteadyShot function is not used.

## AUTO SLW SHUTTR (Auto Slow Shutter)

When recording in dark places, the shutter speed is automatically reduced to 1/25 second.

### Steps

HOME (HOME) → SETTINGS (SETTINGS) → [MOVIE SETTINGS] → [AUTO SLW SHUTTR] → a desired setting → OK → [ ] → X

▶ ON	The Auto Slow Shutter function is used.
OFF	The Auto Slow Shutter function is not used.

## GUIDEFAME

You can display the frame and check that the subject is horizontal or vertical.

The frame is not recorded. Press DISP to make the frame disappear.

### Steps

HOME (HOME) → SETTINGS (SETTINGS) → [MOVIE SETTINGS] → [GUIDEFAME] → a desired setting → OK → [ ] → X

▶ OFF	Does not display the guide frame.
ON	Displays the guide frame.

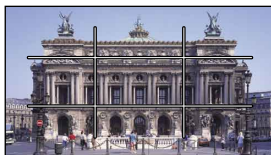

### Tips

- Positioning the subject at the cross point of the guide frame makes a balanced composition.

## REMAINING SET

### Steps

HOME (HOME) → SETTINGS (SETTINGS) → [MOVIE SETTINGS] → [REMAINING SET] → a desired setting → OK → [ ] → X

▶ ON	Always displays the remaining recording media indicator.
AUTO	Displays the remaining recording time of movies for about 8 seconds in situations such as those described below. <ul style="list-style-type: none"><li>– When your camcorder recognizes the remaining recording media capacity while the (Movie) lamp lights up</li><li>– When you press DISP to switch the indicator from off to on while the (Movie) lamp lights up</li><li>– When you select the movie recording mode on the HOME MENU</li></ul>



### Notes

- When the remaining recordable time for movies is less than 5 minutes, the indicator stays on the screen.

## FACE SET

### Steps

HOME (HOME) → SETTINGS (SETTINGS) → [MOVIE SETTINGS] → [FACE SET] → a desired setting → OK → [ ] → X

▶ ON	The camcorder detects faces automatically and displays the Face Index screen (p. 38). Face icons and their meanings  : This icon appears when the setting is [ON].  : This icon flashes when your camcorder detects a face. The icon stops flashing when the face is recorded in Face Index.  : This icon appears when faces cannot be recorded in Face Index.
OFF	Does not display the Face Index screen.

### Notes

- The number of faces detected in a movie is limited.

# PHOTO SETTINGS (Items for recording photos)

The default settings are marked with ▶.

## IMAGE SIZE

You can select a photo size to be shot.

### Steps

🏠 (HOME) → 📷 (SETTINGS) → [PHOTO SETTINGS] → [IMAGE SIZE] → a desired setting → [OK] → [▶] → [X]

### DCR-SR37E/SR38E/SR47E/SR48E/SR57E/SR67E

▶ VGA(0.3M) (VGA)	Records photos clearly (640 × 480).
▶ 0.2M (0.2M)	Allows the maximum number of still images to be recorded (640 × 360). The image size is set to [0.2M] automatically in the 16:9 (wide) aspect ratio.

### DCR-SR77E/SR87E

▶ 1.0M (1.0M)	Records photos clearly (1,152 × 864).
▶ 0.7M (0.7M)	Records photos clearly in the 16:9 (wide) ratio (1,152 × 648). The image size is set to [0.7M] automatically in the 16:9 (wide) aspect ratio.
VGA(0.3M) (VGA)	Allows the maximum number of photos to be recorded (640 × 480).

### 🔔 Notes

- See page 95 for the number of recordable photos.

## FILE NO. (File number)

You can select the way to assign file number of photos.

### Steps

🏠 (HOME) → 📷 (SETTINGS) → [PHOTO SETTINGS] → [FILE NO.] → a desired setting → [OK] → [▶] → [X]

▶ SERIES	Assigns file numbers of photos in sequence. – The file number becomes larger each time you record a photo. – Even if the “Memory Stick PRO Duo” media is replaced with another one, the file number is assigned in sequence.
RESET	Assigns file numbers in sequence, following the largest file number existing on the current recording medium. – When the “Memory Stick PRO Duo” media is replaced with another one, the file number is assigned for each “Memory Stick PRO Duo” media.

## AUTO SLW SHUTTR (Auto Slow Shutter)

When recording in dark places, the shutter speed is automatically reduced to 1/25 second.

### Steps

🏠 (HOME) → 📷 (SETTINGS) → [PHOTO SETTINGS] → [AUTO SLW SHUTTR] → a desired setting → [OK] → [↩] → [X]

▶ ON	The Auto Slow Shutter function is used.
OFF	The Auto Slow Shutter function is not used.

## GUIDEFAME

You can display the frame and check that the subject is horizontal or vertical.

The frame is not recorded. Press DISP to make the frame disappear.

### Steps

🏠 (HOME) → 📷 (SETTINGS) → [PHOTO SETTINGS] → [GUIDEFAME] → a desired setting → [OK] → [↩] → [X]

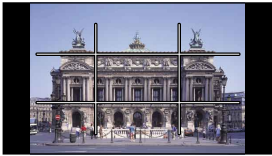
▶ OFF	Does not display the guide frame.	
ON	Displays the guide frame.	

### 💡 Tips

- Positioning the subject at the cross point of the guide frame makes a balanced composition.

# VIEW IMAGES SET (Items to customize the display)

The default settings are marked with ▶.

## DATA CODE

During playback, your camcorder displays the information (data code) recorded automatically at the time of recording.

### Steps

▶ (HOME) → (SETTINGS) → [VIEW IMAGES SET] → [DATA CODE] → a desired setting → [OK] → [▶] → [X]

▶ OFF	Data code is not displayed.
DATE/TIME	Displays the date and time.
CAMERA DATA	Displays camera setting data.

## DATE/TIME



- 1 Date
- 2 Time

## CAMERA DATA

### Movie

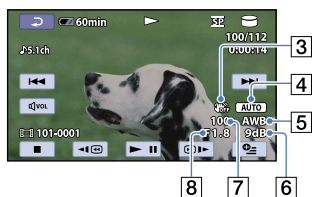

- 3 SteadyShot off
- 4 Brightness
- 5 White balance
- 6 Gain
- 7 Shutter speed
- 8 Aperture value

### Photo

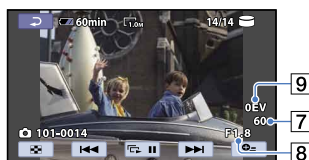

 Tips

- The data code is displayed on the TV screen if you connect your camcorder to a TV.
- Depending on the recording media condition, bars [---:---:---] appear.

# SOUND/DISP SET (Items to adjust the sound and the screen)

The default settings are marked with ▶.

## VOLUME

You can adjust the volume of playback sound.

### Steps

🏠 (HOME) → ⚙️ (SETTINGS) → [SOUND/DISP SET] → [VOLUME] → (quieter)/  
 (louder) → → →

## BEEP

### Steps

🏠 (HOME) → ⚙️ (SETTINGS) → [SOUND/DISP SET] → [BEEP] → a desired setting →  
 → →

▶ ON	A melody sounds when you start/stop recording, or operate the touch panel.
OFF	Cancels the melody.

## LCD BRIGHT

You can adjust the brightness of the LCD screen.

### Steps

🏠 (HOME) → ⚙️ (SETTINGS) → [SOUND/DISP SET] → [LCD BRIGHT] → (darker)/  
 (brighter) → → →

### 💡 Tips

- This adjustment does not affect the recorded images in any way.

## LCD BL LEVEL (LCD back light level)

You can adjust the brightness of the LCD screen's backlight.

### Steps

🏠 (HOME) → ⚙️ (SETTINGS) → [SOUND/DISP SET] → [LCD BL LEVEL] → a desired  
setting → → →

▶ NORMAL	Standard brightness.
BRIGHT	Brightens the LCD screen.

### 🔌 Notes

- When you connect your camcorder to the wall outlet (wall socket) using the supplied AC Adaptor, [BRIGHT] is automatically selected for the setting.
- When you select [BRIGHT], battery life is slightly reduced during recording.



- If you open the LCD panel 180 degrees to face the screen outside and close the LCD panel to the camcorder body, the setting becomes [NORMAL] automatically.







 Tips

- This adjustment does not affect the recorded images in any way.

## LCD COLOR

You can adjust the color of the LCD screen.

### Steps

 (HOME) →  (SETTINGS) → [SOUND/DISP SET] → [LCD COLOR] →  (lower intensity)/ (higher intensity) →  →  → 

 Tips

- This adjustment does not affect the recorded images in any way.

# OUTPUT SETTINGS (Items for when connected to a TV)

The default settings are marked with ►.





## TV TYPE

See page 43.

## DISP OUTPUT (Display output)

You can set where the screen displays are to be output.

### Steps

🏠 (HOME) →  (SETTINGS) → [OUTPUT SETTINGS] → [DISP OUTPUT] → a desired setting →  →  → 

► LCD PANEL	Shows displays such as the time code on the LCD screen.
V-OUT/PANEL	Shows displays such as the time code on the LCD screen, and on the TV screen.

## CLOCK/ LANG (Items to set clock and language)

The default settings are marked with ▶.

### CLOCK SET

See page 19.

### AREA SET

You can adjust a time difference without stopping the clock. Set your local area when using your camcorder in other time zones. Refer to the world time difference on page 97.







#### Steps

 (HOME) →  (SETTINGS) → [CLOCK/  LANG] → [AREA SET] → set your local area using /  →  →  → 

### SUMMERTIME

You can change this setting without stopping the clock. Set to [ON] to move the time forward 1 hour.

#### Steps

 (HOME) →  (SETTINGS) → [CLOCK/  LANG] → [SUMMERTIME] → a desired setting →  →  → 

▶ OFF	Does not set the summertime.
ON	Sets the summertime.

### LANGUAGE SET

You can select the language to be used on the LCD screen.

#### Steps

 (HOME) →  (SETTINGS) → [CLOCK/  LANG] → [ LANGUAGE SET] → a desired setting →  →  → 

#### Tips

- Your camcorder offers [ENG[SIMP]] (simplified English) for when you cannot find your native tongue among the options.



# GENERAL SET (Other setup items)

The default settings are marked with ▶.

## DEMO MODE





When your camcorder is connected to a wall outlet (wall socket), a demonstration movie appear about 10 minutes after you turn on the  (Movie) lamp by pressing MODE.

### Steps

 (HOME) →  (SETTINGS) → [GENERAL SET] → [DEMO MODE] → a desired setting → 

▶ ON	The demonstration appears.
OFF	The demonstration does not appear.

### Tips

- When you set this item to [ON] and touch , the demonstration starts playing.
- The demonstration will be suspended:
  - When you press START/STOP
  - When you touch the screen during the demonstration (The demonstration starts again after about 10 minutes.)
  - When you turn on the  (Photo) lamp
  - When you press  (HOME) or  (VIEW IMAGES)





## CALIBRATION

See page 102.

### A.SHUT OFF (Auto shut off)

You can set your camcorder to turn off automatically when you do not operate your camcorder for more than about 5 minutes.

### Steps

 (HOME) →  (SETTINGS) → [GENERAL SET] → [A.SHUT OFF] → a desired setting →  →  → 

▶ 5min	The camcorder turns off automatically.
NEVER	The camcorder does not turn off automatically.

### Notes

- When you connect your camcorder to a wall outlet (wall socket), [A.SHUT OFF] is automatically set to [NEVER].

## POWER ON BY LCD

You can set your camcorder to turn on and off when you open and close the LCD screen.

### Steps

🏠 (HOME) → ⚙️ (SETTINGS) → [GENERAL SET] → [POWER ON BY LCD] → a desired setting → [OK] → [↩️] → [X]

▶ ON	The camcorder turns on and off when the LCD screen opens and closes.
OFF	The camcorder does not turn on and off when the LCD screen opens and closes.

## DROP SENSOR

Your camcorder detects that it is dropping, and protects the internal hard disk.

### Steps



🏠 (HOME) → ⚙️ (SETTINGS) → [GENERAL SET] → [DROP SENSOR] → a desired setting → [OK] → [↩️] → [X]

▶ ON	Activates the drop sensor. When it is detected that the camcorder is dropping, you may not be able to record or play back images correctly, to protect the internal hard disk. When dropping is detected, 📵 appears.
OFF (OFF)	Deactivates the drop sensor.

### 🔔 Notes

- Set the drop sensor to [ON] when you use the camcorder. Otherwise, if you drop the camcorder, you may damage the internal hard disk.
- In a non-gravity situation, the drop sensor activates. When you record images during an activity such as roller-coasting or skydiving, you can set [DROP SENSOR] to [OFF] so as not to activate the drop sensor.



# Functions set in the OPTION MENU

Items you can set only on the  OPTION MENU will be described below.  
The default settings are marked with .

## SPOT MTR/FCS

You can adjust the brightness and focus for the selected subject simultaneously. This function enables you to use [SPOT METER] (p. 78) and [SPOT FOCUS] (p. 79) at the same time.

### Steps

In recording mode,  (OPTION) →  → [SPOT MTR/FCS] → touch the subject you want to adjust the brightness and focus on → [END] → 

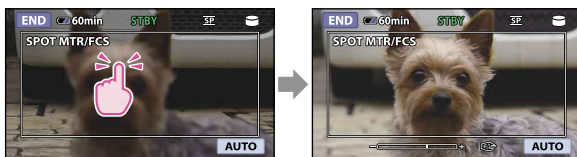

To adjust the brightness and focus automatically, touch [AUTO].



### Notes

- [EXPOSURE] and [FOCUS] are automatically set to [MANUAL].

## SPOT METER (Flexible spot meter)

You can adjust and fix the exposure to the subject, so that it is recorded in suitable brightness even when there is strong contrast between the subject and the background, such as subjects in the spotlight on stage.

### Steps

In recording mode,  (OPTION) →  → [SPOT METER] → touch the point where you want to fix and adjust the exposure on the screen → [END] → 

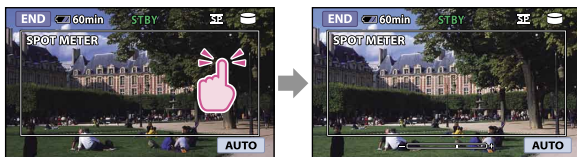

To return the setting to automatic exposure, touch [AUTO].



### Notes

- [EXPOSURE] is automatically set to [MANUAL].

## SPOT FOCUS

You can select and adjust the focal point to aim it at a subject not located at the center of the screen.

### Steps

In recording mode,  (OPTION) →  → [SPOT FOCUS] → touch the point to be focused within the frame on the screen → [END] → 

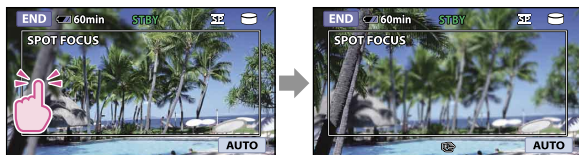

To adjust the focus automatically, touch [AUTO].



### Notes

- [FOCUS] is automatically set to [MANUAL].

## TELE MACRO

This is useful to shoot small subjects, such as flowers or insects. You can blur out backgrounds and the subject stands out clearer.

### Steps

In recording mode,  (OPTION) →  → [TELE MACRO] → a desired setting → [OK] → 

▶ OFF	Cancels TELE MACRO. (TELE MACRO is also canceled when you move the zoom lever to the W side.)	
ON (T)	The zoom (p. 32) moves to the top of the T (telephoto) side automatically and allows recording subjects at a close distance as follows: DCR-SR37E/SR38E/SR47E/SR48E/SR57E/SR67E: down to about 50 cm (19 3/4 in.) DCR-SR77E/SR87E: down to about 38 cm (15 in.)	







### Notes

- When recording a distant subject, focusing may be difficult and can take some time.
- Adjust the focus manually ([FOCUS], p. 80) when it is hard to focus automatically.

## EXPOSURE

You can fix the brightness of a picture manually. Adjust the brightness when the subject is too bright or too dark.

### Steps

In recording mode,  (OPTION) →  → [EXPOSURE] → [MANUAL] →  (darker)/  
 (brighter) →  → 









To adjust the exposure automatically, touch [AUTO].

## FOCUS

You can adjust the focus manually. You can select this function also when you want to focus on a certain subject intentionally.

### Steps

In recording mode,  (OPTION) →  → [FOCUS] → [MANUAL] →  (focusing on close subjects)/ (focusing on distant subjects) →  → 





To adjust the focus automatically, touch [AUTO].

### ⚡ Notes

- When you set [FOCUS] to [MANUAL],  appears.
- The minimum possible distance between camcorder and subject while maintaining sharp focus is about 1 cm (about 13/32 in.) for wide angle and about 150 cm (about 59 1/8 in.) (DCR-SR37E/SR38E/SR47E/SR48E/SR57E/SR67E)/80 cm (about 31 1/2 in.) (DCR-SR77E/SR87E) for telephoto.

### 💡 Tips





-  appears when the focus cannot be adjusted any closer, and  appears when the focus cannot be adjusted farther away.
- It is easier to focus on the subject by moving the power zoom lever towards T (telephoto) to adjust the focus, then towards W (wide angle) to adjust the zoom for recording. When you want to record a subject at close range, move the power zoom lever to W (wide angle), then adjust the focus.
- The focal distance information (distance at which the subject is focused on; used as a guide if it is dark and focus adjustment is difficult) appears for a few seconds in the following cases. (This information will not display correctly if a conversion lens (sold separately) is being used.)
  - When the focus mode is switched from automatic to manual
  - When you set focus manually













## SCENE SELECTION

You can record images effectively in various situations.

### Steps

In recording mode,  (OPTION) →  → [SCENE SELECTION] → a desired setting →  → 

▶ AUTO	Automatically records images effectively without the [SCENE SELECTION] function.	
TWILIGHT* (🌙)	Maintains the darkening atmosphere of the distant surroundings in twilight scenes.	
CANDLE (🕯️)	Maintains the dim atmosphere of a candlelit scene.	
SUNRISE&SUNSET* (🌅)	Reproduces the atmosphere of scenes such as sunsets or sunrises.	
FIREWORKS* (💣)	Takes spectacular shots of fireworks.	
LANDSCAPE* (🏞️)	Shoots distant subjects clearly. This setting also prevents your camcorder from focusing on glass or metal mesh in windows between the camcorder and the subject.	
PORTRAIT (Soft portrait) (👤)	Brings out the subject such as people or flowers while creating a soft background.	
SPOTLIGHT** (🎤)	Prevents people's faces from appearing excessively white when subjects are lit by strong light.	
SPORTS** (🏃)	Select to minimize shake when shooting fast moving subjects.	
BEACH** (🏖️)	Takes the vivid blue of the ocean or a lake.	
SNOW** (❄️)	Takes bright pictures of a white landscape.	

\* Adjusted to focus on subjects farther away only.

\*\* Adjusted not to focus on subjects a short distance away.





## ⚡ Notes

- If you set [SCENE SELECTION], [WHITE BAL.] setting is canceled.





## WHITE BAL. (White balance)

You can adjust the color balance to the brightness of the recording environment.





### Steps

In recording mode,  (OPTION) →  → [WHITE BAL.] → a desired setting →  → 



▶ AUTO	The white balance is adjusted automatically.
OUTDOOR 	The white balance is appropriately adjusted for the following recording conditions: <ul style="list-style-type: none"><li>– Outdoors</li><li>– Night views, neon signs and fireworks</li><li>– Sunrise or sunset</li><li>– Under daylight fluorescent lamps</li></ul>
INDOOR 	The white balance is appropriately adjusted for the following recording conditions: <ul style="list-style-type: none"><li>– Indoors</li><li>– At party scenes or studios where the lighting conditions change quickly</li><li>– Under video lamps in a studio, or under sodium lamps or incandescent-like color lamps</li></ul>
ONE PUSH 	The white balance will be adjusted according to the ambient light. <ol style="list-style-type: none"><li>① Touch [ONE PUSH].</li><li>② Frame a white object such as a piece of paper, to fill the screen under the same lighting conditions as you will shoot the subject.</li><li>③ Touch [].</li></ol>  flashes quickly. When the white balance has been adjusted and stored in the memory, the indicator stops flashing.

## ⚡ Notes

- Set [WHITE BAL.] to [AUTO] or adjust the color in [ONE PUSH] under white or cool white fluorescent lamps.
- When you select [ONE PUSH], keep framing white objects while  is flashing quickly.
-  flashes slowly if [ONE PUSH] could not be set.
- When [ONE PUSH] was selected, if  keeps flashing after touching , set [WHITE BAL.] to [AUTO].
- If you set [WHITE BAL.], [SCENE SELECTION] is set to [AUTO].





### Tips



- If you have changed the battery pack while [AUTO] was selected, or taken your camcorder outdoors after inside use (or vice versa), select [AUTO] and aim your camcorder at a nearby white object for about 10 seconds for better color balance adjustment.
- When the white balance has been set with [ONE PUSH], if the lighting conditions changed by bringing your camcorder outdoors from inside the house, or vice versa, you need to redo the [ONE PUSH] procedure to readjust the white balance.

## FADER

You can record a transition with the following effects adding to the interval between scenes. Select the desired effect in [STBY] (to fading in) or [REC] (to fading out) mode.

### Steps

In recording mode,  (OPTION) →  → [FADER] → a desired setting →  → 

▶ OFF	Does not use an effect.	
WHITE FADER	Fades in/out with the white effect.	<div style="display: flex; justify-content: space-between; align-items: center;"> <span>Out</span> <span>In</span> </div> 
BLACK FADER	Fades in/out with the black effect.	<div style="display: flex; justify-content: space-between; align-items: center;"> <span>Out</span> <span>In</span> </div> 

To cancel the fader before starting the operation, touch [OFF].





### Tips



- When you press START/STOP, the setting is cleared.

## BLT-IN ZOOM MIC (Built-in zoom microphone)

You can record a movie with directional sound as you zoom in or out.

### Steps





In recording mode,  (OPTION) →  → [BLT-IN ZOOM MIC] → a desired setting →  → 

▶ OFF	The microphone does not record sound following zooming in or out.	
ON 	The microphone records sound following zooming in or out.	

## MICREF LEVEL (Microphone reference level)

You can select the microphone level for recording sound.

### Steps





In recording mode,  (OPTION) →  → [MICREF LEVEL] → a desired setting →  → 

▶ NORMAL	Records various ambient sounds, converting them into the appropriate level.
LOW 	Records ambient sound faithfully. Select [LOW] when you want to record an exciting and powerful sound in a concert hall, etc. (This setting is not suitable for recording conversations.)

## SELF-TIMER

Press PHOTO to start the count down. A photo is recorded after about 10 seconds.

### Steps

In recording mode,  (OPTION) →  → [SELF-TIMER] → a desired setting →  → 

▶ OFF	Cancels the self-timer.
ON 	Starts the self-timer recording. To cancel the recording, touch [RESET].

## ? Troubleshooting

If you run into any problems using your camcorder, use the following list to troubleshoot the problem. If the problem persists, disconnect the power source and contact your Sony dealer.

- Overall operations/Easy Handycam operation ..... p. 85
- Batteries/power sources ..... p. 86
- LCD screen ..... p. 86
- “Memory Stick PRO Duo” media ..... p. 87
- Recording..... p. 87
- Playback ..... p. 88
- Playing back images stored on “Memory Stick PRO Duo” media on other devices..... p. 89
- Editing movies/photos on your camcorder ..... p. 89
- Connecting/Dubbing to other devices..... p. 89
- Functions that cannot be used simultaneously ..... p. 89

### Notes before sending your camcorder for repair

- Your camcorder may be required to initialize or change the current hard disk of your camcorder, depending on the problem. In the event of this, the data stored on the hard disk will be deleted. Be sure to save the data on the internal hard disk on other media (backup) before sending your camcorder for repair (p. 53, see Operating Guide too). We will not compensate you for any loss of hard disk data.
- During repair, we may check a minimum amount of data stored on the hard disk in order to investigate the problem. However, your Sony dealer will neither copy nor retain your data.

### Overall operations/Easy Handycam operation

#### The power does not turn on.

- Attach a charged battery pack to the camcorder (p. 16).
- The plug of the AC Adaptor has been disconnected from the wall outlet (wall

socket). Connect it to the wall outlet (wall socket) (p. 16).

#### The camcorder does not operate even when the power is set to on.

- It takes a few seconds for your camcorder to be ready to shoot after the power is turned on. This is not a malfunction.
- Disconnect the AC Adaptor from the wall outlet (wall socket) or remove the battery pack, then reconnect it after about 1 minute. If the functions still do not work, press RESET (p. 8) using a pointed object. (If you press RESET, all settings, including the clock setting, are reset.)
- The temperature of your camcorder is extremely high. Turn off your camcorder and leave it for a while in a cool place.
- The temperature of your camcorder is extremely low. Leave your camcorder with the power of your camcorder on. Turn off your camcorder and take it to a warm place. Leave the camcorder there for a while, then turn on your camcorder.

#### Buttons do not work.

- During Easy Handycam operation, the playback zoom (p. 40) function is not available.

#### The (OPTION) button is not displayed.

- The OPTION MENU cannot be used during Easy Handycam operation.

#### The menu settings have changed automatically.

- During Easy Handycam operation, nearly all the menu items will be automatically set to the default settings.
- Some menu items, such as [  IMAGE SIZE ], retain the settings that were made before Easy Handycam operation.
- During Easy Handycam operation, some menu items are fixed as follows.
  - [REC MODE]: [SP]
  - [DATA CODE]: [DATE/TIME]

- Some menu items retain the setting made during Easy Handycam operation even after Easy Handycam operation is finished.
- The following items return to the default settings in more than 12 hours after you close the LCD screen.
  - [DROP SENSOR]
  - [SPOT MTR/FCS]
  - [SPOT METER]
  - [SPOT FOCUS]
  - [EXPOSURE]
  - [FOCUS]
  - [SCENE SELECTION]
  - [WHITE BAL.]
  - [BLT-IN ZOOM MIC]
  - [MICREF LEVEL]
  - Back light

#### Your camcorder gets warm.

- Your camcorder may become warm during operation. This is not a malfunction.

### Batteries/power sources

#### The power abruptly turns off.

- Use the AC Adaptor.
- In the default setting, when about 5 minutes have elapsed while you do not operate your camcorder, the camcorder is automatically turned off (A.SHUT OFF). Change the setting of [A.SHUT OFF] (p. 76), or turn on the power again.
- Charge the battery pack (p. 16).

#### The CHG (charge) lamp does not light while the battery pack is being charged.

- Close the LCD screen (p. 16).
- Attach the battery pack to the camcorder correctly (p. 16).
- Connect the power cord (mains lead) to the wall outlet (wall socket) properly.
- The battery charge is completed (p. 16).

#### The CHG (charge) lamp flashes while the battery pack is being charged.

- Attach the battery pack to the camcorder correctly (p. 16). If the problem persists, disconnect the AC Adaptor from the wall outlet (wall socket) and contact your Sony dealer. The battery pack may be damaged.

#### The remaining battery time indicator does not indicate the correct time.

- The ambient temperature is too high or too low. This is not a malfunction.
- The battery pack has not been charged enough. Fully charge the battery again. If the problem persists, replace the battery pack with a new one (p. 101).
- The indicated time may not be correct depending on the environment of use.

#### The battery pack is quickly discharged.

- The ambient temperature is too high or low. This is not a malfunction.
- The battery pack has not been charged enough. Fully charge the battery again. If the problem persists, replace the battery pack with a new one (p. 101).

### LCD screen

#### Menu items are grayed out.

- You cannot select grayed items in the current recording/playback situation.
- There are some functions you cannot activate simultaneously (p. 89).

#### The buttons do not appear on the touch panel.

- Touch the LCD screen lightly.
- Press DISP (p. 34).

#### The buttons on the touch panel do not work correctly or do not work at all.

- Adjust the touch panel [CALIBRATION] (p. 102).

## “Memory Stick PRO Duo” media

Operations using the “Memory Stick PRO Duo” media cannot be performed.

- If you use “Memory Stick PRO Duo” media formatted on a computer, format it again on your camcorder (p. 62).

Images stored on the “Memory Stick PRO Duo” media cannot be deleted.

- The maximum number of images that you can delete on the index screen at one time is 100.
- You cannot delete the protected images.



The data file name is not indicated correctly or flashes.

- The file is damaged.
- The file format is not supported by your camcorder (p. 100).

## Recording

Refer also to “Memory Stick PRO Duo” media (p. 87).

Pressing START/STOP or PHOTO does not record images.

- The playback screen is displayed. Press MODE to turn on the  (Movie) or  (Photo) lamp (p. 28, 30).
- Your camcorder is recording the image you have just shot on the recording media. You cannot make new recording during this period.
- The recording media is full. Delete unnecessary images (p. 44).
- Total number of movie scenes or photos exceeds the recordable capacity of your camcorder (p. 94). Delete unnecessary images (p. 44).
- While [DROP SENSOR] is activated (p. 77), you may not record images.
- The temperature of your camcorder is extremely high. Turn off your camcorder and leave it for a while in a cool place.
- The temperature of your camcorder is extremely low. Turn off your camcorder and

take it to a warm place. Leave the camcorder there for a while, then turn on the camcorder.

The ACCESS/access lamp remains lit or flashing even if recording was stopped.

- Your camcorder is recording the scene you have just shot on the recording media.

The imaging field looks different.

- The imaging field may look different depending on the condition of your camcorder. This is not a malfunction.

The actual recording time for movies is less than the expected recording time of the recording media.

- Depending on the recording conditions, the time available for recording may be shorter, for example when recording a fast moving object, etc. (p. 94).

The camcorder stops operating.

- The temperature of your camcorder is extremely high. Turn off your camcorder and leave it for a while in a cool place.
- The temperature of your camcorder is extremely low. Turn off your camcorder and take it to a warm place. Leave the camcorder there for a while, then turn on the camcorder.
- If you keep applying vibration on the camcorder, recording may stop.

There is a time difference between the point when START/STOP is pressed and the point that the recording movie is started or stopped actually.



- On your camcorder, there may be a slight time difference between the point where you press START/STOP and the actual point that recording movie starts/stops. This is not a malfunction.

The auto focus does not function.

- Set [FOCUS] to [AUTO] (p. 80).
- The recording conditions are not suitable for auto focus. Adjust the focus manually (p. 80).

---

### SteadyShot does not function.

- Set [  STEADYSHOT ] to [ON] (p. 66).
- Even if [  STEADYSHOT ] is set to [ON], your camcorder may not be able to compensate for excessive vibrations.

---

### A vertical band appears when recording candlelight or electric light in the dark.

- This occurs when the contrast between the subject and the background is too high. This is not a malfunction.

---

### A vertical white line may appear on an image taken in bright light.

- This phenomenon is called the smear effect. This is not a malfunction.

---

### Black bands appear when you record a TV screen or computer screen.

- Set [  STEADYSHOT ] to [OFF] (p. 66).

---

### Undesirable flicker occurs.

- This occurs when recording images under a fluorescent lamp, sodium lamp, or mercury lamp. This is not a malfunction.

---



### [LCD BL LEVEL] cannot be adjusted.

- You cannot adjust [LCD BL LEVEL] when:
  - The LCD panel is closed on your camcorder with the LCD screen facing out.
  - The power is supplied from the AC Adaptor.

## Playback

---

### Images cannot be played back.

- Select the recording media you want to play back by touching  (HOME) →  (MANAGE MEDIA) → [MOVIE MEDIA SET]/[PHOTO MEDIA SET] (p. 59).

---

### Photos cannot be played back.

- Photos cannot be played back if you have modified files or folders, or have edited the data on a computer. (The file name flashes in that case.) This is not a malfunction.

- Photos recorded on other devices may not be played back. This is not a malfunction.



---

### is indicated on an image on the VISUAL INDEX screen.

- This may appear on an image recorded on other devices, edited on a computer, etc.
- You removed the AC Adaptor or the battery pack before the ACCESS/access lamp is turned off after recording. This may damage your image data and  is displayed.

---

### is indicated on an image on the VISUAL INDEX screen.

- The image data base file may be damaged. Check the data base file by touching  (HOME) →  (MANAGE MEDIA) → [REPAIR IMG.DB F.] → the recording medium. If it still appears, delete the image with  (p. 44).

---

### No sound or only a quiet sound is heard during playback.

- Turn up the volume (p. 36).
- Sound is not output when the LCD screen is closed. Open the LCD screen.
- When you record sound with [MICREF LEVEL] (p. 84) set to [LOW], the recorded sound may be difficult to hear.

---

### Left and right sound will be heard unbalanced when playing back movies on computers or other devices.

- This happens when sound recorded in 5.1ch surround is converted to 2ch (normal stereo sound) by a computer or other device. This is not a malfunction (DCR-SR57E/SR67E/SR77E/SR87E).
- Change the sound conversion type (downmix type) when playing back on 2ch stereo devices. Refer to the instruction manual supplied with your playback device for details.
- Change the sound to 2ch when creating a disc using the supplied software “PMB” (DCR-SR57E/SR67E/SR77E/SR87E).
- Record sound with [AUDIO MODE] set to [2ch STEREO] (DCR-SR57E/SR67E/SR77E/SR87E) (p. 64).



## Playing back images stored on "Memory Stick PRO Duo" media on other devices

Images cannot be played back or the "Memory Stick PRO Duo" media is not recognized.

- The device may not support "Memory Stick PRO Duo" media.

## Editing movies/photos on your camcorder

Unable to edit.

- Unable to edit because of the condition of the image.

Movies cannot be added in the Playlist.

- There is no free space in the recording media.
- You can add no more than 99 movies to a Playlist. Erase unnecessary movies from the Playlist (p. 52).
- You cannot add photos in the Playlist.

A movie cannot be divided.

- A movie that is too short cannot be divided.
- A protected movie cannot be divided.

A photo cannot be captured from a movie.

- The recording media where you want to save photos is full.

## Connecting/Dubbing to other devices

You cannot hear the sound on the TV connected to your camcorder.

- When you are using the S VIDEO plug, make sure the red and white plugs of the A/V connecting cable are connected (p. 42).

The aspect ratio of the playback is not correct when connecting your camcorder to the TV.

- Set [TV TYPE] according to your TV (p. 43).

Images are not dubbed correctly.

- The A/V connecting cable is not connected properly. Make sure to connect the cable to the input jack of another device (p. 56).

## Functions that cannot be used simultaneously

The following list shows examples of unworkable combinations of functions and menu items.

Cannot use	Because of following settings
[SCENE SELECTION]	[FADER], [TELE MACRO]
Back light	[SPOT MTR/FCS], [SPOT METER], [MANUAL] in [EXPOSURE], [FIREWORKS]

## Self-diagnosis display/Warning indicators

If indicators appear on the LCD screen, check the following.

If the problem persists even after you have tried to fix a couple of times, contact your Sony dealer or local authorized Sony service facility.

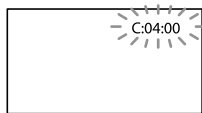

C:(or E:) □□:□□ (Self-diagnosis display)

C:04:□□

- The battery pack is not an "InfoLITHIUM" battery pack (H series). Use an "InfoLITHIUM" battery pack (H series) (p. 100).

- Connect the DC plug of the AC Adaptor to the DC IN jack of your camcorder securely (p. 16).

C:13:□□ / C:32:□□

- Remove the power source. Reconnect it and operate your camcorder again.

E:20:□□ / E:31:□□ / E:61:□□ / E:62:□□ / E:91:□□ / E:94:□□

- A malfunction that you cannot service has occurred. Contact your Sony dealer or local authorized Sony service facility. Inform them of the 5-digit code, which starts from “E.”

### 101-0001 (Warning indicator pertaining to files)

#### Slow flashing

- The file is damaged.
- The file is unreadable.

### (Warning on the hard disk of the camcorder)

#### Fast flashing

- The hard disk of the camcorder is full.
- An error may have occurred with the hard disk drive in your camcorder.

### (Battery level warning)

#### Slow flashing

- The battery pack is nearly used up.
- Depending on the operating environment or battery conditions,  may flash, even if there are about 20 minutes remaining.

### (High temperature warning)

#### Slow flashing

- The temperature of your camcorder is getting higher. Turn off your camcorder and leave it for a while in a cool place.

#### Fast flashing

- The temperature of your camcorder is extremely high. Turn off your camcorder and leave it for a while in a cool place.

### (Low temperature warning)

#### Fast flashing



- The temperature of your camcorder is extremely low. Make the camcorder warm.

### (Warning indicator pertaining to “Memory Stick PRO Duo” media)

#### Slow flashing

- Free spaces for recording images are running out. For the type of “Memory Stick” media you can use with your camcorder, see page 59.
- No “Memory Stick PRO Duo” media is inserted (p. 60).

#### Fast flashing

- There are not enough free spaces for recording images. After storing the images on other media (p. 53, see Operating Guide too), delete unnecessary images, or format the “Memory Stick PRO Duo” media (p. 62).
- The image data base file may be damaged. Check the data base file by touching  (HOME) →  (MANAGE MEDIA) → [REPAIR IMG.DB F.] → the recording medium.
- The “Memory Stick PRO Duo” media is damaged.

### (Warning indicators pertaining to “Memory Stick PRO Duo” media formatting)

- The “Memory Stick PRO Duo” media is damaged.
- The “Memory Stick PRO Duo” media is not formatted correctly (p. 62).

### (Warning indicator pertaining to incompatible “Memory Stick Duo” media)

- Incompatible “Memory Stick Duo” media are inserted (p. 59).

### (Warning indicator pertaining to the write-protect of the “Memory Stick PRO Duo” media)

- Access to the “Memory Stick PRO Duo” media was restricted on another device.

---

### (Warning indicator pertaining to camera-shake warning)

- The camcorder is unsteady, so camera-shake easily occurs. Hold the camcorder steady with both hands and record the image. However, note that the camera-shake warning indicator does not disappear.
- 

### (Warning indicator pertaining to drop sensor)

- The drop sensor function (p. 77) is activated, and has detected that the camcorder has been dropped. Therefore, the camcorder is taking steps to protect the hard disk. Recording/playback may be disabled as a result.
  - The drop sensor function does not guarantee the protection of the hard disk under all possible situations. Use the camcorder under stable conditions.
- 

### (Warning indicator pertaining to photo recording)

- The recording media is full.
- 

### Tips

- You may hear a melody when some warning indicators appear on the screen.

## Description of warning messages

If messages appear on the screen, follow the instructions.

### Recording media

---

#### HDD format error.

- The internal hard disk of the camcorder is set differently from the default format. Performing [MEDIA FORMAT] (p. 62) may enable you to use your camcorder. This will delete all data in the internal hard disk.

### Data error.

- An error occurred during reading or writing the internal hard disk of the camcorder. This may occur when you keep applying shock on the camcorder.
- 

### The Image Database File is damaged. Do you want to create a new file?

- The image management file is damaged. When you touch [YES], a new image management file is created. The old recorded images on the media cannot be played back (Image files are not damaged). If you execute [REPAIR IMG. DB F.] after creating new information, playing back the old recorded images may become possible. If it does not work, copy the image using the supplied software.
- 

### Inconsistencies found in Image Database File. Do you want to repair the Image Database File?

#### The Image Database File is damaged. Do you want to repair the Image Database File?

- The image management file is damaged, and you cannot record movies or photos. Touch [YES] to repair.
  - You can record photos on “Memory Stick PRO Duo” media.
- 

### Buffer overflow

- You cannot record because the drop sensor senses a drop of the camcorder repeatedly. If you are at risk of dropping the camcorder constantly, set [DROP SENSOR] to [OFF], and you may be able to record the image again (p. 77).

---

### Recovering data.

- Your camcorder tries to recover data automatically if the data writing was not performed properly.

---

### Cannot recover data.

- Writing data onto the recording media of the camcorder has failed. Attempts were made to recover the data, but they were unsuccessful.

---

### Reinsert the Memory Stick.

- Reinsert the “Memory Stick PRO Duo” media a few times. If even then the indicator flashes, the “Memory Stick PRO Duo” media could be damaged. Try with another “Memory Stick PRO Duo” media.

---

### This Memory Stick is not formatted correctly.

- Check the format, then format the “Memory Stick PRO Duo” media with your camcorder if necessary (p. 62).

---

### Still picture folder is full. Cannot record still pictures.

- You cannot create folders exceeding 999MSDCF. You cannot create or delete created folders using your camcorder.
- Format the “Memory Stick PRO Duo” media (p. 62), or delete folders using your computer.

---

### This Memory Stick may not be able to record or play movies.

- Use “Memory Stick” media recommended for your camcorder (p. 59).

---

### This Memory Stick may not be able to record or play images correctly.

- Use “Memory Stick” media recommended for your camcorder (p. 59).

---

### Do not eject the Memory Stick during writing. Data may be damaged.

- Reinsert the “Memory Stick PRO Duo” media, and follow the instructions on the LCD screen.

---

### Other

---

#### No further selection is possible.

- You can add no more than 99 movies to a Playlist.
- You can select 99 or only 100 images at one time for:
  - Deleting images
  - Protecting images, or releasing the protection
  - Dubbing movies
  - Copying photos
  - Editing Playlists

---

#### Data protected.

- You tried to delete protected data. Release the protection of the data.

# Recording time of movies/number of recordable photos

## Expected time of recording and playback with each battery pack

### Recording time

Approximate time available when you use a fully charged battery pack.

#### Internal hard disk

DCR-SR37E/SR38E/SR47E/SR48E/  
SR57E/SR67E:

(unit: minute)		
Battery pack	Continuous recording time	Typical recording time
NP-FH30 (supplied)	90	45
NP-FH50	145	70
NP-FH70	315	155
NP-FH100	710	355

DCR-SR77E/SR87E:

(unit: minute)		
Battery pack	Continuous recording time	Typical recording time
NP-FH50 (supplied)	130	65
NP-FH70	280	140
NP-FH100	625	310

"Memory Stick PRO Duo" media

DCR-SR37E/SR38E/SR47E/SR48E/  
SR57E/SR67E:

(unit: minute)		
Battery pack	Continuous recording time	Typical recording time
NP-FH30 (supplied)	95	45

(unit: minute)

Battery pack	Continuous recording time	Typical recording time
NP-FH50	155	70
NP-FH70	330	155
NP-FH100	745	350

DCR-SR77E/SR87E:

(unit: minute)

Battery pack	Continuous recording time	Typical recording time
NP-FH50 (supplied)	140	65
NP-FH70	300	140
NP-FH100	680	320

- Each recording time is measured when the [REC MODE] is set to SP.
- Typical recording time shows the time when you repeat recording start/stop, switching the MODE lamp, and zooming.
- Times measured when using the camcorder at 25 °C (77 °F) (10 °C to 30 °C (50 °F to 86 °F) is recommended).
- The recording and playback time will be shorter when you use your camcorder in low temperatures.
- The recording and playback time will be shorter depending on the conditions under which you use your camcorder.

### Playing time

Approximate time available when you use a fully charged battery pack.

DCR-SR37E/SR38E/SR47E/SR48E/  
SR57E/SR67E:

(unit: minute)

Battery pack	Continuous recording time
NP-FH30 (supplied)	105
NP-FH50	120
NP-FH50	170
NP-FH50	195
NP-FH70	370
NP-FH70	415

(unit: minute)

Battery pack	
NP-FH100	830
	925

**DCR-SR77E/SR87E:**

(unit: minute)

Battery pack	
NP-FH50 (supplied)	170 195
NP-FH70	370 415
NP-FH100	830 925

- Top: Internal hard disk  
Bottom: "Memory Stick PRO Duo" media

**Expected recording time of movies****Internal hard disk****DCR-SR37E/SR47E:**

(unit: hour minute)

Recording mode	Recording time
[HQ]	15 h 10 m
[SP]	21 h 50 m
[LP]	45 h 40 m

**DCR-SR38E/SR48E:**

(unit: hour minute)

Recording mode	Recording time
[HQ]	17 h 40 m
[SP]	25 h 30 m
[LP]	53 h 20 m

**DCR-SR57E/SR67E/SR77E/SR87E:**

(unit: hour minute)

Recording mode	Recording time
[HQ]	19 h 40 m
[SP]	29 h 10 m
[LP](5.1ch)*	56 h
[LP](2ch)*	61 h

\* You can change the recording sound format on [AUDIO MODE] (p. 64).

**Tips**

- You can record movies of a maximum of 9,999 scenes.
- The maximum continuous recording time of movies is approximately 13 hours.
- Your camcorder uses the VBR (Variable Bit Rate) format to automatically adjust image quality to suit the recording scene. This technology causes fluctuations in the recording time of the media. Movies containing quickly moving and complex images are recorded at a higher bit rate, and this reduces the overall recording time.

**"Memory Stick PRO Duo" media****DCR-SR37E/SR38E/SR47E/SR48E:**

(unit: minute)

	HQ	SP	LP
512MB	6 (5)	9 (5)	20 (10)
1GB	10 (10)	20 (10)	40 (25)
2GB	25 (25)	40 (25)	85 (55)
4GB	55 (50)	80 (50)	170 (110)
8GB	115 (105)	170 (105)	355 (230)
16GB	235 (210)	340 (210)	715 (460)

**DCR-SR57E/SR67E/SR77E/SR87E:**

(unit: minute)

	HQ	SP	LP (5.1ch)**	LP (2ch)**
512MB	6 (5)	9 (5)	15 (10)	20 (10)
1GB	10 (10)	20 (10)	35 (25)	40 (25)
2GB	25 (25)	40 (25)	80 (50)	85 (55)
4GB	55 (50)	80 (50)	160 (105)	170 (110)

(unit: minute)

	HQ	SP	LP (5.1ch)**	LP (2ch)**
8GB	115 (100)	170 (100)	325 (215)	355 (230)
16GB	230 (205)	340 (205)	655 (435)	715 (460)

\*\* You can change the recording sound format on [AUDIO MODE] (p. 64).

### ⚡ Notes

- Numbers in the table are based on using Sony “Memory Stick PRO Duo” media.
- The recordable time may vary depending on the recording and subject conditions, [REC MODE] (p. 64), and the type of “Memory Stick” media.
- The number in ( ) is the minimum recordable time.

## Expected number of recordable photos

### Internal hard disk

You can record the maximum 9,999 photos.

### “Memory Stick PRO Duo” media

DCR-SR37E/SR38E/SR47E/SR48E/  
SR57E/SR67E:

	VGA 640 × 480 √VGA
512MB	2800
1GB	5700
2GB	11500
4GB	23000
8GB	47000
16GB	94000

DCR-SR77E/SR87E:

	1.0M 1,152 × 864 √1.0M
512MB	870
1GB	1800

	1.0M 1,152 × 864 √1.0M
2GB	3700
4GB	7200
8GB	14500
16GB	29500

- The number of recordable photos shown is for the maximum image size of your camcorder. The actual number of recordable photos is displayed on the LCD screen during recording (p. 8).

### ⚡ Notes

- Numbers in the table are based on using Sony “Memory Stick PRO Duo” media. The number of recordable photos may vary depending on the recording conditions, and the type of “Memory Stick” media.

### 💡 Tips

- You can also use “Memory Stick Duo” media with a capacity of under 512 MB for recording photos.

# Using your camcorder abroad

## Power supply

You can use your camcorder in any countries/regions using the AC Adaptor supplied with your camcorder within the AC 100 V to 240 V, 50 Hz/60 Hz range.

## On TV color systems

Your camcorder is a PAL-system-based camcorder. If you want to view the playback image on a TV, it must be a PAL-system-based TV with an AUDIO/VIDEO input jack.

System	Used in
PAL	Australia, Austria, Belgium, China, Czech Republic, Denmark, Finland, Germany, Holland, Hong Kong, Hungary, Italy, Kuwait, Malaysia, New Zealand, Norway, Poland, Portugal, Singapore, Slovak Republic, Spain, Sweden, Switzerland, Thailand, United Kingdom, etc.
PAL-M	Brazil
PAL-N	Argentina, Paraguay, Uruguay
NTSC	Bahama Islands, Bolivia, Canada, Central America, Chile, Colombia, Ecuador, Guyana, Jamaica, Japan, Korea, Mexico, Peru, Surinam, Taiwan, the Philippines, the USA, Venezuela, etc.
SECAM	Bulgaria, France, Guiana, Iran, Iraq, Monaco, Russia, Ukraine, etc.



## Setting to the local time

You can easily set the clock to the local time by setting a time difference when using your camcorder abroad. Touch **HOME** → **SETTINGS** → **[CLOCK/ LANG]** → **[AREA SET]** and **[SUMMERTIME]** (p. 75).

## World time difference

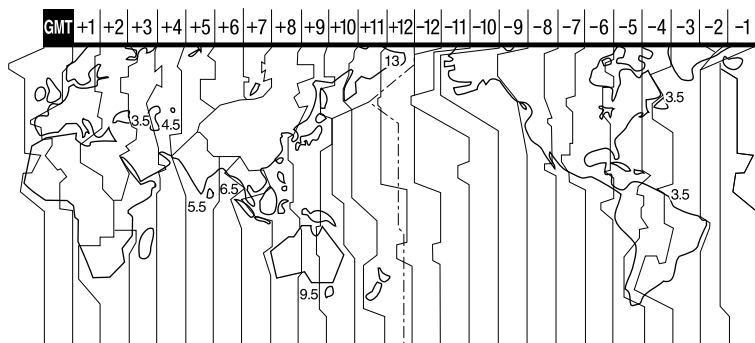

Time-zone differences	Area setting
GMT	Lisbon, London
+01:00	Berlin, Paris
+02:00	Helsinki, Cairo, Istanbul
+03:00	Moscow, Nairobi
+03:30	Tehran
+04:00	Abu Dhabi, Baku
+04:30	Kabul
+05:00	Karachi, Islamabad
+05:30	Calcutta, New Delhi
+06:00	Almaty, Dhaka
+06:30	Yangon
+07:00	Bangkok, Jakarta
+08:00	Hong Kong, Singapore, Beijing
+09:00	Seoul, Tokyo
+09:30	Adelaide, Darwin
+10:00	Melbourne, Sydney
+11:00	Solomon Is
+12:00	Fiji, Wellington, Eniwetok, Kwajalein
-11:00	Samoa
-10:00	Hawaii

Time-zone differences	Area setting
-09:00	Alaska
-08:00	Los Angeles, Tijuana
-07:00	Denver, Arizona
-06:00	Chicago, Mexico City
-05:00	New York, Bogota
-04:00	Santiago
-03:30	St. John's
-03:00	Brasilia, Montevideo
-02:00	Fernando de Noronha
-01:00	Azores, Cape Verde Is.

# File/folder structure on the internal hard disk and “Memory Stick PRO Duo” media

The file/folder structure is shown below. You do not usually need to acknowledge the file/folder structure, when recording/playing back movies and photos on the camcorder. To enjoy movies or photos by connecting your camcorder to a computer, see “PMB Guide” then use the supplied application.

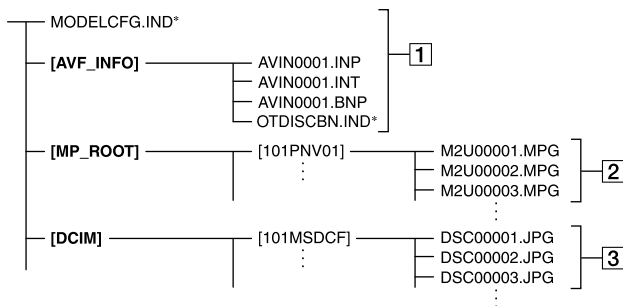

\* Only for the internal hard disk

## 1 Image management files

When you delete the files, you cannot record/play back the images correctly. The files are defaulted as hidden files and not usually displayed.

## 2 Movie files (MPEG2 files)

The extension of the files is “.MPG”. The maximum size is 2 GB. When the capacity of a file exceeds 2 GB, the file becomes divided.

The file numbers go up automatically. When the capacity of a file number exceeds 9999, another folder is created to record new movie files.

The folder name goes up: [101PNV01] → [102PNV01]

## 3 Photo files (JPEG files)

The extension of the files is “.JPG”. The file numbers go up automatically. When the capacity of a file number exceeds 9999, another folder is created to store new photo files.

The folder name goes up: [101MSDCF] → [102MSDCF]

- By setting (HOME) → (OTHERS) → [USB CONNECT] → [USB CONNECT]/ [USB CONNECT], you can access the recording media from the computer through USB connection.
- Access from the computer using the supplied software “PMB.” Do not modify the files or folders on the camcorder through the computer without using the supplied computer application. The image files may be destroyed or may not be played back.
- Operation is not guaranteed, if you perform the above operation.
- When you delete image files, follow the steps on page 44. Do not delete the image files on the camcorder directly from the computer.
- Do not format the recording media using a computer. The camcorder may not operate correctly.
- Do not copy the files on the recording media from the computer. Operation is not guaranteed.
- You cannot import data on the media of the camcorder from the computer (DCR-SR37E/SR38E/SR57E/SR77E).

# Maintenance and precautions

## About the “Memory Stick” media

“Memory Stick” media are a compact, portable IC recording medium with a large data capacity.

You can use only “Memory Stick Duo” media, which are about the half size of standard “Memory Stick” media, with your camcorder.

However, we do not guarantee the operation of all types of “Memory Stick Duo” media on your camcorder.

Types of “Memory Stick” media	Recording/Playback
“Memory Stick Duo” media (with MagicGate)	—
“Memory Stick PRO Duo” media	○
“Memory Stick PRO-HG Duo” media	○*

- \* This product does not support 8-bit parallel data transfer but it supports 4-bit parallel data transfer the same as with “Memory Stick PRO Duo” media.
- This product cannot record or play data that uses “MagicGate” technology. “MagicGate” is a copyright protection technology that records and transfers the contents in an encrypted format.
- This product is compatible with “Memory Stick Micro” media (“M2”). “M2” is the abbreviation for the “Memory Stick Micro” media.
- “Memory Stick PRO Duo” media formatted by a computer (Windows OS/Mac OS) does not have guaranteed compatibility with your camcorder.
- Data read/write speed may vary depending on the combination of the “Memory Stick PRO Duo” media and “Memory Stick PRO Duo” media compliant product you use.
- Damaged or lost data may occur in the following cases (the data will not be compensated for):
  - If you eject the “Memory Stick PRO Duo” media, or turn off your camcorder while your

camcorder is reading or writing image files on the “Memory Stick PRO Duo” media (while the ACCESS/access lamp is lit or flashing)

- If you use the “Memory Stick PRO Duo” media near magnets or magnetic fields
- It is recommended that you make a back-up of important data on the hard disk of a computer.
- Be careful not to apply excessive force when writing a memo area on “Memory Stick PRO Duo” media.
- Do not attach a label or the like on “Memory Stick PRO Duo” media or “Memory Stick Duo” media adaptor.
- When you carry or store “Memory Stick PRO Duo” media, put it in its case.
- Do not touch, or allow metallic objects to come into contact with the terminals.
- Do not bend, drop or apply strong force to the “Memory Stick PRO Duo” media.
- Do not disassemble or modify the “Memory Stick PRO Duo” media.
- Do not let the “Memory Stick PRO Duo” media get wet.
- Keep the “Memory Stick PRO Duo” media out of the reach of small children. There is danger that a child might swallow it.
- Do not insert anything other than “Memory Stick PRO Duo” media into the “Memory Stick Duo” media slot. Doing so may cause a malfunction.
- Do not use or keep the “Memory Stick PRO Duo” media in the following locations:
  - Places subject to extremely high temperature, such as a car parked outside in the summer
  - Places under direct sunlight
  - Places with extremely high humidity or subject to corrosive gases

## On the “Memory Stick Duo” media adaptor

- When using “Memory Stick PRO Duo” media with “Memory Stick” media compliant device, be sure to insert the “Memory Stick PRO Duo” media into “Memory Stick Duo” media adaptor.
- When using “Memory Stick PRO Duo” media with “Memory Stick” media compliant device inserting “Memory Stick PRO Duo” media into “Memory Stick Duo” media adaptor, make sure the “Memory Stick PRO Duo” media are inserted facing in the correct direction. Note that improper use may cause a malfunction.

- When using “Memory Stick PRO Duo” media inserted into “Memory Stick Duo” media adaptor on “Memory Stick” media compliant device, make sure the “Memory Stick PRO Duo” media adaptor is inserted into the device in the correct direction. If inserted in the wrong direction, the device may be damaged.
- Do not insert “Memory Stick Duo” media adaptor without “Memory Stick PRO Duo” media attached into “Memory Stick” media compliant device. Doing so may result in malfunctions of the device.

### On “Memory Stick PRO Duo” media

- The maximum memory capacity of “Memory Stick PRO Duo” media that can be used with your camcorder is 16 GB.

### Notes on using “Memory Stick Micro” media

- To use “Memory Stick Micro” media with your camcorder, you need a Duo-sized M2 Adaptor. Insert the “Memory Stick Micro” media into the Duo-sized M2 Adaptor, and then insert the adaptor into the “Memory Stick Duo” media slot. If you insert a “Memory Stick Micro” media into your camcorder without using a Duo-sized M2 Adaptor, you might not be able to remove it from your camcorder.
- Do not leave the “Memory Stick Micro” media within the reach of small children. They might accidentally swallow it.

### On image data compatibility

- Image data files recorded on “Memory Stick PRO Duo” media by your camcorder conform to the “Design rule for Camera File system” universal standard established by the JEITA (Japan Electronics and Information Technology Industries Association).
- On your camcorder, you cannot play back photos recorded on other devices (DCR-TRV900E or DSC-D700/D770) that do not conform to the universal standard. (These models are not sold in some regions.)
- If you cannot use “Memory Stick PRO Duo” media that have been used with another device, format it with your camcorder (p. 62). Note that formatting erases all information on the “Memory Stick PRO Duo” media.
- You may not be able to play back images with

your camcorder:

- When playing back image data modified on your computer
- When playing back image data recorded with other devices

### About the “InfoLITHIUM” battery pack

Your camcorder operates only with an “InfoLITHIUM” battery pack (H series). “InfoLITHIUM” H series battery packs have the  mark.

### What is an “InfoLITHIUM” battery pack?

- An “InfoLITHIUM” battery pack is a lithium-ion battery pack that has functions for communicating information related to operating conditions between your camcorder and an AC Adaptor/charger (sold separately).
- The “InfoLITHIUM” battery pack calculates the power consumption according to the operating conditions of your camcorder, and displays the remaining battery time in minutes.
- The battery pack NP-FH50 supplied with DCR-SR77E/SR87E is compatible with “ActiFORCE.” “ActiFORCE” is a new generation power system. Battery capacity, boost charge, and the speed and accuracy of battery time remaining calculations have been improved when compared with current “InfoLITHIUM” P-series batteries.

### To charge the battery pack

- Be sure to charge the battery pack before you start using your camcorder.
- We recommend charging the battery pack in an ambient temperature of between 10 °C to 30 °C (50 °F to 86 °F) until the CHG (charge) lamp turns off. If you charge the battery pack outside of this temperature range, you may not be able to charge it efficiently.

### To use the battery pack effectively



- Battery pack performance decreases when the ambient temperature is 10 °C (50 °F) or below, and the length of time you can use the battery pack becomes shorter. In that case, do one of the following to use the battery pack for a longer time.

- Put the battery pack in a pocket to warm it up, and install it on your camcorder right before you start taking shots.
- Use a large capacity battery pack: NP-FH70/FH100 (sold separately).
- Frequent use of the LCD screen or a frequent playback, fast forward or reverse operation wears out the battery pack faster. We recommend using a large capacity battery pack: NP-FH70/FH100 (sold separately).
- Be sure to close the LCD screen when not recording or playing back on your camcorder. The battery pack is also consumed when your camcorder is in recording standby or playback pause.
- Have spare battery packs ready for 2 or 3 times the expected recording time, and make trial recordings before making the actual recording.
- Do not expose the battery pack to water. The battery pack is not water resistant.

### About the remaining battery time indicator

- When the power goes off even though the remaining battery time indicator indicates that the battery pack has enough power to operate, charge the battery pack fully again. Remaining battery time will be indicated correctly. Note, however, that the battery indication will not be restored if it is used in high temperatures for a long time, or if left in a fully charged state, or when the battery pack is frequently used. Use the remaining battery time indication as a rough guide only.
- The  mark that indicates low battery flashes even if there are still 20 minutes of battery time remaining, depending on the operating conditions or ambient temperature.

### About storage of the battery pack

- If the battery pack is not used for a long time, fully charge the battery pack and use it up on your camcorder once a year to maintain proper function. To store the battery pack, remove it from your camcorder and put it in a dry, cool place.
- To discharge the battery pack on your camcorder completely, touch  (HOME) →  (SETTINGS) → [GENERAL SET] → [A.SHUT OFF] → [NEVER], and leave your camcorder in recording standby until the power goes off (p. 76).

### About battery life

- Battery capacity decreases over time and through repeated use. If decreased usage time between charges becomes significant, it is probably time to replace it with a new one.
- Each battery's life is governed by storage, operating and environmental conditions.

### About handling of your camcorder

#### On use and care

- Do not use or store the camcorder and accessories in the following locations:
  - Anywhere extremely hot, cold or humid. Never leave them exposed to temperatures above 60 °C (140 °F), such as under direct sunlight, near heaters or in a car parked in the sun. They may malfunction or become deformed.
  - Near strong magnetic fields or mechanical vibration. The camcorder may malfunction.
  - Near strong radio waves or radiation. The camcorder may not be able to record properly.
  - Near AM receivers and video equipment. Noise may occur.
  - On a sandy beach or anywhere dusty. If sand or dust gets in your camcorder, it may malfunction. Sometimes this malfunction cannot be repaired.
  - Near windows or outdoors, where the LCD screen, or the lens may be exposed to direct sunlight. This damages the LCD screen.
- Operate your camcorder on DC 6.8 V/7.2 V (battery pack) or DC 8.4 V (AC Adaptor).
- For DC or AC operation, use the accessories recommended in these operating instructions.
- Do not let your camcorder get wet, for example, from rain or sea water. If your camcorder gets wet, it may malfunction. Sometimes this malfunction cannot be repaired.
- If any solid object or liquid gets inside the casing, unplug your camcorder and have it checked by a Sony dealer before operating it any further.
- Avoid rough handling, disassembling, modifying, physical shock, or impact such as hammering, dropping or stepping on the product. Be particularly careful of the lens.
- Keep the LCD screen closed when you are not using your camcorder.

- Do not wrap your camcorder with a towel, for example, and operate it. Doing so might cause heat to build up inside.
- When disconnecting the power cord (mains lead), pull it by the plug and not the cord.
- Do not damage the power cord (mains lead) such as by placing anything heavy on it.
- Do not use a deformed or damaged battery pack.
- Keep metal contacts clean.
- If the battery electrolytic liquid has leaked:
  - Consult your local authorized Sony service facility.
  - Wash off any liquid that may have contacted your skin.
  - If any liquid gets in your eyes, wash with plenty of water and consult a doctor.

### When not using your camcorder for a long time

- To keep your camcorder in optimum state for a long time, turn it on and let it run by recording and playing back images about once a month.
- Use up the battery pack completely before storing it.

### Moisture condensation

If your camcorder is brought directly from a cold place to a warm place, moisture may condense inside your camcorder. This may cause a malfunction to your camcorder.

- If moisture condensation has occurred
  - Leave your camcorder for about 1 hour without turning it on.
- Note on moisture condensation
  - Moisture may condense when you bring your camcorder from a cold place into a warm place (or vice versa) or when you use your camcorder in a humid place as follows:
    - You bring your camcorder from a ski slope into a place warmed up by a heating device.
    - You bring your camcorder from an air conditioned car or room into a hot place outside.
    - You use your camcorder after a squall or a shower.
    - You use your camcorder in a hot and humid place.

- How to prevent moisture condensation
  - When you bring your camcorder from a cold place into a warm place, put your camcorder in a plastic bag and seal it tightly. Remove the bag when the air temperature inside the plastic bag has reached the surrounding temperature (after about 1 hour).

### LCD screen



- Do not exert excessive pressure on the LCD screen, as it may cause uneven color and other damage.
- If your camcorder is used in a cold place, a residual image may appear on the LCD screen. This is not a malfunction.
- While using your camcorder, the back of the LCD screen may heat up. This is not a malfunction.

### To clean the LCD screen

- If fingerprints or dust make the LCD screen dirty, it is recommended that you use a soft cloth to clean it.
- When you use the LCD Cleaning Kit (sold separately), do not apply the cleaning liquid directly to the LCD screen. Use cleaning paper moistened with the liquid.

### On adjustment of the touch panel (CALIBRATION)

The buttons on the touch panel may not work correctly. If this happens, follow the procedure below. It is recommended that you connect your camcorder to the wall outlet (wall socket) using the supplied AC Adaptor during the operation.

- ① Touch  (HOME) →  (SETTINGS) → [GENERAL SET] → [CALIBRATION].

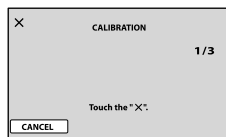

- ② Touch “X” displayed on the screen with the corner of “Memory Stick PRO Duo” media or the like 3 times.  
Touch [CANCEL] to cancel calibration.

## ⚡ Notes

- If you did not press the right spot, try the calibration again.
- Do not use a sharp-pointed object for calibration. Doing so may damage the LCD screen.
- You cannot calibrate the LCD screen if it is rotated, or closed with the screen facing out.

## On handling the casing

- If the casing is soiled, clean the camcorder body with a soft cloth lightly moistened with water, and then wipe the casing with a dry soft cloth.
- Avoid the following to avoid damage to the finish:
  - Using chemicals such as thinner, benzene, alcohol, chemical cloths, repellent, insecticide and sunscreen
  - Handling the camcorder with above substances on your hands
  - Leaving the casing in contact with rubber or vinyl objects for a long period of time

## About care and storage of the lens

- Wipe the surface of the lens clean with a soft cloth in the following instances:
  - When there are fingerprints on the lens surface
  - In hot or humid locations
  - When the lens is exposed to salty air such as at the seaside
- Store in a well-ventilated location subject to little dirt or dust.
- To prevent mold, periodically clean the lens as described above.

## On charging the pre-installed rechargeable battery

Your camcorder has a pre-installed rechargeable battery to retain the date, time, and other settings even when the LCD screen is closed. The pre-installed rechargeable battery is always charged while your camcorder is connected to the wall outlet (wall socket) via the AC Adaptor or while the battery pack is attached. The rechargeable battery will be fully discharged in about 3 months if you do not use your camcorder at all. Use your camcorder after charging the pre-installed rechargeable battery.

However, even if the pre-installed rechargeable battery is not charged, the camcorder operation

will not be affected as long as you are not recording the date.

## How to charge the pre-installed rechargeable battery

Connect your camcorder to a wall outlet (wall socket) using the supplied AC Adaptor, and leave it with the LCD screen closed for more than 24 hours.

## Note on disposal/transfer of the “Memory Stick PRO Duo” media

Even if you delete data in the “Memory Stick PRO Duo” media or format the “Memory Stick PRO Duo” media on your camcorder or a computer, you may not delete data from the “Memory Stick PRO Duo” media completely. When you give the “Memory Stick PRO Duo” media to somebody, it is recommended that you delete data completely using data deletion software on a computer. Also, when you dispose of the “Memory Stick PRO Duo” media, it is recommended that you destroy the actual body of the “Memory Stick PRO Duo” media.

## On trademarks

- “Handycam” and **HANDYCAM** are registered trademarks of Sony Corporation.
- “Memory Stick,” “**MS**,” “Memory Stick Duo,” “**MEMORY STICK DUO**,” “Memory Stick PRO Duo,” “**MEMORY STICK PRO DUO**,” “Memory Stick PRO-HG Duo,” “**MEMORY STICK PRO-HG DUO**,” “Memory Stick Micro,” “MagicGate,” “**MAGICGATE**,” “MagicGate Memory Stick” and “MagicGate Memory Stick Duo” are trademarks or registered trademarks of Sony Corporation.
- “InfoLITHIUM” is a trademark of Sony Corporation.
- “DVDirect” is a trademark of Sony Corporation.
- Dolby and the double-D symbol are trademarks of Dolby Laboratories.
- Microsoft, Windows, Windows Media, Windows Vista, and DirectX are either registered trademarks or trademarks of Microsoft Corporation in the United States and/or other countries.
- Macintosh and Mac OS are registered trademarks of Apple Inc. in the U.S. and other countries.
- Intel, Intel Core, and Pentium are trademarks or registered trademarks of Intel Corporation or its subsidiaries in the United States and other countries.
- Adobe, the Adobe logo, and Adobe Acrobat are either registered trademarks or trademarks of Adobe Systems Incorporated in the United States and/or other countries.

All other product names mentioned herein may be the trademarks or registered trademarks of their respective companies. Furthermore, <sup>TM</sup> and © are not mentioned in each case in this Handbook.

## Notes on the License

ANY USE OF THIS PRODUCT OTHER THAN CONSUMER PERSONAL USE IN ANY MANNER THAT COMPLIES WITH THE MPEG-2 STANDARD FOR ENCODING VIDEO INFORMATION FOR PACKAGED MEDIA IS EXPRESSLY PROHIBITED WITHOUT A LICENSE UNDER APPLICABLE PATENTS IN THE MPEG-2 PATENT PORTFOLIO, WHICH LICENSE IS AVAILABLE FROM MPEG LA, L.L.C., 250 STEELE STREET, SUITE 300, DENVER, COLORADO 80206.

“C Library,” “Expat,” “zlib,” and “libjpeg” software are provided in your camcorder. We provide this software based on license agreements with their owners of copyright. Based on requests by the owners of copyright of these software applications, we have an obligation to inform you of the following. Please read the following sections.

Read “license1.pdf” in the “License” folder on the CD-ROM. You will find licenses (in English) of “C Library,” “Expat,” “zlib,” and “libjpeg” software.

### On GNU GPL/LGPL applied software

The software that is eligible for the following GNU General Public License (hereinafter referred to as “GPL”) or GNU Lesser General Public License (hereinafter referred to as “LGPL”) are included in the camcorder.

This informs you that you have a right to have access to, modify, and redistribute source code for these software programs under the conditions of the supplied GPL/LGPL.

Source code is provided on the web. Use the following URL to download it. When downloading the source code, select DCR-SR87 as the model for your camcorder.

<http://www.sony.net/Products/Linux/>

We would prefer you do not contact us about the contents of source code.

Read “license2.pdf” in the “License” folder on the CD-ROM. You will find licenses (in English) of “GPL,” and “LGPL” software.

To view the PDF, Adobe Reader is needed. If it is not installed on your computer, you can download it from the Adobe Systems web page: <http://www.adobe.com/>



# Index

## Symbols

16:9 .....	43, 65
4:3 .....	43, 65
5.1ch surround recording.....	33

## A

A.SHUT OFF .....	76
A/V connecting cable.....	56
Abroad .....	96
Altitude .....	14
AREA SET .....	75
AUDIO MODE.....	64
AUTO SLW SHUTTR .....	66, 69

## B

BATTERY INFO.....	58
Battery pack.....	16
BEACH .....	81
BEEP.....	72
BLACK FADER .....	83
BLT-IN ZOOM MIC.....	83

## C

CALIBRATION .....	102
CAMERA DATA .....	70
CANDLE .....	81
Capturing a photo from a movie.....	46
Charging the battery pack.....	16
Charging the battery pack abroad .....	17, 96
CLOCK/LANG.....	75
CLOCK SET.....	19, 75
Copy .....	48
Creating a disc .....	53

## D

DATA CODE .....	70
DATE/TIME.....	19, 70
Date Index .....	39
DELETE.....	44
Deleting data .....	44, 62
DEMO MODE.....	76
DIGITAL ZOOM .....	65
DISC BURN .....	11

Disc recorder.....	56
DISP OUTPUT .....	74
DIVIDE.....	50
DROP SENSOR.....	77
Dubbing.....	47
DVD writer.....	55

## E

Easy Handycam Operation .....	22
EDIT.....	50
Empty .....	63
EXPOSURE.....	80

## F

Face Index.....	38
FACE SET .....	67
FADER .....	83
File .....	98
FILE NO.....	68
Film Roll Index .....	38
FIREWORKS .....	81
FOCUS.....	80
Folder .....	98
Format.....	62

## G

GENERAL SET .....	76
GUIDEFRA.....	66, 69

## H

HELP function .....	10
High altitude .....	14
HOME MENU .....	10, 11
HQ.....	64

## I

Image management file.....	98
IMAGE SIZE.....	68
INDOOR.....	82
"InfoLITHIUM" battery pack .....	100
Internal hard disk .....	98

## J

JPEG.....	98
-----------	----

## L

LANDSCAPE.....	81
LANGUAGE SET .....	20, 75
LCD BL LEVEL .....	72
LCD BRIGHT .....	72
LCD COLOR.....	73
LP.....	64

## M

Maintenance.....	99
MANAGE MEDIA .....	59
MEDIA FORMAT .....	62
MEDIA INFO .....	61
"Memory Stick" media.....	59, 99
"Memory Stick PRO-HG Duo" media.....	60, 99
"Memory Stick PRO Duo" media .....	59, 60, 98
Menus.....	10
MICREF LEVEL .....	84
Mirror mode .....	34
Moisture condensation .....	102
MOVIE DUB .....	47
MOVIE MEDIA SET .....	59
Movies .....	25, 28, 35
MOVIE SETTINGS .....	64
MPEG 2 .....	98

## N

Notes on using the Hard Disk Drive Handycam.....	14
---	----

## O

ONE PUSH .....	82
OPTION MENU .....	10, 12, 78
original.....	47
OTHERS.....	44
OUTDOOR.....	82
OUTPUT SETTINGS .....	74

## P

PAL.....	96
PB zoom.....	40

PHOTO CAPTURE.....	46
PHOTO COPY.....	48
PHOTO MEDIA SET.....	59
Photos.....	26, 30, 36
PHOTO SETTINGS.....	68
Playing.....	25, 35
Playlist.....	51
PMB Guide.....	2
PORTRAIT.....	81
Power on.....	19
POWER ON BY LCD.....	77
Precautions.....	99
PROTECT.....	49

## R

REC MODE.....	64
Recording.....	28
Recording and playback time ...	93
Recording media.....	59
Recording time of movies/ number of recordable photos...	93
REMAINING SET.....	67
Repair.....	85
REPAIR IMG.DB F.....	88, 90
RESET.....	8

## S

SCENE SELECTION.....	81
Screen indicators.....	8
Self-diagnosis display/Warning indicators.....	89
SELF-TIMER.....	84
Shooting.....	30
Slide show.....	41
SLIDE SHOW SET.....	41
SNOW.....	81
SOUND/DISP SET.....	72
SP.....	64
SPORTS.....	81
SPOT FOCUS.....	79
SPOTLIGHT.....	81
SPOT METER.....	78
SPOT MTR/FCS.....	78
STEADYSHOT.....	66

SUMMERTIME.....	75
SUNRISE&SUNSET.....	81
Supplied items.....	13

## T

TELE MACRO.....	79
Telephoto.....	32
Thumbnail.....	44
Tripod.....	7
Troubleshooting.....	85
TV.....	42
TV color systems.....	96
TV TYPE.....	74
TWILIGHT.....	81

## U

USB cable.....	55
USB CONNECT.....	55

## V

VBR.....	94
VIEW IMAGES SET.....	70
Viewing.....	26, 36
VISUAL INDEX.....	25, 35
Volume.....	36

## W

Warning messages.....	91
WHITE BAL.....	82
WHITE FADER.....	83
Wide angle.....	32
WIDE SELECT.....	65

## Z

Zoom.....	32, 40
-----------	--------

Additional information on this product and answers to frequently asked questions can be found at our Customer Support Website.

<http://www.sony.net/>