

SONY®

Digital Video Camera Recorder

HANDYCAM®

Handycam Handbook

**DCR-SR30E/SR40E/SR50E/
SR60E/SR70E/SR80E**

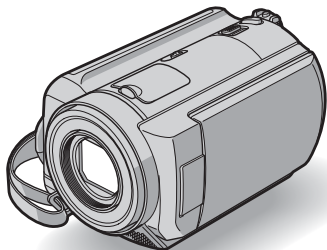

2-698-884-11(1)



Enjoying with
your Hard Disk
Drive Handycam 10

Getting Started 13



Easy
Handycam 24



Recording
/Playback 29

Using the Setup items 44

Editing images 63

Dubbing, Printing 67

Performing with
a computer 74

Troubleshooting 98

Additional Information 114

Glossary, Index 121



© 2006 Sony Corporation

Read this first

Before operating the unit, please read this Handbook thoroughly, and retain it for future reference.

WARNING

To reduce fire or shock hazard, do not expose the unit to rain or moisture.

CAUTION

Replace the battery with the specified type only. Otherwise, fire or injury may result.

FOR CUSTOMERS IN THE UNITED KINGDOM

NOTICE ON THE SUPPLIED AC ADAPTOR

A moulded plug complying with BS1363 is fitted to this equipment for your safety and convenience.

Should the fuse in the plug supplied need to be replaced, a fuse of the same rating as the supplied one and approved by ASTA or BSI to BS1362 (i.e., marked with \diamond or \heartsuit mark) must be used. If the plug supplied with this equipment has a detachable fuse cover, be sure to attach the fuse cover after you change the fuse. Never use the plug without the fuse cover.

If you should lose the fuse cover, please contact your nearest Sony service station.

FOR CUSTOMERS IN EUROPE

ATTENTION

The electromagnetic fields at the specific frequencies may influence the picture and sound of this camcorder.

This product has been tested and found compliant with the limits set out in the EMC Directive for using connection cables shorter than 3 meters. (9.8 feet)



Disposal of Old Electrical & Electronic Equipment (Applicable in the European Union and other European countries with separate collection systems)

This symbol on the product or on its packaging indicates that this product shall not be treated as household waste. Instead it shall be handed over to the applicable collection point for the recycling of electrical and electronic equipment.

By ensuring this product is disposed of correctly, you will help prevent potential negative consequences for the environment and human health, which could otherwise be caused by inappropriate waste handling of this product. The recycling of materials will help to conserve natural resources.

For more detailed information about recycling of this product, please contact your local Civic Office, your household waste disposal service or the shop where you purchased the product.

Applicable Accessories: Remote Commander (DCR-SR50E/SR60E/SR70E/SR80E)

Notice

If static electricity or electromagnetism causes data transfer to discontinue midway (fail), restart the application or disconnect and connect the USB cable again.

Notes on use

Your camcorder is supplied with two kinds of operations guides.

For operating and handling the camcorder, refer to “Operating Guide” and “Handycam Handbook” (PDF/this Handbook).

On using the camcorder

- Do not hold the camcorder by the following parts.



LCD screen

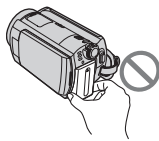

Battery

- The camcorder is not dust proofed, drip proofed or waterproofed. See “Maintenance and precautions” (p.118).
- To prevent the hard disk from being broken or recorded images from being lost, do not do the followings when either of the respective lamps of the POWER switch (p.18) or the ACCESS lamp (p.25, 27, 29) is on:
 - Removing the battery pack or AC Adaptor from the camcorder
 - Applying mechanical shock or vibration to the camcorder
- Before connecting your camcorder to another device with a USB cable etc., be sure to insert the connector plug in the proper direction. If you insert the connector plug forcibly in the wrong direction, the terminal may be damaged, or this may cause a malfunction of your camcorder.
- Disconnect the AC Adaptor from the Handycam Station holding both the camcorder and the DC plug.
- Be sure to slide the POWER switch up to OFF (CHG), when you set the camcorder onto the Handycam Station or remove the camcorder from it.

Notes on the Setup items, LCD screen and lens

- A setup item that is grayed out is not available under the current recording or playback conditions.
- The LCD screen is manufactured using extremely high-precision technology, so over 99.99% of the pixels are operational for effective use. However, there may be some tiny black points and/or bright points (white, red, blue, or green in color) that appear constantly on the LCD screen. These points are normal.

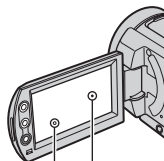

Black point
White, red, blue or green point

- Exposing the LCD screen or the lens to direct sunlight for long periods of time may cause malfunctions. Be careful when placing the camera near a window or outdoors.
- Do not aim at the sun. Doing so might cause your camcorder to malfunction. Take images of the sun only in low light conditions, such as at dusk.

On recording

- Before starting to record, test the recording function to make sure the image and sound are recorded without any problems.
- Compensation for the contents of recordings cannot be provided, even if recording or playback is not possible due to a malfunction of the camcorder.
- TV color systems differ depending on the countries/regions. To view your recordings on a TV, you need a PAL system-based TV.

- Television programs, films, video tapes, and other materials may be copyrighted. Unauthorized recording of such materials may be contrary to the copyright laws. You cannot dub copyright protected software on your camcorder.

Compatibility of images

- You cannot play back both movies and still images other than the images recorded with your camcorder. You also cannot play back images recorded with other DCR-SR30E/SR40E/SR50E/SR60E/SR70E/SR80E.

On this Handbook

- The images of the LCD screen used on this Handbook are captured using a digital still camera, and thus may appear different from what you see.
- Design and specifications of this camcorder and accessories are subject to change without notice.
- The illustrations used on this Handbook are based on the model DCR-SR80E.
- The on-screen displays in each local language are used for illustrating the operating procedures. Change the screen language before using your camcorder if necessary (p.60).

About the Carl Zeiss lens

Your camcorder is equipped with a Carl Zeiss lens, which was developed jointly by Carl Zeiss, in Germany, and Sony Corporation, and produces superior images.

It adopts the MTF* measurement system for video cameras and offers a quality typical of a Carl Zeiss lens.

- * MTF stands for Modulation Transfer Function. The number value indicates the amount of light from a subject coming into the lens.

Notes on using the Hard Disk Drive Handycam

Save all your recorded image data

- In the case of your image data being damaged, save all your recorded images. It is recommended that you save the image data on a DVD using your computer (p.80, 93). Also, you can save it using VCR/DVD device (p.67).
- It is recommended that you save your image data periodically after recording.

Do not apply shock or vibration to your camcorder

- The hard disk of the camcorder may not be recognized, or recording or playback may not be possible.
- Especially, during recording/playback, do not apply shock. After recording, do not apply vibration or shock to the camcorder, while the ACCESS lamp is lit.
- While using the shoulder belt (not supplied), do not crash the camera against a subject.

On the drop sensor

- To protect the internal hard disk from the shock by dropping, the camcorder has the drop sensor function (p.56). When a drop occurs, or under a non-gravity condition, the block noise to protect the camcorder may also be recorded. If the drop sensor catches a drop repeatedly, recording/playback may be stopped.

Notes on Battery Pack/AC Adaptor

- While the ACCESS lamp is lit, be sure to avoid the followings. They may cause malfunctions.
 - Removing the battery pack
 - Removing the AC Adaptor (while charging using the AC Adaptor)
- Be sure to remove the battery pack or the AC Adaptor after turning off the POWER switch.

Note on operational temperatures

- When the temperature of the camcorder becomes extremely high or extremely low, you may not record or playback the camcorder to provide protection to the camcorder. In case of this, a message appears on the LCD screen (p.111).

Note on connecting the camcorder to a computer

- Do not format the hard disk of the camcorder using the computer. It may not operate correctly.

Note on using the camcorder in highlands

- Do not turn on the camcorder in a low-pressure area, where its altitude is more than 3,000 meters (9,800 feet). This may damage the hard disk drive of your camcorder.

Note on disposal/transfer

- If you perform [HDD FORMAT] (p.55) or formatting the camcorder, you may not delete data from the hard disk completely. When you transfer the camcorder, it is recommended that you perform [EMPTY HDD] (p.56) to make it difficult to recover your data. In addition to the above, when you dispose of the camcorder, it is recommended that you destroy the actual body of the camcorder. This may prevent data recovery on the hard disk of the camcorder.

If you cannot record/play back images, perform [HDD FORMAT]

- If you repeat recording/deleting images for a long time, fragmentation occurs. Images cannot be saved/recorded. In such case, save the images to perform [HDD FORMAT] (p.55).
Fragmentation  Glossary (p.121)

Table of Contents

Read this first.....	2
Notes on using the Hard Disk Drive Handycam.....	5



Enjoying with your Hard Disk Drive Handycam

What you can do with your Hard Disk Drive Handycam	10
Using your Hard Disk Drive Handycam	12

Getting Started

Step 1: Checking supplied items.....	13
Step 2: Charging the battery pack	14
Step 3: Turning the power on and holding your camcorder	18
Step 4: Adjusting the LCD screen.....	20
Step 5: Using the touch panel.....	21
Step 6: Setting the date and time.....	22
Step 7: Selecting the aspect ratio (16:9 or 4:3) of the recording image (DCR-SR50E/SR60E/SR70E/SR80E)	23



Easy Handycam - using your camcorder with automatic settings

Using Easy Handycam operation.....	24
Recording with ease	25
Playback with ease	27



Recording/Playback

Recording.....	29
Playback	30
Searching for desired images by date (Date Index)	31
Functions used for recording/playback, etc.	32

Recording

- To use zoom
- To record in dark places (NightShot plus)
- To adjust the exposure for backlit subjects (BACK LIGHT)
- To adjust the focus for an off center subject

- To fix the exposure for the selected subject
- To add special effects
- To record in mirror mode
- To use a tripod
- To attach the shoulder belt

Playback







- To play back a series of still images (Slide show)
- To use Playback zoom

Recording/playback

- To check the remaining battery
- To check available free hard disk space
- To turn off the operation confirmation beep
- To initialize the settings (Reset)
- Other part names and functions

Checking/Deleting the last scene (Review/Review deleting)	35
Indicators displayed during recording/playback	36
Remote Commander (DCR-SR50E/SR60E/SR70E/SR80E)	38
Playing the image on a TV	39
Saving images	41
Deleting images	42

Using the Setup items

Using the Setup items	44
Setup items	46
 CAMERA SET	48
Settings to adjust your camcorder to the recording conditions (EXPOSURE/WHITE BAL./STEADYSHOT, etc.)	
 STILL SET	53
Settings for still images (BURST/QUALITY/IMAGE SIZE, etc.)	
 PICT.APPLI	54
Special effects on images or additional functions on recording/playback (PICT.EFFECT/D.EFFECT, etc.)	
 HDD SET	55
Settings for the hard disk (HDD FORMAT/HDD INFO, etc.)	
 STANDARD SET	57
Settings while recording or other basic settings (REC MODE/LCD SET/USB SPEED, etc.)	
 TIME/LANGU	60
(CLOCK SET/AREA SET/LANGUAGE, etc.)	
Customizing Personal Menu	61

Editing images

Creating the Playlist	63
Playing the Playlist.....	65
Setting image protection (Protection).....	65

Dubbing, Printing

Dubbing to VCR/DVD devices	67
Recording images from a TV or VCR/DVD device (DCR-SR60E/SR80E).....	69
Printing recorded still images (PictBridge compliant printer)	71
Jacks to connect external devices	73

Performing with a computer

What you can do with the camcorder by connecting to your computer	74
System requirements.....	75
Installing software	77
Creating a DVD with One Touch.....	80
Copying images to a computer	84
Viewing copied images on a computer	89
Editing images	91
Creating a DVD with selected images	93
Saving images in the Playlist to a DVD.....	95
Deleting image data from a computer.....	97

Troubleshooting

Troubleshooting	98
Warning indicators and messages.....	110

Additional Information

Using your camcorder abroad.....	114
Files on the camcorder hard disk/folder structure.....	116
About the “InfoLITHIUM” battery pack	117
Maintenance and precautions.....	118

Glossary, Index

Glossary	121
Index.....	123



Enjoying with your Hard Disk Drive Handycam

What you can do with your Hard Disk Drive Handycam

You can record images to the hard disk of the camcorder. Hard Disk Drive Handycam offers more options than the tape or the DVD camcorder for your convenience and entertainment.

“Recording and viewing” : clear, easy and convenient

Recording onto the hard disk for long hours (p.25, 29)

You can record more than seven hours* when the image is set to high quality ([HQ]) onto the hard disk. All the recorded images are saved on the free hard disk space. You are not at a risk to write images onto your favorite images by mistake.

Also, you do not need to rewind or fast-forward your movie, and you can start recording whenever you are ready.

* You can record more than 14 hours when you use DCR-SR70E/SR80E. If you change the image quality of a movie, you can record images for longer hours.



You can find a scene quickly by using the VISUAL INDEX screen (p.27, 30).

The VISUAL INDEX screen allows you to check recorded images at a glance. All you have to do is to touch the scene you want to view.

Also, you can search for a desired scene by date using Date Index.

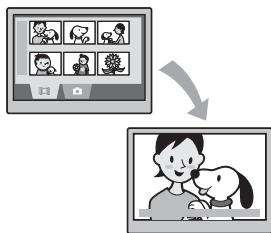

Viewing on a TV or saving to VCR/DVD devices (p.39, 67)

You can connect your Handycam directly to a TV to play back recorded images. Also, you can save them to VCR/DVD devices.



Connecting Hard Disk Drive Handycam to a computer

The supplied software “ImageMixer for HDD Camcorder” is required.

One Touch DVD Burn (p.80)

You can save a recorded image on a DVD with a simple touch. Images that have not been saved to a DVD with One Touch DVD Burn can automatically be saved.

- The quality of a recorded image remains even when it is saved on a DVD.

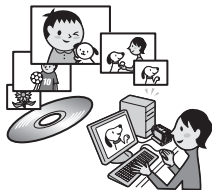

Edit images and create a DVD with selected images (p.91, 93)

You can copy images to your computer. You can also edit images and create a DVD with selected images.

- The quality of a recorded image remains even when it is copied from a computer, or when it is edited or saved on a DVD.

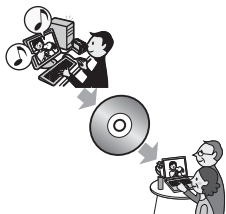

Using your Hard Disk Drive Handycam

Images are recorded on the internal hard disk. When the hard disk becomes full, you cannot record new images. It is recommended that you save the image data periodically, then delete unnecessary images from the hard disk of your camcorder.

- If you delete the images, you can record new images on the free hard disk space again.

Preparing (p.13)



Recording (p.25, 29)



Viewing on your Hard Disk Drive Handycam

- Viewing on the LCD screen (p.27, 30)
- Viewing on a TV (p.39)



Saving

Save recorded images on a DVD etc.

- Saving images on a DVD using a computer (p.80, 93).
- Copying images to a computer (p.84).
- Dubbing on VCR/DVD devices (p.67).



Deleting images

Delete the image data that has been saved on your camcorder. If you delete the images, you can record new images on the free hard disk space again.

- Select the desired image and delete it (p.42).
- Delete all the images ([HDD FORMAT], p.55).



Step 1: Checking supplied items

Make sure that you have following items supplied with your camcorder. The number in the parentheses indicates the number of that item supplied.

AC Adaptor (1) (p.14)

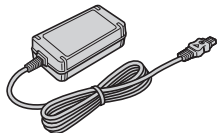

Mains lead (1) (p.14)

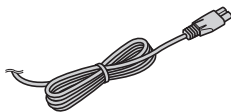

Handycam Station (1) (p.14)

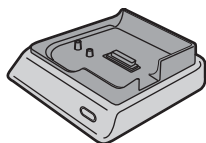

A/V connecting cable (1) (p.39, 67, 69)



USB cable (1) (p.71, 73, 81)

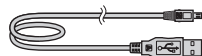

Wireless Remote Commander (1) (p.38)
(DCR-SR50E/SR60E/SR70E/SR80E)



A button-type lithium battery is already installed.

Rechargeable battery pack
NP-FP50 (1) (p.16)

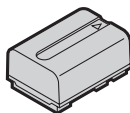

Lens Cap (1) (p.18) (DCR-SR30E/SR40E)



To attach the lens cap
Thread the grip belt through the lens cap ring.

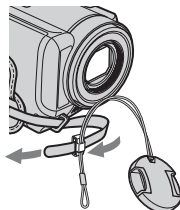

CD-ROM (1) (p.74)

- "ImageMixer for HDD Camcorder" (Software)
- "Handycam Handbook" (PDF/this Handbook)

"Operating Guide" (1)

21-pin adaptor (1) (p.40)

For the models with the CE mark printed on their bottom surfaces only.

Step 2: Charging the battery pack

You can charge the battery after attaching the "InfoLITHIUM" battery pack (P series) (p.117) to your camcorder.

- You cannot use an NP-FP30 battery pack with your camcorder. (See the reverse side of the battery pack for the model number.) Installing the battery pack with excess force may lead to camcorder malfunction such as deterioration in battery pack performance or difficulty in removing the battery pack.

POWER switch

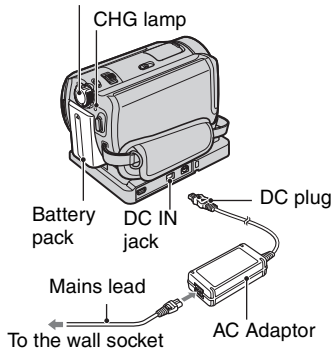

- 2** Slide the POWER switch in the direction of the arrow to set it to OFF (CHG) (The default setting).

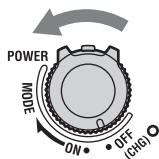

- 3** Connect the AC Adaptor to the DC IN jack on the Handycam Station. Be sure that the ▲ mark on the DC plug is facing up.

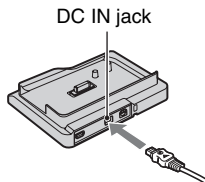

- 1** Slide the battery pack in the direction of the arrow until it clicks.

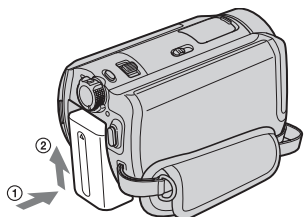

- 4** Connect the mains lead to the AC Adaptor and the wall socket.

5 Set the camcorder onto the Handycam Station securely.

Be sure to set the camcorder to the end.

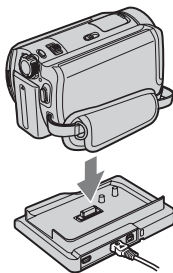

The CHG (charge) lamp lights up and charging starts. The CHG (charge) lamp turns off when the battery pack is fully charged.

- When setting the camcorder onto the Handycam Station, close the DC IN jack cover.

To charge the battery pack using only the AC Adaptor

Slide the POWER switch up to OFF (CHG), then connect the AC Adaptor directly to the DC IN jack on the camcorder.

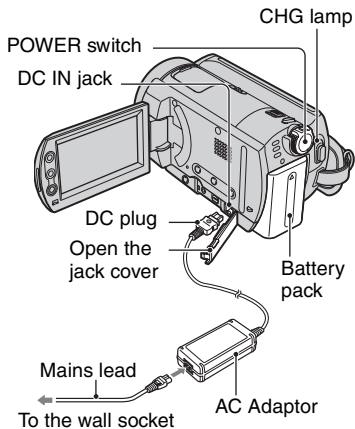

To remove the battery pack

Slide the POWER switch to OFF (CHG). Slide the BATT (battery) release lever and remove the battery pack.

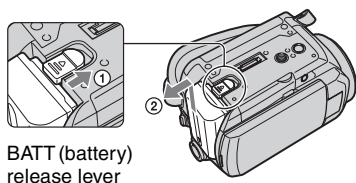

BATT (battery) release lever

- When you remove the battery pack, make sure that none of the respective lamps of the POWER switch (p.18) is on.

To remove your camcorder from the Handycam Station

Turn off the power, then remove the camcorder from the Handycam Station holding both.

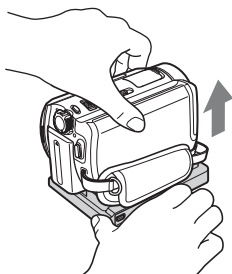

When storing the battery pack

Use up the battery pack completely if you do not intend to use it for a long time (p.117).

To use an outside power source

Make the same connections as you do when charging the battery pack. The battery pack will not lose its charge in this case.

Charging time (full charge)

Approximate time (min.) required when you fully charge a completely exhausted battery pack.

Battery pack	Charging time
NP-FP50 (supplied)	125
NP-FP60	135
NP-FP70	155
NP-FP71	170
NP-FP90	220

Recording time

Approximate time (min.) available when you use a fully charged battery pack.

DCR-SR30E/SR40E

Battery pack	Continuous recording time	Typical recording time*
NP-FP50 (supplied)	125	65
NP-FP60	190	100
NP-FP70	265	145
NP-FP71	315	170
NP-FP90	475	260

DCR-SR50E/SR60E/SR70E/SR80E

Battery pack	Continuous recording time	Typical recording time*
NP-FP50 (supplied)	100 110	55 60
NP-FP60	155 170	85 90
NP-FP70	215 235	115 125
NP-FP71	255 280	140 150
NP-FP90	385 415	210 225

* Typical recording time shows the time when you repeat recording start/stop, turning the power on/off and zooming.

- Times shown vary according to the following conditions (when [REC MODE] is set to [HQ]).
 - Top: When the LCD backlight turns on.
 - Bottom: When the LCD backlight turns off.

Playback time

Approximate time (min.) available when you use a fully charged battery pack.

DCR-SR30E/SR40E

Battery pack	Playback time
NP-FP50 (supplied)	140
NP-FP60	210
NP-FP70	295
NP-FP71	350
NP-FP90	525

DCR-SR50E/SR60E/SR70E/SR80E

Battery pack	Playback time*
NP-FP50 (supplied)	120
NP-FP60	185
NP-FP70	255
NP-FP71	300
NP-FP90	455

* When the LCD backlight turns on.

On the battery pack

- Before changing the battery pack, slide the POWER switch to OFF (CHG).
- The CHG (charge) lamp flashes during charging, or BATTERY INFO (p.34) will not be correctly displayed under the following conditions.
 - The battery pack is not attached correctly.
 - The battery pack is damaged.
 - The battery pack is fully discharged. (For BATTERY INFO only.)
- The power will not be supplied from the battery as long as the AC Adaptor is connected to the DC IN jack of your camcorder or the Handycam Station, even when the mains lead is removed from the wall socket.
- We recommend that you use an NP-FP70, NP-FP71 or NP-FP90 battery pack when a video light (optional) is attached.

On the charging/recording/playback time

- Times measured with the camcorder at 25°C (77°F). (10-30°C (50-86°F) is recommended.)
- Available recording and playback time will be shorter when you use your camcorder in low temperatures.
- The available recording and playback time will be shorter depending on the conditions under which you use your camcorder.

On the AC Adaptor

- Connect the AC Adaptor to an easily accessible wall socket close by. If any trouble occurs while using the adaptor, immediately shut off the power by removing the plug from the wall socket.
- Do not use the AC Adaptor placed in a narrow space, such as between a wall and furniture.
- Do not short-circuit the DC plug of the AC Adaptor or battery terminal with any metallic objects. This may cause a malfunction.

PRECAUTION

- Even if your camcorder is turned off, AC power (mains) is still supplied to it while connected to the wall socket via the AC Adaptor.



Step 3: Turning the power on and holding your camcorder

To record, slide the POWER switch to turn on the respective lamp.

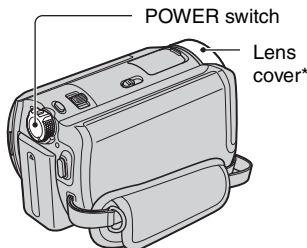

When using it for the first time, the [CLOCK SET] screen appears (p.22).



* DCR-SR50E/SR60E/SR70E/SR80E

-  (Movie): To record movies
-  (Still): To record still images
-  (PLAY/EDIT): To play back images on your camcorder, or to edit/delete them



- When you set the POWER switch to  (Movie) or  (Still), the lens cover opens up (DCR-SR50E/SR60E/SR70E/SR80E).
- After you have set the date and time ([CLOCK SET], p.22), the next time you turn on the power of your camcorder, the current date and time will be displayed on the LCD screen for a few seconds.

- 1 Remove the lens cap by pressing both tabs on the sides of the cap. Pull the lens cap string down until stopped by the grip belt (DCR-SR30E/SR40E).**



- 3 Hold your camcorder correctly.**

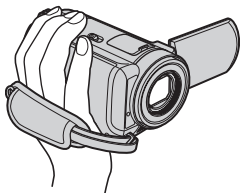

- 2 Turn on the power by sliding the POWER switch in the direction of the arrow while pressing the green button in the center.**

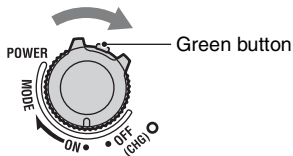

When you record, switch the power mode by sliding the POWER switch in the direction of the arrow until the respective lamp lights up.

- 4 Fasten the grip belt.**

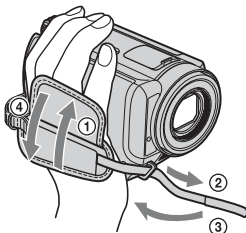

To turn off the power

Slide the POWER switch to OFF (CHG).
Put the lens cap back after turning off the power (DCR-SR30E/SR40E).

- At the time of purchase, the power will be set to turn off automatically if you leave your camcorder without any operation for approximately five minutes, to save battery power ([A.SHUT OFF], p.60).

Step 4: Adjusting the LCD screen

The LCD screen

Open the LCD screen 90 degrees to the camcorder (①), then rotate it to the best angle to record or play (②).

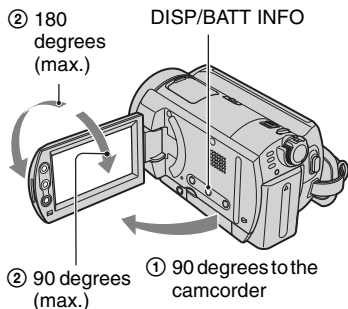

- Be careful not to press the buttons on the LCD frame accidentally, when you open or adjust the LCD screen.
- If you open the LCD screen 90 degrees to the camcorder, rotate it 180 degrees to the lens side, then you can close it with the LCD screen side facing out. This is convenient during playback operations.

To turn off the LCD backlight to make the battery last longer (DCR-SR50E/SR60E/SR70E/SR80E)

Press and hold DISP/BATT INFO for a few seconds until ☐_{OFF} appears.

This setting is practical when you use your camcorder in bright conditions or when you want to save battery power. The recorded image will not be affected by this setting. To cancel, press and hold DISP/BATT INFO until ☐_{OFF} disappears.

- See [LCD SET] - [LCD BRIGHT] (p.58) to adjust the brightness of the LCD screen.

Step 5: Using the touch panel

You can play back recorded images (p.27, 30), or change the settings (p.44) using the touch panel.

Touch the buttons displayed on the screen.

Support the rear of the LCD panel with your finger. Then, touch the buttons displayed on the screen.

Touch the button on the LCD screen.

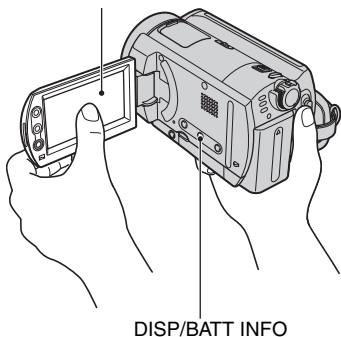

- Perform the same actions as described above when you press the buttons on the LCD frame.
- Be careful not to press the buttons on the LCD frame accidentally while using the touch panel.
- If the buttons on the touch panel do not work correctly, adjust the LCD screen (CALIBRATION) (p.119).

To hide the screen indicators

Press DISP/BATT INFO to hide or show the screen indicators (counter, etc.).

Changing the language setting

You can change the on-screen displays to show messages in a specified language. Select the screen language in [LANGUAGE] on the TIME/LANGU. (p.60).

Step 6: Setting the date and time

Set the date and time when using this camcorder for the first time. If you do not set the date and time, the [CLOCK SET] screen appears every time you turn on your camcorder or slide the POWER switch.

- If you do not use your camcorder for **about 3 months**, the built-in rechargeable battery gets discharged and the date and time settings may be cleared from the memory. In that case, charge the rechargeable battery and then set the date and time again (p.119).

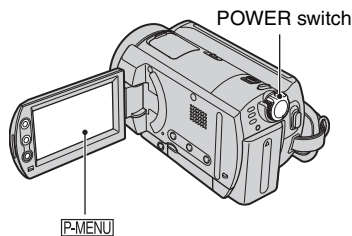

Skip to step 4 when you set the clock for the first time.

1 Touch [P-MENU] → [SETUP].

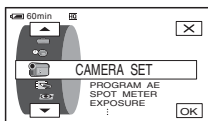

2 Select [TIME/LANGU.] with [▲]/[▼], then touch [OK].

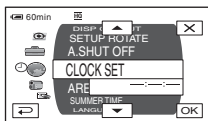

3 Select [CLOCK SET] with [▲]/[▼], then touch [OK].

4 Select the desired geographical area with [▲]/[▼], then touch [OK].

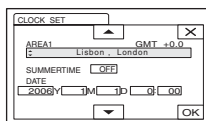

5 Set [SUMMERTIME] to [ON] with [▲]/[▼], if necessary, then touch [OK].

6 Set [Y] (year) with [▲]/[▼], then touch [OK].

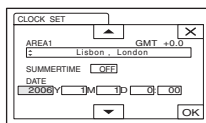

- You can set any year up to the year 2079.

7 Set [M] (month), [D] (day), hour and minute, then touch [OK].

The clock starts.

- Refer to page 115 for information concerning "World time difference".
- The recording date and time are not displayed during recording, but are automatically recorded onto the hard disk and displayed during playback ([DATA CODE], p.58).

Step 7: Selecting the aspect ratio (16:9 or 4:3) of the recording image (DCR-SR50E/SR60E/SR70E/SR80E)

By recording in the 16:9 (wide) mode, you can enjoy wide-angle, high-resolution images.

- If you intend to view images on a wide TV, recording in the 16:9 (wide) mode is recommended.

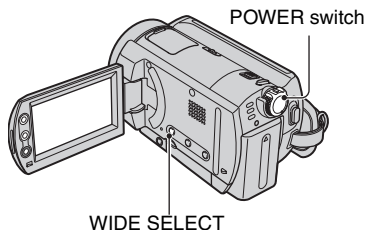

- You cannot change the aspect ratio in the following cases:
 - while recording movies
 - when [D. EFFECT] is set to [OLD MOVIE] (p.54)
- Differences in the angle of view between 16:9(wide) and 4:3 vary depending on the zoom position.

To play back images after connecting your camcorder to a TV

Set [TV TYPE] to [16:9] or [4:3] according to your TV (16:9/4:3) (p.39).

- When viewing 16:9 (wide) images with [TV TYPE] set to [4:3], images may appear rough depending on subjects.

Movies

- 1 Slide the **POWER** switch in the direction of the arrow to light up the  (Movie) lamp.

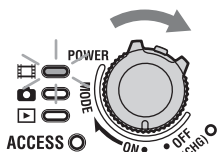

Still images

- 1 Slide the **POWER** switch to light up the  (Still) lamp.

The image size ratio changes to 4:3.

- 2 Press **WIDE SELECT** repeatedly to select the desired setting.





- 2 Press **WIDE SELECT** repeatedly to select the desired screen aspect ratio.

16:9 (wide)



4:3



- Still image size is set to [ 0.7M] () when 16:9 (wide) is selected. [ 1.0M] () is set in maximum mode when 4:3 is selected.
- The number of recordable still images is 9,999.



Using Easy Handycam operation

Easy Handycam operation is a function for making nearly all settings automatic with just one press of the EASY button. Since only basic functions become available and screen font size increases for easy viewing, even first time users can enjoy easy operation.

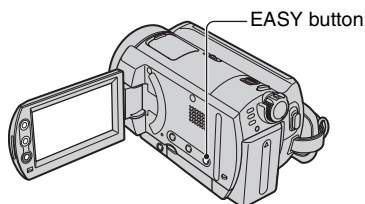

The settings of your camcorder during Easy Handycam operation

Touch [SETUP] to display the available setup items.

For details on setup. See page 45.

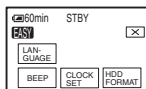
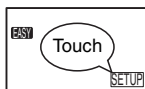

- Nearly all setup items are automatically fixed.
- **P-MENU** is not displayed during Easy Handycam operation.
- To perform settings such as focusing manually and adding special effects, cancel Easy Handycam operation.

Invalid buttons during Easy Handycam operation

You cannot use following buttons or functions since they are automatically set. If you set an invalid operation, [Invalid during Easy Handycam operation] may appear.

- BACK LIGHT (p.32)
- Press and hold DISP/BATT INFO (p.20)
- Zoom lever/buttons (during playback)



Now try recording → page 25

Complete the preparations described in steps 1 to 7 (p.13 to 23) before operation.



Recording with ease

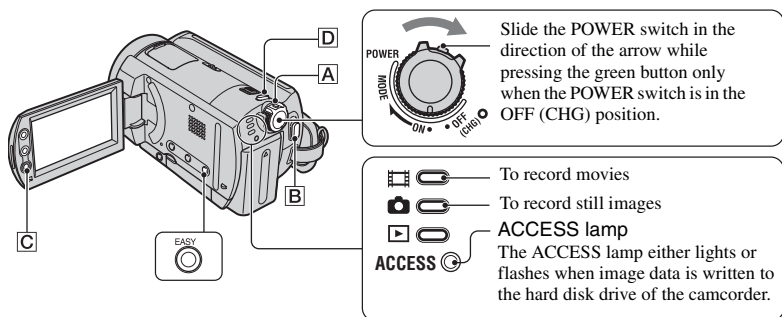

Movies



1 Slide the POWER switch **A** in the direction of the arrow to light up the (Movie) lamp.

2 Press EASY.

[Easy Handycam operation ON.] appears, then **EASY** appears on the LCD screen.



3 Press START/STOP **B** (or **C**).

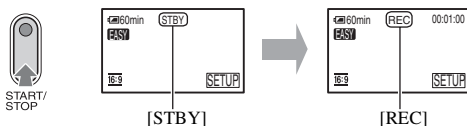

To stop recording, press START/STOP again.

- [REC MODE] is set to [HQ] (default settings) (p.57).
- The maximum continuous recordable time is approximately 13 hours.

To record the next movies

Perform step **3**.



1 Slide the POWER switch **A** in the direction of the arrow to light up the (Still) lamp.

2 Press EASY.

[Easy Handycam operation ON.] appears, then **EASY** appears on the LCD screen.



3 Press PHOTO **D** lightly to adjust the focus **A**, then press it fully **B**.

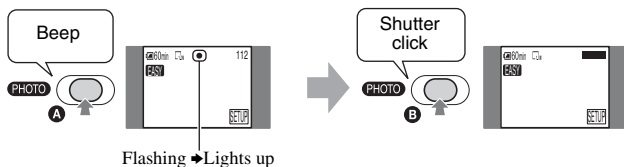

A shutter sound is heard. When disappears, the image has been recorded.

- [QUALITY] is set to [FINE] (default settings) (p.53).

To record the next still images

Perform step 3.

To cancel Easy Handycam

Press EASY again. **EASY** disappears on the LCD screen.

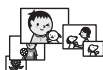

Playback with ease

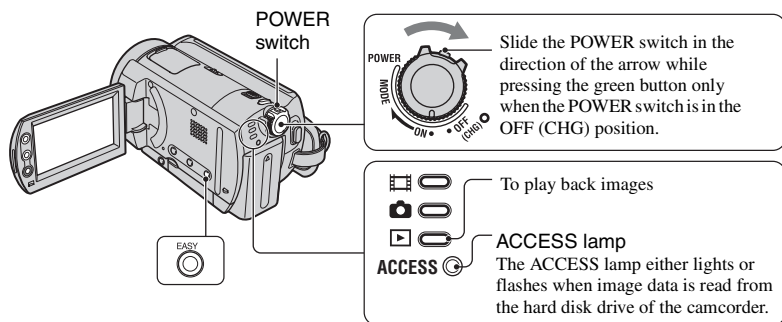

1 Slide the POWER switch in the direction of the arrow repeatedly to light up the (PLAY/EDIT) lamp.

The VISUAL INDEX screen appears on the LCD screen.

2 Press EASY.

[Easy Handycam operation ON.] appears, then  appears on the LCD screen.

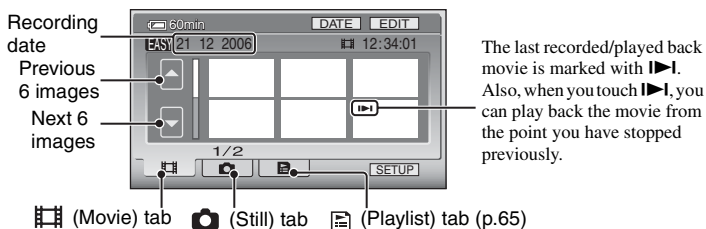

3 Start playback.

Movies



Touch (Movie) tab, then touch the thumbnail of the movie to be played back.

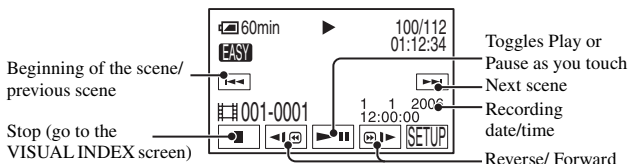

When playback from the selected movie reaches the last movie, the screen returns to the VISUAL INDEX screen.

- Touch during pause to play back movie slowly.
- Touch [SETUP] → [VOLUME], then adjust it with / .

Still Images



Touch (Still) tab, then touch the thumbnail of the still image to be played back.

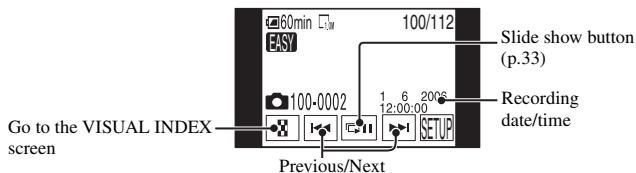

- It may take some time to display the VISUAL INDEX screen.
- When you touch [EDIT] on the VISUAL INDEX screen, you can delete images. See “Deleting images” on page 42..

To cancel Easy Handycam

Press EASY again. EASY disappears on the LCD screen.



Recording/Playback Recording

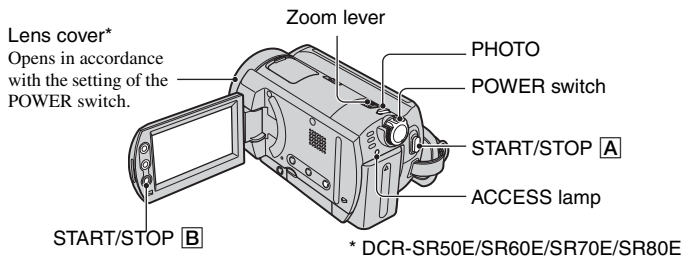

1 Slide the **POWER** switch in the direction of the arrow repeatedly to light up the respective lamp.

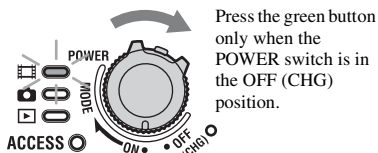

2 Start recording.

Movies

Press **START/STOP [A]** (or **[B]**).

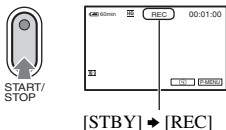

To stop recording, press **START/STOP** again.

Still Images

Press **PHOTO** lightly to adjust the focus **[A]**, then press it fully **[B]**.

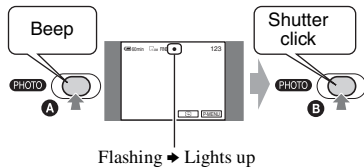

A shutter sound is heard. When **||||** disappears, the image has been recorded.



- If the **ACCESS** lamp is on or flashing after recording is finished, it means data is still being written onto the hard disk. Do not apply shock or vibration to your camcorder, and do not remove the battery pack or AC Adaptor.
- You cannot record movies and still images at the same time.
- The maximum continuous recordable time is approximately 13 hours.
- When a movie data file exceeds 2 GB, the next file is created automatically.
- For image quality of movies, see [REC MODE] (p.57), of still images, see [IMAGE SIZE] (p.53).



Playback

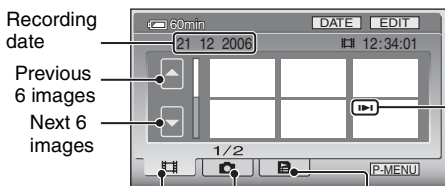



1 Slide the POWER switch repeatedly to light up the (PLAY/EDIT) lamp.

The VISUAL INDEX screen appears on the LCD screen.



The last recorded/played back movie is marked with . Also, when you touch , you can play back the movie from the point you have stopped previously.

 (Movie) tab  (Still) tab  (Playlist) tab (p.65)

- Moving the zoom lever changes the VISUAL INDEX screen indication from 6 to 12 and more images can be displayed at the same time.
- Touch  DISPLAY in  STANDARD SET to set the number of thumbnails that appear in the VISUAL INDEX screen (p.59).
- If you press and hold  / , you can scroll the thumbnail index quickly.



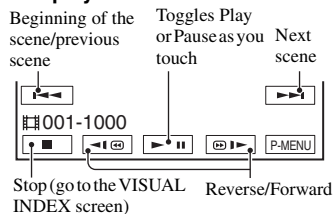

2 Start playback.

Movies

Touch  (Movie) tab and the movie to be played back.



When playback from the selected movie reaches the last movie, the screen returns to the VISUAL INDEX screen.

- Touch  /  during pause to play back movie slowly.
- One touch of  /  makes the reverse/fast forward approximately five times faster, two touches make it approximately 10 times faster, three touches make it approximately 30 times faster, four touches make it approximately 60 times faster.

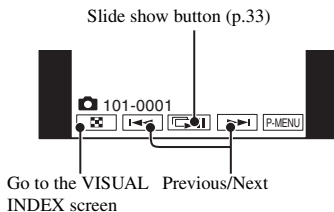

Still Images

Touch  (Still) tab and the still image to be played back.



- The ACCESS lamp either lights or flashes when image data is read from the hard disk drive of the camcorder.

To adjust the volume

Touch  [P-MENU] → [VOLUME], then adjust it with  / .

- If you cannot find [VOLUME] in , touch [SETUP] (p.44).

Searching for desired images by date (Date Index)

You can search for desired images by date efficiently.

- 1 Slide the **POWER** switch repeatedly to light up the **(PLAY/EDIT)** lamp.

The **VISUAL INDEX** screen appears on the LCD screen.

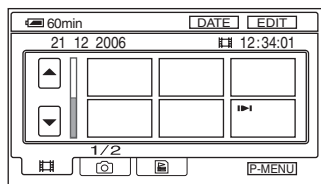

- 2 To search for movies, touch **[#]** (Movie) tab. To search for still images, touch **[CAMERA]** (Still) tab.

- 3 Touch **[DATE]**.

The recording dates of images are displayed on the screen.

Return to the **VISUAL INDEX** screen

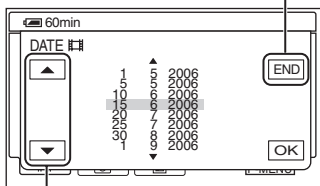

Previous/Next Date button

- 4 Touch **Previous/Next Date** button to select the date of the desired image.

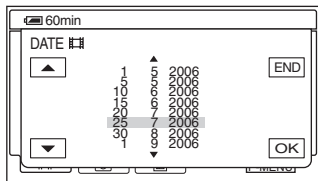

- 5 Touch **[OK]** while the selected date of the desired image is highlighted.

The images for selected date are displayed on the **VISUAL INDEX** screen.

Functions used for recording/playback, etc.

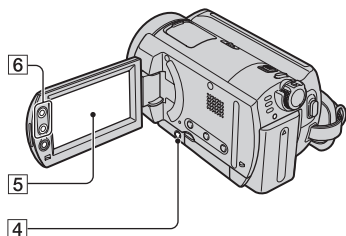
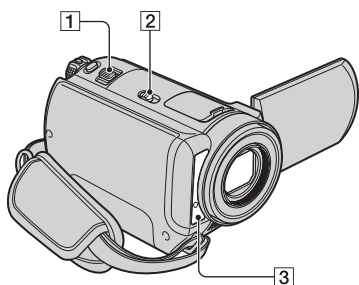

(optical zoom)

DCR-SR30E/SR40E	20 ×
DCR-SR50E/SR60E/ SR70E/SR80E	12 ×

To record in dark places (NightShot plus)..... 2

Set the NIGHTSHOT PLUS switch [2] to ON. ([ON] and ["NIGHTSHOT PLUS"] appear.)

- To record an image brighter, use Super NightShot plus function (p.51). To record an image brighter in dim light, use Color Slow Shutter function (p.51).
- The NightShot plus and Super NightShot plus use infrared light. Therefore, do not cover the infrared port [3] with your fingers or other objects.
- Remove the conversion lens (optional).
- Adjust the focus manually ([FOCUS], p.50) when it is hard to focus automatically.
- Do not use these functions in bright places. This may cause a malfunction.

Recording

To use zoom 1 6

Move the power zoom lever [1] slightly for a slower zoom. Move it further for a faster zoom.

Wider range of view: (Wide)

Close view: (Telephoto)

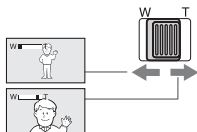

- Be careful not to remove your finger suddenly from the power zoom lever [1]. If you do so, the sound of the lever moving may be recorded.
- You cannot change the zoom speed with the zoom buttons [6] on the LCD frame.
- The minimum distance required between your camcorder and the subject to get a sharp focus is about 1 cm (about 1/2 inch) for wide angle and about 80 cm (about 2 5/8 feet) for telephoto.
- You can set [DIGITAL ZOOM] (p.51) if you want to zoom to a level greater than the following:

To adjust the exposure for backlit subjects (BACK LIGHT) 4

To adjust the exposure for backlit subjects, press BACK LIGHT [4] to display [BL]. To cancel the back light function, press BACK LIGHT again.

To adjust the focus for an off center subject 5

See [SPOT FOCUS] on page 50.

To fix the exposure for the selected subject 5

See [SPOT METER] on page 48.

To add special effects 5

See [PICT.APPLI] on page 54.

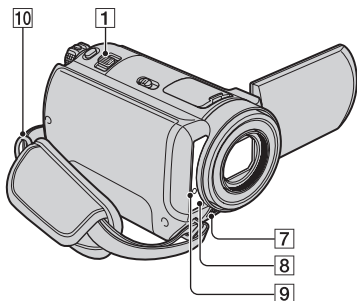

To use a tripod 15

Attach the tripod (optional: the length of the screw must be less than 5.5 mm) to the tripod receptacle 15 using a tripod screw.

To attach the shoulder belt 10



Attach the shoulder belt (optional) with your camcorder to the hook for the shoulder belt.

Playback

To play back a series of still images (Slide show) 5

Touch  on the still image playback screen (p.30).

The slide show begins from the selected image.

Touch  to stop the slide show. To restart, touch  again.

- You can touch  to set continuous slide show playback. The default setting is [ON] (continuous playback).

- You cannot operate playback zoom during slide show.

To use Playback zoom 1 6

You can magnify images from about 1.1 to 5 times the original size.

Magnification can be adjusted with the power zoom lever 1 or the zoom buttons 6 on the LCD frame.

① Play back the image you want to magnify.

② Magnify the image with T (Telephoto). A frame appears on the LCD screen.

③ Touch the portion you want to display in the center of the LCD screen.

④ Adjust the magnification with W (Wide angle)/T (Telephoto).

To cancel, touch [END].

- You cannot change the zoom speed with the zoom buttons 6 on the LCD frame.

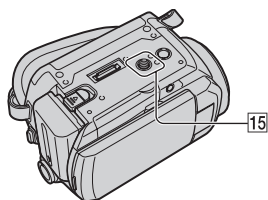
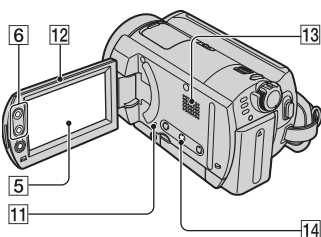

To record in mirror mode 12

Open the LCD screen 12 90 degrees to the camcorder (1), then rotate it 180 degrees to the lens side (2).

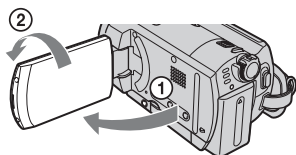

- A mirror-image of the subject appears on the LCD screen, but the image will be normal when recorded.

Recording/playback

To check the remaining battery [14]

Set the POWER switch to OFF (CHG), then press DISP/BATT INFO [14]. If you press this button once, BATTERY INFO appears on the screen for about seven seconds. Press the button while BATTERY INFO appears on the screen to extend the indication to the 20-second maximum.

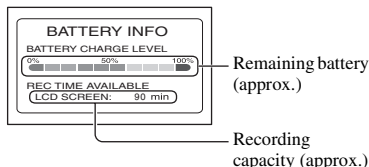

To check available free hard disk space [5]

See [HDD INFO] (on page 55).

- During recording, the remaining recordable time/number of still images are displayed.

To turn off the operation confirmation beep [5]

See [BEEP] on page 60.

To initialize the settings (Reset) ... [11]

Press RESET [11] to initialize all the settings, including settings for date and time. (Setup items customized on Personal Menu are not initialized.)



Other part names and functions

- 7** Built-in stereo microphone
When an external microphone (optional) is connected, it takes precedence over the internal microphone (DCR-SR50E/SR60E/SR70E/SR80E).
- 8** Remote sensor (DCR-SR50E/SR60E/SR70E/SR80E)
Point the Remote Commander (p.38) towards the remote sensor to operate your camcorder.
- 9** Recording lamp (DCR-SR50E/SR60E/SR70E/SR80E)
The recording lamp lights up red during recording (p.59).
The lamp flashes when the remaining capacity for the battery or the hard disk of the camcorder is running low.
- 13** Speaker
Sound comes out from the speaker while playing back.
 - For how to adjust the volume, see page 30.

Checking/Deleting the last scene (Review/Review deleting)

You can check the last recorded movie/still image. Also, you can delete the checked images.

Checking the last scene (Review)

- 1 Slide the **POWER** switch to light up the  (Movie) or  (Still) lamp, then touch .

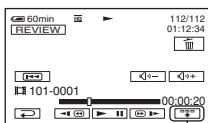

The playback of the latest scene starts.

Movie



Touch to display below function buttons.

 : Return to the beginning of the viewing movie.

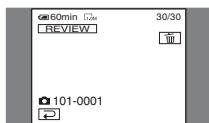

 /  : Adjust the volume.

Still image



To return to recording

Touch .

- Camera data (recording date, conditions, etc.) is not displayed.
- When reviewing still images recorded continuously (p.53), you can forward/backward the images with  /  (DCR-SR50E/SR60E/SR70E/SR80E).

Deleting the last scene (Review deleting)

If the checked scene is unnecessary, you can delete it on the spot.

- 1 Touch  during the review.

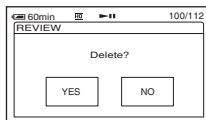

- 2 Touch [YES].

- You cannot recover a scene once you delete it.

- You can delete the last recorded image in a succession with Review deleting.
- You can only delete the last recorded image in order with Review. To delete the desired image, see page 42.
- When the recorded images are deleted in order with Review deleting, you cannot continue to delete them if a protected image appears on the screen.
- When you delete still images that were recorded continuously (p.53), all the images are deleted at the same time (DCR-SR50E/SR60E/SR70E/SR80E).

Indicators displayed during recording/playback

() is a reference page.

The indicators during recording will not be recorded.

Recording movies

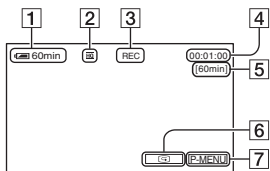

- 1** Remaining battery (approx.) (34)
- 2** Recording mode (HQ / SP / LP) (57)
- 3** Recording status ([STBY] (standby) / [REC] (recording))
- 4** Counter (hour: minute: second)
- 5** Remaining recordable time of movies
- 6** Review button (35)
- 7** Personal Menu button (44)

Recording still images

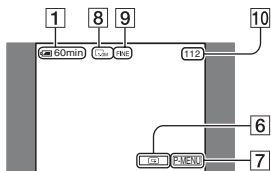

- 8** Image size (53)
(DCR-SR50E/SR60E/SR70E/SR80E)
- 9** Quality ([FINE] / [STD]) (53)
- 10** Number of recordable still images

Viewing movies

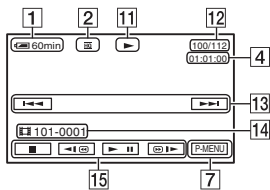

- 11** Playback mode
- 12** Number of played back movies/Total number of recorded movies
- 13** Previous/Next button (28, 30)
- 14** Recording folders/files (116)
- 15** Video operation buttons (28, 30)

Viewing still images

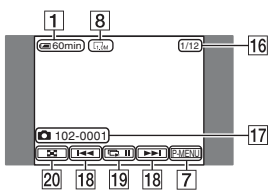

- 16** Number of played back still images/Total number of recorded still images
- 17** Recording folders/files (116)
- 18** Previous/Next button (28, 30)
- 19** Slide show button (33)
- 20** VISUAL INDEX button (28, 30)

Indicators on the LCD screen

When you can change the setup items, or during recording or playback, following indicators are displayed.

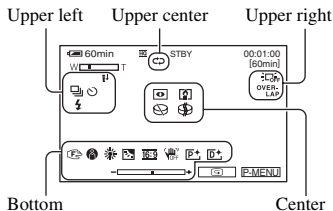

Upper left

Indicator	Meaning
	Self-timer recording (51)
BRK	Continuous photo recording /Bracket recording (53)
	Flash light (50)
	MICREF LEVEL low (57)

Upper center

Indicator	Meaning
	Repeat of Slide show (33)

Upper right

Indicator	Meaning
WHITE FADER OVER-LAP BLACK FADER WIPE	Fader (54)
	LCD backlight off (20)
	Drop sensor off (56)
	Drop sensor (56)

Center

Indicator	Meaning
	NightShot plus (32)
	Super NightShot plus (51)
	Color Slow Shutter (51)
	PictBridge connecting (71)
	Warning (110)

Bottom

Indicator	Meaning
	Picture effect (54)
	Digital effect (54)
	Manual focus (50)
	PROGRAM AE (48)
	Backlight (32)
	White balance (49)
	WIDE SELECT (23)
	SteadyShot off (52)
	Flexible spot meter (48)/ Exposure (49)

DATA CODE while recording

The recording date and time are recorded automatically. They are not displayed while recording. However, you can check them as [DATA CODE] during playback (p.58).

Remote Commander (DCR-SR50E/SR60E/SR70E/SR80E)

Remove the insulation sheet before using the Remote Commander.

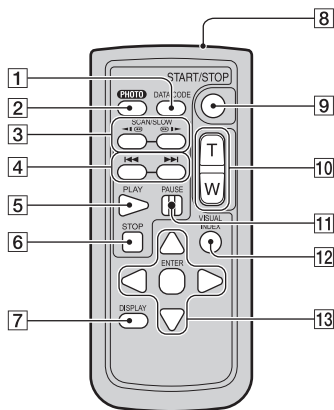
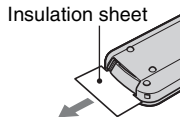

1 DATA CODE (p.58)

Displays the date and time or camera setting data of the recorded images (p.58) when you press this while playing back.

2 PHOTO (p.26, 29)

The on-screen image when you press this button will be recorded as a still image.

3 SCAN/SLOW (p.28, 30)

4 ◀◀ ▶▶ (Previous/Next) (p.28, 30)

5 PLAY (p.28, 30)

6 STOP (p.28, 30)

7 DISPLAY (p.21)

8 Transmitter

9 START/STOP (p.25, 29)

10 Power zoom (p.32, 33)

11 PAUSE (p.28, 30)

12 VISUAL INDEX (p.27, 30)

Displays a VISUAL INDEX screen when you press this while playing back.

13 ◀ / ▶ / ▲ / ▼ / ENTER

When you press any button, the orange frame appears on the LCD screen. Select a desired button or an item with ◀ / ▶ / ▲ / ▼, then press ENTER to enter.

- Point the Remote Commander towards the remote sensor to operate your camcorder (p.34).
- When no commands have been sent from the Remote Commander in a certain period, the orange frame disappears. When you press any of ◀ / ▶ / ▲ / ▼, or ENTER again, the frame appears at the position where it was displayed last.
- To change the battery, see page 120.

Playing the image on a TV

Connect your camcorder to the input jack of TV or VCR using A/V connecting cable **1** or A/V connecting cable with S VIDEO **2**. Connect your camcorder to the wall socket using the supplied AC Adaptor for this operation (p.14). Refer also to the instruction manuals supplied with the devices to be connected.

- To view the recorded images on a computer, see page 74.

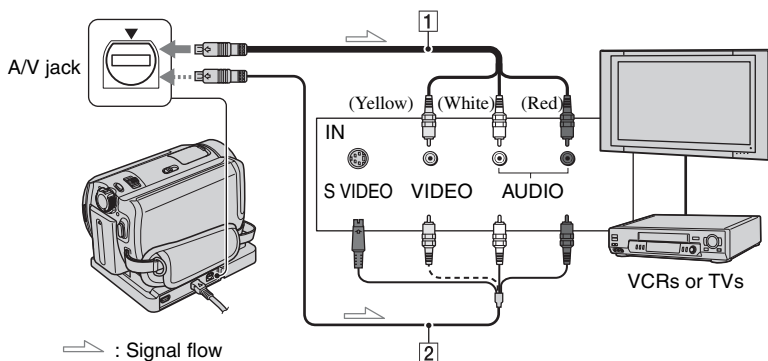

1 A/V connecting cable (supplied)

The Handycam Station and your camcorder are both equipped with A/V jacks (p.73). Connect the A/V connecting cable either to the Handycam Station or to your camcorder, according to your setup.

2 A/V connecting cable with S VIDEO (optional)

When connecting to another device via the S VIDEO jack, by using an A/V connecting cable with an S VIDEO cable (optional), higher quality images can be produced than with an A/V connecting cable. Connect the white and red plug (left/right audio) and the S VIDEO plug (S VIDEO channel) of the A/V connecting cable with an S VIDEO cable (optional). The yellow plug connection is not necessary. S VIDEO connection only will not output audio.

- You can display the counter on the TV screen by setting [DISP OUTPUT] to [V-OUT/PANEL] (p.60).
- Do not connect A/V connecting cables to both your camcorder and the Handycam Station at the same time. The image might get disturbed.

When your TV is connected to a VCR

Connect your camcorder to the LINE IN input on the VCR. Set the input selector on the VCR to LINE (VIDEO 1, VIDEO 2, etc.), if the VCR has an input selector.

To set the aspect ratio according to the connected TV (16:9/4:3) (DCR-SR50E/SR60E/SR70E/SR80E)

Change the setting according to the screen aspect ratio of the TV you will view images on.

- 1 Slide the POWER switch to light up the (PLAY/EDIT) lamp.
 - 2 Touch [P-MENU] → [SETUP] → STANDARD SET → [TV TYPE] → [16:9] or [4:3] → [OK].
- When you set [TV TYPE] to [4:3], the image quality may deteriorate. Also, when the recorded image's aspect ratio switches between 16:9 (wide) and 4:3, the image may jitter.

- On some 4:3 TVs, the still images recorded in 4:3 aspect ratio may not be displayed full screen. This is not a malfunction.



- When you play back an image recorded in 16:9 (wide) aspect ratio on a 4:3 TV not compatible with the 16:9 (wide) signal, set [TV TYPE] to [4:3].

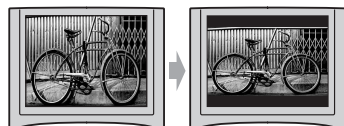

When your TV is monaural (When your TV has only one audio input jack)

Connect the yellow plug of the A/V connecting cable to the video input jack and connect the white (left channel) or the red (right channel) plug to the audio input jack of your TV or VCR.

If your TV/VCR has a 21-pin adaptor (EUROCONNECTOR)

Use the 21-pin adaptor supplied with your camcorder (For models with the CE mark printed on their bottom surfaces only). This adaptor is designed for output use only.

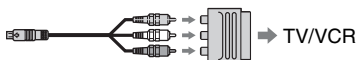

Saving images

Recorded images are stored on the internal hard disk of the camcorder. Due to some limitations on the internal hard disk, make sure that you save the image data to the external media. You can save the images recorded on the camcorder as described below.

Saving images on DVD using your computer

By using the software in the supplied CD-ROM, the quality of a recorded image is maintained even when the image is saved on a DVD.

Create DVD with One Touch

You can save images recorded on the camcorder directly to a DVD with ease.



See “Creating a DVD with One Touch” on page 80.

Create DVD with the desired images

You can save images copied to your computer on a DVD. You can also edit the images.



See “Editing images” on page 91, and “Creating a DVD with selected images” on page 93.

Saving images by connecting the camcorder to other VCR/DVD devices

You can save images recorded on the camcorder by connecting to other VCR/DVD devices.

Dub to VCR/DVD devices

You can save the images recorded on the camcorder by connecting the camcorder to VCR/DVD devices.



See “Dubbing to VCR/DVD devices” on page 67.

Deleting images

You can provide free hard disk space by deleting image data on the camcorder.

- You can check the free hard disk space of the camcorder on [HDD INFO] (p.55).
- Protected images cannot be deleted. To delete the images, cancel the protection (p.66).
- Important data should be saved (p.41).
- Do not delete the image data on the hard disk of the camcorder from your computer.

Deleting desired images

1 Slide the POWER switch to light up the (PLAY/EDIT) lamp.

The VISUAL INDEX screen appears on the LCD screen.

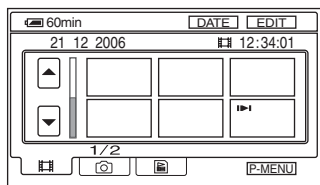

2 Select the (Movie) tab or the (Still) tab that includes the image you want to delete, then touch [EDIT].

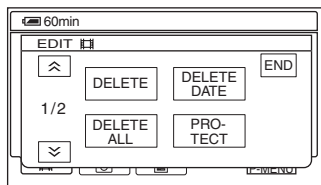



- When you touch [EDIT] during Easy Handycam operation, only [DELETE], [DELETE ALL] and [DELETE DATE] appear (p.27).

3 Touch [DELETE].

4 Select the image to be deleted.

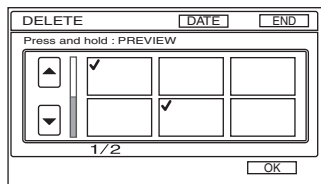
The selected image is marked with .





- Press and hold the movie on the LCD screen to check the movie (Preview). Touch  to return to the previous screen. The Preview screen buttons have the same functions as the ones on the Review screen (p.35).
- You can select multiple images at the same time.

5 Touch → [YES].

- You cannot recover an image once you delete it.

- If you delete an original movie that is listed in a Playlist (p.63), it is also deleted from the Playlist.

To delete all movies or still images at once

- ① To delete a movie, touch  (Movie) tab, to delete still images, touch  (Still) tab on the VISUAL INDEX screen.
- ② Touch [EDIT] → [DELETE ALL] → [YES] → [YES].

- Protected images cannot be deleted (p.65).
- To recover all the recordable space of hard disk, perform [HDD FORMAT] (p.55).

Deleting images by date

You can delete movies or still images by date at once.

1 Slide the POWER switch to light up the (PLAY/EDIT) lamp.

The VISUAL INDEX screen appears on the LCD screen.

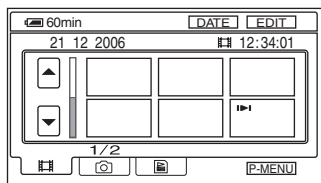

2 To delete movies, touch (Movie) tab. To delete still images, touch (Still) tab.

3 Touch [DATE].

The recording dates of images are displayed on the screen.

Return to the VISUAL INDEX screen

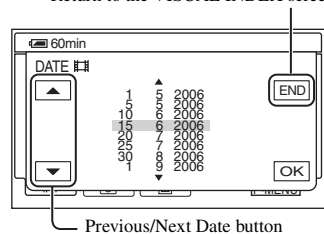

4 Touch Previous/Next Date button to select the date of the desired image.

5 Touch while the selected date of the desired image is highlighted.

Go back to the VISUAL INDEX screen.

6 Touch [EDIT], then touch [DELETE DATE] → [YES].

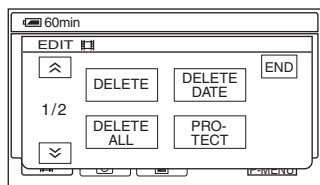

Delete movies or still images recorded on the selected date at once.



- You cannot delete movies and still images recorded on the same date at the same time.
- You cannot delete protected images (p.65).
- When the multiple number of the same date is displayed in step 3, only the image data in the selected date folder can be deleted.

Using the Setup items

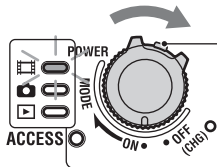
- Slide the POWER switch in the direction of the arrow repeatedly to light up the respective lamp.



Slide the POWER switch while pressing the green button in the center only when the POWER switch is in the OFF (CHG) position.

- : Settings for movies
- : Settings for still images
- : Settings for PLAY/EDIT

- Touch the LCD screen to select the setup item.

Unavailable items will be grayed out.

■ To use the short-cuts of Personal Menu



On Personal Menu, short-cuts for frequently used setup items are added.

- You can customize Personal Menu as you like (p.61).

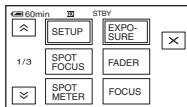
- Touch **P-MENU**.



- Touch the desired setup item.

If the desired setup item is not displayed on the screen, touch  /  until it is displayed.

- Select the desired setting, then touch **OK**.

■ To change the setup items

You can customize setup items that are not added to Personal Menu.

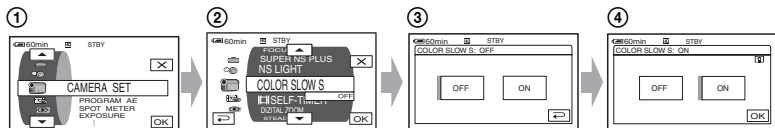

- ① Touch **[P-MENU]** → **[SETUP]**.
- ② Select the desired setup item.
Touch **[▲]** / **[▼]** to select the item, then touch **[OK]**. (The process in step ③ is the same as that in step ②.)
- ③ Select the desired item.
 - You can also touch the item directly to select it.
- ④ Customize the item.
After finishing the settings, touch **[OK]** → **[X]** (close) to hide the setup screen.
If you decide not to change the setting, touch **[↶]** to return to the previous screen.

■ To change the setup items during Easy Handycam operation

[P-MENU] does not appear during Easy Handycam operation (p.24).

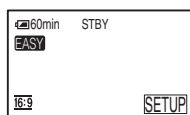

- ① Touch **[SETUP]**.
Available setup items appear.
- ② Select the desired item.
- ③ Customize the item.
Touch **[OK]** after finishing the setting.
If you decide not to change the settings, touch **[↶]** to return to the previous screen.
 - Cancel the Easy Handycam operation (p.26) to change the setup items for the standard operation.

Setup items

Available setup items (●) vary depending on the operating mode. The following settings are made automatically during Easy Handycam operation (p.24).

Position of lamp:



Easy Handycam

CAMERA SET (p.48)

PROGRAM AE	●	●	–	AUTO
SPOT METER	●	●	–	AUTO
EXPOSURE	●	●	–	AUTO
WHITE BAL.	●	●	–	AUTO
AUTO SHUTTER	●	–	–	ON
SPOT FOCUS	●	●	–	AUTO
FOCUS	●	●	–	AUTO
FLASH SET *2	–	●	–	⚡ *1/OFF
SUPER NSPLUS	●	–	–	OFF
NS LIGHT	●	●	–	OFF
COLOR SLOW S	●	–	–	OFF
SELF-TIMER	●	–	–	OFF
SELF-TIMER	–	●	–	OFF
DIGITAL ZOOM	●	–	–	OFF
WIDE SELECT *3	●	–	–	4:3
STEADYSHOT	●	–	–	ON

STILL SET (p.53)

BURST *2	–	●	–	OFF
QUALITY	–	●	–	FINE
IMAGE SIZE *2	–	●	–	●

PICT.APPLI. (p.54)

FADER	●	–	–	OFF
D.EFFECT	●	–	–	OFF
PICT.EFFECT	●	–	–	OFF
REC CTRL *4	–	–	●	–
USB SELECT *5	●	●	●	–
DEMO MODE	●	–	–	ON

HDD SET (p.55)

HDD FORMAT	●	●	●	●
HDD INFO	●	●	●	–
DROP SENSOR	●	●	●	ON
EMPTY HDD	●	●	●	–

Position of lamp: Movie Still PLAY/EDIT **Easy Handycam**

STANDARD SET (p.57)

REC MODE	●	–	–	HQ
VOLUME	–	–	●	●*1
MULTI-SOUND	–	–	●	STEREO
MICREF LEVEL *2	●	–	–	NORMAL
LCD SET	●	●	●	–/NORMAL/–/–*1
TV TYPE *2	●	●	●	–
USB SPEED	●	●	●	–*1
DATA CODE	–	–	●	DATE/TIME
DISPLAY	–	–	●	–*1
REMAINING	●	–	–	AUTO
REMOTE CTRL *2	●	●	●	ON
REC LAMP *2	●	●	–	ON
BEEP	●	●	●	●*1
DISP OUTPUT	●	●	●	LCD PANEL
SETUP ROTATE	●	●	●	–
A.SHUT OFF	●	●	●	5min
CALIBRATION	–	–	●	–

TIME/LANGU. (p.60)

CLOCK SET	●	●	●	●*1
AREA SET	●	●	●	–*1
SUMMERTIME	●	●	●	–*1
LANGUAGE	●	●	●	–*1

*1 The setting values before Easy Handycam operation are maintained.

*2 DCR-SR50E/SR60E/SR70E/SR80E

*3 DCR-SR30E/SR40E

*4 DCR-SR60E/SR80E

*5 [USB SELECT] appears automatically when your camcorder is connected to a computer or other device with the Handycam Station and the USB cable.

CAMERA SET

Settings to adjust your camcorder to the recording conditions (EXPOSURE/WHITE BAL./STEADYSHOT, etc.)

The default settings are marked with ►.
The indicators in parentheses appear when the items are selected.
See page 44 for details on selecting setup items.

PROGRAM AE

You can record images effectively in various situations with the PROGRAM AE function.

► AUTO

Select to automatically record images effectively without the [PROGRAM AE] function.

SPOTLIGHT* (☹)



Select to prevent people's faces from appearing excessively white when subjects are lit by strong light.

PORTRAIT (Soft portrait) (👤)



Select to bring out the subject such as people or flowers while creating a soft background.

SPORTS* (Sports lesson) (🏃)



Select to minimize shake when shooting fast moving subjects.

BEACH&SKI* (🏖)



Select to prevent people's faces from appearing dark in strong light or reflected light, such as at a beach in midsummer or on a ski slope.

SUNSET&MOON** (🌅)



Select to maintain the atmosphere of situations such as sunsets, general night views or fireworks.

LANDSCAPE** (🏞)



Select to shoot distant subjects clearly. This setting also prevents your camcorder from focusing on glass or metal mesh in windows that comes in between the camcorder and the subject.

- Items with one asterisk (*) can be adjusted so as not to focus on subjects only a short distance away. Items with two asterisks (**) can be adjusted to focus on subjects farther away.
- The setting returns to [AUTO] after you remove the power source for more than five minutes.

SPOT METER (Flexible spot meter)

You can adjust and fix the exposure to the subject, so that it is recorded in suitable brightness even when there is strong contrast between the subject and the background, such as subjects in the spotlight on stage.

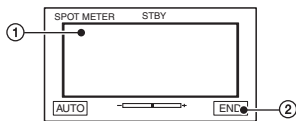

- ① Touch the point where you want to fix and adjust the exposure on the screen. \longleftrightarrow appears.
- ② Touch [END].

To return the setting to automatic exposure, touch [AUTO]→[END].

- If you set [SPOT METER], [EXPOSURE] is automatically set to [MANUAL].
- The setting returns to [AUTO] after you remove the power source for more than five minutes.

EXPOSURE

You can fix the brightness of an image manually. When recording indoors on a clear day, for example, you can avoid backlight shadows on people next to the window by fixing the exposure to that of the wall side of the room.

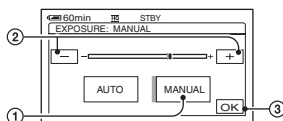

- ① Touch [MANUAL].
⇔ appears.
- ② Adjust the exposure by touching
[-] / [+].
- ③ Touch [OK].

To return the setting to automatic exposure, touch [AUTO] → [OK].

- The setting returns to [AUTO] after you remove the power source for more than five minutes.

WHITE BAL. (White balance)

You can adjust the color balance to the brightness of the recording environment.

► AUTO

The white balance is adjusted automatically.

OUTDOOR (☀)

The white balance is adjusted to be appropriate for the following recording conditions:

- Outdoors
- Night views, neon signs and fireworks
- Sunrise or sunset
- Under daylight fluorescent lamps

INDOOR (☾)

The white balance is adjusted to be appropriate for the following recording conditions:

- Indoors
- At party scenes or studios where the lighting conditions change quickly
- Under the video lamps of those at a studio, or under sodium lamps or incandescent-like color lamps

ONE PUSH (📷)

The white balance will be adjusted according to the ambient light.

- ① Touch [ONE PUSH].
- ② Frame a white object such as a piece of paper, to fill the screen under the same lighting conditions as you will shoot the subject.
- ③ Touch [📷].
📷 flashes quickly. When the white balance has been adjusted and stored in the memory, the indicator stops flashing.
 - Keep framing white object while 📷 is flashing quickly.
 - 📷 flashes slowly if white balance could not be set.
 - 📷 keeps flashing even after you have touched [OK], set [WHITE BAL.] to [AUTO].

- When you have changed the battery pack while [AUTO] is selected, or you bring your camcorder outdoors from inside the house while using fixed exposure, select [AUTO] and aim your camcorder at a nearby white object for about 10 seconds for better color balance adjustment.
- Redo the [ONE PUSH] procedure if you change the [PROGRAM AE] settings, or bring your camcorder outdoors from inside the house, or vice versa during the [ONE PUSH] is set to on.
- Set [WHITE BAL.] to [AUTO] or [ONE PUSH] under white or cool white fluorescent lamps.
- The setting returns to [AUTO] after you remove the power source for more than five minutes.

AUTO SHUTTER

Automatically activates the electronic shutter to adjust the shutter speed when recording in bright conditions if you set it to [ON] (the default setting).

SPOT FOCUS

You can select and adjust the focal point to aim it at a subject not located in the center of the screen.

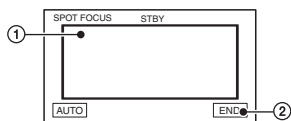

① Touch the subject on the screen.
☑ appears.

② Touch [END].

To adjust the focus automatically, touch [AUTO]→[END] in step ①.



- If you set [SPOT FOCUS], [FOCUS] is automatically set to [MANUAL].
- The setting returns to [AUTO] after you remove the power source for more than five minutes.



FOCUS

You can adjust the focus manually. Select this when you want to focus on a certain subject intentionally.



① Touch [MANUAL].
☑ appears.

② Touch  (focusing on close subjects)/
 (focusing on distant subjects) to sharpen the focus.

 appears when the focus cannot be adjusted any closer, and  appears when the focus cannot be adjusted farther away.

③ Touch [OK].

To adjust the focus automatically, touch [AUTO]→[OK] in step ①.

- It is easier to focus on the subject by moving the power zoom lever towards T (telephoto) to adjust the focus, then towards W (wide angle) to adjust the zoom for recording. When you want to record a subject at close range, move the power zoom lever to W (wide angle), then adjust the focus.
- The minimum distance required between your camcorder and the subject to get a sharp focus is about 1 cm (about 1/2 inch) for wide angle and about 80 cm (about 2 5/8 feet) for telephoto.
- The setting returns to [AUTO] after you remove the power source for more than five minutes.

FLASH SET (DCR-SR50E/SR60E/SR70E/SR80E)

You can set this function when you use an external flash (optional) that is compatible with your camcorder. Attach the external flash to the Active Interface Shoe (p.73).

■ FLASH MODE

▶ ON

Always flashes when recording still images.

ON

Always pre-flashes to reduce redeye phenomenon, then flashes when recording still images

AUTO

Always flashes automatically.

AUTO

Always pre-flashes automatically to reduce redeye phenomenon, then flashes automatically when recording still images.

- If the flash is not capable of preventing the redeye phenomenon, you can select only [ON] or [AUTO].
- The setting returns to [ON] after you remove the power source for more than five minutes.

■ FLASH LEVEL

HIGH (⚡+)

Makes the flash level higher.

▶ NORMAL (⚡)

LOW (⚡-)

Makes the flash level lower.

- The setting returns to [NORMAL] after you remove the power source for more than five minutes.

SUPER NSPLUS (Super NightShot plus)

You can record images at a maximum of 16 times the sensitivity of NightShot plus in dark places.

Set [SUPER NSPLUS] to [ON] while the NIGHTSHOT PLUS switch is set to ON.  and ["SUPER NSPLUS"] flash on the screen.

To cancel the setting, set [SUPER NSPLUS] to [OFF].

- Do not use NightShot plus and [SUPER NSPLUS] in bright places. This may cause a malfunction.
- Do not cover the infrared port with your fingers or other objects (p.32).
- Remove the conversion lens (optional).
- Adjust the focus manually ([FOCUS], p.50), when it is hard to focus automatically.
- The shutter speed of your camcorder changes depending on the brightness. The motion of the image may slow down at this time.

NS LIGHT (NightShot Light)

You can record clearer images with the light which emits infrared light while using NightShot plus. The default setting is [ON].

- Do not cover the infrared port with your fingers or other objects (p.32).
- Remove the conversion lens (optional).
- The maximum shooting distance using [NS LIGHT] is about 3 m (10 feet).

COLOR SLOW S (Color Slow Shutter)

You can record an image brighter in color even in dark places.

Set [COLOR SLOW S] to [ON].  and [COLOR SLOW SHUTTER] flash on the screen.

To cancel [COLOR SLOW S], touch [OFF].

- Adjust the focus manually ([FOCUS], p.50), when it is hard to focus automatically.
- The shutter speed of your camcorder changes depending on the brightness. The motion of the image may slow down at this time.

SELF-TIMER

The self-timer starts recording a movie after about 10 seconds.

Press START/STOP when

 SELF-TIMER is set to [ON] (☺).

To cancel the count down, touch [RESET].

To cancel the self-timer, select [OFF].

- You can also use the self-timer with START/STOP on the Remote Commander (DCR-SR50E/SR60E/SR70E/SR80E) (p.38).

SELF-TIMER

The self-timer starts recording a still image after about 10 seconds.

Press PHOTO when  SELF-TIMER is set to [ON] (☺).

To cancel the count down, touch [RESET].

To cancel the self-timer, select [OFF].

- You can also use the self-timer with PHOTO on the Remote Commander (DCR-SR50E/SR60E/SR70E/SR80E) (p.38).

DIGITAL ZOOM

You can select the maximum zoom level in case you want to zoom greater than optical zoom magnification listed as below. Note that the image quality decreases when you are using the digital zoom.

(optical zoom)

DCR-SR30E/SR40E	20 ×
DCR-SR50E/SR60E/ SR70E/SR80E	12 ×

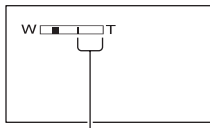

The right side of the bar shows the digital zooming factor. The zooming zone appears when you select the zooming level.

DCR-SR30E/SR40E

▶ OFF

Up to 20 × zoom is performed optically.

40 ×

Up to 20 × zoom is performed optically, and after that up to 40 × zoom is performed digitally.

800 ×

Up to 20 × zoom is performed optically, and after that, up to 800 × zoom is performed digitally.

DCR-SR50E/SR60E/SR70E/SR80E

▶ OFF

Up to 12 × zoom is performed optically.

24 ×

Up to 12 × zoom is performed optically, and after that up to 24 × zoom is performed digitally.

800 ×

Up to 12 × zoom is performed optically, and after that, up to 800 × zoom is performed digitally.

WIDE SELECT (DCR-SR30E/SR40E)

You can record an image in the screen aspect ratio matching a TV screen.

▶ 4:3

When recording an image matching on a standard (4:3) TV screen

16:9 WIDE

When recording an image matching on a wide (16:9) TV screen.

Image recorded in [16:9 WIDE]:

When playing back an image on the LCD screen



When playing back an image on a wide (16:9) TV screen ^{*1}



When playing back an image on a standard (4:3) TV screen ^{*2}



^{*1} If you set your TV to the full-screen mode, you can view the image matching the wide (16:9) TV screen.

^{*2} If you play back an image on a standard (4:3) TV screen, the image is vertically displayed. When the TV is set to the wide mode, the image is displayed just like the image displayed on the LCD screen.

- You cannot switch the screen aspect ratio in the following cases:
 - while recording movies
 - when [D.EFFECT] is set to [OLD MOVIE] (p.54)

STEADYSHOT

You can record images using [STEADYSHOT] (the default setting is [ON]). Set [STEADYSHOT] to [OFF] () when using a tripod or the conversion lens (optional).

STILL SET

Settings for still images (BURST/QUALITY/IMAGE SIZE, etc.)

The default settings are marked with ▶.
The indicators in parentheses appear when the items are selected.

See page 44 for details on selecting setup items.

BURST (DCR-SR50E/SR60E/ SR70E/SR80E)

You can record several still images one after another by pressing PHOTO.

▶ OFF



Select this when not recording continuously.

NORMAL ()

Records still images continuously at approximately 0.5 seconds intervals. The numbers of the maximum recordable images are as follows:

1.0M (): 8 images

VGA (0.3M) (): 21 images

 0.7M (): 8 images

EXP. BRKTG (BRK)

Records 3 images consecutively with different exposures at approximately 0.5 second intervals. You can compare the three images and select an image recorded at the best exposure.

- The flash will not function during continuous recording.
- The maximum number of images will be recorded in the self-timer mode or when you are operating with the Remote Commander (DCR-SR50E/SR60E/SR70E/SR80E).
- You may not be able to record continuous images up to the maximum number depending on the image size and the remaining hard disk space of the camcorder.
- [EXP. BRKTG] does not function, if the hard disk space is only available for less than three still images.
- It takes longer to record continuous images to the hard disk compared to normal recording. Record the next still image after the scroll bar indicator (■■■■) and the ACCESS lamp turns off.

QUALITY

▶ FINE (FINE)

Records still images at the fine image quality level.

STANDARD (STD)

Records still images at the standard image quality level.

The size of still images (Approx. kB)



	1.0M	0.7M	VGA (0.3M)
			
FINE (FINE)	500	380	150
STANDARD (STD)	210	160	60





IMAGE SIZE (DCR-SR50E/ SR60E/SR70E/SR80E)

▶ 1.0M ()

Records still images clearly.

VGA (0.3M) ()

Allows for the maximum number of images to be recorded.

- When the aspect ratio is changed to 16:9 (wide), the image size is changed to  0.7M () (p.23).
- The number of pixels for each image size is as follows:
1.0M : 1152×864
VGA (0.3M) : 640×480
 0.7M : 1152×648
- The maximum number of recordable still images is 9,999.
- The image size of DCR-SR30E/SR40E is set to [VGA (0.3M)] () .

PICT.APPLI.

Special effects on images or additional functions on recording/playback (PICT.EFFECT/D.EFFECT, etc.)

The default settings are marked with ►. The indicators in parentheses appear when the items are selected.

See page 44 for details on selecting setup items.

FADER

You can add the following effects to currently recording images.

- ① During standby (fade in) or recording (fade out), select the desired effect, then touch [OK]. When you select [OVERLAP] or [WIPE], the image is stored as a still image. (While storing the image, the screen turns to blue.)
- ② Press START/STOP.
The fader indicator stops flashing and disappears when the fade is complete.

To cancel the current setting before your operation, touch [OFF] in step ①. Once you press START/STOP, the setting is cancelled.



WHITE FADER



BLACK FADER



OVERLAP (fade in only)





WIPE (fade in only)



D.EFFECT (Digital effect)

You can add digital effects to your recordings.  appears.

- ① Touch the desired effect.
- ② When you select [LUMI. KEY], adjust the effect with  / , then touch [OK].
The image displayed when you touch [OK] is saved as a still image.
- ③ Touch [OK].
 appears.

To cancel [D.EFFECT], touch [OFF] in step ①.

LUMI. KEY (luminance key)

Replaces a brighter area in a previously recorded still image (e.g. a person) with a movie.



OLD MOVIE

Adds an sepia colored effect to movies.

- The aspect ratio cannot be changed to 16:9 (wide) when [OLD MOVIE] is selected.

PICT.EFFECT (Picture effect)

You can add special effects to a picture during recording.  appears.

► OFF

Does not use [PICT.EFFECT] setting.

SEPIA

Picture appears in sepia.

B&W

Picture appears in black and white.

PASTEL



Picture appears like a pale pastel drawing.

MOSAIC



Picture appears mosaic-patterned.

REC CTRL (DCR-SR60E/SR80E)

See page 69.

USB SELECT

You can copy images to a computer when connecting your camcorder to your computer with the USB cable and the Handycam Station or print still images when connecting to the PictBridge compliant printer (p.71).

DVD BURN

The item has the same function as the DVD BURN button on the Handycam Station body. See page 81.

HDD

When connecting the camcorder to a computer via USB, you can access to the hard disk drive of the camcorder from the computer.

PictBridge PRINT

See page 71.

- For details on a computer connection, see page 74.

DEMO MODE

The default setting is [ON] so that you can view the demonstration in about 10 minutes, after you have set the POWER switch to  (Movie).

- The demonstration will be suspended in situations such as those described below.
 - when you touch the screen during the demonstration (The demonstration starts again in about 10 minutes.)
 - when the POWER switch is set to  (Still)
 - when you set the NIGHTSHOT PLUS switch to ON (p.32)

HDD SET

Settings for the hard disk (HDD FORMAT/HDD INFO, etc.)

See page 44 for details on selecting setup items.

HDD FORMAT

You can delete all the images on the hard disk of the camcorder to recover recordable free space to allow you to write in.

- To avoid the loss of important images, they should be saved (p.41) before performing [HDD FORMAT].

① To perform [HDD FORMAT], touch [YES] → [YES].

② When [Completed.] is displayed, touch .

- Protected images are also deleted.
- While [HDD FORMAT] is activated, do not remove the AC Adaptor or the battery pack.
- While [HDD FORMAT] is activated, do not apply vibration or shock.

HDD INFO

The hard disk information of the camcorder can be displayed to allow you to check approximate used and free spaces.

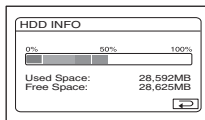

- The calculation for hard disk space is 1MB = 1,048,576 bytes. The fractions less than MB are discarded when the hard disk space is displayed. Only the figures that are less than 30,000 MB (DCR-SR30E/SR40E/SR50E/SR60E) or 60,000 MB (DCR-SR70E/SR80E) for available and unavailable hard disk spaces appear.
- Since there is the management file area, the used space is not displayed as 0MB when you perform [HDD FORMAT] or [EMPTY HDD].

DROP SENSOR

The [DROP SENSOR] is set to [ON] as the default setting. When the drop sensor senses a drop of the camcorder ( appears), you may not record/play back the images to protect the internal hard disk.





- Set the drop sensor to [ON] (default setting) when you use the camcorder. Otherwise when you drop the camcorder, you may damage the hard disk of the camcorder.
- In a non-gravity situation, the drop sensor activates. When you record images during activity such as roller-coasting or skydiving, you can set [DROP SENSOR] to [OFF] () not to activate the drop sensor.
- [DROP SENSOR] is automatically set to [ON] after you remove the power source for more than five minutes.

EMPTY HDD

[EMPTY HDD] allows you to write non important data onto the hard disk of the camcorder. In this way, it may become more difficult to recover any original data. When you dispose or transfer the camcorder to others, it is recommended that you perform [EMPTY HDD].

Connect your camcorder to the wall socket using the supplied AC Adaptor for this operation (p.14).

- If you perform [EMPTY HDD], all the images are deleted. To avoid the loss of important images, they should be saved (p.41) before performing [EMPTY HDD].

- ① Be sure the AC Adaptor is connected. While pressing DISP/BATT INFO, slide the POWER switch to turn on.
 - You can perform this operation, whichever position of the  (Movie) /  (Still) /  (PLAY/EDIT) is lit.
- ② Touch [P.MENU] →  HDD SET → [EMPTY HDD] → [YES] → [YES].
- ③ When [Completed.] is displayed, touch .

- If you do not follow the instructions above to turn on the switch, [EMPTY HDD] cannot be displayed on the set up items.
- The actual performing time for [EMPTY HDD] is as follows:
DCR-SR30E/SR40E/SR50E/SR60E
approx. 30 minutes
DCR-SR70E/SR80E
approx. 60 minutes
- Remove all cables except the AC Adaptor. Do not remove the AC Adaptor during the operation.
- While performing [EMPTY HDD], do not apply any vibrations or shocks.
- When you have cancelled [EMPTY HDD] during the operation, perform [HDD FORMAT] or [EMPTY HDD] when you use the camcorder for the next time.
- Protected images (p.65) are also deleted.



STANDARD SET

Settings while recording or other basic settings (REC MODE/LCD SET/USB SPEED, etc.)

The default settings are marked with ▶.
The indicators in parentheses appear when the item is selected.

See page 44 for details on selecting setup items.

REC MODE (Recording mode)

You can select an image quality of the movie from three levels.

▶ HQ (HQ)

Records in high quality mode.

SP (SP)

Records in standard quality mode.

LP (LP)

Increases the recording time (Long Play).

Recordable time:

	DCR-SR30E/ SR40E/SR50E/ SR60E	DCR-SR70E/ SR80E
HQ	approx. 7 hours 20 min.	approx. 14 hours 40 min.
SP	approx. 10 hours 50 min.	approx. 21 hours 40 min.
LP	approx. 20 hours 50 min.	approx. 41 hours 50 min.

- The recordable time varies depending on the subject.
- The remaining recordable time is displayed on the screen.
- The maximum number of recordable movies is 9,999.
- If you record in the LP mode, the quality of scenes may be degraded, or scenes with quick movements may appear with a block noise when you play back the images.
- When measuring media capacity, 1GB equals 1 billion bytes, a portion of which is used for data management.

VOLUME

See page 30.

MULTI-SOUND

You can select whether to play back audio recorded using [REC CTRL](p.69) with dual sound or stereo sound.

▶ STEREO

Plays back with main and sub sound (or stereo sound).

1

Plays back with main sound or the left channel sound.

2

Plays back with sub sound or the right channel sound.

- The setting returns to [STEREO] after you remove the power source for more than five minutes.

MICREF LEVEL (DCR-SR50E/ SR60E/SR70E/SR80E)

You can select the microphone level for recording sound.

Select [LOW] when you want to record exciting and powerful sound in a concert hall, etc.

▶ NORMAL

Records various surround sounds, converting them into the same level.

LOW (↑↓)

Records surround sound faithfully. This setting is not suitable for recording conversations.

- The setting returns to [NORMAL] after you remove the power source for more than five minutes.

LCD SET

The recorded image will not be affected even when you change the setting.

LCD BRIGHT

You can adjust the brightness of the LCD screen.

- Adjust the brightness with \square / \square .
- Touch \square .

LCD BL LEVEL

You can adjust the brightness of the LCD screen's backlight.

► NORMAL

Standard brightness.

BRIGHT

Brightens the LCD screen.

- When you use the AC Adaptor as the power source, [BRIGHT] is automatically selected for the setting.
- When you select [BRIGHT], battery life is slightly reduced during recording.

LCD COLOR

You can adjust the color on the LCD screen with \square / \square .



Low intensity

High intensity

WIDE DISPLAY (DCR-SR30E/SR40E)

You can select how a 16:9 (wide) aspect ratio image appears on the LCD screen.

► LETTER BOX

Normal setting (standard type of screen)

SQUEEZE (Squeeze)

Expands the image vertically if black bands at the top and bottom in 16:9 (wide) aspect ratio are undesirable.

TV TYPE (DCR-SR50E/SR60E/ SR70E/SR80E)

See page 39.

USB SPEED

You can select data transfer speed used to transfer data to your computer.

► AUTO

Sends data by switching automatically between the Hi-Speed USB (USB 2.0) and the speed corresponding to USB1.1 (full speed transfer).

FULL SPEED

Sends data corresponding to USB1.1 (full speed transfer).

DATA CODE

You can check the information recorded automatically (data code) during playback.

► OFF

Data code is not displayed.

DATE/TIME

Displays the date and time of recorded images.

CAMERA DATA

Displays the camera setting data of recorded images.

DATE/TIME

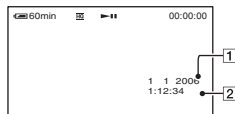

- Date
- Time

CAMERA DATA

Movie

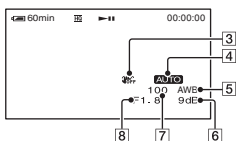

Still image

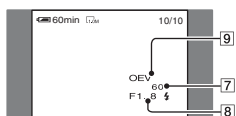

- 3 SteadyShot off
- 4 Exposure
- 5 White balance
- 6 Gain
- 7 Shutter speed
- 8 Aperture value
- 9 Exposure value

- appears for an image recorded using a flash (optional).
- The data code is displayed on the TV screen, if you connect your camcorder to a TV.
- The indicator toggles through the following sequences as you press DATA CODE on the Remote Commander: DATE/TIME → CAMERA DATA → OFF (no indication) (DCR-SR50E/SR60E/SR70E/SR80E).
- Depending on the hard disk condition of the camcorder, bars [---:---] appear.
- The setting returns to [OFF] after you remove the power source for more than five minutes.

DISPLAY

You can select the number of thumbnails that appear on the VISUAL INDEX screen.

Thumbnail Glossary (p.121)

► ZOOM LINK

Change the number of thumbnails (6 or 12) with the zoom lever on your camcorder.*

6IMAGES

Displays thumbnails of 6 images.

12IMAGES

Displays thumbnails of 12 images.

* You can operate with the zoom buttons on the LCD frame or on the Remote Commander (DCR-SR50E/SR60E/SR70E/SR80E).

REMAINING

► AUTO

Displays the remaining hard disk free space for about eight seconds as described below.

- When your camcorder recognizes the free hard disk space, with the POWER switch is set to (Movie)
- When you press DISP/BATT INFO to switch the screen display from off to on, with the POWER switch is set to (Movie)
- When you start recording from the line input (DCR-SR50E/SR60E/SR70E/SR80E)

ON

Always displays the remaining hard disk free space indicator.

- When the available free space on the hard disk of the camcorder becomes less than five minutes for movie recording, the remaining free space will be displayed all the time.

REMOTE CTRL (Remote control) (DCR-SR50E/SR60E/SR70E/ SR80E)

The default setting is [ON] so that you can use the supplied Remote Commander (p.38).

- Set to [OFF] to prevent your camcorder from responding to a command sent by other device's remote control.
- The setting returns to [ON] after you remove the power source for more than five minutes.

REC LAMP (Recording lamp) (DCR-SR50E/SR60E/SR70E/ SR80E)

The camera recording lamp will not light up during recording when you set this to [OFF]. (The default setting is [ON].)



TIME/LANGU.

(CLOCK SET/AREA SET/LANGUAGE, etc.)

See page 44 for details on selecting setup items.

BEEP

▶ ON

A melody sounds when you start/stop recording, or operate the touch panel.

OFF

Cancels the melody.

DISP OUTPUT

▶ LCD PANEL

Shows displays such as the counter on the LCD screen.

V-OUT/PANEL

Shows the display also on the TV screen.

SETUP ROTATE

▶ NORMAL

Scrolls the setup items downwards by touching .

OPPOSITE

Scrolls the setup items upwards by touching .

A.SHUT OFF (Auto shut off)

▶ 5min

The camcorder is automatically turned off, when you do not operate your camcorder for more than approximately 5 minutes.

NEVER

The camcorder is not automatically turned off.

- When you connect your camcorder to a wall socket, [A.SHUT OFF] is automatically set to [NEVER].

CALIBRATION

See page 119.

CLOCK SET

See page 22.

AREA SET

You can adjust a time difference without stopping the clock.
 Set your local area with ▲/▼ when using your camcorder overseas.
 Refer to “World time difference” on page 115..

SUMMERTIME

You can change this setting without stopping the clock.
 Set to [ON] to move the time forward one hour.

LANGUAGE



You can select the language to be used on the LCD screen.

- Your camcorder offers [ENG[SIMP]] (simplified English) for when you cannot find your native tongue among the options.

Customizing Personal Menu

You can add desired setup items to Personal Menu, and customize Personal Menu settings. This is convenient if you add frequently used setup items to Personal Menu.

Adding a setup item

You can add up to 28 setup items for  (Movie),  (Still) or  (PLAY/EDIT). Delete a less important setup item, if you want to add more.

- 1 Touch **[P-MENU]** → **[P-MENU SET UP]** → **[ADD]**.

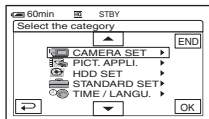

- 2 Touch **[▲]/[▼]** to select a setup category, then touch **[OK]**.

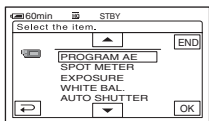

- 3 Touch **[▲]/[▼]** to select a setup item, then touch **[OK]** → **[YES]** → **[X]**.

The setup item is added to the end of list.

Deleting a setup item

- 1 Touch **[P-MENU]** → **[P-MENU SET UP]** → **[DELETE]**.

If the desired setup item is not displayed, touch **[▲]/[▼]**.

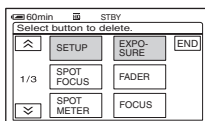

- 2 Touch the setup item that you want to delete.

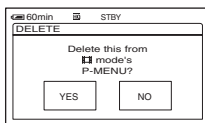

- 3 Touch **[YES]** → **[X]**.

- You cannot delete **[SETUP]** and **[P-MENU SET UP]**.

Arranging the order of setup items displayed on Personal Menu

- 1 Touch **[P-MENU]** → **[P-MENU SET UP]** → **[SORT]**.

If the desired setup item is not displayed, touch **[▲]**/**[▼]**.

- 2 Touch the setup item you want to move.

- 3 Touch **[▲]**/**[▼]** to move the setup item to the desired place.

- 4 Touch **[OK]**.

To sort more items, repeat step 2 to 4.

- 5 Touch **[END]** → **[X]**.

- You cannot move [P-MENU SET UP].

Initializing the Personal Menu settings (Reset)

Touch **[P-MENU]** → **[P-MENU SET UP]** → **[RESET]** → **[YES]** → **[YES]** → **[X]**.

Creating the Playlist

A Playlist is a list displaying your favorite movies selected from the original movies. Playlist  Glossary (p.121)

- Do not remove the battery pack or the AC Adaptor from your camcorder while editing the Playlist. It may damage the hard disk of the camcorder.
- You can add up to 99 scenes in the Playlist.
- You cannot add still images on the Playlist.
- If you delete the original image data from the camcorder, they are automatically deleted from the Playlist.



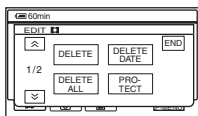

1 Slide the POWER switch to light up the (PLAY/EDIT) lamp.

The VISUAL INDEX screen appears.

2 Select (Movie) tab, then touch [EDIT].





3 Touch [ADD].

- Touch / to display [ ADD] when [ ADD] is not displayed.

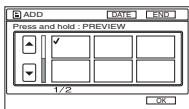
4 Select the scene to be added to the Playlist.



The selected scene is marked with .

- If you press and hold the thumbnail of the image, you can check the image. Touch  to return to the previous screen.
- You can select several images at once.

5 Touch → [YES].

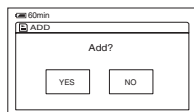

To add all the images selected by date on the Playlist

Touch [ ADD DATE] in step 3.

Erasing unnecessary scenes from the Playlist

1 Slide the POWER switch to light up the (PLAY/EDIT) lamp.

The VISUAL INDEX screen appears.

2 Touch (Playlist) tab → [EDIT] → [ERASE].

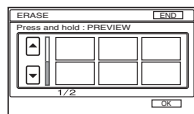

3 Select the scene to be deleted from the list.

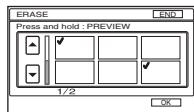

The selected scene is marked with .

- If you press and hold the thumbnail of the image, you can check the image. Touch  to return to the previous screen.
- You can select several images at once.

4 Touch OK → [YES].

To erase all the scenes at the same time

Touch [ERASE ALL] in step 2 → [YES].

- The original images are not changed even if you erase the images from the Playlist.

Changing the order within the Playlist

1 Slide the POWER switch to light up the (PLAY/EDIT) lamp.

The VISUAL INDEX screen appears on the LCD screen.

2 Touch (Playlist) tab → [EDIT] → [MOVE].

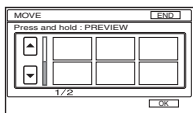

3 Select the scene to be moved.

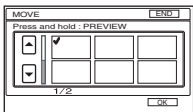

The selected scene is marked with ✓.

- If you press and hold the thumbnail of the image, you can check the image. Touch to return to the previous screen.
- You can select several images at once.

4 Touch OK.

5 Select the designated position with [←]/[→].

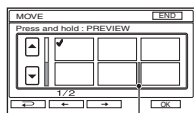

Move destination bar

6 Touch OK → [YES].

- When you have selected several images, the scenes are moved following the order appeared in the Playlist.
-

Playing the Playlist

You can play the Playlist.

1 Slide the POWER switch to light up the (PLAY/EDIT) lamp.

The VISUAL INDEX screen appears on the LCD screen.

2 Touch (Playlist) tab.

A list of the scenes added in the Playlist appears.

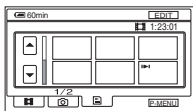

3 Touch the image from which you want to playback.

The screen returns to the VISUAL INDEX screen when the Playlist is played back from the selected scene to the end.

- You can save images in your Playlist on a DVD using a computer. For details, see page 95.

Setting image protection (Protection)

You can protect selected images not to be deleted (p.42). By setting protection, you can prevent your images from being deleted by mistake.

Protecting the desired image

You can set protection to an individual image.

1 Slide the POWER switch to light up the (PLAY/EDIT) lamp.

The VISUAL INDEX screen appears on the LCD screen.

2 Touch [EDIT] → [PROTECT].

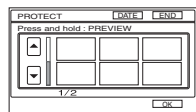

3 Touch the desired image you want to protect.

The selected image is marked with .

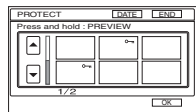



- You can select several images at once.
- If you press and hold the thumbnail of the image, you can check the image. Touch  to return to the previous screen.

4 Touch [OK] → [YES].

Protection on the image is set.

-
- The protected image is marked with  on the VISUAL INDEX screen.

To cancel protection from the desired image

Touch the image marked with  in step 3.  mark disappears.

To cancel protection from the desired image by date

Touch [EDIT] → [PROTECT DATE] → [OFF] in step 4.  does not appear on the images that are cancelled for protection.

Protecting images by date

You can set protection from selected images by recording date.

1 Slide the POWER switch to light up the (PLAY/EDIT) lamp.

The VISUAL INDEX screen appears on the LCD screen.

2 Touch [DATE].

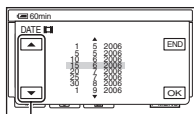

Previous/Next Date button

3 Select the desired date to protect with Previous/Next Date button, then touch .

Return to the VISUAL INDEX screen.

4 Touch [EDIT] → [PROTECT DATE] → [ON].

Set protection for all the images in the selected folder by date.

- Protected images are marked with  on VISUAL INDEX screen.

Dubbing to VCR/DVD devices

You can save images on your camcorder to VCRs or DVD recorders. Connect your camcorder to the wall socket using the supplied AC Adaptor for this operation (p.14). Refer also to the instruction manuals supplied with the devices to be connected.

- To save image data on your computer or to save DVD using a computer, see page 80, 84.
- You cannot use the i.LINK cable.
- Since you dub your data to other device through analogue data, the image quality may decline.

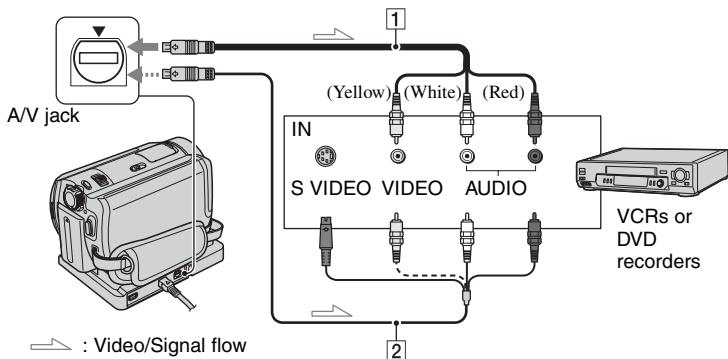

1 A/V connecting cable (supplied)

The Handycam Station and your camcorder are both equipped with A/V jacks (p.73). Connect the A/V connecting cable either to the Handycam Station or to your camcorder, according to your setup.

2 A/V connecting cable with S VIDEO (optional)

When connecting to another device via the S VIDEO jack, by using an A/V connecting cable with an S VIDEO cable (optional), higher quality images can be produced than with an A/V connecting cable. Connect the white and red plug (left/right audio) and the S VIDEO plug (S VIDEO channel) of the A/V connecting cable with an S VIDEO cable (optional). The yellow plug connection is not necessary. S VIDEO connection only will not output audio.



- To hide the screen indicators (such as a counter, etc.) on the screen of the monitor device connected, set [DISP OUTPUT] to [LCD PANEL] (the default setting, p.60).
- To record the date/time and camera data, display them on the screen (p.58).
- When you are connecting your camcorder to a monaural device, connect the yellow plug of the A/V connecting cable to the video input jack, and the red (right channel) or the white (left channel) plug to the audio input jack on the VCR or the TV.

1 Slide the POWER switch to light up the  (PLAY/EDIT) lamp.

Set [TV TYPE] according to the playback device (p.39).

2 Insert the recording media for your VCR or DVD recorder.

If your recording device has an input selector, set it to the input mode.

3 Connect your camcorder to the VCR/DVD device with the A/V connecting cable (supplied)  or the A/V connecting cable with S VIDEO (optional) .

- Connect your camcorder to the input jacks of a VCR or DVD device.
-

4 Start the playback on your camcorder, and record it on the recording device.

Refer to the instruction manuals supplied with your recording devices for details.

5 When dubbing is finished, stop your camcorder and the recording device.

- After dubbing your images, it is recommended that you delete unnecessary images from the hard disk of the camcorder (p.42).

Recording images from a TV or VCR/DVD device (DCR-SR60E/SR80E)

You can record images or TV programs from a VCR, TV or DVD device onto the hard disk of camcorder.

Connect your camcorder to the wall socket using the supplied AC Adaptor for this operation (p.14). Refer also to the instruction manuals supplied with the devices to be connected.

- On your camcorder, you cannot view images copied from a computer.

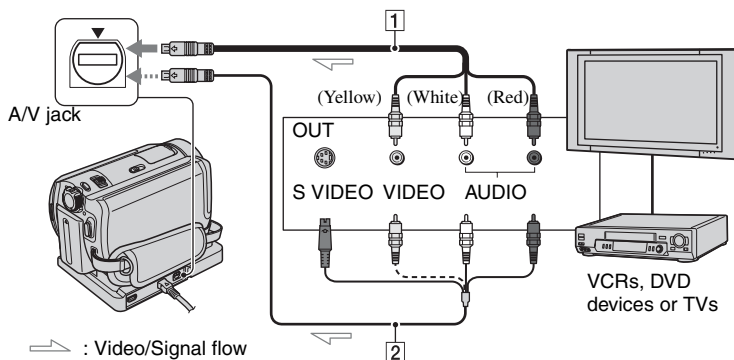

1 A/V connecting cable (supplied)

The Handycam Station and your camcorder are both equipped with A/V jacks (p.73). Connect the A/V connecting cable either to the Handycam Station or to your camcorder, according to your setup.

2 A/V connecting cable with S VIDEO (optional)

When connecting to another device via the S VIDEO jack, by using an A/V connecting cable with an S VIDEO cable (optional), higher quality images can be produced than with an A/V connecting cable. Connect the white and red plug (left/right audio) and the S VIDEO plug (S VIDEO channel) of the A/V connecting cable with an S VIDEO cable (optional). The yellow plug connection is not necessary. S VIDEO connection only will not output audio.

- You cannot record images from a TV with no output jacks.
- You cannot record TV programs which allow you to record once, or have copy control technology.
- When you are connecting your camcorder to a monaural device, connect the yellow plug of the A/V connecting cable to the video output jack, and the red (right channel) or the white (left channel) plug to the audio output jack on the VCR or the TV.
- Your camcorder can only record from a PAL source. For example, French video or TV programs (SECAM) cannot be recorded correctly. See page 114 for details on TV color systems.
- If you use a 21-pin adaptor to input PAL source, you need a dual direction 21-pin adaptor (optional).

1 Connect your camcorder to the TV or VCR/DVD device with the A/V connecting cable (supplied) **1** or the A/V connecting cable with S VIDEO (optional) **2**.

- Connect your camcorder to the output jacks of a TV or VCR/DVD device.

2 If you are recording from a VCR/DVD device, insert the video tape or the DVD into the playback device.

3 Slide the POWER switch to light up the  (PLAY/EDIT) lamp.

4 Touch  → [REC CTRL].

If you connected your camcorder to the device which has the S VIDEO jack, touch [SET] → [VIDEO INPUT] → [S VIDEO] → .

- Touch [SET] to change the recording mode or adjust the volume.
- Touch [SET] →  REMAIN → [ON] to display the remaining hard disk free space indicator all the time.

5 Start playing the cassette or the DVD on the play back device, or select a TV program.

The image played on the connected device appears on the LCD screen of your camcorder.

6 Touch [REC] at the point you want to start recording.

7 Touch  at the point you want to stop recording.

8 Touch [END].

-
- There may be a time difference between the point where you press [REC] and the actual point that the recording starts/stops.
 - You cannot record an image as a still image even if you press PHOTO during recording.

Printing recorded still images

(PictBridge compliant printer)

You can print out still images using a PictBridge compliant printer without connecting the camcorder to a computer.

PictBridge



- To print still images after having copied them onto a computer, see page 90.

Connect your camcorder to the printer

1 Turn on the printer.

2 Connect the Handycam Station to the wall socket using the supplied AC Adaptor.

3 Set the camcorder onto the Handycam Station securely, then slide the POWER switch to turn on.

- When you set the camcorder onto the Handycam Station, connect securely onto the interface connector of the Handycam Station (p.73).
- You can perform this operation, when whichever position of the  (Movie) /  (Still) /  (PLAY/EDIT) is lit.

4 Connect the  (USB) jack of the Handycam Station to the printer using the supplied USB cable.

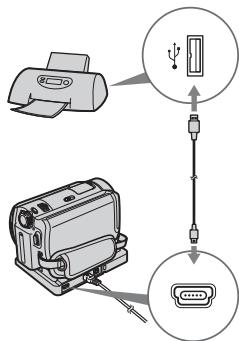

[USB SELECT] screen appears on the LCD screen.

5 Touch [PictBridge PRINT].

When connection is complete,  (PictBridge connecting) appears on the screen.

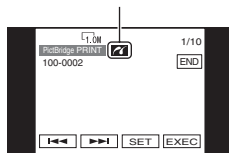

The still image appears.

- You can also display [USB SELECT] screen by touching [P-MENU] → [SETUP] →  PICT.APPLI. → [USB SELECT].
- We cannot guarantee the operation of models that are not PictBridge compatible.

Printing

1 Select the image to be printed with



2 Touch [SET] → [COPIES].

3 Select the number of copies to be printed with / .

You can set a maximum of 20 copies of one image to be printed.

4 Touch → [END].

To print the date on the image, touch [SET] → [DATE/TIME] → [DATE] or [DAY&TIME] → .

5 Touch [EXEC] → [YES].

When printing is finished, [Printing...] disappears and the image selection screen appears again. You can continue to print other images.

6 When printing is finished, touch [END] → [END].

- Refer also to the instruction manual for the printer to be used.
- Do not attempt the following operations when  is on the screen. The operations may not be performed properly.
 - Operating the POWER switch
 - Removing your camcorder from the Handycam Station
 - Removing the USB cable (supplied) from the printer
 - Removing the USB cable (supplied) from the Handycam Station
- If the printer stops working, remove the USB cable (supplied), turn the printer off and on again and restart the operation from the beginning.
- Depending on the type of printer you have, all four edges of an image may not be printed. Especially, the left and right ends of a 16:9 (wide) image may not be printed due to its aspect ratio.

- Some printer models may not support the date printing function. Refer to your printer's instruction manual for details.
- Still images that have a file size of 2 MB or more or are larger than 2304 × 1728 pixels cannot be printed.
- PictBridge is an industry standard established by the Camera & Imaging Products Association (CIPA). You can print still images without using a computer by connecting a printer directly to a digital video camera or digital still camera, regardless of model or manufacturer.

To remove the USB cable

- ① Touch [END].
- ② Remove the USB cable from the Handycam Station and the printer.

Jacks to connect external devices

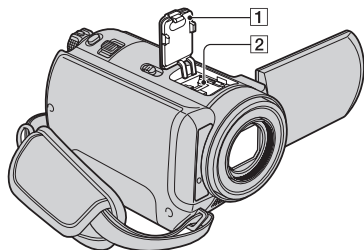

- 1 Shoe cover
(DCR-SR50E/SR60E/SR70E/SR80E)
- 2 Active Interface Shoe 
(DCR-SR50E/SR60E/SR70E/SR80E)

The Active Interface Shoe supplies power to optional accessories such as a video light, a flash, or a microphone. The accessory can be turned on or off as you operate the POWER switch on your camcorder. Refer also to the instruction manual supplied with your accessory for details.

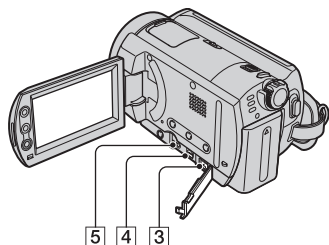

- 2 ...Open the shoe cover.
- 3 4 5 ...Open the jack cover.

- The Active Interface Shoe has a safety device for fixing the installed accessory securely. To connect an accessory, press down and push it to the end, and then tighten the screw. To remove an accessory, loosen the screw, and then press down and pull out the accessory.
- When you are recording with the external flash (optional), turn off the power of the external flash to prevent charging noise being recorded.
- When an external microphone (optional) is connected, it takes precedence over the internal microphone (p.34).

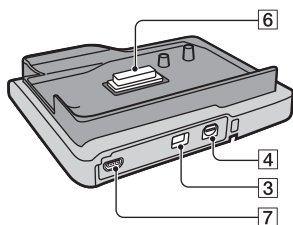

- 3 DC IN jack (p.14)
- 4 A/V (audio/video) jack (p.39, 67, 69)
- 5 REMOTE jack (DCR-SR50E/SR60E/SR70E/SR80E)
 - Connect other optional accessories.
- 6 Interface connector
- 7  (USB) jack (p.71, 81)

What you can do with the camcorder by connecting to your computer

If you install “ImageMixer for HDD Camcorder” in the supplied CD-ROM on your computer (p.77), you can operate various functions by connecting the camcorder with your computer.

■ DVD creation with One Touch (p.80)

By pressing the DVD BURN button on the Handycam Station, you can save images recorded on the camcorder to a DVD automatically. You can use easy DVD creation.

■ Copying and viewing images on the computer (p.84, 89)

You can view images recorded on the camcorder by copying them to your computer. You can print still images on a computer.

■ Creating a DVD with edited images (p.91, 93)

You can edit copied movies on a computer. Also, you can create DVD by selecting the copied images on a computer. The quality of a recorded image is maintained even when the image is saved on a DVD.

Main functions of the supplied software

- Other functions are also available other than described below. For details, see the help in the supplied software.

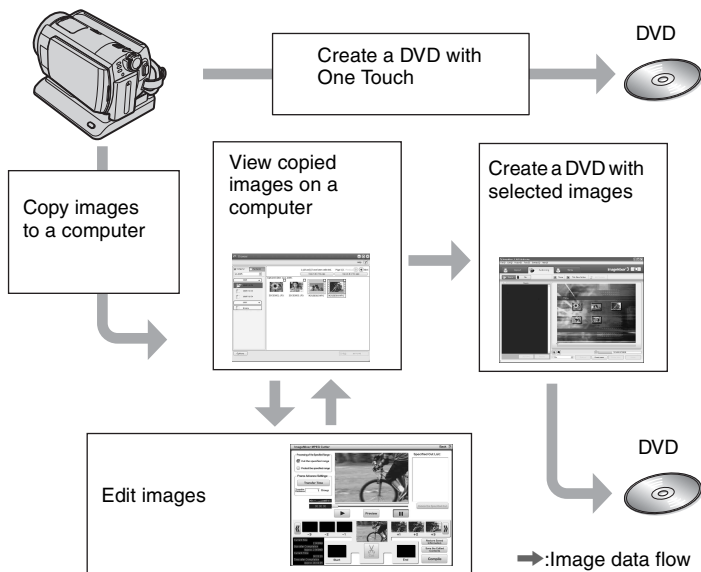

- You can also view the images on the hard disk of the camcorder on the computer.

System requirements

When using the supplied software, you need the following system requirements below.

OS : Windows 2000 Professional (Service Pack 3 or later) /Windows XP Home Edition/Windows XP Professional

- Standard installation is required. Operation is not assured if the above OS has been upgraded.

CPU : Intel Pentium III 800 MHz or faster (Pentium 4 1.7 GHz or faster recommended), or the equivalent CPU

Application : DirectX 9.0c or later (This product is based on DirectX technology. It is necessary to have DirectX installed.)

Sound system : 16 bit stereo sound card and stereo speakers

Memory : For Windows 2000 Professional: 128 MB or more (256 MB or more recommended)

For Windows XP Home Edition / Professional Edition: 256 MB or more (512 MB or more recommended)

Hard Disk : Available memory required for installation: 300 MB or more

Available free hard disk space for operations required: 14 GB or more (for dual layer DVD system, 28 GB or more required)

- When copying images to a computer, more available disk space required for saving image data than shown above.

Display : 4MB VRAM video card, Minimum 1024 × 768 dots, High color (16 bit color, 65 000 colors). This product will not operate correctly at less than 800 × 600 dots, and 256 colors or less.

USB port : As standard equipment (USB 2.0 recommended)

- The camcorder is compatible with Hi-Speed USB (USB2.0). You can transfer data at a faster rate using a computer compatible with Hi-Speed USB (USB2.0). When you connect a USB interface not compatible with Hi-Speed USB (USB2.0), the data transfer ratio will be that of USB 1.1 (USB full speed).

Disc Drive : A DVD writable drive

- Operations are not guaranteed on any computers fulfilling the above system requirements.

For inquires about the software

Pixela User Support Center

Pixela Home Page

ImageMixer for HDD Camcorder:

<http://www.pixela.co.jp/oem/sony/c/>

- North America (Los Angeles)
Telephone:
(Toll-Free) +1-800-458-4029
+1-213-341-0163
- Europe (U.K.) Telephone:
(Toll-Free) UK, Germany, France and Spain:
+800-1532-4865
Other countries:
+44-1489-564-764
- Asia (Philippines) Telephone:
+63-2-438-0090

Connecting with a Macintosh

The supplied software “ImageMixer for HDD Camcorder” is not compatible with a Macintosh. The functions offered by “ImageMixer for HDD Camcorder”, such as One Touch DVD Burn, cannot be used on the Macintosh.

To use the camcorder connecting with a Macintosh, apply the compliant software introduced on the following website.

- The system requirements for Macintosh are also shown on the website.

Pixela home page:

<http://www.pixela.co.jp/oem/sony/e/>

Compliant Software:

- Capty MPEG Edit EX (Video editing software)
- Capty DVD/VCD 2 (DVD authoring software)

Copying image files from the camcorder to a Macintosh

- ① Turn on your Macintosh.
- ② Connect the Handycam Station to the wall socket using the supplied AC Adaptor.
- ③ Set the camcorder onto the Handycam Station, then slide the POWER switch to turn on.
- ④ Connect the Ψ (USB) jack of the Handycam Station to your Macintosh using the supplied USB cable.

[USB SELECT] appears on the LCD screen of the camcorder.

- ⑤ Touch  HDD] on the [USB SELECT] screen.

Now you can access to the hard disk drive of the camcorder from your Macintosh.

If a screen asking whether to format the hard disk drive appears, select [NO].

- ⑥ Operate your Macintosh to copy image files from the camcorder.

You can edit the copied images and burn them on a DVD using the compliant software.

- For the folder structure of your camcorder, see page 116.
- When you copy image files to a Macintosh, do not delete the files on the camcorder directly from the Macintosh.

Use a special caution for preventing damages and malfunctions of the camcorder

- When connecting your camcorder with the USB cable or other cable, make sure you insert the connector in the correct direction. Do not insert the connector forcibly as it may damage the cable or your camcorder.
- Do not delete files on the camcorder through the computer, it may cause a malfunction.

On screenshots

- The screenshots are from Windows XP. The scenes may vary depending on the operating system of the computer.
- On screenshots in this Handbook, the application for English version is used. When you install the application, you can select other language (p.77).

On copyrights

Music works, sound recording or other third party musical contents you may acquire from CDs, the Internet or other sources (the “Music Contents”) are the copyrighted work of the respective owners thereof and are protected by copyright laws and other applicable laws of each country/region. Except to the extent expressly permitted by applicable laws, you are not permitted to use (including, without limitation, copying, modifying, reproducing, uploading, transmitting or placing to the external network accessible to the public, transferring, distributing, lending, licensing, selling and publishing) any of the Music Contents without obtaining authorization or approval of the respective owners thereof. License of ImageMixer for HDD Camcorder by Sony Corporation would not be construed as conferring to you by implication, estoppel or otherwise, any license or right to use the Music Contents.

Installing software

You need to install the software to your Windows computer. The installation is only required once.

1 Confirm that your camcorder is not connected to the computer.

2 Turn on the computer.

- Log on as Administrators for installation.
- Close all the applications running on the computer before installing the software.

3 Place the CD-ROM (supplied) on the disc drive of your computer.

The select screen for installation appears.



4 Click [ImageMixer for HDD Camcorder].

The installation screen appears.



If the screen does not appear, follow the steps below.

① Click [start], then click [My Computer] (For Windows 2000, double-click [My Computer] on the desktop.)

② Double-click [CAMCORDERSOFT (E:)] (CD-ROM)*

* Drive names (such as (E:)) vary depending on the computer.

③ Double-click [install.exe].

5 Click [Install].



6 Select the language for the application to be installed, then click [Next].



7 Click [Next].



- 8** Read [License Agreement], check [I accept the terms of the license agreement] when you agree, then click [Next].

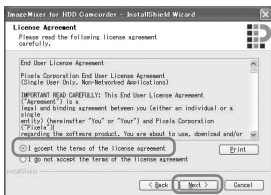

- 9** Select a folder to save the software, then click [Next].

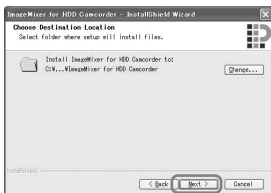

- 10** Select [PAL], then click [Next].

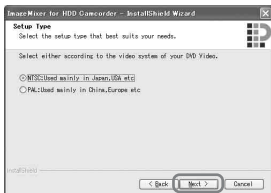

- 11** Click [Install] on the [Ready to Install the Program] screen.



The installation for “ImageMixer for HDD Camcorder” starts.

- 12** If the [Installing Microsoft (R) DirectX (R)] screen is displayed, follow the steps below to install DirectX 9.0c. If not, skip to step 13.

- ① Read [License Agreement], then click [Next].



- ② Click [Next].

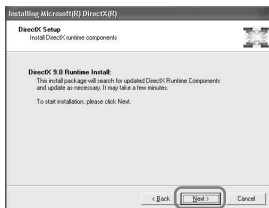

③ Click [Finish].



13 Make sure [Yes, I want to restart my computer now.] is checked, then click [Finish].



The computer turns off once, then starts up again automatically (Restart).

When you complete the installation, the shortcut icons for  [ImageMixer for HDD Camcorder] and [ImageMixer destination folder] appear on the desktop of your computer.

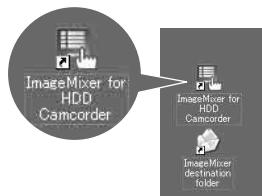

14 Remove the CD-ROM from the disc drive of your computer.

Creating a DVD with One Touch

You can save images with ease by pressing the DVD BURN button on the Handycam Station (One Touch DVD Burn function) without any complex operations of your computer.

- Images that have not been saved to a DVD with One Touch DVD Burn can automatically be saved.
- The history of each saved image is recorded according to the user account. If you use a different user account, the image that has already been saved to a DVD is recorded on the DVD again.
- You can play back the created DVD on a DVD player or other devices.
- Still images are recorded first on a DVD. When you save images on several DVDs, the still images are recorded on the first DVD.
- Still images on a DVD created by One Touch DVD Burn function cannot be played back on a DVD player. Play them back on a computer.
- Movies are organized by date under the same title in a created DVD. Depending on the device used, the ending of each title pauses for a few seconds.

What kinds of DVD can you use?

The kinds of DVD that you can use for the supplied software are as follows. Available DVDs differ, depending on the computer you use. For details on the DVDs compatible with your computer, refer to the supplied operational manual. Some DVD types may not be able to be played back, depending on the device you have. Refer to the specifications of your playback equipment for additional compatibility information.

DVD compatible with the supplied software

DVD types	Characteristics
DVD-R	<ul style="list-style-type: none">• Unrewritable• Fairly inexpensive. Mainly used for saving data• Compatible with most DVD players
DVD+R	<ul style="list-style-type: none">• Unrewritable
DVD+R DL	<ul style="list-style-type: none">• Using the dual layer DVD+R system containing more recordable capacity• Unrewritable
DVD-RW	<ul style="list-style-type: none">• Rewritable and reusable
DVD+RW	<ul style="list-style-type: none">• Rewritable and reusable

- Only the 12cm DVD can be used. The 8cm DVD cannot be used.
- When creating a DVD with One Touch DVD Burn function, there is no operational difference among DVD types except that DVD-RW/DVD+RW are both reusable.
- When you create a DVD by editing images copied to your computer, some of the operations may differ depending on the DVD type.
- When saving data on a DVD+RW, the data is recorded in VIDEO format. You cannot add more data on the DVD+RW.
- Use a DVD produced by a reliable manufacturer. You may not save images correctly when using a low quality DVD.

Saving images on a DVD with One Touch (One Touch DVD Burn)

Among the image data recorded on the hard disk of the camcorder, save the images that have not been stored on a DVD using this operation.

- In this operation, the image data recorded on the camcorder can be saved on DVD only once. To save images on the DVD for the next time, copy the images to the computer (p.84) to create DVD.
- If you cannot copy all your image data on a DVD, the image data is automatically saved on more than one DVD. The required number of DVDs is displayed in step 7 on the screen.

- When you play back a created DVD, the ending of each movie pauses for a few seconds. However, when you make the Seamless playback setting with ImageMixer Menu, the ending of each movie does not pause. Before connecting the camcorder to a computer via USB, refer to “Setting Seamless playback”(p.83).

1 Confirm that the Handycam Station is not connected to a computer.

2 Turn on the computer.



- Close all applications running on the computer.

3 Place the recordable DVD to be saved on the disc drive of your computer.

- It is recommended that you use a new recordable DVD.
- If any software starts on the computer automatically, close it.

4 Connect the Handycam Station to the wall socket using the supplied AC Adaptor.

5 Set the camcorder onto the Handycam Station, then slide the POWER switch to turn on.

- When you set the camcorder onto the Handycam Station, connect securely onto the interface connector of the Handycam Station (p.73).
- You can perform this operation, when whichever position of the  (Movie) /  (Still) /  (PLAY/EDIT) is lit.

6 Press the DVD BURN button on the Handycam Station.

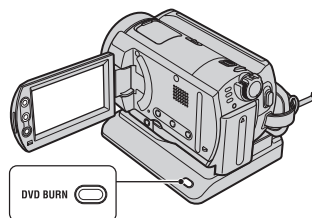

[Check the connected device.] appears on the LCD screen of the camcorder.

7 Connect the (USB) jack of the Handycam Station to a computer using the supplied USB cable.

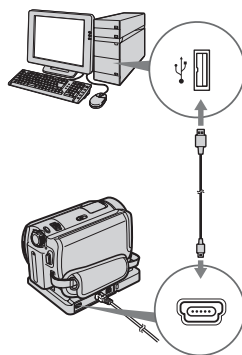

DVD creation starts up.

- During DVD creation, do not apply vibration. The DVD creation may be terminated.
- When you insert a burned DVD-RW/ DVD+RW in the disc drive in step 3, a message appears, asking if you want to delete images saved on a DVD.
- Make sure no other USB devices are connected to your computer.

- If your computer has a USB keyboard and a USB mouse as standard equipment, leave them connected and connect the Handycam Station to an available USB jack with the USB cable.

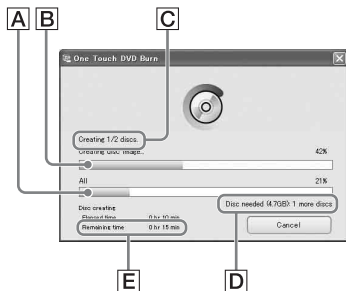

- A** Current status of all DVD creation
- B** Current status per DVD
- C** Number of DVD created
- D** Number of DVD required
- E** Remaining time (approx.)

When you complete creating DVD, it is exited automatically.

- When you cannot store all the recordable data on a DVD, follow the on-screen instructions, then insert a new DVD onto the disc drive.
- The maximum number of recordable movie files is limited. When the movie files exceed this limit, the rest will be saved on a new DVD.
- It may take more time to create DVD when the movie file is small.

8 Once the completion dialog for DVD creation appears, click [Close].



- To create another DVD, click [Create another disc set].

- After creating a DVD, check that the DVD can be played back properly on a DVD player or other devices. When you cannot play back the DVD properly, copy the images to the computer by following the steps on page 84. Then save the images on DVD by referring to “Creating a DVD with selected images” (p.93).
- If you check that the DVD can be played back properly, it is recommended that you delete the image data from the camcorder using the functions on the camcorder by following the steps on page 42. In this way, you can increase the free hard disk space of your camcorder.
- To copy a created DVD, use the DVD creation software installed on your computer. You cannot copy created DVDs with the supplied software.
- You cannot record image data on the hard disk of your computer in this operation.
- You cannot delete image data on the hard disk of the camcorder in this operation.
- You cannot edit images on the created DVD with a computer. When you want to edit the images with the computer, copy the images onto the computer (p.84).
- If DVD creation ends unexpectedly, the last correctly saved file is completed. When you create a DVD with One Touch DVD Burn function next time, the image data not saved on the DVD is the first one to be saved.
- Movies are organized by date under the same title in a created DVD. However, under the following conditions, this title will be divided even when the movies are recorded on the same date.
 - When a movie is recorded, the aspect ratio of the movie is switched from 16:9 (wide) to 4:3 and vice versa before recording another movie.
 - While setting the aspect ratio of a movie to 4:3, the recording mode has been switched from [LP] to [HQ] or [SP] and vice versa.
 - When the movies recorded on the same date exceed 99.
- The images that have been copied on your computer using Easy PC Back-up are also saved on a DVD with One Touch DVD Burn function.

Setting Seamless playback

When you play back a created DVD, the ending of each movie pauses for a few seconds. When you make a setting for Seamless playback, the ending of each movie does not pause. Once you make this setting, you do not have to make the same setting next time.

- 1 Double click  [ImageMixer for HDD Camcorder] on the desktop. ImageMixer Menu will be displayed.
- 2 Click [Options].



- 3 Check the check box for [Seamless playback], then click [OK].

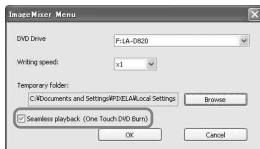

- When you make this setting, it will take more time for creating a DVD.
- Even when you make this setting, the ending of each title pauses for a few seconds.

Removing the USB cable

- 1 Click  ([Unplug or eject hardware]) icon on the task tray, then click when “Safely Remove USB Mass Storage Device” appears.



[Safe to Remove Hardware] appears.

- 2 Remove the USB cable from the Handycam Station and the computer.

- Do not remove the USB cable while the ACCESS lamp is lit.
- Make sure to remove the USB cable before turning off your camcorder.

- 3 Touch [END] on the LCD screen of the camcorder.

Copying images to a computer

You can view and edit images copied from the camcorder to your computer. Also, you can create a DVD with the copied materials. You can choose either way to copy images as follows.

Copying images that have not been saved (Easy PC Back-up) (p.84):

Images that have not been copied to a computer can automatically be copied to your computer.

Copying selected images (p.86):

You can select the desired images and copy them to your computer.

Destination of saved images

Images are saved in a new created folder under [ImageMixer3] folder in [My Pictures].

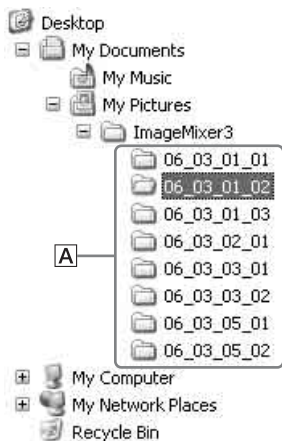

A Folders for saving images

- Movies and still images are saved on the same folder.
- On the file names of image data, see page 116.
- You can change the destination folders to copy your images (p.85, 88).
- On the file/folder order in the hard disk of the camcorder, see page 116.

Folder names created by Easy PC Back-up

Each time you copy images, a new folder is created. Each folder name becomes “YY_MM_DD (copy date) + Number of copies (sub-numbers)”.

- Example: If you copied images on March 1, 2006:
 - First Copy “06_03_01_01”
 - Second Copy “06_03_01_02”
 - Third Copy “06_03_01_03”

Folder names created by copying selected images

Each day you copy images, a new folder is created. Each folder name becomes “YY_MM_DD (Copy date)+00”. When you copy images a few times on the same day, new files are added on the folder created on that day.

- Example: If you copied images on March 1, 2006:
 - “06_03_01_00”
- If a file name in a folder created on the same day, and if a new file happens to have the same name, sub-numbers are added on the new file.

Copying images that have not been saved (Easy PC Back-up)

Images that have not been copied to a computer can automatically be copied to your computer.



1 Confirm that the Handycam Station is not connected to a computer.

2 Turn on the computer.

- Close all applications running on the computer.

3 Connect the Handycam Station to the wall socket using the supplied AC Adaptor.

4 Set the camcorder onto the Handycam Station, then slide the POWER switch to turn on.

- When you set the camcorder onto the Handycam Station, connect securely onto the interface connector of the Handycam Station (p.73).
- You can perform this operation, when whichever position of the  (Movie) /  (Still) /  (PLAY/EDIT) is lit.

5 Connect the (USB) jack of the Handycam Station to a computer using the supplied USB cable.

[USB SELECT] appears on the LCD screen of the camcorder.

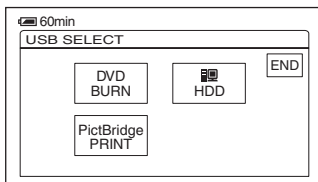

- For connecting with the USB cable, see page 81.
- Make sure no other USB devices are connected to your computer.
- If your computer has a USB keyboard and a USB mouse as standard equipment, leave them connected and connect the Handycam Station to an available USB jack with the USB cable.

6 Touch HDD on the LCD screen of the camcorder.

ImageMixer Menu appears on the screen of the computer.

- If the screen other than the ImageMixer Menu appears, close the screen.

7 Click [Easy PC Back-up] on the screen of the computer.



The setting screen appears.

8 Apply the settings for copying images, then click [Start importing].

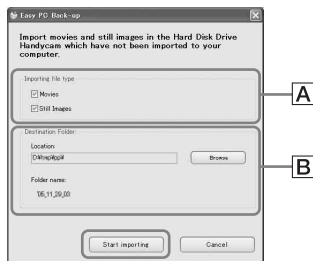

A Images to be copied

Select if you want to copy movies and still images individually. In the default setting, both the movies and still images are set to be copied.

B Destination folder

Displays the destination folders. To change the destination, click [Browse], then select the desired folder. Each time you copy images to the folder displayed on the screen, a new folder containing the copied images is created under the folder (p.84).

Images that have not been copied to a computer are automatically copied to your computer.

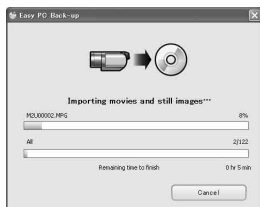

- While copying images, do not apply vibration on the camcorder. The copying may be terminated.

9 Once the completion dialog for copy appears, click [OK].

The copied images are displayed.

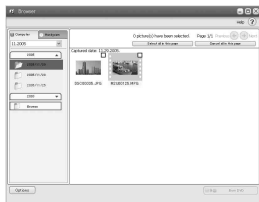

- See page 83 to remove the USB cable from the Handycam Station and your computer.

- The images that have been saved on a DVD using One Touch DVD Burn function are also copied to the computer with Easy PC Back-up.
- The history of each saved image is recorded according to the user account. If you use a different user account, the image that has already been imported is copied to the computer again.
- Data copy is cancelled when the free hard disk space of the computer becomes less than 500MB. In this case, increase free hard disk space by deleting some of the unnecessary files, then perform Easy PC Back-up again.

- If the operation ends unexpectedly, including an indication of insufficient free hard disk space, the last correctly copied file is saved. When you restart the operation, the next image data will be copied.

Copying selected images

You can copy selected images to your computer.



1 Confirm that the Handycam Station is not connected to a computer.

2 Turn on the computer.

- Close all applications running on the computer.

3 Connect the Handycam Station to the wall socket using the supplied AC Adaptor.

4 Set the camcorder onto the Handycam Station, then slide the POWER switch to turn on.

- You can perform this operation, when whichever position of the  (Movie) /  (Still) /  (PLAY/EDIT) is lit.

5 Connect the (USB) jack of the Handycam Station to a computer using the supplied USB cable.

[USB SELECT] appears on the LCD screen of the camcorder.

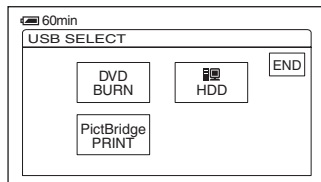

- For connecting with the USB cable, see page 81.
- Make sure no other USB devices are connected to your computer.
- If your computer has a USB keyboard and a USB mouse as standard equipment, leave them connected and connect the Handycam Station to an available USB jack with the USB cable.

6 Touch [HDD] on the LCD screen of the camcorder.

ImageMixer Menu appears on the screen of the computer.

- If the screen other than the ImageMixer Menu appears, close the screen.
- During the operation, do not apply vibration on the camcorder. The operation may be terminated.

7 Click [Viewing and Editing] on the screen of the computer.



Browser starts up.

8 Click [Handycam] tab.

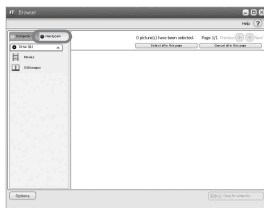

- You can view images on the hard disk of the camcorder.

9 To copy movies, click [Movies], or to copy still images, click [Still Images].



- If the message about Hi-Speed USB appears, click [OK]. Then select [Preview directly from the Hard Disk Drive Handycam] on the displayed Option screen and click [OK].

10 Click the images you want to copy.

The selected images on which you have clicked are marked with ✓. Mark all the desired images with ✓.

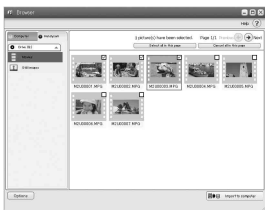

- You can also click the checkbox on the preview screen.
- You can select both the movies and still images at the same time.
- To change the destination, click [Options], then select the desired folder.

11 Click [Import to computer].

The selected images are copied to the hard disk of your computer.

-
- See page 83 to remove the USB cable from the Handycam Station and your computer.

Viewing copied images on a computer

You can view images copied to your computer.

1 Double-click [ImageMixer for HDD Camcorder] on the desktop.

ImageMixer Menu appears.

- You can also start up ImageMixer Menu by clicking [start] → [All Programs] → [PIXELA] → [ImageMixer for HDD Camcorder] → [ImageMixer for HDD Camcorder].

2 Click [Viewing and Editing].



Browser starts up.

3 Click the [Computer] tab.

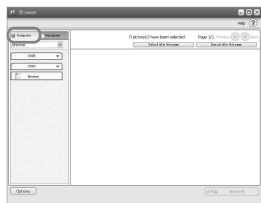

4 Click the folder containing the desired image.



- When you right-click the thumbnail, you can view the information of the movie or still image.

5 Double-click the desired image.

The preview screen appears.

Movie



You can play, stop, and pause using the buttons at the top of the screen.

- Depending on the computer you use, the played back image or sound may stop temporarily.

Still image



You can print and expand images using the buttons at the top of the screen.

- For data compatible with Exif, click ⓘ (Exif) to display the recording conditions such as shutter speed, exposure, aperture, etc.

Printing still images

Click 🖨️ (Print) in step 5.

Editing images

You can delete unnecessary scenes from a movie copied to your computer.

1 Turn on the computer.

2 Double-click [ImageMixer for HDD Camcorder] on the desktop.

ImageMixer Menu appears.

- You can also start up ImageMixer Menu by clicking [start] → [All Programs] → [PIXELA] → [ImageMixer for HDD Camcorder] → [ImageMixer for HDD Camcorder].

3 Click [Viewing and Editing].



Browser starts up.

4 Click the [Computer] tab.

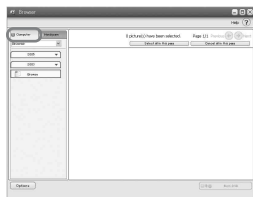

5 Click the folder including the movie you want to edit.

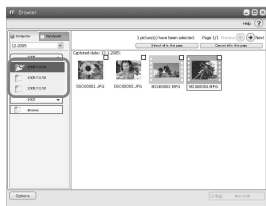

6 Double-click the movie you want to edit.

The preview screen appears.



7 Click [Edit].

ImageMixer MPEG Cutter starts up.



8 Check [Cut the specified range].



9 Search the scene you want to delete by clicking << or >>.



10 Drag and drop the first frame of the scene you want to delete to [Start].



11 Display the last frame of the scene to delete on the center frame by clicking << or >>, then drag and drop the frame to [End].



12 Click [Cut].



- When you want to delete more of the frames, repeat the steps from step 9 to step 12.

13 Click [Compile].

The new file except for deleted scenes are created on the computer.

- The image data selected as editing materials is saved on the computer.

14 When [Save as] appears on the screen, specify the destination and file name, then click [Save].

- For details, refer to the help in ImageMixer MPEG Cutter.

Creating a DVD with selected images

You can create a DVD with an index menu by putting images on your computer as materials. You can also use edited images (p.91) on the computer as DVD materials.

- When the created DVD is played back, the ending of each movie pauses for a few seconds, depending on the device used.
- For available DVD types, see page 80.

1 Turn on the computer.

- Close all applications running on the computer.

2 Place the recordable DVD on the disc drive of your computer.

- It is recommended that you use a new recordable DVD.
- Close the software, if it has started on the computer automatically.

3 Double click [ImageMixer for HDD Camcorder] on the desktop.

ImageMixer Menu appears.

- You can also start up ImageMixer Menu by clicking [start] → [All Programs] → [PIXELA] → [ImageMixer for HDD Camcorder] → [ImageMixer for HDD Camcorder].

4 Click [Viewing and Editing].



- By clicking [Options], you can change the settings for the DVD Drive, Writing speed, or Temporary folder.

Browser starts up.

5 Click the [Computer] tab, then click the folder including the image you want to save on a DVD.

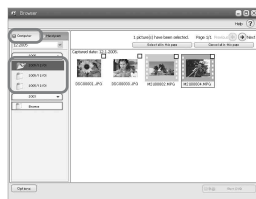

6 Click the desired image to save on a DVD.

The selected material is marked with ✓. Mark all the desired materials with ✓.



7 Click [Burn DVD].



[Project Settings] screen appears.

- You do not need to change the setting unless necessary.

8 Click [OK].

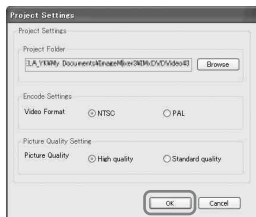

ImageMixer3 DVD Authoring starts up.

9 Click [Write] tab → [Write] on the ImageMixer3 DVD Authoring screen.



[Write settings] screen appears.

10 Click [OK].

DVD creation starts up.

- When you insert a burned DVD-RW/ DVD+RW in the disc drive in step 2, a message appears, asking if you want to delete images saved on a DVD.
- The maximum number of recordable movie files is 98.
- DVD menus can be edited. For details, see the help in the supplied software.

11 Once the completion dialog for DVD creation appears, click [No].



- To create another DVD, click [Yes].

-
- After creating a DVD, check that the DVD can be played back properly on a DVD player or other devices.
 - If you check that the DVD can be played back, it is recommended that you delete the image data from the camcorder by following the steps on page 42. In this way, you can increase the free hard disk space of your camcorder.
 - To copy a created DVD, use the DVD creation software installed on your computer. You cannot copy created DVDs with the supplied software.
 - You cannot edit images on a created DVD with a computer.
 - When you save still images on a DVD, the still images convert a Photomovie to a DVD automatically. In this way, you can view still images on a DVD player.
Photomovie  Glossary (p.121)

Saving images in the Playlist to a DVD

You can save images in a Playlist on the camcorder to a DVD.

- For creating a Playlist, refer to page 63.

1 Confirm that the Handycam Station is not connected to a computer.

2 Turn on the computer.





- Close all applications running on the computer.

3 Place the recordable DVD on the disc drive.

- It is recommended that you use a new recordable DVD.
- If any software starts on the computer automatically, close it.

4 Connect the Handycam Station to the wall socket using the supplied AC Adaptor.

5 Set the camcorder onto the Handycam Station, then slide the POWER switch to turn on.

- You can perform this operation, when whichever position of the  (Movie) /  (Still) /  (PLAY/EDIT) is lit. 

6 Connect the (USB) jack of the Handycam Station to a computer using the supplied USB cable.

[USB SELECT] appears on the LCD screen of the camcorder.

- For connecting with the USB cable, see page 81.

7 Touch [HDD] on the LCD screen of the camcorder.

ImageMixer Menu appears on the screen of the computer.

8 Click [Playlist DVD creation] on the screen of the computer.



[Project Settings] screen appears.

- You do not need to change the setting unless necessary.
- During the operation, do not apply vibration on the camcorder. The operation may be terminated.

9 Click [OK].

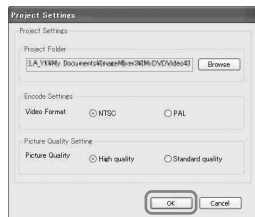

ImageMixer3 DVD Authoring starts up, and it allows you to select images in the Playlist created on the camcorder.

- By using ImageMixer3 DVD Authoring, you can create the index menu or select images to be saved on a DVD. For details, see the help in the software.

-
- 10** Click [ Write] tab → [Write] on the ImageMixer3 DVD Authoring screen.



[Write settings] screen appears.

-
- 11** Click [OK].

DVD creation starts up.

- When you insert a burned DVD-RW/ DVD+RW in the disc drive in step **3**, a message appears, asking if you want to delete images saved on a DVD.

-
- 12** Once the completion dialog for DVD creation appears, click [No].



- To create another DVD, click [Yes].

-
- See page 83 to remove the USB cable from the Handycam Station and your computer.

Deleting image data from a computer

Due to limitation of the hard disk space of the computer, it is recommended that you delete the image data on the hard disk once you save it to a DVD or other media.

- Before you delete images from your computer, check that the images saved on the DVD or other media can be played back properly.
- You cannot edit images on the created DVD with the supplied software. If you want to edit images after you save them on the DVD, it is recommended that you do not delete the images from the computer.
- The steps below show the procedures if you do not change the destination folders for your image data. When you have changed a destination folder, delete the images from the last destination folder.
- Do not delete the image data on the hard disk of the camcorder with your computer.

1 When using Windows XP, click [start] → [My Pictures].

The contents of [My Pictures] are displayed.

- For Windows 2000, double-click [My Document] → [My Pictures] on the desktop of your computer.

2 Double-click [ImageMixer3] folder.

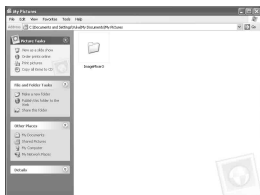

3 Double-click the folder containing the unnecessary image data.



- On the folder names, see page 84.

4 Drag and drop the unnecessary files to [Trash].

- When you delete the folder containing unnecessary files, drag and drop the folder in step 3.

Troubleshooting

If you run into any problems using your camcorder, refer to the following table to troubleshoot them. If your problem persists, remove the power source and contact your Sony dealer.

Note before sending your camcorder for repair

- Your camcorder may be required to initialize or change the current hard disk of the camcorder, depending on the problem. In the event of this, the data stored on the hard disk will be deleted. Be sure to save (backup) the data on the hard disk (p.41) on the other media before sending your camcorder to repair. We cannot guarantee any loss of your hard disk data.
- During repair, we may check a minimum amount of data stored on the hard disk in order to improve the condition. However, your Sony dealer will neither copy nor save your data.

Overall operations/Easy Handycam

The camcorder does not operate even when the power is set to on.

- Remove the AC Adaptor from the wall socket or remove the battery pack, then reconnect it after about one minute. If the functions still do not work, press the RESET button (p.34) using a sharp-pointed object. (If you press the RESET button, all settings are reset, except the Personal Menu items.)
- The temperature of your camcorder is extremely high. Turn off your camcorder and leave it for a while in a cool place.
- The temperature of your camcorder is extremely low. With POWER switch turned on, leave the camcorder for a while. If you still cannot operate the camcorder, turn it off, taking it to a warm place. Leave the camcorder there for a while, then turn on the camcorder.

Buttons do not work.

- During Easy Handycam operation, available buttons are limited. Cancel Easy Handycam operation (p.26).

You cannot turn Easy Handycam operation on or off.

- You cannot turn Easy Handycam operation on or off while recording or communicating with another device via USB cable.

Settings change during Easy Handycam operation.

- Some of the settings of your camcorder are restored to the default setting when you set Easy Handycam operation (p.24). The settings return to the ones before Easy Handycam operation when you cancel Easy Handycam operation (p.26).

[DEMO MODE] does not start.

- You cannot view the demonstration when the NIGHTSHOT PLUS switch is set to ON. Set the NIGHTSHOT PLUS switch to OFF (p.32).
- Set the POWER switch to  (Movie).

A vibration is felt in your hand or a faint sound is heard during operation.

- This is not a malfunction.

Your camcorder gets warm.

- This is because the power has been turned on for a long time. This is not a malfunction. Turn off your camcorder and leave it for a while in a cool place.

Batteries/Power sources

The power does not turn on.

- The battery pack is not attached to the camcorder. Attach a charged battery pack to the camcorder (p.14).
- The battery pack is discharged or running low. Charge the battery pack (p.14).
- The plug of the AC Adaptor has been removed from the wall socket. Connect it to the wall socket (p.14).
- Set the camcorder onto the Handycam Station securely (p.15).

The power abruptly turns off.

- When approximately five minutes have elapsed while you do not operate your camcorder, the camcorder is automatically turned off (A.SHUT OFF). Change the setting of [A.SHUT OFF] (p.60), or turn on the power again, or use the AC Adaptor.
- The battery pack is discharged or running low. Charge the battery pack (p.14).

The CHG (charge) lamp does not light while the battery pack is being charged.

- Slide the POWER switch to OFF (CHG) (p.14).
- Attach the battery pack to the camcorder correctly (p.14).
- Connect the mains lead to the wall socket properly.
- The battery charge is completed (p.14).
- Set the camcorder onto the Handycam Station securely (p.15).

The CHG (charge) lamp flashes while the battery pack is being charged.

- Attach the battery pack to the camcorder correctly (p.14). If the problem persists, remove the AC Adaptor from the wall socket and contact your Sony dealer. The battery pack may be damaged.

The power turns off frequently although the remaining battery indicator indicates that the battery pack has enough power to operate.

- A problem has occurred in the remaining battery time indicator, or the battery pack has not been charged enough. Fully charge the battery again to correct the indication (p.14).

The remaining battery time indicator does not indicate the correct time.

- The temperature of the environment is too high or too low. This is not a malfunction.
- The battery pack has not been charged enough. Fully charge the battery again. If the problem persists, replace the battery pack with a new one (p.14).
- The indicated time may not be correct depending on the environment of use. When you open or close the LCD screen, it takes about one minute to display the correct remaining battery time.

The battery pack is quickly discharged.

- The temperature of the environment is too high or low. This is not a malfunction.
- The battery pack has not been charged enough. Fully charge the battery again. If the problem persists, replace the battery pack with a new one (p.14).

A problem occurs when the camcorder is connected to the AC Adaptor.

- Turn off the power, and remove the AC Adaptor from the wall socket. Then, connect it again.

LCD screen

An unknown image appears on the screen.

- The camcorder is in [DEMO MODE] (p.55). Touch the LCD screen.

An unknown indicator appears on the screen.

- They may be warning indicators or messages (p.110).

The image remains on the LCD screen.

- This occurs if you remove the AC Adaptor from the wall socket or remove the battery pack without turning off the power first. This is not a malfunction.

You cannot turn the LCD backlight off.

- During Easy Handycam operation (p.24), you cannot turn the LCD backlight on/off pressing and holding DISP/BATT INFO. Cancel Easy Handycam operation (p.26).

The buttons do not appear on the touch panel.

- Touch the LCD screen lightly.
- Press DISP/BATT INFO on your camcorder (or DISPLAY on the Remote Commander (DCR-SR50E/SR60E/SR70E/SR80E)) (p.21, 38).



The buttons on the touch panel do not work correctly or do not work at all.

- Adjust the screen ([CALIBRATION]) (p.119).
- If you change the aspect ratio of the image, the aspect ratio of the buttons on the touch panel and indicators will be switched to the selected one (p.23).

Recording

Refer also to “Adjusting the image during recording” (p.102).

Pressing START/STOP or PHOTO does not record movies/still images.

- Slide the POWER switch to light up the  (Movie) or the  (Still) lamp.
- Your camcorder is recording the image you have just shot on the hard disk of the camcorder. You cannot press PHOTO while [CAPTURE] or  appears on the LCD screen (p.26, 29).
- The hard disk of the camcorder is full. Delete unnecessary images. Or perform [HDD FORMAT] (p.55).
- The temperature of your camcorder is extremely high. Turn off your camcorder and leave it for a while in a cool place.
- The temperature of your camcorder is extremely low. With POWER switch turned on, leave the camcorder for a while. If you still cannot operate the camcorder, turn it off, taking it to a warm place. Leave the camcorder there for a while, then turn on the camcorder.
- The folder number shows 999, and the file number shows 9,999. Delete images (p.42) or perform [HDD FORMAT] (p.55).
- While activating [DROP SENSOR] (p.56), you may not record movies/still images.

The ACCESS lamp lights up even when you stop recording.

- Your camcorder is recording the image you have just shot on the hard disk of the camcorder. Do not remove the AC Adaptor or the battery pack while the lamp is turned on.

The recording angle differs depending on the POWER switch setting position.

- The recording angle for the still image is wider than the one for the movie.

The shutter sound is not heard when you record a still image.

- Set [BEEP] to [ON] (p.60).

The external flash (optional) does not work (DCR-SR50E/SR60E/SR70E/SR80E).

- You cannot record with the flash with:
 - During recording movies
 - [SUPER NSPLUS]
 - [COLOR SLOW S]
 - [D.EFFECT]
 - [■ BURST]
- The flash does not light up in the following cases even when you set [AUTO] or [REDEYE REDUC] in [FLASH SET]:
 - NightShot plus
 - [SPOTLIGHT], [SUNSET&MOON] or [LANDSCAPE] in [PROGRAM AE]
 - [EXPOSURE]
 - [SPOT METER]
- The power of the external flash (optional) is not turned on, or the flash is not attached correctly.

The actual recording time for movie is less than the expected approximate recording time.

- When you record an object that moves fast, the time available for recording may shorten (p.16, 57).

The recording stops.

- The temperature of your camcorder is extremely high. Turn off your camcorder and leave it for a while in a cool place.
- The temperature of your camcorder is extremely low. Turn off the camcorder and take it to a warm place. Leave the camcorder there for a while, then turn on the camcorder.
- The maximum continuous recordable time is approximately 13 hours.
- If you keep applying vibration on the camcorder, recording may stop.
- Fragmentation has occurred. Perform [HDD FORMAT] (p.55).

There is a time difference between the point where you press START/STOP and the point that the recorded movie starts/stops.

- On your camcorder, there may be a slight time difference between the point where you press START/STOP and the actual point that recording movie starts/stops. This is not a malfunction.

Adjusting the image during recording

Refer also to “Setup items” (p.104).

The auto focus does not function.

- Set [FOCUS] to [AUTO] (p.50).
- The recording conditions are not suitable for auto focus. Adjust the focus manually (p.50).

[STEADYSHOT] does not function.

- Set [STEADYSHOT] to [ON] (p.52).
- [STEADYSHOT] may not work for an excessive camera shake even if [STEADYSHOT] is set to [ON].

The back light function does not function.

- The back light function is cancelled when you set [EXPOSURE] to [MANUAL] (p.49) or select [SPOT METER] instead (p.48).
- The back light function does not work during Easy Handycam operation. Cancel Easy Handycam operation (p.26).

A vertical band appears when recording candlelight or electric light in the dark.

- This occurs when the contrast between the subject and the background is too high. This is not a malfunction.

A vertical band appears when recording a bright subject.

- This phenomenon is called the smear effect. This is not a malfunction.

Tiny spots in white, red, blue, or green appear on the screen.

- The spots appear when you are recording in [SUPER NSPLUS] or [COLOR SLOW S]. This is not a malfunction.

The color of the image is not correctly displayed.

- Set the NIGHTSHOT PLUS switch to OFF (p.32).

The image appears too bright on the screen, and the subject does not appear on the screen.

- Set the NIGHTSHOT PLUS switch to OFF (p.32).

The image appears too dark on the screen, and the subject does not appear on the screen.

- The LCD screen backlight is switched off. Turn on the LCD backlight by pressing and holding DISP/BATT INFO (p.20).

Flickering or changes in color occurs.

- This occurs when recording images under a fluorescent lamp, sodium lamp, or mercury lamp with [PORTRAIT] or [SPORTS]. Cancel [PROGRAM AE] in this case (p.48).

Black bands appear when you record a TV screen or computer screen.

- Set [STEADYSHOT] to [OFF] (p.52).

Remote Commander (DCR-SR50E/SR60E/SR70E/SR80E)

The supplied Remote Commander does not function.

- Set [REMOTE CTRL] to [ON] (p.59).
- Insert a battery into the battery holder with the +/- polarities correctly matching the +/- marks (p.120).
- Remove any obstructions between the Remote Commander and the remote sensor.
- Point the remote sensor away from strong light sources such as direct sunlight or overhead lighting. Otherwise, the Remote Commander may not function properly.
- Remove the conversion lens (optional) as the remote sensor may be obstructed by it.

Another DVD device malfunctions when you use the supplied Remote Commander.

- Select a commander mode other than DVD 2 for your DVD device, or cover the sensor of your DVD device with black paper.

Playback

“” is indicated on an image in the VISUAL INDEX screen.

- Loading of the data may have failed. It may be indicated correctly when you turn off the power and then turn it on again.
- You removed the AC Adaptor or the battery pack before the ACCESS lamp is turned off after recording. This may damage your image data and  is displayed.

“” is indicated on an image in the VISUAL INDEX screen.

- The image data is damaged. Delete the image marked with  (p.42).

No sound or only a low sound is heard when playing back.

- Set [MULTI-SOUND] to [STEREO] (p.57).
- Turn up the volume (p.30).
- Sound is not output when the LCD screen is closed. Open the LCD screen.
- When you record sound with [MICREF LEVEL] (p.57) set to [LOW], the recorded sound may be difficult to hear.

Image data

Images cannot be deleted.

- Protected images cannot be deleted. Cancel the image protection (p.66).

The data file name is not indicated correctly.

- Only the file name is displayed if the directory structure does not conform to the camcorder standard.
- The file is damaged.
- The file format is not supported on your camcorder (p.116).

The data file name flashes.

- The file is damaged.
- The file format is not supported on your camcorder (p.116).

Setup items

Setup items are grayed out.

- You cannot select grayed out items in the current situation.

[P-MENU] is not displayed.

- You can operate limited operations during Easy Handycam operation. Cancel Easy Handycam operation (p.26).

You cannot use [PROGRAM AE].

- You cannot use [PROGRAM AE] together with:
 - NightShot plus
 - [SUPER NSPLUS]
 - [COLOR SLOW S]
 - [OLD MOVIE]
- [SPORTS] will not work when the POWER switch is set to  (Still).

You cannot use [SPOT METER].

- You cannot use [SPOT METER] together with:
 - NightShot plus
 - [SUPER NSPLUS]
 - [COLOR SLOW S]
- If you set [PROGRAM AE], [SPOT METER] is automatically set to [AUTO].

You cannot use [EXPOSURE].

- You cannot use [EXPOSURE] together with:
 - NightShot plus
 - [SUPER NSPLUS]
 - [COLOR SLOW S]
- If you set [PROGRAM AE], [EXPOSURE] is automatically set to [AUTO].

You cannot use [WHITE BAL.].

- You cannot use [WHITE BAL.] together with:
 - NightShot plus
 - [SUPER NSPLUS]

You cannot use [SPOT FOCUS].

- You cannot use [SPOT FOCUS] together with [PROGRAM AE].

You cannot use [SUPER NSPLUS].

- The NIGHTSHOT PLUS switch is not set to ON.
- You cannot use [SUPER NSPLUS] together with:
 - [FADER]
 - [D.EFFECT]

[COLOR SLOW S] does not operate correctly.

- [COLOR SLOW S] may not operate correctly in total darkness. Use NightShot plus or [SUPER NSPLUS].
- You cannot use [COLOR SLOW S] together with:
 - [FADER]
 - [D.EFFECT]
 - [PROGRAM AE]
 - [EXPOSURE]
 - [SPOT METER]

You cannot use [SELF-TIMER].

- You cannot use [SELF-TIMER] together with [FADER].

You cannot use [FADER].

- You cannot use [FADER] together with:
 - [SUPER NSPLUS]
 - [COLOR SLOW S]
 - [D.EFFECT]

You cannot use [D.EFFECT].

- You cannot use [D.EFFECT] together with:
 - [SUPER NSPLUS]
 - [COLOR SLOW S]
 - [FADER]
- You cannot use [OLD MOVIE] together with:
 - [PROGRAM AE]
 - [PICT.EFFECT]

You cannot use [PICT.EFFECT].

- You cannot use [PICT.EFFECT] together with [OLD MOVIE].

You cannot adjust [LCD BL LEVEL].

- You cannot adjust [LCD BL LEVEL] when power is supplied from the AC Adaptor.

Editing for movies and still images

Scenes cannot be added in the Playlist.

- The added scenes exceed 99. Delete unnecessary scenes (p.42, 63).

A scene cannot be deleted.

- Protected images cannot be deleted. Cancel the image protection (p.66).

Dubbing/Connecting to other devices

Images from connected devices are not displayed on the LCD screen (DCR-SR50E/SR60E/SR70E/SR80E).

- Touch **P-MENU** → [REC CTRL] (p.70).

The aspect ratio of the playback is not correct when connecting your camcorder to the TV.

- Set [TV TYPE] depending on your TV (DCR-SR50E/SR60E/SR70E/SR80E) (p.39).

Images from connected devices cannot be zoomed (DCR-SR50E/SR60E/SR70E/SR80E).

- You cannot zoom scenes input from the other device on your camcorder.

No sound is heard during playback.

- The audio will not be output when you connect a device via the S VIDEO plug only. Connect the white and red plugs of the A/V connecting cable, too (p.39, 67).

You cannot dub correctly using the A/V connecting cable.

- The A/V connecting cable is not connected properly. Make sure that the A/V connecting cable is connected to the proper jack, i.e. to the output jack of a device you are dubbing a image from, or to the input jack of another device for dubbing a image from your camcorder (p.67, 69).

Connecting a computer

The computer does not recognize your camcorder.

- Install the supplied software “ImageMixer for HDD Camcorder” (p.77).
- Set the camcorder onto the Handycam Station securely (p.15).
- Remove the USB cable from the Handycam Station and the computer, then connect it again firmly.
- Remove USB device other than the keyboard, the mouse, and the Handycam Station from the computer.
- Remove the USB cable from the Handycam Station and the computer, then restart the computer to connect them again correctly.
- Check that [DVD BURN] or [HDD] appears on the LCD screen of the camcorder. If not, remove the USB cable from the Handycam Station and the computer, and turn the camcorder off. Then turn on, and repeat the operation.

An error message appears when you place the supplied CD-ROM on your computer.

- Set the computer display as follows:
 - 1024 × 768 dots or more, High Color (16 bits, 65 000 colors) or more.

You cannot use the supplied software on a Macintosh computer.

- The supplied software “ImageMixer for HDD Camcorder” is not compatible with Macintosh.

[Cannot start Easy Handycam.] or [Cannot cancel Easy Handycam.] appears on the screen of your camcorder.

- You cannot start or cancel the Easy Handycam operation during USB connection. Remove the USB cable from the Handycam Station first (p.83), then touch [END] on the LCD screen of the camcorder.

You cannot view images recorded on your camcorder through your computer.

- Remove the USB cable from the Handycam Station and the computer, then connect it again firmly.
- Remove the USB device other than the keyboard, mouse, and Handycam Station from the computer.
- Touch [HDD], when [USB SELECT] appears on the LCD screen of the camcorder.

You cannot copy image data from your camcorder to a computer.

- Set [USB SPEED] to [FULL SPEED] in setup item (p.58).

The image or sound on your camcorder cannot be played back correctly.

- When you connect your camcorder to a computer not compatible with Hi-Speed USB (USB 2.0), it may not be able to be played back correctly. However, it does not affect the images or sounds copied to your computer.
- When you set [USB SPEED] to [FULL SPEED] (p.58), it may not be able to be played back correctly. However, it does not affect the images or sounds copied to your computer.
- Depending on the computer you use, the played back image or sound may stop temporarily, but this does not affect the images or sound copied to your computer.

“ImageMixer for HDD Camcorder” does not function correctly.

- Close “ImageMixer for HDD Camcorder”, then restart the computer.

An error message appears while operating “ImageMixer for HDD Camcorder”.

- Close “ImageMixer for HDD Camcorder” first, then slide the POWER switch on your camcorder to turn on another lamp.

The actual display and message look different on your computer.

- The actual display and message may look different.

The extension of a file is not displayed on your computer.

- To display the extension, follow the steps below.
 - ① Click [Tool] in the window folder → [Folder option...] → [View] tab.
 - ② Remove the check mark from the [Hide file extensions for known file types] under Advanced Settings.
 - ③ Click [OK].

If you press the DVD BURN button on the Handycam Station, the software on the computer does not run.

- Set the camcorder onto the Handycam Station securely (p.15).
- After  appears in the task tray on the screen of your computer, press DVD BURN again.

While performing Easy PC Back-up, [Not enough space on destination hard disk.] is displayed on the computer screen.

- Delete unnecessary files from your computer to provide free hard disk space (p.97).

You cannot change the lit status of the power lamps on the camcorder.

- When using the USB connection, you cannot change the lit status of the power lamps on the camcorder. Cancel the USB connection.

Others

The beep sounds for five seconds.

- The temperature of your camcorder is extremely high. Turn off your camcorder and leave it for a while in a cool place.
- Some problems have occurred in your camcorder. Turn off and on, then operate your camcorder again.

Warning indicators and messages

Self-diagnosis display/Warning indicators

If indicators appear on the LCD screen, check the following.

You can solve some of the symptoms by yourself. If your problem persists even after you have tried a couple of times, contact your Sony dealer or local authorized Sony service facility.

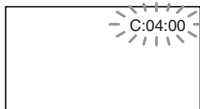

C:(or E:) □□:□□ (Self-diagnosis display)

C:04:□□

- The battery pack is not an "InfoLITHIUM" battery pack. Use an "InfoLITHIUM" battery pack (p.117).
- Connect the DC plug of the AC Adaptor to the DC IN jack of the Handycam Station or your camcorder securely (p.14, 15).

C:13:□□ / C:32:□□

- Remove the power source. Reconnect it and operate your camcorder again.

E:20:□□ / E:31:□□ / E:40:□□ / E:61:□□ / E:62:□□ / E:91:□□ / E:94:□□

- A malfunction that you cannot service has occurred. Contact your Sony dealer or local authorized Sony service facility. Inform them of the 5-digit code, which starts from "E".

100-0001 (Warning indicator pertaining to files)

Slow flashing

- The file is damaged.
- The file is unreadable.

⊕ (Warning on the hard disk of the camcorder)*

Fast flashing

- An error may have occurred with the hard disk drive in your camcorder.

⊕ (Warning on the hard disk of the camcorder)*

Fast flashing

- The hard disk of the camcorder is fully recorded.
- An error may have occurred with the hard disk drive in your camcorder.

⊖ (Battery level warning)

Slow flashing

- The battery pack is nearly used up.
- Depending on the operating environment or battery conditions, ⊖ may flash, even if there are approximately 20 minutes remaining.

[H] (High temperature warning)

Slow flashing

- The temperature of your camcorder is getting higher. Turn off your camcorder and leave it for a while in a cool place.

Fast flashing*

- The temperature of your camcorder is extremely high. Turn off your camcorder and leave it for a while in a cool place.

[L] (Low temperature warning)

Fast flashing*

- The temperature of your camcorder is extremely low. Make the camcorder warm.

⚡ (Warning indicator pertaining to the external flash)*

Slow flashing

- Still charging.

Fast flashing

- There is something wrong with the flash.

 **(Warning indicator pertaining to camera-shake warning)***

- The amount of lights is not sufficient, so camera-shake easily occurs. Use the flash.
- The camcorder is unsteady, so camera-shake easily occurs. Hold the camcorder steady with both hands and record the image. However, note that the camera-shake warning indicator does not disappear.

* You hear a melody when the warning indicators appear on the screen (p.60).

Description of warning messages

If messages appear on the screen, follow the instructions.

■ Battery

Use the “InfoLITHIUM” battery pack. (p.117)

Battery level is low. (p.14, 117)

Old Battery. Use a new one. (p.117)

■ Hard disk

 **Drive error. Turn on power again.**

- A problem occurred with the hard disk. Turn off and then on again.

 **Overheated. Cannot access HDD.**

 **Low temperature. Cannot access HDD.**

 **HDD full. Cannot record.**

- Delete unnecessary images (p.42).

 **Movie scene number is full. Cannot record.**

- Delete unnecessary images (p.42).

 **Movie folder full. Cannot record movies.**

- Delete unnecessary images (p.42) or perform [HDD FORMAT].

 **Still scene number is full. Cannot record.**

- Delete unnecessary images (p.42).

 **Still pic folder full. Cannot record stills.**

- Delete unnecessary images (p.42) or perform [HDD FORMAT].

 **Movie recording disabled.**

- Movies cannot be recorded due to some limitations of the hard disk of the camcorder. However, you may be able to record still images.

 **Still recording disabled.**

- Still images cannot be recorded due to some limitations of the hard disk of the camcorder. However, you may be able to record movies.

No applicable files available.

- Image files have been deleted.

Format error. Please format.

- The hard disk of the camcorder is set differently from the default format. Performing [HDD FORMAT] (p.55) may enable you to use your camcorder.

Data error.

- An error occurred during reading or writing the hard disk of the camcorder. This may occur when you keep applying shock on the camcorder.

Access error.

- An error occurred during reading or writing the hard disk of the camcorder. This may occur when you keep applying shock on the camcorder.

Management file damaged. Create new file?

- The image management file is damaged. When you touch [YES], a new image management file is created. When a new management file is created, the old recorded images on the hard disk of the camcorder cannot be played back. (Image files are not damaged.) In this case, copy the image files to computer by following the steps on page 84.

Buffer overflow

- You cannot record because the drop sensor senses a drop of the camcorder repeatedly. If you may be at risk of dropping the camcorder constantly, set the drop sensor to [OFF], and you may be able to record the image again.

Recovering data  Avoid any vibration.

- Your camcorder tries to recover data automatically if the data writing was not performed properly.

Cannot recover data.

- Writing data onto the hard disk of the camcorder has failed. Attempts were made to recover the data, but they were unsuccessful.

■ PictBridge compliant printer

Check the connected device.

- Turn off the printer and on again, then remove the USB cable (supplied) and reconnect it.

Connect the camcorder to a PictBridge compatible printer.

- Turn off the printer and on again, then remove the USB cable (supplied) and reconnect it.

Error. Cancel the task.

- Check the printer.

Cannot print. Check the printer.

- Turn off the printer and on again, then remove the USB cable (supplied) and reconnect it.

■ Flash

Charging... Cannot record still images.

- You are trying to record a still image while the external flash is charging.

Flash cannot charge. Not available.

- A malfunction has occurred with the external flash and disable charging.

■ Lens cover

Lens cover not fully open. Turn power off then on. (p.18)

Lens cover is not closed. Turn the power off once. (p.18)

■ Easy Handycam

Cannot start Easy Handycam. (p.24)

Cannot cancel Easy Handycam. (p.24)

Cannot start Easy Handycam with USB connected. (p.24)

Cannot cancel Easy Handycam with USB connected. (p.24)

Invalid during Easy Handycam operation (p.24)

■ Other

Please connect AC Adaptor.

- You are trying to format the camcorder hard disk, while the battery capacity is low. Use the AC Adaptor as the power source to prevent the battery from wearing out in the middle of this operation.

Playback prohibited.

- You can only play back the images recorded by the camcorder.

Playlist full.

- You cannot create the playlist exceeding 99 scenes.

Data protected.

- The data is protected (p.65).

Copy Inhibit.

- The copyright protected images cannot be dubbed on the camcorder.

Already added to mode's P-MENU.

Drop sensor activated. USB function ended.

Press END button and end USB connection.

- During USB connection, you cannot perform One Touch DVD Burn.

Using your camcorder abroad

Power supply

You can use your camcorder in any countries/regions using the AC Adaptor supplied with your camcorder within the AC 100 V to 240 V, 50/60 Hz range.

On TV color systems

Your camcorder is a PAL system-based camcorder. If you want to view the playback picture on a TV, it must be a PAL system based TV with an AUDIO/VIDEO input jack.

System	Used in
PAL	Australia, Austria, Belgium, China, Czech Republic, Denmark, Finland, Germany, Holland, Hong Kong, Hungary, Italy, Kuwait, Malaysia, New Zealand, Norway, Poland, Portugal, Singapore, Slovak Republic, Spain, Sweden, Switzerland, Thailand, United Kingdom, etc.
PAL - M	Brazil
PAL - N	Argentina, Paraguay, Uruguay.
NTSC	Bahama Islands, Bolivia, Canada, Central America, Chile, Colombia, Ecuador, Guyana, Jamaica, Japan, Korea, Mexico, Peru, Surinam, Taiwan, the Philippines, the U.S.A., Venezuela, etc.
SECAM	Bulgaria, France, Guyana, Iran, Iraq, Monaco, Russia, Ukraine, etc.

Setting to the local time

You can easily set the clock to the local time by setting a time difference when using your camcorder abroad. Set [AREA SET] and [SUMMERTIME] in the  TIME/LANGU. (p.22).

World time difference

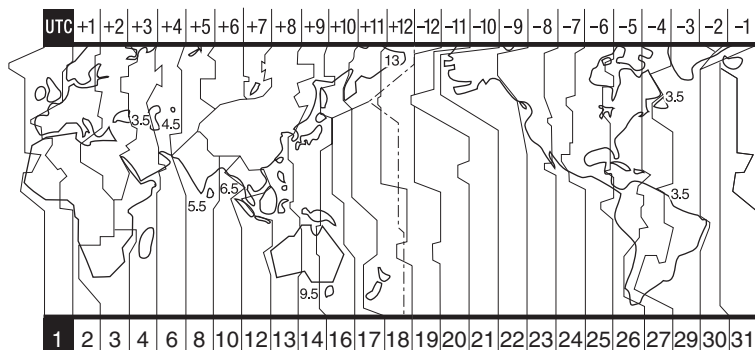

Area code	Time-zone differences	Area setting
1	GMT	Lisbon, London
2	+01:00	Berlin, Paris
3	+02:00	Helsinki, Cairo
4	+03:00	Moscow, Nairobi
5	+03:30	Tehran
6	+04:00	Abu Dhabi, Baku
7	+04:30	Kabul
8	+05:00	Karachi, Islamabad
9	+05:30	Calcutta, New Delhi
10	+06:00	Almaty, Dhaka
11	+06:30	Rangoon
12	+07:00	Bangkok, Jakarta
13	+08:00	HongKong, Singapore
14	+09:00	Seoul, Tokyo
15	+09:30	Adelaide, Darwin
16	+10:00	Melbourne, Sydney

Area code	Time-zone differences	Area setting
17	+11:00	Solomon Is.
18	+12:00	Fiji, Wellington
19	-12:00	Eniwetok, Kwajalein
20	-11:00	Midway Is., Samoa
21	-10:00	Hawaii
22	-09:00	Alaska
23	-08:00	Los Angeles, Tijuana
24	-07:00	Denver, Arizona
25	-06:00	Chicago, Mexico City
26	-05:00	New York, Bogota
27	-04:00	Santiago
28	-03:30	St. John's
29	-03:00	Brasilia, Montevideo
30	-02:00	Fernando de Noronha
31	-01:00	Azores

Files on the camcorder hard disk/folder structure

The file/folder structure is shown below. You do not usually need to acknowledge the file/folder structure, when recording/playing back images on the camcorder. To enjoy still images or movies by connecting to a computer, see page 74, then use the supplied application.

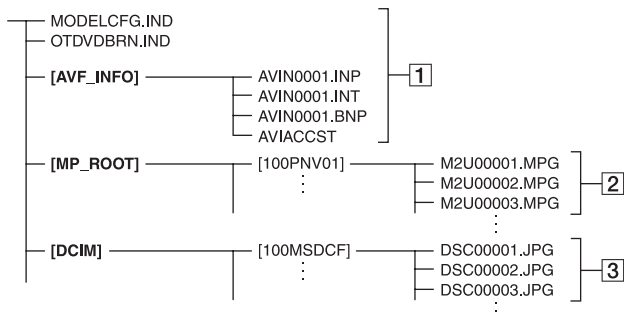

1 Image management files

When you delete the files, you cannot record/playback the images correctly. The files are defaulted as hidden files and not usually displayed.

2 Movie files (MPEG2 files)

The extension of the files is “.MPG”. The maximum size is 2GB. When the capacity of a file exceeds 2GB, the file becomes divided.

The file numbers go up automatically. When the file numbers exceeds 9,999, another folder is created to store new movie files.

The folder name goes up: [100PNV01]
→ [101PNV01]

3 Still image files (JPEG files)

The extension of the files is “.JPG”. The file numbers go up automatically. When the capacity of a file number exceeds 9,999, another folder is created to store new image files.

The folder name goes higher as shown here: [100MSDCF] → [101MSDCF]

- Do not modify the files or folders on the camcorder through the computer without using the supplied computer application. The image files may be destroyed or may not be played back.
- Operation is not guaranteed, if you perform the above operation without using the supplied computer application.
- When you delete image files, see the steps on page 42. Do not delete the image files on the camcorder directly from the computer.
- Do not format the hard disk of the camcorder using the computer. It may not operate correctly.
- When the file extensions are not displayed on the screen of the computer, see page 108.
- Do not copy the files on the hard disk of the camcorder from the computer. Operation is not guaranteed.
- When the folder number shows 999 and file number exceeds 9,999, recording may not be possible. In this case, perform [HDD FORMAT] (p.55).

For DCR-SR30E/SR50E/SR70E only:

- You cannot copy data on the hard disk of the camcorder from the computer.

- When you set [USB SELECT] to  HDD (p.55), you can access the hard disk of the camcorder from the computer through USB connection.

About the “InfoLITHIUM” battery pack

This unit is compatible with an “InfoLITHIUM” battery pack (P series). Your camcorder operates only with an “InfoLITHIUM” battery pack. “InfoLITHIUM” P series battery packs have the  mark.

What is an “InfoLITHIUM” battery pack?

An “InfoLITHIUM” battery pack is a lithium-ion battery pack that has functions for communicating information related to operating conditions between your camcorder and an optional AC Adaptor/charger (optional).

The “InfoLITHIUM” battery pack calculates the power consumption according to the operating conditions of your camcorder, and displays the remaining battery time in minutes.

Charging the battery pack

- Be sure to charge the battery pack before you start using your camcorder.
- It is recommended that you charge the battery pack in an ambient temperature of between 10°C to 30°C (50°F to 86°F) until CHG (Charge) lamp turns off. If you charge the battery pack outside of this temperature range, you may not be able to charge the battery pack efficiently.

Effective use of the battery pack

- Battery pack performance decreases when the surrounding temperature is 10°C (50°F) or below, and the length of time you can use the battery pack becomes shorter. In that case, do one of the following to use the battery pack for a longer time.
 - Put the battery pack in a pocket to warm it up, and insert it in your camcorder right before you start taking shots.
 - Use a large capacity battery pack: NP-FP71/ NP-FP90 (optional).
- Frequent use of the LCD screen or a frequent playback, fast forward or reverse operation wears out the battery pack faster. It is recommended that you use a large capacity battery pack: NP-FP71/ NP-FP90 (optional).

- Be sure to slide the POWER switch to OFF (CHG) when not shooting or playing back on your camcorder. The battery pack is also consumed when your camcorder is in the standby mode or playback is paused.
- Have spare battery packs ready for two or three times the expected recording time, and make trial recordings before making the actual recording.
- Do not expose the battery pack to water. The battery pack is not water-resistant.

Remaining battery time indicator

- If the power goes off even though the remaining battery time indicator indicates that the battery pack has enough power to operate, charge the battery pack fully again so that the indication on the remaining battery time indicator is correct. Note, however, that the correct battery indication sometimes will not be restored if the battery is used in high temperatures for a long time or left in a fully charged state, or the battery pack is used frequently. Regard the remaining battery time indication as the approximate shooting time.
- The  mark indicating that there is little remaining battery time sometimes flashes depending on the operating conditions or ambient temperature and environment even if the remaining battery time is approximately 20 minutes.

How to store the battery pack

- If the battery pack is not used for a long time, fully charge the battery pack and discharge it on your camcorder once a year to maintain the proper function. To store the battery pack, remove it from your camcorder and put it in a dry, cool place.
- To use the battery pack up on your camcorder, leave your camcorder in the recording standby with the [A.SHUT OFF] to [NEVER] in  STANDARD SET in the SETUP screen until the power goes off (p.60).

Battery life

- The battery life is limited. Battery capacity drops little by little as you use it more and more, and as time passes. When the available battery time is shortened considerably, a probable cause is that the battery pack has reached the end of its life. Please buy a new battery pack.
- The battery life varies according to how it is stored, the operating conditions, and environment in which each battery pack is used.

Maintenance and precautions

On use and care

- Do not use or store the camcorder and accessories in the following locations.
 - Anywhere extremely hot or cold or humid places. Never leave them exposed to temperatures above 60°C (140°F), such as under direct sunlight, near heaters or in a car parked in the sun. They may malfunction or become deformed.
 - Near strong magnetic fields or mechanical vibration. The camcorder may malfunction.
 - Near strong radio waves or radiation. The camcorder may not record properly.
 - Near AM receivers and video equipment. Noise may occur.
 - On a sandy beach or anywhere dusty. If sand or dust gets in your camcorder, it may malfunction. Sometimes this malfunction cannot be repaired.
 - Near windows or outdoors, where the LCD screen or the lens may be exposed to direct sunlight. This damages the inside of the LCD screen.
- Operate your camcorder on DC 7.2 V (battery pack) or DC 8.4 V (AC Adaptor).
- For DC or AC operation, use the accessories recommended in this instruction manual.
- Do not let your camcorder get wet, for example, from rain or sea water. If your camcorder gets wet, it may malfunction. Sometimes this malfunction cannot be repaired.
- If any solid object or liquid gets inside the casing, unplug your camcorder and have it checked by a Sony dealer before operating it any further.
- Avoid rough handling, disassembling, modifying, physical shock, or impact such as hammering, dropping or stepping on the product. Be particularly careful of the lens.
- Keep the POWER switch setting to OFF (CHG) when you are not using your camcorder.
- Do not wrap your camcorder with a towel, for example, and operate it. Doing so might cause heat to build up inside.
- When removing the mains lead, pull it by the plug and not the cord.
- Do not damage the mains lead such as by placing anything heavy on it.
- Keep metal contacts clean.

- Keep the Remote Commander and button-type battery out of children's reach. If the battery is accidentally swallowed, consult with a doctor immediately (DCR-SR50E/SR60E/SR70E/SR80E).
- If the battery electrolytic liquid has leaked,
 - consult with your local authorized Sony service facility.
 - wash off any liquid that may have contacted your skin.
 - if any liquid gets in your eyes, wash with plenty of water and consult with a doctor.

■ When not using your camcorder for a long time

- Occasionally turn it on and let it run such as by playing back images or recording for about three minutes.
- Use up the battery pack completely before storing it.

Moisture condensation

If your camcorder is brought directly from a cold place to a warm place, moisture may condense inside your camcorder. This may cause malfunction to your camcorder.

■ Note on moisture condensation

Moisture may condense when you bring your camcorder from a cold place into a warm place (or vice versa) or when you use your camcorder in a humid place as follows:

- You bring your camcorder from a ski slope into a place warmed up by a heating device.
- You bring your camcorder from an air conditioned car or room into a hot place outside.
- You use your camcorder after a squall or a shower.
- You use your camcorder in a hot and humid place.

■ How to prevent moisture condensation

When you bring your camcorder from a cold place into a warm place, put your camcorder in a plastic bag and seal it tightly. Remove the bag when the air temperature inside the plastic bag has reached the surrounding temperature (after about one hour).

■ If moisture condensation has occurred

Leave the camcorder tuned off for about an hour until moisture condensation disappears.

On the LCD screen

- Do not exert excessive pressure on the LCD screen. Blurs appear and it may cause a malfunction of your camcorder.
- If your camcorder is used in a cold place, a residual image may appear on the LCD screen. This is not a malfunction.
- While you are using your camcorder, the back of the LCD screen may heat up. This is not a malfunction.



■ To clean the LCD screen

If fingerprints or dust make the LCD screen dirty, use the cleaning cloth (optional) to clean the LCD screen.

When you use the LCD Cleaning Kit (optional), do not apply the cleaning liquid directly to the LCD screen. Use cleaning paper moistened with the liquid.

■ On adjustment of the LCD screen (CALIBRATION)

The buttons on the touch panel may not work correctly. If this happens, follow the procedure below. It is recommended you connect your camcorder or the Handycam Station to the wall socket with the supplied AC Adaptor during the operation.

- ① Slide the POWER switch to light up the  (PLAY/EDIT) lamp.
- ② Remove cables other than that of the AC Adaptor from your camcorder or the Handycam Station.
- ③ Touch **[MENU]** → **[SETUP]** →  STANDARD SET → **[CALIBRATION]**.

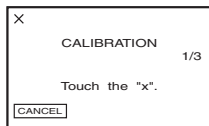

- ④ Touch the "x" displayed on the screen with a thin object such as a corner of "Memory Stick Duo".
The position of the "x" changes.
Touch **[CANCEL]** to cancel.

If you did not press the right spot, try the calibration again.

- Do not use a sharp-pointed tool to calibrate the LCD screen. Doing so may damage the surface of the screen.
- You cannot calibrate the LCD screen if you have rotated it, or if you have set it with the LCD screen side facing out.

On handling the casing

- If the casing is soiled, clean the camcorder body with a soft cloth lightly moistened with water, and then wipe the casing with a dry soft cloth.
- Avoid the following to prevent damage to the finish.
 - Using chemicals such as thinner, benzene, alcohol, chemical cloths, repellent and insecticide and sunscreen.
 - Handling with above substances on your hands.
 - Leaving the casing in contact with rubber or vinyl objects for a long period of time.

Care and storage of the camera lens

- Wipe the surface of the lens clean with a soft cloth in the following instances:
 - when there are fingerprints on the lens surface.
 - in hot or humid locations
 - when the lens is exposed to salty air such as at the seaside.
- Store the lens in a well-ventilated location subject to little dirt or dust.
- To prevent mold, periodically clean the lens as described above. It is recommended that you operate your camcorder about once a month to keep it in optimum state for a long time.

To charge the pre-installed rechargeable battery

Your camcorder has a pre-installed rechargeable battery to retain the date, time, and other settings even when the POWER switch is set to OFF (CHG). The pre-installed rechargeable battery is always charged while you are using your camcorder but it will get discharged gradually if you do not use your camcorder. The rechargeable battery will be fully discharged in **about 3 months** if you do not use your camcorder at all. However, even if the pre-installed rechargeable battery is not charged, the camcorder operation will not be affected as long as you are not recording the date.

■ Procedures

Connect your camcorder to a wall socket using the AC Adaptor supplied with your camcorder, and leave your camcorder with the POWER switch turned off for more than 24 hours.

To change the battery of the Remote Commander (DCR-SR50E/SR60E/SR70E/SR80E)

- ① While pressing on the tab, inset your fingernail into the slit to pull out the battery case.
- ② Place a new battery with the + side facing up.
- ③ Insert the battery case back into the Remote Commander until it clicks.

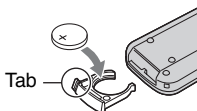

WARNING

Battery may explode if mistreated. Do not recharge, disassemble or dispose of in fire.

- A button-type lithium battery (CR2025) is used in the Remote Commander. Do not use batteries other than the CR2025.
- When the lithium battery becomes weak, the operating distance of the Remote Commander may shorten, or the Remote Commander may not function properly. In this case, replace the battery with a Sony CR2025 lithium battery. Use of another battery may present a risk of fire or explosion.

On trademarks

- “Handycam” and **HANDYCAM** are registered trademarks of Sony Corporation.
- “InfoLITHIUM” is a trademark of Sony Corporation.
- “Memory Stick Duo” is a trademark of Sony Corporation.
- “ImageMixer for HDD Camcorder” is a trademark of Pixela Corporation.
- Dolby and the double-D symbol are trademarks of Dolby Laboratories.
- Dolby Digital Stereo Creator is a trademark of Dolby Laboratories.
- DVD-R, DVD-RW, and DVD+RW logo are trademarks.
- Microsoft, Windows, and Windows Media are either registered trademarks or trademarks of Microsoft Corporation in the United States and/or other countries.
- Macintosh is a trademark of Apple Computer, Inc. in the U.S. and other countries.
- Pentium is a trademark or registered trademark of Intel Corporation.

All other product names mentioned herein may be the trademarks or registered trademarks of their respective companies. Furthermore, ™ and “®” are not mentioned in each case in this Handbook.

Notes on the License

ANY USE OF THIS PRODUCT OTHER THAN CONSUMER PERSONAL USE IN ANY MANNER THAT COMPLIES WITH THE MPEG-2 STANDARD FOR ENCODING VIDEO INFORMATION FOR PACKAGED MEDIA IS EXPRESSLY PROHIBITED WITHOUT A LICENSE UNDER APPLICABLE PATENTS IN THE MPEG-2 PATENT PORTFOLIO, WHICH LICENSE IS AVAILABLE FROM MPEG LA, L.L.C., 250 STEELE STREET, SUITE 300, DENVER, COLORADO 80206.

Glossary

■ Extension

The last three letters of a file name after “.”. The extension of a movie file recorded on the camcorder is “.MPG,” while that of a still image is “.JPG”. If you cannot see an extension on your file name, see page 108.

■ Formatting

The process of deleting all recorded image data from the hard disk of the camcorder and restoring its original storage capacity. You can initialize the hard disk of the camcorder using [HDD FORMAT] (p.55).

■ Fragmentation

The condition of a hard disk in which files are divided into pieces scattered around the hard disk. You may not save your images correct. You can solve the condition by performing [HDD FORMAT] (p.55).

■ JPEG

JPEG stands for Joint Photographic Experts Group, a still image data compression (data capacity reduction) standard. Hard Disk Drive Handycam records still images in JPEG format.

■ MPEG2

MPEG stands for Moving Picture Experts Group, the group of standards for the coding (image compression) of video (movie) and audio. There are MPEG1 (standard definition) and MPEG2 (high definition) formats. Hard Disk Drive Handycam records movies in MPEG2 format.

■ Photomovie

A series of still images (JPEG format) recorded with a camcorder is converted and resaved as a movie (MPEG format) to be played back on another DVD device or computer. Create a Photomovie to view still images on a DVD device that does not support JPEG playback. Still images converted to a Photomovie are played back continuously like a slide show. Resolution is slightly reduced.

■ PictBridge

PictBridge is a standard created for direct printing from digital cameras to printers. By connecting a PictBridge-compatible printer, you can print out still images without using a computer (p.71).

■ Playlist

A list of your favorite selected original movies.

It enables simple editing of original recorded data such as changing playback order.

■ Protection

The setting for preventing you from deleting image data.

■ Recording mode

By setting the recording mode before recording, you can select the image quality. There are 3 modes: HQ (high quality), SP (standard play) and LP (long play). The higher the recording quality, the shorter the recording time.

■ Thumbnail

Reduced-size images which enable you to view many images at the same time. The VISUAL INDEX screen uses a thumbnail display system.

■ USB 2.0

USB 2.0 is a standard for connecting with various devices. When your computer is compatible with USB 2.0, you can transfer data in high-speed between computers.

■ VBR

VBR stands for Variable Bit Rate, the recording format for automatically controlling the bit rate (the volume of recording data in a given time segment) according to the scene being recorded. For fast-moving video, a lot of disc space is used to produce a clear image so the recording time is short.

■ VISUAL INDEX

This function displays images of movies and still images you have recorded so that you can select those scenes you want to play back.

Index

Numerics

12IMAGES	59
16:9 (wide).....	23
21-pin adaptor.....	40
4:3	23
6IMAGES	59

A

A/V connecting cable	13, 39, 67, 69
A/V jack.....	39, 67, 69, 73
AC Adaptor	13, 14, 15, 81, 85, 86, 95
ACCESS lamp	29
Active Interface Shoe	73
Adjusting exposure for back light.....	32
AREA SET	60
Aspect ratio	23
AUTO SHUTTER	50
A.SHUT OFF (Auto shut off)	60

B

BACK LIGHT button.....	32
Backup.....	<i>See Saving images</i>
Battery	
BATTERY INFO	34
Battery pack.....	14
Remaining battery	34
BATT (battery) release lever	15
BEACH&SKI	48
BEEP	60
BLACK FADER.....	54
Browser.....	89
Build-in stereo microphone	34
BURST	53
EXP. BRKTG.....	53
NORMAL.....	53

Button-type lithium battery	120
B&W	54

C

CALIBRATION.....	119
CAMERA DATA.....	59
CAMERA SET.....	48
CD-ROM.....	13, 74, 77
Charging the battery	14
Charging time	16
CHG (charge) lamp	14
CLOCK SET	22
COLOR SLOW S (Color Slow Shutter)	51, 105
Computer.....	74, 84, 89, 97
System requirements	75
Connect	
Computer.....	81
Printer.....	71
TV	39
VCR/DVD device	67, 69
Copy	84, 86
Copyright.....	3
Counter	36
CPU	75

D

DATA CODE.....	22, 37, 58
Date Index	31
DATE/TIME	58
DC IN jack.....	14, 15, 73
DC plug	14, 15
Delete.....	12, 35, 42, 97
DEMO MODE	55
Destination Folder	84, 88
DIGITAL ZOOM.....	51
DirectX	75
Disc drive	75, 77, 81, 93, 95
DISP OUTPUT.....	60
DISP/BATT INFO	20, 21, 34

DISPLAY	59
Display	75
Display indicators	36, 37
DROP SENSOR.....	56
Dubbing.....	67
DVD	80
DVD BURN	55
DVD BURN button.....	81
DVD type	80
DVD+R	80
DVD+R DL.....	80
DVD+RW	80
DVD-R	80
DVD-RW	80
D.EFFECT (Digital effect).....	54, 105

E

EASY button	24
Easy Handycam operation	24, 45
Easy PC Back-up	84
Editing images.....	91
EMPTY HDD	56
EUROCONNECTOR	40
EXP. BRKTG.....	53
EXPOSURE	49, 104
Extension.....	108, 116, 121

F

FADER.....	54, 105
File	116
FINE.....	53
Fireworks	48
Fixing the exposure	<i>See SPOT METER</i>
FLASH LEVEL	51
FLASH MODE	50
FLASH SET	50
FOCUS.....	50, 102
Folder	84, 116
Formatting.....	55, 121

Fragmentation.....121
FULL SPEED.....58

H

Handycam Station13, 14
Hard disk10, 75
HDD55, 85, 87, 95
HDD FORMAT.....55
HDD INFO.....55
HDD SET55
Highland5
Hi-Speed USB75
Holding the camcorder18
HQ57

I

Icon.....*See Display indicators*
Image management files.....116
IMAGE SIZE53
ImageMixer Menu
.....85, 87, 89, 91, 93, 95
ImageMixer MPEG Cutter...91
ImageMixer3 DVD
Authoring.....94, 95
INDOOR49
“InfoLITHIUM” battery pack
.....117
Initialize (Reset)34
Inquire75
Install77
Insulation sheet.....38

J

Jack.....73
JPEG.....116, 121

L

LANDSCAPE48
LANGUAGE.....60
LCD backlight20
LCD BL LEVEL58, 106
LCD BRIGHT58

LCD COLOR58
LCD PANEL.....60
LCD screen.....20
LCD SET.....58
Lens cover.....18, 29
LETTER BOX58
LOW.....57
LP (Long Play).....57
LUMI. KEY
(luminance key).....54

M

Macintosh.....75
Main sound.....57
Mains lead14, 15
Maintenance118
Memory75
MICREF LEVEL57
Mirror mode33
Moisture condensation118
MOSAIC55
Movie
REC MODE
(Recording mode).....57
Recording.....25, 29
Movie files116
MPEG2.....116, 121
MULTI-SOUND57
My Computer77
My Pictures97

N

NightShot plus.....32
NIGHT SHOT PLUS switch
.....32
NORMAL53
NS LIGHT
(NightShot Light).....51
NTSC.....114
Number of recordable still
images36

O

OLD MOVIE54
ONE PUSH49
One Touch DVD Burn.....80
Operation confirmation
beep.....*See BEEP*
OS75
OUTDOOR49
OVERLAP.....54

P

PAL.....114
PASTEL.....54
Personal Menu44, 61
Add61
Arrange the order.....62
Delete.....61
Reset62
Personal Menu button36
PHOTO button.....26, 29, 38
Photomovie121
PictBridge71, 121
PictBridge PRINT.....55
PICT.APPLI.
(Picture Application).....54
PICT. EFFECT
(Picture effect)54, 105
Pixela User Support Center
.....75
Playback.....27, 30
Playback time.....17
Playback zoom.....33
Playlist63, 95, 121
ADD63
ERASE63
MOVE64
Play65
tab27
PORTRAIT (Soft portrait)...48
Power supply.....114
POWER switch.....14, 15

Pre-installed rechargeable battery119

Preparation

- Camcorder13
- Computer77

Preview89, 91

Previous/next button28, 30

Previous/Next Date button31, 43, 66

Print71, 90

PROGRAM AE48, 104

PROTECT65

Protection65, 121

P-MENU... *See Personal Menu*

Q

QUALITY53

R

Rechargeable battery pack..... *See Battery*

Recording25, 29

Recording lamp34, 59

Recording mode57, 121

Recording time16

REC CTRL70

REC LAMP59

REC MODE57

REMAINING59

Remaining battery34

Remote Commander38

REMOTE CTRL59

REMOTE jack73

Remote sensor34

Removing the USB cable83

RESET34

Review35

Review deleting35

S

Saving images12, 41

Searching for desired images by date31

Self-diagnosis display110

SELF-TIMER51, 105

SEPIA54

Setup44

- CAMERA SET48
- HDD SET55
- Personal Menu44, 61
- PICT.APPLI54
- Setup items46
- STANDARD SET57
- STILL SET53
- TIME/LANGU60
- Using the Setup items ...44

SETUP ROTATE60

Shoe cover73

Shoulder belt33

Slide show33

Slide show button28, 30, 33

Software77

Sound card75

SP57

Speaker34

SPORTS (Sports lesson)48

SPOTLIGHT48

SPOT FOCUS50, 105

SPOT METER (Flexible spot meter)48, 104

SQUEZE (Squeeze)58

STANDARD53

STANDARD SET57

START/STOP25, 29

STEADYSHOT52, 102

Still image

- IMAGE SIZE53
- QUALITY53
- Recording26, 29

Still image files116

STILL SET53

Sub sound57

SUMMERTIME22, 60

SUNSET&MOON48

SUPER NSPLUS (Super NightShot plus)51, 105

Supplied items13

System requirements75

S VIDEO cable39, 67, 69

S VIDEO jack39, 67, 69

T

Task tray83

Telephoto32

Thumbnail59, 121

TIME/LANGU. (Language)60

Touch panel21

Transmitter38

Tripod33

TV39

TV color system114

TV TYPE39

U

USB1.158

USB2.058, 121

USB cable 13, 71, 81, 83, 85, 86, 95

USB jack71, 73

USB SELECT55, 85, 87, 95

USB SPEED58

Using abroad114

V

VBR121

Video operation buttons36

VISUAL INDEX27, 30, 122

Volume28, 30

V-OUT/PANEL60

W

Wall socket14, 15

Warning indicators110

Warning messages	110
WHITE BAL. (White balance)	49, 105
WHITE FADER	54
Wide angle.....	32
WIDE DISPLAY.....	58
WIDE SELECT	23, 52
Windows 2000.....	75
Windows XP.....	75
WIPE	54
Wireless Remote Commander <i>See Remote Commander</i>	
World time difference	115

Z

Zoom	32
Zoom lever	32
ZOOM LINK.....	59

Additional information on this product and answers to frequently asked questions can be found at our Customer Support Website.

<http://www.sony.net/>