

Digital Video Camera Recorder



Operating Instructions

Before operating the unit, please read this manual thoroughly, and retain it for future reference.

Owner's Record

The model and serial numbers are located on the bottom. Record the serial number in the space provided below. Refer to these numbers whenever you call upon your Sony dealer regarding this product.

Model No. **DCR-DVD** _____ Model No. **AC-** _____

Serial No. _____ Serial No. _____

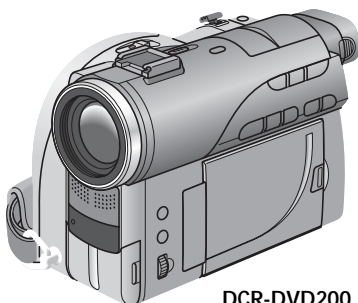

DCR-DVD200

HANDYCAM



DCR-DVD100/DVD200/DVD300

Welcome!

Congratulations on your purchase of this Sony Handycam. With your Handycam, you can capture precious moments with superior picture and sound quality. Your Handycam is loaded with advanced features, but at the same time it is very easy to use. You will soon be producing home movies that you will enjoy for years to come.

WARNING

To prevent fire or shock hazard, do not expose the unit to rain or moisture.

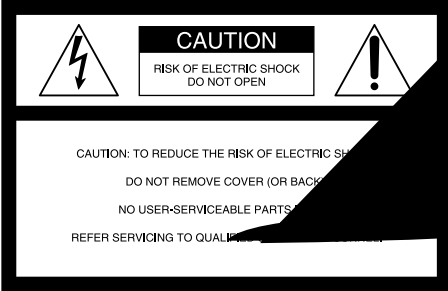

This symbol is intended to alert the user to the presence of uninsulated "dangerous voltage" within the product's enclosure that may be of sufficient magnitude to constitute a risk of electric shock to persons.



This symbol is intended to alert the user to the presence of important operating and maintenance (servicing) instructions in the literature accompanying the appliance.

CAUTION

The use of optical instruments with this product will increase eye hazard. Use of controls or adjustments or performance of products other than those specified herein may result in hazardous radiation exposure.

Notice

If static electricity or electromagnetism causes data transfer to discontinue midway (fail), restart the application or disconnect and connect the USB cable again.

For customers in the U.S.A. and CANADA

RECYCLE

Lithium-Ion



Caution: Do not handle damaged or leaking Lithium-Ion batteries.

CAUTION

TO PREVENT ELECTRIC SHOCK, MATCH WIDE BLADE OF PLUG TO WIDE SLOT, FULLY INSERT.

For customers in the U.S.A.

If you have any questions about this product, you may call :
Sony Customer Information Center 1-800-222-SONY (7669)
The number below is for the FCC related matters only.
Regulatory Information

Declaration of Conformity

Trade Name: SONY
Model No.: DCR-DVD100
Responsible Party: Sony Electronics Inc.
Address: 680 Kinderkamack Road,
Oradell, NJ 07649 U.S.A.
Telephone No.: 201-930-6972

This device complies with Part 15 of the FCC Rules. Operation is subject to the following two conditions.: (1) This device may not cause harmful interference, and (2) this device must accept any interference received, including interference that may cause undesired operation.

Declaration of Conformity

Trade Name: SONY
Model No.: DCR-DVD200
Responsible Party: Sony Electronics Inc.
Address: 680 Kinderkamack Road,
Oradell, NJ 07649 U.S.A.

Telephone No.: 201-930-6972

This device complies with Part 15 of the FCC Rules. Operation is subject to the following two conditions.: (1) This device may not cause harmful interference, and (2) this device must accept any interference received, including interference that may cause undesired operation.

Declaration of Conformity

Trade Name: SONY
Model No.: DCR-DVD300
Responsible Party: Sony Electronics Inc.
Address: 680 Kinderkamack Road,
Oradell, NJ 07649 U.S.A.

Telephone No.: 201-930-6972

This device complies with Part 15 of the FCC Rules. Operation is subject to the following two conditions.: (1) This device may not cause harmful interference, and (2) this device must accept any interference received, including interference that may cause undesired operation.

CAUTION

You are cautioned that any changes or modifications not expressly approved in this manual could void your authority to operate this equipment.

Note:

This equipment has been tested and found to comply with the limits for a Class B digital device, pursuant to Part 15 of the FCC Rules. These limits are designed to provide reasonable protection against harmful interference in a residential installation. This equipment generates, uses, and can radiate radio frequency energy and, if not installed and used in accordance with the instructions, may cause harmful interference to radio communications. However, there is no

guarantee that interference will not occur in a particular installation. If this equipment does cause harmful interference to radio or television reception, which can be determined by turning the equipment off and on, the user is encouraged to try to correct the interference by one or more of the following measures:

- Reorient or relocate the receiving antenna.
- Increase the separation between the equipment and receiver.
- Connect the equipment into an outlet on a circuit different from that to which the receiver is connected.
- Consult the dealer or an experienced radio/TV technician for help.

The supplied interface cable must be used with the equipment in order to comply with the limits for a digital device pursuant to Subpart B of Part 15 of FCC Rules.

Certain countries may regulate disposal of the battery used to power this product. Please consult with your local authority.

Read this first

What you can do with your DVD Handycam

Your DVD Handycam uses DVD-R and DVD-RW as a recording media. You can enjoy your DVD Handycam in ways that are new and different from those of a tape media-based camcorder. Read the next few pages to find out how.

You can find a scene quickly using a Visual Index display.

The Visual Index display shows thumbnails of movies and still images recorded on the disc in your DVD Handycam. You can find the desired scene quickly using this convenient index.

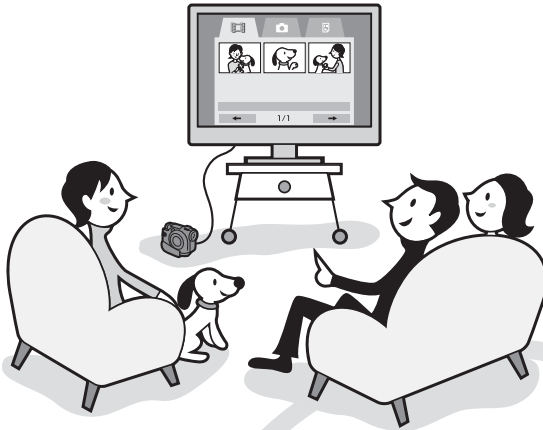

You can play back a disc recorded with your DVD Handycam on your DVD player.

You can play back a disc recorded with your DVD Handycam on DVD players that can play back DVD-R/DVD-RW.

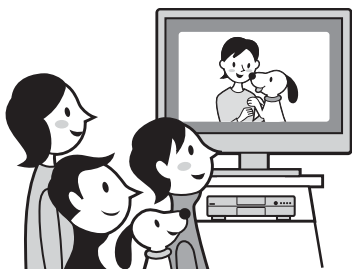

You can edit and copy a disc easily by connecting your DVD Handycam to your computer.

You can edit and copy a disc easily on your computer using the supplied ImageMixer Ver. 1.5 for Sony DVD Handycam software. It also enables you to produce your own original DVD disc.

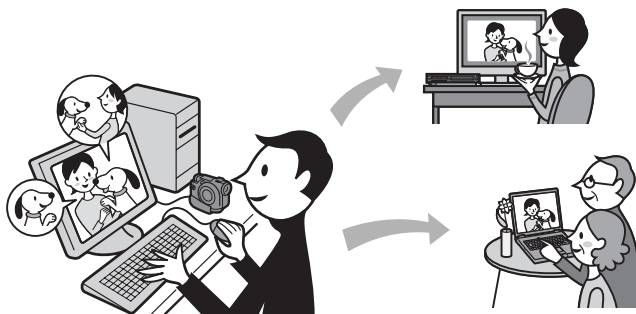

What is the difference between DVD-R and DVD-RW?

Two types of discs are available and they are different in the following ways.



Which disc can I use?

8cm DVD-Rs and 8cm DVD-RWs are available.



How can I choose between these two discs?

The number of recordable times is different for the two discs. Choose the one that meets your needs.

8cm DVD-R

You can use the following discs:

- DMR30 (single-sided disc)
- DMR60 (double-sided disc)

DVD-Rs can be recorded only once.

It is suitable for permanent records and for making a backup copy. Recorded in VIDEO mode.

8cm DVD-RW

You can use the following discs:

- DMW30 (single-sided disc)
- DMW60 (double-sided disc)

DVD-RWs can be overwritten repeatedly.

It is suitable for source gathering and temporary recordings. You can choose VIDEO mode or VR mode to make your recordings (see page 26).

Discs other than these two types are cannot be used in your DVD Handycam.

Examples of incompatible discs

- 12cm DVD-R
- 12cm DVD-RW
- DVD+R
- DVD-RAM
- DVD+RW
- DVD-ROM
- CD-R
- CD-RW



What kind of player can I use for playback?

You can play back a disc you have recorded on your DVD Handycam on other players by finalizing the disc (see page 63).

The following list shows examples of players that can play back a disc recorded by your DVD Handycam. However, playback compatibility is not guaranteed with all players.*

DVD-R (VIDEO mode only)

Players compatible with the DVD Video format.

DVD-RW (in VIDEO mode)

Players that can play back DVD-RWs.

DVD-RW (in VR mode)

Players that can play back DVD-RWs in VR mode.



Computer with a DVD drive installed

In VIDEO mode and VR (Video Recording) mode

VIDEO mode: A disc has wide compatibility with other players.

VR mode: A disc can be edited on DVD Handycam but the players are limited.

* DVD-R/RW discs recorded by Sony DVD Handycam camcorders are designed to be compatible with and may be played back on most home DVD players, computer DVD drives, and PlayStation 2 video game consoles.**

** Playback on all home DVD players, computer DVD drives, and PlayStation 2 consoles cannot be guaranteed. Some players, drives, and video game consoles lack the ability to read due to the optical reflection standards of DVD-R/RW discs and/or due to encoding incompatibilities. Refer to the specifications of your playback equipment for additional compatibility information.

How to prepare and use your DVD Handycam

Preparing



Prepare a new disc.

- You can start recording promptly with a DVD-R.
- You need to format a DVD-RW before recording. Formatting is required also when using a once recorded DVD-RW again.

Select a recording format (either VIDEO mode or VR mode) when using DVD-RW.

Shooting



Both movies and still images can be recorded on a single disc.

Because your movies and still images are recorded in free areas on the disc automatically, important recordings are not overwritten.

Playing back

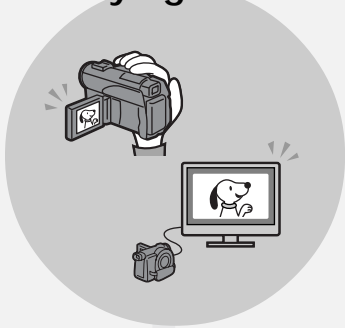

Select a scene to play back from the Visual Index display.

Continued on the right page.

Editing

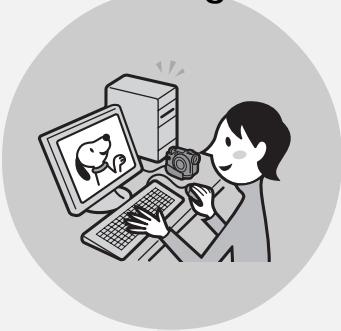

- You can make a copy of a disc you have recorded by connecting your DVD Handycam to your computer with the supplied software.

For the recommended computer system environment, see page 89.

- You can produce an original DVD by editing your movies/still images on your computer.

Finalizing

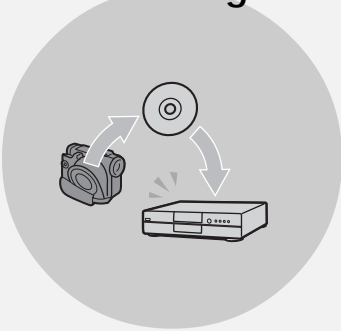

- Finalize the disc so that it is compatible with other DVD players.

You may not overwrite, edit, or format a disc after finalizing it.

	Overwrite	Edit	Format
DVD-R (VIDEO mode)	No	No	No
DVD-RW (VIDEO mode)	Yes*1	No	Yes*3
DVD-RW (VR mode)	Yes*2	Yes*2	Yes*3

*1 Unfinalizing a disc is required.

*2 Unfinalizing a disc is not required.

*3 Recorded data will be erased.

Table of contents

Read this first

What you can do with your DVD Handycam	4
What is the difference between DVD-R and DVD-RW?	6
How to prepare and use your DVD Handycam	8

Getting Started

Using this manual	12
Checking the supplied accessories	14
Step 1 Preparing the power source ...	15
Installing/removing the battery pack	15
Charging the installed battery pack	16
Showing the remaining battery time – BATTERY INFO	18
Connecting to a wall outlet	18
Step 2 Opening the LCD screen	19
Step 3 Turning on the power	20
Step 4 Setting the date and time	21
Simple setting of the clock using a time difference	23
Step 5 Adjusting the LCD screen and the viewfinder	24
Adjusting the brightness of the LCD screen	24
Adjusting the viewfinder	25
Step 6 Preparing a disc for recording.	26

Shooting movies/still images

Shooting movies/still images	28
Before shooting	28
Shooting movies	29
Shooting still images	34
Shooting techniques to match your circumstances	41
Shooting backlit subjects – BACK LIGHT	41
Shooting in the dark – NightShot/Super NightShot/ Color Slow Shutter	41
Shooting with the subject checking the image – Mirror mode	43
Self-timer recording	43
Adjusting the white balance manually	44
Shooting for the wide-screen TV – Wide mode	45

Optimizing the camera automatically – PROGRAM AE	47
Adjusting the exposure manually	48
Focusing manually	49
Shooting with special effects	50
Using fader (for movies only)	50
Using special effects – Picture effect/Digital effect	51
Other functions	53
Checking the last scene – Review	53
Deleting the last scene (DVD-RWs only)	53
Changing the disc title	54

Viewing the recordings

Playing a disc on your camcorder	55
Choosing and viewing a recording – Visual Index	55
Various playback modes	57
To display the indicators during playback – Display	58
Magnifying recorded images – PB ZOOM	60
Playing still images automatically – Slide Show	61
Viewing recordings on TV	62
If your TV is already connected to a VCR	62
If your TV or VCR is a monaural type	62

Finalizing a disc for other players

Finalizing a disc	63
Playing back a finalized disc on other players	66
Playing back a disc on DVD players	66
Playing back movies on a computer with a DVD drive installed	68
Showing still images on a computer with a DVD drive installed	68
Structures and file names of movies and still images	69
Recording on a finalized disc – Unfinalizing (VIDEO mode DVD-RWs only) ...	70
Recording again on a used disc – Formatting (DVD-RWs only)	72

Table of contents

Using a disc in VR mode (DVD-RWs only)

Selecting the playing order on your camcorder – Playlist	74
Registering movies or still images to the Playlist	74
Saving all the still images on a disc to a movie file	77
Erasing unnecessary scenes from the Playlist	78
Changing the order within the Playlist	80
Dividing a movie within the Playlist	82
Playing the Playlist.....	84
Editing the original data	85
Dividing a movie	85
Deleting movies/still images	87

Viewing/dubbing discs/ editing the recordings on your computer

Connecting your camcorder to your computer – Introduction	89
System requirements	89
Installing the USB driver	90
Installing software	91
Connecting your camcorder to the computer	92
Consulting the on-line help (operating instructions) of ImageMixer Ver.1.5 for Sony DVD Handycam	97
Viewing scenes recorded on your computer	98
Viewing scenes on the disc	98
Making a disc copy – Disc Dubbing .	100
Making a disc copy	100
Editing and saving scenes.....	101
Editing movies	101
Saving the movie on your computer	101
Creating an original disc	102
Making a menu	102
Editing the contents	103
Recording on a disc	104

Connecting your camcorder to a TV and a VCR

Dubbing a disc to a tape.....	105
Connecting your camcorder to a VCR	105
Dubbing to a tape	106
Dubbing a TV program or video tape onto a disc	107
Connecting your camcorder to a TV or a VCR.....	107
Dubbing onto a disc	107

Customizing your camcorder

Changing the SETUP display	108
Selecting the option of each item.	109

Troubleshooting

Types of trouble and corrective action	116
Self-diagnosis display	123
Warning indicators	124
Warning messages	125

Additional information

About the “InfoLITHIUM” battery pack	127
Glossary	128
Using your camcorder abroad	129
Maintenance information and precautions	130
Specifications	134

Parts and controls/Index

Identifying parts and controls	136
Index	144

Using this manual

The instructions in this manual are for the three models listed in the table below. Before you start reading this manual and operating your camcorder, check the model number by looking at the bottom of your camcorder. The DCR-DVD200 is the model used for illustration purposes. Otherwise, the model name is indicated in the illustrations. Any differences in operation are clearly indicated in the text, for example, “DCR-DVD200 only”.

Types of differences

Model	DVD100	DVD200	DVD300
Image device	4.5mm (1/4 type) CCD, gross approx. 680 000 pixels	3.8 mm (1/4.7 type) CCD, gross approx. 1 070 000 pixels	3.8 mm (1/4.7 type) CCD, gross approx. 1 070 000 pixels
LCD screen	6.2 cm (2.5 type)	6.2 cm (2.5 type)	8.8 cm (3.5 type)

Note on TV color systems

TV color systems differ depending on the country or region. To view your recordings on a TV, you need an NTSC system-based TV.

Copyright precautions

Television programs, films, video tapes, and other materials may be copyrighted. Unauthorized recording of such materials may be contrary to copyright laws. You cannot dub copyright protected software on your camcorder.

Contents of the recording cannot be compensated if recording or playback is not made due to a malfunction of the camcorder, storage media, etc.

Camcorder care

LCD screen/finder

The LCD screen and the finder are manufactured using extremely high-precision technology, so over 99.99 % of the pixels are operational for effective use. However, there may be some tiny black points and/or bright points (white, red, blue or green in color) that appear constantly on the LCD screen and the finder. These points are normal in the manufacturing process and do not affect the recording in any way.

Disc compatibility with other players

Discs recorded on your camcorder must be finalized to play with other players. For details on how to finalize a disc, see “Finalizing a disc” (page 63).

Discs recorded in VIDEO mode

You must finalize a disc after all the recording is finished. You cannot record again on a disc recorded in VIDEO mode once you finalize it. On DVD-RW, you can record again by unfinalizing it.

Compatible players: DVD players

Discs recorded in VR mode

Only DVD-RWs can be recorded in VR mode. Finalizing is required only when other DVD-RW compatible players cannot play the disc. You can record again with your camcorder on a finalized disc recorded in VR mode.

Compatible players: DVD players that can play back DVD-RWs in VR mode

Note

You may not be able to play certain finalized discs, depending on the disc and the players.

Checking the supplied accessories

Make sure that the following accessories are supplied with your camcorder.

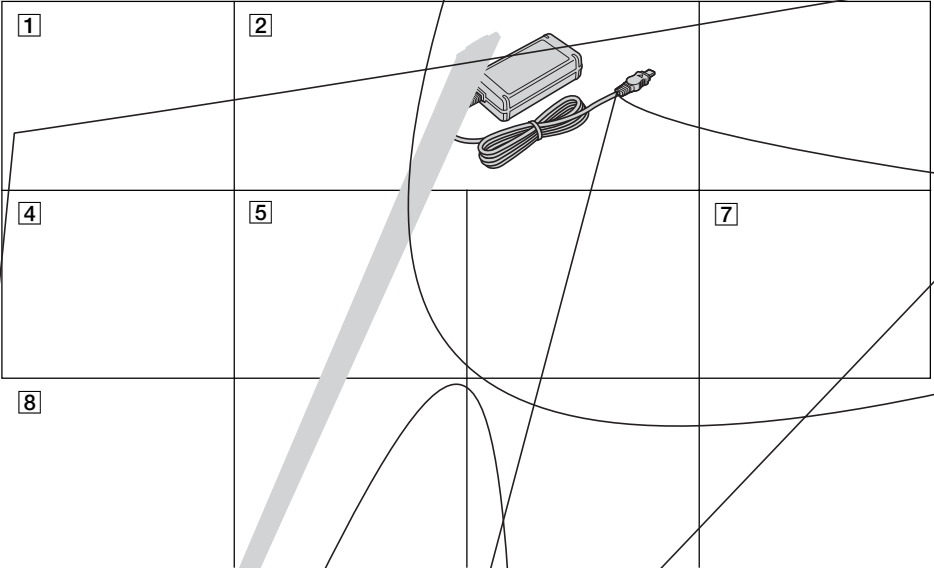

1 Wireless Remote Commander (1)
(page 141)

2 AC-L15A AC adaptor (1),
Power cord (1) (page 16)

3 Size AA (R6) battery for the Remote
Commander (2) (page 142)

4 NP-FM50 rechargeable battery pack
(1) (page 15)

5 A/V connecting cable (1)

6 Shoulder strap (1)

7 Lens cap (1) (page 29)

8 USB cable (1) (page 92)

9 DVD-R (DMR30) (1)

10 CD-ROM (SPVD-011 USB Driver) (1)

11 Cleaning cloth (1)

Step 1 Preparing the power source

Installing/removing the battery pack

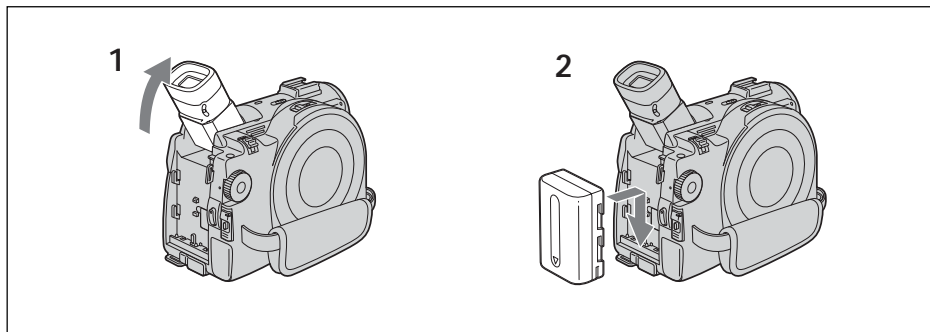

- 1 Lift up the viewfinder.
- 2 Slide the battery pack in and down until it clicks.

To remove the battery pack

- 1 Lift up the viewfinder.
- 2 Slide the battery pack up and out in the direction of the arrow while pressing BATT down.

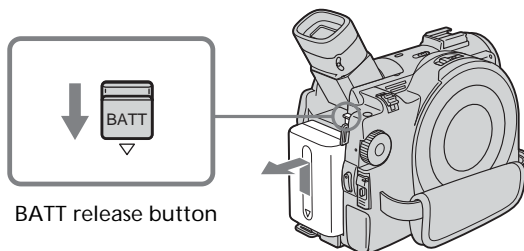

Step 1 Preparing the power source

Charging the installed battery pack

Your camcorder operates only with the "InFoLITHIUM" battery pack (M series).
See page 127 for more information on the "InFoLITHIUM" battery pack.

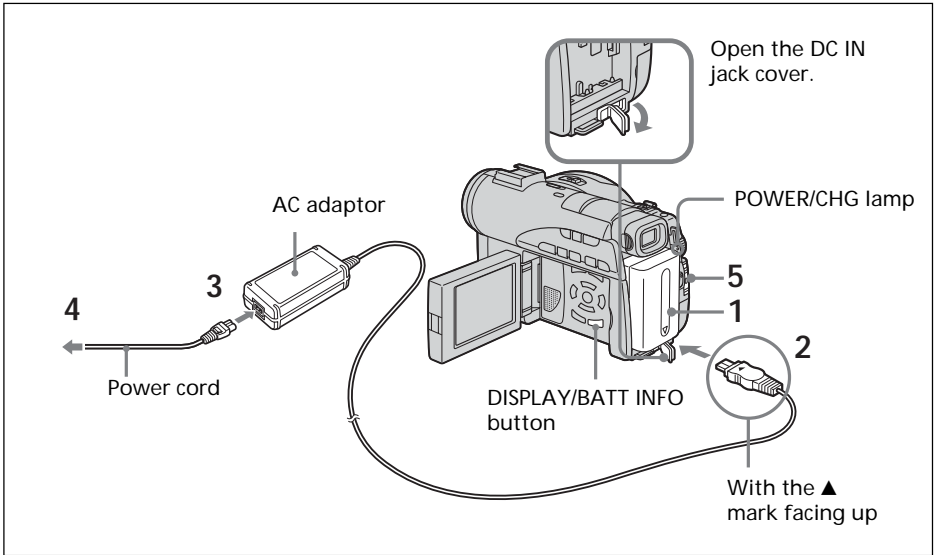

- 1 Make sure that the battery pack is installed on the camcorder.
- 2 Open the DC IN jack cover, then connect the AC adaptor supplied with your camcorder to the DC IN jack on your camcorder with the plug's ▲ mark facing up.
- 3 Connect the power cord to the AC adaptor.
- 4 Connect the power cord to the wall outlet.
- 5 Slide the POWER switch downward while pressing the green button in the center.
Charging begins. The POWER/CHG lamp lights in orange during the charge, then turns off when the charge is completed (full charge).

After charging the battery pack

Disconnect the AC adaptor from the DC IN jack on your camcorder.

Notes on the AC adaptor

- Prevent metallic objects from coming into contact with the metal parts of the DC plug of the AC adaptor. This may cause a short-circuit, damaging the AC adaptor.
- Place the AC adaptor near a wall outlet. If any trouble occurs with this unit while using the AC adaptor, disconnect the plug from the wall outlet as soon as possible to cut off the power.
- The POWER/CHG lamp may flash if the battery pack is not installed correctly or the battery pack is damaged.

Step 1 Preparing the power source

Charging time (full charge)

Battery pack

NP-FM50 (supplied)	150
NP-FM70	240
NP-QM71/QM71D	260
NP-FM91/QM91/QM91D	360

Approximate number of minutes required at 25°C (77°F) to charge an empty battery pack. The charging time may increase if the battery's temperature is extremely high or low because of the ambient temperature.

Recording time with the viewfinder

Battery pack	Continuous			Typical		
	DVD100	DVD200	DVD300	DVD100	DVD200	DVD300
NP-FM50 (supplied)	85	75	75	40	35	35
NP-FM70	185	170	170	90	85	85
NP-QM71/QM71D	215	195	195	105	95	95
NP-FM91/QM91/QM91D	325	295	295	160	145	145

Recording time with the LCD screen

Battery pack	Continuous			Typical		
	DVD100	DVD200	DVD300	DVD100	DVD200	DVD300
NP-FM50 (supplied)	70	65	65	35	30	30
NP-FM70	155	145	140	75	70	70
NP-QM71/QM71D	180	165	160	90	80	80
NP-FM91/QM91/QM91D	275	255	245	135	125	120

Approximate number of minutes you can record when using a fully charged battery pack.

* Approximate number of minutes you can record, including starting/stopping, zooming and turning the power on/off. The actual battery life may be shorter.

Playing time

Battery pack	Playing time on LCD screen			Playing time with LCD closed		
	DVD100	DVD200	DVD300	DVD100	DVD200	DVD300
NP-FM50 (supplied)	80	80	75	100	100	100
NP-FM70	175	175	170	210	210	210
NP-QM71/QM71D	205	205	195	245	245	245
NP-FM91/QM91/QM91D	305	305	295	375	375	375

Approximate number of minutes of playing time when using a fully charged battery pack.

Notes

- If the power goes off even though the remaining battery time indicator indicates that the battery pack has enough power to operate, charge the battery pack fully again so that the indication on the remaining battery time indicator is correct.
- Battery pack performance decreases in low-temperature surroundings and recording may not be possible even though the battery time remaining may be as much as 20 minutes. Recharge the battery pack fully in this case.
- NP-FM30 is not recommended because of its short recording time when used with your camcorder.

Step 1 Preparing the power source

Showing the remaining battery time – BATTERY INFO

- 1 Open the LCD screen while pressing OPEN.
- 2 Press DISPLAY/BATT INFO.
The remaining battery time appears for a while on the LCD display.

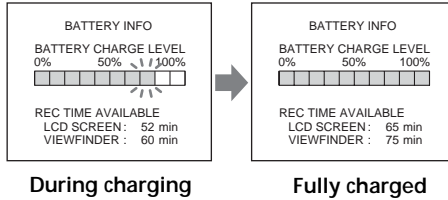

Notes

- The remaining battery time may not be indicated in the following cases:
 - The battery pack is not installed correctly.
 - The battery pack is damaged.
 - The battery pack is empty.
- The number displayed as Battery Info is the approximate recording time.
- While the remaining battery time is being calculated, “CALCULATING BATTERY INFO...” is displayed.
- It may take some time to display the remaining battery time after DISPLAY/BATT INFO is pressed.

Connecting to a wall outlet

When you use your camcorder for a long time, it is recommended that you power it from a wall outlet using the AC adaptor.

- 1 Open the DC IN jack cover, then connect the AC adaptor supplied with your camcorder to the DC IN jack on your camcorder with the plug's ▲ mark facing up.
- 2 Connect the power cord to the AC adaptor.
- 3 Connect the power cord to a wall outlet.
See page 16 for details.

WARNING

Your camcorder is not disconnected from the AC power source (house current) as long as it is connected to the wall outlet, even if your camcorder itself has been turned off.

Notes

- The AC adaptor can supply power even if the battery pack is attached to your camcorder.
- The DC IN jack has “source priority”. This means that the battery pack cannot supply any power if the AC adaptor is connected to the DC IN jack, even when the power cord is not plugged into a wall outlet.

Step 2 Opening the LCD screen

LCD screen is used for such as changing settings, shooting images in various angles, and reviewing recorded images.

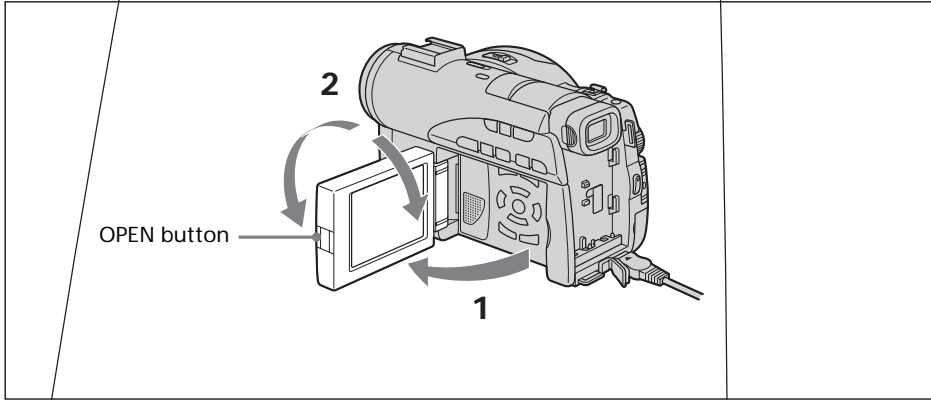

- 1** Open the LCD screen while pressing OPEN.
- 2** Adjust the direction of the LCD screen to the desired position.
When you adjust the angle of the LCD screen, make sure if the LCD screen is opened up to 90 degrees.
You can turn the LCD screen over and move it back to the camcorder body with the LCD screen facing out as shown below.

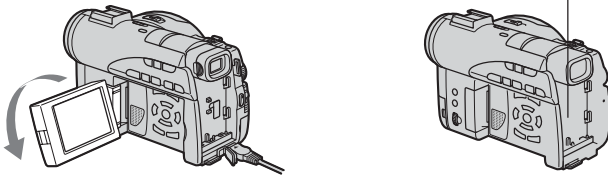

Notes

- When closing the LCD screen, set it vertically until it clicks, then swing it into the camcorder body.
- When the LCD screen is moved back to the camcorder while recording or while in standby to record, the screen backlight is fixed to the [BRT NORMAL].

Step 3 Turning on the power

Slide the POWER switch upward while pressing the green button in the center. Your camcorder turns on and the POWER/CHG lamp lights up in green.

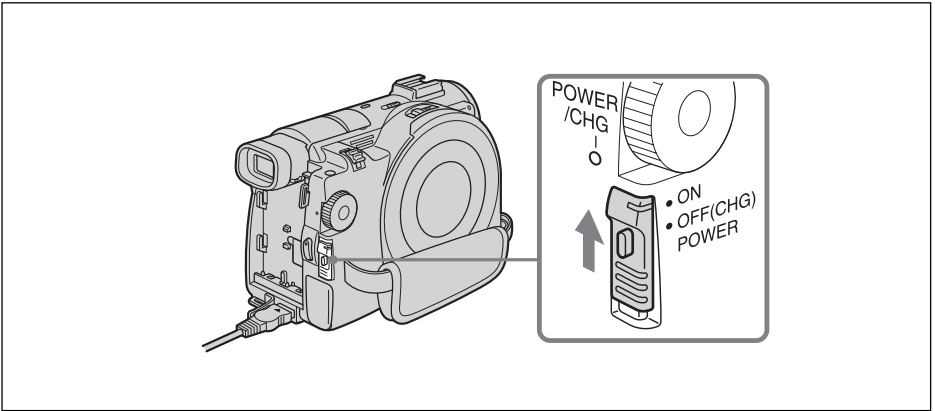

To turn off the power

Slide the POWER switch downward while pressing the green button in the center. When the POWER/CHG lamp turns off, the power cuts off.

Step 4 Setting the date and time

Set the date and time when you use your camcorder for the first time. Set the geographical area, then the daylight savings time, the year, the month, the day, the hour and then the minute, in that order.

If you do not use your camcorder for **about 3 months**, the date and time settings may be cleared from memory (bars may appear) because the built-in rechargeable battery in your camcorder will have been discharged during that time. In that case, charge the built-in rechargeable battery by connecting the AC adaptor, and set the date and time again (page 16, 132).

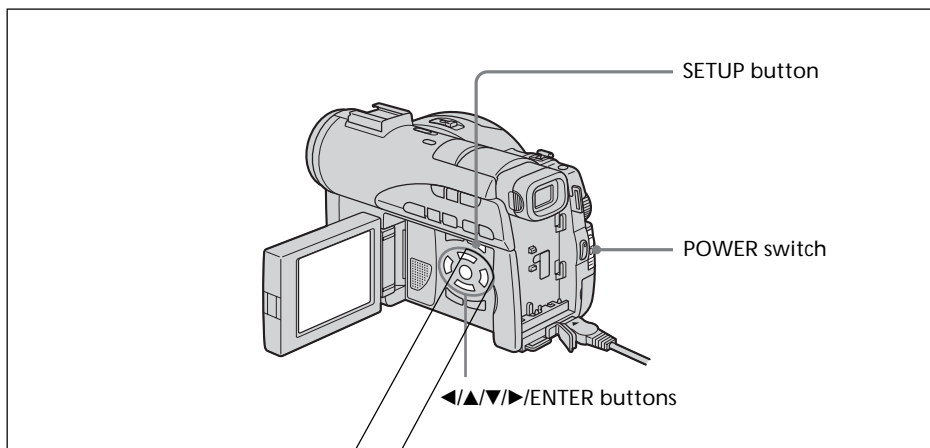

- 1 Open the LCD screen while pressing OPEN.
- 2 Turn the power on by sliding the POWER switch upward while pressing the green button.
The CLOCK/SET display appears.
- 3 Select the desired geographical area with $\blacktriangle/\blacktriangledown$, and press ENTER.

Step 4 Setting the date and time

- 4 Set daylight savings time ([DST]) to [ON] with ▲/▼ if necessary.

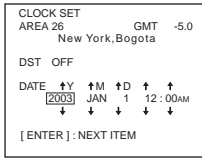

- 5 Select the desired year with ▲/▼, and press ENTER.

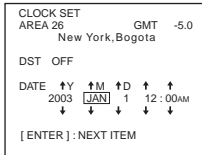

- 6 Set the month, day, hour and minute with the same procedure as in step 5.

Set the minute using a time signal, etc., with ▲/▼, and press ENTER.

The clock starts to move.

The internal clock of your camcorder operates on a 12-hour cycle.

- 12:00 AM stands for midnight.
- 12:00 PM stands for noon.

Tips

- If the CLOCK SET display does not appear in step 2, press SETUP, then select  (SETUP MENU), then [CLOCK SET] with ▲/▼.
- If the SETUP display appears after step 6, press SETUP. The SETUP display disappears.

Step 4 Setting the date and time

Simple setting of the clock using a time difference

You can easily set the clock to the local time by setting a time difference. In the SETUP display, select **ETC** (OTHERS) then **[AREA SET]** with **▲/▼/ENTER**.

World time difference

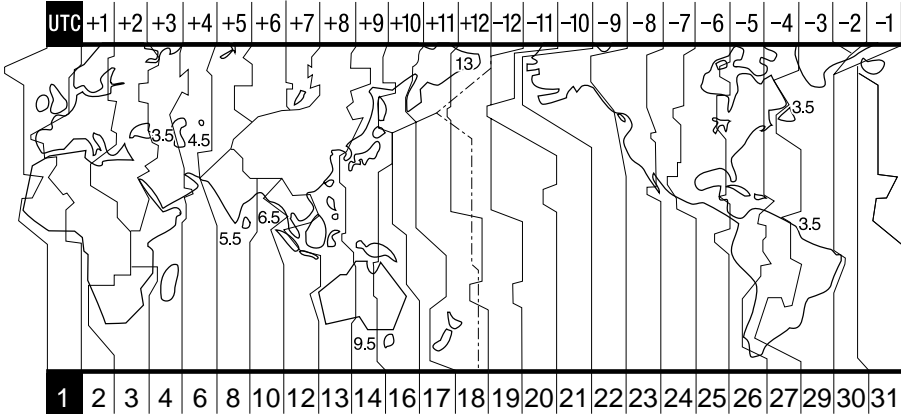

Area code	Time-zone differences	Area setting
1	GMT	Lisbon, London
2	+01:00	Berlin, Paris
3	+02:00	Helsinki, Cairo
4	+03:00	Moscow, Nairobi
5	+03:30	Tehran
6	+04:00	Abu Dhabi, Baku
7	+04:30	Kabul
8	+05:00	Karachi, Islamabad
9	+05:30	Calcutta, New Delhi
10	+06:00	Almaty, Dhaka
11	+06:30	Rangoon
12	+07:00	Bangkok, Jakarta
13	+08:00	HongKong, Singapore
14	+09:00	Seoul, Tokyo
15	+09:30	Adelaide, Darwin
16	+10:00	Melbourne, Sydney

Area code	Time-zone differences	Area setting
17	+11:00	Solomon Is.
18	+12:00	Fiji, Wellington
19	-12:00	Eniwetok, Kwajalein
20	-11:00	Midway Is., Samoa
21	-10:00	Hawaii
22	-09:00	Alaska
23	-08:00	Los Angeles, Tijuana
24	-07:00	Denver, Arizona
25	-06:00	Chicago, Mexico City
26	-05:00	New York, Bogota
27	-04:00	Santiago
28	-03:30	St. John's
29	-03:00	Brasilia, Montevideo
30	-02:00	Fernando de Noronha
31	-01:00	Azores

Step 5 Adjusting the LCD screen and the viewfinder

Adjusting the brightness of the LCD screen

Adjust the brightness of the LCD screen properly in your sight.

- 1 Open the LCD screen while pressing OPEN.
- 2 Turn the power on by sliding the POWER switch upward while pressing the green button.
- 3 Press SETUP.

The SETUP display appears.

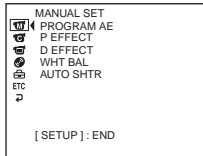

- 4 Select [LCD/VF SET] with ▲/▼, and press ENTER.

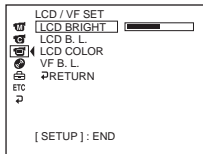

- 5 Select [LCD BRIGHT] with ▲/▼, and press ENTER.

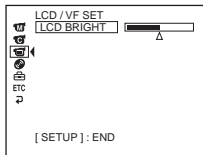

- 6 Adjust the brightness of the LCD screen with ◀/▶, and press ENTER.

◀: Get darker

▶: Get brighter

The LCD screen brightness is adjusted.

- 7 Press SETUP.

The SETUP display disappears from the LCD display.

Tips

- You can change the brightness of the backlight. Select [LCD/VF SET] then [LCD B.L.] in the SETUP display when using the battery pack (page 111).
- The [LCD BRIGHT] and [LCD B.L.] settings do not affect the brightness of the image when you are recording.

Step 5 Adjusting the LCD screen and the viewfinder

Adjusting the viewfinder

When recording pictures with the LCD screen closed, check the picture with the viewfinder. Adjust the viewfinder lens to accommodate your eyesight so that the image in the viewfinder comes into sharp focus.

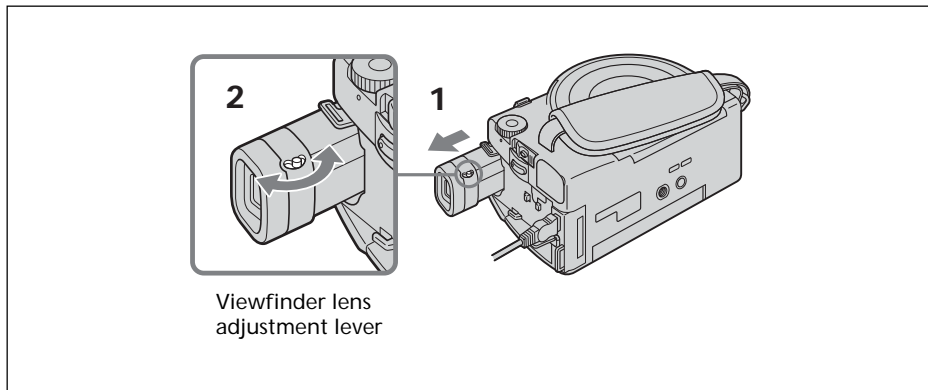

- 1** Lift up the viewfinder.
- 2** Move the viewfinder lens adjustment lever as you can see the characters in the viewfinder clearly.

Tips

- If you install an NP-FM70/QM71/QM71D/FM91/QM91/QM91D battery pack in your camcorder, extend and lift up the viewfinder and adjust the angle of it.
- You can change the brightness of the viewfinder backlight. Select [VF B.L.] in the SETUP display when using the battery pack (page 111).
- The [VF B.L.] setting does not affect the brightness of the image when you are recording.
- Recording pictures with the viewfinder is recommended in the following cases:
 - When the picture seen on the LCD display is poor.
 - When you want to save on battery consumption.

Step 6 Preparing a disc for recording

A new DVD-R or DVD-RW is required for recording. You cannot overwrite or delete data recorded on a DVD-R, but you can delete data and record again with a DVD-RW. The preparation procedure is different depending on the type of disc you use.

Note

You can open the disc cover only while the Access/Open lamp is lit in green. The cover will be locked after about 30 seconds if you do not open the disc cover. When the lamp turns off, slide the disc cover OPEN switch again.

Tips

- The camcorder is set in the VIDEO mode as the default setting.
- Formatting is required when a DVD-RW is used for the first time.

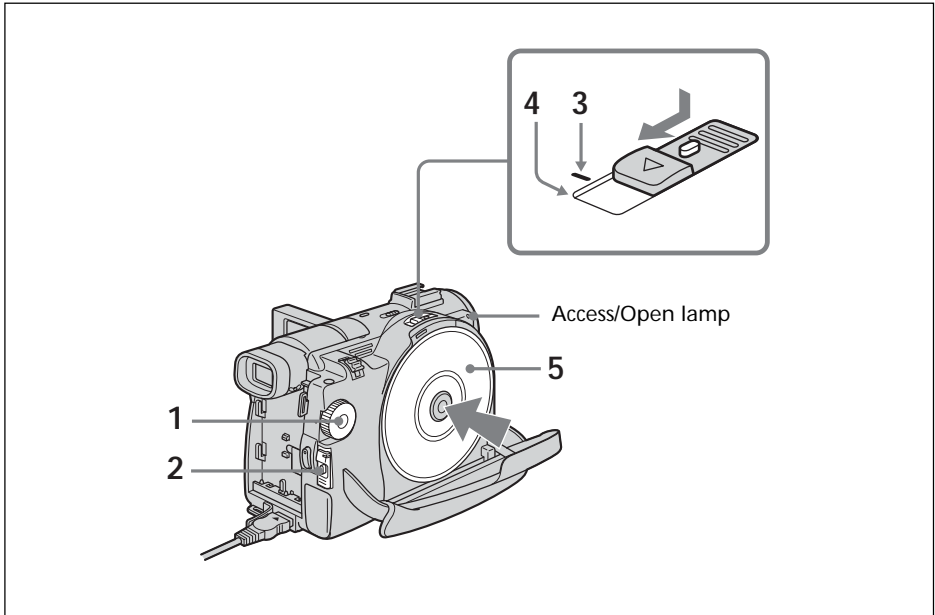

- 1 Set the mode dial to (Movie) or (Still).
- 2 Turn the power on by sliding the POWER switch upward while pressing the green button.
- 3 Slide the disc cover OPEN switch to the mark.
The beep sounds and PREPARING TO OPEN COVER appears on the LCD display. After a while, the beep sound changes and the Access/Open lamp lights in green, and SLIDE [OPEN] appears.
- 4 Slide the disc cover OPEN switch again to the end.
The disc cover opens.
- 5 Set the disc with the label side facing up, then press firmly to seat it on the center spindle until it clicks.
Make sure that the disc is not exposed to fingerprints and dust.

Step 6 Preparing a disc for recording

6 Close the disc cover.

Your camcorder starts recognizing the inserted disc.

With a DVD-R, you can start recording immediately after DISC ACCESS disappears on the LCD display. See page 29 for details on shooting movies and see page 34 for details on shooting still images.

The FORMAT display appears when you insert a DVD-RW. Proceed to step 7.

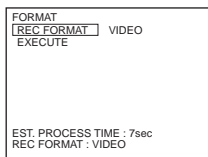

7 When recording in VIDEO mode, select [EXECUTE] and [YES] with ◀/▲/▼/▶, then press ENTER.

When recording in VR mode (page 7):

1 Select [REC FORMAT] with ▲/▼, then press ENTER.

2 Select [VR] with ▲/▼, then press ENTER.

3 Select [EXECUTE] with ▲/▼, then press ENTER.

4 Select [YES] with ▲/▼, then press ENTER.

The disc formatting starts. When the formatting is completed, you can start recording on the DVD-RW.

Notes

- If you close the disc cover with the disc set incorrectly, it may cause your camcorder to malfunction.
- Do not shock or vibrate your camcorder during “DISC ACCESS” appearing.
- It may take some time to recognize the disc depending on the disc type and condition.
- You may hear the motor running when the disc cover is closed without a disc being set. This is not a malfunction.
- Do not remove the battery pack or disconnect the AC adaptor while formatting.
- See page 133 for details on disc handling.

To eject the disc

1 Perform the steps 3 and 4 on page 26.

2 Take out the disc after the disc spin stops completely.

Note

You can open the disc cover only while the Access/Open lamp is lit in green.

On disc information

When you replace a disc, disc information such as the date you started to use it and information on previously recorded areas appears for about 5 seconds. The information on previously recorded areas may not be displayed correctly depending on the condition of the disc.

Shooting movies/still images

Before shooting

To shoot movies/still images correctly, note the following:

- Do not vibrate your camcorder during shooting.
- Do not expose the disc to dirt and dust.
- Do not scratch the disc.

You can shoot stable images by holding the camcorder correctly.

To hold your camcorder

Hold your camcorder with your fingers inserted through the grip belt.

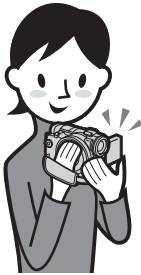

To fasten the grip belt

Fasten the grip belt firmly following the illustration below.

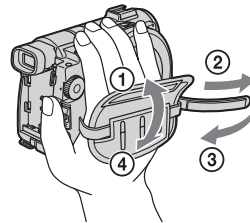

Note

Do not pick up your camcorder by the viewfinder, the LCD screen, or the battery pack.

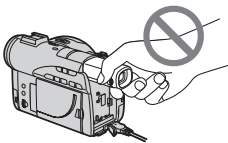

Viewfinder

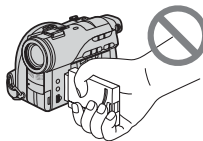

LCD screen

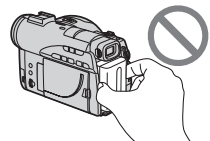

Battery pack

Shooting movies

Perform “Getting Started” from step 1 to 6 beforehand (page 15).
The following operation is common with VIDEO mode and VR mode.

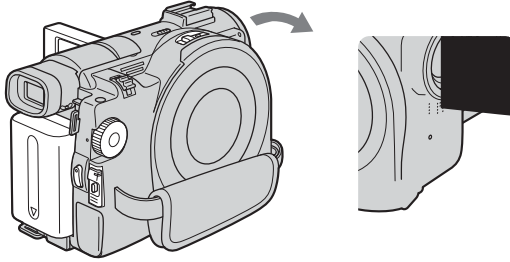

- 1** Remove the lens cap by pressing both knobs on the sides of the cap.
- 2** Install the battery pack or connect the AC adaptor (page 15).
- 3** Open the LCD screen while pressing OPEN.
The image is not displayed in the viewfinder when the LCD screen opens.
- 4** Set the mode dial to  (Movie).
- 5** Turn the power on by sliding the POWER switch upward while pressing the green button.
- 6** Insert a disc (page 26).
This sets your camcorder to standby.

Shooting movies/still images

7 Press START/STOP (●).

Your camcorder starts recording. The REC indicator appears on the LCD display. The camera recording lamp located on the front of your camcorder lights up. To stop recording, press START/STOP again.

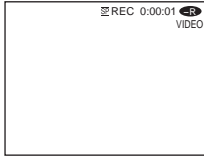

Notes

- Do not touch the built-in microphone during recording.
- When the Access/Open lamp lights in red, data is being recorded on the disc. Take note of the following when data is being recorded, or the data or the disc may be damaged.
 - Do not shock or vibrate the camcorder.
 - Do not turn the power off.
 - Do not remove the battery pack or disconnect the AC adaptor.
 - Do not open the disc cover.
- The time to access the disc for recording may vary depending on the type of movies.
- There may be time difference between the point when you press START/STOP and the actual point that the recording stops.

Tip

If you leave your camcorder powered by battery pack for 5 minutes while a disc is inserted, your camcorder automatically turns off. This is to save battery power and to prevent battery wear. Set the POWER switch to OFF (CHG) once, then set to ON, and your camcorder is set to a standby mode. You can cancel the automatic power-off by setting the  (SETUP MENU) – [A. SHUT OFF] menu item to [NEVER] in the SETUP display.

After recording

- 1 Eject the disc (page 27).
- 2 Turn the power off by sliding the POWER switch downward while pressing the green button.
- 3 Close the LCD screen.
- 4 Remove the battery pack or disconnect the AC adaptor.

Indicators displayed in the recording mode

These indicators are not recorded on discs.

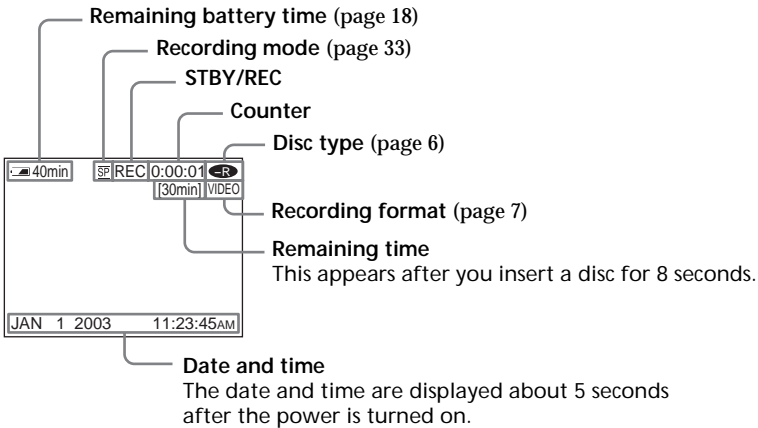

Notes

- The remaining battery time indicator shows the approximate continuous recording time remaining. The indicator may not be displayed accurately, depending on the conditions under which you are recording. When you close the LCD screen and open it again, it takes about 1 minute for the correct remaining battery time in minutes to be displayed.
- The recording data (date/time or various settings in effect when shooting) are not displayed while recording. However, they are recorded automatically onto the disc. To display the recording data, press DATA CODE on the Remote Commander during playback (page 58).

Shooting movies/still images

To use the zoom feature

Move the power zoom lever a little for
Using the zoom sparingly results in better
W: For wide-angle (subject appears farther)
T: For telephoto (subject appears closer)

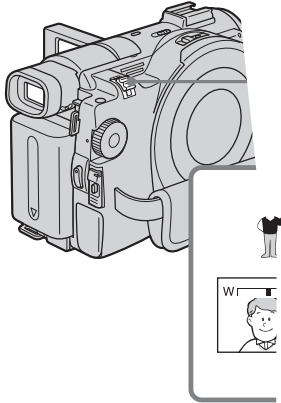

To use zoom greater than 10×

Zoom greater than 10× is performed digitally.
The picture quality deteriorates as you move
side.

To activate digital zoom, select the digital
display (page 110). The digital zoom is set

The right side of the bar shows
the digital zooming zone.
The digital zooming zone
appears when you select the
digital zoom power in the
SETUP display.

Note

You cannot use the digital zoom to shoot s

Tip

If you cannot get a sharp focus, move the
focus is sharp. You can shoot a subject that
away from the lens surface in the telephoto
away in the wide-angle position.

To Select the recording mode

Your camcorder records and plays back in the HQ (high quality) mode, SP (standard play) mode, and the LP (long play) mode. Your camcorder is set to SP mode as the default setting.

- 1 Set the mode dial to  (Movie).
- 2 Press SETUP.

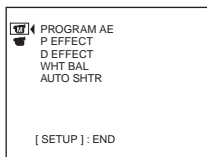

- 3 Select  (DISC SET) with ▲/▼, then press ENTER.

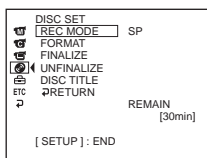

- 4 Select [REC MODE] with ▲/▼, then press ENTER.
The remaining time differs depending on the recording mode.

- 5 Select the desired recording mode with ▲/▼, then press ENTER.

Recording mode	Recording time*	Details
HQ	20 minutes	High quality
SP	30 minutes	Standard play
LP	60 minutes	Long play

- * • The numbers are for the reference.
- The picture quality generally improves as the recording time decreases.
- The table shows approximate recording time and the above numbers apply to a single-sided disc, and it will be doubled for a double-sided disc.

- 6 Press SETUP.
The SETUP display disappears from the LCD display.

Notes

- You can record for a longer time in the LP mode, but the recording mode is degraded compared with the SP mode, and block noise may appear in scenes with quick movement.
- Recording time may shorten depending on the type of images you are shooting.

Shooting movies/still images

Shooting still images

Perform “Getting Started” from step 1 to 6 beforehand (page 15).
The following operation is common with VIDEO mode and VR mode.



- 1** Remove the lens cap by pressing both knobs on the sides of the cap.

- 2** Install the battery pack or connect the AC adaptor (page 15).
- 3** Open the LCD screen while pressing OPEN.
The image is not displayed in the viewfinder when the LCD screen opens.
- 4** Set the mode dial to  (Still).
- 5** Turn the power on by sliding the POWER switch upward while pressing the green button.
- 6** Insert a disc (page 26).
This sets your camcorder to standby.

- 7** Press and hold PHOTO down lightly, then check out the image. When the AE/AF lock indicator (●) stops flashing and remains on, your camcorder is ready for shooting. The brightness of the image and focus are adjusted, are targeted for the middle of the image, and are set.

Number of recorded images

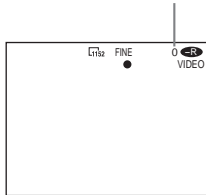

When you press PHOTO of the Remote Commander, the image appeared on the LCD display is recorded at once.

- 8** Press PHOTO all the way down. The CAPTURE indicator appears after the shutter sounds. Recording is complete when the bar scroll indicator disappears.

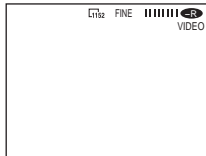

The image displayed when you pressed PHOTO all the way down in this step will be recorded.

Notes

- When the mode dial is set to  (Still), the following functions do not work.
 - Wide mode
 - Digital zoom
 - SteadyShot
 - Super NightShot
 - Color Slow Shutter
 - Fader
 - Picture effect
 - Digital effect
 - The Sports lesson feature of [PROGRAM AE] (The indicator flashes.)
- When the Access/Open lamp lights in red, data is being recorded on the disc. Take note of the following when data is being recorded, or the data and the disc may be damaged.
 - Do not shock or vibrate the camcorder.
 - Do not turn the power off.
 - Do not remove the battery pack or disconnect the AC adaptor.
 - Do not open the disc cover.
- When you press PHOTO lightly in step 7, the image momentarily flickers. This is not a malfunction.
- You can neither turn off the power nor press PHOTO while CAPTURE appears on the LCD display.
- The time to access the disc for recording may vary depending on the type of still images.

Shooting movies/still images

Tips

- The amount of recording data may vary depending on the settings for image quality and image size, and the type of images you are shooting.
- The recording data (date/time or various settings in effect when shooting) are not displayed while recording. However, they are recorded automatically onto the disc. To display the recording data, press DATA CODE on the Remote Commander during playback.
- The angle of view for still images is slightly wider compared with the angle of view of the movie mode (DCR-DVD200/DVD300 only).
- If you leave your camcorder powered by battery for 5 minutes while a disc is inserted, your camcorder automatically turns off. This is to save battery power and to prevent battery wear. Set the POWER switch to OFF (CHG) once, then set to ON, and your camcorder is set to a standby mode. You can cancel the automatic power-off by setting the  (SETUP MENU) - [A.SHUT OFF] menu item to [NEVER] in the SETUP display.

To Use the zoom feature

Move the power zoom lever a little for a slower zoom. Move it further for a faster zoom. For details, see page 32.

To select the still image quality

You can select the image quality for still image recording.
The default setting is [FINE].

- 1 Set the mode dial to  (Still).
- 2 Press SETUP.

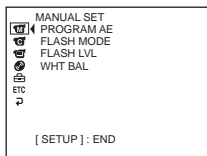

- 3 Select  (CAMERA SET) with $\blacktriangle/\blacktriangledown$, then press ENTER.

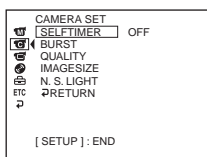

- 4 Select [QUALITY] with $\blacktriangle/\blacktriangledown$, then press ENTER.

The amount of recording data varies depending on the settings for image quality.

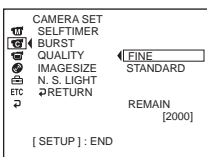

- 5 Select the desired image quality with $\blacktriangle/\blacktriangledown$, then press ENTER.

- 6 Press SETUP

The SETUP display disappears from the LCD display.

Image quality settings

Setting	Meaning
FINE (FINE)	Use this mode when you want to record high quality images. Fine images are compressed to about 1/4.
STANDARD (STD)	This is the standard image quality level for your camcorder. Standard images are compressed to about 1/10.

Shooting movies/still images

To select the still image size (DCR-DVD200/DVD300 only)

You can select either of 2 image sizes, 1152 × 864 or 640 × 480. The default setting is 1152 × 864.

1 Set the mode dial to  (Still).

2 Press SETUP.

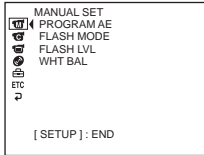

3 Select  (CAMERA SET) with $\blacktriangle/\blacktriangledown$, then press ENTER.

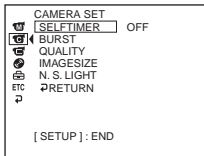

4 Select [IMAGESIZE] with $\blacktriangle/\blacktriangledown$, then press ENTER.

The amount of recording data varies depending on the settings for image size.

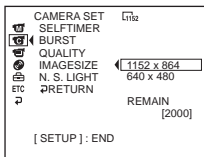

5 Select the desired image size with $\blacktriangle/\blacktriangledown$, then press ENTER.

The indicator changes as follows:

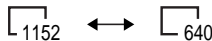

6 Press SETUP

The SETUP display disappears from the LCD display.

File size of still images

Image quality	File size	
	640 × 480 image size	1152 × 864 image size*
FINE	150 KB	500 KB
STANDARD	60 KB	200 KB

The table shows approximate file size.

* DCR-DVD200/DVD300 only.

Tip

The image size is 640 × 480 for DCR-DVD100.

Shooting movies/still images

To shoot images continuously (BURST, DCR-DVD200/DVD300 only)

You can record still images continuously by setting [BURST] beforehand.

It takes about 10 seconds to record the continuous images on the disc. You cannot shoot still images while the camera is recording.

NORMAL [a]

Your camcorder shoots up to 4 still images in 1152 × 864 size or 12 still images in 640 × 480 size at about 0.6 sec intervals. ()

[a]

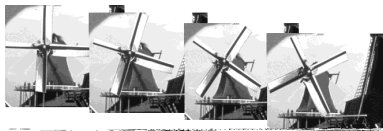

EXP BRKTG (Exposure bracketing) [b]

Your camcorder automatically shoots 3 images at about 0.6 sec intervals at different exposures. ()

[b]



1 Set the mode dial to  (Still).

2 Press SETUP.

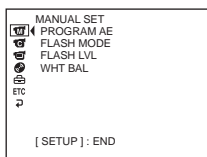

3 Select  (CAMERA SET) with ▲/▼, then press ENTER.

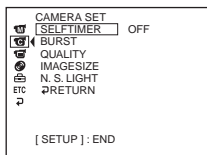

4 Select [BURST] with ▲/▼, then press ENTER.

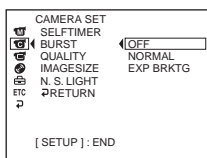

Shooting movies/still images

- 5 Select [NORMAL] or [EXP BRKTG] with ▲/▼, then press ENTER.

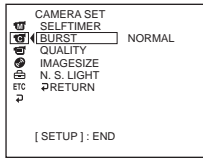

- 6 Press SETUP.

The SETUP display disappears from the LCD display.

- 7 Press PHOTO all the way down.

Images are recorded continuously as the settings specified above.

In the [NORMAL] settings, images are recorded continuously to the maximum number while pressing PHOTO.

Notes

- The number of continuous images you can shoot may vary depending on the image size and the remaining of the disc.
- The flash unit (optional) is disabled during continuous shooting.

Tips

- Shooting with the self-timer or the Remote Commander, images are automatically recorded up to the maximum number possible.
- The effect of exposure bracketing may be difficult to recognize on the LCD display. It is recommended that you connect your camcorder to a TV or a computer to see its effect.

Number of still images recordable in a disc

Your camcorder compresses image data in JPEG format (extension .jpg).

Default image data file name is as following:

- 100-0001: This file name appears on the LCD display of your camcorder.
- DSC00001.jpg: This file name appears on the display of your personal computer.

Number may vary depending on the settings of the image quality, the image size and the type of images you are shooting.

Image quality	Image size	Recordable number**		
		DVD-RW		DVD-R
		VIDEO mode	VR mode	
FINE	1152 × 864*	2 250	2 250	2 150
	640 × 480	5 400	5 400	5 100
STANDARD	1152 × 864*	4 300	4 300	4 100
	640 × 480	8 600	8 600	8 100

* DCR-DVD200/DVD300 only.

** The table shows approximate recordable number and the above numbers apply to a single-sided disc, and it will be doubled for a double-sided disc.

Note

On image data compatibility



Image data files recorded by your camcorder conform with the Design Rule for Camera File Systems standard established by the JEITA (Japan Electronics and Information Technology Industries Association).

Shooting techniques to match your circumstances

Shooting backlit subjects – BACK LIGHT

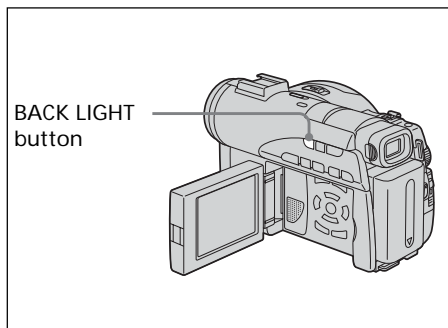
When you shoot a subject with the light source behind the subject or a subject with a light background, use the backlight.



- 1 Set the mode dial to  (Movie) or  (Still).
- 2 Press BACK LIGHT.
The  indicator appears on the LCD display.

To cancel BACK LIGHT

Press BACK LIGHT again.

Note



If you press EXPOSURE (page 48) when shooting with BACK LIGHT, the backlight will be canceled.

Shooting in the dark – NightShot/Super NightShot/ Color Slow Shutter

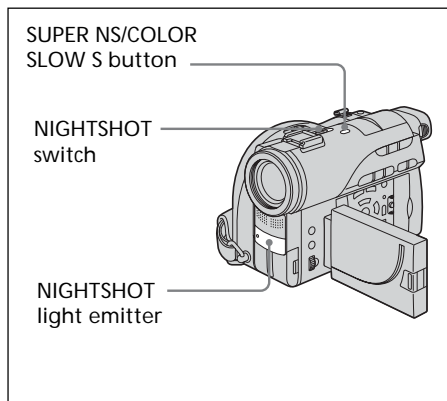
NightShot enables you to shoot a subject in the night or in a dark place. When using Night Shot, the picture may be recorded in incorrect or unnatural colors.



To use NightShot

- 1 Set the mode dial to  (Movie) or  (Still).
- 2 Slide the NIGHTSHOT switch to ON.
The  and "NIGHTSHOT" indicators flash on the LCD display.

To cancel the NightShot mode

Slide the NIGHTSHOT switch to OFF.



Notes

- Do not use the NightShot mode in bright places (e.g. outdoors in the daytime). This may cause your camcorder to malfunction.
- If focusing is difficult with the autofocus mode when using the NightShot mode, focus manually.
- While recording using the NightShot Light, do not obstruct the Infrared rays (NightShot Light) emitter with your finger.
- While using NightShot, you cannot use the following functions:
 - Exposure
 - PROGRAM AE (The indicator flashes)
 - White balance

Shooting techniques to match your circumstances

To use Super NightShot

The Super NightShot makes subjects more than 16 times brighter than those recorded in the NightShot.

- 1 Set the mode dial to  (Movie).
- 2 Slide the NIGHTSHOT switch to ON.
- 3 Press SUPER NS.
The S  and "SUPER NIGHTSHOT" indicators flash on the LCD display.

To cancel Super NightShot

Press SUPER NS again to make the S indicator disappear. To cancel NightShot, slide NIGHTSHOT to OFF.

Notes

- You cannot use Super NightShot to record still images.
- While using Super NightShot, the shutter speed is automatically adjusted depending on the brightness. At this time, the motion of the picture may slow down.
- While using Super NightShot, you cannot use the following functions:
 - Fader
 - Exposure
 - Digital effect
 - PROGRAM AE
 - White balance

To use the NightShot Light

The picture will be clearer with the NightShot Light on.

NightShot Light rays are infrared and so are invisible. The maximum shooting distance using the NightShot Light is about 3 m (10 feet).



To enable the NightShot Light, set  (CAMERA SET) – [N.S.LIGHT] to ON in the SETUP display.

The default setting is ON.

To use Color Slow Shutter

Color Slow Shutter enables you to record color images in a dark place.

Color Slow Shutter may not work normally in total darkness.

- 1 Set the mode dial to  (Movie).
- 2 Slide the NIGHTSHOT switch to OFF.
- 3 Press COLOR SLOW S.
The  and "COLOR SLOW SHUTTER" indicators flash on the LCD display.

To cancel Color Slow Shutter

Press COLOR SLOW S again to make the  indicator disappear.

Notes

- You cannot use Color Slow Shutter to record still images.
- While using Color Slow Shutter, the shutter speed is automatically adjusted depending on the brightness. At this time, the motion of the picture may slow down.
- While using Color Slow Shutter, you cannot use the following functions:
 - Fader
 - Exposure
 - Digital effect
 - PROGRAM AE

Shooting techniques to match your circumstances

Shooting with the subject checking the image - Mirror mode

The picture on the LCD display is a mirror-image. However, the picture will be normal when recorded.

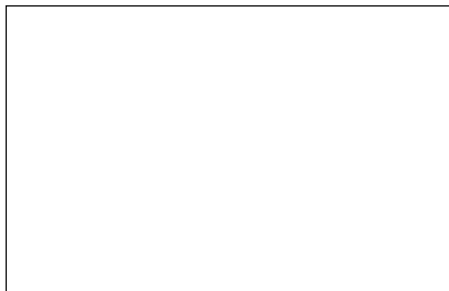

- 1 Set the mode dial to (Movie) or (Still).
- 2 Extend the viewfinder.
- 3 Open and rotate the LCD screen 180 degrees.

The indicator appears in the viewfinder and on the LCD display. When the mode dial is set to (Movie), appears in the standby mode, and appears in the recording mode. Some indicators appear mirror-reversed and others are not displayed.

Note

The viewfinder automatically turns off when using the LCD display, except in the mirror mode.

Self-timer recording

You can also use the Remote Commander for this operation.

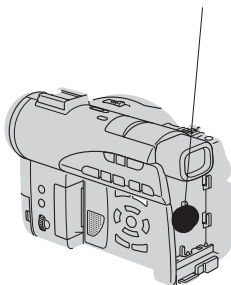

Shooting movies/still images

On shooting movies

- 1 Set the mode dial to (Movie).
- 2 Press SETUP.
- 3 Select (CAMERA SET) with /, then press ENTER.
- 4 Select [SELFTIMER] with /, then press ENTER.
- 5 Select [ON] with /, then press ENTER.
- 6 Press SETUP.
The SETUP display disappears from the LCD display and the (self-timer) indicator appears.
- 7 Press START/STOP.
Self-timer starts counting down with a beep. In the last 2 seconds of the countdown, the beep gets faster, then recording starts automatically 10 seconds after pressing START/STOP.

Tip

To stop the countdown, press START/STOP. To restart the countdown, press START/STOP again.

Shooting techniques to match your circumstances

On shooting still images

- 1 Set the mode dial to  (Still), then perform Steps 2 to 6 on the previous page .
- 2 Press PHOTO all the way down.
Self-timer starts counting down with a beep. In the last 2 seconds of the countdown, the beep gets faster, then recording starts automatically 10 seconds after pressing PHOTO.

Notes

- When the self-timer recording is finished, the self-timer is automatically cancelled.
- You can set self-timer during the standby only.
- You cannot stop the count-down on shooting still images by pressing PHOTO.



To cancel self-timer

Set  (CAMERA SET) – [SELFTIMER] to [OFF] in the SETUP display during the standby.

Adjusting the white balance manually

Normally white balance is adjusted automatically. Adjust manually in the following cases:

- When shooting at the place that the light condition changes such as a party hall.
- When shooting a night scene and a neon sign.

- 1 Set the mode dial to  (Movie) or  (Still).
- 2 Press SETUP.
- 3 Select  (MANUAL SET) with $\blacktriangle/\blacktriangledown$, then press ENTER.

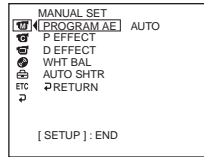

- 4 Select [WHT BAL] with $\blacktriangle/\blacktriangledown$, then press ENTER.

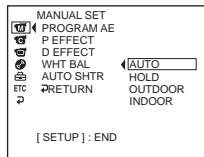

- 5 Select the desired white balance with $\blacktriangle/\blacktriangledown$, then press ENTER.

HOLD :

When recording a single-colored subject or background

(OUTDOOR) :

- When recording a sunset/sunrise, just after sunset, just before sunrise
- When recording a neon signs, or fireworks
- Under a color-matching fluorescent lamp

(INDOOR) :

- Where lighting condition changes quickly
- When recording in TV lighting in a studio
- Under sodium lamps or mercury lamps

- 6 Press SETUP.

The SETUP display disappears from the LCD display.

Shooting techniques to match your circumstances

To return to the automatic white balance mode

Set **[M]** (MANUAL SET) - [WHT BAL] to [AUTO] in the SETUP display.

Note

In the [HOLD] white balance mode, set the white balance to [AUTO] and reset it to [HOLD] after a few seconds:

- when you change the [PROGRAM AE] setting.
- when you take your camcorder outdoors from inside a house, or vice versa.

Tips

- If the picture is being taken in a studio lit by TV lighting, it is recommended that you record in the [INDOOR] mode.
- When you record under fluorescent lighting, use the [AUTO] or [HOLD] mode.
Your camcorder may not adjust the white balance correctly in the [INDOOR] mode.
- In the automatic white balance mode, point your camcorder at a white subject for about 10 seconds after turning the power on to get a better adjustment:
 - after you replace the battery pack.
 - when you take your camcorder outdoors from inside a house while holding the exposure, or vice versa.
- When you slide the NIGHTSHOT switch to ON, white balance returns to [AUTO].

Shooting for the wide-screen TV - Wide mode

You can record a 16:9 wide picture to watch on a 16:9 wide-screen TV (16:9WIDE).

Black bands appear on the LCD display during recording in 16:9WIDE mode [a]. The picture during playback on a normal TV [b]* or on a wide-screen TV [c] is compressed in the longwise direction. If you set the screen mode of the wide-screen TV to the full mode, you can watch pictures of normal images [d]. If you connect a TV compatible with the ID-1/ID-2 system, the screen size is selected automatically.

Refer also to the operating instructions of your TV.

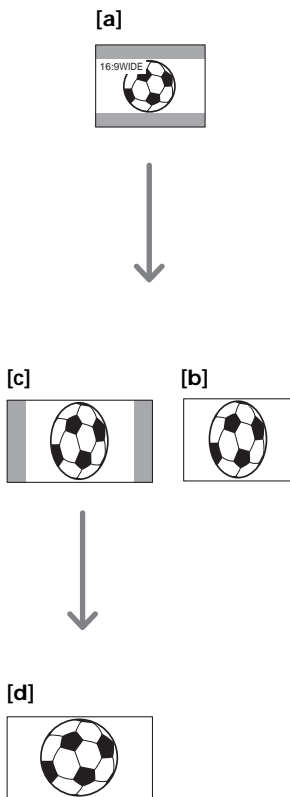



* The picture played back in the wide mode on a normal TV appears the same as the picture played back in the wide mode on your camcorder [a].

Shooting techniques to match your circumstances

1 Set the mode dial to  (Movie).

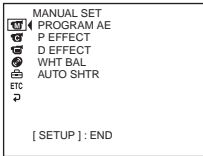
2 Press SETUP.



3 Select  (CAMERA SET) with ▲/▼, then press ENTER.

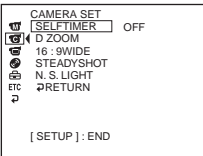

4 Select [16:9WIDE] with ▲/▼, then press ENTER.

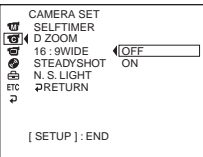

5 Select [ON] with ▲/▼, then press ENTER.

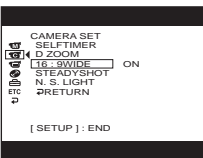

6 Press SETUP.

The SETUP display disappear from the LCD display.

To cancel the wide mode

Set [16:9WIDE] to [OFF] in step 5.

Notes

- You cannot select [OLD MOVIE] during recording in the wide mode.
- You cannot change a movie recorded in the 16:9WIDE mode to the normal aspect.

Tips

- Pictures recorded in the 16:9WIDE mode automatically appear on the TV screen at full size when:
 - you connect your camcorder to a TV that is compatible with the video ID (ID-1/ID-2) system.
 - you connect your camcorder to the S video jack on the TV.
- The ID-1 system sends aspect ratio (screen horizontal/vertical ratio) information (16:9, 4:3, or letter box) along with the video signals.
- The ID-2 system sends a copyright protection signal with ID-1 signals inserted between video signals when you connect your camcorder to other equipment using the A/V connecting cable.

Shooting techniques to match your circumstances

Optimizing the camera automatically – PROGRAM AE

SPOTLIGHT*

This effect prevents people's faces, for example, from appearing excessively white when shooting subjects lit by strong light.

PORTRAIT (soft portrait)

This effect brings out the subject while creating a soft background for subjects such as people or flowers.

SPORTS (sports lesson)*

This effect minimizes camera-shake on fast-moving subjects such as in tennis or golf.

BEACH&SKI*

This effect prevents people's faces from appearing dark in strong light or reflected light, such as at a beach in midsummer or on a ski slope.

SUNSETMOON (sunset & moon)**

This effect allows you to maintain atmosphere when you are recording sunsets, general night views, fireworks displays and neon signs.



LANDSCAPE**

This effect is for when you are recording distant subjects such as mountains, and prevents your camcorder from focusing on glass or metal mesh in windows when you are recording a subject behind glass or a screen.





* Your camcorder focuses only on subjects in the middle to far distance.

** Your camcorder focuses only on distant subject.

1 Set the mode dial to  (Movie) or  (Still).

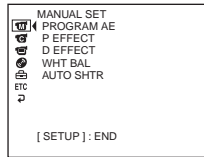
2 Press SETUP.



3 Select  (MANUAL SET) with ▲/▼, then press ENTER.

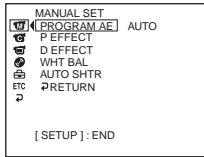

4 Select [PROGRAM AE] with ▲/▼, then press ENTER.

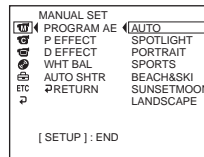

5 Select the desired effect with ▲/▼, then press ENTER.

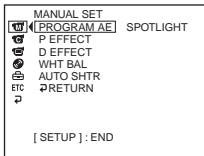

6 Press SETUP.

The SETUP display disappears from the LCD display.

To cancel PROGRAM AE

Set [PROGRAM AE] to [AUTO] in step 5.

Notes

- The following functions do not work with PROGRAM AE:
 - Color Slow Shutter
 - OLD MOVIE
- When NIGHTSHOT is set to ON, PROGRAM AE does not work. (The indicator flashes.)
- You cannot use SPORTS to record still images. (The indicator flashes.)



Shooting techniques to match your circumstances

Adjusting the exposure manually

Adjust the exposure manually in the following cases:

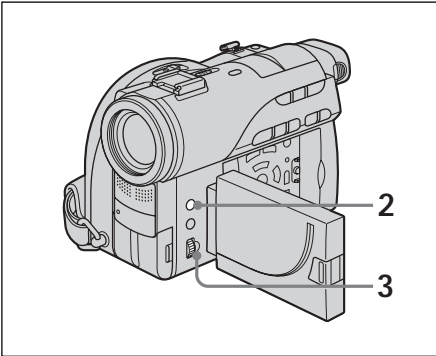
- when you need a fine adjustment for subjects against the light.
- when the subject is too bright against the background.
- when recording dark pictures (e.g. night scenes).



1 Set the mode dial to  (Movie) or  (Still).

2 Press EXPOSURE.

The exposure indicator appears.

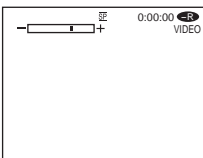

3 Turn the dial to adjust the brightness.

- + : brighter
- : darker

To return to the automatic exposure

Press EXPOSURE again.

Notes

- When you adjust the exposure manually, the following functions do not work:
 - Color Slow Shutter
 - BACK LIGHT
- Your camcorder automatically returns to the automatic exposure setting:
 - if you change the PROGRAM AE effect.
 - if you slide the NIGHTSHOT switch to ON, while adjusting the exposure manually.



Shooting techniques to match your circumstances

Focusing manually

Normally, focus is adjusted automatically. However, you can gain better results by manually adjusting the focus in the following cases:

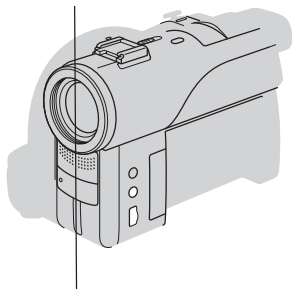
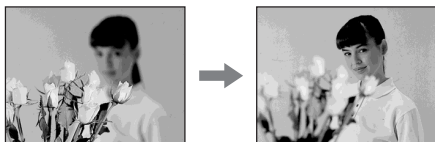
- The autofocus is not effective when shooting
 - Subjects through glass coated with water droplets
 - Horizontal stripes
 - Subjects with little contrast with backgrounds such as walls or sky
- Shooting a stationary subject when using a tripod
- When you want to change the focus from a subject in the foreground to a subject in the background



- 1 Set the mode dial to  (Movie) or  (Still).
- 2 Press FOCUS.
The  (manual focus) indicator appears.
- 3 Viewing the viewfinder or the LCD display, turn the dial to adjust the focus.

To return to the autofocus



Press FOCUS again.

To record distant subjects

Turn the dial to FAR until the  indicator appears.

The focus is fixed at the most distant position.

Tips

- It is easier to focus on subjects if you adjust the zoom to shoot at the “W” (wide-angle) position after adjusting the focus at the “T” (telephoto) position.
- When you shoot close to the subject, focus at the end of the “W” (wide-angle) position.
-  changes as follows:
 -  when recording a distant subject.
 -  when the subject is too close to focus on.

Shooting with special effects

Using fader (for movies only)

You can fade in or out to give your movie a more professional appearance.

FADER

OVERLAP*

WIPE*

* Fade in only

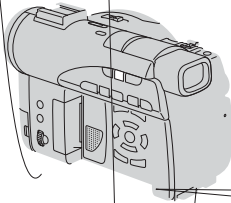

1 Set the mode dial to  (Movie).

2 When fading in

In the standby mode, press the FADER button until the desired fader indicator flashes.

When fading out

In the recording mode, press FADER until the desired fader indicator flashes.

The indicator changes as follows:

FADER → OVERLAP → WIPE
no indicator (off)

The last selected fader mode is indicated first.

3 Press START/STOP.

The fader indicator stops flashing, then remains lit.

After fade in/out ends, the fader indicator disappears.

To cancel fader

Before pressing START/STOP in step 3, press FADER until the indicator disappears.

Notes

- You cannot use the following functions while using fader. Also you cannot use fader while using following function.
 - Digital effect
 - Super NightShot
 - Color Slow Shutter
- When the OVERLAP or WIPE indicator appears in the standby mode, your camcorder automatically stores the image recorded on a disc. While the image is being stored, the indicators flash fast, and the playback picture disappears temporarily.

Shooting with special effects

Using special effects – Picture effect/Digital effect

You can digitally process movies to obtain special effects like those in films or on TV.

Picture effect

- SEPIA:** The picture appears in sepia.
- B&W:** The picture appears in monochrome (black-and-white).
- PASTEL:** The picture appears like a pale pastel drawing.
- MOSAIC:** The picture appears mosaic-patterned.

PASTEL



MOSAIC



Digital effect

LUMI. (Luminance key):
You can swap a brighter area in a still image with a moving picture.

OLD MOVIE:
You can add an old movie-type atmosphere to pictures. Your camcorder automatically sets the wide mode to ON and picture effect to SEPIA, and sets the appropriate shutter speed.

Still image

LUMI.



- 1 Set the mode dial to  (Movie).
- 2 Press SETUP.

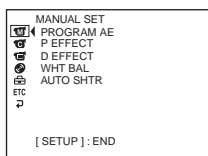

- 3 Select  (MANUAL SET) with ▲/▼, then press ENTER.

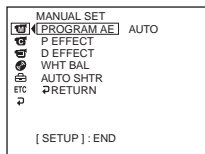

- 4 Select [P EFFECT] or [D EFFECT] with ▲/▼, then press ENTER.

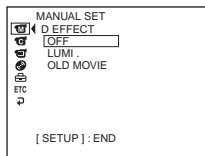

- 5 Select the desired picture effect mode with ▲/▼, then press ENTER.
In the [LUMI.] mode, the still image displayed when ENTER is pressed is recorded in the memory. Adjust the degree of the still image swapped by a movie with ◀ (reduce the degree)/▶ (increase the degree).

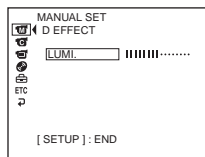

Bars: Displayed in LUMI. only.

- 6 Press SETUP.
The SETUP display disappears from the LCD display.

To cancel effect

Set [P EFFECT] or [D EFFECT] to [OFF] in step 5.

Shooting with special effects

Notes



- The following functions do not work during digital effect:
 - Fader
 - Super NightShot
 - Color Slow Shutter
- While using picture effect, you cannot select OLD MOVIE.
- The following functions do not work in OLD MOVIE:
 - Wide mode
 - Picture effect
 - PROGRAM AE

Other functions

Checking the last scene – Review

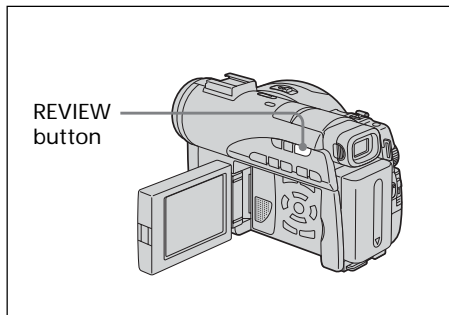
You can check the last recorded scene quickly.



- 1 Set the mode dial to  (Movie) or  (Still).
- 2 Press REVIEW.
The playback of the latest scene starts.



To return to recording

Press REVIEW again.

Note

The recording data does not appear on the Review display.

Tip

When reviewing still images recorded continuously (BURST, DCR-DVD200/DVD300 only), you can forward/backward the images with  .

Deleting the last scene (DVD-RWs only)

If the checked scene is unnecessary, you can delete it on the spot.

Note

You can delete the last scene only when it has been recorded on DVD-RWs. Any data once recorded on DVD-Rs cannot be deleted.

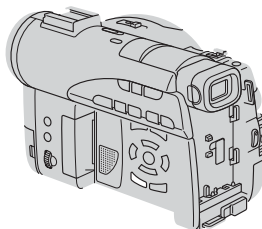

- 1 Press EDIT during the review.
A deletion confirmation display appears.
- 2 Select [EXEC.] with , then press ENTER.
The latest scene is deleted.

To cancel the deletion

Select [RET.] in step 2.

Notes

- When you delete the still images recorded continuously (BURST, DCR-DVD200/DVD300 only), all the images are deleted once. To delete the specific image recorded continuously, see “Deleting movies/still images” (VR mode only, page 87).
- You cannot delete the last scene:
 - when you move the mode dial.
 - when you turn the power off.
 - when you eject the disc.

Other functions

Changing the disc title

You can make a title on each disc. As the default, the date the disc was first used is added as a disc title.

1 Press SETUP.

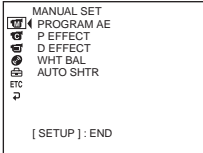

2 Select [DISC SET] with ▲/▼, then press ENTER.

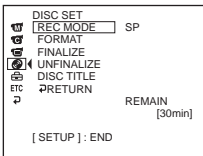

3 Select [DISC TITLE] with ▲/▼, then press ENTER.

The DISC TITLE display appears.

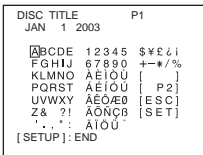

4 Delete unnecessary characters by selecting [←] with ◀/▲/▼/▶, then press ENTER.

Characters are deleted from the end.

5 Select the desired character with ◀/▲/▼/▶, then press ENTER.

Repeat this step to enter a desired title. Up to 20 characters can be registered.

- 6 When you have finished entering all the characters, select [SET] with ◀/▲/▼/▶, then press ENTER.
The disc title is set and the display returns to the SETUP display.

7 Press SETUP.

The SETUP display disappears from the LCD display.

Note

When you change a disc title already set by other devices, the 21st and subsequent characters are deleted.

Tips

- You can add a space by selecting [] between [&] and [?].
- When you press SETUP in step 6, the disc title is set and the SETUP display disappears from the LCD display.

To cancel changing the disc title

In any step from 2 to 5, select [ESC] with ◀/▲/▼/▶, then press ENTER.

Playing a disc on your camcorder

Choosing and viewing a recording – Visual Index

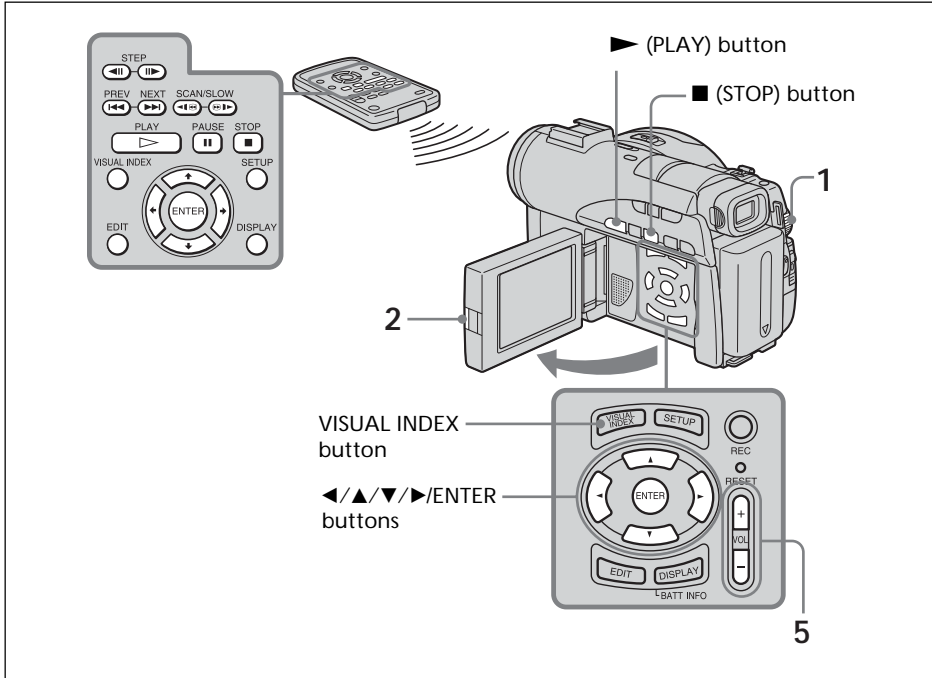

The recorded movies/still images are displayed as a list in the Visual Index display. You can find the desired scene quickly using this convenient index. If you close the LCD screen, you can monitor the playback picture in the viewfinder. You can control playback using the Remote Commander supplied with your camcorder.

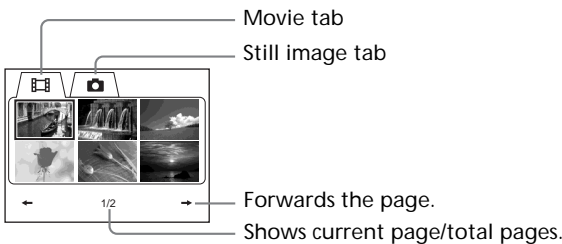

- 1 Set the mode dial to (Play/Edit).
- 2 Open the LCD screen while pressing OPEN. The Visual Index display appears.



Playing a disc on your camcorder

- 3** Select the  (Movie) tab or the  (Still) tab with $\blacktriangleleft/\blacktriangleright$ according to the kind of scene you want to play back.
A list of movies or still images appears.

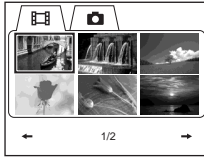

- 4** Select the desired movie or still image with $\blacktriangleleft/\blacktriangle/\blacktriangledown/\blacktriangleright$, then press \blacktriangleright .
When you select a movie, playback starts and continues until the last scene of the movie. When you select a still image, the image appears in full screen mode.

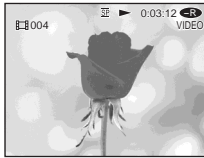

- 5** Adjust the volume when a movie is played back by pressing either +/- on VOL. The sound is muted when the LCD screen is closed.

Tip

When the Visual Index display does not appear in step 2, press VISUAL INDEX.

To return to the Visual Index display

Press VISUAL INDEX again.

To stop playback

Press \blacksquare .

Pressing \blacktriangleright starts playback from the point which \blacksquare was pressed.

Various playback modes

[Movies]

The sound is muted in the various playback modes.

To pause play back (view a still image)

Press **||** during playback. To resume normal playback, press **||** again.

To advance the scene

Press **▶▶** during playback.

To return to the beginning of the scene

Press **◀◀** during playback.

To play a previous scene

Press **◀◀** repeatedly during playback.

To locate a scene while monitoring the picture

Press and hold **◀◀** or **▶▶** during playback. To resume normal playback, release the button.

On the Remote Commander, press **◀◀** or **▶▶**.*

Pressing **◀◀** or **▶▶** repeatedly switches the playback speed from 5x and 15x.

To view the picture at slow speed (slow playback)

Press **◀▶**

Playing a disc on your camcorder

To display the indicators during playback – Display

Press DISPLAY/BATT INFO on your camcorder, or press DISPLAY on your Remote Commander.

The indicators appear on the LCD display.

To make the indicators disappear, press DISPLAY/BATT INFO or DISPLAY again.

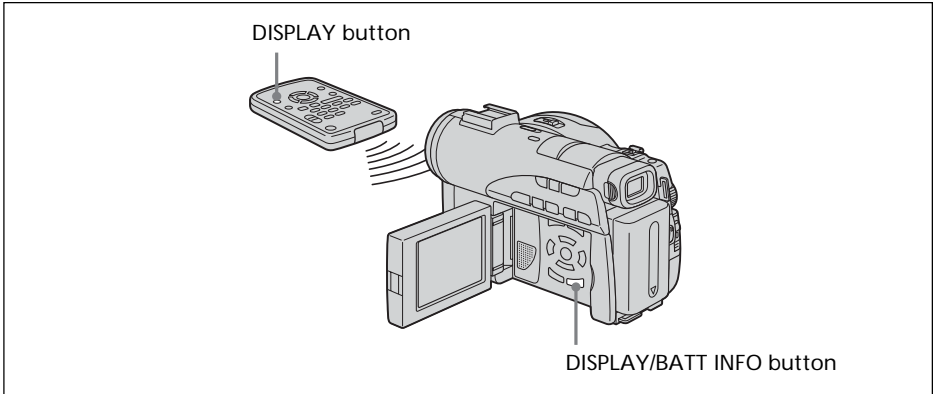

To display date/time and various settings

Your camcorder automatically records not only images on the disc but also the recording data (date/time or various settings when recorded) (**Data code**).

To display both the date/time and the data code, set **ETC** (OTHERS) – [DATA CODE] to [DATE/CAM] in the SETUP display.

To change date/time and various settings

Press DATA CODE on the Remote Commander during playback.

The display changes as follows:

date/time → various settings (SteadyShot, white balance, gain, shutter speed, aperture value, exposure mode) → no indicator

Date/time

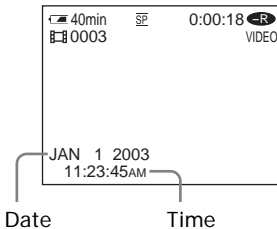

Playing a disc on your camcorder

Various settings (movie)

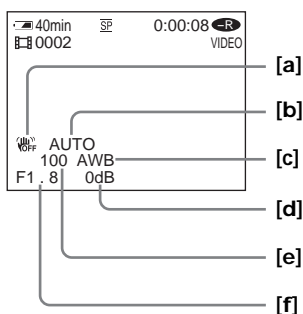

- [a] SteadyShot OFF
- [b] Exposure mode
- [c] White balance
- [d] Gain
- [e] Shutter speed
- [f] Aperture value

Various settings (still image)

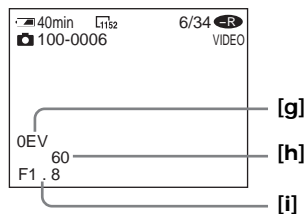

- [g] Exposure value
- [h] Shutter speed
- [i] Aperture value

Tips

- During recording, various settings are not displayed.
- When you use data code, bars (--- ---) appear if:
 - the disc is unreadable due to damage or noise.
 - the disc was recorded through the AUDIO/VIDEO jack.
- The data code is displayed on the TV screen if you connect your camcorder to a TV.

Playing a disc on your camcorder

Magnifying recorded images – PB ZOOM

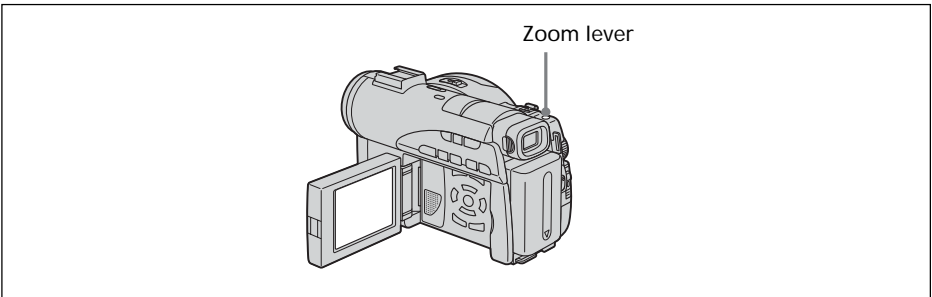

- 1** In the playback, playback pause or review, move the power zoom lever.
You can choose the magnification from approx. 1.1x to 5x.
W: Decreases the zoom ratio.
T : Increases the zoom ratio.
- 2** Move the enlarged image in the desired direction with ◀/▲/▼/▶.

To cancel PB ZOOM

Press ENTER.

You can also cancel PB ZOOM by moving the power zoom lever toward W as far as it will go.

Notes

- You cannot process externally input scenes using PB ZOOM of your camcorder.
- You cannot move a magnified circumferential image to the center of the display.

Tips

- You cannot record images on a disc in your camcorder when you have processed the image using the disc PB ZOOM. However, you can record images on a VCR using your camcorder as a player.
- You can operate PB ZOOM in fast forward, fast backward, slow playback and frame-by-frame playback.
- PB ZOOM is canceled when you change the scene with ◀◀ / ▶▶.



Playing a disc on your camcorder

Playing still images automatically – Slide Show

You can see the automatic playback of all the still images recorded on the disc.

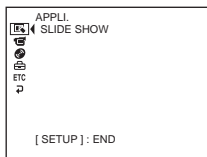
- 1 Set the mode dial to  (Play/Edit).
Press VISUAL INDEX when Visual Index does not appear on the LCD display.
- 2 Press SETUP.



- 3 Select  (APPLI.) with , then press ENTER.

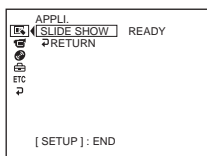



- 4 Select [SLIDE SHOW], then press ENTER.



- 5 Press ENTER.
Still images play back in sequence. Playback stops when all the images are played back.

To start a slide show from a particular image

Select the desired image with   after step 4.

The slide show starts from the selected image and stops after all the images have been shown.

To cancel a slide show

Press SETUP.

To pause a slide show

Press ENTER. Press ENTER again to restart the slide show.

Viewing recordings on TV

Connect your camcorder to your TV with the A/V connecting cable supplied with your camcorder to watch playback pictures on the TV screen. You can operate the video control buttons in the same way as when you monitor playback pictures on the LCD display. When monitoring playback pictures on the TV screen, it is recommended that you power your camcorder from a wall outlet using the AC adaptor (page 18). Refer to the operating instructions of your TV.

Open the jack cover. Connect your camcorder to the TV using the A/V connecting cable supplied with your camcorder. Then, set the TV/VCR selector on the TV to VCR.

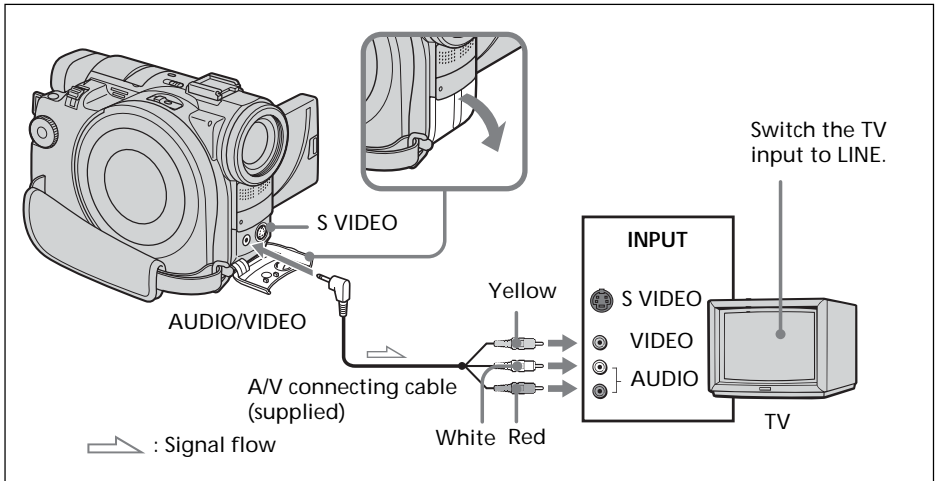

If your TV is already connected to a VCR

Connect your camcorder to the LINE IN input on the VCR using the A/V connecting cable supplied with your camcorder. Set the input selector on the VCR to LINE.

If your TV or VCR is a monaural type

Connect the yellow plug of the A/V connecting cable to the video input jack and the white or the red plug to the audio input jack on the VCR or the TV. If you connect the white plug, the sound comes from the L (left) signal. If you connect the red plug, the sound comes from the R (right) signal.

Tips

- Pictures can be reproduced more faithfully by using an S video cable (optional). With this connection, you do not need to connect the yellow (video) plug of the A/V connecting cable. Connect the S video cable (optional) to the S video jacks on both your camcorder and the TV or the VCR.
- The sound is not output on the other equipment if your camcorder is connected with an S video cable (optional) only. Use the A/V connecting cable along with an S video cable.
- To display the indicators on the TV, set [DISPLAY] to [V-OUT/LCD] in **ETC** (OTHERS) in the SETUP display (page 114). Then press DISPLAY/BATT INFO on your camcorder. To turn off the indicators, press DISPLAY/BATT INFO on your camcorder again.

Finalizing a disc

You have to finalize the disc before you can play a recorded disc on other players such as DVD players. Finalizing makes the recorded disc DVD-Video compatible, and you can play the disc on DVD-Video compatible players.

Some players cannot play discs recorded in the VR mode. Make sure of playback compatibility with your players in advance of recording. For details, see the operating instructions supplied with your player.

Note that you cannot record again on finalized DVD-Rs.

You can record again on DVD-RWs.

– In VIDEO mode: the disc is recordable if unfinalized.

– In VR mode: the disc is recordable after finalizing.

Before finalizing the disc

Place your camcorder in a stable position. It takes about a minute to a few hours for finalizing. The shorter the amount of material recorded, the longer it takes for finalizing.

The procedure differs between DVD-Rs and DVD-RWs.

Notes

- Power your camcorder from a wall outlet using the AC adaptor.
- If you disconnect the AC adaptor during finalizing, the disc may be damaged.
- Do not vibrate your camcorder during finalizing.
- Playback may pause between the scenes in some players.

- 1 Connect the AC adaptor to the DC IN jack on your camcorder, then connect the power cord to the wall outlet.
- 2 Turn the power on by sliding the POWER switch upward pressing the green button.
- 3 Press SETUP.

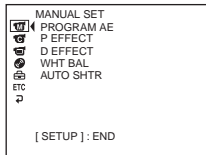

- 4 Select  (DISC SET) with ▲/▼, then press ENTER.

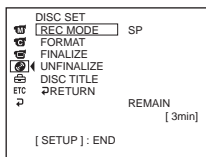

Finalizing a disc

- 5 Select [FINALIZE] with ▲/▼, then press ENTER.

The disc title is set as the date and time the disc was first used. See “Changing the disc title” on page 54 if you want to change the disc title.

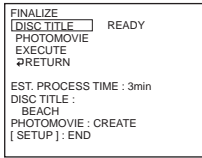

- 6 When still images are included on a disc recorded in VIDEO mode, select [PHOTOMOVIE], [CREATE] with ▲/▼, then press ENTER. Proceed to step 7 in VR mode.

To play back still images on players such as DVD players, still images must be converted to a movie. Converted still images are played back in sequence. The original still images remain as JPEG files.

When still images are recorded in VR mode, perform the operation in “Saving all the still images on a disc to a movie file” (page 77).

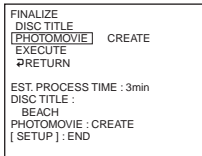

- 7 Select [EXECUTE] with ▲/▼, then press ENTER.

The confirmation display appears.

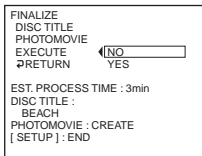

- 8 Select [YES] with ▲/▼, then press ENTER.

Finalizing starts. In VIDEO mode, the menu display for the playback on DVD players appears shortly.

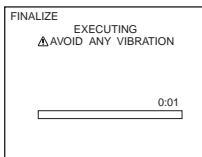

- 9 Press SETUP when the finalizing completion message appears.

The finalizing completion display disappears from the LCD display.

Playing back a finalized disc on other players

Note the following when using a disc on other players.

- Make sure that the vertical-shaped DVD player/computer with a DVD drive are placed in a horizontal position when playing back 8 cm DVDs.
- Do not use the 8 cm CD adaptor with an 8 cm DVD as it may cause malfunctions.

Playing back a disc on DVD players

To play back a disc recorded in VIDEO mode

You can play back a finalized disc recorded in VIDEO mode on players that can play back DVD-Rs or DVD-RWs.

When the disc is finalized, a menu display is provided similar to the Visual Index display. In menu display, six scenes are listed per page (200 pages in maximum).

Select the scene to be played back in menu display on the DVD player.

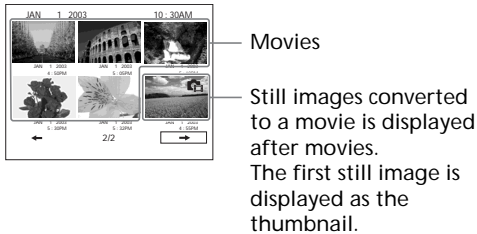
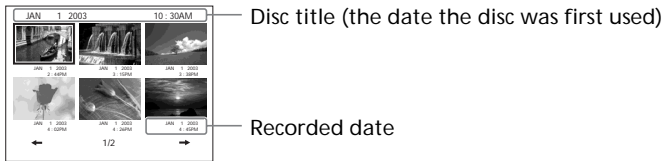

To play back still images

Still images are played back as a photo movie swapping images in every three seconds. Pressing ◀◀/▶▶ during playback skips 10 images.

Notes

- The disc may not be played back on some players.
- Some functions, such as playback of still images, may be disabled on some players.
- To play back still images on other players, still images must be converted to photo movie (page 63).
- Still images converted to a photo movie may not be played back clearly, as the resolution (pixels) of converted photo movie is lower than that of original still images.

Tip

For details on how to use a DVD player, see operating instructions of the DVD player.

Playing back a finalized disc on other players

To play back a disc recorded in VR mode

You can play back a finalized disc recorded in VR mode on players that can play back DVD-RWs in VR mode.

The operation is different depending on your player. See operating instructions of your player.

To play back still images

The operation is different depending on your player. See operating instructions of your player.

Notes

- To play back still images on other players, still images must be converted into photo movie (page 77).
- Still images converted to a photo movie may not be played back clearly, as the resolution (pixels) of converted photo movie is lower than that of original still images.

Playing back a finalized disc on other players

Playing back movies on a computer with a DVD drive installed

The display and the operation may vary depending on the operating system of your computer.

- 1 Turn on your computer.
- 2 Insert the finalized disc to the DVD drive of your computer.
A DVD playback application starts and the movie is played back.
When the DVD playback application does not start automatically, start the application from the [Start] menu of your computer.

Notes

- Use the DVD drive compatible with 8 cm discs.
- A DVD playback application must have been installed on your computer.
- When playing back movies from the disc, the movie and sound may pause. In this case, copy the data to the hard disk drive of your computer.
- The disc may not be played back on some computers. For details, see operating instructions of your computer.

Tip

You can play back the disc on a computer without a DVD drive, by connecting your camcorder to your computer (page 89).

Showing still images on a computer with a DVD drive installed

The display and the operation may vary depending on the operating system of your computer. Following screens are example of Microsoft Windows XP Professional.

- 1 Turn on your computer.
- 2 Insert the finalized disc to the DVD drive of your computer.
When a DVD playback application starts, close the application.
- 3 Click [Start] → [My Computer].
Or, double-click the [My Computer] icon on the desktop.
My Computer screen appears.

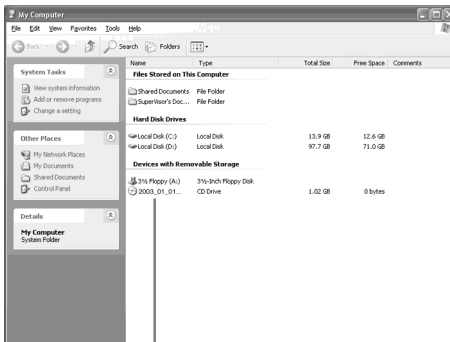

The date the disc was first used is recorded on the volume label of the disc.
When the disc was first used at 6:00 pm on January 1st 2003:
2003_01_01_06H00M_PM

Playing back a finalized disc on other players

- 4 Right-click the DVD drive with the disc inserted, then click [Open].
Folders in the disc appear.
- 5 Click [DCIM] → [100MSDCF].
The list of still images recorded on the disc appears.
- 6 Double-click the file to be shown.
The selected still image appears on the screen.

Notes

- Use the DVD drive compatible with 8 cm discs.
- The disc may not be played back on some computers. For details, see operating instructions of your computer.

Tip

You can play back the disc on a computer without DVD drive, by connecting your camcorder to your computer (page 89).

Structures and file names of movies and still images

Movies and still images are stored in the following folders on the disc.

Movies: VIDEO_TS folder (on VIDEO mode)

DVD_RTAV folder (on VR mode)

Still images: DCIM\100MSDCF folder

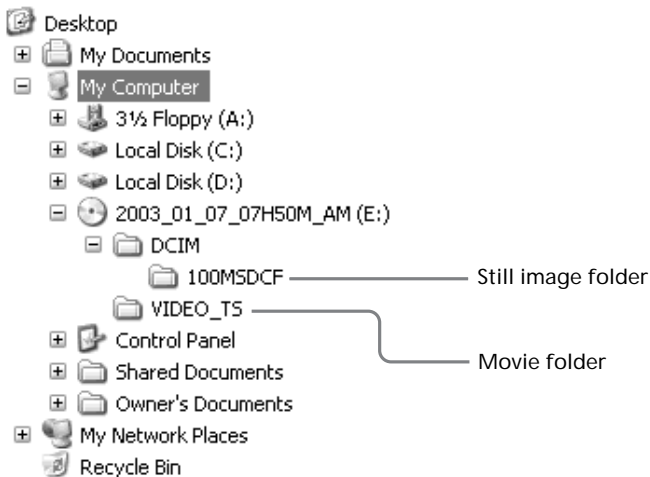

Recording on a finalized disc – Unfinalizing (VIDEO mode DVD-RWs only)

You can record on finalized DVD-RWs by unfinalizing them. This operation is valid in VIDEO mode only. You do not have to unfinalize a VR mode disc.
Insert a finalized DVD-RW into your camcorder beforehand.

1 Press SETUP.

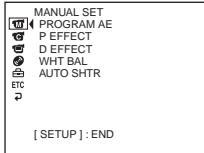

2 Select [DISC SET] with ▲/▼, then press ENTER.

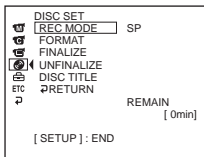

3 Select [UNFINALIZE] with ▲/▼, then press ENTER.

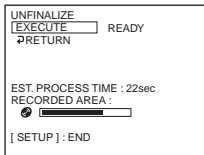

4 Select [EXECUTE] with ▲/▼, then press ENTER. The confirmation display appears.

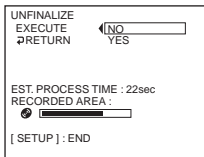

5 Select [YES] with ▲/▼, then press ENTER. Unfinalizing starts.

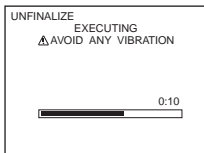

Recording on a finalized disc – Unfinalizing (VIDEO mode DVD-RWs only)

- 6** Press SETUP when the unfinalizing completion message appears.
The message disappears from the LCD display and you can record on the disc again.

To cancel unfinalizing

Press SETUP in any step from 2 to 4.

Notes

- Power your camcorder from a wall outlet using the AC adaptor.
- If you disconnect the AC adaptor during unfinalizing, the disc may be damaged.
- Do not vibrate your camcorder during unfinalizing.
- You can unfinalize DVD-RWs only. You cannot make any modification to DVD-Rs once the disc is finalized.

Tip

It takes about 20 seconds for unfinalizing.

Recording again on a used disc – Formatting (DVD-RWs only)

You can format recorded DVD-RWs and make them new discs. Note that formatting erases all the data recorded on the disc.

Insert a recorded DVD-RW into your camcorder beforehand.

- 1 Press **SETUP**.

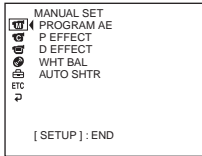

- 2 Select **(DISC SET)** with **▲/▼**, then press **ENTER**.

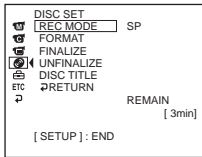

- 3 Select **[FORMAT]** with **▲/▼**, then press **ENTER**.

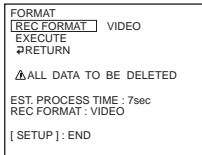

- 4 Select **[REC FORMAT]** with **▲/▼**, then press **ENTER**.

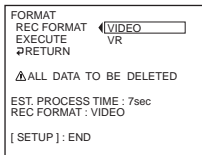

- 5 Select the disc format from **[VIDEO]** or **[VR]** with **▲/▼**, then press **ENTER**.

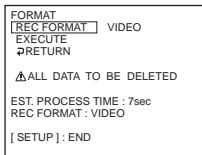

- 6 Select **[EXECUTE]** with **▲/▼**, then press **ENTER**.

The confirmation display appears.

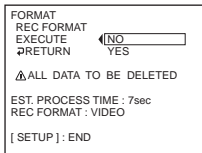

Recording again on a used disc – Formatting (DVD-RWs only)

- 7 Select [YES] with ▲/▼, then press ENTER.

Formatting starts.

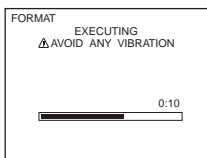

- 8 Press SETUP when the format completion message appears.
The message disappears from the LCD display. The disc is formatted and you can record on the disc again.

To cancel formatting

Press SETUP in any step from 2 to 6.

Notes

- Power your camcorder from a wall outlet using the AC adaptor.
 - If you disconnect the AC adaptor during formatting, the disc may be damaged.
 - Do not vibrate your camcorder during formatting.
 - You can format DVD-RWs only. You cannot delete any recorded data from DVD-Rs.
 - Formatting a finalized disc becomes as following. In both cases, the recorded data are all deleted.
 - In VIDEO mode: unfinalized
 - In VR mode: remains finalized
- A disc finalized in VR mode cannot be unfinalized by formatting, but still you can record/edit on the disc.

Tip

It takes about 10 seconds to format a DVD-RW in VIDEO mode, and about 40 seconds to format a DVD-RW in VR mode.

Selecting the playing order on your camcorder – Playlist

You can play movies and still images in the desired order by making the Playlist on your DVD-RWs recorded in VR mode. You can change the playing order without actual modification to the recorded data.

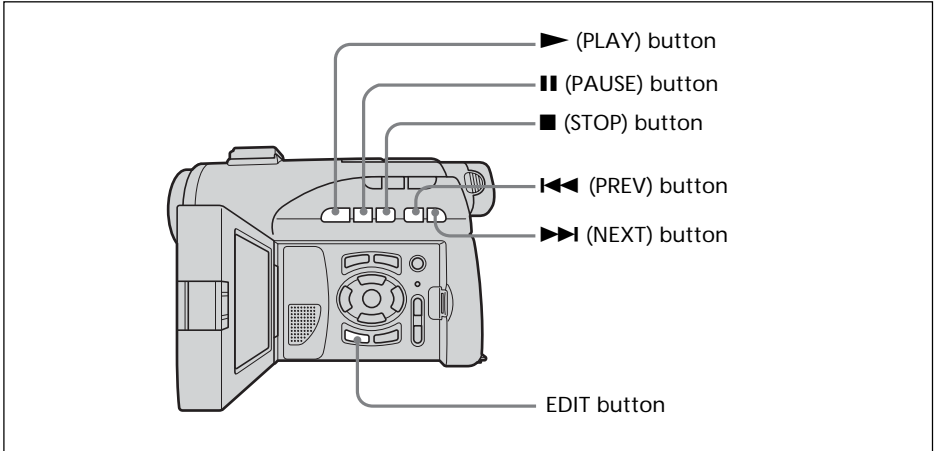



Registering movies or still images to the Playlist

Insert a recorded DVD-RW in VR mode into your camcorder beforehand.

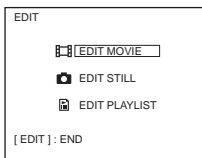
- 1 Set the mode dial to  (Play/Edit).
- 2 Press EDIT.
The display to select editing object appears.



- 3 Select [EDIT PLAYLIST] with /, then press ENTER.
The Playlist edit display appears.

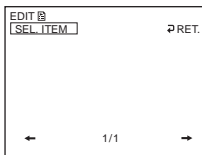

Selecting the playing order on your camcorder – Playlist

- 4 Select [SEL. ITEM] with ◀/▲/▼/▶, then press ENTER.

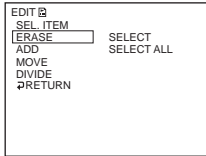

- 5 Select [ADD] with ▲/▼, then press ENTER.

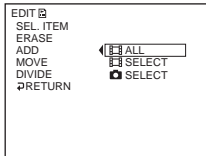

- 6 Select [SELECT] (movies) or [SELECT] (still images) with ▲/▼, then press ENTER.
A thumbnail list of movies or still images on the disc appears.

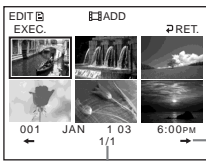

Forwards the page.

Shows current page/total pages.

- 7 Select the scene to be added to the Playlist with ◀/▲/▼/▶, then press ENTER.
The selected scene is marked with ✓.
Repeat this step to select multiple scenes.

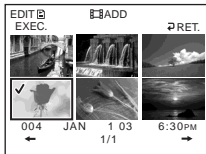

Pressing ▶ starts playback of the selected scene. Press ■ to return to the display to select other scenes.

- 8 Select [EXEC.] with ◀/▲/▼/▶, then press ENTER.
The confirmation display appears.



Selecting the playing order on your camcorder – Playlist

9 Select [EXEC.] with ◀/▶, then press ENTER.

The selected movies or still images are registered in the new Playlist. When a still image is added to a Playlist, it is converted and registered as a new movie file in the movie tab. It returns to the Playlist edit display when the registration is completed.

To register all movies at the same time

Select  ALL] in step 6.

To register all still images at the same time

See “Saving all the still images on a disc to a movie file” on page 77.

To cancel the registration

Press EDIT in any step from 3 to 8.

Note

The Playlist is usable in VR mode only. You cannot use it in VIDEO mode.

Tips

- You can register up to 999 scenes to the Playlist.
- You can register MPEG format movies only to the Playlist. Still images recorded in JPEG format are converted to MPEG format when registering in the Playlist.
- Still images converted to a movie are shown with .

Selecting the playing order on your camcorder – Playlist

Saving all the still images on a disc to a movie file

Saving still images to a single movie provides following merits:

- You can save the remaining space for the Playlist on the disc.
- You can register multiple still images as a single movie scene that is recordable up to 999 on a disc.

Insert a DVD-RW in VR mode with still images recorded into your camcorder beforehand.

1 Set the mode dial to  (Play/Edit).

2 Press EDIT.

The display to select editing object appears.

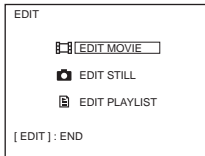

3 Select [EDIT MOVIE] with $\blacktriangle/\blacktriangledown$, then press ENTER.

The movie edit display appears.

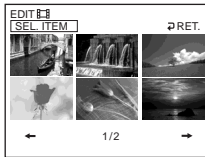

4 Select [SEL. ITEM] with $\blacktriangleleft/\blacktriangleright$, then press ENTER.

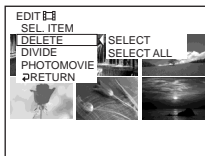

5 Select [PHOTOMOVIE] with $\blacktriangle/\blacktriangledown$, then press ENTER.

The confirmation display appears.



6 Select [EXEC.] with $\blacktriangleleft/\blacktriangleright$, then press ENTER.

All the still images on the disc are saved to a single movie file.

Still images saved as a movie are shown with .

It returns to the movie edit display when the saving is completed.

To cancel the saving

Press EDIT in any step from 3 to 5.

Selecting the playing order on your camcorder – Playlist

Erasing unnecessary scenes from the Playlist

Erasing unnecessary scenes from the Playlist does not affect the actual recorded data on the disc.

Insert a Playlist-registered DVD-RW into your camcorder beforehand.

- 1 Set the mode dial to  (Play/Edit).
- 2 Insert a recorded DVD-RW in VR mode, then press EDIT.
The display to select editing object appears.

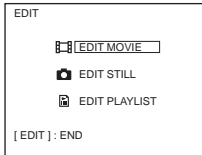

- 3 Select [EDIT PLAYLIST] with $\blacktriangle/\blacktriangledown$, then press ENTER.
The Playlist edit display appears.

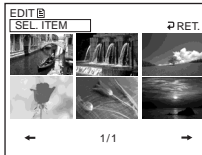

- 4 Select [SEL. ITEM] with $\blacktriangle/\blacktriangleright$, then press ENTER.

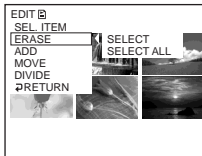

- 5 Select [ERASE] with $\blacktriangle/\blacktriangledown$, then press ENTER.

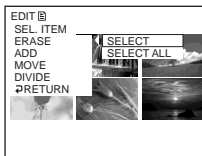

- 6 Select [SELECT] with $\blacktriangle/\blacktriangledown$, then press ENTER.
A thumbnail list of movies or still images registered to the Playlist appears.

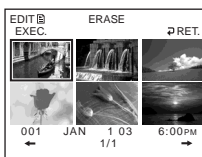

Selecting the playing order on your camcorder – Playlist

- 7 Select the scene to be erased with ◀/▲/▼/▶, then press ENTER.
The selected scene is marked with ✓.
Repeat this step to erase multiple scenes.

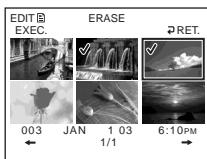

Pressing ▶ starts playback of the selected scene. Press ■ to return to the display to select other scenes.

- 8 Select [EXEC.] with ◀/▲/▼/▶, then press ENTER.
The confirmation display appears.

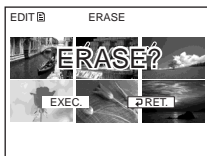

- 9 Select [EXEC.] with ◀/▶, then press ENTER.
The selected scenes are erased from the Playlist. It returns to the Playlist edit display when the erasing is completed.

To erase all the scenes at the same time

Select [SELECT ALL] in step 6 then perform step 9.

To cancel erasing

Press EDIT in any step from 3 to 8.

Tip

Still images registered in a Playlist are converted to a movie file. If you erase still images from a Playlist, the converted movie file from still images still remains. To delete a converted movie file from the movie folder, see “Deleting movies/still images” (page 87).

Selecting the playing order on your camcorder – Playlist

Changing the order within the Playlist



Insert a Playlist-registered DVD-RW into your camcorder beforehand.

1 Set the mode dial to  (Play/Edit).

2 Press EDIT.



The display to select editing object appears.

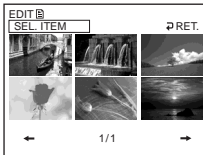

3 Select [EDIT PLAYLIST] with /, then press ENTER.

The Playlist edit display appears.





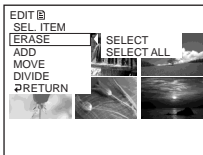

4 Select [SEL. ITEM] with /, then press ENTER.

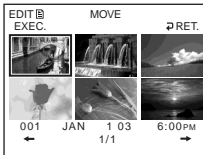

5 Select [MOVE] with /, then press ENTER.

A thumbnail list of the scenes registered to the Playlist appears.





6 Select the scene to be moved with //, then press ENTER.

The selected scene is marked with .

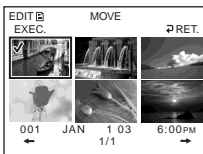
Repeat this step if you want to move multiple scenes.



Pressing  starts playback of the selected scene. Press  to return to the display to select other scenes.

Selecting the playing order on your camcorder – Playlist

- 7 Select [EXEC.] with ◀/▲/▼/▶, then press ENTER.
The move destination display appears.

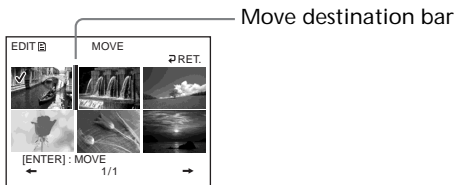

- 8 Place the move destination bar where you want to move the scenes with ◀/▲/▼/▶, then press ENTER.
The confirmation display appears.



- 9 Select [EXEC.] with ◀/▶, then press ENTER.
The selected scene in step 6 is moved to the designated position. When you have selected multiple scenes, the scenes are moved following the order appeared in the Playlist.
It returns to the Playlist edit display when the moving is completed.

To cancel the change in the order

Press EDIT in any step from 3 to 8.

Selecting the playing order on your camcorder – Playlist

Dividing a movie within the Playlist

You can divide a movie into two scenes. Dividing movies into scenes within the Playlist does not affect the actual recorded data on the disc.

Insert a Playlist-registered DVD-RW into your camcorder beforehand.

Note

You cannot divide a movie converted from still images.

1 Set the mode dial to  (Play/Edit).

2 Press EDIT.

The display to select editing object appears.

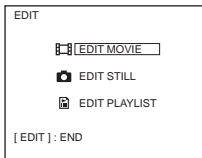

3 Select [EDIT PLAYLIST] with ▲/▼, then press ENTER.

The Playlist edit display appears.

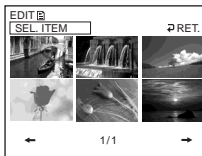

4 Select [SEL. ITEM] with ◀/▶, then press ENTER.

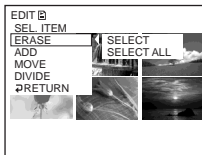

5 Select [DIVIDE] with ▲/▼, then press ENTER.

A thumbnail list of the scenes registered to the Playlist appears.

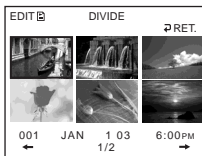

Selecting the playing order on your camcorder – Playlist

- 6 Select the scene to be divided with ◀/▲/▼/▶, then press ENTER.
The dividing display appears and the playback of the selected scene starts.

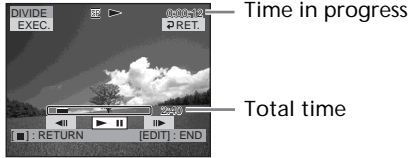

- 7 Press ENTER at the point at which you want to divide the movie into scenes.
The movie pauses.

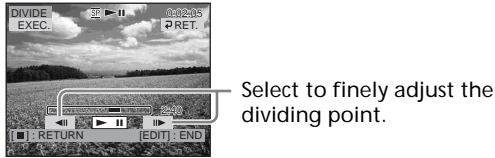

Note

A slight difference may occur from the point where you press ENTER/◀|||▶ and the actual dividing point, as your camcorder selects the dividing point based on half-second increments.

- 8 Select [EXEC.] with ◀/▲/▼/▶, then press ENTER.
The confirmation display appears.



- 9 Select [EXEC.] with ◀/▶, then press ENTER.
Dividing of the movie starts. It returns to the Playlist edit display when the dividing is completed.

To cancel dividing

Press EDIT in any step from 3 to 8.

Selecting the playing order on your camcorder – Playlist





Playing the Playlist

Insert a Playlist-registered DVD-RW into your camcorder.

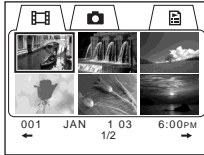
- 1 Set the mode dial to  (Play/Edit).

The Visual Index display appears.



- 2 Select  (Playlist) tab with ///.



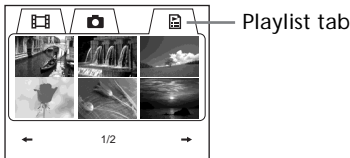

A thumbnail list of the scenes registered to the Playlist appears.



- 3 Press .

A playback of the Playlist starts. On still images, the image appears in sequence. Playback stops when all the registered scenes are played back.

To start playback from a particular scene

Select the scene with ///, then press ENTER.
Playback starts from the selected scene.

To display another scene during playback

Press /.

To pause the scene

Press .

To cancel playback

Press .

Editing the original data

Original data stand for the actual recorded movies and still images data on the disc. You can edit the original data of DVD- RW recorded in VR mode. Editing the original data affects the actual recorded data.

Dividing a movie

Note that this operation actually divides the original recorded data on the disc. Insert a recorded DVD-RW in VR mode into your camcorder beforehand.

Notes

- You cannot divide still images and still images converted to a movie.
- When the movie is registered in the Playlist, dividing the original movie does not affect the movie in the Playlist. Register the divided movies in the Playlist again.

1 Set the mode dial to  (Play/Edit).

2 Press EDIT.

The display to select editing object appears.

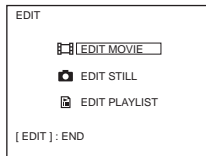

3 Select [EDIT MOVIE] with , then press ENTER.

The Movie edit display appears.

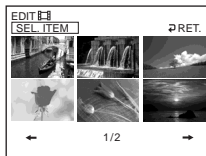

4 Select [SEL. ITEM] with , then press ENTER.

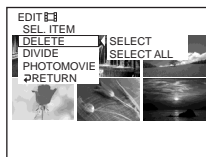

5 Select [DIVIDE] with , then press ENTER.

A thumbnail list of movies on the disc appears.

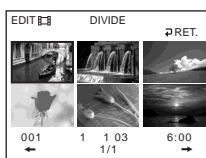

Editing the original data

- 6 Select the scene to be divided with ◀/▲/▼/▶, then press ENTER.
The editing display appears and the playback of the selected movie starts.

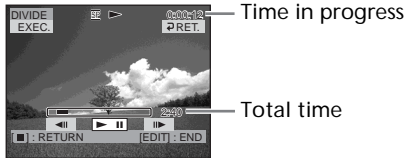

- 7 Press ENTER at the point at which you want to divide the movie into scenes.
The movie pauses.

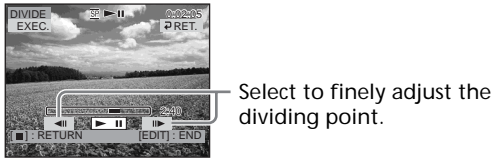

Note

A slight difference may occur from the point where you press ENTER/◀||/||▶ and the actual dividing point, as your camcorder selects the dividing point based on half-second increments.

- 8 Select [EXEC.] with ◀/▲/▼/▶, then press ENTER.
The confirmation display appears.

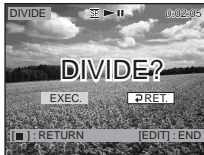

- 9 Select [EXEC.] with ◀/▶, then press ENTER.
Dividing of the movie starts. It returns to the movie edit display when the dividing is completed.

To cancel dividing

Press EDIT in any step from 3 to 8.

Editing the original data

Deleting movies/still images

You can delete unnecessary original movies/still images. Note that this operation actually deletes recorded data from the disc.

Insert a recorded DVD-RW in VR mode into your camcorder beforehand.

Notes

- When you delete movies, the movies registered to the Playlist are also deleted.
- Deleting movies/still images may not provide enough space to record movies/still images additionally.

1 Set the mode dial to  (Play/Edit).

2 Press EDIT.

The display to select editing object appears.

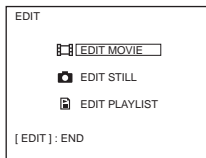

3 Select [EDIT MOVIE] or [EDIT STILL] with $\blacktriangle/\blacktriangledown$, then press ENTER.

The movie or still images edit display appears.

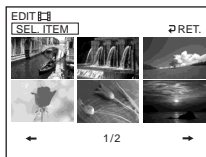

4 Select [SEL. ITEM] with $\blacktriangle/\blacktriangleright$, then press ENTER.

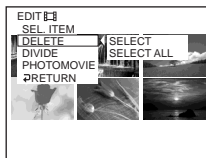

5 Select [DELETE] with $\blacktriangle/\blacktriangledown$, then press ENTER.

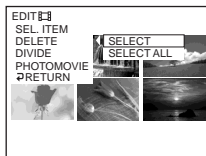

Editing the original data

- 6 Select [SELECT] with ▲/▼, then press ENTER.
A thumbnail list of the movies/still images recorded on the disc appears.

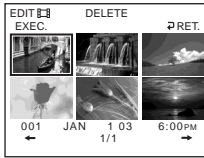

- 7 Select the movie or the still image to be deleted with ◀/▲/▼/▶, then press ENTER.
The selected scene is marked with ✓.
Repeat this step to select multiple movies/still images.

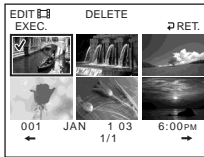

Pressing ▶ starts playback of the selected movie/still image. Press ■ to return to the display to select other movie/still image.

- 8 Select [EXEC.] with ◀/▲/▼/▶, then press ENTER.
The confirmation display appears.



- 9 Select [EXEC.] with ◀/▶, then press ENTER.
The selected movies/still images are deleted from the disc. It returns to the movie edit/still image edit display when the deletion is completed.

To delete all movies/still images in the folder at the same time
Select [SELECT ALL] in step 6. All movies or still images respectively are deleted when you select [EDIT MOVIE] or [EDIT STILL] in step 3.

To cancel the deletion

Press EDIT in any step from 3 to 8.

Tip

To delete all the movies/still images on the disc, perform formatting (page 72).

Connecting your camcorder to your computer – Introduction

You can enjoy the following with your camcorder by connecting it to your computer:

- Viewing scenes on your computer
- Copying recorded scenes to your computer
- Duplicating a disc
- Editing scenes copied to your computer
- Making original DVD recorded scenes on your computer.

The USB driver installation is required to connect your camcorder to your computer.

Install the USB driver before connecting the camcorder to your computer. If you connect the camcorder to the computer first, you will not be able to install the USB driver correctly.

Tips

- The USB driver can be found on the CD-ROM supplied, along with the application software required for viewing scenes.
- Your camcorder is compatible with Hi-Speed USB (USB 2.0 Specification).
- You can transfer data at a faster rate using your camcorder with a computer compatible with Hi-Speed USB.

System requirements

OS:

Microsoft Windows Me,
Microsoft Windows 2000 Professional,
Microsoft Windows XP Home Edition or
Microsoft Windows XP Professional.

The above OS must be installed at the factory. Operation is not assured in an environment upgraded to the operating systems described above or in a multi-boot environment.

CPU:

Minimum: 500 MHz Intel Pentium III or faster
(1 GHz Intel Pentium III or faster recommended)

Application:

DirectX 8.0a or later

Sound system:

16 bit stereo sound card and stereo speakers

Memory:

64 MB or more

Hard disk:

Available free space required for installation:
at least 250 MB

Available hard disk space recommended:
at least 2 GB (depending on the size of the files edited)

Display:

Video card with 4 MB of VRAM, Minimum 800 × 600 Hi color (16 bit color, 65 000 colors), Direct Draw display driver capability (At 800 × 600 or less, 256 colors and less, this product will not operate correctly.)

USB port:

Must be provided as standard.

Consult the computer manufacturer for the details on connectors and editing software of your computer.

The supplied CD-ROM does not support to connect your camcorder to a Macintosh computer.

Connecting your camcorder to your computer – Introduction

Notes on using your computer

Software

Depending on your application software, the file size may increase when you open a still image file.

Communications with your computer

Communications between your camcorder and your computer may not recover properly even after your computer recovers from Suspend/Resume, or from Sleep status.

Installing the USB driver

Start the following operation before connecting the USB cable to your computer.

Install the USB driver to control your camcorder from your computer.

If you are using Windows 2000 Professional or Windows XP Home Edition/Professional, log in as administrator.

- 1 Turn on your computer and allow Windows to load.
When your computer is already turned on, close all the software.
- 2 Insert the supplied CD-ROM into the CD-ROM drive of your computer.
The installation menu screen appears.



If the menu screen does not appear, double-click [My Computer,] then [ImageMixer] (CD-ROM Drive). The menu screen appears after a while.

Connecting your camcorder to your computer – Introduction

- 3 Move the cursor to [USB Driver] and click.

InstallShield Wizard program starts up.



- 4 Click [Next].

The USB driver installation starts. “InstallShield Wizard Complete” screen appears after a while.



- 5 Click [Finish].

The USB driver installation is completed.

Note

If you connect the USB cable before USB driver installation is complete, the USB driver will not be properly registered. Install the USB driver again following the steps in “If you cannot install the USB driver” (page 97).

Installing software

Install the ImageMixer Ver.1.5 for Sony DVD Handycam (hereinafter referred to as ImageMixer) software that manages movies and still images transferred from your camcorder on your computer, and the WinASPI software that manages writing data on CD-Rs/CD-RWs.

- 1 When the USB driver installation is completed, click [ImageMixer] on the menu screen.

Install Wizard program starts up and the “Choose Setup Language” screen appears.

If the menu screen does not appear, double-click [My Computer,] then [ImageMixer] (CD-ROM Drive). The menu screen appears after a while.



- 2 Select the language to be used and click [OK].

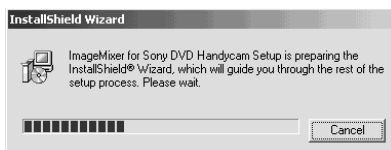

- 3 Follow the instructions given in the on-screen messages. When the “Setup Type” screen appears, make sure that [NTSC] is selected and continue the procedure. The “InstallShield Wizard Complete” screen appears.

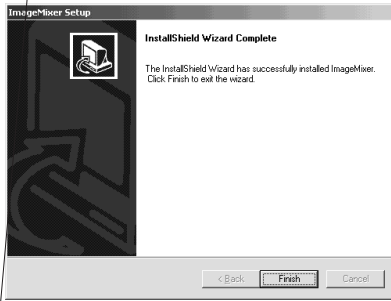

- 4 Click [Finish].
The installation of ImageMixer is completed. The installation screen of WIN ASPI appears (Windows 2000 Professional and Windows XP users only).
- 5 Follow the instructions given in the on-screen messages.
- 6 When The “InstallShield Wizard Complete” screen appears, click [Finish].
- 7 Take out the CD-ROM from the CD-ROM drive after the computer restarts.

Note

On a computer without DirectX 8.0a or later, DirectX installation starts. Follow the instructions given in the on-screen messages and restart the computer after the installation is complete.



To replace WIN ASPI

To be able to use the ImageMixer CD writing function, you need to install WIN ASPI. If a different writing application was previously installed, its writing function may not work correctly. If that happens, reinstall the original application and replace WIN ASPI. Note that the ImageMixer CD writing function may not work properly.

Connecting your camcorder to the computer

You can connect only one camcorder to every single computer. Operations are not guaranteed if you connect your camcorder via a USB hub or to the USB port not equipped with your computer at default.

For Microsoft Windows XP users

- 1 Connect the AC adaptor to your camcorder.
- 2 Set the mode dial to  (Play/Edit).
- 3 Turn the power on your camcorder by sliding the POWER switch upward while pressing the green button.
- 4 Connect the  (USB) jacks of the camcorder and the  (USB) port of the computer using the USB cable supplied with your camcorder.

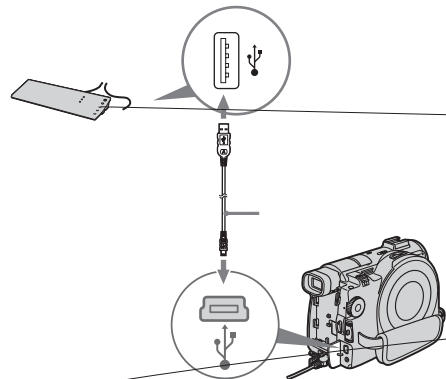

Your computer recognizes the camcorder, and the “Found New Hardware Wizard” starts.

Connecting your camcorder to your computer – Introduction



- 5 Select [Install the software automatically (Recommended)] and click [Next].

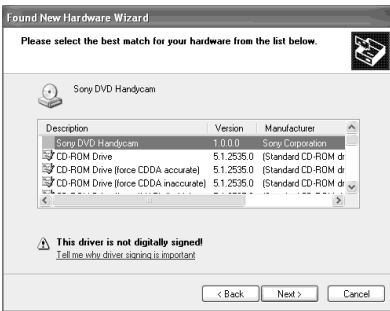

- 6 Make sure that [Sony DVD Handycam] is selected as the best match and click [Next]. Click [Sony DVD Handycam] if it is not selected. “Completing the Found New Hardware Wizard” screen appears.



- 7 Click [Finish]. The connection between your camcorder and the computer is completed.

To disconnect the USB cable See “To disconnect the USB cable” (page 96).

To confirm the USB driver installation

- 1 Click [Start] → [Control Panel].
 - 2 Click [Performance and Maintenance] → [System].
- “System Properties” screen appears.
- 3 Click [Hardware] tab.
 - 4 Click [Device Manager].
- “Device Manager” screen appears.
- 5 Make sure that “SONY DDX-A1000 USB Device” appears in DVD/CD-ROM drives, “Generic volume” in Storage volumes, and “USB Mass Storage Device” in Universal Serial Bus controllers respectively.

When all the devices appear, the USB driver is installed correctly. If any of these devices are not shown, install the USB driver again following “If you cannot install the USB driver” (page 97).

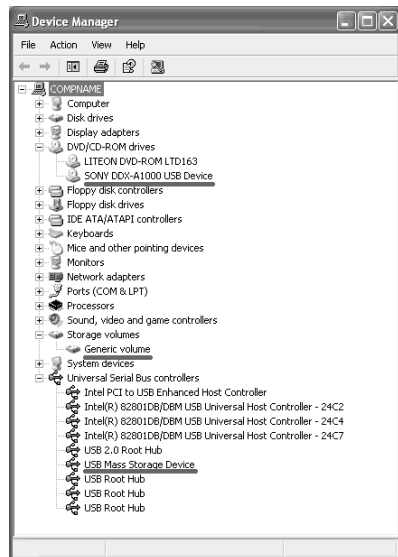

Viewing/dubbing discs/ editing the recordings on your computer

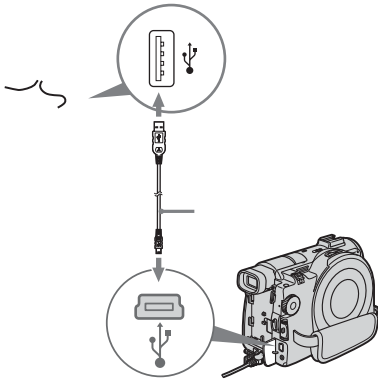

Connecting your camcorder to your computer – Introduction



To confirm the USB driver installation

- 1 Click [Start] → [Settings] → [Control Panel].
- 2 Click [System].
“System Properties” screen appears.
- 3 Click [Hardware] tab.
- 4 Click [Device Manager].
“Device Manager” screen appears.
- 5 Make sure that “SONY DDX-A1000 USB Device” appears in DVD/CD-ROM drives, “Generic volume” in Storage volumes, and “USB Mass Storage Device” in Universal Serial Bus controllers respectively.

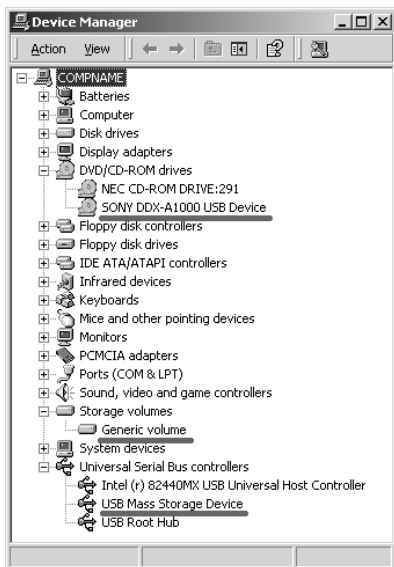
When all the devices appear, the USB driver is installed correctly. If any of these devices are not shown, install the USB driver again following “If you cannot install the USB driver” (page 97).



For Microsoft Windows Me users

- 1 Connect the AC adaptor to your camcorder.
- 2 Set the mode dial to  (Play/Edit).
- 3 Turn the power on your camcorder by sliding the POWER switch upward while pressing the green button.
- 4 Connect the  (USB) jacks of the camcorder and the  (USB) port of the computer using the USB cable supplied with your camcorder.

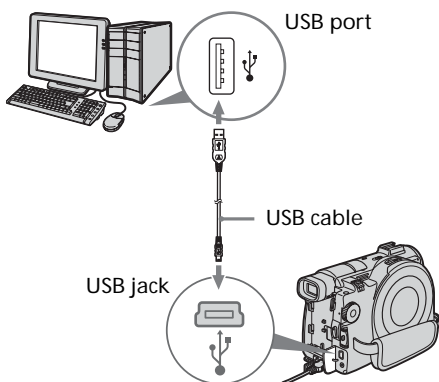

Your computer recognizes the camcorder, and the “New Hardware Found” dialog box appears.

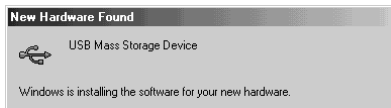

- 5 Follow the instructions given in the on-screen messages and restart your computer.
The connection between your camcorder and the computer is completed.

Connecting your camcorder to your computer – Introduction

To disconnect the USB cable
See “To disconnect the USB cable” (page 96).

To confirm the USB driver installation

- 1 Click [Start] → [Settings] → [Control Panel].
- 2 Click [System].
“System Properties” screen appears.
- 3 Click [Device Manager].
“Device Manager” screen appears.
- 4 Make sure that “SONY DDX-A1000 USB Device” appears in CD-ROM, “Sony DVD Handycam” in Storage device, and “USB Mass Storage Device” in Universal Serial Bus controllers respectively. When all the devices appear, the USB driver is installed correctly. If any of these devices are not shown, install the USB driver again following “If you cannot install the USB driver” (page 97).

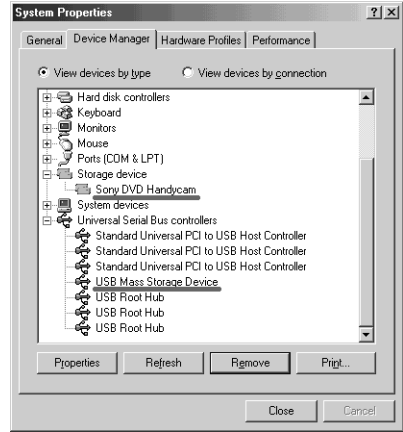
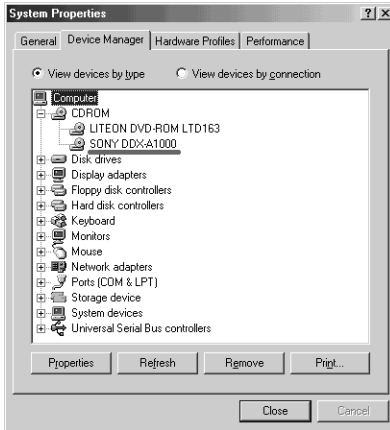

To Disconnect the USB cable

- 1 Move the cursor to the “Unplug or Eject Hardware” icon on the Task Tray and click to cancel the applicable drive.



- 2 After the “Safe to Remove Hardware” dialog box appears, disconnect the USB cable and turn off your camcorder.

Notes

- Be sure to turn off your camcorder after disconnecting it from your computer. Turning off your camcorder keeping connection to the computer may prevent from normal disconnection.
- Never disconnect the USB cable when the Access/Open lamp is lit in red. It may cause a damage to the disc.

If you cannot install the USB driver

The USB driver have been registered incorrectly as your computer was connected to your camcorder before the installation of the USB driver was completed. Perform the following procedure to install the USB driver correctly.

- 1 Disconnect your camcorder from the computer following “To Disconnect the USB cable” (page 96).
- 2 Install the USB driver again following “Installing the USB driver” (page 90).
- 3 Connect your camcorder to the computer following “Connecting your camcorder to the computer” (page 92). The USB driver installation and the connection between your camcorder and the computer is completed.

Consulting the on-line help (operating instructions) of ImageMixer Ver.1.5 for Sony DVD Handycam

An ImageMixer Ver.1.5 for Sony DVD Handycam on-line help is available where you can find detailed operating instructions for ImageMixer software.

- 1 Click  located at the top right of the screen.
Or, click [Start] → [Programs] ([All Programs] in Windows XP) → [PIXELA] → [ImageMixer] → [Help]. The ImageMixer Help screen appears.
- 2 Find the information you need from the table of contents.

To close the on-line help

Click the  button at the top right of the screen.

If you have any questions about ImageMixer Ver.1.5 for Sony DVD Handycam



ImageMixer Ver.1.5 for Sony DVD Handycam is the product of PIXELA corporation. For details, refer to the operating instructions of the CD-ROM supplied with your camcorder.

Viewing scenes recorded on your computer

You must install the USB driver and the ImageMixer software to view scenes recorded on a disc with your computer (page 90, 91). If you are using Windows 2000 Professional or Windows XP Home Edition/Professional, log in as administrator.

Viewing scenes on the disc

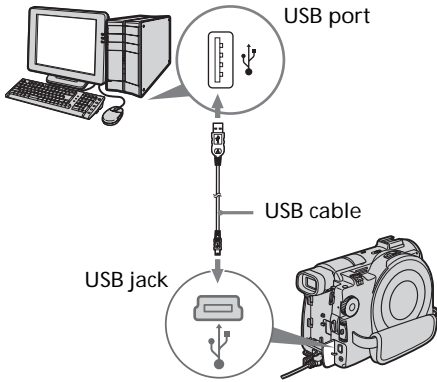

You can view scenes recorded on the disc without finalizing on your computer, by inserting a recorded disc into your camcorder and connecting it to your computer.

- 1 Turn on your computer and allow Windows to load.
- 2 Connect the AC adaptor to your camcorder.
- 3 Set the mode dial to  (Play/Edit).
- 4 Turn the power on your camcorder by sliding the POWER switch upward while pressing the green button.
- 5 Insert a recorded disc into your camcorder.
- 6 Connect the  (USB) jacks of the camcorder and the  (USB) port of the computer using the USB cable supplied with your camcorder.





- 7 Double-click [ImageMixer Ver.1.5 for Sony] icon on the Windows desktop. Or, click [Start] → [Programs] ([All Programs] in Windows XP) → [PIXELA] → [ImageMixer] → [PIXELA ImageMixer Ver.1.5 for Sony] on your computer. The ImageMixer software starts and the title screen appears.



- 8 Click  on the left of the screen. The ImageMixer software starts and thumbnails of the scenes recorded on the disc appear. When the thumbnails do not appear, click .

Thumbnails



- Click  to view movies and click  to view still images.

Viewing scenes recorded on your computer

- 9 Double-click the scene to view from the thumbnails.
The selected scene is temporarily copied to your computer and is displayed in the preview window.
To return to the thumbnails list, click  below right of the screen.

To save the scene on your computer

- 1 Click the thumbnail of the scene to save.
- 2 Click .
The selected scene is saved on your computer.



Notes

- It may take some time to save the scene depending on the recording mode (page 33) and the length of the movie.
- Still images converted to a movie are not displayed.

Tip

An album is a unit to register and to manage the saved movies and still images saved from your camcorder to your computer.

To view the album

- 1 Click .
- 2 Double-click the scene to view from the thumbnails.
The selected scene is displayed. When you have selected a movie, click  and start playback.
To return to the thumbnails list, click  at the top right of the screen.



Notes

- If you connect the USB cable before USB driver installation is complete, the USB driver will not be properly registered. Install the USB driver again following the steps in “If you cannot install the USB driver” (page 97).
- When anything goes wrong with the operation, close all the software and restart them.



Making a disc copy – Disc Dubbing

Making a disc copy

You can make a copy of a finalized disc.

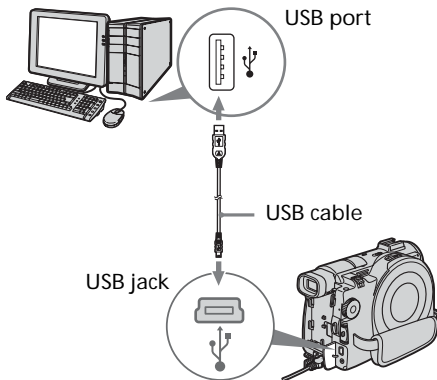
- 1 Turn on your computer and allow Windows to load.
- 2 Connect the AC adaptor to your camcorder.
- 3 Set the mode dial to  (Play/Edit).
- 4 Turn the power on your camcorder by sliding the POWER switch upward while pressing the green button.
- 5 Insert a recorded disc into your camcorder.
- 6 Connect the  (USB) jacks of the camcorder and the  (USB) port of the computer using the USB cable supplied with your camcorder.



- 7 Start the ImageMixer software on your computer.
- 8 Click  on the left of the screen.
- 9 Click  (Duplication).
The confirmation screen appears.

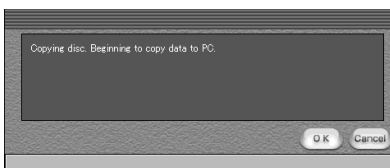

10 Click [OK].

11 When the copy completion message appears, eject the disc and insert a new disc into your camcorder.

12 Click [OK].

Copying of data from your computer to the new disc starts. When the disc copy operation is completed, a screen asking if you want to make an additional copy appears.

13 If you want to make an additional copy, click [OK].

The making of an additional copy starts. If you do not want to make an additional copy, click [Cancel] to end the procedure.

14 Eject the disc following the instructions given in the on-screen messages.

Notes

- It may take some time to save the scene depending on the recording mode (page 33) and the length of the movie.
- You cannot make a copy of an unfinalized disc.
- Using DVD-RWs for the copied media prevents you from unfinalizing and making additional recordings on your camcorder because the format of copied media is different from that of your camcorder. You must format the DVD-RW to record additional material on the disc.

Tip

To use the disc with other DVD authoring applications, an export procedure is required. For details, see the ImageMixer on-line help.

Editing and saving scenes

You can edit the movies and still images save on your computer and save them using the ImageMixer software.

Editing movies

You can unite multiple scenes into a single scenes.

- 1 Click .

The screen switches to the movie editing mode and thumbnails appear.

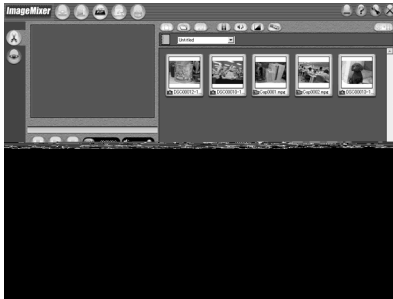

- 2 Drag and drop the thumbnails on the storyboard in the order you want to edit them.

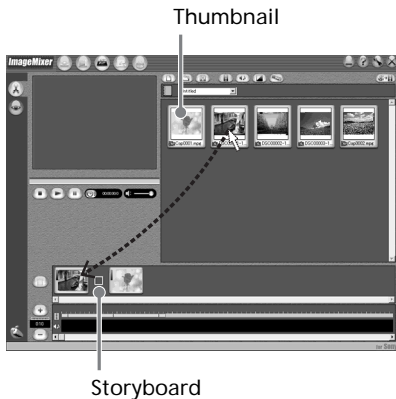

When you delete the specific scene, click the scene, then click .

Saving the movie on your computer

When the editing of the movie is completed, you can save the data as on your computer. The following procedure shows an example of saving data in the My Documents folder.

- 1 Click  (Generate movie).

The “Output Format Settings” screen appears.

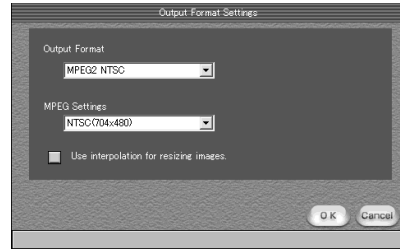

- 2 Click [OK].

- 3 Select the My Documents folder as the saving destination, then name the file and click [OK] to save it. When the movie is saved, it is also saved as a new file in the album.

Note

It takes some time for saving the file in the following cases:

- when the file includes both movies and still images.
- when the file includes multiple recording modes (HQ/SP/LP).
- when some effects such as fader are added.

To view the saved file

Double-click the saved file (stored in the My Documents folder in this procedure).

Windows Media Player starts and the file is played back.

Creating an original disc

You can edit the scenes registered to the album and make an original DVD.

Making a menu

A menu is required to play a disc recorded on your camcorder on a DVD player.

- 1 Click .

The “Layout mode” screen appears.

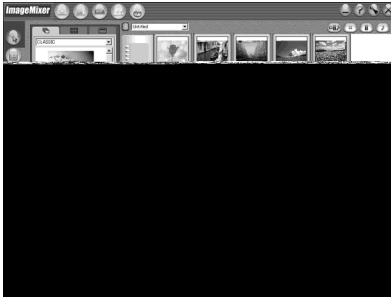



- 2 Click the  tab and select a background.
- 3 Drag and drop thumbnails of the scenes to record on the disc, onto the background. The thumbnails change into icons and the selected scenes are registered to contents. You can register an album as a single title by dragging and dropping the album onto the background. You can also joint scenes from multiple albums and display it as a single title.

Album menu:
Click to change the displayed album.

Disc title

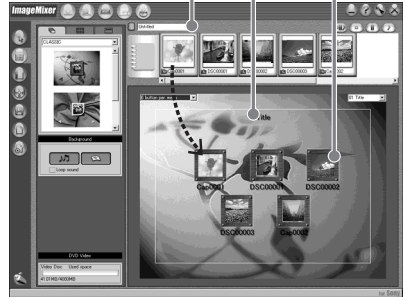
Title



- 4 When you want to change the names and designs of icons, click the  tab. Click the icon and change the settings.

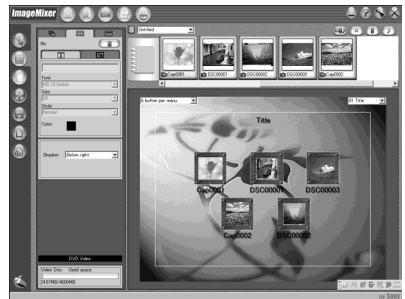

Creating an original disc

- 5 When you want to change the disc title shown on the menu, click the  tab. Change the settings such as the name and the font.

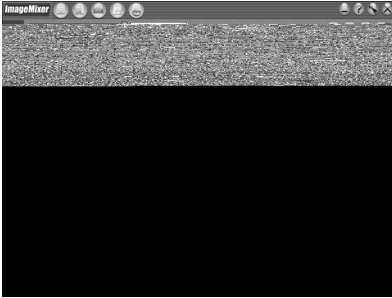

Tip

When you create a DVD on the DVD drive installed with your computer, you can change the "Disc Type" from [1.4G] to [4.7G] by clicking  at the top right of the screen. Selecting [4.7G] enables you to record data in 12 cm DVD-R/DVD-RW at its maximum capacity.

Editing the contents

You can edit the contents by adding/deleting scenes, changing the order of scenes, and selecting an image used for the thumbnail.

- 1 Click the icon of the contents to edit, then click  (Album mode) on the left of the screen. The "Album mode" screen appears.



- 2 Drag and drop the contents to add and change the order. To delete the contents, click the contents, then click . Note that image selected as a thumbnail cannot be deleted.





Creating an original disc

Recording on a disc

Check the menu and view the contents on a preview screen, then record the contents on a disc.

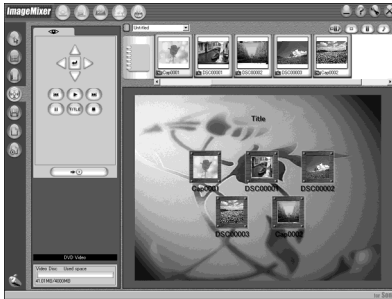
- 1 Click  (Writing mode) on the left of the screen. The “Writing mode” screen appears.



- 2 Click the button on the  (Preview) box on the upper left of the screen, and preview the contents.

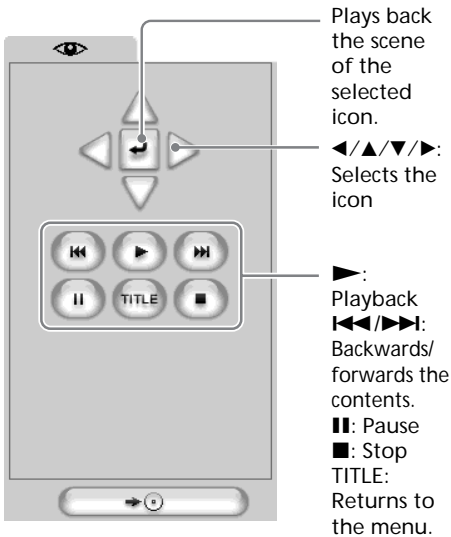

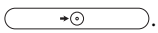
- 3 When you have checked that all the contents are right, connect your camcorder to the computer with the USB cable, then insert a blank disc into your camcorder.
- 4 Click . The “DVD Video Output” screen appears.

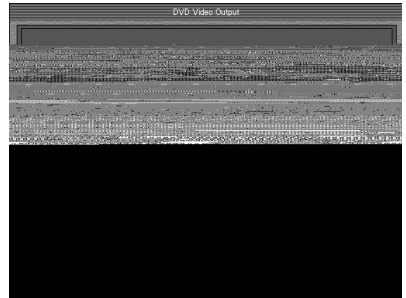

- 5 Click [OK]. Recording on the disc starts. When the operation is completed, a screen asking if you want to make an additional copy appears.
- 6 If you want to make an additional copy, click [OK]. The making of an additional copy starts. If you do not want to make an additional copy, click [Cancel] to end the procedure.
- 7 Eject the disc following the instructions given in the on-screen messages.

ED

Dubbing a disc to a tape

Dubbing to a tape

Before operation

- Set [DISPLAY] in **[ETC]** (OTHERS) to LCD in the SETUP display. (The default setting is [LCD].)
- Press the following buttons to make the indicators disappear so that they will not be superimposed on the edited tape:
 - DISPLAY/BATT INFO
 - DISPLAY on the Remote Commander
 - DATA CODE on the Remote Commander

- 1** Insert the recorded disc into your camcorder.
- 2** Prepare the VCR for recording.
Insert a blank tape (or a tape you want to record over) into the VCR.
Set the input selector to LINE.
Refer to the operating instructions of the VCR.
- 3** Play back the recorded disc on your camcorder.
- 4** Start recording on the VCR.
Refer the operating instructions of your VCR.

When you have finished dubbing

Stop recording on the VCR, then press **■** on your camcorder.

Dubbing a TV program or video tape onto a disc

You can record a disc from another VCR or a TV program from a TV that has video/audio outputs. Use your camcorder as a recorder.

Connecting your camcorder to a TV or a VCR

Connect your camcorder to the TV/VCR using the A/V connecting cable supplied with your camcorder.

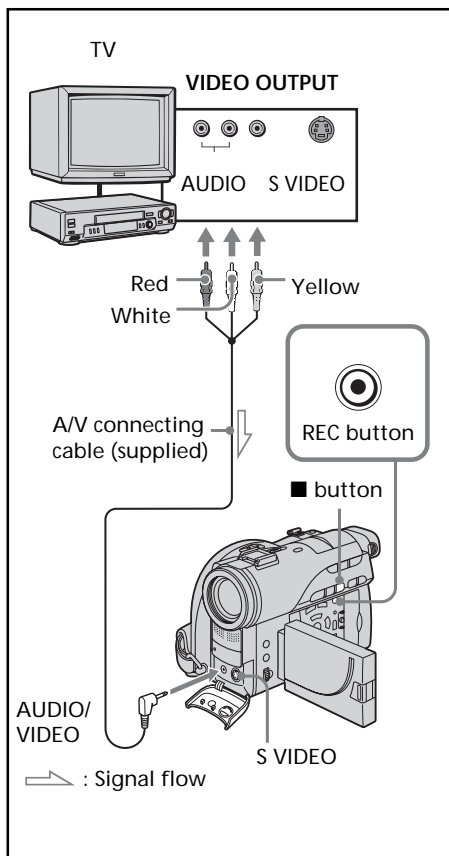

Dubbing onto a disc

Set [DISPLAY] in [ETC] (OTHERS) to [LCD] in the SETUP display. (The default setting is [LCD].)

You can also use the Remote Commander for this operation.

- 1 Prepare the TV/VCR.
If you are recording a tape from the VCR, insert a recorded tape into the VCR.
- 2 Set the mode dial to (Play/Edit) on your camcorder.
- 3 Insert a blank disc (or a disc you want to record additionally) into your camcorder.
The FORMAT display appears when you insert a new DVD-RW. Format the disc in VIDEO mode or in VR mode (page 7) following the instructions on the LCD display.
- 4 Press VISUAL INDEX on your camcorder.
The Visual Index display disappears, and the image from the LINE appears.
- 5 Press on the VCR to start playback if you are recording a tape from a VCR. Select a TV program if you are recording from a TV. The picture from the VCR or TV appears on the LCD display or in the viewfinder.
- 6 Press on your camcorder at the scene where you want to start recording. Dubbing starts.

Tip

To change the recording mode, see page 33.

When you have finished dubbing the disc







Press on your camcorder to stop recording and stop the playback on the VCR.



Changing the SETUP display

You can partially change the default settings by selecting the options in the SETUP display with ◀/▲/▼/▶.

Select the item in the following order:
 SETUP display → icon → menu item
 → option

Menu items are displayed as the following icons. The displayed icons are different depending on the mode dial position.

-  APPLI
-  MANUAL SET
-  CAMERA SET
-  LCD/VF SET
-  DISC SET
-  SETUP MENU
-  OTHERS

- 1 Turn the power on by sliding the POWER switch upward while pressing the green button.
- 2 Set the mode dial to  (Movie),  (Still) or  (Play/Edit), then press SETUP.

 (Movie)

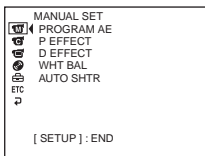

 (Still)

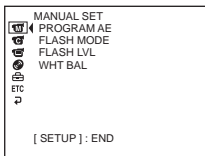

 (Play/Edit)

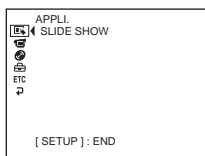

- 3 Select the desired icon with ▲/▼, then press ENTER.

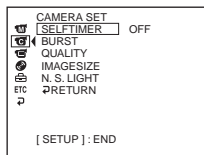

- 4 Select the desired item with ▲/▼, then press ENTER.

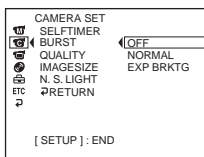

- 5 Select the desired mode with ▲/▼, then press ENTER.

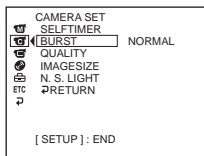

- 6 If you want to change other items, select [RETURN] and press ENTER, then repeat steps 3 to 5. To return to step 3, select [RETURN].



For details, see “Selecting the mode setting of each item” on the next page.











To make the SETUP display disappear
 Press SETUP.

Changing the SETUP display

Selecting the option of each item ● is the default setting.

Menu items differ depending on the position of the mode dial. The display shows only the items that are currently in effect or that you can operate at the moment.

Icon/item	Option	Meaning	Mode dial
 APPLI.			
	SLIDE SHOW —	To play back still images continuously (page 61)	 Play/Edit











Icon/item	Option	Meaning	Mode dial
 MANUAL SET			
	PROGRAM AE —	To suit your specific shooting requirement (page 47)	 Movie  Still
	P EFFECT —	To add special effects like those in films or on TV to images (page 51)	 Movie
	D EFFECT —	To add special effects using the various digital functions (page 51)	 Movie
	FLASH MODE ● ON	To fire the flash (optional), regardless of the brightness of the surroundings	 Still
	ON ●	To fire the flash (optional), regardless of the brightness of the surroundings. Pre-flashes before recording to reduce the red-eye phenomenon	
	AUTO	To fire the flash (optional) automatically	
	AUTO ●	To fire the flash (optional) automatically. Pre-flashes before recording to reduce the red-eye phenomenon	
	FLASH LVL *1 *2		
	HIGH	To make the flash (optional) level higher than normal	 Still
	● NORMAL	Normal setting	
	LOW	To make the flash (optional) level lower than normal	
	WHT BAL —	To adjust the white balance (page 44)	 Movie  Still
	AUTO SHTR ● ON	To automatically activate the electronic shutter* ³ when shooting in bright conditions	 Movie
	OFF	To not automatically activate the electronic shutter* ³ in bright conditions	

*1 You cannot adjust [FLASH MODE] and [FLASH LVL] if an external flash (optional) is not connected.

*2 You cannot adjust [FLASH LVL] if the external flash (optional) used is not compatible with the flash level.

*3 An electronic shutter is the function used to adjust the shutter speed electronically.

Changing the SETUP display

Icon/item	Option	Meaning	Mode dial
 CAMERA SET			
SELFTIMER	● OFF	To disable self-timer	 Movie
	ON	To use self-timer (page 43)	 Still
D ZOOM	● OFF	To deactivate the digital zoom. Only up to 10× optical zoom is performed.	 Movie
	20×	To activate the digital zoom. From 10× to 20× zoom is performed digitally (page 32)	
	120×	To activate the digital zoom. From 10× to 120× zoom is performed digitally	
16:9WIDE	● OFF	To not record 16:9 wide picture	 Movie
	ON	To record a 16:9 wide picture (page 45)	
STEADYSHOT	● ON	To compensate for camera-shake	 Movie
	OFF	To cancel SteadyShot. Natural pictures are produced when shooting a stationary object with a tripod	
BURST*	● OFF	To disable the Burst	 Still
	NORMAL	To record up to four (in 1152 × 864 size) or 12 (in 640 × 480 size) still images continuously fast (page 39)	
	EXP BRKTG	To record three images continuously with different exposures	
QUALITY	● FINE	To record still images in the fine image quality mode (page 37)	 Still
	STANDARD	To record still images in the standard image quality mode	
IMAGESIZE*	● 1152 × 864	To record still images in 1152 × 864 size (page 38)	 Still
	640 × 480	To record still images in 640 × 480 size	
N.S.LIGHT	● ON	To use NightShot Light (page 42)	 Movie
	OFF	To cancel NightShot Light	 Still

* DCR-DVD200/DVD300 only

Notes



On SteadyShot

- [SteadyShot] will not correct excessive camera-shake.
- Attachment of a conversion lens (optional) may influence [SteadyShot].

Tip

If you cancel [SteadyShot], the SteadyShot off indicator “” appears. Your camcorder prevents excessive compensation for camera-shake.

Changing the SETUP display

Icon/item	Option	Meaning	Mode dial
 LCD/VF SET			
LCD BRIGHT	—	To adjust the brightness on the LCD screen with ◀/▶.	<input type="checkbox"/> Movie <input checked="" type="checkbox"/> Still <input type="checkbox"/> Play/Edit
		 Darker ▶ Brighter	
LCD B.L.	<input checked="" type="radio"/> BRT NORMAL <hr/> <input type="radio"/> BRIGHT	To set the brightness on the LCD screen to normal <hr/> To brighten the LCD screen	<input type="checkbox"/> Movie <input checked="" type="checkbox"/> Still <input type="checkbox"/> Play/Edit
LCD COLOR	—	To adjust the color on the LCD screen with ◀/▶.	<input type="checkbox"/> Movie <input checked="" type="checkbox"/> Still <input type="checkbox"/> Play/Edit
		To get low-intensity color  To get high-intensity color ▶	
VF B.L.	<input checked="" type="radio"/> BRT NORMAL <hr/> <input type="radio"/> BRIGHT	To set the brightness on the viewfinder screen to normal <hr/> To brighten the viewfinder screen	<input type="checkbox"/> Movie <input checked="" type="checkbox"/> Still <input type="checkbox"/> Play/Edit

Notes

















On LCD B.L. and VF B.L.

- When you select [BRIGHT], battery life is reduced a little during recording.
- When you use power supplies other than the battery pack, [BRIGHT] is automatically selected.

Tip

Even if you adjust [LCD BRIGHT], [LCD B.L.], [LCD COLOR], and/or [VF B.L.], the recorded picture will not be affected.











Changing the SETUP display

Icon/item	Option	Meaning	Mode dial
 DISC SET			
REC MODE	HQ	To record in the HQ (High Quality) mode	 Movie
	<input checked="" type="radio"/> SP	To record in the SP (Standard Play) mode	 Play/Edit
	LP	To record in the LP (Long Play) mode	
FORMAT* ¹	—	To format a disc (page 72)	   Play/Edit
FINALIZE	—	To prohibit further recording on the disc, and make it compatible with other DVD players (page 63)	   Play/Edit
UNFINALIZE* ¹ * ²	—	To make the finalized disc recordable again (page 70)	   Play/Edit
DISC TITLE	—	To add an original title to the disc (page 54)	   Play/Edit
FILE NO.	<input checked="" type="radio"/> SERIES	To assign numbers to files in sequence even if the disc is changed	 Still
	RESET	To reset the file numbering each time the disc is changed	

*¹ DVD-RWs only



*² VIDEO mode only



Changing the SETUP display

Icon/item	Option	Meaning	Mode dial
 SETUP MENU			
CLOCK SET	—	To set the date or time (page 21)	 Movie  Still  Play/Edit
A. SHUT OFF	<input checked="" type="radio"/> 5 min <hr/> NEVER	To turn the power off automatically if no operations have taken place for five minutes when powered by the battery pack. To remain the power on if no operations last.	 Movie  Still  Play/Edit
LTR SIZE	<input checked="" type="radio"/> NORMAL <hr/> 2×	To display selected menu items in normal size To display selected menu items at twice the normal size	 Movie  Still  Play/Edit
DEMO MODE	<input checked="" type="radio"/> ON <hr/> OFF	To make the demonstration appear To cancel the demonstration mode	 Movie













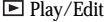

Notes

On DEMO MODE

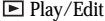

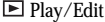

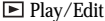







- You cannot select [DEMO MODE] when a disc is inserted in your camcorder.
- When [NightShot] is set to [ON], the "NIGHTSHOT" indicator appears on the LCD display and you cannot select [DEMO MODE] in the SETUP display.
- The following operations cancel the demonstration:
 - When the mode dial is set to  (Still) or  (Play/Edit).
 - When you press SETUP.
 - When the NIGHTSHOT switch is set to ON.
 - When you slide the disc cover OPEN switch.
- The [DEMO MODE] default setting is standby and the demonstration starts about 10 minutes after you have set the mode dial to  (Movie) without a disc inserted.

To cancel the demonstration, insert a disc, set the mode dial to  (Still) or  (Play/Edit), or set [DEMO MODE] to [OFF]. To set the camcorder to standby again, leave the [DEMO MODE] at [ON] in the menu settings, slide the POWER switch to OFF (CHG), and then return the POWER switch to ON and the mode dial to  (Movie).

Changing the SETUP display

Icon/item	Option	Meaning	Mode dial
ETC OTHERS			
DATA CODE (operation on the Remote Commander)	● DATE/CAM	Press DATA CODE on the Remote Commander to display date, time and various settings during playback (page 58)	▶ Play/Edit
	DATE	Press DATA CODE on the Remote Commander to display date and time during playback	
AREA SET	—	To set your local area	 Movie  Still  Play/Edit
DST SET	● OFF	To cancel the use of daylight savings time	 Movie  Still  Play/Edit
	ON	To use the daylight savings time	
BEEP	● MELODY	To output a melody when you start/stop recording or when an unusual condition occurs on your camcorder	 Movie  Still  Play/Edit
	NORMAL	To output the beep instead of the melody	
	OFF	To cancel the melody, beep sound and shutter sound	
COMMANDER	● ON	To activate the Remote Commander supplied with your camcorder	 Movie  Still  Play/Edit
	OFF	To deactivate the Remote Commander to avoid erroneous remote control operation caused by another VCR's remote control.	
DISPLAY	● LCD	To show the display on the LCD screen and in the viewfinder	 Movie  Still  Play/Edit
	V-OUT/LCD	To show the display also on the TV screen	
HiFi SOUND	● STEREO	To play back a stereo disc or dual sound track disc with main and sub sound	▶ Play/Edit
	1	To play back a stereo disc with the left sound or a dual sound track disc with main sound	
	2	To play back a stereo disc with the right sound or a dual sound track disc with sub sound	
REC LAMP	● ON	To light up the camera recording lamp on the front of your camcorder during recording	 Movie  Still
	OFF	To turn the camera recording lamp off so that the subject is not aware of the recording	

Changing the SETUP display

Icon/item	Option	Meaning	Mode dial
ETC OTHERS			
 REMAIN	<input type="radio"/> AUTO	To display the remaining capacity of the disc in the following cases for example: <ul style="list-style-type: none"> • For 8 seconds after setting the power on and the mode dial to  (Movie) or  (Still) • For 8 seconds after recognizing the inserted disc into your camcorder in  (Movie) or  (Still) • For 8 seconds when set the display to on by pressing DISPLAY/BATT INFO in  (Movie) or  (Still) • When the remaining capacity of the disc is less than 5 minutes in  (Movie) or 20 in  (Still) • For 8 seconds when starting recording from the line input 	 Movie  Still  Play/Edit
	<input type="radio"/> ON	To always display the remaining capacity of the disc	

Notes

- If you press DISPLAY/BATT INFO with [DISPLAY] set to [V-OUT/LCD] in the SETUP display, the picture from a TV or VCR will not appear on the LCD display even when your camcorder is connected to outputs on the TV or VCR.
- If more than five minutes passes after removing the power source, the [PROGRAM AE], [FLASH LVL], [WHT BAL], [COMMANDER], and [HiFi SOUND] settings are returned to their factory settings. Other settings are held in memory even when the battery is removed.





Tip

When recording a close subject, if [REC LAMP] is set to [ON], the red camera recording lamp on the front of the camcorder may reflect on the subject if it is close. In this case, it is recommended to set [REC LAMP] to [OFF].





Types of trouble and corrective action

If you run into problems using your camcorder, use the following table to troubleshoot the problem. If the problem persists, disconnect the power source and contact your Sony dealer or local authorized Sony service facility. If "C:□□:□□" appears on the LCD display, the self-diagnosis display function is working. See page 123.



During recording

Symptom	Cause and/or Corrective Actions
Pressing START/STOP or PHOTO does not record movies/still images.	<ul style="list-style-type: none"> • The mode dial is set to  (Play/Edit). → Set it to  (Movie) or  (Still). (page 29, 34) • The disc has run out of space. → Use a new disc or format the disc (DVD-RW only, page 72) • The disc has been finalized. → Unfinalize the disc (DVD-RW only) or use a new disc. (page 70) • Shooting by swapping movies and still images frequently reduces the remaining capacity of the disc and may prevent you from shooting movies. • The copyright-protected movie cannot be dubbed on your camcorder.
The power goes off.	<ul style="list-style-type: none"> • Your camcorder powered by the battery pack turns off for more than five minutes with no operations performed. → Slide the POWER switch to OFF (CHG) and then to ON. → Set [A. SHUT OFF] to [NEVER] in  (SETUP) in the SETUP display. (page 113) • The battery pack is exhausted or nearly exhausted. → Install a charged battery pack. (page 15)
The image on the viewfinder screen is not clear.	<ul style="list-style-type: none"> • The viewfinder is not extended. → Extend the viewfinder. (page 25) • The viewfinder lens is not adjusted. → Adjust the viewfinder lens. (page 25)
SteadyShot does not work.	<ul style="list-style-type: none"> • [STEADYSHOT] is set to [OFF] in  (CAMERA SET) in the SETUP display. → Set it to [ON]. (page 110)
Autofocus does not work.	<ul style="list-style-type: none"> • The setting is set to manual focus. → Press FOCUS to set the autofocus. (page 49) • Shooting conditions are not suitable for autofocus. → Adjust the focus manually. (page 49)
The picture does not appear in the viewfinder.	<ul style="list-style-type: none"> • The LCD screen is open. → Close the LCD screen. (page 19)
A vertical band appears when you shoot a subject such as lights or a candle flame against a dark background.	<ul style="list-style-type: none"> • The contrast between the subject and background is too high. This is not a malfunction.
A vertical band appears when you shoot a very bright subject.	<ul style="list-style-type: none"> • This is not a malfunction.
Some tiny white, red, blue or green spots appear on the display.	<ul style="list-style-type: none"> • Super NightShot or Color Slow Shutter is activated. This is not a malfunction.

Types of trouble and corrective action



Symptom	Cause and/or Corrective Actions
The picture flickers and the color changes incorrectly.	<ul style="list-style-type: none"> PROGRAM AE is set to soft portrait or sports lesson under the fluorescent lamp, the sodium lamp and the mercury lamp. → Cancel PROGRAM AE. (page 47)
An unknown picture is displayed on the LCD display.	<ul style="list-style-type: none"> If 10 minutes elapse after you set the mode dial to  (Movie) without a disc inserted, your camcorder automatically starts the demonstration. → Insert a disc and the demonstration stops. You can also cancel DEMO MODE. (page 113)
The picture is recorded in incorrect or unnatural colors.	<ul style="list-style-type: none"> NIGHTSHOT is set to ON. → Set it to OFF. (page 41)
The picture appears too bright, and the subject does not appear on the LCD display.	<ul style="list-style-type: none"> NIGHTSHOT is set to ON in a bright place. → Set it to OFF. (page 41) BACK LIGHT  is activated. → Deactivate it. (page 41)
The click of the shutter does not sound.	<ul style="list-style-type: none"> [BEEP] is set to [OFF] in  (OTHERS) in the SETUP display. → Set it to [MELODY] or [NORMAL]. (page 114)
Black bands appear when you record a TV or computer screen.	<ul style="list-style-type: none"> → Set [STEADYSHOT] to [OFF] in  (CAMERA SET) in the SETUP display. (page 110)
The recording stops.	<ul style="list-style-type: none"> The temperature of your camcorder is extremely high. → Turn off your camcorder and leave it for a while in a cool place.

During playback

Symptom	Cause and/or Corrective Actions
The playback button does not work.	<ul style="list-style-type: none"> There is no disc inserted in the camcorder. → Insert a disc. (page 26) The disc is inserted upside down. → Insert the disc correctly. The mode dial is set to  (Movie) or  (Still). → Set the mode dial to  (Play/Edit). The incompatible disc is inserted. → Check out the disc compatibility. (page 7) The disc recorded in other devices is inserted. → The disc recorded in other devices may not be played back on your camcorder.
The playback picture is distorted.	<ul style="list-style-type: none"> The disc may be dirty. → Clean the disc using the cleaning cloth (supplied). (page 133)
No sound or only a low sound is heard when playing back a disc.	<ul style="list-style-type: none"> The volume is turned to minimum. → Turn up the volume. (page 56) The LCD screen is closed. → Open the LCD screen. (page 19)



Types of trouble and corrective action

During recording and playback

Symptom	Cause and/or Corrective Actions
The power does not turn on.	<ul style="list-style-type: none"> The battery pack is not installed, or is exhausted or nearly exhausted. → Install a charged battery pack. (page 15) The AC adaptor is not connected to a wall outlet. → Connect the AC adaptor to a wall outlet. (page 18)
The battery pack is quickly discharged.	<ul style="list-style-type: none"> The operating temperature is too low. The battery pack is not fully charged. → Charge the battery pack fully again. (page 16) The battery pack is completely dead, and cannot be recharged. → Replace with a new battery pack. (page 15)
The battery remaining time indicator does not indicate the correct time.	<ul style="list-style-type: none"> You have used the battery pack in an extremely hot or cold environment for a long time. The battery pack is completely dead, and cannot be recharged. → Replace it with a new battery pack. (page 15) The battery pack is exhausted. → Install a fully charged battery pack. (page 15) A problem has occurred in the display of the remaining battery time. → Charge the battery pack fully again so that the indication on the remaining battery time indicator is correct. (page 16)
The power goes off although the remaining battery time indicator indicates that the battery pack has enough power to operate.	<ul style="list-style-type: none"> A problem has occurred in the display of the remaining battery time. → Charge the battery pack fully again so that the indication on the remaining battery time indicator is correct. (page 16) Battery pack performance decreases in low-temperature surroundings and recording may not be possible even though the battery time remaining may be as much as 20 minutes. → Recharge the battery pack fully. (page 16)
Remaining disc space indicator is not displayed.	<ul style="list-style-type: none"> The [REMAIN] item is set to [AUTO] in ETC (OTHERS) in the SETUP display. → Set it to [ON] to always display the remaining disc space indicator. (page 115)
Your camcorder vibrates.	<ul style="list-style-type: none"> Vibration occurs depending on the condition of the disc. This is not a malfunction.
The  indicator flashes.	<ul style="list-style-type: none"> Moisture condensation has occurred. → Turn off your camcorder and leave it for at least 30 minutes to acclimatize it. (page 130)
The  indicator flashes.	<ul style="list-style-type: none"> The temperature of your camcorder is extremely high. → Turn off your camcorder and leave it for a while in a cool place.

Types of trouble and corrective action

During editing

Symptom	Cause and/or Corrective Actions
The edit display is not displayed although you press EDIT.	<ul style="list-style-type: none">• The mode dial is set to  (Movie) or  (Still). → Set the mode dial to  (Play/Edit).• DVD-R is inserted. → DVD-R cannot be edited. Insert DVD-RW.• Inserted DVD-RW is formatted in VIDEO mode. → Format DVD-RW in VR mode. Note that all the recorded data are deleted if you format the disc.
Scenes cannot be registered to the Playlist.	<ul style="list-style-type: none">• The registered scenes exceeds 999. → Delete unnecessary scenes or register all the still images converting to a movie. (page 77, 78)• The remaining of the disc is empty. → Delete unnecessary scenes. (page 87)
A movie cannot be divided.	<ul style="list-style-type: none">• A too short movie cannot be divided.• Still images converted to a movie cannot be divided.• A movie protected on another device cannot be divided. → Cancel the protection of the movie on the device used to protect the movie.
A scene cannot be deleted.	<ul style="list-style-type: none">• A scene protected on another device cannot be deleted. → Cancel the protection of the scene on the device used to protect the scene.
Editing is disabled.	<ul style="list-style-type: none">• The temperature of your camcorder is extremely high. → Turn off your camcorder and leave it for a while in a cool place.• Another device is used for editing the disc. → Another device may not be able to edit the disc recorded on your camcorder.

Types of trouble and corrective action

Others

Symptom	Cause and/or Corrective Actions
The disc title cannot be changed.	<ul style="list-style-type: none">• The disc has been finalized. → Unfinalize the disc (DVD-RW only). You cannot record a disc title on a finalized DVD-R.• The disc title has been made by another device. → The disc title may not be changed on your camcorder if the disc title has been made by another device.
Still images cannot be converted to a movie.	<ul style="list-style-type: none">• When too many still images are recorded, the remaining of the disc is reduced and still images cannot be converted to a movie. → Delete unnecessary scenes in the disc. (page 87)
The Remote Commander supplied with your camcorder does not work.	<ul style="list-style-type: none">• [COMMANDER] is set to [OFF] in $\overline{\text{ETC}}$ (OTHERS) in the SETUP display. → Set it to [ON]. (page 114)• Something is blocking the infrared rays. → Remove the obstacle.• The batteries are inserted in the battery holder with the +/- polarities incorrectly matching the +/- marks. → Insert the batteries correctly. (page 142)• The batteries are dead. → Replace with new ones. (page 142)
The picture from a TV or VCR does not appear even when your camcorder is connected to output on the TV or VCR.	<ul style="list-style-type: none">• [DISPLAY] is set to [V-OUT/LCD] in $\overline{\text{ETC}}$ (OTHERS) in the SETUP display. → Set it to [LCD]. (page 114)• The Visual Index display is displayed. → Press VISUAL INDEX. (page 55)
The melody or beep sounds for 5 seconds.	<ul style="list-style-type: none">• Moisture condensation has occurred. → Turn off your camcorder and leave it for at least 30 minutes to acclimatize it. (page 130)• Some problems have occurred in your camcorder. → Remove the disc and insert it again, then operate your camcorder again.
No functions work although the power is on.	<ul style="list-style-type: none">→ Disconnect the power cord of the AC adaptor or remove the battery pack, then reconnect/install it after about one minute. Turn the power on. If the functions still do not work, open the LCD screen and press RESET using a sharp-pointed object. (If you press RESET, all the settings including the date and time return to their defaults.) (page 140)• The temperature of your camcorder is extremely high. → Turn off your camcorder and leave it for a while in a cool place.• Your camcorder was attacked a strong shock or vibration. → Your camcorder may be damaged. Contact your Sony dealer or local authorized Sony service facility.
Recording, editing, finalizing, unfinalizing, formatting or ejecting the disc do not work although the power is on.	<ul style="list-style-type: none">• The temperature of your camcorder is extremely high. → Turn off your camcorder and leave it for a while in a cool place.

Types of trouble and corrective action

Symptom	Cause and/or Corrective Actions
While charging the battery pack, POWER/CHG (Charge) lamp does not light.	<ul style="list-style-type: none"> • The battery charge is completed. • The battery pack is not properly installed. → Install it properly. (page 15)
You cannot charge the battery pack.	<ul style="list-style-type: none"> • The POWER switch is set to ON. → Slide it to OFF (CHG) while pressing the green button. (page 20)
While charging the battery pack, the POWER/CHG (Charge) lamp flashes.	<ul style="list-style-type: none"> • The battery pack is not properly installed. → Install it properly. (page 15) • Something is wrong with the battery pack. → If the symptom persists, disconnect the plug from the wall outlet as soon as possible to cut off the power, and contact your Sony dealer or local authorized Sony service facility.
Characters on the viewfinder turn over.	<ul style="list-style-type: none"> • When using the mirror mode, characters turn over on the viewfinder and on the TV monitor connected with the AUDIO/VIDEO jack. This is not a malfunction.
Image data cannot be transferred using the USB connection.	<ul style="list-style-type: none"> • The USB cable was connected before installation of the USB driver was completed. → Install the USB driver again. (page 97)
The disc cannot be ejected.	<ul style="list-style-type: none"> • The battery pack or the AC adaptor are not installed/connected. → Install/connect the power source correctly. • The battery pack is exhausted. → Install a charged battery pack. • The disc cover OPEN switch was not operated correctly. → Slide the disc cover OPEN switch, and after the Access/Open lamp lights in green, slide the switch again to open the disc cover. (page 26) • Moisture condensation has occurred. → Turn off your camcorder and leave it for at least 30 minutes to acclimatize it. (page 130) • The temperature of your camcorder is extremely high. → Turn off your camcorder and leave it for a while in a cool place. • Finalizing is interrupted by turning off your camcorder. → Turn on your camcorder and eject the disc after finalizing is completed.
Your camcorder gets hot during use for a long period.	<ul style="list-style-type: none"> • This is not a malfunction.
The disc cannot be recorded additionally on other devices.	<ul style="list-style-type: none"> • The disc recorded on your camcorder may not be recorded additionally on other devices.

Types of trouble and corrective action

During playback on other players

Symptom	Cause and/or Corrective Actions
Playback freezes for an instant between the scenes.	<ul style="list-style-type: none">• DVD players may freeze for an instant between the scenes if the speed of signal pickup and processing is inadequate.
Playback does not move to the previous scene when you press ⏮ .	<ul style="list-style-type: none">• If playback crosses 2 titles made automatically by your camcorder when ⏮ is pressed, playback may not move to the previous scene. → Select the desired scene by other means such as the menu screen.

Self-diagnosis display

Your camcorder has a self-diagnosis display function.

This function displays the current state of your camcorder as a 5-digit code (a combination of a letter and figures), on the LCD display or in the viewfinder. If a 5-digit code is displayed, check the following list of codes. The last two digits (indicated by □□) differ depending on the state of your camcorder.

LCD display or viewfinder

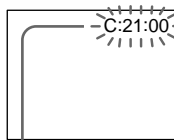

Self-diagnosis display

- C:□□:□□
You can service your camcorder yourself.
- E:□□:□□
Contact your Sony dealer or local authorized Sony service facility.

Five-digit display	Cause and/or Corrective Actions
C:04:□□	<ul style="list-style-type: none"> • You are using a battery pack that is not an "InfoLITHIUM" battery pack. → Use an "InfoLITHIUM" battery pack. (page 127)
C:13:□□	<ul style="list-style-type: none"> • The disc is faulty. → Use a compatible disc with your camcorder. (page 6)
C:21:□□	<ul style="list-style-type: none"> • Moisture condensation has occurred. → Turn off your camcorder and leave your camcorder for at least 30 minutes to acclimatize it. (page 130)
C:31:□□ C:32:□□	<ul style="list-style-type: none"> • A malfunction that you can service yourself other than those above has occurred. → Remove the disc and insert it again, then operate your camcorder again. → Disconnect the power cord of the AC adaptor or remove the battery pack. After reconnecting/reinstalling the power supply, operate your camcorder.
E:20:□□ E:61:□□ E:62:□□ E:93:□□ E:94:□□	<ul style="list-style-type: none"> • A malfunction that you cannot service has occurred. → Contact your Sony dealer or local authorized Sony service facility and inform them of the 5-digit code. (example: E:61:10)

If you are unable to rectify the problem even if you try the suggested corrective actions a few times, contact your Sony dealer or local authorized Sony service facility.

Warning indicators

If indicators appear on the LCD display or in the viewfinder, check the following:
See the page in parentheses “ () ” for more information.

100-0001 Warning indicator referring to a file

Slow flashing:

- The file is corrupted.
- The file is unreadable on your camcorder.



C:21:00 Self-diagnosis display (page 123)

Warning indicator referring to the disc

Slow flashing:

- A disc is not inserted.*
- The remaining time for recording movies is less than 5 minutes.
- The remaining amount of space for recording still images will be accommodated fewer than 20 images.
- The disc recorded in the different TV color system from your camcorder is inserted.*

Fast flashing:

- An unrecognizable disc is inserted.*
- A finalized disc is inserted in VIDEO mode when the mode dial is set to  (Movie) or  (Still).
- The disc is fully recorded.*
- A disc containing copy protection signals is inserted.*

You need to eject the disc*

Fast flashing:

- An unrecognizable disc is inserted.
- The disc is fully recorded.
- A disc containing copy protection signals is inserted.
- The disc recorded in the different TV color system from your camcorder is inserted.
- The disc recorded in the different regional code from your camcorder is inserted.

Warning indicator referring to the disc

Fast flashing:

- A disc that cannot be read or written is inserted, such as the single-sided disc inserted inside out.

The battery pack is dead or nearly dead

Slow flashing:

- The battery pack is exhausted.
Depending on the operating conditions, or the environment and battery condition, the  indicator may flash even if there are approximately 20 minutes remaining.

Fast flashing:

- The battery error occurs.

Moisture condensation has occurred*

Fast flashing:

- Moisture condensation has occurred with the disc.
Turn off your camcorder and leave it for at least 30 minutes to acclimatize it.

Warning indicator referring to the temperature rise

Fast flashing:

- The temperature of your camcorder is extremely high.*

Warning indicator referring to the flash (optional)

Slow flashing:





- The flash is charging.*

Fast flashing:

- There is a problem with the flash (optional).





* You hear the melody or beep sound.

Warning messages

Message	Cause and/or Corrective Actions
FOR "InfoLITHIUM" BATTERY ONLY	<ul style="list-style-type: none"> • Use an "InfoLITHIUM" battery pack.
	<ul style="list-style-type: none"> • Install a charged battery pack. • The battery pack is completely dead, and cannot be recharged. <ul style="list-style-type: none"> → Replace it with a new battery pack.
 *	<ul style="list-style-type: none"> • Moisture condensation has occurred. <ul style="list-style-type: none"> → Turn off your camcorder and leave it for at least 30 minutes to acclimatize it. (page 130)
 *	<ul style="list-style-type: none"> • The temperature of your camcorder is extremely high. <ul style="list-style-type: none"> → Turn off your camcorder and leave it for a while in a cool place.
REC DISABLE*	<ul style="list-style-type: none"> • A malfunction has occurred with the disc and you cannot record any movies or still images on the disc.
CAPACITY FULL FOR MOVIE*	<ul style="list-style-type: none"> • The disc is full for recording movies. <ul style="list-style-type: none"> → Use a new disc.
SCENE NUMBER FULL*	<ul style="list-style-type: none"> • Your camcorder can record up to 98 titles of movies in VIDEO mode and up to 999 chapters in VR mode per disc. • Your camcorder can record up to 9999 still images per disc.
COPY INHIBIT*	<ul style="list-style-type: none"> • Copyright protected movies and sounds cannot be recorded on your camcorder.
DISC PROTECTED*	<ul style="list-style-type: none"> • A disc protected on another device cannot be edited. <ul style="list-style-type: none"> → Cancel the protection of the disc on the device used to protect the disc.
EDIT DISABLE*	<ul style="list-style-type: none"> • A blank disc cannot be edited.
FINALIZED DISC, USE ANOTHER DISC*	<ul style="list-style-type: none"> • A finalized DVD-R cannot be recorded.
NEED TO UNFINALIZE*	<ul style="list-style-type: none"> • To record on the finalized DVD-RW in VIDEO mode, unfinalize it.
 NOW CHARGING*	<ul style="list-style-type: none"> • You cannot operate your camcorder during charging the flash.
 DISC ERROR*	<ul style="list-style-type: none"> • The incompatible disc with your camcorder is inserted. • Your camcorder cannot recognize the disc because of malfunctions such as scratches. • The disc is not set correctly. <ul style="list-style-type: none"> → Set the disc correctly. (page 26)
FORMAT ERROR*	<ul style="list-style-type: none"> • The disc recorded in the different format code from your camcorder. <ul style="list-style-type: none"> → Formatting the disc may enables you to use the disc on your camcorder (DVD-RW only).
ACCESS ERROR*	<ul style="list-style-type: none"> • An error occurred during reading or writing the disc.
RECOVERING DATA	<ul style="list-style-type: none"> • Your camcorder automatically recovers data when it is not recorded correctly. However, there are some situations in which some data cannot be recovered.

* You hear the beep sound when the message appears.

Warning messages

Message	Cause and/or Corrective Actions
NEED TO FORMAT DISC	<ul style="list-style-type: none">• The data cannot be recovered. → Format the disc (DVD-RW only).
CANNOT RECOVER DATA	<ul style="list-style-type: none">• The data cannot be recovered. → Use a new disc.
 CLOSE DISC COVER	<ul style="list-style-type: none">• The disc cover is open. → Close the disc cover.
  DISC FULL	<ul style="list-style-type: none">• The disc has run out of space. → Use a new disc.
 NO DISC	<ul style="list-style-type: none">• There is no disc inserted. → Insert a disc.• The disc is not set correctly. → Set the disc correctly. (page 26)

About the “InfoLITHIUM” battery pack

This unit is compatible with the “InfoLITHIUM” battery pack (M series). Your camcorder operates only with the “InfoLITHIUM” battery pack. “InfoLITHIUM” M series battery packs have the  mark.

What is the “InfoLITHIUM” battery pack?

The “InfoLITHIUM” battery pack is a lithium-ion battery pack that has functions for communicating information related to operating conditions between the battery pack and an AC adaptor/charger (optional). The “InfoLITHIUM” battery pack calculates the power consumption according to the operating conditions of your camcorder, and displays the remaining battery time in minutes.

With an AC adaptor/charger (optional), the remaining battery time and charging time are displayed.

Charging the battery pack

- Be sure to charge the battery pack before you start using your camcorder.
- It is recommended to charge the battery pack in an ambient temperature of between 10°C to 30°C (50°F to 86°F) until POWER/CHG (Charge) lamp turns off. If you charge the battery pack outside of this temperature range, you may not be able to efficiently charge the battery pack.
- After charging is completed, either disconnect the cable from the DC IN jack on your camcorder or remove the battery pack.

Effective use of the battery pack

- Battery pack performance decreases in low-temperature surroundings and recording may not be possible even though the battery time remaining may be as much as 20 minutes. We recommend the following to ensure longer battery pack use:
 - Put the battery pack in a pocket close to your body to warm it up, and insert it in your camcorder immediately before you start taking shots.
 - Use a large capacity battery pack (NP-FM70/QM71/QM71D/FM91/QM91/QM91D, optional).
- Frequently using the LCD screen or frequently operating playback, fast forward or backward wears out a battery pack faster. It is recommended that you use the large capacity battery pack (NP-FM70/QM71/QM71D/FM91/QM91/QM91D, optional).

- Be sure to slide the POWER switch to OFF (CHG) when not shooting or playing back on your camcorder. The battery pack is also consumed when your camcorder is in the standby mode or playback is paused.
- Have spare battery packs handy for two or three times the expected recording time, and make a trial recording on DVD-RW before the actual recording.
- Do not expose the battery pack to water. The battery pack is not water-resistant.

Remaining battery time indicator

- If the power goes off even though the remaining battery time indicator indicates that the battery pack has enough power to operate, charge the battery pack fully again so that the indication on the remaining battery time indicator is correct. Note, however, that the correct battery indication sometimes will not be restored if the battery is used in high temperatures for a long time or left in a fully charged state, or the battery pack is used frequently. Regard the remaining battery time indication as the approximate shooting time.
- The  mark indicating that there is little remaining battery time sometimes flashes depending on the operating conditions or ambient temperature and environment even if the remaining battery time is about 20 minutes.

How to store the battery pack

- If the battery pack is not used for a long time, perform the following procedure once per year to maintain proper battery function.
 1. Fully charge the battery pack.
 2. Discharge it using your camcorder.
 3. Remove the battery from the camcorder and store it in a dry, cool place.
- To use the battery pack up on your camcorder, leave your camcorder in the recording standby without a disc inserted with the [A. SHUT OFF] to [NEVER] in the  (SETUP MENU) in the SETUP display until the power goes off.

Battery life

- The battery life is limited. Battery capacity drops little by little as you use it more and more, and as time passes. When the available battery time is shortened considerably, a probable cause is that the battery pack has reached the end of its life. Buy a new battery pack.
- The battery life varies according to how it is stored, the operating conditions, and the environment in which each battery pack is used.

Glossary

Chapter

Sections of a movie created when START/STOP is pressed, and closed when START/STOP is pressed again. A list of chapters is displayed on the Visual Index display (page 55) when you play back the disc. Up to 999 chapters can be recorded on a single disc.

DVD

An optical disc format developed for multimedia use, such as recording movies and large amounts of data. An 8 cm disc is used in your camcorder. The data capacity of this disc is 1.4 GB in a single layer/single side disc.

DVD menu

When a disc recorded in VIDEO mode is finalized on your camcorder, a menu screen is provided similar to the Visual Index screen. You can use the menu for playback on other players that can play back DVD-R or DVD-RW.

DVD-Video

A format for recording movies. The picture data uses the MPEG 2 format, a standard of digital compression technology. Audio information is recorded in a multi-channel format, such as Dolby Digital, allowing you to enjoy a more realistic audio presence.

DVD-VR

A format simplified from the DVD-Video format with added functions, such as Playlists and editing. DVD-VR is an abbreviation for DVD-Video Recording. While the DVD-Video format is developed for recording package media, the DVD-VR format is developed for use on recording devices such as DVD recorders and DVD camcorders.

Finalize

A process to allow the disc recorded on your camcorder be compatible with other players. If you finalize DVD-Rs and DVD-RWs in VIDEO mode, the disc is compatible with the DVD-Video format, and you can play it back on a conventional DVD player. Note that once the VIDEO mode disc is finalized, you cannot record additional material on it (DVD-RWs can be unfinalized and you can record additional material).

Format

Generally, formatting is required of a disc before the use on any device. (You can use DVD-Rs without formatting them on your camcorder, however) Note that formatting deletes all the recorded data at once.

JPEG

A format for compression of graphic files developed by the Joint Photographic Experts Group, as a standard for variable level compressed color images. Still images are recorded in JPEG format on your camcorder.

MPEG

A format for compression of moving images such as film and video, developed by the Moving Pictures Experts Group, an industry committee. Your camcorder records movies in the MPEG 2 format, developed for encoding video and audio signals in high quality.

Playlist

A list used to edit the playback order of movies and still images. Because the Playlist does not affect the original data, you can change the playback order of desired scenes only.

Region code

Region code limits the regions in which a disc can be used. A region-coded disc will not play back on a different region-coded player. This disc coding cannot be changed by the consumer.

Title

Titles are created when recording movies in VIDEO mode. A title is closed when:

- you start shooting still images (page 34).
- you shoot movies by changing recording mode (page 33).
- you shoot movies by changing to the 16:9WIDE mode (page 45).
- you eject the disc (page 27).

Up to 98 titles can be recorded on a single disc. A title consists of chapters. Up to 999 chapters can be stored in a title.

Using your camcorder abroad

Using your camcorder abroad

You can use your camcorder with the AC adaptor supplied in any country or area with 100 V to 240 V AC, 50/60 Hz power standards.

Use a commercially available AC plug adaptor [a], if necessary, depending on the design of the wall outlet [b].

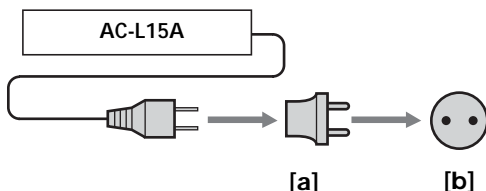

Your camcorder is an NTSC system-based camcorder. If you want to view the playback picture on a TV, it must be an NTSC system-based TV with the AUDIO/VIDEO input jack. The following lists show TV color systems used overseas.

NTSC system

Bahama Islands, Bolivia, Canada, Central America, Chile, Colombia, Ecuador, Guyana, Jamaica, Japan, Korea, Mexico, Peru, Surinam, Taiwan, the Philippines, the U.S.A., Venezuela, etc.

PAL system

Australia, Austria, Belgium, China, Czech Republic, Denmark, Finland, Germany, Holland, Hong Kong, Hungary, Italy, Kuwait, Malaysia, New Zealand, Norway, Poland, Portugal, Singapore, Slovak Republic, Spain, Sweden, Switzerland, Thailand, United Kingdom, etc.

PAL-M system

Brazil

PAL-N system

Argentina, Paraguay, Uruguay

SECAM system

Bulgaria, France, Guiana, Iran, Iraq, Monaco, Russia, Ukraine, etc.

Maintenance information and precautions

Moisture condensation

If your camcorder is brought directly from a cold place to a warm place, moisture may condense inside your camcorder, on the surface of the disc, or on the lens. This may cause a malfunction to your camcorder. If there is moisture inside your camcorder, the following indicator appears for 5 seconds.

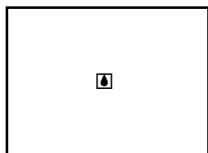

If moisture condensation has occurred

Turn off your camcorder, and leave it for about 30 minutes. You can use the camcorder if the  indicator does not appear when the power is turned on again.

Note on moisture condensation

Moisture may condense when you bring your camcorder from a cold place into a warm place (or vice versa) or when you use your camcorder in a hot place as follows:

- You bring your camcorder from a ski slope into a place warmed up by a heating device.
- You bring your camcorder from an air-conditioned car or room to a hot place outside.
- You use your camcorder after a squall or a shower.
- You use your camcorder in a hot and humid place.

How to prevent moisture condensation

When you bring your camcorder from a cold place into a warm place, put your camcorder in a plastic bag and tightly seal it. Remove the bag when the air temperature inside the plastic bag has reached the surrounding temperature (after about 30 minutes).

Precautions

Camcorder operation

- Operate your camcorder on 7.2 V (battery pack) or 8.4 V (AC adaptor) power.
- For DC or AC operation, use the accessories recommended in these operating instructions.
- If any solid object or liquid gets inside the casing, unplug your camcorder and have it checked by a Sony dealer before operating it any further.
- Avoid rough handling or mechanical shock. Be particularly careful of the lens.
- Keep the POWER switch set to OFF (CHG) when you are not using your camcorder.
- Do not wrap your camcorder with a towel, for example, and operate it. Doing so might cause heat to build up inside.
- Keep your camcorder away from strong magnetic fields or mechanical vibration.
- Do not touch the LCD screen with your fingers or a sharp-pointed object.
- If your camcorder is used in a cold place, a residual image may appear on the LCD screen. This is not a malfunction.
- While using your camcorder, the back of the LCD screen may heat up. This is not a malfunction.

Camcorder care

- Remove the disc when you do not intend to operate your camcorder for a while. Periodically turn on the power, operate the movie and still images functions and play back a disc for about three minutes if your camcorder is not to be used for a long time.

On placement

Regardless of whether it is in use or not, avoid leaving your camcorder in the following locations. Doing so may cause a malfunction.

- In locations subject to extremely high temperatures
Under the hot sun or inside a car when the windows are closed in summer, your camcorder may be subjected to too much heat, and this may cause the outer casing to lose its shape, or cause the camcorder to malfunction.
- Under direct sunlight or near a heater
This may cause the outer casing to lose its shape, or cause the camcorder to malfunction.

Maintenance information and precautions

- In locations subject to strong vibration
- In locations subject to strong magnetic fields
- In locations subject to strong electric wave and radio wave

The recording may not be done correctly.

- In sandy or dusty places

Do not let sand get into your camcorder.

When you use your camcorder on a sandy beach or in a dusty place, protect it from the sand or dust. Sand or dust may cause your camcorder to malfunction, and sometimes this malfunction cannot be repaired.

- Avoid exposing the viewfinder and the LCD screen to direct sunlight

The internal mechanisms of the viewfinder and the LCD screen may be damaged.

On the LCD screen

- Do not press the LCD screen firmly. Blurs appear and it causes a malfunction of the LCD screen.
- If fingerprints or dust make the LCD screen dirty, use the cleaning cloth (supplied) to clean the LCD screen.

When using the LCD Cleaning Kit (optional), do not pour the cleaning liquid directly on the LCD screen, but pour the liquid on a sheet of cleaning paper and wipe the LCD screen gently.

On cleaning the casing

Clean the camcorder body with a dry soft cloth, or a soft cloth lightly moistened with a mild detergent solution. Do not use any type of solvent such as the following which may damage the finish.

- thinner
- benzine
- alcohol
- chemical cloth
- volatile material like an insecticide

Do not leave the case in contact with rubber or vinyl objects for a long period of time

On the pickup lens

- Do not touch the lens inside the disc cover. Keep the disc cover closed except when inserting and ejecting the disc, to keep dust out.

Pickup lens

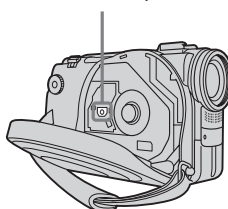

- When the camcorder does not work because the pickup lens is dirty, clean it with a blower (not supplied). Do not touch the pickup lens directly during cleaning because this may cause the camcorder to malfunction.

Care and storage of the lens

- Wipe the surface of the lens clean with a soft cloth in the following instances:
 - when there are fingerprints on the lens surface.
 - in hot or humid locations.
- To prevent mold from occurring, periodically perform the above. It is recommended to turn on and operate the video camera recorder about once per month to keep the video camera recorder in an optimum state for a long time.
- Store the lens in a well-ventilated location subject to little dirt or dust.

AC adaptor

- Unplug the unit from the wall outlet when you are not using it for a long time. To disconnect the power cord, pull it out by the plug. Never pull the power cord itself.
- Do not operate the unit with a damaged cord or if the unit has been dropped or damaged.
- Do not bend the power cord forcibly, or place a heavy object on it. This will damage the cord and may cause fire or electric shock.
- Prevent metallic objects from coming into contact with the metal parts of the connecting section. If this happens, a short may occur and the unit may be damaged.
- Always keep metal contacts clean.
- Do not disassemble the unit.
- Do not apply mechanical shock or drop the unit.
- While the unit is in use, particularly during charging, keep it away from AM receivers and video equipment. AM receivers and video equipment disturb AM reception and video operation.
- The unit becomes warm during use. This is not a malfunction.
- Do not place the unit in locations that are:
 - extremely hot or cold
 - dusty or dirty
 - very humid
 - vibrating

Rechargeable battery pack

- Use only the specified charger or video equipment with the charging function.
- To prevent an accident from a short circuit, do not allow metal objects to come into contact with the battery terminals.
- Keep the battery pack away from fire.
- Never expose the battery pack to temperatures above 60°C (140°F), such as in a car parked in the sun or under direct sunlight.
- Keep the battery pack dry.
- Do not expose the battery pack to any mechanical shock.
- Do not disassemble or modify the battery pack.
- Attach the battery pack to the video equipment securely.

Charging the built-in rechargeable battery in your camcorder

The built-in rechargeable battery is installed in your camcorder to retain the date and time, etc., regardless of the setting of the POWER switch. The built-in rechargeable battery is always charged as long as you are using your camcorder. The battery, however, will become discharged gradually if you do not use your camcorder. It will be completely discharged in about three months if you do not use your camcorder at all. Even if the built-in rechargeable battery is not charged, it will not affect camcorder operation. To retain the date, time, and other information, charge the battery if it is discharged.

Charging the built-in rechargeable battery:

- Connect your camcorder to a wall outlet using the AC adaptor supplied with your camcorder, and leave your camcorder with the POWER switch turned off for more than 24 hours.
- Or, install a fully charged battery pack in your camcorder, and leave your camcorder with the POWER switch turned off for more than 24 hours.

Notes on dry batteries

To avoid possible damage from battery leakage or corrosion, observe the following:

- Be sure to insert the batteries with the + and – correctly matching the + and – terminals inside the battery compartment.
- Dry batteries are not rechargeable.
- Do not use a combination of new and old batteries.
- Do not use different types of batteries.
- Current flows from batteries when you are not using them for a long time.
- Do not use leaking batteries.

If batteries are leaking

- Wipe off the liquid in the battery compartment carefully before replacing the batteries.
- If you touch the liquid, wash it off with water.
- If the liquid gets into your eyes, wash your eyes with a lot of water and then consult a doctor immediately.

If any problem occurs, unplug your camcorder and contact your nearest Sony dealer.

Maintenance information and precautions

Maintenance information

Cleaning the viewfinder

- 1 ① Extend the viewfinder.
- 2 ② Remove the screws on the side and bottom of the viewfinder.
- 3 ③ Remove the eye-cup.

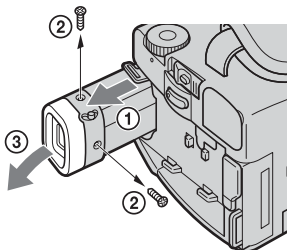

Note

Take care not to lose or bend the shaft of the eye-cup.

- 2 Remove the dust inside the eye-cup and the viewfinder with a commercially available blower.
- 3 Attach the eye-cup on the viewfinder reversing the process in step 1.

Caution

Do not remove any other screws. You may remove only the screw to remove the eyecup.

Notes on disc handling

- Use only round-shaped discs. If you use a special shaped disc (e.g. star-shaped or heart-shaped etc.), your camcorder may be damaged.
- Hold the disc at the edges while supporting the center hole lightly. Do not touch the recordable side (the reverse of the printed side) of a disc.



- Do not attach any material on the surface of a disc. This causes a nonuniform rotating speed, which may cause the camcorder to malfunction.
- Do not expose the disc to direct sunlight or to the humid place.
- After recording/playing, store the disc in its case.
- If the disc is dirty with fingerprints or dust, it may lessen the quality of the audio and video output.
- Clean the disc with a supplied cleaning cloth. Wipe the disc from the center out. For dirt, clean the disc with a soft cloth slightly moistened with water. Then remove the moisture with a soft, dry cloth.



- Do not use solvents such as benzine, cleaners intended for vinyl LPs or antistatic spray, as they may cause a malfunction to the disc.
- You can write only on the label surface of a disc. Write using only an oil-based felt-tip marker and do not touch the ink until dry. Do not heat the disc or use a sharp-pointed tool, such as a ballpoint pen. Do not dry the surface by heating.

Specifications

Video camera recorder

System

Video recording format

DVD-Video

DVD-VR (DVD-RW only)

Audio recording system

2ch Dolby* Digital

Video signal

NTSC color, EIA standards

Usable discs

8 cm DVD-R and DVD-RW

Video compression format

MPEG2/JPEG (Still images)

Recording/playback time

HQ: Approx. 20 minutes

SP: Approx. 30 minutes

LP: Approx. 60 minutes

Viewfinder

Electric viewfinder (color)

Image device

DCR-DVD100:

4.5 mm (1/4 type) CCD (Charge

Coupled Device)

Number of Pixels

Gross: Approx. 680 000 pixels

Effective :

Approx. 340 000 pixels

DCR-DVD200:

3.8 mm (1/4.7 type) CCD (Charge

Coupled Device)

Number of Pixels

Gross: Approx. 1 070 000 pixels

Effective (for still images):

Approx. 1 000 000 pixels

Effective (for movies):

Approx. 690 000 pixels

DCR-DVD300:

3.8 mm (1/4.7 type) CCD (Charge

Coupled Device)

Number of Pixels

Gross: Approx. 1 070 000

Effective (for still images):

Approx. 1 000 000 pixels

Effective (for movies):

Approx. 690 000 pixels

* Manufactured under license from Dolby Laboratories.

"Dolby" and the double-D symbol are trademarks of Dolby Laboratories.

Lens

Carl Zeiss

Combined power zoom lens

Filter diameter:

30 mm (1 3/16 in.)

10× (Optical), 120× (Digital)

DCR-DVD100:

F = 1.7 - 2.2

DCR-DVD200/DVD300:

F = 1.8 - 2

Focal length

DCR-DVD100

3.3 - 33 mm (5/32 - 1 5/16 in.)

When converted to a 35 mm still

camera

42 - 420 mm (1 11/16 - 16 5/8 in.)

DCR-DVD200/DVD300:

3.7 - 37 mm (5/32 - 1 1/2 in.)

When converted to a 35 mm still

camera

For movies:

50 - 500 mm (2 - 19 3/4 in.)

For still images:

42 - 420 mm (1 11/16 - 16 5/8 in.)

Color temperature

Auto, HOLD (Hold),  Indoor

(3 200 K),  Outdoor (5 800 K)

Minimum illumination

DCR-DVD100:

5 lx (lux) (F 1.7)

0 lx (lux) (in the NightShot mode)*

DCR-DVD200/DVD300:

7 lx (lux) (F 1.8)

0 lx (lux) (in the NightShot mode)*

* Objects unable to be seen due to the dark can be shot with infrared lighting.

Input/Output connectors

S video input/output

4-pin mini DIN

Luminance signal: 1 Vp-p, 75 Ω

(ohms), unbalanced

Chrominance signal: 0.286 Vp-p,

75 Ω (ohms), unbalanced

Audio/Video input/output

AV MINI JACK, 1 Vp-p, 75 Ω

(ohms), unbalanced, sync negative

327 mV, (at output impedance of

more than 47 kΩ (kilohms))

Output impedance of less than 2.2

kΩ (kilohms)/Stereo minijack (ø

3.5 mm)

Input impedance of more than

47 kΩ (kilohms)

USB jack

mini-B

Control jack

Stereo mini-minijack (ø 2.5 mm)

MIC jack

Stereo minijack (ø 3.5 mm)

LCD screen

Picture

DCR-DVD100/DVD200:

6.2 cm (2.5 type)

DCR-DVD300:

8.8 cm (3.5 type)

Total number of pixels

123 200 (560 × 220)

General

Power requirements

7.2 V (battery pack)

8.4 V (AC adaptor)

Average power consumption

(when using the battery pack)

During camera recording using

LCD

DCR-DVD100: 6.5 W

DCR-DVD200: 7.0 W

DCR-DVD300: 7.2 W

Viewfinder

DCR-DVD100: 5.5 W

DCR-DVD200/DVD300: 6.0 W

Operating temperature

0°C to 40°C (32°F to 104°F)

Storage temperature

-20°C to +60°C

(-4°F to +140°F)

Dimensions (Approx.)

DCR-DVD100/DVD200:

66 × 94 × 142 mm

(2 5/8 × 3 3/4 × 5 5/8 in.)

(w/h/d)

DCR-DVD300:

79 × 94 × 142 mm

(3 1/8 × 3 3/4 × 5 5/8 in.)

(w/h/d)

Mass (approx.)

DCR-DVD100

640 g (1 lb 6 oz)

main unit only

730 g (1 lb 9 oz)

including the battery pack,

disc and lens cap

DCR-DVD200

650 g (1 lb 6 oz)

main unit only

740 g (1 lb 10 oz)

including the battery pack,

disc and lens cap

DCR-DVD300

710 g (1 lb 9 oz)

main unit only

800 g (1 lb 12 oz)

including the battery pack,

disc and lens cap

Supplied accessories

See page 14.

Specifications

AC adaptor AC-L15A

Power requirements

100 – 240 V AC, 50/60 Hz

Current consumption

0.35 – 0.18 A

Power consumption

18 W

Output voltage

DC OUT: 8.4 V, 1.5 A in the operating mode

Operating temperature

0°C to 40°C (32°F to 104°F)

Storage temperature

-20°C to + 60°C (-4°F to + 140°F)

Dimensions (approx.)

56 × 31 × 100 mm

(2 1/4 × 1 1/4 × 4 in.) (w/h/d)

excluding projecting parts

Mass (approx.)

190 g (6.7 oz)

excluding power cord

Rechargeable battery pack NP-FM50

Maximum output voltage

DC 8.4 V

Output voltage

DC 7.2 V

Capacity

8.5 Wh (1 180 mAh)

Dimensions (approx.)

38.2 × 20.5 × 55.6 mm

(1 9/16 × 13/16 × 2 1/4 in.)

(w/h/d)

Mass (approx.)

76 g (2.7 oz)

Operating temperature

0°C to 40°C (32°F to 104°F)

Type

Lithium ion

Design and specifications are subject to change without notice.

Identifying parts and controls

Camcorder

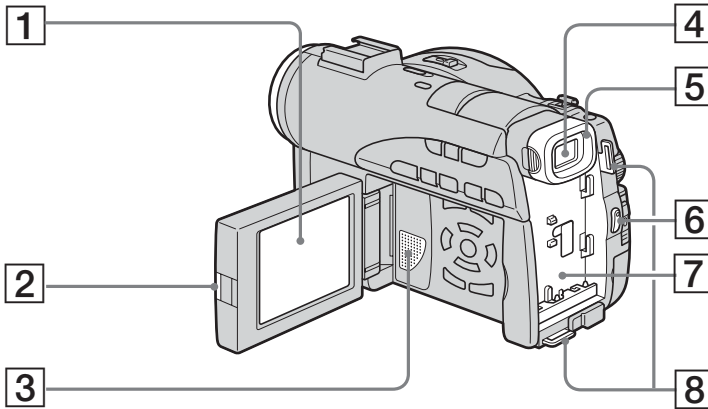

1 LCD screen (page 19)

2 OPEN button (page 19)

3 Speaker

4 Viewfinder (page 25)

5 Eye cup (page 133)

6 START/STOP button (page 29)

7 Battery attachment (page 15)

8 Hooks for shoulder strap

Note on the Carl Zeiss lens

Your camcorder is equipped with a Carl Zeiss lens which can reproduce fine images. The lens for your camcorder was developed jointly by Carl Zeiss, in Germany, and Sony Corporation. It adopts the MTF* measurement system for video cameras and offers the same quality as a Carl Zeiss lens.

* MTF stands for Modulation Transfer Function.

The value number indicates the amount of light from a subject coming into the lens.

Identifying parts and controls

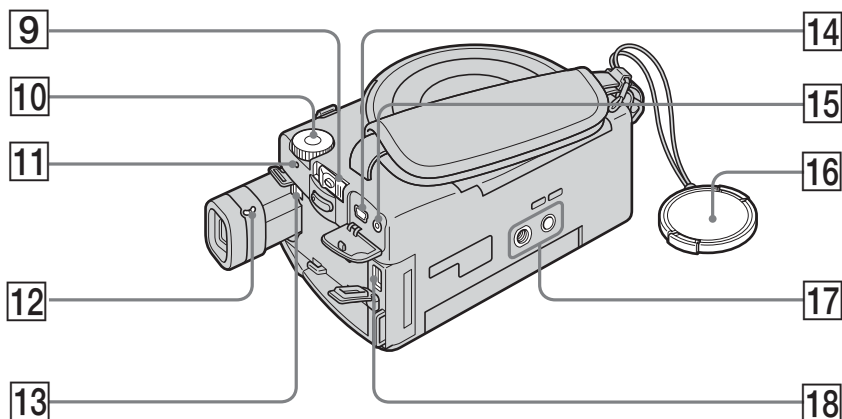

9 POWER switch (page 20)

10 Mode dial (page 26)

11 POWER/CHG lamp (page 16)

12 Viewfinder lens adjustment lever
(page 25)

13 BATT (battery) release button
(page 15)

14 Ψ (USB) jack (page 92)

15 REMOTE jack

16 Lens cap (page 29)

17 Tripod receptacle

Make sure that the length of the tripod screw is less than 5.5 mm (7/32 inch). Otherwise, you cannot attach the tripod securely, and the screw may damage your camcorder.

18 DC IN jack (page 16)

Identifying parts and controls

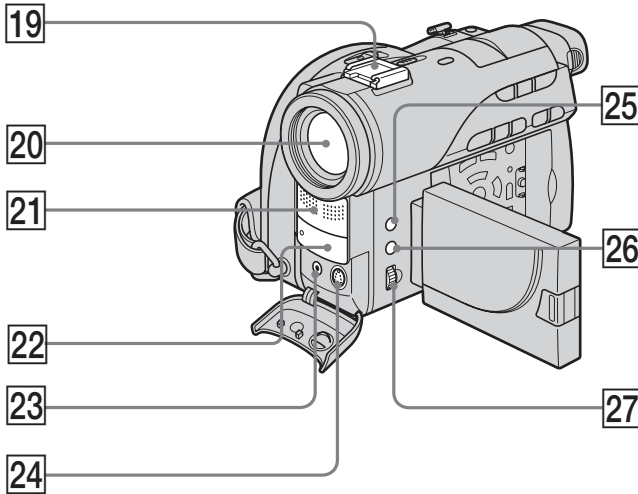

19 Intelligent accessory shoe

20 Lens

21 Microphone

22 Remote sensor/Infrared ray emitter

23 AUDIO/VIDEO jack (page 62)

24 S VIDEO jack (page 62)

25 EXPOSURE button (page 48)

26 FOCUS button (page 49)

27 Adjustment dial (page 48, 49)



Notes on the intelligent accessory shoe

- The intelligent accessory shoe supplies power to optional accessories such as a video light or microphone.
- The intelligent accessory shoe is linked to the POWER switch, allowing you to turn the power supplied by the shoe on and off. Refer to the operating instructions of the accessory for further information.
- The intelligent accessory shoe has a safety device for fixing the installed accessory securely. To connect an accessory, press down and push it to the end, and then tighten the screw.
- To remove an accessory, loosen the screw, and then press down and pull out the accessory.
- You cannot use the Flash/Video Light, IR/Video Light or Video Light with your camcorder.

Identifying parts and controls

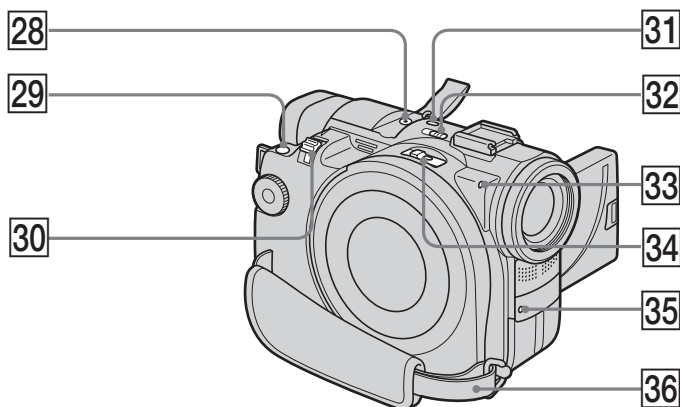

- | | |
|--|---|
| 28 MIC (PLUG IN POWER) jack
Connect an external microphone (optional). This jack also accepts a “plug-in-power” microphone. When an external microphone is connected, it is preferred for an audio input source. | 31 SUPER NS/COLOR SLOW S button
(page 41) |
| 29 PHOTO button (page 34) | 32 NIGHTSHOT switch (page 41) |
| 30 Power zoom lever (page 32) | 33 Access/Open lamp (page 26) |
| | 34 Disc cover OPEN switch (page 26) |
| | 35 Recording lamp (page 29) |
| | 36 Grip belt (page 28) |

Attaching the shoulder strap

Attach the shoulder strap supplied with your camcorder to the hooks for the shoulder strap.

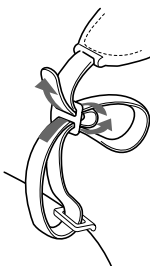

Identifying parts and controls

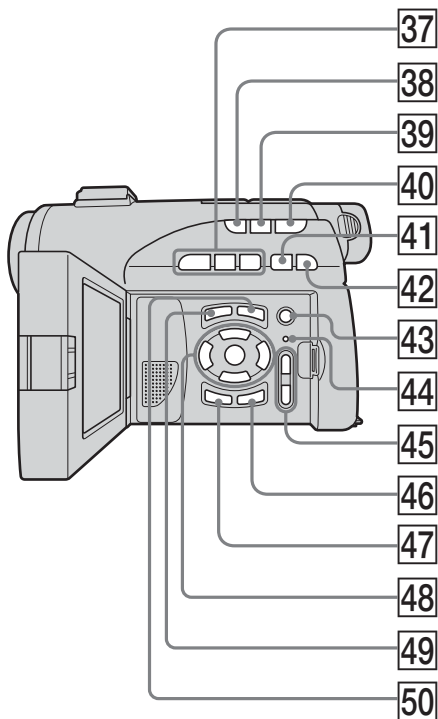

37 Disc control buttons (page 55)

▶ **PLAY** (playback) button

▬▬ **PAUSE** button

■ **STOP** button

38 **BACK LIGHT** button (page 41)

39 **FADER** button (page 50)

40 **REVIEW** button (page 53)

41 ◀◀ **PREV** (previous) button (page 57)

42 ▶▶ **NEXT** (next) button (page 57)

43 ● **REC** button (page 107)

44 **RESET** button

45 **VOL** buttons (page 56)

46 **DISPLAY/BATT INFO** button (page 18)

47 **EDIT** button (page 53)

48 ◀/▲/▼/▶/**ENTER** buttons (page 21)

49 **VISUAL INDEX** button (page 55)

50 **SETUP** button (page 21)

Identifying parts and controls

Remote Commander

The buttons that have the same name on the Remote Commander as on your camcorder function identically to the buttons on your camcorder.

1

2

3

4

5

6

7

8

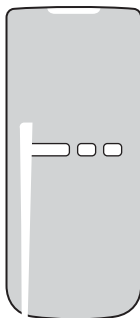

9

10

11

12

13

14

15

16

17

18

1 Transmitter

2 PHOTO button (page 34)

3 ◀|||/|||▶ STEP buttons (page 57)

4 ◀◀ PREV/▶▶ NEXT buttons (page 57)

5 ▷ PLAY button (page 55)

6 VISUAL INDEX button (page 55)

7 EDIT button (page 53)

8 ◀/▲/▼/▶/ENTER buttons (page 21)

9 DATA CODE button (page 58)

10 REC buttons (page 107)

11 START/STOP button (page 29)

12 REVIEW button (page 53)

13 Power zoom buttons (page 32)

14 ◀◀|◀/▶/▶▶ SCAN/SLOW buttons (page 57)

15 ■ STOP button (page 55)

16 || PAUSE button (page 57)

17 SETUP button (page 21)

18 DISPLAY button (page 58)

Identifying parts and controls

To prepare the Remote Commander

Insert 2 size AA (R6) batteries by matching the + and - on the batteries to the + and - terminals in the battery compartment.

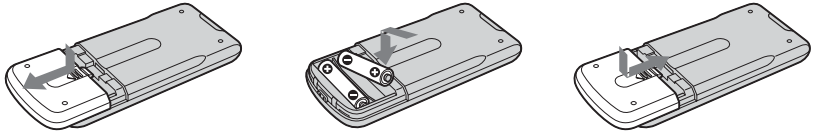

Notes

On the Remote Commander

- Point the remote sensor away from strong light sources such as direct sunlight or overhead lighting. Otherwise, the Remote Commander may not function properly.
- Your camcorder works in the DVD 2 Commander mode. Commander modes 1, 2 and 3 are used to distinguish your camcorder from other Sony DVD players to avoid erroneous remote control operation. If you use another Sony DVD player in the DVD 2 Commander mode, it is recommended that you change the Commander mode of the DVD player or cover the sensor of the DVD player with black paper.

Identifying parts and controls

Operation indicators

LCD display and viewfinder

On shooting

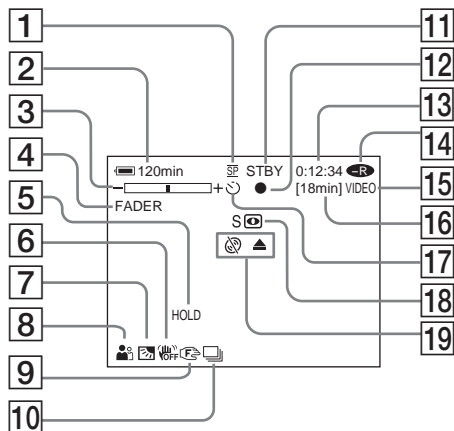

- 1 Recording mode (page 33, 112), Image size (page 38, 110)
- 2 Remaining battery time (page 18)
- 3 Zoom (page 60), Exposure (page 48)
- 4 FADER (page 50), 16:9WIDE (page 45), Effect (page 51)
- 5 White balance (page 44, 109)
- 6 SteadyShot off (page 110)
- 7 Backlight (page 41)
- 8 PROGRAM AE (page 47, 109), Volume (page 56), Date (page 58), Time (page 58)
- 9 Manual focus (page 49)
- 10 Burst (page 39, 110), Video flash ready (page 109), Reducing red-eye phenomenon (page 109)
- 11 STBY, REC (page 29), Image quality (page 37, 110)
- 12 AE/AF lock (page 35)
- 13 Counter, Number of recorded still images, Self-diagnosis (page 123)

On playback

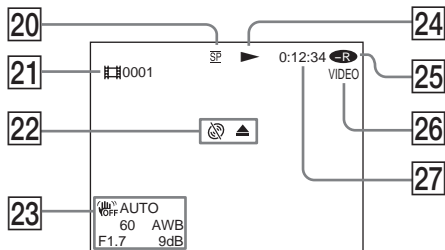

- 14 Disc type (page 6)
- 15 Recording format (page 7)
- 16 Remaining time (page 115), Recordable number of still images (page 40)
- 17 Self-timer (page 43)
- 18 NIGHTSHOT, SUPER NIGHTSHOT, COLOR SLOW SHUTTER (page 41)
- 19 Warning (page 124, 125)
- 20 Recording mode (page 33, 112), Image size (page 38, 110)
- 21 Scene number (page 56), File number (page 112)
- 22 Warning (page 124, 125)
- 23 Data code (page 58), Date and time (page 31, 58)
- 24 Playback mode (page 57)
- 25 Disc type (page 6)
- 26 Recording format (page 7)
- 27 Counter, Number of played back still images/Number of recorded still images, Self-diagnosis (page 123)

Index

A, B

AC adaptor	16
Adjusting viewfinder	25
A/V connecting cable	14, 62
BACK LIGHT	41
BATTERY INFO	18
Battery pack	15
BEACH & SKI	47
Beep	26, 43, 114
BURST	39
B & W	51

C, D

Charging the battery	16
Charging the built-in rechargeable battery	132
Clock set	21
Color slow shutter	42
Continuous still images shooting	39
Counter	31
Data code	58
Date/time display	31, 58
Daylight saving time	21, 114
DEMO	113
Digital effect	51
Digital zoom	32
Disc dubbing	100
Disc title	54
Disc type	6
DISPLAY	58
Divide	82, 85
DVD-R	6
DVD-RW	6

E

EXP BRKTG	39
EXPOSURE	48

F, G, H

FADER	50
Fade in/out	50
Finalize	63
FINE	37
Flash	109
Folder	69
FOCUS	49
Format	72
Full charge	16
Grip belt	28
HiFi SOUND	114
HQ	33

I, J, K, L

ImageMixer	91, 98
Image quality	37, 110
Image size	38, 110
"InfoLITHIUM" battery	127
Infrared ray emitter	41
Intelligent accessory shoe	138
JPEG	40, 128
LANDSCAPE	47
LCD screen	19
LP	33
LUMI. (Luminance key)	51

M, N

Manual focus	49
MIC (PLUG IN POWER) jack	139
Mirror mode	43
Moisture condensation	130
MOSAIC	51
Move	80
MPEG	128
NIGHTSHOT	41
NORMAL	39, 109, 110
NTSC system	12, 92, 129

O, P, Q

OLD MOVIE	51
Operation indicators	143
OVERLAP	50
PASTEL	51
PB ZOOM	60
Photomovie	64, 77
Picture effect	51
Picture search	57
Playback pause	57
Playing time	17
Playlist	74
PORTRAIT	47
PROGRAM AE	47

R

Recording format	7
Recording mode	33
Recording time	17
Remaining battery time indicator	31
Remaining time	115
Remote Commander	141
REMOTE jack	137
RESET	112, 140
Review	53

S

Self-diagnosis display	123
Self-timer recording	43, 110
SEPIA	51
SETUP display	108
Shoulder strap	136, 139
Slide show	61
Slow playback	57
SP	33
SPORTS	47
SPOTLIGHT	47
STANDARD	37
STEADYSHOT	110
SUNSET MOON	47
SUPER NIGHTSHOT	42
S video jack	62, 105

T, U, V

Telephoto	32
Time difference	23
Title	54
TV	45, 62, 107
TV color systems	12, 129
Unfinalize	70
USB jack	92
VCR	105
VIDEO mode	7
Viewfinder	25, 133
Viewfinder lens adjustment ..	25
Visual Index	55
VR mode	7

W, X, Y, Z

Warning indicators	124
Warning messages	125
White balance	44
Wide-angle	32
Wide mode	45
WIPE	50
Zoom	32, 60

On trademarks

- DVD-VIDEO, DVD-RW, and the DVD-R logo are trademarks.
- InfoLITHIUM is a trademark of Sony Corporation.
- PlayStation is a registered trademark of Sony Computer Entertainment Inc.
- Microsoft and Windows are trademarks or registered trademarks of Microsoft Corporation in the United States and/or other countries.
- Pentium is a trademark or a registered trademark of Intel Corporation.
- Macintosh is a trademark or registered trademark of Apple Computer, Inc.
- All other trademarks are trademarks of their respective owners.

<http://www.sony.net/>



Printed on 100% recycled paper using VOC
(Volatile Organic Compound)-free vegetable
oil based ink.

