

## Digital HD Video Camera Recorder

### Operating Guide

Table of contents

Getting started

Recording/Playback

Advanced operations

Saving movies and photos  
with a computer

Saving images with an  
external device

Customizing your camcorder

Additional information

Quick reference



**HANDYCAM**

**AVCHD**

**HDMI™**  
HIGH DEFINITION MULTIMEDIA INTERFACE

  
MEMORY STICK™

 InfoLITHIUM™  
V SERIES

  
CLASS C

  
NAVTEQ  
MAPS

# Read this first

Before operating the unit, please read this manual thoroughly, and retain it for future reference.

## WARNING

**To reduce fire or shock hazard, do not expose the unit to rain or moisture.**

**Do not expose the batteries to excessive heat such as sunshine, fire or the like.**

## CAUTION

### Battery pack

If the battery pack is mishandled, the battery pack can burst, cause a fire or even chemical burns. Observe the following cautions.

- Do not disassemble.
- Do not crush and do not expose the battery pack to any shock or force such as hammering, dropping or stepping on it.
- Do not short circuit and do not allow metal objects to come into contact with the battery terminals.
- Do not expose to high temperature above 60°C (140°F) such as in direct sunlight or in a car parked in the sun.
- Do not incinerate or dispose of in fire.
- Do not handle damaged or leaking lithium ion batteries.
- Be sure to charge the battery pack using a genuine Sony battery charger or a device that can charge the battery pack.
- Keep the battery pack out of the reach of small children.
- Keep the battery pack dry.
- Replace only with the same or equivalent type recommended by Sony.
- Dispose of used battery packs promptly as described in the instructions.

Replace the battery with the specified type only. Otherwise, fire or injury may result.

### AC Adaptor

Do not use the AC Adaptor placed in a narrow space, such as between a wall and furniture.

Use the nearby wall outlet (wall socket) when using the AC Adaptor. Disconnect the AC Adaptor from the wall outlet (wall socket) immediately if any malfunction occurs while using your camcorder.

Even if your camcorder is turned off, AC power source (mains) is still supplied to it while connected to the wall outlet (wall socket) via the AC Adaptor.



### Note on the power cord (mains lead)

The power cord (mains lead) is designed specifically for use with this camcorder only, and should not be used with other electrical equipment.

Excessive sound pressure from earphones and headphones can cause hearing loss.

### Notice for customers in the United Kingdom

A moulded plug complying with BS 1363 is fitted to this equipment for your safety and convenience.

Should the fuse in the plug supplied need to be replaced, a fuse of the same rating as the supplied one and approved by ASTA or BSI to BS 1362, (i.e., marked with an  or  mark) must be used. If the plug supplied with this equipment has a detachable fuse cover, be sure to attach the fuse cover after you change the fuse. Never use the plug without the fuse cover. If you should lose the fuse cover, please contact your nearest Sony service station.

## FOR CUSTOMERS IN EUROPE



Hereby, Sony Corporation, declares that this HDR-CX560VE/CX700VE Digital HD Video Camera Recorder is in compliance with the essential requirements and other relevant provisions of the Directive 1999/5/EC. For details, please access the following URL: <http://www.compliance.sony.de/>

### Notice for the customers in the countries applying EU Directives

The manufacturer of this product is Sony Corporation, 1-7-1 Konan Minato-ku Tokyo, 108-0075 Japan. The Authorized Representative for EMC and product safety is Sony Deutschland GmbH, Hedelfinger Strasse 61, 70327 Stuttgart, Germany. For any service or guarantee matters please refer to the addresses given in separate service or guarantee documents.

### ATTENTION

The electromagnetic fields at the specific frequencies may influence the picture and sound of this unit.

This product has been tested and found compliant with the limits set out in the EMC Directive for using connection cables shorter than 3 meters (9.8 feet).

### Notice

If static electricity or electromagnetism causes data transfer to discontinue midway (fail), restart the application or disconnect and connect the communication cable (USB, etc.) again.



**Disposal of Old Electrical & Electronic Equipment (Applicable in the European Union and other European countries with separate collection systems)**

This symbol on the product or on its packaging indicates that this product shall not be treated as household waste. Instead it shall be handed over to the applicable collection point for the recycling of electrical and electronic equipment. By ensuring this product is disposed of correctly, you will help prevent potential negative consequences for the environment and human health, which could otherwise be caused by inappropriate waste handling of this product. The recycling of materials will help to conserve natural resources. For more detailed information about recycling of this product, please contact your local Civic Office, your household waste disposal service or the shop where you purchased the product.



**Disposal of waste batteries (applicable in the European Union and other European countries with separate collection systems)**

This symbol on the battery or on the packaging indicates that the battery provided with this product shall not be treated as household waste. On certain batteries this symbol might be used in combination with a chemical symbol. The chemical symbols for mercury (Hg) or lead (Pb) are added if the battery contains more than 0.0005% mercury or 0.004% lead. By ensuring these batteries are disposed of correctly, you will help prevent potentially negative consequences for the environment and human health which could otherwise be caused by inappropriate waste handling of the battery. The recycling of the materials

will help to conserve natural resources. In case of products that for safety, performance or data integrity reasons require a permanent connection with an incorporated battery, this battery should be replaced by qualified service staff only. To ensure that the battery will be treated properly, hand over the product at end-of-life to the applicable collection point for the recycling of electrical and electronic equipment.

For all other batteries, please view the section on how to remove the battery from the product safely. Hand the battery over to the applicable collection point for the recycling of waste batteries.

For more detailed information about recycling of this product or battery, please contact your local Civic Office, your household waste disposal service or the shop where you purchased the product.

### **For customers in the U.S.A.**

If you have any questions about this product, you may call:  
Sony Customer Information Center 1-800-222-SONY (7669).  
The number below is for the FCC related matters only.

## **Regulatory Information**

### **Declaration of Conformity**

Trade Name: SONY  
Model No.: HDR-CX700E  
Responsible Party: Sony Electronics Inc.  
Address: 16530 Via Esprillo, San Diego, CA 92127 U.S.A.  
Telephone No.: 858-942-2230  
This device complies with Part 15 of the FCC Rules. Operation is subject to the following two conditions: (1) This device may not cause harmful interference, and (2) this device must accept any interference received, including interference that may cause undesired operation.

### **Declaration of Conformity**

Trade Name: SONY  
Model No.: HDR-CX560E  
Responsible Party: Sony Electronics Inc.  
Address: 16530 Via Esprillo, San Diego, CA 92127 U.S.A.  
Telephone No.: 858-942-2230  
This device complies with Part 15 of the FCC Rules. Operation is subject to the following two conditions: (1) This device may not cause harmful interference, and (2) this device must accept any interference received, including interference that may cause undesired operation.

## **CAUTION**

You are cautioned that any changes or modifications not expressly approved in this manual could void your authority to operate this equipment.

## Note

This equipment has been tested and found to comply with the limits for a Class B digital device, pursuant to Part 15 of the FCC Rules.

These limits are designed to provide reasonable protection against harmful interference in a residential installation. This equipment generates, uses, and can radiate radio frequency energy and, if not installed and used in accordance with the instructions, may cause harmful interference to radio communications. However, there is no guarantee that interference will not occur in a particular installation. If this equipment does cause harmful interference to radio or television reception, which can be determined by turning the equipment off and on, the user is encouraged to try to correct the interference by one or more of the following measures:

- Reorient or relocate the receiving antenna.
- Increase the separation between the equipment and receiver.
- Connect the equipment into an outlet on a circuit different from that to which the receiver is connected.
- Consult the dealer or an experienced radio/TV technician for help.

The supplied interface cable must be used with the equipment in order to comply with the limits for a digital device pursuant to Subpart B of Part 15 of FCC Rules.

## Battery pack

This device complies with Part 15 of the FCC Rules. Operation is subject to the following two conditions: (1) This device may not cause harmful interference, and (2) this device must accept any interference received, including interference that may cause undesired operation.

## Supplied items

The numbers in ( ) are the supplied quantity.

- AC Adaptor (1)
- Power cord (Mains lead) (1)
- Component A/V cable (1) **A**
- A/V connecting cable (1) **B**
- USB connection support cable (1) **C**  
Use this cable when the Built-in USB Cable of the camcorder (p. 12) is too short for connection.
- Lens hood (1) (Only for HDR-CX690E/CX700E/CX700VE) **D**  
To attach the lens hood, see page 74.
- Wireless Remote Commander (1)  
A button-type lithium battery is already installed. Remove the insulation sheet before using the Wireless Remote Commander.
- Rechargeable battery pack NP-FV50 (1)
- CD-ROM “Handycam” Application Software (1) (p. 37)
  - “PMB” (software, including “PMB Help”)
  - “Handycam” Handbook (PDF)
- “Operating Guide” (This manual) (1)

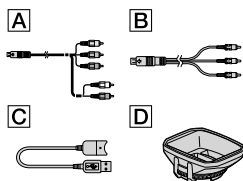

- This camcorder has a built-in software application called “PMB Portable” (p. 40).
- See page 19 for the memory card you can use with this camcorder.

## Using the camcorder

- Do not hold the camcorder by the following parts, and also do not hold the camcorder by the jack covers.

Viewfinder (HDR-CX690E/  
CX700E/CX700VE)



Lens hood (HDR-CX690E/  
CX700E/CX700VE)



LCD Screen

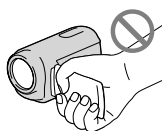

Battery pack



Built-in USB Cable



- The camcorder is not dustproofed, dripproofed or waterproofed. See “Precautions” (p. 66).

## Menu items, LCD panel, viewfinder (HDR-CX690E/CX700E/CX700VE) and lens

- A menu item that is grayed out is not available under the current recording or playback conditions.
- The LCD screen and viewfinder (HDR-CX690E/CX700E/CX700VE) are manufactured using extremely high-precision technology, so over 99.99% of the pixels are operational for effective use. However, there may be some tiny black points and/or bright points (white, red, blue, or green in color) that appear constantly on the LCD screen. These points are normal results of the manufacturing process and do not affect the recording in any way.

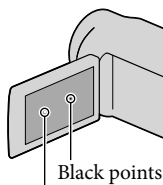

White, red, blue or green points

- Exposing the LCD screen, the viewfinder (HDR-CX690E/CX700E/CX700VE) or the lens to direct sunlight for long periods of time may cause malfunctions.
- Do not aim at the sun. Doing so might cause your camcorder to malfunction. Take images of the sun only in low light conditions, such as at dusk.

## About language setting

- The on-screen displays in each local language are used for illustrating the operating procedures. Change the screen language before using the camcorder if necessary (p. 17).

## On recording

- To ensure stable operation of the memory card, it is recommended to format the memory card with your camcorder before the first use. Formatting the memory card will erase all the data stored on it and the data will be irrecoverable. Save your important data on your PC etc.
- Before starting to record, test the recording function to make sure the image and sound are recorded without any problems.
- Compensation for the contents of recordings cannot be provided, even if recording or playback is not possible due to a malfunction of the camcorder, recording media, etc.
- TV color systems differ depending on the country/region. To view your recordings on a TV, you need a PAL system-based TV.
- Television programs, films, video tapes, and other materials may be copyrighted. Unauthorized recording of such materials may be contrary to the copyright laws.

- Use the camcorder in accordance with local regulations.

## Notes on playing back

- You may not be able to play back normally images recorded on your camcorder with other devices. Also, you may not be able to play back images recorded on other devices with your camcorder.
- Standard (STD) image quality movies recorded on SD memory cards cannot be played on AV equipment of other manufacturers.

## DVD media recorded with HD image quality (high definition)

- DVD media recorded with high definition image quality (HD) can be played back with devices that are compatible with the AVCHD standard. You cannot play discs recorded with high definition image quality (HD) with DVD players/recorders as they are not compatible with the AVCHD format. If you insert a disc recorded with the AVCHD format (high definition image quality (HD)) into a DVD player/recorder, you may not be able to eject the disc.

## Save all your recorded image data

- To prevent your image data from being lost, save all your recorded images on external media periodically. To save images on your computer, see page 36, and to save images on external devices, see page 43.
- The type of discs or media on which the images can be saved depend on the [  REC Mode ] selected when the images were recorded. Movies recorded with [50p Quality **PS**] can be saved using external media (p. 45). Movies recorded with [Highest Quality **FX**] can be saved on external media or on Blu-ray discs.

## Notes on battery pack/AC Adaptor

- Be sure to remove the battery pack or the AC Adaptor after turning off the camcorder.
- Disconnect the AC Adaptor from the camcorder, holding both the camcorder and the DC plug.

## Note on the camcorder/battery pack temperature

- When the temperature of the camcorder or battery pack becomes extremely high or extremely low, you may not be able to record or play back on the camcorder, due to the protection features of the camcorder being activated in such situations. In this case, an indicator appears on the LCD screen or on the viewfinder (HDR-CX690E/CX700E/CX700VE).

## When the camcorder is connected to a computer or accessories

- Do not try to format the recording media of the camcorder using a computer. If you do so, your camcorder may not operate correctly.
- When connecting the camcorder to another device with communication cables, be sure to insert the connector plug in the correct way. Pushing the plug forcibly into the terminal will damage the terminal and may result in a malfunction of the camcorder.
- When the camcorder is connected to other devices through a USB connection and the power of the camcorder is turned on, do not close the LCD panel. The image data that has been recorded may be lost.

## If you cannot record/play back images, perform [Format]

- If you repeat recording/deleting images for a long time, fragmentation of data occurs on the recording media. Images cannot be saved or recorded. In such a case, save your images on some type of external media first, and then perform [Format] by touching **MENU** (MENU) → [Setup] → [  (Media Settings) ] → [Format] → the desired medium (HDR-CX560E/CX560VE/CX700E/CX700VE) → **OK** → **OK**.

## Notes on optional accessories

- We recommend using genuine Sony accessories.
- Genuine Sony accessories may not be available in some countries/regions.

## About this manual, illustrations and on-screen displays

- The example images used in this manual for illustration purposes are captured using a digital still camera, and therefore may appear different from images and screen indicators that actually appear on your camcorder. And, the illustrations of your camcorder and its screen indication are exaggerated or simplified for understandability.
- In this manual, the internal memory (HDR-CX560E/CX560VE/CX700E/CX700VE) and the memory card are called “recording media.”
- In this manual, the DVD disc recorded with high definition image quality (HD) is called AVCHD recording disc.
- Design and specifications of your camcorder and accessories are subject to change without notice.

## Confirm the model name of your camcorder



- The model name is shown in this manual when there is a difference in specification between models. Confirm the model name on the bottom of your camcorder.
- The main differences in specification of this series are as follows.

	Recording media	Capacity of internal recording media	USB jack
HDR-CX560E/ CX560VE*	Internal memory + memory card	64 GB	Output only
HDR-CX690E**	Memory card	—	Input/output
HDR-CX700E**/ CX700VE** **	Internal memory + memory card	96 GB	

The model with \* is equipped with GPS.

The model with \*\* is equipped with viewfinder.

## Notes on use

- Do not do any of the following. Otherwise, the recording media may be damaged, recorded images may be impossible to play back or may be lost, or other malfunctions could occur.
  - ejecting the memory card when the access lamp (p. 20) is lit or flashing
  - removing the battery pack or AC Adaptor from the camcorder, or applying mechanical shock or vibration to the camcorder when the  (Movie)/ (Photo) lamps (p. 22) or the access lamp (p. 20) are lit or flashing
- When using a shoulder belt (sold separately), do not crash the camcorder against an object.



# Table of contents

Read this first .....	2
-----------------------	---

---

## Getting started

Step 1: Charging the battery pack.....	11
Charging the battery pack abroad .....	14
Step 2: Turning the power on, and setting the date and time .....	15
Changing the language setting.....	17
Step 3: Preparing the recording media .....	18
To check the recording media settings.....	18
Copying movies and photos (HDR-CX560E/CX560VE/CX700E/CX700VE) .....	20

---

## Recording/Playback

Recording.....	21
Acquiring location information using the GPS (HDR-CX560VE/CX700VE).....	25
Selecting the recording mode .....	26
Adjusting for shooting conditions.....	27
Playback on the camcorder .....	28
Performing Highlight Playback .....	31
Playing images on a TV .....	32

---

## Advanced operations

Deleting movies and photos.....	35
---------------------------------	----

---

## Saving movies and photos with a computer

Useful functions available if you connect the camcorder to a computer.....	36
Preparing a computer .....	37
When using a Macintosh.....	37
Starting PMB (Picture Motion Browser).....	40
Uploading images to a network service.....	40

---

## Saving images with an external device

Selecting a method for saving images with an external device .....	43
Saving images on an external media device .....	45
Creating a disc with the DVD writer, DVDirect Express .....	48
Creating a high definition image quality (HD) disc with a DVD writer, etc., other than DVDirect Express .....	51
Creating a standard definition image quality (STD) disc with a recorder, etc. ....	52

---

## Customizing your camcorder

Using menus .....	54
Getting detailed information from the “Handycam” Handbook .....	59

---

## Additional information

 Troubleshooting .....	60
Recording time of movies/number of recordable photos .....	63
Precautions .....	66
Specifications .....	68

---

## Quick reference

Screen indicators .....	72
Parts and controls .....	73
Index .....	76

## Step 1: Charging the battery pack

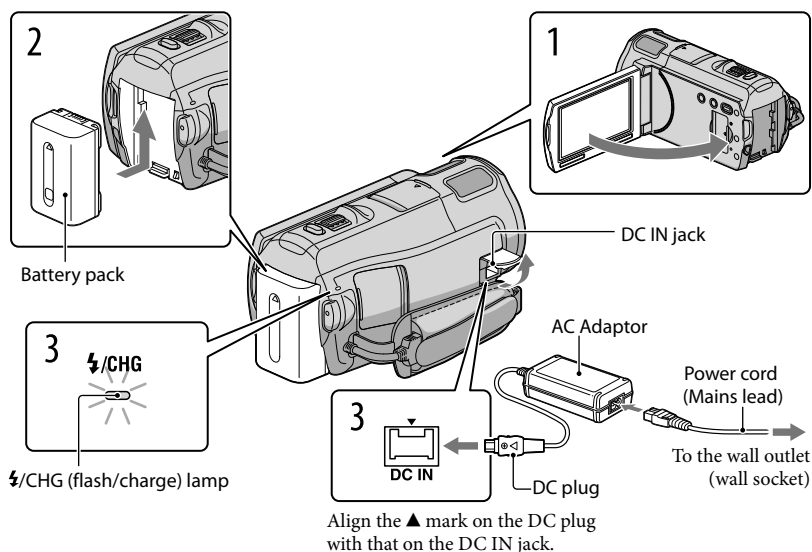

You can charge the “InfoLITHIUM” battery pack (V series) after attaching it to your camcorder.

⚡ Notes

- You cannot attach any “InfoLITHIUM” battery pack other than the V series to your camcorder.

1 Turn off your camcorder by closing the LCD screen after replacing the viewfinder (HDR-CX690E/CX700E/CX700VE).

2 Attach the battery pack by sliding it in the direction of the arrow until it clicks.

3 Connect the AC Adaptor and the power cord (mains lead) to your camcorder and the wall outlet (wall socket).

The ⚡/CHG (flash/charge) lamp lights up and charging starts. The ⚡/CHG (flash/charge) lamp turns off when the battery pack is fully charged.

## 4 When the battery is charged, disconnect the AC Adaptor from the DC IN jack of your camcorder.

### To charge the battery using your computer

This method is useful when the AC Adaptor is not available.

- ① Turn off the camcorder and attach the battery pack to the camcorder.
- ② Connect the camcorder to a running computer using the Built-in USB Cable.

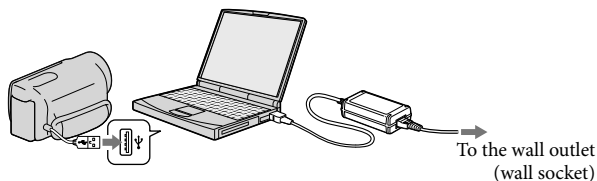

- ③ When the battery is fully charged, disconnect the camcorder from the computer (p. 39).

#### ⚡ Notes

- Operation with all computers is not assured.
- If you connect the camcorder to a laptop computer that is not connected to a power source, the battery of the laptop computer will continue to use up its charge. Do not leave the camcorder connected to a computer in this manner.
- Charging with a personally assembled computer, with a converted computer, or through a USB hub are not guaranteed. The camcorder may not function correctly depending on the USB device which is used with the computer.

#### 💡 Tips

- You can charge the battery by connecting the Built-in USB Cable to a wall outlet (wall socket) using an AC-U501AD/AC-U50AG USB charger/AC Adaptor (sold separately). You cannot use a Sony CP-AH2R or CP-AL portable power supply device (sold separately) to charge the camcorder.
- The USB charger/AC Adaptor may not be available in some countries/regions.
- The ⚡/CHG (flash/charge) lamp may not light up when the remaining battery power is too low. In such a case, charge the battery using the supplied AC Adaptor.

### Charging time

Approximate time (min.) required when you fully charge a fully discharged battery pack.

Battery pack	Charging time	
	AC Adaptor	Built-in USB Cable*
NP-FV50 (supplied)	155	315
NP-FV70	195	600
NP-FV100	390	1050

- The charging times shown in the table above are measured when charging the camcorder at a temperature of 25 °C (77 °F). It is recommended that you charge the battery in a temperature range of 10 °C to 30 °C (50 °F to 86 °F).
- \* The charging times are measured without using the USB Connection support cable.

#### Tips

- See page 63 on recording and playing time.
- When your camcorder is on, you can check the approximate amount of remaining battery power with the remaining battery indicator at the upper right on the LCD screen.

### To remove the battery pack

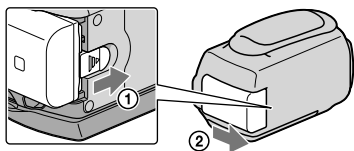

Close the LCD screen. Slide the BATT (battery) release lever (①) and remove the battery pack (②).



### To use a wall outlet (wall socket) as a power source

Make the same connections as “Step 1: Charging the battery pack” (p. 11). Even if the battery pack is attached, the battery pack is not discharged.

### Notes on the battery pack

- When you remove the battery pack or disconnect the AC Adaptor, turn the camcorder off and make sure that the  (Movie)/ (Photo) lamps (p. 22), the access lamp (p. 20) are turned off.
- The /CHG (flash/charge) lamp flashes during charging under the following conditions:
  - The battery pack is not attached correctly.
  - The battery pack is damaged.
  - The temperature of the battery pack is low.  
Remove the battery pack from your camcorder and put it in a warm place.
  - The temperature of the battery pack is high.  
Remove the battery pack from your camcorder and put it in a cool place.
- When attaching a video light (sold separately), it is recommended that you use an NP-FV70 or NP-FV100 battery pack.
- We do not recommend using an NP-FV30, which only allows short recording and playback times, with your camcorder.
- In the default setting, the power turns off automatically if you leave your camcorder without any operation for about 5 minutes, to save battery power ([A. Shut Off]).

## Notes on the AC Adaptor

- Use the nearby wall outlet (wall socket) when using the AC Adaptor. Disconnect the AC Adaptor from the wall outlet (wall socket) immediately if any malfunction occurs while using your camcorder.
- Do not use the AC Adaptor placed in a narrow space, such as between a wall and furniture.
- Do not short-circuit the DC plug of the AC Adaptor or battery terminal with any metallic objects. This may cause a malfunction.

## Charging the battery pack abroad

You can charge the battery pack in any countries/regions using the AC Adaptor supplied with your camcorder within the AC 100 V - 240 V, 50 Hz/60 Hz range.

- Do not use an electronic voltage transformer.

## Step 2: Turning the power on, and setting the date and time

- 1 Open the LCD screen of your camcorder.

Your camcorder is turned on.

- To turn on your camcorder when the LCD screen is open, press POWER.

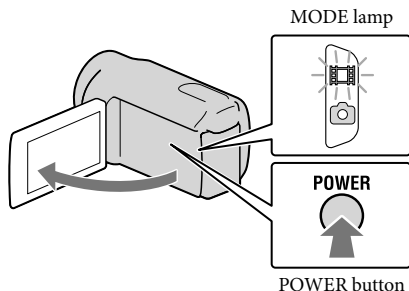

- 2 Select the desired language, then touch [Next].

Touch the button on the LCD screen

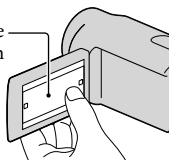

- 3 Select the desired geographical area with **<** / **>**, then touch [Next].

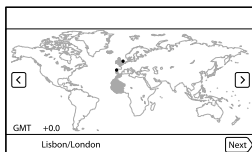

- To set the date and time again, touch **MENU** (MENU) → [Setup] → [⌚ (Clock Settings)] → [Date & Time Setting] → [Date & Time]. When an item is not on the screen, touch **▲** / **▼** until the item appears.

---

## 4 Set [Summer Time], then touch [Next].

- If you set [Summer Time] to [On], the clock advances 1 hour.

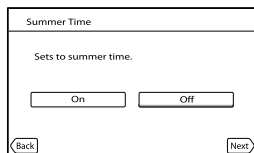

---

## 5 Select the date format, then touch [Next].

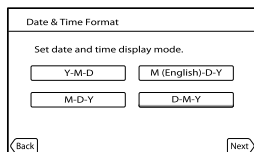

---



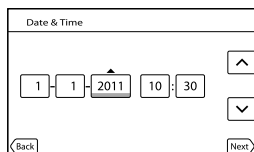



## 6 Select the date and time, touch / to set the value, then touch [Next] → .



The clock starts.

---

### Notes

- The date and time does not appear during recording, but they are automatically recorded on the recording media, and can be displayed during playback. To display the date and time, touch  (MENU) → [Setup] →  (Playback Settings) → [Data Code] → [Date/Time] → .
- You can turn off the operation beeps by touching  (MENU) → [Setup] →  (General Settings) → [Beep] → [Off] → .
- If the button you touch does not react correctly, calibrate the touch panel.
- Once the clock is set, the clock time is automatically adjusted with [Auto Clock ADJ] and [Auto Area ADJ] set to [On]. The clock may not be adjusted to the correct time automatically, depending on the country/region selected for your camcorder. In this case, set [Auto Clock ADJ] and [Auto Area ADJ] to [Off] (HDR-CX560VE/CX700VE).



## To turn off the power

- ① Close the LCD screen.
- ② If the viewfinder is pulled out, retract the viewfinder as shown in the illustration below (HDR-CX690E/CX700E/CX700VE).  
The  (Movie) lamp flashes for a few seconds and the camcorder is turned off.

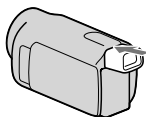

### Tips

- You can turn off the camcorder also by pressing POWER.
- When [Power On By LCD] is set to [Off], turn off your camcorder by pressing POWER (HDR-CX560E/CX560VE).

## On turning the camcorder on or off using the LCD screen or the viewfinder (HDR-CX690E/CX700E/CX700VE)

The power of the camcorder is turned on or off depending on the status of the LCD screen or the viewfinder.

LCD screen	Status		Power of the camcorder
	Viewfinder		
Open	Retracted		On
	Pulled out		On
Closed	Retracted		Off
	Pulled out		On

### Notes

- Even if the LCD screen is closed, if the viewfinder is pulled out, the camcorder is not turned off. When you turn off the power of the camcorder, make sure that the viewfinder is retracted to the original position.

## Changing the language setting

You can change the on-screen displays to show messages in a specified language.

Touch **MENU** (MENU) → [Setup] → [ (General Settings)] → [Language Setting] → a desired language → **OK** → **X** → **X**.

## Step 3: Preparing the recording media

The recording media that can be used differs depending on your camcorder. The following icons are displayed on the screen of your camcorder.

HDR-CX690E



Memory card

HDR-CX560E/CX560VE/  
CX700E/CX700VE



Internal memory \*



Memory card

\* In the default setting, both movies and photos are recorded on this recording media. You can perform recording, playback and editing operations on the selected medium.

### Tips

- See page 64 for the recordable time of movies.
- See page 65 for the number of recordable photos.

### Selecting recording media (HDR-CX560E/CX560VE/CX700E/CX700VE)

**1** Touch **MENU** (MENU) → [Setup] → [Media Settings] → [Media Select].  
The [Media Select] screen appears.

**2** Touch the desired recording medium, then touch **OK** → **OK**.  
Both movies and photos are recorded on the selected medium.

### To check the recording media settings

In either movie recording mode or photo recording mode, the media icon of the selected recording media is displayed at the top right corner of the screen.



Recording media icon



- The icon displayed may vary depending on your model.

## Inserting a memory card

### ⚡ Notes

- Set the recording medium to [Memory Card] to record movies and/or photos on a memory card (HDR-CX560E/CX560VE/CX700E/CX700VE).

### Types of memory card you can use with your camcorder

		SD Speed Class	Described in this manual
“Memory Stick PRO Duo” media (Mark2)		—	“Memory Stick PRO Duo” media
“Memory Stick PRO-HG Duo” media			
SD memory card		Class 4 or faster	SD card
SDHC memory card			
SDXC memory card			

- Operation with all memory cards is not assured.
- “Memory Stick PRO Duo” media, half the size of “Memory Stick”, or standard size SD cards can be used for this camcorder.
- Do not attach a label or the like on memory card or memory card adaptor. Doing so may cause a malfunction.
- “Memory Stick PRO Duo” media of up to 32 GB and SD cards of up to 64 GB have been verified to operate with your camcorder.

### ⚡ Notes

- A MultiMediaCard cannot be used with this camcorder.
  - Movies recorded on SDXC memory cards cannot be imported to or played back on computers or AV devices not supporting the exFAT\* file system by connecting the camcorder to these devices with the USB cable. Confirm in advance that the connecting equipment is supporting the exFAT system. If you connect an equipment not supporting the exFAT system and the format screen appears, do not perform the format. All the data recorded will be lost.
- \* The exFAT is a file system that is used for SDXC memory cards.

---

**1** Open the cover, and insert the memory card with the notched edge in the direction as illustrated until it clicks.

- Close the cover after inserting the memory card.

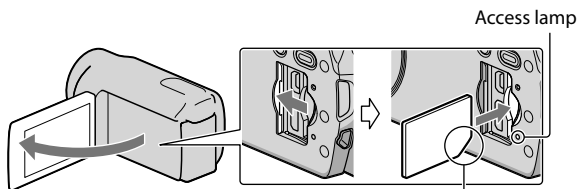

Note the direction of notched corner.

The [Preparing image database file. Please wait.] screen appears if you insert a new memory card. Wait until the screen disappears.

---

**2** Close the cover.

---

**⚡** Notes

- If [Failed to create a new Image Database File. It may be possible that there is not enough free space.] is displayed, format the memory card.
- Confirm the direction of the memory card. If you forcibly insert the memory card in the wrong direction, the memory card, memory card slot, or image data may be damaged.
- Do not open the cover during recording.
- When inserting or ejecting the memory card, be careful so that the memory card does not pop out and drop.

**To eject the memory card**

Open the cover and lightly push the memory card in once.

**Copying movies and photos (HDR-CX560E/CX560VE/CX700E/CX700VE)**

HDR-CX560E/CX560VE

You can copy movies and photos from the internal recording media to the memory card.

HDR-CX700E/CX700VE

You can copy movies and photos back and forth between the internal recording media and the memory card.

Touch **MENU** (MENU) → [Edit/Copy] → [Copy], then follow the instructions that appear on the screen.

# Recording

In the default setting, movies and photos are recorded on the following media. Movies are recorded with high definition image quality (HD).

HDR-CX690E: Memory card

HDR-CX560E/CX560VE/CX700E/CX700VE: Internal recording media

## Tips

- To change the recording media, see page 18 (HDR-CX560E/CX560VE/CX700E/CX700VE).

- 
- 1 Fasten the grip belt.

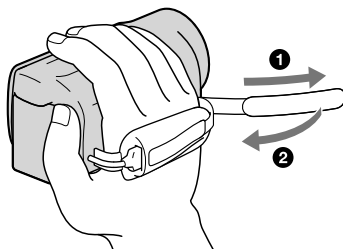

- 
- 2 Open the LCD screen of your camcorder.

Your camcorder is turned on.

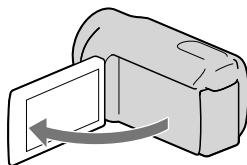

## Recording movies

 (Movie): When recording a movie

 (Photo): When recording a photo

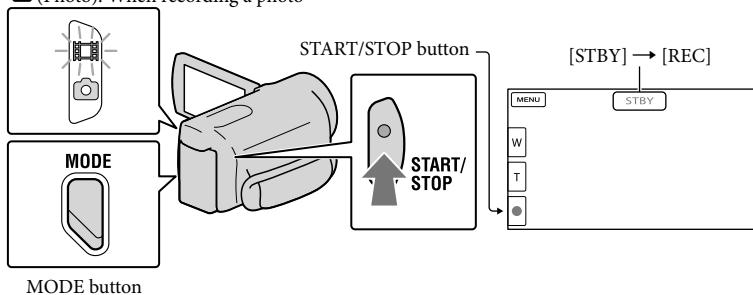

**1** Press MODE to turn on the  (Movie) lamp.

**2** Press START/STOP to start recording.

To stop recording, press START/STOP again.

### To display items on the LCD screen again

Touch anywhere on the screen except the buttons on the LCD screen so that you can use items. You can change the settings using the [Display Setting] menu.

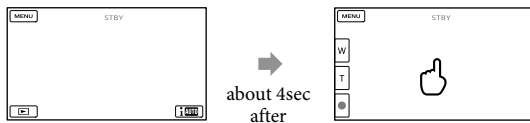

### To capture smiles

In the default setting, a photo is automatically recorded when the camcorder detects the smile of a person during movie recording (Smile Shutter). When the camcorder detects faces during movie recording, image quality is automatically adjusted ([Face Detection]).

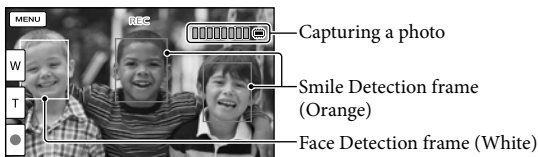

### ⚡ Notes

- If you close the LCD screen while recording movies, the camcorder stops recording.
- The maximum continuous recordable time of movies is about 13 hours.
- When a movie file exceeds 2 GB, the next movie file is created automatically.
- It will take several seconds until you can start recording after you turn on the camcorder. You cannot operate your camcorder during this time.
- The following states will be indicated if data is still being written onto the recording media after recording has finished. During this time, do not apply shock or vibration to the camcorder, or remove the battery or AC Adaptor.
  - Access lamp (p. 20) is lit or flashing
  - The media icon in the upper right of the LCD screen is flashing

### 👁 Tips

- See page 64 on the recordable time of movies.
- You can record photos during movie recording by pressing PHOTO fully (Dual Rec).
- [SteadyShot] is set to [Active] in the default setting.
- You can specify the priority face by touching it.
- You can capture photos from recorded movies.
- You can check the recordable time, estimated remaining capacity, etc., by touching **MENU** (MENU) → [Setup] → [Media Settings] → [Media Info].
- The LCD screen of your camcorder can display recording images across the entire screen (full pixel display). However, this may cause slight trimming of the top, bottom, right and left edges of images when played back on a TV which is not compatible with full pixel display. In this case, set [Guide Frame] to [On], and record images using the outer frame displayed on the screen as a guide.
- To adjust the angle of the LCD panel, first open the LCD panel 90 degrees to the camcorder (①), and then adjust the angle (②).

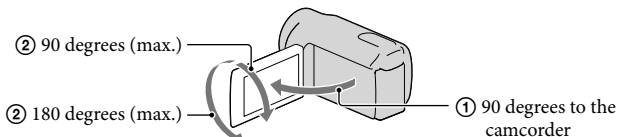

- When you make recording with the viewfinder only, pull out the viewfinder and close the LCD panel. If the indicator on the viewfinder appear blurred, adjust the viewfinder lever located on the side of the viewfinder (HDR-CX690E/CX700E/CX700VE).

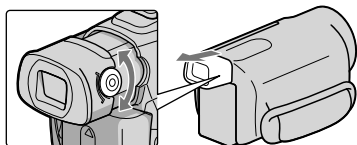

### Data code during recording

The recording date, time and condition, and coordinates (HDR-CX560VE/CX700VE) are recorded automatically on the recording media. They are not displayed during recording. However, you can check them as [Data Code] during playback. To display them, touch **MENU** (MENU) → [Setup] → [▶] (Playback Settings) → [Data Code] → a desired setting → **OK**.

### Shooting photos

📺(Movie): When recording a movie

📷(Photo): When recording a photo

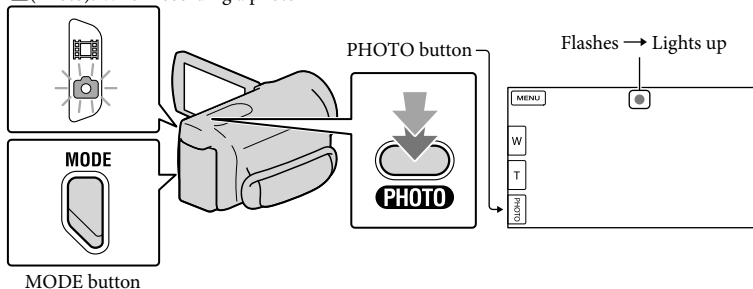

When  disappears, the photo is recorded.

**1** Press MODE to turn on the  (Photo) lamp.

The LCD screen display switches for photo recording mode.

**2** Press PHOTO lightly to adjust the focus, then press it fully.



### Tips

- See page 65 on the recordable number of photos.
- To change the image size, touch **MENU** (MENU) → [Image Quality/Size] → [Image Size] → a desired setting → **OK**.
- You cannot record photos while  is displayed.
- Your camcorder flashes automatically when there is insufficient ambient light. The flash does not work in the movie recording mode. You can change how your camcorder flashes by **MENU** (MENU) → [Camera/Mic] → [Flash] → [Flash] → a desired setting → **OK**.

### If white circular spots appear on photos

This is caused by particles (dust, pollen, etc.) floating close to the lens. When they are accentuated by the camcorder's flash, they appear as white circular spots.

To reduce the white circular spots, light the room and shoot the subject without a flash.

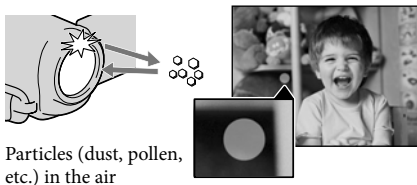

Particles (dust, pollen, etc.) in the air

### Acquiring location information using the GPS (HDR-CX560VE/CX700VE)

When you set [GPS Setting] (p. 58) to [On],  appears on the LCD screen, and your camcorder starts searching for the GPS satellites and acquires the location information.

Acquiring the location information enables you to use functions such as the Map View.

The indicator changes according to the strength of GPS signal reception.

- Processing time can be shortened when you load the GPS assist data into the camcorder using the supplied software "PMB." Install "PMB" on your computer (p. 37) and connect the computer to the internet. Then connect the camcorder to the computer and the GPS assist data will be automatically updated.
- The GPS assist data may not function in the following cases:
  - When the GPS assist data are not updated for about 30 days or more
  - When the date and time of the camcorder are not correctly set
  - When the camcorder is moved for a long distance
- Built-in map is powered by companies as follows; Map of Japan by ZENRIN CO., LTD., other areas by NAVTEQ.

## Selecting the recording mode

You can change the quality of the image that you record by touching **MENU** (MENU) → [Image Quality/Size] → [  REC Mode].

The types of media that images can be saved on will depend on the recording mode selected.

For details on a save operation using the external devices, see page 43.

Types of media	Recording mode		
	PS*	FX	FH/HQ/LP
On this camcorder			
Internal recording media	✓	✓	✓
Memory card	✓	✓	✓
On external devices			
External media (USB storage devices)	✓	✓	✓
Blu-ray discs	—	✓	✓
AVCHD recording discs	—	—	✓

\* [PS] can be set only when [  Frame Rate] is set to [50p].

# Adjusting for shooting conditions

## Recording in dark places (NightShot)

When you press NIGHTSHOT,  appears, and you can record images even in total darkness.

Press NIGHTSHOT again to cancel the NightShot function.

- Using NightShot in bright places will cause a malfunction of your camcorder.



Infrared port

## Adjusting focus, etc., manually (MANUAL dial)

It is convenient to make manual adjustments using the MANUAL dial, by assigning a menu item ([Focus] in the default setting) to the MANUAL dial.

MANUAL button

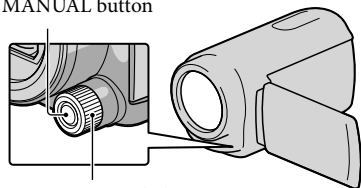

MANUAL dial

## How to use the MANUAL dial

Press MANUAL to switch to manual operation mode, and rotate the dial to make the adjustment. Pressing MANUAL switches the operation mode between manual and automatic.

## To assign a menu item

Press and hold MANUAL for a few seconds to display the [Dial Setting] screen. Rotate the MANUAL dial to assign an item. You can assign [Focus], [Exposure], [IRIS], [Shutter Speed], [AE Shift], or [White Balance Shift].

## Using a tripod

Attach a tripod (sold separately) to the tripod receptacle using a tripod screw (sold separately, the length of the screw must be less than 5.5 mm (7/32 in.)).

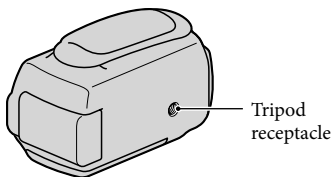

# Playback on the camcorder

You can enjoy the playback of images with powerful sound through the stereo speakers built into the camcorder.

In the default setting, movies and photos that are recorded on the following recording media are played.

HDR-CX690E: Memory card

HDR-CX560E/CX560VE/CX700E/CX700VE: Internal recording media

## Tips

- To change the recording media, see page 18 (HDR-CX560E/CX560VE/CX700E/CX700VE).
- The camcorder displays recorded images as an event automatically, based on the date and time. It can also display recorded images on the basis of location information (HDR-CX560VE/CX700VE).

## 1 Open the LCD screen of your camcorder.

Your camcorder is turned on.

## 2 Press (View Images).

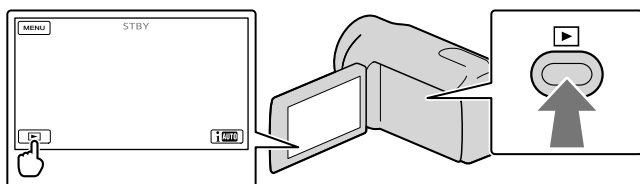

The Event View screen appears after some seconds.

## 3 Touch / to select the desired event (B).

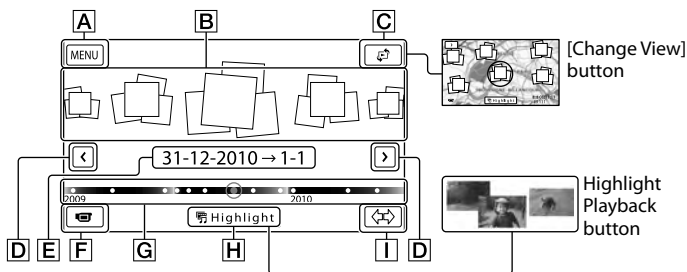

**A** To the MENU screen

**B** Events

**C** Change View button (HDR-CX560VE/CX700VE)

- D** ◀/▶ : To the previous/next event
- E** Event name
- F** Change to the movie/photo recording mode
- G** Time-line bar
- H** Highlight Playback button\*
- I** Change Event Scale button

\* Appears only when the image quality is set to [HD:HD Quality].

The Event Index screen appears when you touch the event that is displayed on the center.

- You can also choose an event by touching ◆ on the time-line bar.
- Touch ⇄ (Change Event Scale) on the bottom right of the screen so that you can change the time range of the time-line bar from one and a half years to three months, which changes the number of the events that can be displayed on the time-line bar.

## 4 Touch an image you want to view.

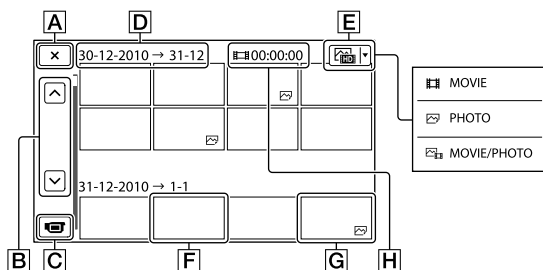



Touch **E** to select the image type to be displayed in the index from [MOVIE] (movies only), [PHOTO] (photos only), or [MOVIE/PHOTO] (movies and photos mixed).

- A** To go back to the Event View screen
- B** ▲/▼ : Displays the previous/next page (Touching and holding the button scrolls the index screen.)
- C** Change to the movie/photo recording mode
- D** Event title
- E** Switch Image Type button
- F** Movie
- G** Photo
- H** Total playing time of movies in the event (total number of photos if photos only)

- ▶| appears with the movie or photo that was most recently played or recorded. If you touch the movie or photo with ▶|, you can continue playback from the previous time.

## Operating the camcorder while playing a movie

You can use the functions shown in the figure below while the camcorder is playing a movie. The figure below will be displayed when you select [  MOVIE/PHOTO ] (the default setting) or [  MOVIE ] by touching the Switch Image Type button on the Event Index screen.

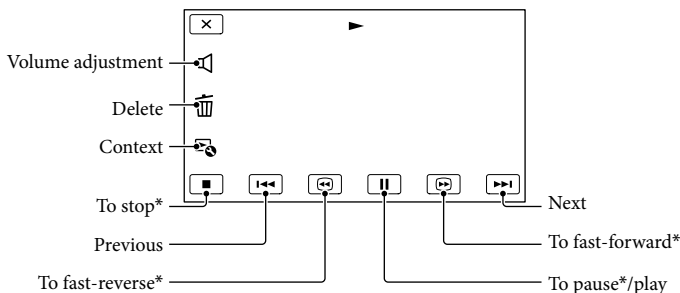







\* These buttons can be used only when the camcorder is playing a movie.

### Notes

- You may not be able to play back the images with other devices than camcorder.

### Tips

- Touching the  button on the playback screen displays functions you can currently use, and allows you to use those functions easily.
- When playback from the selected image reaches the last image, the screen returns to the INDEX screen.
- Touch  /  during pause to play back movies slowly.
- As you repeat touching  /  during playback, movies are played as fast as about 5 times → about 10 times → about 30 times → about 60 times.
- The recording date, time, and shooting conditions, and coordinates (HDR-CX560VE/CX700VE) are recorded automatically during recording. This information is not displayed during recording, but you can display it during playback by touching **MENU** (MENU) → [Setup] → [  (Playback Settings) ] → [Data Code] → a desired setting → **OK** → **X**.
- In the default setting, a protected demonstration movie is pre-recorded (HDR-CX560E/CX560VE/CX700E/CX700VE).

### To adjust the sound volume of movies

While playing back movies, touch  → adjust with  /  → **OK**.

## Viewing photos

You can use the functions shown in the figure below while you are viewing photos. The figure below will be displayed when you select [PHOTO] by touching the Switch Image Type button on the Event Index screen.

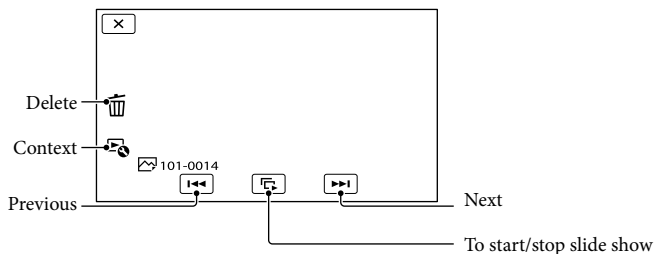

### Tips

- To repeat Slideshow, touch [Repeat] → [Slideshow Set].

## Performing Highlight Playback

Press [Play] → Touch [Left/Right] to select the desired event, then touch [Highlight].

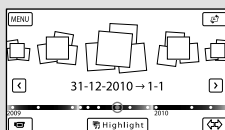

- Touch [Scenario Save] on the screen after the Highlight Playback is finished so that you can save the Highlight Playback scenario.

# Playing images on a TV

Connection methods and the image quality (high definition (HD) or standard definition (STD)) viewed on the TV screen differ depending on what type of TV is connected, and the connectors used.

## Output connectors on the camcorder

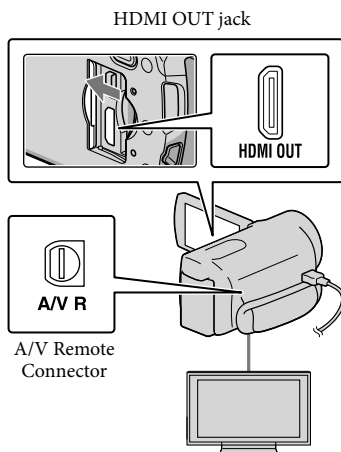

1 Switch the input on the TV to the connected jack.

- Refer to the instruction manuals of the TV.

2 Connect the camcorder to a TV.

- Use the supplied AC Adaptor as the power source (p. 13).

3 Play a movie or a photo on the camcorder (p. 28).

## List of connection

### Connecting to a high definition TV

When the recording quality is high definition image quality (HD), the movies are played back in high definition image quality (HD). When the recording quality is standard image quality (STD), the movies are played back in standard definition image quality (STD).

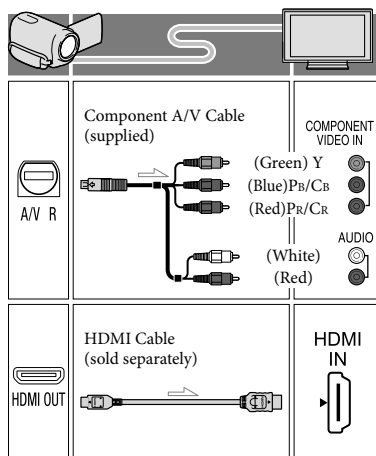



## Connecting to a non-high-definition 16:9 (wide) or 4:3 TV

When movies are recorded with high definition image quality (HD), they are played back in standard definition image quality (STD). When movies are recorded with standard image quality (STD), they are played back in standard definition image quality (STD).

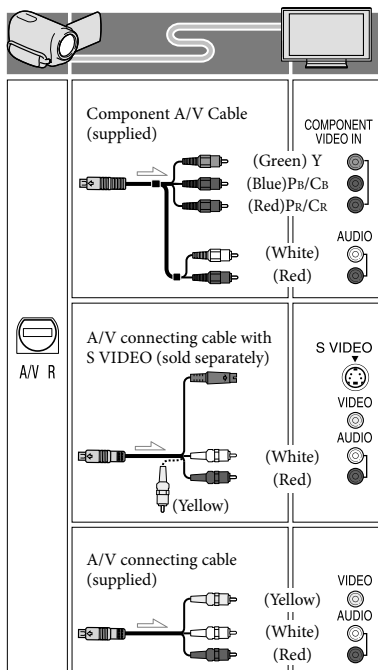

## When you connect with component A/V cable

- If you connect only component video plugs, audio signals are not output. Connect the white and red plugs to output audio signals.
- Select the [Component] setting for the component input jack you are using. Touch **MENU** (MENU) → [Setup] → [↔ (Connection)] → [Component] → a desired setting → **OK** to make the setting.

## When you connect with HDMI cable

- Use an HDMI cable with the HDMI logo.
- Use an HDMI mini connector on one end (for the camcorder), and a plug suitable for connecting your TV on the other end.
- Copyright-protected images are not output from the HDMI OUT jack of your camcorder.
- Some TVs may not function correctly (e.g., no sound or image) with this connection.
- Do not connect the camcorder HDMI OUT jack to an external device HDMI OUT jack, as malfunction may result.
- When the connected device is compatible with 5.1ch surround sound, high definition image quality (HD) movies are output in 5.1ch surround sound automatically. Standard definition image quality (STD) movies are converted to 2ch sound.

## To set the aspect ratio according to the connected TV (16:9/4:3)

- Set [TV Type] to [16:9] or [4:3] according to your TV.

## When you connect with A/V connecting cable with S-Video

- When the S VIDEO plug (S VIDEO channel) is connected, audio signals are not output. To output audio signals, connect the white and red plugs to the audio input jack of your TV.
- This connection produces higher resolution images compared with the A/V connecting cable.

## When your TV is monaural (When your TV has only one audio input jack)

- Connect the yellow plug of the A/V connecting cable to the video input jack and connect the white (left channel) or red (right channel) plug to the audio input jack of your TV or VCR.

## When connecting to your TV via a VCR

- Connect your camcorder to the LINE IN input on the VCR using the A/V connecting cable. Set the input selector on the VCR to LINE (VIDEO 1, VIDEO 2, etc.).

### ⚙ Notes

- When you play back standard definition image quality (STD) movies on a 4:3 TV that is not compatible with the 16:9 signal, record movies with 4:3 aspect ratio. Touch **MENU** (MENU) → [Image Quality/Size] → [Wide Mode] → [4:3] → **OK**.
- When the A/V connecting cable is used to output movies, movies are output with standard definition image quality (STD).

## If your TV/VCR has a 21-pin adaptor (EUROCONNECTOR)

Use a 21-pin adaptor (sold separately) to view playback pictures.

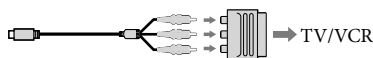

### ⚙ Tips

- If you connect your camcorder to the TV using more than one type of cable to output images, the order of priority of the TV input jacks is as follows:  
HDMI → component → S VIDEO → video
- HDMI (High Definition Multimedia Interface) is an interface to send both video/audio signals. The HDMI OUT jack outputs high quality images and digital audio.

## On “Photo TV HD”

This camcorder is compatible with the “Photo TV HD” standard. “Photo TV HD” allows for highly-detailed, photo-like depiction of subtle textures and colors. By connecting Sony’s Photo TV HD-compatible devices using an HDMI cable\* or the component AV cable\*\*, a whole new world of photos can be enjoyed in breathtaking full HD quality.

- \* The TV will automatically switch to the appropriate mode when [PHOTO] is selected with the Switch Image Type button.
- \*\* Setup of the TV will be necessary. Please refer to the instructions of your Photo TV HD-compatible TV for details.

## Deleting movies and photos

You can free media space by deleting movies and photos from recording media.

### Notes



- You cannot restore images once they are deleted. Save important movies and photos in advance.
- Do not remove the battery pack or the AC Adaptor from your camcorder while deleting the images. It may damage the recording media.
- Do not eject the memory card while deleting images from the memory card.
- You cannot delete protected movies and photos. Undo the protection of the movies and photos to delete them, before you try to delete them.
- The demonstration movie on your camcorder is protected (HDR-CX560E/CX560VE/CX700E/CX700VE).
- If you delete movies/photos that are included in saved scenarios, the scenarios will also be deleted.





### Tips

- If you start playing back an image by selecting it from the Event Index screen, you can delete the image using  on the playback screen.
- To delete all images recorded in the recording media, and recover all the recordable space of the media, format the media.
- Reduced-size images which enable you to view many images at the same time on an index screen are called "thumbnails."

1 Press  (View Images) (p. 28).

2 Touch **MENU** (MENU) → [Edit/Copy] → [Delete].

3 To select and delete movies, touch [Multiple Images] → [ MOVIE]/[ PHOTO]/[ MOVIE/PHOTO].

- When [  Setting] is set to [ STD Quality],  appears instead of .

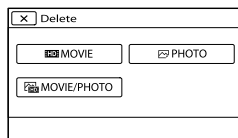

4 Touch and display the  mark on the movies or photos to be deleted.

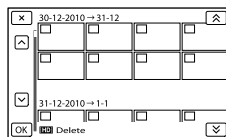



- Touch and hold the desired thumbnail so that you can confirm the image. Touch  to return to the previous screen.

5 Touch **OK** → **OK** → **OK**.

To delete all movies/photos in an event at one time

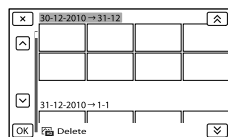
① In step 3, touch [All In Event].



② Touch  /  to select the desired event, then touch **OK**.

- Touch and hold the desired thumbnail so that you can confirm the image. Touch  to return to the previous screen.

③ Touch **OK** → **OK**.

Saving movies and photos with a computer

## Useful functions available if you connect the camcorder to a computer

Editing and managing images on your computer (Windows)

The software PMB stored in the CD-ROM (supplied) includes functions that enable you to do more with the images recorded with the camcorder.

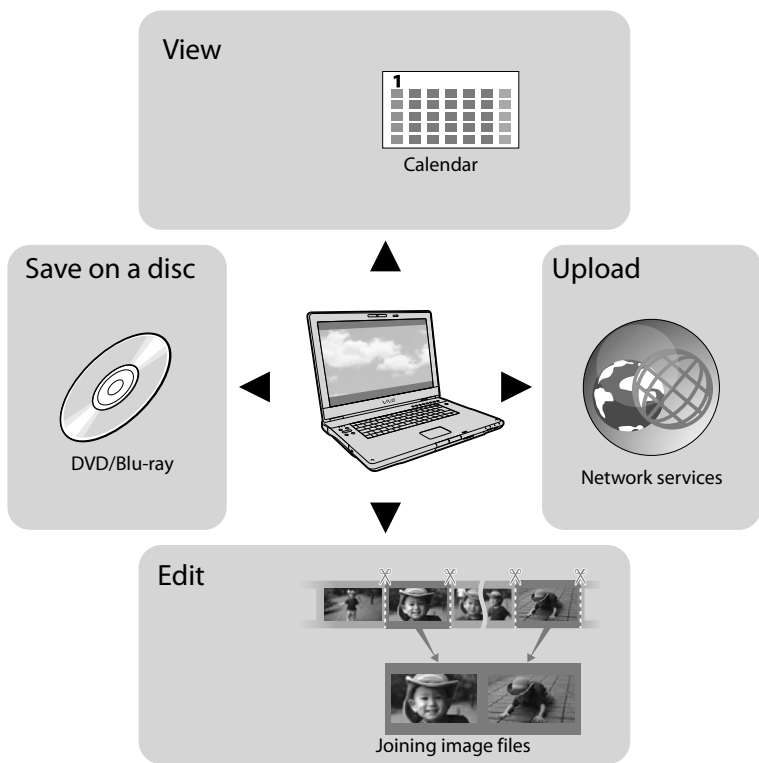

Easy uploading when away from home (Windows, Macintosh)

With PMB Portable, which is pre-installed on the camcorder, you can play back or upload your images to the Web by connecting your camcorder to a computer away from home.

# Preparing a computer

## Step 1 Checking the computer system

### Windows

<b>OS*</b> <sup>1</sup>
Microsoft Windows XP SP3* <sup>2</sup> /Windows Vista SP2* <sup>3</sup> /Windows 7
<b>CPU*</b> <sup>4</sup>
Intel Core Duo 1.66 GHz or faster, or Intel Core 2 Duo 1.66 GHz or faster (Intel Core 2 Duo 2.26 GHz or faster is required when processing FX or FH movies, and Intel Core 2 Duo 2.40 GHz or faster is required when processing PS movies.) However, Intel Pentium III 1 GHz or faster is sufficient for the following operations: – Importing the movies and photos to the computer – One Touch Disc Burn – Creating a Blu-ray disc/AVCHD recording disc/DVD-video (Intel Core Duo 1.66 GHz or faster is required when creating a DVD video by converting high definition image quality (HD) to standard definition image quality (STD).) – Copying a disc – Processing only the movies with standard definition image quality (STD)
<b>Application</b>
PMB/PMB Portable /Music Transfer (HDR-CX690E/CX700E/CX700VE)
<b>Memory</b>
For Windows XP: 512 MB or more (1 GB or more is recommended.) However, 256 MB or more is sufficient for processing only the movies with standard definition image quality (STD). For Windows Vista/Windows 7: 1 GB or more
<b>Hard disk</b>
Disk volume required for installation: Approximately 500 MB (10 GB or more may be necessary when creating AVCHD recording discs. 50 GB maximum may be necessary when creating Blu-ray discs.)

<b>Display</b>
Minimum 1,024 × 768 dots
<b>Others</b>
USB port (this must be provided as standard, Hi-Speed USB (USB 2.0 compatible)), Blu-ray disc/DVD burner (CD-ROM drive is necessary for installation) Either NTFS or exFAT file system is recommended as the hard disk file system.

### Macintosh

<b>OS</b>
PMB Portable: Mac OS X* <sup>5</sup> (v10.5-v10.6) Music Transfer: Mac OS X* <sup>5</sup> (v10.4-v10.6) (HDR-CX690E/CX700E/CX700VE)

- \*<sup>1</sup> Standard installation is required. Operation is not assured if the OS has been upgraded or in a multi-boot environment.
- \*<sup>2</sup> 64-bit editions and Starter (Edition) are not supported. Windows Image Mastering API (IMAPI) Ver.2.0 or newer is required to use disc creation function, etc.
- \*<sup>3</sup> Starter (Edition) is not supported.
- \*<sup>4</sup> Faster processor is recommended.
- \*<sup>5</sup> Macintosh computer with an Intel processor.

#### 🔗 Notes

- Operation with all computer environments is not assured.

## When using a Macintosh

The supplied software “PMB” is not supported by Macintosh computers. To import the movies and photos to the computer, please contact Apple Inc.

## Step 2 Installing the supplied software “PMB”

Install “PMB” before connecting your camcorder to a computer.

## ⚡ Notes

- Even if another version of “PMB” has already been installed on your computer, install the version of “PMB” supplied with your camcorder.
- If the version of “PMB” on the computer is newer than that of “PMB” supplied with your camcorder, a message appears. In this case, discontinue the installation.
- The new version does not include the data disc creation function. Create a data disc using software on your computer.

---

### 1 Confirm that your camcorder is not connected to the computer.

---

### 2 Turn on the computer.

- Log on as an Administrator for installation.
- Close all applications running on the computer before installing the software.

---

### 3 Place the supplied CD-ROM in the disc drive of your computer.

The installation screen appears.

- If the screen does not appear, click [Start] → [Computer] (in Windows XP, [My Computer]), then double-click [SONYPMB (E:)] (CD-ROM)\*.

\* Drive names (such as (E:)) may vary depending on the computer.

---

### 4 Click [Install].

---

### 5 Select the country or region.

---

### 6 Select the language for the application to be installed, then proceed to the next screen.

---

### 7 Read the terms of the license agreement carefully. If you agree to the terms, change to , and then click [Next] → [Install].

---

### 8 Follow the instructions that appear on the computer screen to continue the installation.

- You may be required to install some other applications included on the disc at the same time. If the installation display appears, follow the instructions that appear on the screen.
- When you are required to restart the computer, follow the instructions that appear on the screen and restart it.
- Connect the camcorder to the computer when you are instructed to do so.

---

### 9 Connect the camcorder to the computer using the Built-in USB Cable, then touch [USB Connect] on the LCD screen of the camcorder.

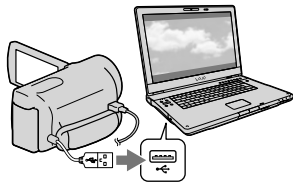

---

### 10 When the installation is completed, remove the CD-ROM from the computer.

- Click  (PMB icon) that appears on the desktop of the computer to start up the software.

### ⚡ Notes

- To create discs or use other functions on Windows XP, Image Mastering API v2.0 for Windows XP should be installed. If Image Mastering API v2.0 for Windows XP has not been installed yet, select it from required programs on the installation screen and install it following the procedures displayed. (The computer must be connected to the internet for the installation.) You may install Image Mastering API v2.0 for Windows XP in response to the message displayed when you try to start those functions.
- Operation is not guaranteed if you read or write video data from or to the camcorder using software other than the supplied “PMB.” For the information on the compatibility of the software you are using, consult the manufacturer of the software.

### To disconnect your camcorder from the computer

- ① Click the  icon at the bottom right of the desktop of the computer → [Safely remove USB Mass Storage Device].



- ② Touch [Cancel] → [Yes] on the camcorder screen.
- ③ Disconnect the USB cable.
  - If you are using Windows 7, the  icon may not appear on the desktop of the computer. In this case, you can disconnect the camcorder from your computer without following the procedures described above.

### ⚡ Notes

- Do not format the internal recording media of the camcorder using a computer. If you do this, the camcorder will not operate correctly.

- Do not insert AVCHD recording discs that have been created using the “PMB” software to DVD players or recorders, as these devices do not support the AVCHD standard. If you do, you may not be able to remove the disc from these devices.
- This camcorder captures high definition footage in the AVCHD format. Using the enclosed PC software, high definition footage can be copied onto DVD media. However, DVD media containing AVCHD footage should not be used with DVD based players or recorders, as the DVD player/recorder may fail to eject the media and may erase its contents without warning.
- When you access the camcorder from the computer, use the supplied software “PMB” or the pre-installed software “PMB Portable.” Do not modify the files or folders on the camcorder from the computer. The image files may be damaged or may not be played back.
- Operation is not guaranteed, if you operate the data on the camcorder from the computer.
- The camcorder automatically divides an image file that exceeds 2 GB or larger and saves the parts as separate files. All image files may be shown as separate files on a computer, however, the files will be handled properly by the import function of the camcorder or the “PMB” software, and also by the playback function of the “PMB Portable” software.
- Use the supplied “PMB” software when you import long movies or edited images from the camcorder to a computer. If you use other software, the images may not be imported correctly.
- When you delete image files, follow the steps on page 35.
- You can create a Blu-ray disc by using a computer with a Blu-ray disc burner. Install the BD Add-on Software for “PMB.”

## Starting PMB (Picture Motion Browser)

- 1 Double-click the “PMB” short-cut icon on the computer screen.



The PMB software starts up.

- 2 Double-click the “PMB Help” short-cut icon on the computer screen to see how to use “PMB.”



### ⚡ Notes

- If the icon is not displayed on the computer screen, click [Start] → [All Programs] → [PMB] → the desired item.

### 💡 Tips

- Double-click “PMB Launcher” on the desktop of the computer. This allows you to start the desired function (application) by selecting one from a list of “PMB” functions.

## Uploading images to a network service

The application software “PMB Portable” is pre-installed in the camcorder. You can enjoy the following functions using the “PMB Portable.”

- Uploading images to network services such as blogs with ease
- Uploading by a network connected computer while away from home
- Register network services (such as blogs) to use frequently

Click the [Help] button on the upper right of the computer screen after the “PMB Portable” software starts up, and then you can view the details on how to use the software.

### Starting up “PMB Portable” (Windows)

- 1 Turn on your camcorder, then connect the camcorder to the computer using the Built-in USB Cable.

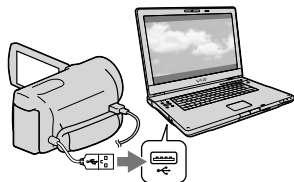

- The [USB Select] screen appears on the camcorder screen.



- 
- 2** Touch [USB Connect] on the camcorder screen.

When using Windows 7: The Device Stage\* window opens.

When using Windows XP/Windows Vista: The AutoPlay wizard is displayed.

- If the [USB Select] screen does not appear, touch **MENU** (MENU) → [Setup] → [↔] (Connection) → [USB Connect].
  - \* “Device Stage” is a menu of Windows 7, that is used to manage devices (camcorder, camera, etc.) that are connected to the computer.
- 

- 3** Click “PMB Portable.”

The license agreement screen appears.

---

- 4** Select the desired language and click [OK].

The area select screen appears.

---

- 5** Select [Region] and [Country/Area] and click [OK].

The license agreement screen appears.

---

- 6** Read the agreement well and click [I Agree].

“PMB Portable” starts up.

---

## Starting up “PMB Portable” (Macintosh)

---

- 1** Turn on your camcorder, then connect the camcorder to the computer using the Built-in USB Cable.

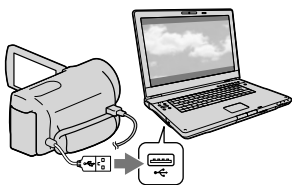

- The [USB Select] screen appears on the camcorder screen.
- 

- 2** Touch [USB Connect] on the camcorder screen.

When the computer recognizes the camcorder, the [PMBPORTABLE] icon appears on the computer screen.

---

- 3** Click “PMBP\_Mac” in the [PMBPORTABLE] folder.

The area select screen appears.

---

- 4** Select [Region] and [Country/Area] and click [OK].

The license agreement screen appears.

---

- 5** Read the agreement well and click [I Agree].

“PMB Portable” starts up.

---

## ⚡ Notes

- When using “PMB Portable,” make sure to connect the camcorder to the network.
- Set [USB LUN Setting] to [Multi] (p. 57).
- If the “PMB Portable” does not start up, set [USB Connect Setting] to [Mass Storage] (p. 57) and try reconnecting.
- If the AutoPlay wizard does not appear when you are using Windows XP or Windows Vista, click [Start] → [Computer] (in Windows XP, [My Computer]) → [PMBPORTABLE], then double click [PMBP\_Win.exe].
- If the “Device Stage” does not start up when you are using Windows 7, click [Start], then double click the camera icon for this camcorder → the medium icon on which the desired images are stored → [APPLICATION] → [PMBP\_MTP.exe].
- If you are using Windows 7, the Device Stage start-up window (which does not contain the information about the specific device) may appear, depending on the computer settings. In such a case, follow the instructions on the screen and download the latest information about the system.
- If you are using Windows 7, the [USB Connect Setting] (USB transfer mode) will be changed to [Mass Storage] automatically when you start up “PMB Portable.”
- When you upload images via Internet, as in the case of with the camcorder, cache files may be stored in the computer you are using depending on the service provider to upload the image to.
- If a problem occurs to “PMB Portable” or if you wrongly delete the software, you can download the “PMB Portable” installer from the Web to repair.

## Notes on “PMB Portable”





You can download the URLs of some websites from a server administered by Sony (hereinafter referred to as the “Sony server”) using “PMB Portable.”

You must agree to the following in order to utilize the image uploading service (herein after referred to as “the service”) provided by various websites including those using “PMB Portable.”

- Depending on the website, registration and fees may be required for use of the service. Use the service in accordance with the terms stipulated by the website.
- The service can be suspended or altered without notice by the website organizer. In these, as well as other cases, Sony shall not be liable in any way for any loss, damages or trouble between you and a third party which arose from the use of the service.
- You will be redirected to the websites by the Sony server. However, you may not be able to access the websites for some reason such as server maintenance.
- If Sony decides to terminate server operation, it will be announced in advance on Sony’s website, etc.
- Such information as URL address of the site you are redirected to from the Sony server may be recorded in order to improve products and services Sony offers in the future. However, personal information will not be recorded.

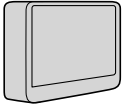
## Selecting a method for saving images with an external device

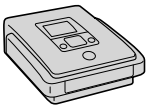
You can save high definition image quality (HD) movies using an external device. Select the method to be used according to the device.

	External devices	Connecting cable	Page
	<p><b>External media device</b> Saving images on an external media device with high definition image quality (HD).</p>	<p>USB Adapter cable VMC-UAM1 (sold separately)</p>	<p>45</p>
	<p><b>DVDirect Express DVD writer</b> Saving images on a DVD disc with high definition image quality (HD).</p>	<p>Built-in USB cable of the DVDirect Express</p>	<p>48</p>
	<p><b>DVD writer other than DVDirect Express</b> Saving images on a DVD disc with high definition image quality (HD) or with standard definition image quality (STD).</p>	<p>Built-in USB Cable</p>	<p>51</p>
	<p><b>Hard disk recorder, etc.</b> Saving images on a DVD disc with standard definition image quality (STD).</p>	<p>A/V connecting cable (supplied)</p>	<p>52</p>

### Movies that are recorded with standard definition image quality (STD)

Use the A/V connecting cable to connect the camcorder to an external device in which images are saved.

#### Notes

- The AVCHD recording disc can be played back only on AVCHD format compatible devices.
- Discs with high definition image quality (HD) images recorded should not be used in DVD players/recorders. Because DVD players/recorders are not compatible with the AVCHD format, DVD players/recorders may fail to eject the disc.
- Delete the demonstration movie when copying or creating discs. If it is not deleted, the camcorder may not operate correctly. However, you cannot recover the demonstration movie once you delete it.

The types of media on which images are saved

Refer to “Selecting the recording mode” on page 26.

### The devices on which the created disc can be played back

DVD disc with high definition image quality (HD)

AVCHD format playback devices, such as a Sony Blu-ray disc player or a PlayStation®3.

DVD disc with standard definition image quality (STD)

Ordinary DVD playback devices, such as a DVD player.

#### Notes

- Always maintain your PlayStation®3 to use the latest version of the PlayStation®3 system software.
- The PlayStation®3 may not be available in some countries/regions.

# Saving images on an external media device

You can save movies and photos on an external media device (USB storage devices), such as an external hard disk drive. You can also play back images on the camcorder or another playback device.

## ⚡ Notes

- For this operation, you need the USB Adaptor Cable VMC-UAM1 (sold separately).
- The USB Adaptor Cable VMC-UAM1 may not be available in some countries/regions.
- Connect your camcorder to the wall outlet (wall socket) using the supplied AC Adaptor (p. 13).
- Refer to the instruction manual supplied with the external media device.

## 💡 Tips

- You can import images saved on the external media device to your computer by using the supplied software “PMB.”

## Functions available after saving images on an external media device

- playback of images through the camcorder (p. 47)
- importing images to “PMB”

## Devices that cannot be used as an external media device

- You cannot use the following devices as an external media device.
  - media devices with a capacity exceeding 2 TB
  - ordinary disc drive such as CD or DVD drive
  - media devices connected via a USB hub
  - media devices with built-in USB hub
  - card reader

## ⚡ Notes

- You may not be able to use external media devices with a code function.
- The FAT file system is available for your camcorder. If the storage medium of the external device was formatted for the NTFS file system, etc., format the external media device using the camcorder before use. The format screen appears when an external media device is connected to your camcorder. Make sure that

important data has not previously been saved on the external media device before you format it using the camcorder.

- Operation is not assured with every device satisfying requirements for operating.
- For details on available external media devices, go to the Sony support website in your country/region.

---

1 Connect the AC Adaptor and the power cord (mains lead) to the DC IN jack of your camcorder and the wall outlet (wall socket).

---

2 If the external medium device has the AC power cable, connect it to the wall outlet (wall socket).

---

3 Connect the USB Adaptor Cable to the external media device.

---

4 Connect the USB Adaptor Cable to the  $\Psi$  (USB) jack of your camcorder.

Make sure not to disconnect the USB cable while [Preparing image database file. Please wait.] is displayed on the LCD screen. If [Repair Img. DB F.] is displayed on the camcorder screen, touch **OK**.

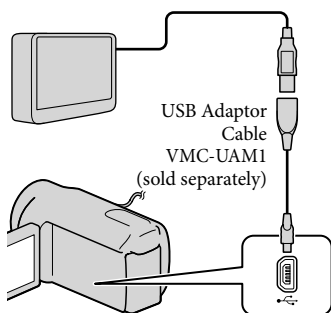

- You cannot use the Built-in USB Cable for this type of connection.

5 Connect the external media device and touch [Copy.] on the camcorder screen.

#### HDR-CX690E:

Movies and photos that are stored in the memory card (inserted in the camcorder), and that have not yet been saved on to external media device can be saved on the connected media device at this time.

#### HDR-CX560E/CX560VE/CX700E/ CX700VE:

Movies and photos that are stored on one of the camcorder's recording media selected in [Media Select], and that have not yet been saved on external media device can be saved on the connected media device at this time.

- This operation is available only when there are newly recorded images.

6 After operation is completed, touch **OK** on the camcorder screen.

### When connecting an external media device

The images saved in the external media device are displayed on the LCD screen.

When an external media device is connected, the USB icon will appear on the Event View screen, etc.

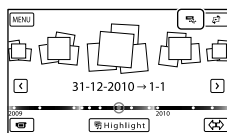

You can make menu settings of the external media device such as deleting images.

Touch **MENU** (MENU) → [Edit/Copy] on Event View.

### To disconnect the external media device

- 1 Touch **⏏** while the camcorder is in the playback standby mode ([Event View] or Event Index is displayed) of the external media device.
- 2 Disconnect the USB Adaptor Cable.

#### ⚙ Notes

- The number of scenes you can save on the external media device are as follows. However, even if the external media device has free space, you cannot save scenes exceeding the following number.
    - High definition image quality (HD) movies: Max. 3,999
    - Standard definition image quality (STD) movies: Max. 9,999
    - Photos: Max. 40,000
- The number of scenes may be smaller depending on the type of images recorded.

## Saving desired movies and photos

You can save desired images in the camcorder to the external media device.

- 1 Connect the camcorder to the external media device and touch [Play without copying].

Event View of the external medium is displayed.

- 2 Touch **MENU** (MENU) → [Edit/Copy] → [Copy].

- 3 Follow the instructions that appear on the screen to select the recording media (HDR-CX560E/CX560VE/CX700E/CX700VE), image selection methods and type of the image.

You cannot copy images from an external media device to the internal recording medium on the camcorder.

- 4 When you selected [Multiple Images], touch the image to be saved.

✓ appears.

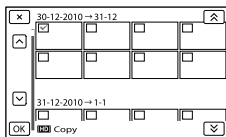

- Press and hold the image down on the LCD screen to confirm the image. Touch **X** to return to the previous screen.

- If you select [All In Event], select the event to copy with **▲** / **▼**. You cannot select multiple events.

- 5 Touch **OK** → **OK** → **OK** on the camcorder screen.

## Playing back images in the external media device on the camcorder

- 1 Connect the camcorder to the external media device and touch [Play without copying].

Event View of the external media device is displayed.

- 2 Select the image you want to view and play back the image (p. 28).

- You can also view images on a TV connected to your camcorder (p. 32).
- You can play back the high definition image quality (HD) movies on your computer using [Player for AVCHD]. Start [Player for AVCHD], and select the drive where the external media device is connected with [Settings].

## To perform [Direct Copy] manually

You can perform [Direct Copy] manually while the camcorder is connected to an external media device.

- ① Touch **MENU** (MENU) → [Edit/Copy] → [Direct Copy] on the [Event View] screen of the external media device.

② Touch [Copy images that have not been copied.].

③ Touch **OK** → **OK**.

⚡ Notes

- If your camcorder does not recognize the external media device, try the following operations.
  - Reconnect the USB Adaptor Cable to your camcorder.
  - If the external media device has the AC power cord (mains lead), connect it to the wall outlet (wall socket).

## Creating a disc with the DVD writer, DVDirect Express

You can create a disc or play back the images on a created disc by using the DVD writer, DVDirect Express (sold separately). Refer also to the instruction manual supplied with the DVD writer.

⚡ Notes

- Connect your camcorder to the wall outlet (wall socket) using the supplied AC Adaptor for this operation (p. 13).
- DVDirect Express is referred to as “DVD writer” in this section.

### Discs that can be used

- 12 cm DVD-R
- 12 cm DVD+R

The device does not support two-layered discs.

1 Connect the AC Adaptor and the power cord (mains lead) to the DC IN jack of your camcorder and the wall outlet (wall socket) (p. 13).

2 Turn on your camcorder, and connect the DVD writer to the  $\Psi$  (USB) jack of your camcorder with the USB cable of the DVD writer.

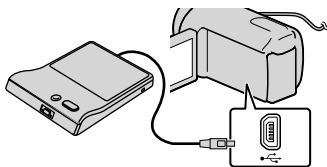

- You cannot use the Built-in USB Cable for this type of connection.



---

3 Insert an unused disc into the DVD writer, and close the disc tray.

---

4 Press  (DISC BURN) on the DVD writer.

• **HDR-CX690E**



Movies that are stored in the memory card (inserted in the camcorder), and that have not yet been saved on any disc can be saved on the disc at this time.

**HDR-CX560E/CX560VE/CX700E/  
CX700VE**

Movies that are stored on one of the camcorder's recording media selected in [Media Select], and that have not yet been saved on any discs can be saved on the disc at this time.

- When there are unsaved high definition (HD) and standard definition (STD) image quality movies, they will be saved on individual discs according to the image quality.
- If the files you want to copy do not fit onto one disc, replace the disc in the DVD writer with an unused one and repeat the operation.

---

5 After the operation is completed, touch  →  → (the tray opens) → remove the disc → touch  on the camcorder screen.

---

6 Touch , then disconnect the USB cable.

---

 Tips

- If the total memory size of movies to be burnt by the DISC BURN operation exceeds that of the disc, disc creation stops when the limit is reached. The last movie on the disc may be cut off.

Performing [DISC BURN OPTION]

Perform this operation in the following cases:

- When copying a desired image
- When creating multiple copies of the same disc

---

1 Connect the camcorder to the DVD writer and touch [DISC BURN OPTION].

---

2 Select the recording media containing the movie(s) you want to save (HDR-CX560E/CX560VE/CX700E/CX700VE) and touch [Next].

---

**3** Touch the movie you want to burn on the disc.

✓ appears.

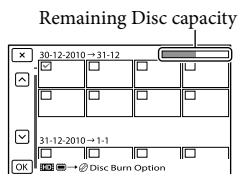

- Touch and hold the desired thumbnail so that you can confirm the image. Touch **✕** to return to the previous screen.

---

**4** Touch **OK** → **OK** on the camcorder screen.

To create another disc of the same contents, insert a new disc and touch [CREATE SAME DISC].

---

**5** After the operation is completed, touch [Exit.] → **✕** on the camcorder screen.

---

**6** Disconnect the USB cable from your camcorder.

---

**Notes**

- Do not do any of the following when creating a disc.
  - Turn off the camcorder
  - Disconnect the USB cable or the AC Adaptor
  - Subject the camcorder to mechanical shock or vibration
  - Eject the memory card from the camcorder

- Play the created disc to make sure copying was performed correctly before deleting the movies on your camcorder.
- If [Failed.] or [DISC BURN failed.] appears on the screen, insert another disc into the DVD writer and perform the DISC BURN operation again.

**Tips**

- Disc creation time to copy movies to the limit of the disc is about 20 to 60 minutes. It may take more time depending on the recording mode or the number of scenes.

---

## Playing back a disc on the DVD writer

---

**1** Connect the AC Adaptor and the power cord (mains lead) to the DC IN jack of your camcorder and the wall outlet (wall socket) (p. 13).

**2** Turn on your camcorder, and connect the DVD writer to the  $\Psi$  (USB) jack of your camcorder with the USB cable of the DVD writer.

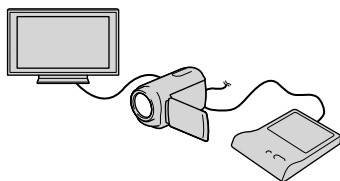

- You can play back movies on the TV screen by connecting the camcorder to a TV (p. 32).

- 
- 3** Insert a created disc into the DVD writer.

The movies on the disc appear on the index screen on the camcorder.

---

- 4** Press the play button on the DVD writer.

- You can also operate by the camcorder screen.
- 

- 5** After the operation is completed, touch **X** on the camcorder screen and remove the disc when the tray is open.
- 

- 6** Touch **OK** and disconnect the USB cable.
- 

## Creating a high definition image quality (HD) disc with a DVD writer, etc., other than DVDirect Express

Use the USB cable to connect your camcorder to a disc creation device, which is compatible with high definition image quality (HD) movies, such as a Sony DVD writer. Refer also to the instruction manuals supplied with the device to be connected.

### Notes

- Connect your camcorder to the wall outlet (wall socket) using the supplied AC Adaptor for this operation (p. 13).
- Sony DVD writer may not be available in some countries/regions.

- 1 Connect the AC Adaptor and the power cord (mains lead) to the DC IN jack of your camcorder and the wall outlet (wall socket) (p. 13).

- 2 Turn on your camcorder, and connect a DVD writer, etc. to your camcorder with the Built-in USB Cable.

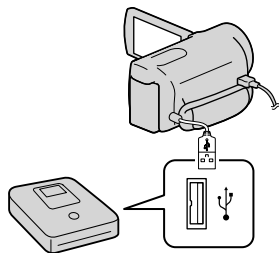

The [USB Select] screen appears on the camcorder screen.

- If the [USB Select] screen does not appear, touch **MENU** (MENU) → [Setup] → [↔(Connection)] → [USB Connect].

3 Touch [USB Connect] on the camcorder screen.

- The displayed recording media differ depending on the model.

4 Record movies on the connected device.

- For details, refer to the instruction manuals supplied with the device to be connected.

5 After the operation is completed, touch **X** → **OK** on the camcorder screen.

6 Disconnect the USB cable.

## Creating a standard definition image quality (STD) disc with a recorder, etc.

You can copy images played back on your camcorder on a disc or video cassette, by connecting your camcorder to a disc recorder, a Sony DVD writer, etc., other than DVDirect Express, with the A/V connecting cable. Connect the device in either way of **1** or **2**. Refer also to the instruction manuals supplied with the devices to be connected.

### ⓘ Notes

- Connect your camcorder to the wall outlet (wall socket) using the supplied AC Adaptor for this operation (p. 13).
- Sony DVD writer may not be available in some countries/regions.
- High definition image quality (HD) movies will be copied with standard definition image quality (STD).

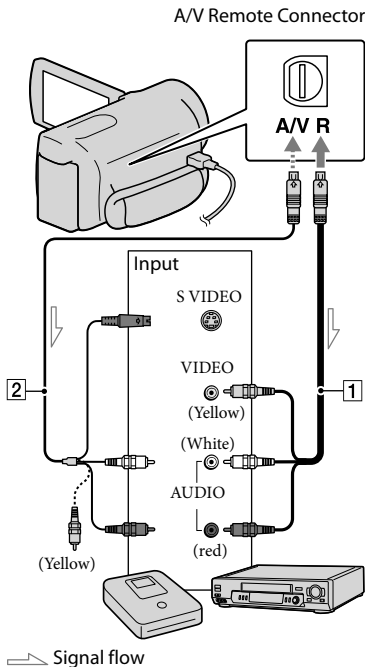

Signal flow

- 1 A/V connecting cable (supplied)
- 2 A/V connecting cable with S VIDEO (sold separately)

By using this cable, higher quality images can be produced than with an A/V connecting cable. Connect the white and red plug (left/right audio) and the S VIDEO plug (S VIDEO channel) of the A/V connecting cable with an S VIDEO cable. If you connect the S VIDEO plug only, you will hear no sound. The yellow plug (video) connection is not necessary.

- 1 Insert the recording media in the recording device.

- If your recording device has an input selector, set it to the input mode.

- 2 Connect your camcorder to the recording device (a disc recorder, etc.) with the A/V connecting cable 1 (supplied) or an A/V connecting cable with S VIDEO 2 (sold separately).

- Connect your camcorder to the input jacks of the recording device.

- 3 Start playback on your camcorder, and record it on the recording device.

- Refer to the instruction manuals supplied with your recording device for details.

- 4 When dubbing is finished, stop the recording device, and then your camcorder.

#### Notes

- Since copying is performed via analog data transfer, the image quality may deteriorate.
- You cannot copy images to recorders connected with an HDMI cable.
- To copy date/time information, camera data, and coordinates (HDR-CX560VE/CX700VE), touch **MENU** (MENU) → [Setup] → [ ] (Playback Settings) → [Data Code] → a desired setting → **OK**.
- When the screen size of display devices (TV, etc.) is 4:3, touch **MENU** (MENU) → [Setup] → [ ] (Connection) → [TV Type] → [4:3] → **OK**.
- When you connect a monaural device, connect the yellow plug of the A/V connecting cable to the video input jack, and the white (left channel) or the red (right channel) plug to the audio input jack on the device.

## Using menus

You can enjoy using your camcorder more by making good use of menu operations. The camcorder has various menu items under each of 6 menu categories.

 **Shooting Mode (Items for selecting a shooting mode)** → p. 55

 **Camera/Mic (Items for customized shooting)** → p. 55

 **Image Quality/Size (Items for setting up image quality or size)** → p. 56

 **Playback Function (Items for playback)** → p. 56

 **Edit/Copy (Items for editing)** → p. 57

 **Setup (Other setup items)** → p. 57

### Operating menus

Follow the procedures explained below to set the menu items.

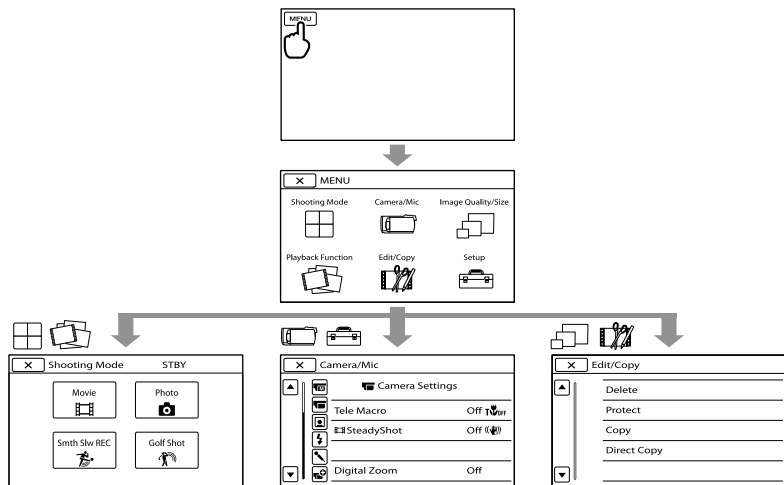

The [Camera/Mic] and [Setup] menus have sub-categories. Touch the sub-category icon, and the screen changes to other sub-category menus.

Grayed out menu items or settings are not available.

#### Notes

- You may not be able to set some menu items, depending on the recording or playback conditions.
- Touch  to finish setting the menu or to return to the previous menu screen.



## Menu lists

### Shooting Mode





- Movie ..... Records movies.
- Photo ..... Shoots photos.
- Smth Slw REC ..... Records fast moving subjects in slow-motion.
- Golf Shot ..... Divides two seconds of fast movement into frames which are then recorded as a movie and photos.

### Camera/Mic

#### (Manual Settings)

- White Balance ..... Adjusts the color balance to the brightness of the recording environment.
- Spot Meter/Fcs ..... Adjusts the brightness and focus for the selected subject simultaneously.
- Spot Meter ..... Adjusts the brightness of images to a subject you touch on the screen.
- Spot Focus ..... Focuses on a subject you touch on the screen.
- Exposure ..... Adjusts the brightness of movies and photos.
- Focus ..... Focuses manually.
- IRIS ..... Sharpens the subject with its background blurred or sharpens the whole image.
- Shutter Speed ..... Adjusts Shutter Speed. When you shoot a moving subject at a higher shutter speed, it appears as if frozen on the image. At a lower shutter speed, the subject appears as if it is flowing.
- AE Shift ..... Adjusts the exposure. Touch  if the subject is white or the backlight is bright, or touch  if the subject is black or the light is dim.
- White Balance Shift ..... Adjusts the white balance.
- Low Lux ..... Records bright color images in the dim.

#### (Camera Settings)

- Scene Selection ..... Selects an appropriate recording setting according to the type of scene, such as night view or beach.
-  Cinematone ..... Adjusts the color of the movie to resemble the atmosphere of films when recording.
-  Fader ..... Fades scenes in or out.
-  Self-Timer ..... Sets the self-timer when your camcorder is in photo recording mode.
- Tele Macro ..... Shoots a subject in focus with the background out of focus.
-  SteadyShot ..... Sets the SteadyShot function when recording movies.
-  SteadyShot ..... Sets the SteadyShot function when shooting photos.
- Digital Zoom ..... Sets the maximum zoom level of the digital zoom that exceeds the zoom level of the zoom.
- Conversion Lens ..... Sets the type of an attached conversion lens (sold separately). Optimizes the SteadyShot function and focus according to the attached lens.
- Auto Back Light ..... Adjusts the exposure for backlit subjects automatically.
- Dial Setting ..... Assigns a function to the MANUAL dial.
- NIGHTSHOT Light ..... Emits infrared light when using NightShot.

### (Face)

- Face Detection ..... Adjusts the image quality of the face(s) automatically.
- Smile Shutter ..... Automatically takes a shot whenever a smile is detected.
- Smile Sensitivity ..... Sets the smile detection sensitivity using the smile shutter function.

### (Flash)

- Flash ..... Sets how the flash is activated.
- Flash Level ..... Sets the brightness of flash.
- Red Eye Reduction ..... Prevents reddy when shooting with flash.

### (Microphone)







- Blt-in Zoom Mic ..... Records movies with vivid sound appropriate to the zoom position.
- Wind Noise Reduct. .... Reduces the wind noise.
- Audio Mode ..... Sets the recording sound format (5.1ch surround/2ch stereo).
- Micref Level ..... Sets the microphone level.

### (Shooting Assist)

- Expanded Focus\*<sup>1</sup> ..... Magnifies the image that appears at the center of the screen by about 2.0 times.
- Guide Frame ..... Displays the frame to make sure the subject is horizontal or vertical.
- Display Setting ..... Sets the duration that icons or indicators are displayed on the LCD screen.
- Zebra\*<sup>1</sup> ..... Displays a zebra pattern as a guide for adjusting brightness.
- Peaking\*<sup>1</sup> ..... Displays an image on the LCD screen with its outlines enhanced.
- Audio Level Display ..... Displays the audio level meter on the LCD screen.

## Image Quality/Size

---

-  REC Mode ..... Sets the mode to record movies. When recording fast moving subject, a high image quality is recommended.
-  Frame Rate ..... Sets the frame rate to record movies.
-  **HD** / **STD** Setting ..... Sets image quality for recording, playback, or editing movies.
-  Wide Mode ..... Sets the horizontal to vertical ratio when recording movies with standard definition image quality (STD).
-  x.v.Color ..... Records wider range of colors.
-  **Image Size** ..... Sets the photo size.

## Playback Function

---

- Event View ..... Shows the Event View display.
- Map View\*<sup>2</sup> ..... Shows the Map View display.
- Highlight Movie ..... Starts Highlight Playback.
-  Scenario ..... Starts playing Highlight Scenario that has been saved.



## Edit/Copy

- Delete..... Deletes movies or photos.
- Protect ..... Protects movies or photos to avoid deleting.
- Copy\*<sup>3</sup> ..... HDR-CX560E/CX560VE:  
Copies images from the selected internal recording medium to the inserted memory card.  
HDR-CX700E/CX700VE:  
Copies images back and forth between the selected internal recording medium and the inserted memory card.
- Direct Copy ..... Copies images stored on the internal recording medium or on a memory card to some type of external media.

## Setup

### (Media Settings)

- Media Select\*<sup>3</sup> ..... Sets the type of media to be used for recording movies or photos (p. 18).
- Media Info..... Displays information on the recording media, such as free space.
- Format..... Deletes all data on the internal recording media or a memory card.
- Repair Img. DB F..... Repairs the image database file on the internal recording media or a memory card (p. 62).
- File Number..... Sets how to assign the file number.

### (Playback Settings)

- Data Code ..... Sets the date and time.
- Volume..... Adjusts the volume of playback sound (p. 30).
- Download Music\*<sup>1</sup> ..... Download music files that can be played with Highlight Playback.
- Empty Music\*<sup>1</sup> ..... Deletes music files.

### (Connection)

- TV Type ..... Converts the signal depending on the TV connected (p. 32).
- Component..... Select this option when you connect your camcorder to a TV with the component input jack (p. 33).
- HDMI Resolution ..... Selects the output image resolution when connecting your camcorder to a TV with an HDMI cable (sold separately).
- CTRL FOR HDMI ..... Sets whether or not the TV's Remote Commander is to be used when the camcorder is connected to a "BRAVIA" Sync compatible TV with the HDMI cable (sold separately).
- USB Connect..... Selects which type of media on the camcorder is to be used when the camcorder is connected to an external device via USB.
- USB Connect Setting ... Sets the connection mode when the camcorder is connected to a computer or a USB device.
- USB LUN Setting..... Sets the camcorder to improve the compatibility of a USB connection by restricting some USB functions.
- Disc Burn ..... Allows you to save images onto discs by a single press of a button.

## (General Settings)

- Beep ..... Sets whether the camcorder sounds operation beeps or not.
- LCD Brightness ..... Adjusts the brightness of the LCD screen.
- Your Location\*<sup>2</sup> ..... Displays the current location on a map.
- GPS Setting\*<sup>2</sup> ..... Sets the GPS signal reception on or off.
- REC Lamp ..... Sets the recording lamp to light up or not.
- Remote Ctrl ..... Sets whether the Wireless Remote Commander is to be used or not.
- A. Shut Off ..... Changes the [A. Shut Off] setting (p. 13).
- Power On By LCD\*<sup>4</sup> ..... Sets whether or not the camcorder is turned on and off when you open and close the LCD screen.
- Language Setting ..... Sets the display language (p. 17).
- Calibration ..... Calibrates the touch panel.
- Battery Info ..... Displays the battery information.
- Demo Mode ..... Sets whether the demonstration appears or not.

## (Clock Settings)

- Date & Time Setting ..... Sets the [Date & Time Format], [Summer Time], or [Date & Time] (p. 15).
- Area Setting ..... Adjusts for a time difference without stopping the clock (p. 15).
- Auto Clock ADJ \*<sup>2</sup> ..... Sets whether the camcorder adjusts the clock automatically by acquiring the time from GPS or not.
- Auto Area ADJ\*<sup>2</sup> ..... Sets whether the camcorder compensates for a time differences automatically by acquiring the current location information from GPS or not.

---

\*<sup>1</sup> HDR-CX690E/CX700E/CX700VE

\*<sup>2</sup> HDR-CX560VE/CX700VE

\*<sup>3</sup> HDR-CX560E/CX560VE/CX700E/CX700VE

\*<sup>4</sup> HDR-CX560E/CX560VE

# Getting detailed information from the “Handycam” Handbook

The “Handycam” Handbook is a user guide designed to be read on a computer screen. The “Handycam” Handbook is intended to be read when you want to know more about operating your camcorder.

1 To install the “Handycam” Handbook on a Windows computer, place the supplied CD-ROM in the disc drive of your computer.

The installation screen appears.

- If the screen does not appear, click [Start] → [Computer] (in Windows XP, [My Computer]), then double-click [SONYPMB(E:)](CD-ROM)\* → [install.exe].

\* Drive names (such as (E:)) may vary depending on the computer.

2 Click [Handbook].

3 Click the desired language and the model name of your camcorder → [Install], and follow the on-screen instructions to install “Handycam” Handbook.

- The model name of your camcorder is printed on the bottom surface.

To view the “Handycam” Handbook, double-click the short-cut icon on the computer screen.



- When using a Macintosh, open the [Handbook] – [GB] folder in the CD-ROM, then copy [Handbook.pdf].
- You need Adobe Reader to read “Handycam” Handbook. If it is not installed on your computer, you can download it from the Adobe Systems web page: <http://www.adobe.com/>
- Refer to “PMB Help” for details on the supplied software “PMB” (p. 37).

## ? Troubleshooting

If you run into any problems using your camcorder, follow the steps below.

- 1 Check the list (p. 60 to 62), and inspect your camcorder.



- 2 Remove the power source, attach the power source again after about 1 minute, and turn the camcorder on.



- 3 Press RESET (p. 75) using a pointed object, and turn the camcorder on. If you press RESET, all settings, including the clock setting, are reset.



- 4 Contact your Sony dealer or local authorized Sony service facility.

- Your camcorder may be required to initialize or change the current internal memory (HDR-CX560E/CX560VE/CX700E/CX700VE) of your camcorder, depending on the problem. In the event of this, the data stored on the internal memory will be deleted. Be sure to save the data on the internal memory on other media (backup) before sending your camcorder for repair. We will not compensate you for any loss of internal memory data.
- During repair, we may check a minimum amount of data stored on the internal memory in order to investigate the problem. However, your Sony dealer will neither copy nor retain your data.
- See the "Handycam" Handbook (p. 59) for details on the symptoms of your camcorder, and "PMB Help" (p. 40) on connecting your camcorder to a computer.

### The power does not turn on.

- Attach a charged battery pack to the camcorder (p. 11).
- Connect the plug of the AC Adaptor to the

wall outlet (wall socket) (p. 13).

### The camcorder does not operate even when the power is set to on.

- It takes a few seconds for your camcorder to be ready to shoot after the power is turned on. This is not a malfunction.
- Disconnect the AC Adaptor from the wall outlet (wall socket) or remove the battery pack, then reconnect it after about 1 minute. If your camcorder still does not work, press RESET (p. 75) using a pointed object. (If you press RESET, all settings, including the clock setting, are reset.)
- The temperature of your camcorder is extremely high. Turn off the camcorder and leave it for a while in a cool place.
- The temperature of your camcorder is extremely low. Leave the camcorder with the power turned on. If you still cannot operate your camcorder, turn off the camcorder and take it to a warm place. Leave the camcorder there for a while, then turn on the camcorder.



### Your camcorder gets warm.

- Your camcorder may become warm during operation. This is not a malfunction.

### The power abruptly turns off.

- Use the AC Adaptor (p. 13).
- Turn on the power again.
- Charge the battery pack (p. 11).

### Pressing START/STOP or PHOTO does not record images.

- Press MODE to turn on the  (Movie) or  (Photo) lamp.
- Your camcorder is recording the image you have just shot on the recording media. You cannot make any new recordings during this period.
- The recording media is full. Delete unnecessary images (p. 35).

- Total number of movie scenes or photos has exceeded the recordable capacity of your camcorder (p. 64). Delete unnecessary images (p. 35).

---

### The recording stops.

- The temperature of your camcorder is extremely high/low. Turn off your camcorder and leave it for a while in a cool/warm place.

---

### "PMB" cannot be installed.

- Check the computer environment or installation procedure required to install "PMB" (p. 37).

---

### "PMB" does not work correctly.

- Quit "PMB" and restart your computer.

---

### The camcorder is not recognized by the computer.

- Disconnect devices from the USB jack of the computer other than the keyboard, mouse, and your camcorder.
- Disconnect the USB cable from the computer and your camcorder, and restart the computer, then connect the computer and your camcorder again in an orderly manner.
- When both the built-in USB cable and other USB cable (that is connected to the USB port on the camcorder) are connected to external devices at the same time, disconnect the one that is not connected to a computer.

## Self-diagnosis display/Warning indicators

If indicators appear on the LCD screen or viewfinder (HDR-CX690E/CX700E/CX700VE), check the following.

If the problem persists even after you have tried to fix a couple of times, contact your Sony dealer or local authorized Sony service facility. In this case, when you contact them, give them all the numbers of the error code beginning with C or E.

---

#### C:04:□□

- The battery pack is not an "InfoLITHIUM" battery pack V series. Use an "InfoLITHIUM" battery pack (V series) (p. 11).
- Connect the DC plug of the AC Adaptor to your camcorder securely (p. 11).

---

#### C:06:□□

- The battery pack temperature is high. Change the battery pack or place it in a cool place.

---

#### C:13:□□ / C:32:□□

- Remove the power source. Reconnect it and operate your camcorder again.

---

#### E:□□:□□

- Follow the steps from ② on page 60.



- Battery power is low.



- The battery pack temperature is high. Change the battery pack or place it in a cool place.



- No memory card is inserted (p. 19).
- When the indicator flashes, there is not enough free space for recording images. Delete unnecessary images (p. 35), or format the memory card after storing the images on other media.
- The Image Database File is damaged. Check the data base file by touching **MENU** (MENU) → [Setup] → [Media Settings] → [Repair Img. DB F.] → the recording medium (HDR-CX560E/CX560VE/CX700E/CX700VE).



- The memory card is damaged. Format the memory card with your camcorder (p. 57).



- Incompatible memory card is inserted (p. 19).



- The memory card is write-protected.
- Access to the memory card was restricted on another device.



- There is something wrong with the flash.



- The amount of light is not sufficient. Use the flash.
- The camcorder is unsteady. Hold the camcorder steady with both hands. However, note that the camera-shake warning indicator does not disappear.



- The recording media is full. Delete unnecessary images (p. 35).
- Photos cannot be recorded during processing. Wait for a while, then record.
- When [REC Mode] is set to [Highest Quality **FX**] or [50p Quality **PS**], you cannot capture photos while recording movies. Furthermore, if [Frame Rate] is set to [25p], you cannot record photos while the camcorder is in movie recording standby mode.

# Recording time of movies/number of recordable photos

“HD” stands for high definition image quality, and “STD” stands for standard image quality.

## Expected time of recording and playback with each battery pack

### Recording time

Approximate time available when you use a fully charged battery pack.

#### HDR-CX560E/CX560VE



(unit: minute)

Battery pack	Continuous recording time		Typical recording time	
	HD	STD	HD	STD
Image quality				
NP-FV50 (supplied)	125	130	60	65
NP-FV70	260	270	130	135
NP-FV100	515	535	255	265

#### HDR-CX690E/CX700E/CX700VE

(unit: minute)

Battery pack	Continuous recording time		Typical recording time	
	HD	STD	HD	STD
Image quality				
NP-FV50 (supplied)	125 135	130 140	60 65	65 70
NP-FV70	260 280	270 290	130 140	135 145
NP-FV100	515 555	535 580	255 275	265 290

- Top: When the LCD screen is opened  
Bottom: When recording with the viewfinder without opening the LCD screen
- Each recording time is measured when the camcorder is recording high definition image quality (HD) movies with [  REC Mode] set to [Standard  ].

- Typical recording time shows the time when you repeat recording start/stop, switching the MODE lamp, and zooming.
- Times measured when using the camcorder at 25 °C (77 °F). 10 °C to 30 °C (50 °F to 86 °F) is recommended.
- The recording and playback time will be shorter when you use your camcorder in low temperatures.
- The recording and playback time will be shorter depending on the conditions under which you use your camcorder.

### Playing time

Approximate time available when you use a fully charged battery pack.

#### HDR-CX560E/CX560VE

(unit: minute)

Battery pack	HD	STD
Image quality		
NP-FV50 (supplied)	215	225
NP-FV70	440	465
NP-FV100	870	925

#### HDR-CX690E/CX700E/CX700VE

(unit: minute)

Battery pack	HD	STD
Image quality		
NP-FV50 (supplied)	215 240	225 255
NP-FV70	440 490	465 525
NP-FV100	870 980	925 1045

- Top: When the LCD screen is opened  
Bottom: When playing with the viewfinder without opening the LCD screen

## Expected recording time of movies

### Internal recording media

#### HDR-CX560E/CX560VE

High definition image quality (HD) in h (hour) and m (minute)

Recording mode	Recording time	
	HDR-CX560E	HDR-CX560VE
[50p Quality <b>PS</b> ]	5 h 15 m (5 h 15 m)	5 h 10 m (5 h 10 m)
[Highest Quality <b>FX</b> ]	6 h 15 m (6 h 15 m)	6 h 10 m (6 h 10 m)
[High Quality <b>FH</b> ]	8 h 25 m (8 h 25 m)	8 h 20 m (8 h 20 m)
[Standard <b>HQ</b> ]	14 h 55 m (11 h 20 m)	14 h 40 m (11 h 10 m)
[Long Time <b>LP</b> ] (5.1ch)*	25 h 45 m (21 h 10 m)	25 h 25 m (20 h 50 m)
[Long Time <b>LP</b> ] (2ch)*	26 h 40 m (21 h 45 m)	26 h 20 m (21 h 30 m)

Standard definition image quality (STD) in h (hour) and m (minute)

Recording mode	Recording time	
	HDR-CX560E	HDR-CX560VE
[Standard <b>HQ</b> ] (5.1ch)*	15 h 25 m (14 h 15 m)	15 h 15 m (14 h 0 m)
[Standard <b>HQ</b> ] (2ch)*	15 h 55 m (14 h 35 m)	15 h 40 m (14 h 25 m)

#### HDR-CX700E/CX700VE

High definition image quality (HD) in h (hour) and m (minute)

Recording mode	Recording time	
	HDR-CX700E	HDR-CX700VE
[50p Quality <b>PS</b> ]	7 h 55 m (7 h 55 m)	7 h 50 m (7 h 50 m)
[Highest Quality <b>FX</b> ]	9 h 20 m (9 h 20 m)	9 h 15 m (9 h 15 m)
[High Quality <b>FH</b> ]	12 h 45 m (12 h 45 m)	12 h 35 m (12 h 35 m)

Recording mode	Recording time	
	HDR-CX700E	HDR-CX700VE
[Standard <b>HQ</b> ]	22 h 25 m (17 h 0 m)	22 h 15 m (16 h 50 m)
[Long Time <b>LP</b> ] (5.1ch)*	38 h 40 m (31 h 45 m)	38 h 20 m (31 h 30 m)
[Long Time <b>LP</b> ] (2ch)*	40 h 5 m (32 h 45 m)	39 h 45 m (32 h 30 m)

Standard definition image quality (STD) in h (hour) and m (minute)

Recording mode	Recording time	
	HDR-CX700E	HDR-CX700VE
[Standard <b>HQ</b> ] (5.1ch)*	23 h 10 m (21 h 20 m)	23 h 0 m (21 h 10 m)
[Standard <b>HQ</b> ] (2ch)*	23 h 55 m (21 h 55 m)	23 h 40 m (21 h 45 m)

\* You can change the recording sound format with [Audio Mode] (p. 56).

### Notes

- The number in ( ) is the minimum recordable time.

### Tips

- You can record movies of a maximum of 3,999 scenes with high definition image quality (HD), and 9,999 scenes with standard definition image quality (STD).
- The maximum continuous recording time of movies is approximately 13 hours.
- If you want to record up to the maximum recording time indicated in the table, you need to delete the demonstration movie on your camcorder (HDR-CX560E/CX560VE/CX700E/CX700VE).
- Your camcorder uses the VBR (Variable Bit Rate) format to automatically adjust image quality to suit the recording scene. This technology causes fluctuations in the recording time of the media. Movies containing quickly moving and complex images are recorded at a higher bit-rate, and this reduces the overall recording time.



## Memory card

### High definition image quality (HD)

	(unit: minute)				
	2 GB	4 GB	8 GB	16 GB	32 GB
<b>PS</b>	9 (9)	15 (15)	35 (35)	75 (75)	150 (150)
<b>FX</b>	10 (10)	20 (20)	40 (40)	85 (85)	180 (180)
<b>FH</b>	10 (10)	25 (25)	60 (60)	120 (120)	245 (245)
<b>HQ</b>	25 (15)	50 (35)	105 (80)	210 (160)	430 (325)
<b>LP</b> 5.1ch*	40 (35)	90 (70)	180 (150)	370 (300)	745 (610)
<b>LP</b> 2ch*	45 (35)	90 (75)	190 (155)	380 (310)	770 (630)

### Standard definition image quality (STD)

	(unit: minute)				
	2 GB	4 GB	8 GB	16 GB	32 GB
<b>HQ</b> 5.1ch*	25 (20)	50 (50)	110 (100)	220 (205)	445 (410)
<b>HQ</b> 2ch*	25 (25)	55 (50)	110 (100)	225 (210)	460 (420)

\* You can change the recording sound format with [Audio Mode] (p. 56).

#### ⚡ Notes

- The recordable time may vary depending on the recording and subject conditions and [REC Mode] and [Frame Rate] (p. 56).
- The number in ( ) is the minimum recordable time.

## Expected number of recordable photos

### Internal recording media (HDR-CX560E/CX560VE/CX700E/CX700VE)

You can record the maximum 40,000 photos.

### Memory card

	16:9 12.3M 42.3M
2 GB	360
4 GB	720
8 GB	1450
16 GB	2900
32 GB	5900

- The selected image size is effective when the  (Photo) lamp is lit.
- The number of recordable photos of memory card shown is for the maximum image size of your camcorder. The actual number of recordable photos is displayed on the LCD screen during recording (p. 72).
- The number of recordable photos of memory card may vary depending on the recording conditions.

#### ⚡ Notes

- The unique pixel array of Sony's ClearVid and the image processing system (BIONZ) allow still image resolution equivalent to the sizes described.

# Precautions

## Tips

- You can also use memory card with a capacity of under 1 GB for recording photos.
- The following list shows the bit-rate, pixels and aspect ratio of each recording mode (movie + audio, etc.).
  - High definition image quality (HD):
    - PS: Max. 28 Mbps 1,920 × 1,080 pixels/16:9
    - FX: Max. 24 Mbps 1,920 × 1,080 pixels/16:9
    - FH: Approx. 17 Mbps (average) 1,920 × 1,080 pixels/16:9
    - HQ: Approx. 9 Mbps (average) 1,440 × 1,080 pixels/16:9
    - LP: Approx. 5 Mbps (average) 1,440 × 1,080 pixels/16:9
  - Standard definition image quality (STD):
    - HQ: Approx. 9 Mbps (average) 720 × 576 pixels/16:9, 4:3
- The photo recording pixels and the aspect ratio.
  - Photo recording mode:
    - 4,672 × 2,628 dots/16:9
    - 3,504 × 2,628 dots/4:3
    - 2,112 × 1,584 dots/4:3
    - 640 × 480 dots/4:3
  - Dual recording:
    - 4,672 × 2,628 dots/16:9
    - 3,504 × 2,628 dots/4:3
  - Capturing a photo from a movie:
    - 1,920 × 1,080 dots/16:9
    - 640 × 360 dots/16:9
    - 640 × 480 dots/4:3

## On use and care

- Do not use or store the camcorder and accessories in the following locations:
  - Anywhere extremely hot, cold or humid. Never leave them exposed to temperatures above 60 °C (140 °F), such as under direct sunlight, near heaters or in a car parked in the sun. They may malfunction or become deformed.
  - Near strong magnetic fields or mechanical vibration. The camcorder may malfunction.
  - Near strong radio waves or radiation. The camcorder may not be able to record properly.
  - Near AM receivers and video equipment. Noise may occur.
  - On a sandy beach or anywhere dusty. If sand or dust gets in your camcorder, it may malfunction. Sometimes this malfunction cannot be repaired.
  - Near windows or outdoors, where the LCD screen, the viewfinder (HDR-CX690E/CX700E/CX700VE) or the lens may be exposed to direct sunlight. This damages the inside of the viewfinder (HDR-CX690E/CX700E/CX700VE) or the LCD screen.
- Operate your camcorder on DC 6.8 V/7.2 V (battery pack) or DC 8.4 V (AC Adaptor).
- For DC or AC operation, use the accessories recommended in these operating instructions.
- Do not let your camcorder get wet, for example, from rain or sea water. If your camcorder gets wet, it may malfunction. Sometimes this malfunction cannot be repaired.
- If any solid object or liquid gets inside the casing, unplug your camcorder and have it checked by a Sony dealer before operating it any further.
- Avoid rough handling, disassembling, modifying, physical shock, or impact such as hammering, dropping or stepping on the product. Be particularly careful of the lens.
- Keep the camcorder turning off when you are not using your camcorder.
- Do not wrap your camcorder with a towel, for example, and operate it. Doing so might cause heat to build up inside.

- When disconnecting the power cord (mains lead), pull it by the plug and not the cord (lead).
- Do not damage the power cord (mains lead) such as by placing anything heavy on it.
- Do not use a deformed or damaged battery pack.
- Keep metal contacts clean.
- If the battery electrolytic liquid has leaked:
  - Consult your local authorized Sony service facility.
  - Wash off any liquid that may have contacted your skin.
  - If any liquid gets in your eyes, wash with plenty of water and consult a doctor.

### When not using your camcorder for a long time

- To keep your camcorder in optimum state for a long time, turn it on and let it run by recording and playing back images about once a month.
- Use up the battery pack completely before storing it.

### LCD screen

- Do not exert excessive pressure on the LCD screen, as it may cause damage.
- If your camcorder is used in a cold place, a residual image may appear on the LCD screen. This is not a malfunction.
- While using your camcorder, the back of the LCD screen may heat up. This is not a malfunction.

### To clean the LCD screen

- If fingerprints or dust make the LCD screen dirty, it is recommended that you use a soft cloth to clean it.

### On handling the casing

- If the casing is soiled, clean the camcorder body with a soft cloth lightly moistened with water, and then wipe the casing with a dry soft cloth.
- Avoid the following to avoid damage to the finish:
  - Using chemicals such as thinner, benzene, alcohol, chemical cloths, repellent, insecticide and sunscreen

- Handling the camcorder with above substances on your hands
- Leaving the casing in contact with rubber or vinyl objects for a long period of time

### About care and storage of the lens

- Wipe the surface of the lens clean with a soft cloth in the following instances:
  - When there are fingerprints on the lens surface
  - In hot or humid locations
  - When the lens is exposed to salty air such as at the seaside
- Store in a well-ventilated location subject to little dirt or dust.
- To prevent mold, periodically clean the lens as described above.

### On charging the pre-installed rechargeable battery

Your camcorder has a pre-installed rechargeable battery to retain the date, time, and other settings even when the camcorder is turned off. The pre-installed rechargeable battery is always charged while your camcorder is connected to the wall outlet (wall socket) via the AC Adaptor or while the battery pack is attached. The rechargeable battery will be fully discharged in about 3 months if you do not use your camcorder at all. Use your camcorder after charging the pre-installed rechargeable battery. However, even if the pre-installed rechargeable battery is not charged, the camcorder operation will not be affected as long as you are not recording the date.

#### Procedures

Connect your camcorder to a wall outlet (wall socket) using the supplied AC Adaptor, and leave it with the LCD screen closed for more than 24 hours.

### Note on disposal/transfer of the camcorder (HDR-CX560E/CX560VE/CX700E/CX700VE)

Even if you delete all movies and still images, or perform [Format], data on the internal recording media may not be completely erased. When you transfer the camcorder, it is

# Specifications

recommended that you perform [Empty] (See “Getting detailed information from the “Handycam” Handbook” on page 59.) to prevent the recovery of your data. Also, when you dispose of the camcorder, it is recommended that you destroy the actual body of the camcorder.

## Note on disposal/transfer of memory card

Even if you delete data in the memory card or format the memory card on your camcorder or a computer, you may not delete data from the memory card completely. When you give the memory card to somebody, it is recommended that you delete data completely using data deletion software on a computer. Also, when you dispose of the memory card, it is recommended that you destroy the actual body of the memory card.

## To change the battery of the Wireless Remote Commander

- ① While pressing on the tab, inset your fingernail into the slit to pull out the battery case.
- ② Place a new battery with the + side facing up.
- ③ Insert the battery case back into the Wireless Remote Commander until it clicks.

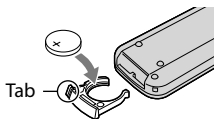

### WARNING

Battery may explode if mistreated. Do not recharge, disassemble or dispose of in fire.

- When the lithium battery becomes weak, the operating distance of the Wireless Remote Commander may shorten, or the Wireless Remote Commander may not function properly. In this case, replace the battery with a Sony CR2025 lithium battery. Use of another battery may present a risk of fire or explosion.

## System

Signal format: PAL color, CCIR standards  
HDTV 1080/50i, 1080/50p specification

Movie recording format:

HD: MPEG-4 AVC/H.264 AVCHD format compatible (1080 50p/original format)  
STD: MPEG2-PS

Audio recording system:

Dolby Digital 2ch/5.1ch  
Dolby Digital 5.1 Creator

Photo file format

DCF Ver.2.0 Compatible  
Exif Ver.2.3 Compatible  
MPF Baseline Compatible

Recording media (Movie/Photo)

Internal memory  
HDR-CX560E/CX560VE: 64 GB  
HDR-CX700E/CX700VE: 96 GB  
“Memory Stick PRO Duo” media  
SD card (Class 4 or faster)

When measuring media capacity, 1 GB equals 1 billion bytes, a portion of which is used for system management and/or application files. The capacity that a user can use is below.

HDR-CX560E:  
approximately 63.9 GB  
HDR-CX560VE:  
approximately 63.1 GB  
HDR-CX700E:  
approximately 96.0 GB  
HDR-CX700VE:  
approximately 95.2 GB

Viewfinder: Electronic viewfinder: color (HDR-CX690E/CX700E/CX700VE)

Image device: 6.2 mm (1/2.88 type) CMOS sensor  
Recording pixels (photo, 16:9):  
Max. 12.3 mega (4 672 × 2 628) pixels\*1  
Gross: Approx. 6 648 000 pixels  
Effective (movie, 16:9)\*2:  
Approx. 6 140 000 pixels  
Effective (photo, 16:9):  
Approx. 6 140 000 pixels  
Effective (photo, 4:3):  
Approx. 4 600 000 pixels

## Lens: G lens

10 × (Optical)<sup>\*2</sup>, 14 × (Extended)<sup>\*3</sup>, 120 × (Digital)

Filter diameter: 37 mm (1 1/2 in.)

F1.8 ~ 3.4

Focal length:

f=3.8 mm ~ 38.0 mm (5/32 in. ~ 1 1/2 in.)

When converted to a 35 mm still camera

For movies<sup>\*2</sup>: 26.3 mm ~ 263 mm (1 1/16 in. ~ 10 3/8 in.) (16:9)

For photos: 26.3 mm ~ 263 mm (1 1/16 in. ~ 10 3/8 in.) (16:9)

Color temperature: [Auto], [One Push], [Indoor] (3 200 K), [Outdoor] (5 800 K)

## Minimum illumination

11 lx (lux) (in default setting, shutter speed 1/50 second)

3 lx (lux) ([Low Lux] is set to [On], shutter speed 1/25 second)

0 lx (lux) (NIGHTSHOT is set to [On])

<sup>\*1</sup> The unique pixel array of Sony's ClearVid and the image processing system (BIONZ) allow still image resolution equivalent to the sizes described.

<sup>\*2</sup> [SteadyShot] is set to [Standard] or [Off].

<sup>\*3</sup> [SteadyShot] is set to [Active].

## Input/Output connectors

A/V Remote Connector: Component/video and audio output jack

HDMI OUT jack: HDMI mini connector

USB jack: mini-AB/Type A (Built-in USB) (HDR-CX560E/CX560VE: output only)

Headphone jack: Stereo minijack (φ 3.5 mm)

MIC input jack: Stereo minijack (φ 3.5 mm)

## LCD screen

Picture: 7.5 cm (3.0 type, aspect ratio 16:9)

Total number of pixels: 921 600 (1 920 × 480)

## General

Power requirements: DC 6.8 V/7.2 V (battery pack) DC 8.4 V (AC Adaptor)

USB Charging: DC 5 V 500 mA

Average power consumption:

HDR-CX560E/CX560VE:

HD: 3.0 W STD: 2.9 W

HDR-CX690E/CX700E/CX700VE:

During camera recording using the viewfinder at normal brightness:

HD: 2.8 W STD: 2.7 W

During camera recording using LCD screen at normal brightness:

HD: 3.0 W STD: 2.9 W

Operating temperature: 0 °C to 40 °C (32 °F to 104 °F)

Storage temperature: -20 °C to +60 °C (-4 °F to +140 °F)

Dimensions (approx.):

HDR-CX560E/CX560VE:

62 mm × 67 mm × 126 mm (2 1/2 in. × 2 3/4 in. × 5 in.) (w/h/d) including the projecting parts

62 mm × 67 mm × 133.5 mm (2 1/2 in. × 2 3/4 in. × 5 3/8 in.) (w/h/d) including the projecting parts, and the supplied rechargeable battery pack attached

HDR-CX690E/CX700E/CX700VE:

62 mm × 72.5 mm × 139 mm (2 1/2 in. × 2 7/8 in. × 5 1/2 in.) (w/h/d) including the projecting parts

92 mm × 76.5 mm × 174 mm (3 5/8 in. × 3 1/8 in. × 6 7/8 in.) (w/h/d) including the projecting parts, the supplied lens hood, and the supplied rechargeable battery pack attached

Mass (approx.)

HDR-CX560E/CX560VE:

385 g (13 oz) main unit only

435 g (15 oz) including the supplied rechargeable battery pack

HDR-CX690E/CX700E/CX700VE:

395 g (14 oz) main unit only

490 g (1 lb 1 oz) including the supplied lens hood and the supplied rechargeable battery pack

## AC Adaptor AC-L200C/AC-L200D

Power requirements: AC 100 V - 240 V,  
50 Hz/60 Hz

Current consumption: 0.35 A - 0.18 A

Power consumption: 18 W

Output voltage: DC 8.4 V\*

Operating temperature: 0 °C to 40 °C (32 °F to  
104 °F)

Storage temperature: -20 °C to +60 °C (-4 °F to  
+140 °F)

Dimensions (approx.): 48 mm × 29 mm × 81 mm  
(1 15/16 in. × 1 3/16 in. × 3 1/4 in.) (w/h/d)  
excluding the projecting parts

Mass (approx.): 170 g (6.0 oz) excluding the  
power cord (mains lead)

\* See the label on the AC Adaptor for other  
specifications.

## Rechargeable battery pack NP-FV50

Maximum output voltage: DC 8.4 V

Output voltage: DC 6.8 V

Maximum charge voltage: DC 8.4 V

Maximum charge current: 2.1 A

Capacity

Typical: 7.0 Wh (1 030 mAh)



Minimum: 6.6 Wh (980 mAh)

Type: Li-ion

Design and specifications of your camcorder and  
accessories are subject to change without notice.

- Manufactured under license from Dolby  
Laboratories.

## On trademarks

- “Handycam” and **HANDYCAM** are registered trademarks of Sony Corporation.
- “AVCHD” and “AVCHD” logotype are trademarks of Panasonic Corporation and Sony Corporation.
- “Memory Stick,”  “Memory Stick Duo,” **“MEMORY STICK DUO”**, “Memory Stick PRO Duo,” **“MEMORY STICK PRO DUO”**, “Memory Stick PRO-HG Duo,” **“MEMORY STICK PRO-HG DUO”**, “MagicGate,” **“MAGICGATE”** “MagicGate Memory Stick” and “MagicGate Memory Stick Duo” are trademarks or registered trademarks of Sony Corporation.
- “InfoLITHIUM” is a trademark of Sony Corporation.
- “x.v.Colour” is a trademark of Sony Corporation.
- “BIONZ” is a trademark of Sony Corporation.
- **S-MASTER** is a registered trademark of Sony Corporation.
- “BRAVIA” is a registered trademark of Sony Corporation.
- “DViDirect” is a trademark of Sony Corporation.
- Blu-ray Disc™ and Blu-ray™ are trademarks of the Blu-ray Disc Association.
- Dolby and the double-D symbol are trademarks of Dolby Laboratories.
- HDMI, the HDMI logo and High-Definition Multimedia Interface are trademarks or registered trademarks of HDMI Licensing LLC in the United States and other countries.
- Microsoft, Windows, Windows Vista, and DirectX are either registered trademarks or trademarks of Microsoft Corporation in the United States and/or other countries.
- Macintosh and Mac OS are registered trademarks of Apple Inc. in the U.S. and other countries.
- Intel, Intel Core, and Pentium are trademarks or registered trademarks of Intel Corporation or its subsidiaries in the United States and other countries.
-  and “PlayStation” are registered trademarks of Sony Computer Entertainment Inc.
- Adobe, the Adobe logo, and Adobe Acrobat are either registered trademarks or trademarks of Adobe Systems Incorporated in the United States and/or other countries.

- NAVTEQ and the NAVTEQ Maps logo are trademarks of NAVTEQ in the US and other countries.
- SDXC logo is a trademark of SD-3C, LLC.
- MultiMediaCard is a trademark of MultiMediaCard Association.

All other product names mentioned herein may be the trademarks or registered trademarks of their respective companies. Furthermore, <sup>TM</sup> and ® are not mentioned in each case in this manual.



Add further enjoyment with your PlayStation 3 by downloading the application for PlayStation 3 from PlayStation Store (where available.)

The application for PlayStation 3 requires PlayStation Network account and application download.

Accessible in areas where the PlayStation Store is available.

## Screen indicators

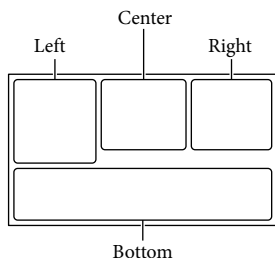

## Left

Indicator	Meaning
	MENU button
	Self-timer recording
	GPS triangulating status
	Wide Mode
	Fader
	[Face Detection] set to [Off]
	[Smile Shutter] set to [Off]
	Manual focus
	Scene Selection
	White Balance
	SteadyShot off
	White Balance Shift
	Tele Macro
	x.v.Color
	Conversion Lens
	Zebra
	Peaking
	Cinematone
	Destination
	Intelligent Auto (face detection/scene detection/camera-shake detection)

## Center

Indicator	Meaning
	Recording status
	Slide show set
	NightShot
	Warning
	Playback mode

## Right

Indicator	Meaning
	Recording image quality (HD/STD), frame rate (50p/50i/25p) and recording mode (PS/FX/FH/HQ/LP)
	Remaining battery
	Recording/playback/editing media
	Counter (hour:minute:second)
	Estimated recording remaining time
	Photo size
	Approximate number of recordable photos and photo size
	Playback folder
	Current playing movie or photo/Number of total recorded movies or photos

## Bottom

Indicator	Meaning
	View Images button
	Micref Level low
	Wind Noise Reduct.
	Blt-in Zoom Mic
	Audio Mode
	Audio Level Display
	Low Lux



# Parts and controls

Indicator	Meaning
	Spot Meter/Fcs/ Spot Meter/ Exposure
EV	AE Shift
10000	Shutter Speed
F1.4	IRIS
iAUTO	Intelligent Auto
	Slide show button
101-0005	Data file name
	Protected image
	Flash/ Red Eye Reduction

- Indicators and their positions are approximate and may differ from what you actually see.
- Some indicators may not appear, depending on your camcorder model.

Figures in ( ) are reference pages.

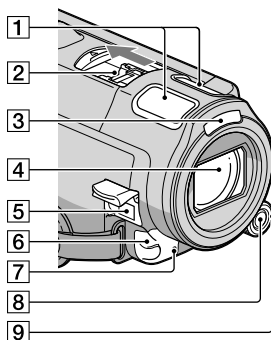

- 1 Built-in microphone
- 2 Active Interface Shoe



The Active Interface Shoe supplies power to optional accessories such as a video light, a flash, or a microphone. The accessory can be turned on or off as you operate the POWER switch on your camcorder.

- 3 Flash

#### 4 Lens (G lens)

##### Attaching the lens hood (HDR-CX690E/ CX700E/CX700VE)

Align the lens hood with the camcorder properly, then turn the securing ring of the lens hood in the direction of the arrow.

- When attaching the lens hood, align the opening section of the lens hood with the flash-emitting section of the camcorder properly.

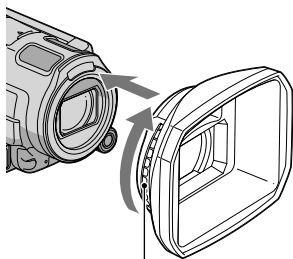

Securing ring

##### To remove the lens hood

Turn the securing ring of the lens hood in the opposite direction from that of the arrow to remove the lens hood.

- When recording movies using the NightShot function, remove the lens hood. If you do not do so, the shadow of the lens hood will be reflected and recorded in your movies. Remove the lens hood when you operate the camcorder with the supplied remote commander.

#### 5 DC IN jack (11)

#### 6 Remote sensor/Infrared port

#### 7 Camera recording lamp (58)

The camera recording lamp lights up in red during recording. The lamp flashes when the remaining recording media capacity or battery power is low.

#### 8 MANUAL button (27)

#### 9 MANUAL dial (27)

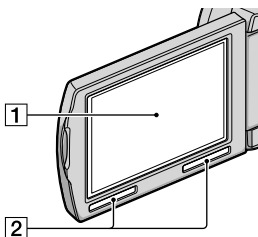

#### 1 LCD screen/Touch panel

If you rotate the LCD panel 180 degrees, you can close the LCD panel with the LCD screen facing out. This is convenient during playback operations.



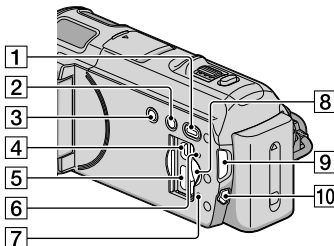

#### 2 Speaker

### HDR-CX560E/CX560VE

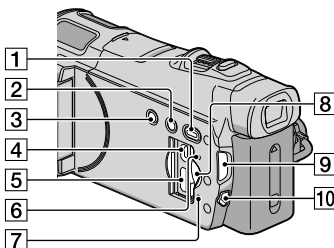

### HDR-CX690E/CX700E/CX700VE



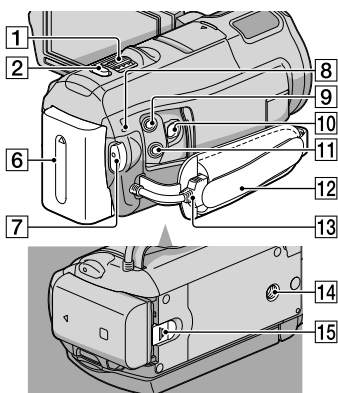

- 1  (View Images) button (28)
- 2 NIGHTSHOT button (27)
- 3 POWER button (15)
- 4  (USB) jack (45, 48)
- 5 HDMI OUT jack (32)
- 6 RESET button  
Press RESET using a pointed object.  
Press RESET to initialize all the settings including the clock setting.
- 7 Memory card access lamp (20)  
While the lamp is lit or flashing, the camcorder is reading or writing data.
- 8 Memory card slot (20)
- 9  (Movie)/ (Photo) lamps (22)
- 10 MODE button (22)

### HDR-CX560E/CX560VE

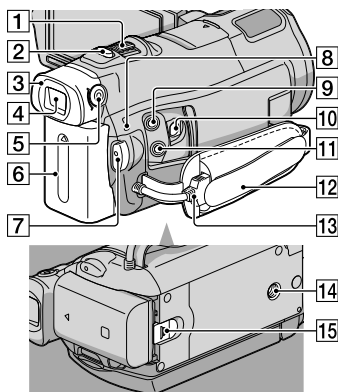

### HDR-CX690E/CX700E/CX700VE



- 1 Power zoom lever
- 2 PHOTO button (24)
- 3 Eyecup (HDR-CX690E/CX700E/CX700VE)
- 4 Viewfinder (HDR-CX690E/CX700E/CX700VE) (23)
- 5 Viewfinder lens adjustment lever (HDR-CX690E/CX700E/CX700VE) (23)
- 6 Battery pack (11)
- 7 START/STOP button (22)
- 8  (flash/charge) lamp (11)
- 9 MIC (PLUG IN POWER) jack
- 10 A/V Remote Connector (32)
- 11  (headphones) jack
- 12 Grip belt (21)
- 13 Built-in USB Cable (12)
- 14 Tripod receptacle (27)
- 15 BATT (battery) release lever (13)

# Index

- A**
  - A/V connecting cable.....33, 53
- B**
  - Battery pack.....11
  - Built-in USB Cable.....5, 12
- C**
  - Care .....66
  - Charging the battery pack .....11
  - Charging the battery pack abroad .....14
  - Clock Set.....15
  - Computer.....37
  - Computer system.....37
  - Connection.....32
  - Copy .....20
- D**
  - Data Code.....16
  - Date/Time.....16
  - Delete .....35
  - Disc recorder.....52
  - DVDirect Express.....48
  - DVD writer.....48, 51
- E**
  - Event Index.....28
  - Event View.....28
  - External media.....45
- F**
  - Fully charged.....11
- G**
  - GPS.....25
- H**
  - “Handycam” Handbook.....59
  - Highlight Playback.....31
- I**
  - Install.....37
- L**
  - Language Setting .....17
- M**
  - Macintosh .....37
  - Maintenance.....66
  - MANUAL dial.....27
  - Media Select .....18
  - Media Settings.....18
  - Memory card.....19
  - “Memory Stick” media.....19
  - “Memory Stick PRO-HG Duo” media.....19
  - “Memory Stick PRO Duo” media.....19
  - Menus.....55
  - Movies.....22, 30
- N**
  - NightShot.....27
- P**
  - Photos .....24, 31
  - Playing.....28
  - PMB (Picture Motion Browser).....40
  - Power on .....15
  - Precautions .....66
  - PS.....26
- R**
  - Recording .....21
  - Recording and playback time ..63
  - Recording media.....18
  - Recording time of movies/  
number of recordable photos...63
  - Repair .....60
  - RESET .....75
- S**
  - Saving images in external  
media.....45
  - Screen indicators .....72
  - Self-diagnosis display.....61
  - Setting the date and time .....15
  - Software .....37
  - Specifications .....68
  - Supplied items.....5
- T**
  - Thumbnail .....35
  - Tripod.....27, 75
  - Troubleshooting.....60
  - Turning the power on .....15
  - TV.....32
- U**
  - USB cable.....48, 51
- V**
  - VBR .....64
- W**
  - Wall outlet (wall socket) .....11
  - Warning indicators.....61
  - Windows.....37

You will find the menu lists on pages 55 to 58.







Additional information on this product and answers to frequently asked questions can be found at our Customer Support Website.

<http://www.sony.net/>

