

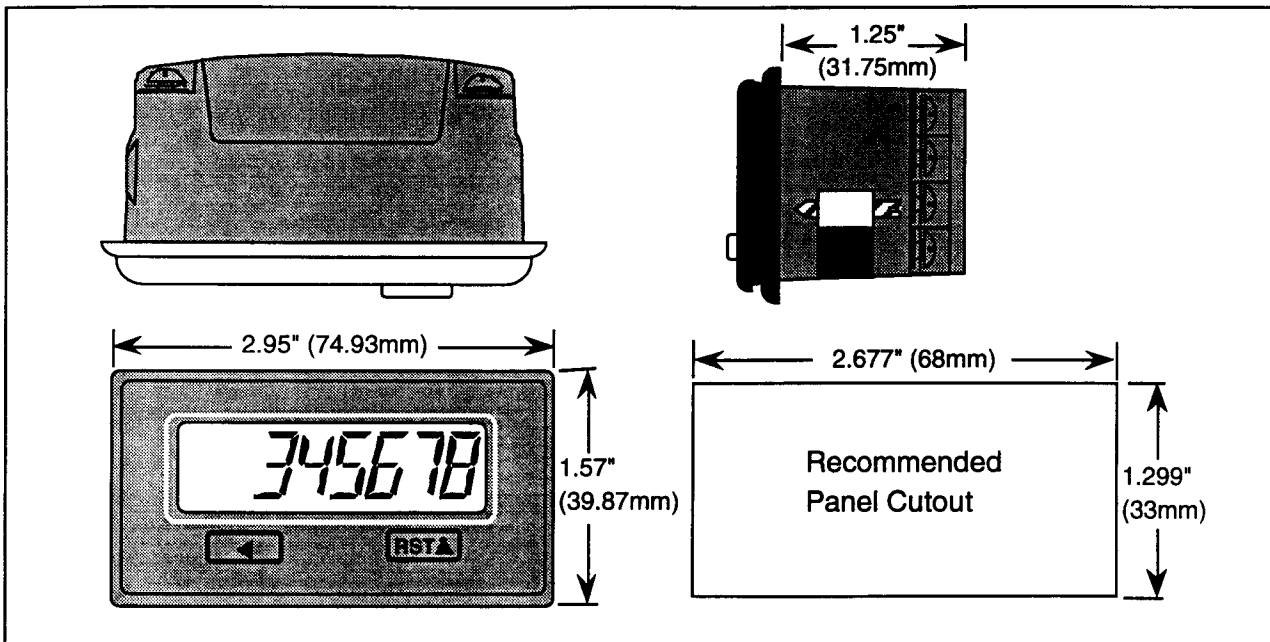

# DPC10-CS Add/Subtract Totalizer (Solid State Inputs)

# DPC10-CC Add/Subtract Totalizer (Contact Inputs)

M1663/0693



## POWER

Internal battery: 3V, lithium  
 Life expectancy: 5 years +  
 Replacement Part: DPC10-BAT

## PHYSICAL

Operation Temperature: 0° - 55°C  
 Storage Temperature: -20 to 70°C  
 Operating Humidity: 90% Non-condensing  
 Weight: 2.2 oz. net  
 Display Size: .43" high  
 Front Panel Rating: NEMA-4X when mounted with gasket provided  
 Case Material: Cylolac X-17

## TOTALIZER

Type: Up/Down Counting  
 Digits: 8 digits positive/minus sign and 7 digits negative  
 Scaler: 0.0001 - 100.0000  
 (0.0000 scales by 100)  
 Decimal Point: 5 positions, programmable

## DC COMMON (Terminal 1)

### EXTERNAL RESET INPUT (Terminal 4)

Resets totalizer when connected to dc common.  
 Minimum Low Time: 0.25 to 1.0 sec. (maintained)  
 The required pulse width varies with count speed, scale factor and number of digits displayed.  
 Voltage Thresholds: Low 0 to 0.4 V dc  
 High 2.0 to 28 V dc

## COUNT INPUT A (SUBTRACT); COUNT INPUT B (ADD) (TERMINALS 2&3)

### DPC10-CS

Inputs A & B require a voltage source, such as a current sourcing sensor or a current sinking sensor used with the provided pull up resistors.

Speed: 0 to 10 kHz  
 Minimum Low Time: 80 microseconds  
 Minimum High Time: 20 microseconds  
 (These times are with a 0.0V to 5.0 V swing.)  
 Input Impedance: 2KΩ above 5 V dc  
 Voltage Thresholds: Low 0 to 1.2 V dc, High 2.0 to 28 V dc, Maximum High 28 V dc

### DPC10-CC

Inputs A & B are designed for contact closures to dc common.

Speed: 0 to 20 Hz  
 Minimum Low Time: 10 milliseconds  
 Minimum High Time: 40 milliseconds  
 Input Impedance: 101 kΩ  
 Voltage Thresholds: Low 0 to 0.4 V dc  
 High 2.0 to 28 V dc  
 Maximum High 28 V dc

## PROGRAM ENABLE INPUT (Terminal 5)

Operation: Level sensitive (maintained)

## COUNT ACCURACY

Absolute when operated within specifications.

## INTRODUCTION

Your OMEGA DPC10-CS or DPC10-CC is a counter with an eight-digit LCD display. A programmable scaler and decimal point allow for display in any engineering unit.

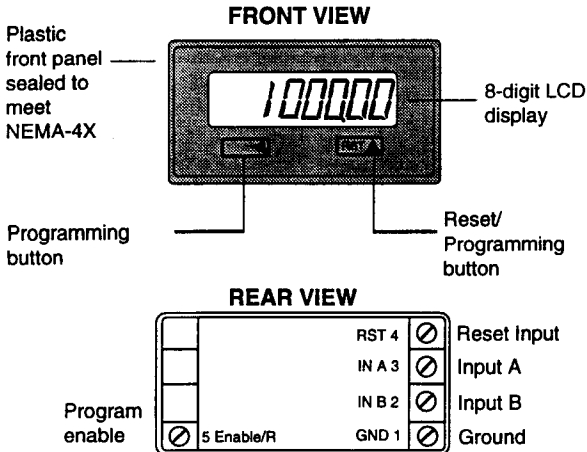

## APPLICATION

You must make certain programming and wiring choices to accomplish your application. We recommend the following sequence:

1. Answer the following questions:
  - What type of sensor will be used?
  - What engineering units should the counter be scaled to?
  - How many pulses per item is the sensor providing?
  - Is a decimal point needed on the display?
2. Calculate the scale factor.

## MOUNTING

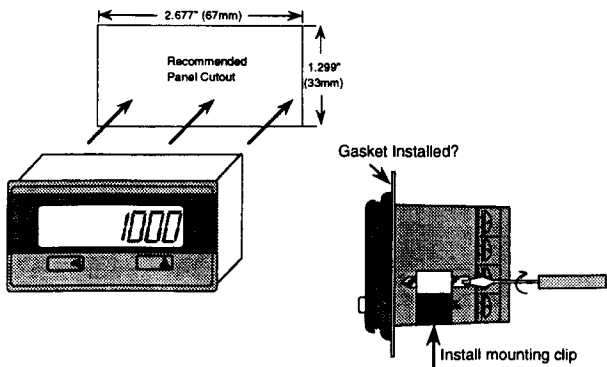

## PROGRAM MODE

**NOTE:** To enter the program mode, you must connect a jumper between terminals 1 and 5 (see page 4). To leave the program mode, disconnect the jumper.

### Screens

There are four program-mode screens in the DPC10-CS and DPC10-CC. Upon entering the setup mode, the counter will display screen 1. Press and hold the key while repeatedly pressing the key to advance to successive screens.

Programming Screens	
Screen	Function
1	Count Scale Factor
2	Count Decimal Point
3	Reset to Offset Value
4	Reset Key Enable / Disable

## OPERATION

### Add/Subtract Counting

There are two count input terminals on the rear of the totalizer. Count pulses entering Input A (terminal 3) cause the total to decrement (count down). Count pulses entering Input B (terminal 2) cause the total to increment (count up). The totalizer may start counting from zero, when reset, or may start from a user-programmed offset value. The offset value is a positive number and may be up to six digits.

If only one of the count inputs is used, the totalizer becomes an up counter with a range of zero to 99,999,999, or a down counter with a range of zero to -9,999,999. If both inputs are used, the totalizer displays the difference count between the two inputs - counts at Input B are added, counts at Input A are subtracted. In this mode of operation, the totalizer's range is -9,999,999 to 99,999,999. Positive numbers are not indicated with a plus sign(+). Both inputs may occur simultaneously, in which case the displayed total does not change.

### Count Inputs

The DPC10-CS has hi-speed inputs and can accept pulses from solid state, current sourcing sensors at up to 10 kHz per input. The sensor must supply at least +2.0 V dc, but not more than +28 V dc to the input. Counts are entered on the positive-going edge of the pulse.

The DPC10-CC has low speed inputs and can accept pulses from solid state, current sinking sensors or contact closures to ground at up to 20 Hz per input. These inputs are internally pulled up to +3 V dc. The sensor must be capable of sinking current from the input to bring the input voltage down to +0.4 V dc or less. Counts are entered on the negative-going edge of the pulse.

## COUNT SCALER

### Calculating the Count Scale Factor

The count scale factor is used to convert the incoming count pulses to the desired unit of measure to be displayed (feet, gallons, etc.) or to correct for a known amount of error (wheel wear, viscosity, etc.). This scaler has six digits available with a fixed decimal point.

Count Scaler Range: 0.0001 to 99.9999

(Setting the count scale factor to 0.0000 will allow scaling by 100)

Count Scaler (CS) Formula:

$$CS = \frac{DPF}{PPI}$$

where:

DPF is the decimal point factor corresponding to the desired decimal point location.

DISPLAY	DPF	DISPLAY	DPF
XXXXXX	= 1	XXX.XXX	= 1,000
XXXXX.X	= 10	XX.XXXX	= 10,000
XXXX.XX	= 100		

PPI is the number of pulses per item from the sensor.

**Example 1:** A sensor produces 20 pulses per inch of material travel. Calculate the count scaler required to indicate material used in whole inches (XXXXXX).

$$CS = \frac{1}{20} = 0.05000$$

**Example 2:** An encoder produces 120 pulses per foot. Calculate the count scaler required to indicate material usage in 1/100's of feet (XXXX.XX).

$$CS = \frac{100}{120} = 0.8333$$

(Select the XXXX.XX position on the totalizer decimal point menu).

### Programming Count Scale Factor

The first screen in the program mode is used to enter the count scale factor.

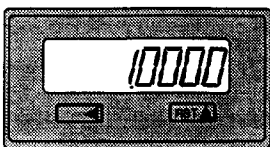

The far right digit will be flashing. Press the **RST** key until reaching the desired digit value.

**Note:** Pressing and holding the **RST** key will cause the numbers to autoscroll.

Next press the **←** key to move the flashing digit one place to the left. Change this digit to the desired value with the **RST** key.

Repeat this process until all digits are set correctly.

### Programming Decimal Point

The second screen is used to enter the decimal point display on the totalizer screen. Press and hold the **←** key and then press the **RST** key to move from screen one to screen two.

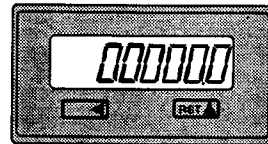

Press the **RST** key to move the decimal point to the desired position.

### Programming Offset Value

Programming an offset value allows the counter to reset to a value other than zero. The offset may be up to six digits. The offset cannot be a negative number.

The third screen in the program mode is used to enter the offset value.

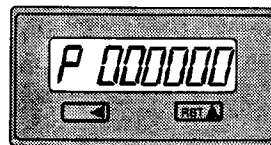

The far right digit will be flashing. Press the **RST** key until reaching the desired digit value.

**Note:** Pressing and holding the **RST** key will cause the numbers to autoscroll.

Next press the **←** key to move the flashing digit one place to the left. Change this digit to the desired value with the **RST** key. Repeat this process until all digits are set correctly.

## Enabling the Front Panel Reset Key

The fourth screen in the program mode allows you to enable or disable the front panel reset key.



Press the **RST** key to choose the option you want.

**Note:** The reset terminal on the rear panel is still active when the front reset button is disabled.

**Note:** To exit the program mode, disconnect the jumper between terminals 1 and 5.

## WIRING RECOMMENDATIONS

Following these suggestions will increase noise immunity and lengthen unit life.

**Cable:** Make the connection between the count source and the totalizer with a two-conductor shielded cable. Connect the shield to earth ground at one end only.

**Relay Coil Suppression:** If a relay contact is used as a count source, suppress the relay coil. This can be accomplished with an RC network for AC coils or a diode for DC coils.

**Mounting:** Do not mount the totalizer near a solenoid or other inductive devices. Supply enough ventilation to keep the totalizer operating within the temperature specifications. Do not mount this unit in a heavy vibration area.

## BATTERY SAFETY

The lithium battery that powers your device contains inflammable materials such as lithium organic solvent, and other chemical ingredients. Explosion or fire may result if the battery is not handled correctly. To avoid an accident follow these guidelines:

- Do not heat batteries above 95°C
- Do not recharge lithium batteries
- Do not dispose of batteries in fire
- Insert battery with correct polarity

## WIRING DIAGRAMS

### SOLID STATE ADD/SUBTRACT INPUT (DPC10-CS) CURRENT SOURCING SENSOR

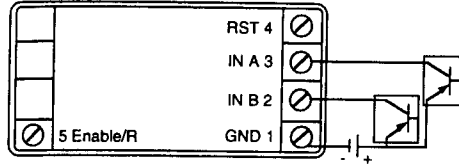

### SOLID STATE ADD/SUBTRACT INPUT (DPC10-CS) CURRENT SINKING SENSOR

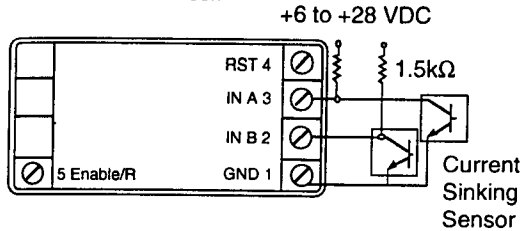

### CONTACT CLOSURE COUNT INPUT (DPC10-CC)

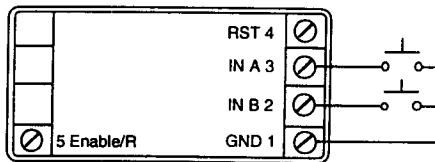

### PROGRAM MODE ENABLE (All Models)

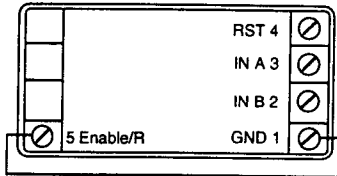

### REMOTE RESET (All Models)

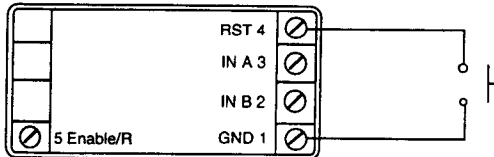

Terminal	Function	Operation
1	Ground	
2	Input B Count Input	Current Source Input (DPC10-CS) Current Sink Input (DPC10-CC)
3	Input A Count Input	Current Source Input (DPC10-CS) Current Sink Input (DPC10-CC)
4	Reset	Connect through Contact Closure to Ground
5	Program Enable	Connect to Ground to Enter Program Mode

## REPLACEMENT PARTS

DPC10-BAT	Battery
46066-210	Gasket
53300-241	Mounting Clip
28772-200	Mounting Screw

## OTHER OMEGA MINI COUNTER PRODUCTS

DPC10-TL	Totalizer
DPC10-QT	Quadrature Indicator
DPC10-RM	Ratemeter
DPC10-RT	Ratemeter/Totalizer



### WARRANTY

OMEGA warrants this unit to be free of defects in materials and workmanship and to give satisfactory service for a period of **13 months** from date of purchase. OMEGA Warranty adds an additional one (1) month grace period to the normal **one (1) year product warranty** to cover handling and shipping time. This ensures that our customers receive maximum coverage on each product. If the unit should malfunction, it must be returned to the factory for evaluation. Our Customer Service Department will issue an Authorized Return (AR) number immediately upon phone or written request. Upon examination by OMEGA, if the unit is found to be defective it will be repaired or replaced at no charge. However, this WARRANTY is VOID if the unit shows evidence of having been tampered with or shows evidence of being damaged as a result of excessive corrosion; or current, heat, moisture or vibration; improper specification; misapplication; misuse or other operating conditions outside of OMEGA's control. Components which wear or which are damaged by misuse are not warranted. These include contact points, fuses, and triacs.

**We are glad to offer suggestions on the use of our various products. Nevertheless OMEGA only warrants that the parts manufactured by it will be as specified and free of defects.**

**OMEGA MAKES NO OTHER WARRANTIES OR REPRESENTATIONS OF ANY KIND WHATSOEVER, EXPRESSED OR IMPLIED, EXCEPT THAT OF TITLE AND ALL IMPLIED WARRANTIES INCLUDING ANY WARRANTY OF MERCHANTABILITY AND FITNESS FOR A PARTICULAR PURPOSE ARE HEREBY DISCLAIMED.**

**LIMITATION OF LIABILITY: The remedies of buyer set forth herein are exclusive and the total liability of OMEGA with respect to this order, whether based on contract, warranty, negligence, indemnification, strict liability or otherwise, shall not exceed the purchase price of the component upon which liability is based. In no event shall OMEGA be liable for consequential, incidental or special damages.**

Every precaution for accuracy has been taken in the preparation of this manual, however, OMEGA ENGINEERING, INC. neither assumes responsibility for any omissions or errors that may appear nor assumes liability for any damages that result from the use of the products in accordance with the information contained in the manual.

### RETURN REQUESTS / INQUIRIES

Direct all warranty and repair requests/inquiries to the OMEGA ENGINEERING Customer Service Department. Call toll free in the USA and Canada: 1-800-622-2378, FAX: 203-359-7811; International: 203-359-1660, FAX: 203-359-7807.

**BEFORE RETURNING ANY PRODUCT(S) TO OMEGA, YOU MUST OBTAIN AN AUTHORIZED RETURN (AR) NUMBER FROM OUR CUSTOMER SERVICE DEPARTMENT (IN ORDER TO AVOID PROCESSING DELAYS).** The assigned AR number should then be marked on the outside of the return package and on any correspondence. Please have the following information available BEFORE contacting OMEGA:

1. P.O. number under which the product was PURCHASED,
2. Model and serial number of the product, and
3. Repair instructions and/or specific problems you are having with the product.

OMEGA's policy is to make running changes, not model changes, whenever an improvement is possible. That way our customers get the latest in technology and engineering.

OMEGA is a registered trademark of OMEGA ENGINEERING, INC.

© Copyright 1993 OMEGA ENGINEERING, INC. All rights reserved including illustrations. Nothing in this manual may be reproduced in any manner, either wholly or in part for any purpose whatsoever without written permission from OMEGA ENGINEERING, INC. Printed in U.S.A.

# OMEGA® ... Your Source for Process Measurement and Control

## TEMPERATURE

- Thermocouple, RTD & Thermistor Probes, Connectors, Panels & Assemblies
- Wire: Thermocouple, RTD & Thermistor
- Calibrators & Ice Point References
- Recorders, Controllers & Process Monitors
- Infrared Pyrometers

## PRESSURE/STRAIN FORCE

- Transducers & Strain Gauges
- Load Cells & Pressure Gauges
- Displacement Transducers
- Instrumentation & Accessories

## FLOW/LEVEL

- Rotameters, Gas Mass Flowmeters & Flow Computers
- Air Velocity Indicators
- Turbine/Paddlewheel Systems
- Totalizers & Batch Controllers

## pH/CONDUCTIVITY

- pH Electrodes, Testers & Accessories
- Benchtop/Laboratory Meters
- Controllers, Calibrators, Simulators & Pumps
- Industrial pH & Conductivity Equipment

## DATA ACQUISITION

- Data Acquisition and Engineering Software
- Communications-Based Acquisition Systems
- Plug-in Cards for Apple, IBM & Compatibles
- Datalogging Systems
- Recorders, Printers & Plotters

## HEATERS

- Heating Cable
- Cartridge & Strip Heaters
- Immersion & Band Heaters
- Flexible Heaters
- Laboratory Heaters



One Omega Drive, P.O. Box 4047  
Stamford, CT 06907  
Tel: (203) 359-1660  
Telex: 996404 Cable OMEGA  
Fax: (203) 359-7700