

CE



FR

EN

DE

IT

ES

PT

EL

NL

DA

NO

FI

SV

CS

PL

SL

SK

LT

BG

RU

HU

RO

TR

HR

LV

ET

UK

FR	<i>Lire ce manuel avant l'installation/utilisation du nettoyeur en faisant très attention aux INSTRUCTIONS POUR LA SÉCURITÉ</i>
EN	<i>Read this manual through carefully before installing/using the cleaner, paying special attention to the SAFETY INSTRUCTIONS</i>
DE	<i>Lesen Sie dieses Handbuch vor der Installation und dem Gebrauch des Hochdruckreinigers aufmerksam durch und achten Sie besonders auf die SICHERHEITSAUWEISUNGEN</i>
IT	<i>Leggere questo manuale prima dell'installazione/uso dell'idropulitrice, prestando particolare attenzione alle ISTRUZIONI PER LA SICUREZZA</i>
ES	<i>Leer este manual antes de la instalación/uso de la hidrolimpiadora, prestando particular atención a las INSTRUCCIONES SOBRE SEGURIDAD</i>
PT	<i>Leia este manual antes de instalar/usar a lavadora a alta pressão, prestando muita atenção nas INSTRUÇÕES PARA A SEGURANÇA</i>
EL	<i>Διαβάστε το παρόν εγχειρίδιο πριν από την εγκατάσταση/χρήση του μηχανήματος πλύσης, με ιδιαίτερη προσοχή στις ΟΔΗΓΙΕΣ ΓΙΑ ΤΗΝ ΑΣΦΑΛΕΙΑ</i>
NL	<i>Lees vóór de installatie/het gebruik van de hogedrukreiniger deze handleiding goed door en in het bijzonder de VEILIGHEIDSVOORSCHRIFTEN</i>
DA	<i>Læs denne vejledning inden installation og brug af højtryksrensere og vær særligt opmærksom på SIKKERHEDSREGLERNE</i>
NO	<i>Les denne håndboken før installasjon og bruk av høytrykksspyleren og vær spesielt oppmerksom på SIKKERHETSREGLENE</i>
FI	<i>Lue tämä käyttöopas ennen painepesurin asennusta/käyttöä. Kiinnitä erityistä huomiota TURVAOHJEISIIN</i>
SV	<i>Läs igenom bruksanvisningen före installation och användning av högtryckstvätten. Lägg speciellt märke till SÄKERHETSBESTÄMMELSERNA</i>
CS	<i>Před instalací nebo používáním tohoto čističe si pečlivě přečtěte tuto příručku. Zvýšenou pozornost věnujte části BEZPEČNOSTNÍ POKYNY</i>
PL	<i>Przed przystąpieniem do instalacji bądź użycia myjki należy dokładnie przeczytać niniejszy podręcznik, zwracając szczególną uwagę na treść części dotyczącej INSTRUKCJI BEZPIECZEŃSTWA</i>
SL	<i>Pozorno preberite ta navodila pred namestitvijo/uporabo čistilnika, pri čemer posebno pozornost namenite VARNOSTNIM NAVODILOM</i>
SK	<i>Pred inštaláciou/používaním čističa si pozorne prečítajte tento návod a buďte obzvlášť opatrní pri čítaní BEZPEČNOSTNÝCH POKYNOV</i>
LT	<i>Prieš sumontuodami ir naudodami įrenginį atidžiai perskaitykite šią naudojimo instrukciją, ypatingą dėmesį atkreipdami į SAUGOS INSTRUKCIJAS</i>
BG	<i>Прочетете това ръководство внимателно, преди да инсталирате/използвате машината за почистване, като обърнете особено внимание на ИНСТРУКЦИИТЕ ЗА БЕЗОПАСНОСТ</i>
RU	<i>Прочитайте данное руководство перед установкой моечной машины, обращая особенное внимание на ИНСТРУКЦИИ ПО БЕЗОПАСНОСТИ</i>
HU	<i>A tisztítóberendezés üzembehelyezése/használatá előtt olvassa át gondosan ezt a leírást, különös figyelmet szentelve a BIZTONSÁGI ELŐÍRÁSOK című résznek</i>
RO	<i>Citiți acest manual în întregime cu atenție înainte de a instala/utiliza aparatul de curățat, acordând o atenție mărită INSTRUCȚIUNILOR DE SIGURANȚĂ</i>
TR	<i>Hidro temizleyiciji kurmadan/kullanmadan önce, EMNİYET BİLGİLERİ'NE özellikle dikkat göstererek, işbu kılavuzu okuyunuz</i>
HR	<i>Prije montiranja/korištenja čistača pažljivo pročitajte ovaj priručnik i posebno pozornost posvetite SIGURNOSNIM MJERAMA</i>
LV	<i>Pirms tīrīšanas ierīces uzstādīšanas/izmantošanas izlasiet šo rokasgrāmatu, īpaši vērigi lasiet DROŠĪBAS NOTEIKUMUS</i>
ET	<i>Lugege see kasutusjuhend enne survepesuri töökorra seadmist/kasutamist hoolega läbi, pöörates erilist tähelepanu OHUTUSNÕUETELE</i>
UK	<i>Перед тим, як встановлювати/використовувати пристрій для миття, уважно прочитайте цей посібник, звертаючи особливу увагу на ІНСТРУКЦІЇ З БЕЗПЕКИ</i>



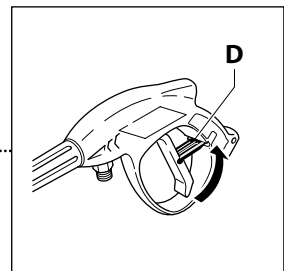
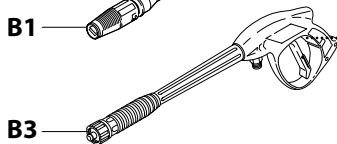
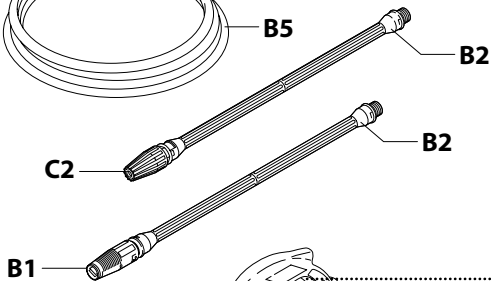
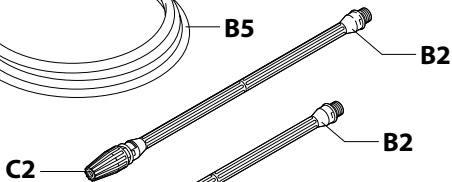
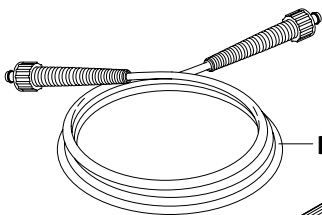
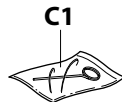
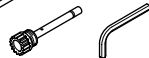
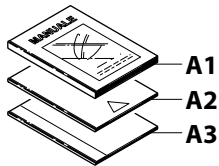
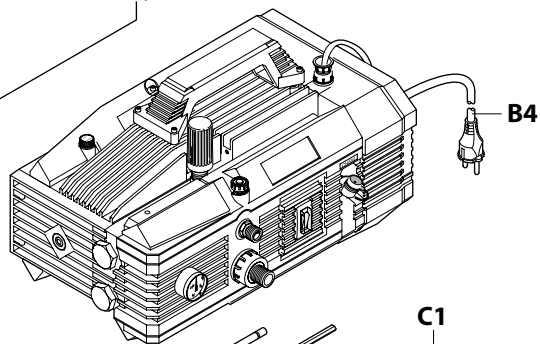
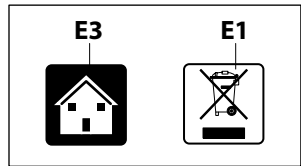
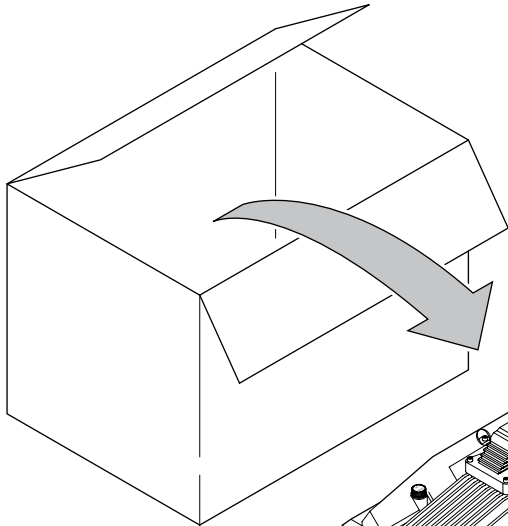

1

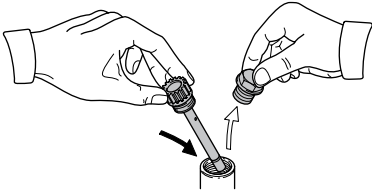

2

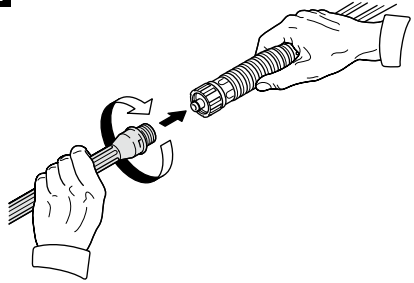

3

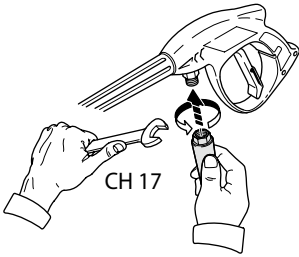

4

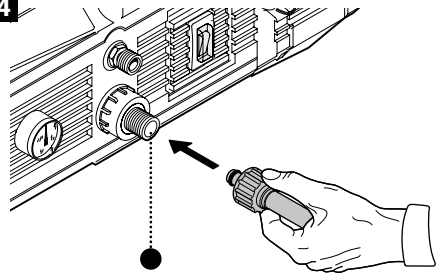

5

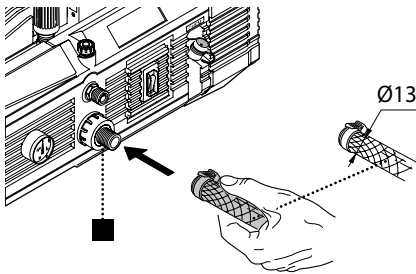

6

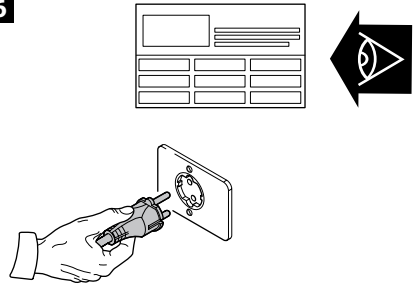

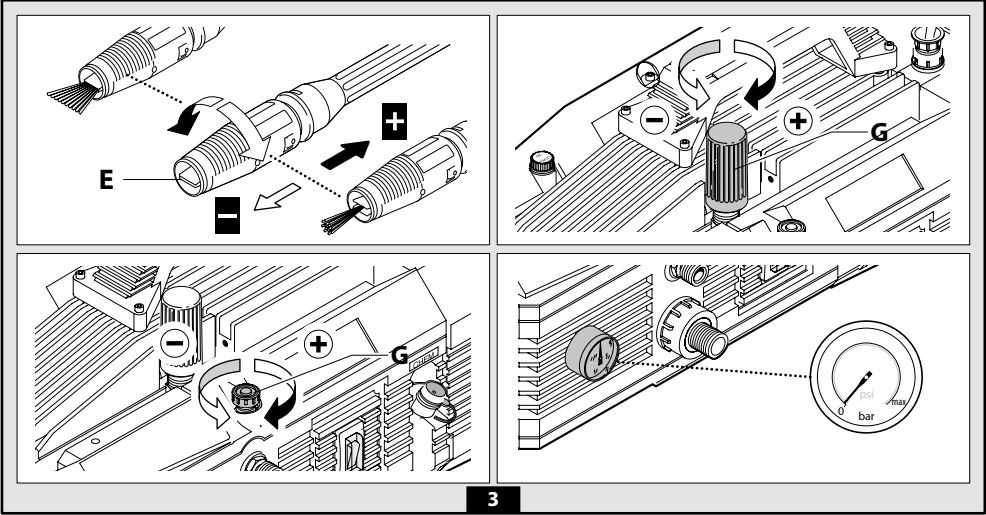



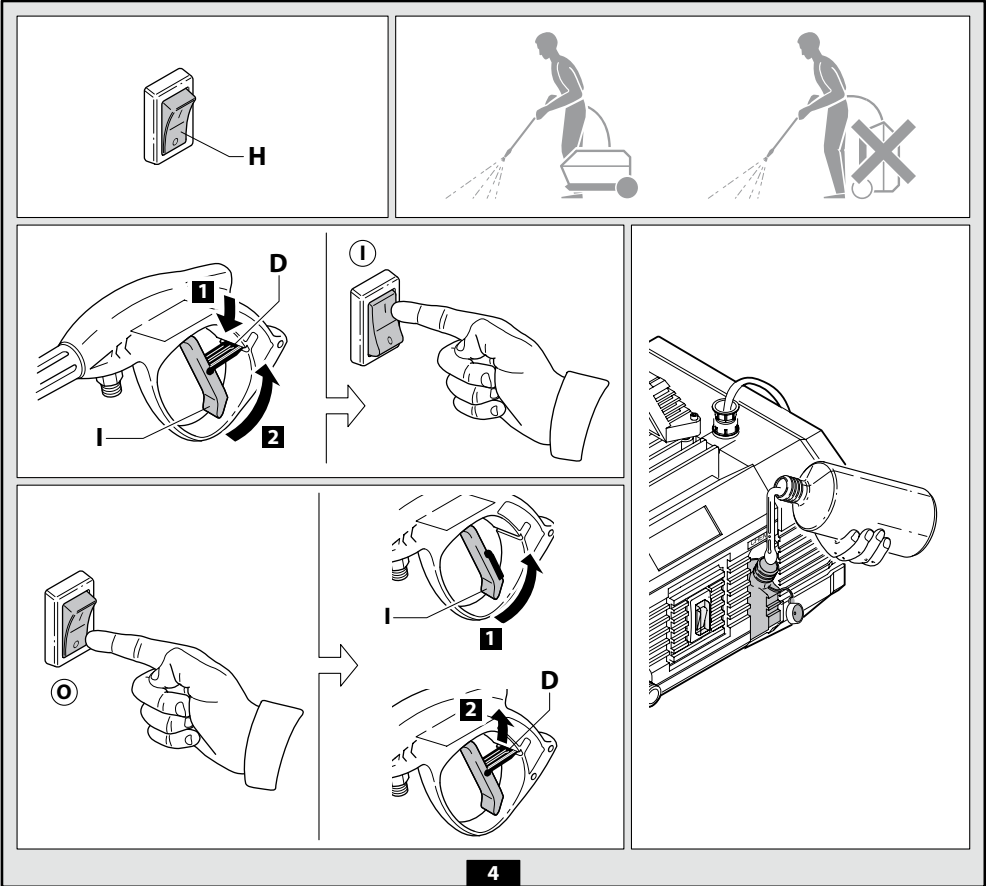

3

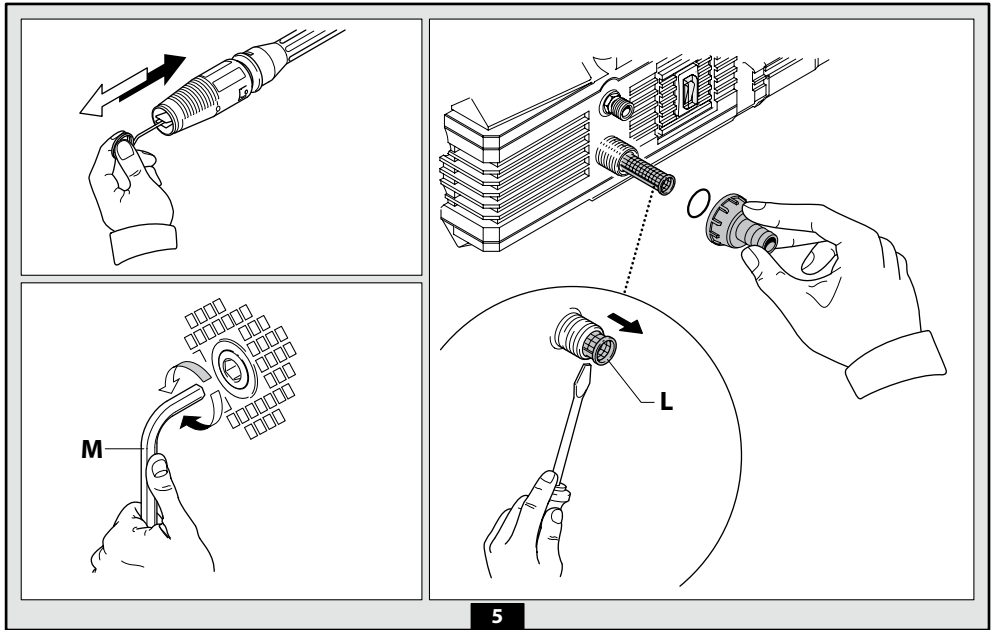

4



	 Volt	 $\Rightarrow 1 \div 25 \text{ m}$	 $\Rightarrow 25 \div 50 \text{ m}$
	230	$3 \times 1,5 \text{ mm}^2$	$3 \times 2,5 \text{ mm}^2$

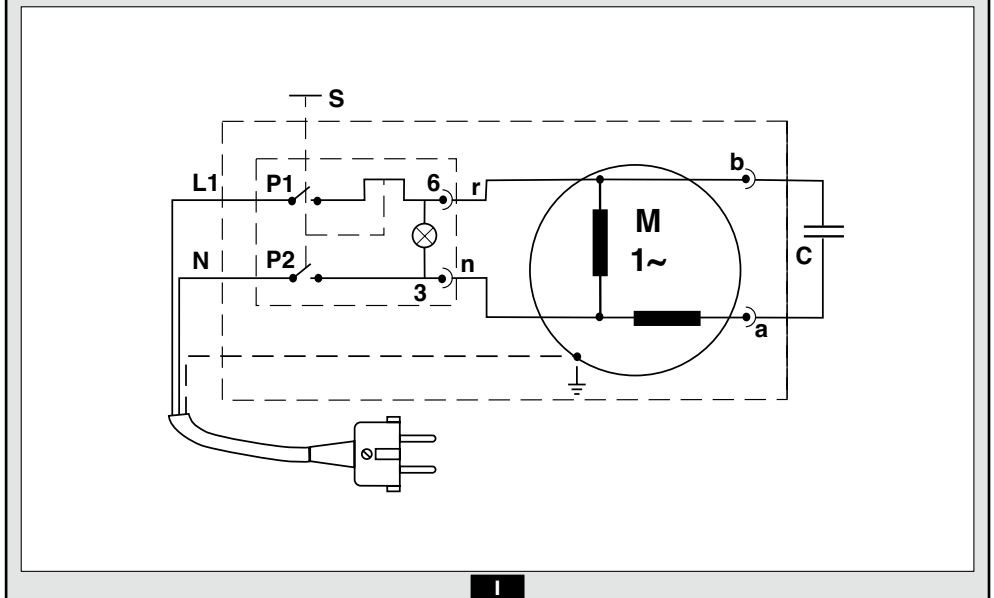

1 GENERAL INFORMATION (FIG.1)**1.1 Use of the manual**

This manual forms an integral part of the appliance and should be kept for future reference. Please read it carefully before installing/using the unit. If the appliance is sold, the Seller must pass on this manual to the new owner along with the appliance.

1.2 Delivery

The appliance is delivered partially assembled in a cardboard box. The supply package is illustrated in fig.1.

1.2.1 Documentation supplied with the appliance

- A1** Use and maintenance manual
- A2** Safety instructions
- A3** Declaration of conformity

1.3 Disposing of packaging

The packaging materials are not environmental pollutants but must still be recycled or disposed of in compliance with the relevant legislation in the country of use.

1.4 Safety signs

Comply with the instructions provided by the safety signs fitted to the appliance.

Check that they are present and legible; otherwise, fit replacements in the original positions.

E1 sign – Indicates that the appliance **must not be disposed of** as municipal waste; it may be handed in to the dealer on purchase of a new appliance. The appliance's electrical and electronic parts must not be reused for improper uses since they contain substances which constitute health hazards.

1.4.1 Symbols

E2 symbol – Indicates that the appliance is intended for professional use, i.e. for experienced people informed about the relative technical, regulatory and legislative aspects and capable of performing the operations necessary for the use and maintenance of the appliance.

E3 symbol – Indicates that the appliance is intended for non-professional (domestic) use.

2 TECHNICAL INFORMATION (FIG.1)**2.1 Envisaged use**

This appliance has been designed for individual use for the cleaning of vehicles, machines, boats, masonry, etc, to remove stubborn dirt using clean water and biodegradable chemical detergents.

Vehicle engines may be washed only if the dirty water is disposed of as per regulations in force.

- Intake water temperature: **see data plate on the appliance.**
- Intake water pressure: **below 10 bar.**
- Operating ambient temperature **over 0°C** in accordance with standard EN 60335-2-79/A1 only for domestic model (see symbol E3).

2.2 Operator

The symbol on the front cover identifies the appliance's intended operator (professional or non-professional).

2.3 Improper use

Use by unskilled persons or those who have not read and understood the instructions in the manual is forbidden.

The introduction of inflammable, explosive and toxic liquids into the appliance is prohibited.

Use of the appliance in a potentially inflammable or explosive atmosphere is forbidden.

The use of non-original spare parts and any other spare parts not specifically intended for the model in question is prohibited.

All modifications to the appliance are prohibited. Any modifications made to the appliance shall render the Declaration of Conformity null and void and relieve the manufacturer of all liability under civil and criminal law.

2.4 Main components

B1 Adjustable spray nozzle

B2 Lance

B3 Gun with safety catch

B4 Power supply cable with plug

B5 High pressure hose

B6 Detergent tank (on models with this feature)

2.4.1 Accessories (where applicable – see fig.1).

C1 Nozzle cleaning tool

C2 Rotating nozzle kit

C3 Handle

C4 Brush

C5 Hose reel

2.5 Safety devices**Caution - Danger!**

Do not tamper with or adjust the safety valve setting.

- Safety valve and pressure limiting valve.

The safety valve is also a pressure limiting valve. When the gun trigger is released, the valve opens and the water recirculates through the pump inlet.

- Safety catch (D); prevents accidental spraying of water.

3 INSTALLATION (FIG.2)**3.1 Assembly****Caution - Danger!**

All installation and assembly operations must be performed with the appliance disconnected from the mains power supply.

The assembly sequence is illustrated in fig.2.

3.2 Assembling the rotating nozzle

(For models with this feature)

The rotating nozzle kit delivers greater washing power.

3.3 Electrical connection**Caution - Danger!**

Check that the electrical supply voltage and frequency (V-Hz) correspond to those specified on the appliance data plate (fig.2). The appliance should only be connected to a mains power supply equipped with an adequate earth connection and a differential security breaker (30 mA) to cut off the electricity supply in the instance of a short circuit.

3.3.1 Use of extension cables

Use cables featuring "IPX5" protection level.

The cross-section of the extension cable should be proportionate to its length; the longer it is, the greater its cross-section should be. See table I.

3.4 Water supply connection**Caution - Danger!**

Only clean or filtered water should be used for intake. The delivery of the water intake tap should be equal to that of pump capacity.

Place the appliance as close to the water supply system as possible.

3.4.1 Connection points

● Water outlet (OUTLET)

■ Water inlet with filter (INLET)

3.4.2 Connection to the mains water supply

The appliance can be connected directly to the mains drinking water supply only if the supply hose is fitted with a backflow preventer valve as per current regulations in force. Make sure that the hose is at least Ø 13 mm and that it is reinforced.

4 ADJUSTMENT INFORMATION (FIG.3)

- 4.1 Adjusting the spray nozzle** (for models with this feature)
Water flow is adjusted by regulating the nozzle (E).
- 4.2 Adjusting the detergent** (on models with this feature)
Detergent flow is adjusted using the regulator (F).
- 4.3 Adjusting the detergent pressure**
Set the adjustable nozzle on "■" to deliver detergent at the correct pressure (on models with this feature).
- 4.4 Adjusting the pressure** (on models with this feature)
The regulator (G) is used to adjust the working pressure. The pressure is shown on the pressure gauge (where fitted).

5 INFORMATION ON USE OF THE APPLIANCE (FIG.4)

5.1 Controls

- Starter device (H).

Set the starter switch on (ON/1) to:

- start the motor (in models without TSS device);
 - set the motor ready to start (in models with TSS device).
- If there is a pilot light on the starter device, it should light up.

If the "low/high" settings are available, use them as follows:

Low : low pressure washing

High : high pressure washing

Set the starter device switch on (OFF/0) to shut down the appliance.

If there is a pilot light on the starter device, it should go out.

- Water jet control lever (I).



Caution - Danger!

During operation the appliance must be positioned as shown in fig. 4 on a sturdy, stable surface.

5.2 Start-up



Caution - Danger!

Before starting up the appliance check that the water supply hose is connected properly; use of the appliance without water will damage it; do not cover the ventilation grilles when the appliance is in use.

On three-phase models for professional use, at first use start the appliance for a very short time to check that the motor is running in the correct direction. If the motor fan is turning anti-clockwise, exchange two of the three phase wires (L1, L2, L3) in the electrical plug.

- Turn on the water supply tap fully.
- Release the safety catch (D).
- Depress the gun trigger for a few seconds and start up the appliance using the starter device (ON/1).

TSS models - In TSS models with automatic delivery flow cut-off system:

- when the gun trigger is **released** the dynamic pressure automatically cuts out the motor (see fig.4);
- when the gun trigger is **depressed** the automatic drop in pressure starts the motor and the pressure is restored after a very slight delay;
- if the TSS is to function correctly all gun **releasing** and **depressing** operations must be performed at intervals of **less** than 4-5 seconds.

To prevent damage to the appliance, when running do not stop the water jet for more than 10 minutes at a time.

5.3 Stopping the appliance

- Set the starter device switch on (OFF/0).
- Depress the gun trigger and discharge the residual pressure inside the hoses.
- Engage the gun safety catch (D).

5.4 Restarting

- Release the safety catch (D).
- Depress the gun trigger and discharge the residual air inside the hoses.
- Set the starter device on (ON/1).

5.5 Storage

- Switch the appliance off (OFF/0).
- Remove the plug from the socket.
- Turn off the water supply tap.
- Discharge the residual pressure from the gun until all the water has come out of the nozzle.
- Drain the detergent tank.
- Engage the gun safety catch (D).

5.6 Refilling and using detergent

When using detergent, the adjustable nozzle must be set on "■" (on models with this feature).

Fill the tank with highly degradable detergent.

5.7 Recommended cleaning procedure

Dissolve dirt by applying the detergent mixed with water to the surface while still dry.

When dealing with vertical surfaces work from the bottom upwards. Leave the detergent to act for 1-2 minutes but do not allow the surface to dry. Starting from the bottom, use the high pressure jet at a minimum distance of 30 cm. Do not allow the rinse water to run onto unwashed surfaces.

6 MAINTENANCE (FIG.5)

Any maintenance operations not covered by this chapter should be carried out by an Authorized Sales and Service Centre.



Caution - Danger!

Always disconnect the plug from the power socket before carrying out any work on the appliance.

6.1 Cleaning the nozzle

- Disconnect the lance from the nozzle.
- Remove any dirt deposits from the nozzle hole using the tool (C1).

6.2 Cleaning the filter

Clean the suction filter (L) and the detergent filter after every 50 hours of operation.

6.3 Unjamming the motor (on models with this feature)

In case of lengthy stoppages, limescale sediments may cause the motor to seize. To unjam the motor, turn the drive shaft with a tool (M).

6.4 End-of-season storage

Treat the appliance with non-corrosive, non-toxic antifreeze before storing it away for winter.

7 TROUBLESHOOTING

Problem	Possible causes	Remedy
Pump does not reach working pressure	Nozzle worn	Replace nozzle
	Water filter fouled	Clean filter (fig.5)
	Water supply pressure low	Turn on water supply tap fully
	Air being sucked into system	Check tightness of hose fittings
	Air in pump	Switch off the appliance and keep depressing and releasing the gun trigger until the water comes out in a steady flow. Switch the appliance back on again.
Pressure drops during use	Adjustable nozzle not positioned correctly	Turn the adjustable nozzle (E) (+) (fig.3)
	Water intake from external tank	Connect appliance to the mains water supply
	Intake water too hot	Reduce temperature
Motor "sounds" but fails to start	Nozzle clogged	Clean nozzle (fig.5)
	Insufficient power supply	Check that the voltage of the mains power supply line is the same as that on the plate (fig.2)
	Voltage loss due to use of extension cable	Check characteristics of extension cable
	Appliance not used for a long period of time	Contact your nearest Authorized Service Centre
Motor fails to start	Problems with TSS device	Contact your nearest Authorized Service Centre
	No electrical power	Check that the plug is firmly in the socket and that the mains voltage supply is present (*)
	Appliance not used for a long period of time	Using the tool (L) unjam the motor from the hole at the rear of the appliance (in models with this feature) (fig.5)
Water leakage	Seals worn	Have the seals replaced at your nearest Authorized Service Centre
Appliance noisy	Water too hot	Reduce temperature (see technical data)
Oil leakage	Seals worn	Contact your nearest Authorized Service Centre
TSS versions only: motor starts even with gun trigger is released	Nozzle clogged	Clean nozzle (fig.5)
	High pressure system or pump hydraulic circuit not watertight	Contact your nearest Authorized Service Centre
TSS versions only: no water delivery when gun trigger is depressed (with supply hose connected)	Nozzle clogged	Clean nozzle (fig.5)

If the motor starts and does not restart during operation, wait 2-3 minutes before repeating the start-up procedure (**overload cutout has been tripped**). If the problem recurs more than once, contact your nearest Authorized Service Centre.

CE DÉCLARATION DE CONFORMITÉ FR

Nous déclarons, en assumant la pleine responsabilité de cette déclaration, que le produit est conforme aux normes suivantes et aux documents correspondants

EN 60335-1; EN 60335-2-79; EN 55014-1; EN 55014-2; EN 61000-3-2; EN 61000-3-3; EN 61000-3-11; EN 60704-1

Selon les prescriptions des directives:
98/37/CE

2006/95/CE, 2002/95/CE, 2002/96/CE, 89/336/CE, 2000/14/CE

Date: 02/02/2007
MODENA (I)
Stefano Reverberi
Managing Director

CE DECLARATION OF CONFORMITY EN

We declare under our sole responsibility that this product is in conformity with the following standards or standardized documents

EN 60335-1; EN 60335-2-79; EN 55014-1; EN 55014-2; EN 61000-3-2; EN 61000-3-3; EN 61000-3-11; EN 60704-1

In accordance with the regulations:
98/37/EC

2006/95/EC, 2002/95/EC, 2002/96/EC, 89/336/EC, 2000/14/EC

Date: 02/02/2007
MODENA (I)
Stefano Reverberi
Managing Director

CE KONFORMITÄTSERKLÄRUNG DE

Wir erklären in alleiniger Verantwortung, dass das Produkt den folgenden Normen und normativen Dokumenten entspricht:

EN 60335-1; EN 60335-2-79; EN 55014-1; EN 55014-2; EN 61000-3-2; EN 61000-3-3; EN 61000-3-11; EN 60704-1

gemäß den Bestimmungen der Richtlinien:
98/37/EG

2006/95/EG, 2002/95/EG, 2002/96/EG, 89/336/EG, 2000/14/EG

Datum: 02.02.2007
MODENA (I)
Stefano Reverberi
Managing Director

CE DICHIARAZIONE DI CONFORMITÀ IT

Dichiariamo, assumendo la piena responsabilità di tale dichiarazione, che il prodotto è conforme alle seguenti normative e ai relativi documenti

EN 60335-1; EN 60335-2-79; EN 55014-1; EN 55014-2; EN 61000-3-2; EN 61000-3-3; EN 61000-3-11; EN 60704-1

In base alle prescrizioni delle direttive:
98/37/CE

2006/95/CE, 2002/95/CE, 2002/96/CE, 89/336/CE, 2000/14/CE

Data: 02/02/2007
MODENA (I)
Stefano Reverberi
Managing Director

CE DECLARACIÓN DE CONFORMIDAD ES

Declaramos, asumiéndonos la plena responsabilidad al respecto, que el producto cumple con lo establecido por las siguientes normativas y relativos documentos:

EN 60335-1; EN 60335-2-79; EN 55014-1; EN 55014-2; EN 61000-3-2; EN 61000-3-3; EN 61000-3-11; EN 60704-1

sobre la base de lo dispuesto por las directivas:
98/37/CE

2006/95/CE, 2002/95/CE, 2002/96/CE, 89/336/CE, 2000/14/CE

Fecha: 02/02/2007
MODENA (I)
Stefano Reverberi
Managing Director

CE DECLARAÇÃO DE CONFORMIDADE PT

Declaramos, assumindo a plena responsabilidade por tal declaração, que o produto está em conformidade com as seguintes normas e relativos documentos

EN 60335-1; EN 60335-2-79; EN 55014-1; EN 55014-2; EN 61000-3-2; EN 61000-3-3; EN 61000-3-11; EN 60704-1

com base nas prescrições das diretivas:
98/37/CE

2006/95/CE, 2002/95/CE, 2002/96/CE, 89/336/CE, 2000/14/CE

Data: 02/02/2007
MODENA (I)
Stefano Reverberi
Managing Director

CE ΔΗΛΩΣΗ ΣΥΜΜΟΡΦΩΣΗΣ EL

Δηλώνουμε, αναλαμβάνοντας πλήρη ευθύνη αυτής της δήλωσης, ότι το προϊόν συμμορφώνεται με τους παρακάτω κανονισμούς και τα αντίστοιχα έγγραφα

EN 60335-1; EN 60335-2-79; EN 55014-1; EN 55014-2; EN 61000-3-2; EN 61000-3-3; EN 61000-3-11; EN 60704-1

με βάση τις προδιαγραφές των Οδηγιών:
98/37/ΕΚ

2006/95/ΕΚ, 2002/95/ΕΚ, 2002/96/ΕΚ, 89/336/ΕΚ, 2000/14/ΕΚ

Ημερομηνία: 02/02/2007
Μόδενα (Ι)
Stefano Reverberi
Managing Director

CE EG-VERKLARING VAN OVEREENSTEMMING NL

Bij dezen verklaren wij onder volledige eigen verantwoordelijkheid dat het product overeenstemt met het volgende normenstelsel en de bijbehorende documenten

EN 60335-1; EN 60335-2-79; EN 55014-1; EN 55014-2; EN 61000-3-2; EN 61000-3-3; EN 61000-3-11; EN 60704-1

op grond van de voorschriften van de volgende richtlijnen:
98/37/EG

2006/95/EG, 2002/95/EG, 2002/96/EG, 89/336/EG, 2000/14/EG

Datum: 02/02/2007
MODENA (I)
Stefano Reverberi
Managing Director

CE KONFORMITÆTSERKLÆRING DA

Vi erklærer under almindeligt ansvar, at dette produkt er i overensstemmelse med følgende normer eller standarder:

EN 60335-1; EN 60335-2-79; EN 55014-1; EN 55014-2; EN 61000-3-2; EN 61000-3-3; EN 61000-3-11; EN 60704-1

i henhold til bestemmelserne i direktivene:
98/37/EF

2006/95/EF, 2002/95/EF, 2002/96/EF, 89/336/EF, 2000/14/EF

Dato: 02.02.2007
Modena (I)
Stefano Reverberi
Adm. direktør

CE OVERENSSTEMMELSESERKLÆRING NO

Vi erklærer på eget ansvar at dette produktet er i overensstemmelse med følgende normer eller standarder:

EN 60335-1; EN 60335-2-79; EN 55014-1; EN 55014-2; EN 61000-3-2; EN 61000-3-3; EN 61000-3-11; EN 60704-1

i henhold til bestemmelserne i direktivene:
98/37/EC

2006/95/EC, 2002/95/EC, 2002/96/EC, 89/336/EC, 2000/14/EC

Dato: 02.02.2007
Modena (I)
Stefano Reverberi
Daglig leder

CE STANDARDIENMUKAISUUSTODISTUS FI

Todistamme ottaen täyden vastuun, että tuote on seuraavien standardien ja vastaavien asiakirjojen mukainen

EN 60335-1; EN 60335-2-79; EN 55014-1; EN 55014-2; EN 61000-3-2; EN 61000-3-3; EN 61000-3-11; EN 60704-1

seuraavien direktiivien mukaan:
98/37/EY

2006/95/EY, 2002/95/EY, 2002/96/EY, 89/336/EY, 2000/14/EY

Pvm: 02.02.2007
Modena (I)
Stefano Reverberi
Toimitusjohtaja

CE FÖRSÄKRAN OM CE-ÖVERENSSTÄMMEELSE SV

Vi försäkrar på eget ansvar att denna produkt är i överensstämmelse med följande lagar eller standarder:

EN 60335-1; EN 60335-2-79; EN 55014-1; EN 55014-2; EN 61000-3-2; EN 61000-3-3; EN 61000-3-11; EN 60704-1

enligt kraven i direktiven:
98/37/EG

2006/95/EG, 2002/95/EG, 2002/96/EG, 89/336/EG, 2000/14/EG

Datum: 02/02-02
Modena (I)
Stefano Reverberi
Verkställande direktör

CE PROHLÁŠENÍ O SHODĚ CS

Prohlášíme na vlastní odpovědnost, že tento výrobek je ve shodě s následujícími normami nebo standardizovanými dokumenty

EN 60335-1; EN 60335-2-79; EN 55014-1; EN 55014-2; EN 61000-3-2; EN 61000-3-3; EN 61000-3-11; EN 60704-1

v souladu s předpisy:
98/37/ES

2006/95/ES, 2002/95/ES, 2002/96/ES, 89/336/ES, 2000/14/ES

Datum: 02.02.2007
MODENA (I)
Stefano Reverberi
Generální ředitel

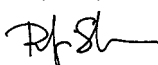
CE DEKLARACJA ZGODNOŚCI PL

Deklarujemy z pełną odpowiedzialnością, że wyrob ten jest zgodny z następującymi normami i dokumentacją normalizacyjną

EN 60335-1; EN 60335-2-79; EN 55014-1; EN 55014-2; EN 61000-3-2; EN 61000-3-3; EN 61000-3-11; EN 60704-1

zgodnie z przepisami:
98/37/WE

2006/95/WE, 2002/95/WE, 2002/96/WE, 89/336/WE, 2000/14/WE

Data: 02/02/2007
MODENA (I)
Stefano Reverberi
Dyrektor zarządzający

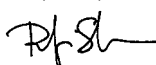
CE IZJAVA O SKLADNOSTI SL

Na lastno izključno odgovornost izjavljamo, da je izdelek v skladu z naslednjimi standardi ali standardiziranimi dokumenti

EN 60335-1; EN 60335-2-79; EN 55014-1; EN 55014-2; EN 61000-3-2; EN 61000-3-3; EN 61000-3-11; EN 60704-1

v skladu s predpisi:
98/37/ES

2006/95/ES, 2002/95/ES, 2002/96/ES, 89/336/ES, 2000/14/ES

Datum: 02/02/2007
MODENA (I)
Stefano Reverberi
Direktor

