

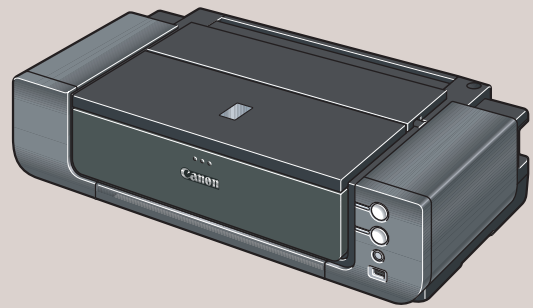

1 Unpack the Printer

1 Carefully remove all items from the box.



PIXMA Pro9500 series Photo Printer

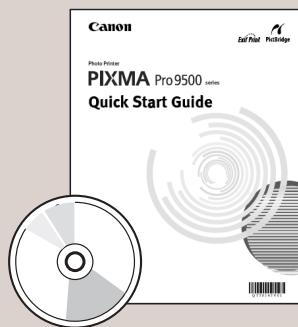

Documentation and Software Kit

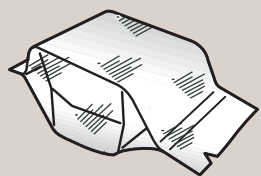

PIXMA Pro9500 series Print Head

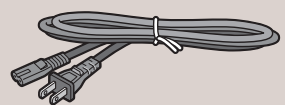

Power Cord

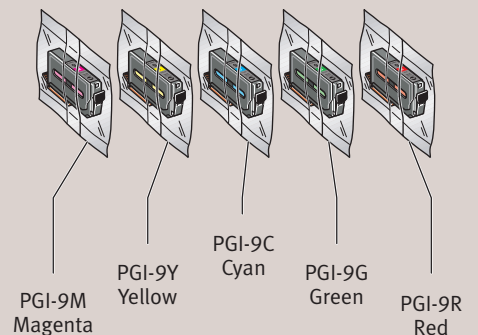
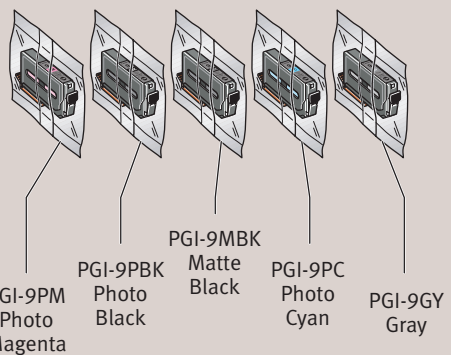

2 Remove the tapes from the printer.

NOTE:

- It takes about an hour to complete the setup of the printer.
- A USB cable is necessary to connect the printer with your computer.

2 Prepare the Printer

1 Plug the power cord into the back of the printer and connect the other end to a power outlet. Press the POWER button. The printer will initialize. Wait until the POWER lamp displays a steady blue light.

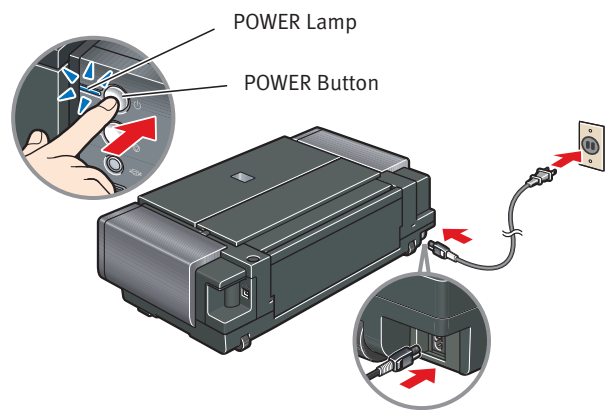

2 Open the Front Tray. Raise the Top Cover.

NOTE: Gently press the mark on the Front Tray. The Front Tray automatically opens.

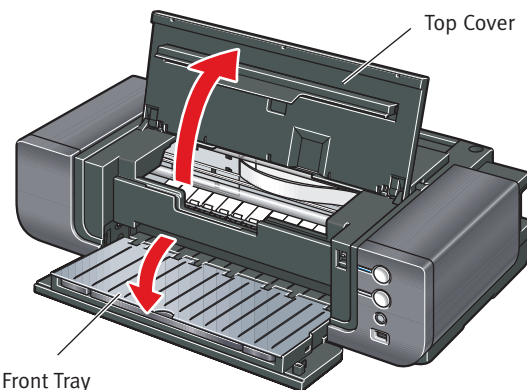

3 The Print Head Holder automatically moves to the center. Remove the protective tape from the Print Head Holder. The tape position is subject to change.

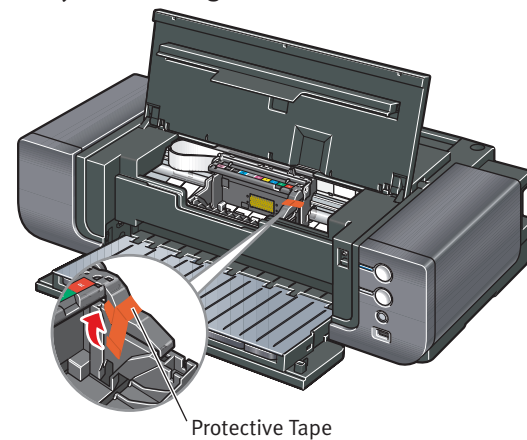

4 Write down the serial number located inside the printer. You will need this to register your products.

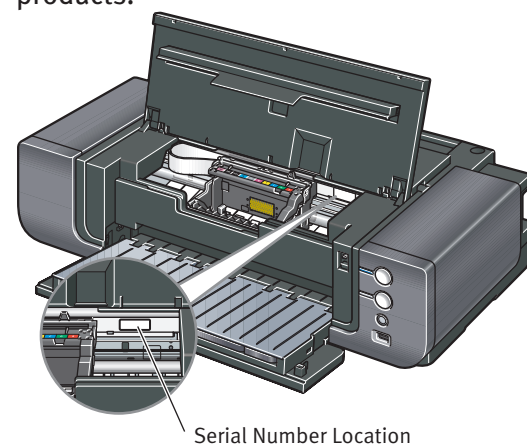

IMPORTANT: If the Top Cover is left open for more than 10 minutes, the Print Head Holder moves to the right. Close and reopen the Top Cover to return the holder to the center.

3 Install the Print Head

1 Firmly raise the print head lock lever.

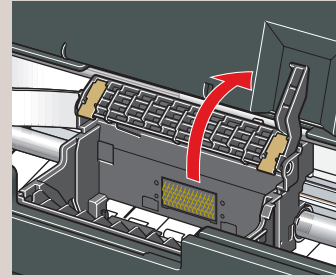

2 Remove the Print Head from its package.

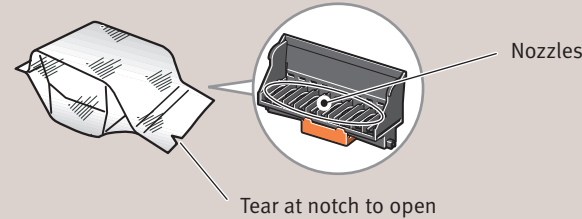

CAUTION: There might be some transparent or light color ink on the inside of the bag the Print Head comes in - this has no effect on print quality. Be careful not to get ink on yourself when handling these items.

NOTE: Do not touch the nozzles.

3 Remove and discard the orange protective cap from the Print Head.

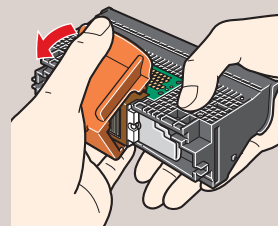

CAUTION: There might be some transparent or light color ink on the inside of the protective cap - this has no effect on print quality. Be careful not to get ink on yourself when handling these items.

NOTE:

- Do not touch the print head nozzles and the electrical contacts.
- Do not attempt to reattach the protective cap once it has been removed.

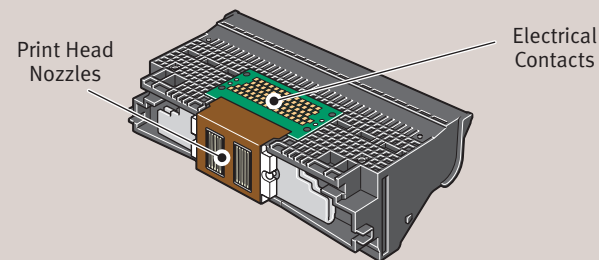

4 Slide the Print Head into the holder. The Print Head will rest at a slight angle.

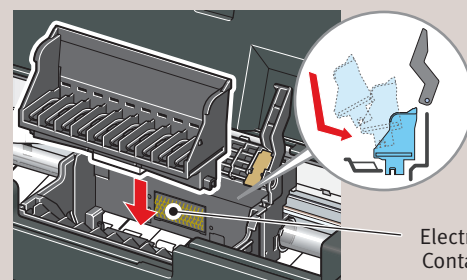

NOTE: Do not touch the electrical contacts.

5 Lower the print head lock lever carefully.

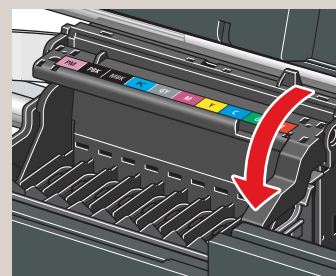

4 Install the Ink Tanks

1 Remove the Red Ink Tank (PGI-9R) from its package.

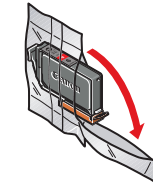

2 Remove and discard the orange protective cap located on the bottom of the ink tank.

IMPORTANT: Do not touch the electrical contacts.

NOTE:

- To avoid spilling ink, never press on the sides of an ink tank.
- Do not touch the open ink port once the protective cap is removed, as this may prevent the ink from being ejected properly.

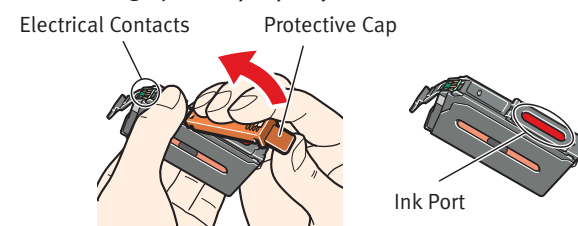

3 Insert the ink tank into the rightmost slot. Press the mark on the ink tank until it clicks into place and then its lamp lights red.

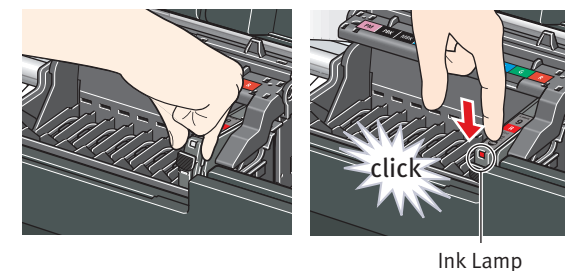

4 Insert the remaining nine ink tanks into their assigned slots. Ensure that ink lamps light red.

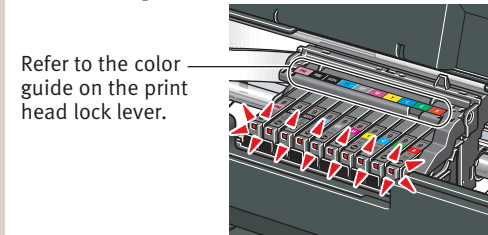

Refer to the color guide on the print head lock lever.

5 Close the Top Cover. Lift open the Paper Support and the Paper Support Extension, then pull out the Front Tray Extension.

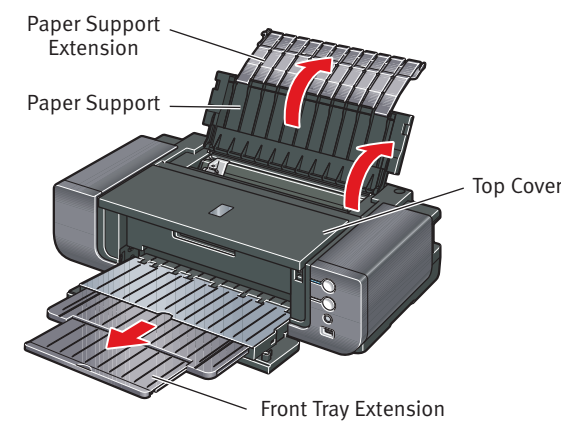

NOTE: If the ALARM lamp on the printer flashes orange after you have closed the Top Cover, an ink tank may not be installed properly. Open the Top Cover and make sure that the ink tanks are installed in the correct order directed on the label.

5 Connect the Printer and Load Paper

IMPORTANT: When the POWER lamp flashes blue and the printer vibrates, the printer is shaking the ink tanks. Once you have installed the ink tanks and have closed the Top Cover, wait for about 2 minutes 30 seconds until the POWER lamp stops flashing and stays lit, and the printer has stopped making operating noises before proceeding. Do not open the Top Cover while the printer is operating (the POWER lamp is flashing blue).

1 **TURN THE PRINTER OFF.**

IMPORTANT: Be sure the printer is off before continuing, or the computer will attempt to install the printer driver before the printer is ready.

2 Connect one end of the USB cable to the computer, the other to the appropriate USB port on the printer.

NOTE: The Pro9500 series Photo Printer is equipped with USB 2.0 Hi-Speed port. If your PC does not support USB 2.0 Hi-Speed, or if any non-certified USB 2.0 cable or driver is used for the connection, the printer will operate at a lower speed provided under USB 1.1.

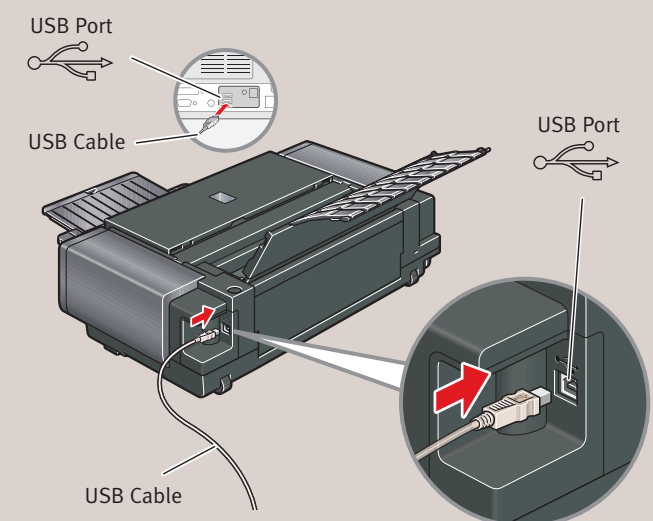

3 Pinch the Paper Guide and slide it to the left. Load two sheets of plain paper into the Auto Sheet Feeder, align the paper with the right edge of the Auto Sheet Feeder, then slide the Paper Guide toward the left edge of the paper.

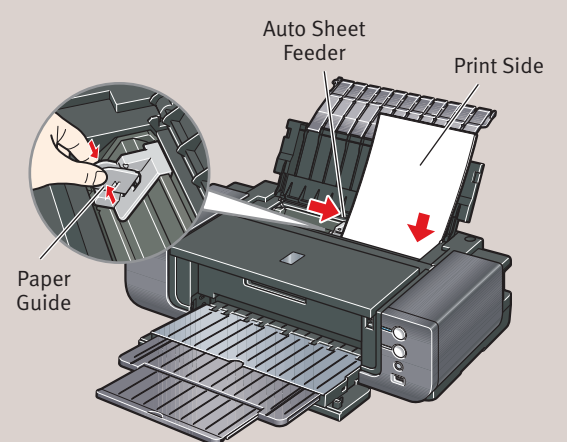

IMPORTANT: Print Head Alignment (Step 6) requires that letter size paper is loaded in the Auto Sheet Feeder (top paper feeder).

Continue with Step 6 on the back page.



6 Windows® Printer Driver Installation and Print Head Alignment

6 Macintosh® Printer Driver Installation and Print Head Alignment

Column For the Best Print Result

Column Introduction to the Front Paper Feeding

NOTE: The screens below refer to Windows XP Service Pack 2 installation. Screens may differ depending on the operating system you are using.

1 Be sure to **TURN THE PRINTER OFF** before continuing.

2 Turn on the computer and start Windows.

NOTE:

• For Windows XP or Windows 2000, log on to Windows as a member of the Administrators group before continuing.

• Before installing the driver, disable all anti-virus programs and automatically loading programs.

IMPORTANT: If you see the Found New Hardware Wizard, remove the USB cable. Click **Cancel** to quit the screen. Next, turn off the printer. Then proceed from step 3 to install the printer driver.

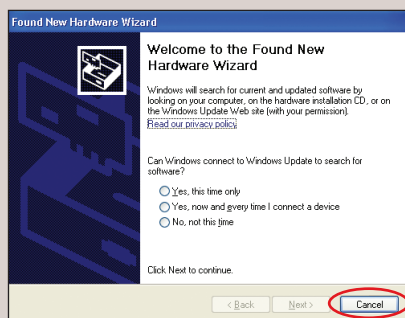

3 Insert the *Setup CD-ROM*. The setup program should run automatically.

NOTE: If the installer in the CD-ROM does not run automatically, click **Start** and select **My Computer**, then double-click the CD-ROM icon.

4 When the main menu appears, click **Easy Install**.

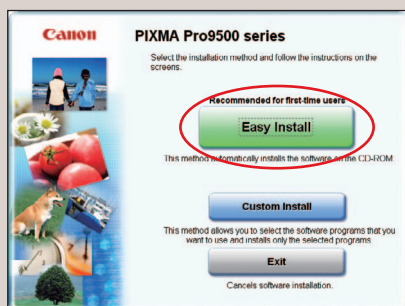

NOTE:

• Select **Easy Install** in order to install the application software, on-screen manuals and printer driver. Select **Custom Install** in order to choose the options you would like to install.

• Adobe® Photoshop® CS, Adobe Photoshop CS2, or Digital Photo Professional must be installed to use Easy-PhotoPrint Pro.

5 When the list of applications to install appears, verify the contents, click **Install**, then follow the instructions on the screen. Move the cursor over items to display explanations of each application below.

6 Read the **License Agreement** and click **Yes**. Follow the on-screen instructions to install the software.

If a message asking for your confirmation to restart your computer appears, click **OK**. The system is restarted automatically.

7 When the **Printer Connection** screen appears, ensure that the printer is connected to the computer with the USB cable, then **TURN THE PRINTER ON**. The software will begin identifying the printer port being used.



IMPORTANT: If your computer cannot detect a printer port, click **Help** and refer to the online instructions.

If a message asking for your confirmation to restart your computer appears, click **OK**. The system is restarted automatically.

8 When the **Print Head Alignment** screen appears, ensure that two sheets of letter size paper are loaded in the Auto Sheet Feeder (top paper feeder). Click **Execute**, read the message and click **Print Head Alignment**.

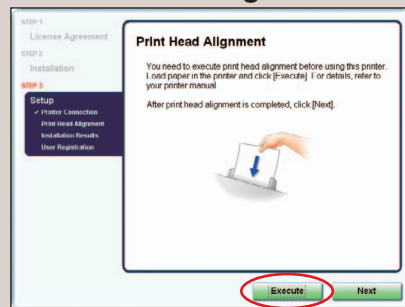

NOTE:

• Print head alignment will take about nine minutes to complete. Do not start another operation here.

• Do not open the Top Cover while printing.

9 Print head alignment is automatically adjusted by printing the patterns below.

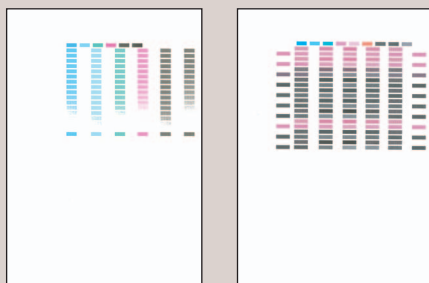

NOTE:

• Some parts of the first pattern that is printed will be faint.

• If the pattern is not printed successfully, refer to “Eleven flashes” in “Handling Error Messages” in the *Quick Start Guide*. When you align the print head again, the pattern that is printed is different from the pattern shown above.

10 After print head alignment is completed, click **Next**.

11 When the **Installation Results** screen appears, click **Next**.

12 When the **User Registration** screen appears, click **Register**.

NOTE:

• Follow on-screen instructions to register your product. You will need your product serial number, which is located on the inside of the printer. See Step 2-4 on the front page. If you intend to register later, double-click on the desktop after Step 10.

• If your computer is not connected to the Internet, click **Next**.

13 Go back to the **User Registration** screen, then click **Next**.

We would appreciate it if you would take part in the **PIXMA Extended Survey Program** regarding the use of Canon printers. For details, refer to the on-screen instructions.

14 When the **Installation completed successfully** screen appears, click **Exit**.

If **Restart** is displayed, ensure the **Restart the system now (recommended)** check box is selected, then click **Restart**.

Macintosh

IMPORTANT: Since Mac® OS 9, Mac OS X Classic environments, or Mac OS X v.10.2.7 or earlier are not supported, do not connect the printer to these.

NOTE:

• Use Mac OS X v.10.2.8 to 10.4.x.
• The screens below refer to Mac OS X v.10.4.x installation. Screens may differ depending on the operating system you are using.
• Before installing the driver, disable all anti-virus programs and automatically loading programs.

1 Turn on your Mac and your printer and insert the *Setup CD-ROM*. If the CD-ROM folder does not open automatically, double-click the on the desktop.

NOTE: Log on as an Administrator before continuing.

2 Double-click the **Setup** icon.

NOTE: When the **Authenticate** screen appears, enter your administrator name and password, then click **OK**. If you do not know your administrator name or password, click on the lower-left corner of the screen, then follow the on-screen instructions.

3 When the main menu appears, click **Easy Install** and then **Install**, then follow the on-screen instructions.

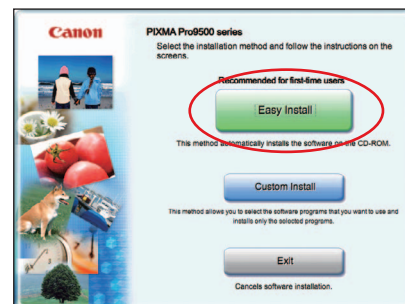

NOTE:

• Select **Easy Install** in order to install the application software, on-screen manuals and printer driver. Select **Custom Install** in order to choose the options you would like to install.
• Adobe Photoshop CS, Adobe Photoshop CS2, or Digital Photo Professional must be installed to use Easy-PhotoPrint Pro.

4 Read the **License Agreement** and click **Yes**. Follow the on-screen instructions to install the software.

5 When the **Print Head Alignment Recommended** screen appears, click **Next**.

6 When the **User Registration** screen appears, click **Register**.

NOTE:

• Follow on-screen instructions to register your product. You will need your product serial number, which is located on the inside of the printer. See Step 2-4 on the front page. If you intend to register later, double-click on the desktop after Step 11.

• If your computer is not connected to the Internet, click **Next**.

7 Go back to the **User Registration** screen, then click **Next**.

8 When the **Installation completed successfully** screen appears, click **Restart**.

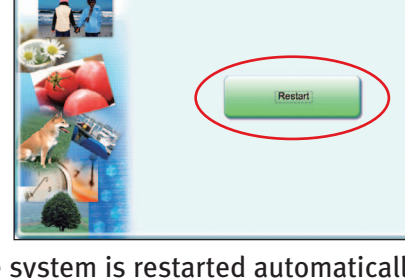

The system is restarted automatically.

9 Start the print head alignment procedure.

a. After restarting the computer, select **Applications** from the **Go** menu. Double-click the **Utilities** folder, then the **Printer Setup Utility (Print Center)** when using Mac OS X v.10.2.8 icon.

b. When the **Printer List** screen appears, select **Pro9500 series** from the **Name** list, then click **Utility (Configure)** when using Mac OS X v.10.2.8 icon.

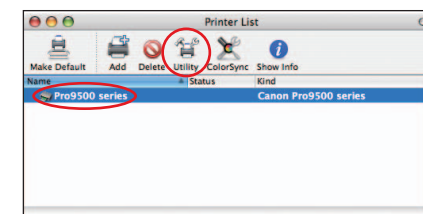

If the printer is not displayed on the **Printer List**, click **Add** to add the printer.

For details, follow the instructions in **Mac Help**.

c. Select **Pro9500 series** from the **Product** list and click **Maintenance**.

d. Ensure that two sheets of letter size paper are loaded in the Auto Sheet Feeder (top paper feeder).

e. Click the down-arrow to select **Test Print**. Click the **Print Head Alignment** icon, read the message and click **Print Head Alignment**.

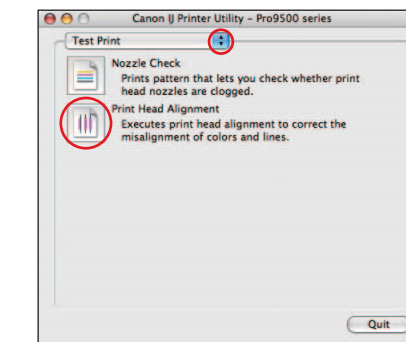

NOTE:

• Print head alignment will take about nine minutes to complete. Do not start another operation here.
• Do not open the Top Cover while printing.

10 Print head alignment is automatically adjusted by printing the patterns below.

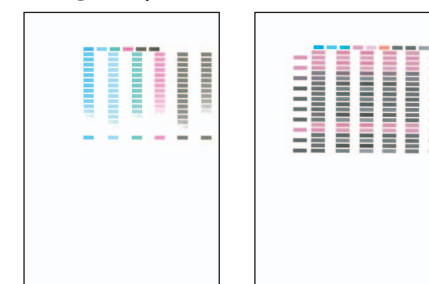

NOTE:

• Some parts of the first pattern that is printed will be faint.
• If the pattern is not printed successfully, refer to “Eleven flashes” in “Handling Error Messages” in the *Quick Start Guide*. When you align the print head again, the pattern that is printed is different from the pattern shown above.

11 Click **Quit** to exit the Canon IJ Printer Utility.

To maintain optimal print quality, press the **RESUME/CANCEL** button on the printer about once a week to shake the ink tanks.

NOTE: For details, refer to “Shaking the Ink Tanks Periodically” in the *Quick Start Guide*.

You can load paper in both the Auto Sheet Feeder and the Front Tray.

Loading paper in the Front Tray to print on large size paper or to print on thick paper such as art paper.

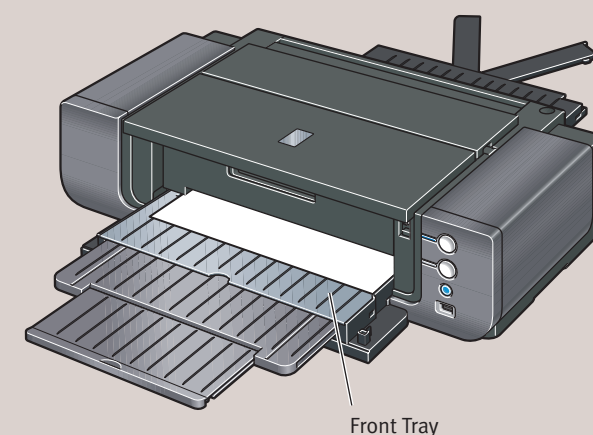

Front Tray

IMPORTANT:

• When loading paper in the Front Tray, the paper sticks out from the back of the printer. Keep a space of 40 cm / 15.7 inches for this purpose behind the printer.

• There are wheels on the back corners of the printer. Lift up the front of the printer to move it back and forth.

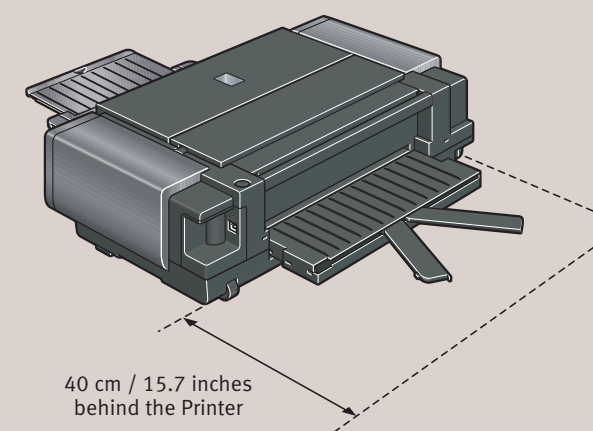

40 cm / 15.7 inches behind the Printer

NOTE: For details, refer to “Loading Paper in the Front Tray” in “Loading Paper” in the *Quick Start Guide*.