

## Precautions

### On safety

- Operate the printer on 120 V AC, 60 Hz (for the US model) or 220 to 240 V AC, 50/60 Hz (for the models for other areas) only.
- Be careful not to set or drop any heavy objects on the power cord, or to damage the power cord in any way. Never operate this printer with a damaged power cord.
- Should any solid object or liquid fall into the cabinet, unplug the printer and have it checked by qualified personnel before operating it any further.
- Never disassemble the printer.
- To disconnect the power cord, pull it out by the plug. Never pull the power cord itself.
- When the printer is not going to be used for an extended period of time, disconnect the power cord from the wall outlet.
- Do not handle the printer roughly.
- To reduce the risk of electrical shock, always unplug the printer from the electrical outlet before cleaning and servicing the printer.

### On installation

- Avoid placing the printer in a location subject to:
  - vibration
  - high humidity
  - excessive dust
  - direct sunlight
  - extremely high or low temperatures
- Do not use electrical equipment near the printer. The printer will not work properly in electromagnetic fields.
- The printer is designed to operate horizontally. Never attempt to operate the printer in a tilted position.
- Do not place heavy objects on the printer.
- Leave enough room around the printer so that the ventilation holes are not blocked. Blocking these holes may cause internal heat build-up.

### On moisture condensation

If the printer is brought directly from a cold location to warm location or placed in an extremely warm or humid room, moisture may condense inside the unit. In such cases the printer will probably not work properly and may even develop a fault if you persist in using it. If moisture condensation occurs, turn off the power and do not use the printer for at least one hour.

### On transport

When you transport the printer, remove the print cartridge, paper tray, the "Memory Stick" or PC card from the printer and put the printer and its peripherals in the original box with the protective packaging. If you no longer have the original box and packing parts, use similar packing material so that the printer will not be damaged while transporting.

### On cleaning

Clean the cabinet, panel and controls with a soft dry cloth, or a soft cloth lightly moistened with a mild detergent solution. Do not use any type of solvent, such as alcohol or benzene, which may damage the finish.

### On restrictions on duplication

If duplicating documents with the printer, pay special attention to the following:

- Duplication of banknotes, coins, or securities is against the law.
- Duplication of blank certificates, licenses, passports, private securities, or unused postal stamps is also against the law.
- TV program, films, video tapes, others' portraits or other materials may be copyrighted. Unauthorized video printing of such materials may infringe the provisions of the copyright law.

## About "Memory Stick" and PC card

The printer can read and write "Memory Stick" and PC card (PCMCIA ATA compatible type II flash memory cards with a power specification of 5V or 3.3/5V). By using a commercially available PC card adaptor, you can also use Smart Media and other types of compact flash cards.

### On "Memory Stick"

There are two types of "Memory Stick": general "Memory Stick" and "MagicGate Memory Stick." The "MagicGate Memory Stick" is equipped with the MagicGate copyright protection technology that uses encryption technology. You can use both types of "Memory Stick" with your printer. However, because the printer does not support the MagicGate standards, data recorded with the printer is not subject to MagicGate copyright protection.

### To protect "Memory Stick" images

To prevent accidental erasure of important image data, slide the write protect switch on the "Memory Stick" to the write protect position when you just view the images. Only when you write, delete data, or format a "Memory Stick," slide it to the write enable position.

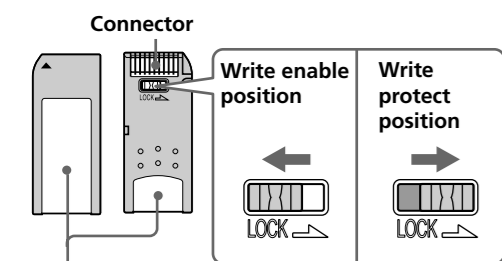

Place the label here

### Notes

- You cannot use the PC cards with the power specification of 3V only.
- Do not insert other types of PC card into the printer's insertion slot. The printer may be damaged.
- Do not drop, bend, or submit the "Memory Stick" or PC card to external shock.
- Do not disassemble or modify the "Memory Stick" or PC card.
- Avoid getting liquids on the "Memory Stick" or PC card.
- Avoid using or storing the "Memory Stick" or PC card in a location subject to:
  - extremely high temperature such as the hot inside of a car or the outdoors exposed to a burning sun, or a place near a heater.
  - direct sunlight
  - high humidity
  - corrosive substances
  - excessive dust
  - electrostatic or electronic noises
  - magnetic fields
- Avoid touching the connector of the "Memory Stick" or contacting it with a metal object.
- When attaching a label to the "Memory Stick" as specified in the illustration, use the label supplied for the "Memory Stick" only. Do not use any other labels.
- When storing and carrying the "Memory Stick" or PC card, keep it in its original case to ensure protection of important data.
- Avoid removing the "Memory Stick" or PC card from the insertion slot or turning off the power of the printer while the printer is accessing the "Memory Stick" or PC card. Otherwise, data may be rendered unreadable.
- When using a compact flash card or Smart Media, use a commercially available PC card adaptor that is compatible with the card. Attach the card into the adaptor and then insert it into the printer. For how to install the card and adaptor, refer to the operating instructions of the PC card adaptor.
- Avoid inserting or removing the compact flash card or Smart Media into or out of the PC card adaptor while the PC card adaptor is inserted in the printer. The data may be rendered unreadable or erased.

## Troubleshooting

If you run into any problems using the printer, use the following to solve the problem. If the problem persists, consult your Sony dealer.

### Cannot operate the printer after the power switch is turned on.

- Connect the AC power cord to an AC outlet securely.

### The television displays no images.

- Set the input selector of the television to "VIDEO."
- Connect the printer to the television properly and turn them on.
- Insert a "Memory Stick" or PC card securely. Check that images are recorded.
- Press INPUT SELECT to turn on the proper indicator.

### Cannot remove the print cartridge.

- Turn the printer off then on. After the motor sound stops, try to remove the cartridge.

### Cannot print.

- Insert the correct set of print cartridge and print paper.
- Check that the paper tray has paper.
- The thermal head may be overheated. Leave the printer until the head cools down and the printer resumes printing.
- Remove the jammed paper, if any.

### An image in thumbnail list is not properly displayed or printed.

- If the image is displayed but is not printed, the file for printing is damaged.
- If an image is not compatible with DCF (Design rule for Camera File system), it may not be printed with the printer even if it is displayed on the PC monitor.
- Some types of PC card adaptor that is not compatible with PCMCIA ATA cannot be used with the printer.

### The beeps sound.

- Check that you operate with the correct procedures.

### The or indicator is lit or an error message is displayed.

- Follow the instructions on the screen.

## If paper jams

If the print paper jams, the  paper error indicator lights and an error message is displayed. Printing stops. Turn off and on the printer and remove the jammed paper from the paper outlet or take out the paper tray to remove the jammed paper.

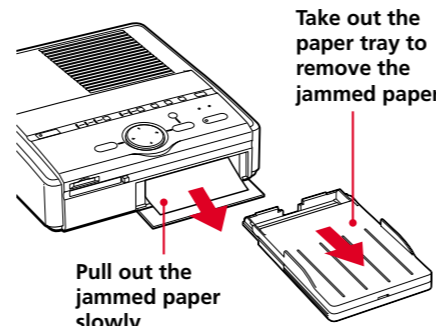

### Note

If you cannot remove the jammed paper, contact your Sony dealer.

## Specifications

### Printing system

Sublimation dye transfer printing (Yellow / Magenta / Cyan 3 pass)

### Resolution

403 (H) x 403 (V) dpi

### Image processing

256 levels (8 bits for each Yellow /Magenta /Cyan), approx. 16,770,000 colors

### Printing size

152.4 (H) x 101.6 (V) mm (maximum, Post Card Size, borderless) (6 x 4 inches)

### Printing time

Approx. 90 seconds per sheet (Post Card Size Paper)

Approx. 60 seconds per sheet (Small Size Paper)

(excluding the time for data processing and data transferring from the personal computer or "Memory Stick" or PC card)

### Input/output connectors

- USB connector (1)
- VIDEO OUTPUT connector (phono jack x 1)
  - 1 Vp-p, 75 ohms (unbalanced), sync negative

### Slot

- "Memory Stick" insertion slot (1)
- PC card insertion slot (PCMCIA II) (1)

### Compatible image file formats

JPEG: 4:4:4, 4:2:2, 4:2:0 (baseline JPEG)  
BMP: 24 bits full color, Windows format  
(Note that some versions of the file formats may not be compatible.)

Maximum number of files to be handled  
999 files

### Print cartridge/Print Paper

See "Using the printing pack" of the Operating Instructions – Basic Operations.

### Power requirements

120 V AC, 60 Hz, 1.16 A  
(for the US model)

220 - 240 V AC, 50/60 Hz, 0.62A  
(for the models for other areas)

### Power consumption (standby mode)

Approximately 1 W

### Operating temperature

5 °C to 35 °C (41 °F to 95 °F)

### Dimensions

Approx. 242 x 72 x 267 mm  
(w/h/d, excluding protruding parts)  
(9 5/8 x 2 7/8 x 10 5/8 inches)  
(363 mm (14 3/8 inches) of depth when the paper tray is installed.)

### Mass

Approx. 2.1 kg (4 lb 10 oz)  
(excluding the 0.1 kg (4 oz) paper tray)

### Supplied accessories

See "Unpacking the printer" of the Operating Instructions – Basic Operations.

Design and specifications are subject to change without notice.

## Identifying the parts

### Printer

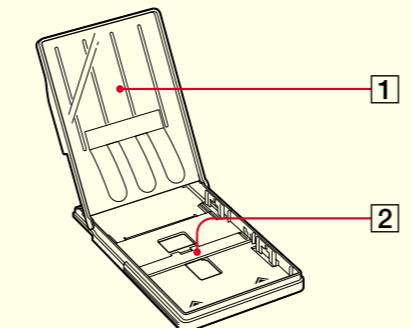
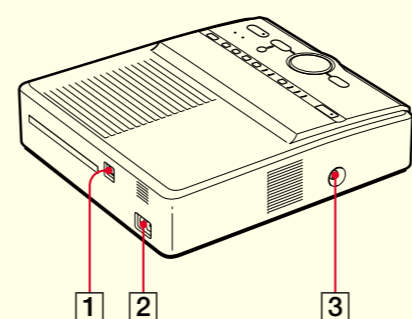
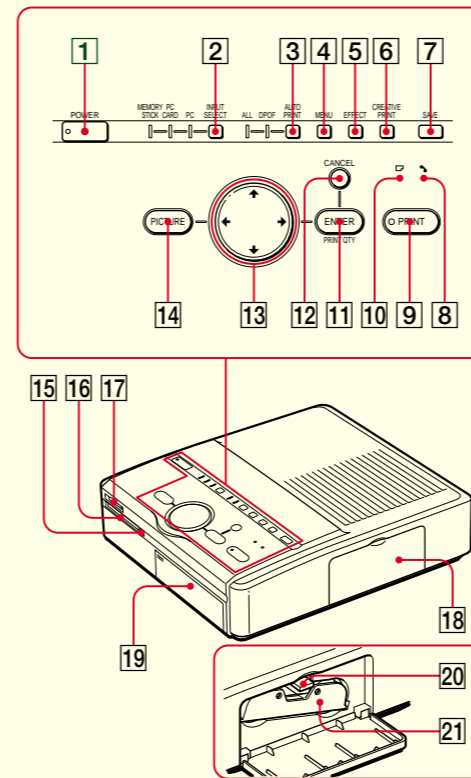

### Front

- POWER switch**
- INPUT SELECT button**  
Switches the input among "MEMORY STICK," "PC CARD," or "PC." (The selected indicator lights.)
- AUTO PRINT button**  
Selects the automatic printing of "ALL" images or "DPOF" images. (The selected printing indicator lights.)
- MENU button**  
Displays the menu to change printer settings.
- EFFECT button**  
Displays the menu to add effects to the pictures.
- CREATIVE PRINT button**  
Displays the menu to make creative prints.
- SAVE button**  
Saves an image on a "Memory Stick" or PC card.
- Cartridge error indicator**
- PRINT button**
- Paper error indicator**
- ENTER/PRINT QTY button**
- CANCEL button**
- Arrow (←/→/↑/↓) button**
- PICTURE button**  
Switches the thumbnail list and preview image.
- PC card eject button**
- PC CARD insertion slot**
- "MEMORY STICK" insertion slot**
- Cartridge compartment lid**
- Paper tray compartment lid**
- Print cartridge eject lever**
- Print cartridge**

### Rear

- USB connector**
- AC IN connector**
- VIDEO OUT connector**

### Paper tray

- lid**
- Partition**

### Screen

#### Thumbnail list

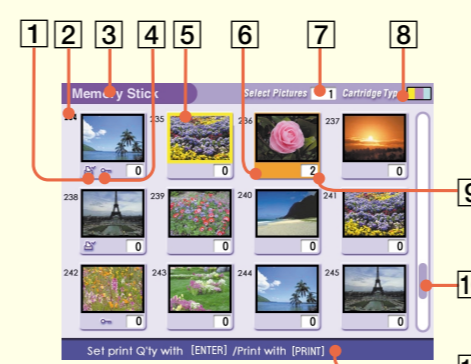

#### Preview image

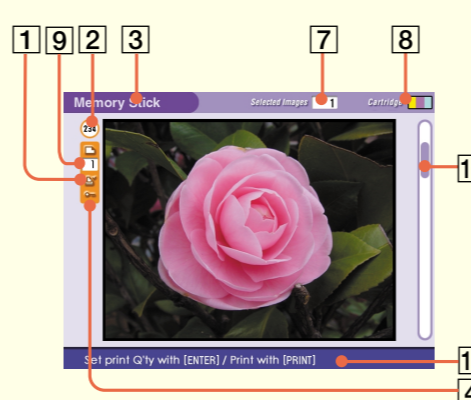

# Digital Photo Printer

## Operating Instructions – Software Guide/Additional Information

This manual describes the additional information and the installation and basic operations of the software supplied with the Sony Digital Photo Printer DPP-SV55. First read "Operating instructions – Basic Operations" and then read this manual and retain it for future reference.

For advanced operation of the printer, also refer to "Operating Instructions – Advanced Operations."



## DPP-SV55

© 2000 Sony Corporation

## Notice for users

Program © 2000 Sony Corporation  
Documentation ©2000 Sony Corporation

All rights reserved. This manual or the software described herein, in whole or in part, may not be reproduced, translated or reduced to any machine readable form without prior written approval from Sony Corporation. IN NO EVENT SHALL SONY CORPORATION BE LIABLE FOR ANY INCIDENTAL, CONSEQUENTIAL OR SPECIAL DAMAGES, WHETHER BASED ON TORT, CONTACT, OR OTHERWISE, ARISING OUT OF OR IN CONNECTION WITH THIS MANUAL, THE SOFTWARE OR OTHER INFORMATION CONTAINED HEREIN OR THE USE THEREOF.

By breaking the seal of the envelope of the CD-ROM package, you accept all the terms and conditions of this agreement. If you do not accept these terms and conditions, please return this disk envelope unopened, along with the rest of the package, immediately to the dealer where you obtained it.

Sony Corporation reserves the right to make any modification to this manual or the information contained herein at any time without notice. The software described herein may also be governed by the terms of a separate user license agreement.

### User Registration

To receive customer services, complete and return the registration card included in your package.

Any design data such as sample pictures provided in this software cannot be modified or duplicated except for the purpose of personal use. Any unauthorized duplication of this software is prohibited under copyright law.

Please note that unauthorized duplication or modification of others' portraits or copyrighted work could infringe the rights reserved by right holders.

## Using the printer with Windows

The supplied software enables you to print an image of your computer’s hard disk with the Digital Photo Printer DPP-SV55. You can also view, copy, or transfer the images stored in a “Memory Stick” or PC card being inserted in the printer from your computer’s monitor. To print an image from the computer, you need a commercially available printing application software.

### System requirements

To use the supplied software, you need a computer that must meet the following system requirements:

- OS:** Microsoft Windows 98/Windows 98SE/Windows Me should be pre-installed.(We cannot guarantee any operations with the computer where Windows 3.1 or Windows 95 is upgraded to Windows 98 or Windows 98 is upgraded to Windows Me.)
- CPU:** MMX Pentium 200 MHz and above is recommended.
- RAM:** 32 MB or more (64 MB or more is recommended.)
- Hard disk space:** 50 MB or more (It depends on the number of copies you print.)
- Port:** USB port should be installed as standard.
- Drive:** CD-ROM drive (for software installation)

**Notes**

- We cannot guarantee the printer operations when a hub is used or when two or more USB devices are connected to your computer.
- When two or more DPP-SV55 printers are connected to your computer, you cannot operate the printer.
- You cannot operate the printer from another USB device being used simultaneously.

## Installing the software

Install the printer driver and Memory Stick/PC card reader software contained in the supplied CD-ROM into your computer’s hard disk.

### Installing the USB driver

#### 1 Turn on your computer and the printer.

#### 2 Start Windows and then connect your computer and the printer.

When the computer detects the printer, the “Add New Hardware Wizard” dialog box is displayed. For the connections, refer to “Connecting the printer” of “Operating Instructions – Basic Operations.”

**Note**

Close all programs before running the installer.

#### 3 Click “Next.”

The dialog box to select searching method appears.

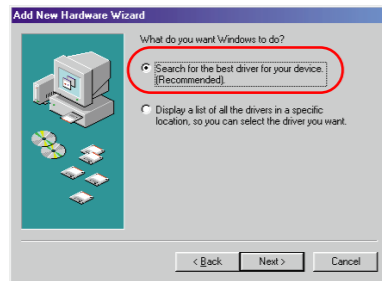

#### 4 Check “Search for the best driver for your device (Recommended).” and click “Next.”

The dialog box to specify the driver location is displayed.

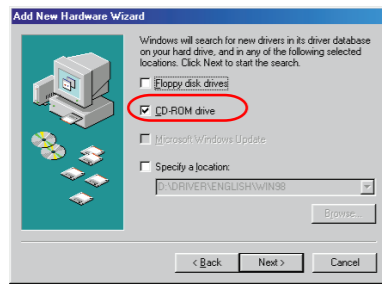

#### 5 Insert the supplied CD-ROM into your CD-ROM drive and check “CD-ROM drive.” Then click “Next.”

Installation starts. When installation ends, the “Finish Setup” dialog box appears.

**Note**

During installation, you may be asked to insert the Windows OS CD-ROM.

#### 6 Click “Finish.”

The Sony DPP-SV55 USB driver is installed.

### To check the installation

- 1 Click “Start,” point to “Settings” and then click “Control Panel.” The “Control Panel” window is displayed.
- 2 Double-click “System.” The “System Properties” window is displayed.
- 3 Click “Device Manager” tab. When “Sony DPP-SV55 USB Digital Photo Printer” is listed under “Universal serial bus controller,” installation is completed successfully.

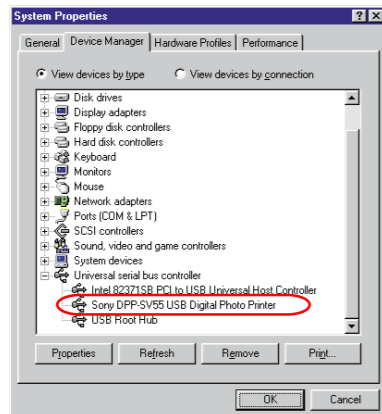

### Installing the printer driver and reader software

#### 1 Insert the supplied CD-ROM into your CD-ROM drive and click “Start,” and then click “Run.”

The “Run” dialog box is displayed.

#### 2 Input “D:\Setup.exe” (When your CD-ROM drive is D: drive) then click “OK.”

If your CD-ROM drive is not D: drive, input the relevant drive name. You can also input the location of the installer by clicking the “Browse” button. The installer automatically starts, and the language selection dialog box appears.

#### 3 Select the language for the application, then click “OK.”

The “Welcome” dialog box appears.

#### 4 Click “Next.”

The “Choose Destination Location” dialog box is displayed. The files are factory-set installed to “C:\Program Files\Sony\DPSPV55” folder. If you want to install them to another folder, input the destination folder or specify the destination folder by clicking the “Browse” button.

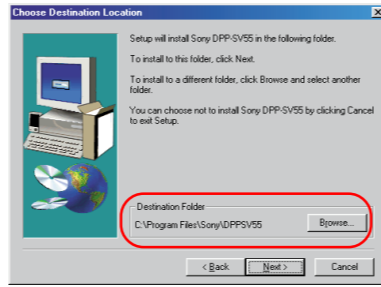

#### 5 Click “Next.”

“Add Printer Wizard” starts up.

#### 6 Click “Next.”

The dialog box to select printer connection is displayed.

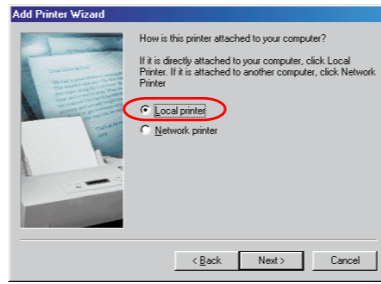

#### 7 Check “Local printer” and click “Next.”

The dialog box to select the manufacturer and model of the printer is displayed.

#### 8 Click “Have Disk.”

The “Install From Disk” dialog box is displayed.

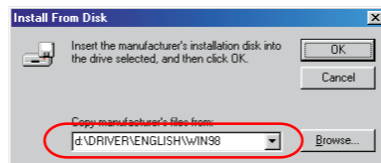

#### 9 Input “D:\DRIVER\ENGLISH\WIN98” (D: stands for the CD-ROM drive/ENGLISH stands for your language) and click “OK.”

The dialog box to select the model name is displayed.

You can also input the location by clicking the “Browse” button.

#### 10 Select “Sony DPP-SV55” and click “Next.”

Copying files started. The dialog box to select the port is displayed.

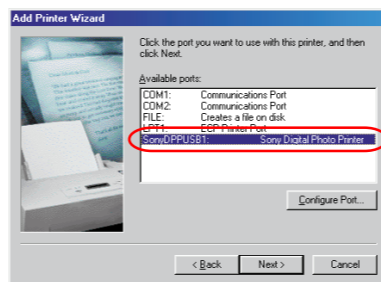

**Note**

During installation, you may be asked to insert the Windows OS CD-ROM.

#### 11 Select “Sony DPPUSB1: Sony Digital Photo Printer” in the list and click “Next.”

The dialog box to select the printer name is displayed. It is factory-set named “Sony DPP-SV55.” If you use another name, input the name in the text box.

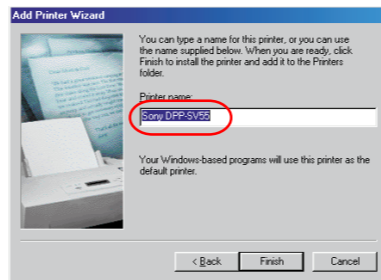

#### 12 Click “Finish.”

The “Setup Complete” dialog box is displayed.

#### 13 Click “Finish.”

Printer driver and reader software are installed. The readme file is displayed. “Sony DPP-SV55” is added to the “Printers” window.

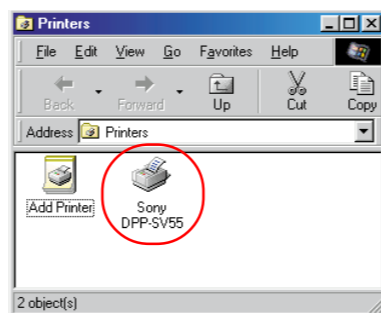

### Uninstalling the software

When the software becomes unnecessary, you need to remove the software from your computer’s hard disk. Uninstall the software in the following procedures:

#### Uninstalling the “Sony DPP-SV55”

- 1 Disconnect the USB cable from the printer and the computer.
- 2 Click “Start,” point to “Settings” and then click “Control Panel.”
- 3 Double-click “Add/Remove Programs” in the “Control Panel” window.
- 4 In the “Install/Uninstall” tab of the “Add/Remove Programs Properties” window, select “Sony DPP-SV55” and click “Add/Remove.”

## Using the reader software

You can view the “Memory Stick” or PC card inserted in the printer as a drive on your computer’s monitor. In “My Computer” or “Windows Explorer” window, select “Sony DPP-SV55” and then “Memory Stick” or PC card icon to display the images stored. You can copy, transfer and save the “Memory Stick” or PC card images as other Windows files.

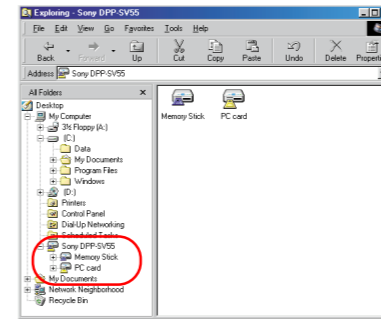

**Note**

The reader software does not operate the DPP-SV55 as a complete removable medium. When using the software, note the following restrictions:

- Before editing an image of the “Memory Stick” or PC card inserted in the printer, store it onto the computer’s hard disk.
- If you double-click and open the file in the printer with its associated application and edit it with the

application, you cannot save the edition on the “Memory Stick” or PC card with the application’s saving command.

- You cannot view nor open the file in the printer from the “Open” command of an application other than the reader software.
- You cannot run an execution file contained in the “Memory Stick” or PC card.

## Printing from an application software

You can use the “Print” command of an application software to print your computer’s hard disk images with the DPP-SV55 Digital Photo Printer. Select “Print” from the “File” menu. In the “Print” dialog box, select “Sony DPP-SV55” as the printer, set the range and number of copies and print images.

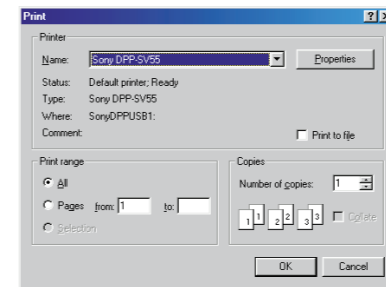

### To set the printer in detail

Click “Properties” in the “Print” dialog box to display the “Properties” window. Set the printer in detail in each tab:

**Paper tab**

- ① Set “Paper Size.”

Choose	When you make
Post Card (no margin)	Post Card Size borderless print
Post Card	Post Card Size border print
Small	Small Size print

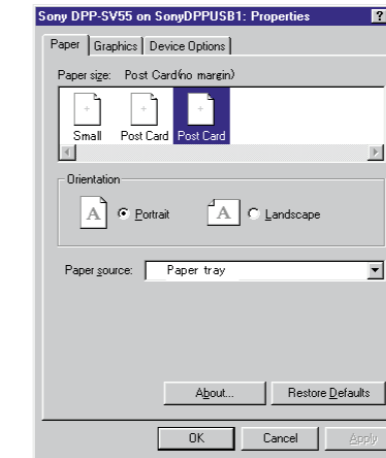

- ② Set “Orientation.” To print in portrait (tall) format, select “Portrait.” To print in landscape (wide) format, select “Landscape.”

**Note**

Depending on the application, you can set the printer in the “Page Setup” or “Printer Setup” dialog box from the “File” menu.

**Graphics tab**

You can set the resolution when printing an image. You cannot specify dithering, intension, and color.

**Device Options tab**

You can select finish either from “Glossy” or “Texture.”

**Note**

To make a print as expected, we suggest you use the application software that allows you to check the print preview. If you use the application that you cannot check the preview, make the image size to 1664 (dots) x 2466 (dots) and the resolution to 403 dpi.

## Using the printer with Macintosh

The supplied software enables you to print an image from your Macintosh with the Digital Photo Printer DPP-SV55. To print an image from the computer, you need a commercially available printing application software.

### System requirements

To use the supplied software, you need a Macintosh computer that must meet the following system requirements.

- OS:** Mac OS 8.5.1/8.6/9.0 should be pre-installed.
- Port:** USB port should be installed as standard.
- RAM:** 32 MB or more (64 MB or more is recommended.)
- Hard disk space:** 50 MB or more (It depends on the number of copies you print.)
- Drive:** CD-ROM drive (for software installation)

**Notes**

- We cannot guarantee the printer operations when a hub is used or when two or more USB devices are connected to your computer.
- When two or more DPP-SV55 printers are connected to your computer, you cannot operate the printer.
- You cannot operate the printer from another USB device being used simultaneously.

## Installing the printer driver

Install the Sony DPP-SV55 Printer Driver Software for Mac OS 8.5.1/8.6/9.0 Ver. 1.0 (“printer driver” in this manual) into your Macintosh.

#### 1 Connect your Macintosh and the printer.

For the connections, refer to “Connecting the printer” of “Operating Instructions – Basic Operations.”

**Note**

Close all programs before running the installer.

#### 2 Turn on the printer and start your Macintosh.

#### 3 Insert the supplied CD-ROM into your CD-ROM drive and select the software language by double-clicking the corresponding folder in the CD-ROM.

The selected language folder opens.

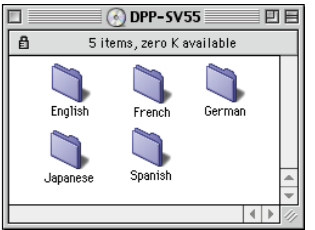

#### 4 Double-click “Setup Program.”

#### 5 Click “Install.”

Installation starts. Follow the instructions on the screen to complete installation.

### Uninstalling the printer driver

When the software becomes unnecessary, remove the software as follows: In step 5, click “Uninstall.”

## Printing from an application software

You can use an application software to print your computer’s hard disk images with the DPP-SV55 Digital Photo Printer.

#### 1 Select “Chooser” from the Apple menu and click “Sony DPP-SV55” in the “Chooser.”

#### 2 Close the “Chooser” and select “Print Setup” from the “File” menu and set printing in detail.

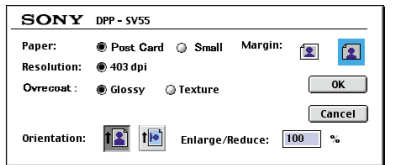

Paper/Margin	To make Post Card Size borderless print, click “Post Card” and no margin icon . To make border Post Card Size print, click “Post Card” and margin icon . To make Small Size print, click “Small.”
Orientation	To print a wide image, click landscape icon . To print a tall image, click portrait icon .
Overcoat	Select the overcoat type (“Glossy” / “Texture”).
Enlarge/Reduce	Select the enlarged or reduced size to be printed.

#### 3 Click “OK” to close the dialog box and select “Print” from the “File” menu to start printing.

Specify the printing range and copies. Then click “Preview” to display the print preview or “Print” to start printing.

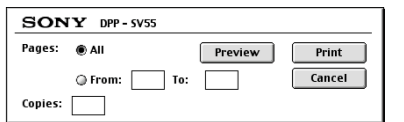

**Note**

To make a print as expected, we suggest you use the application software that allows you to check the print preview. Otherwise, make the image size to 1664 (dots) x 2466 (dots) and the resolution to 403 dpi.