

Digital Photo Printer/Frame  
DPP-F800

Read This First

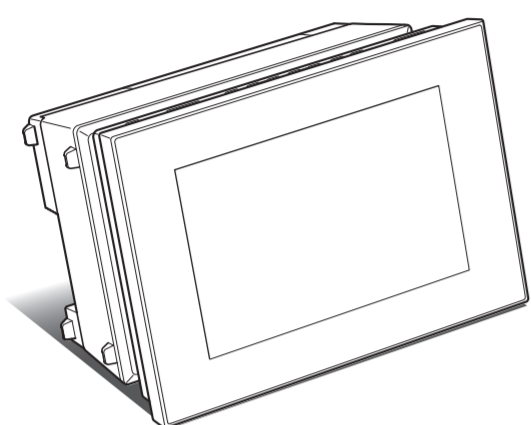

Welcome to the Sony DPP-F800 Digital Photo Printer/Frame.

This leaflet explains preparations and basic viewing and printing procedures. To customize this unit and to enjoy a variety of viewing and printing options, please read the Operating Instructions also supplied.

© 2010 Sony Corporation Printed in China

Getting started

1 Preparing the remote control.

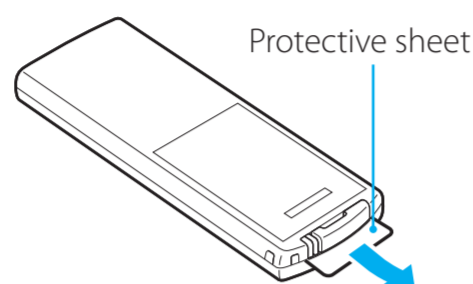

Pull out the protective sheet before use as illustrated.

The supplied lithium battery (CR2025) is already inserted into the remote control.

2 Connecting to the AC power source.

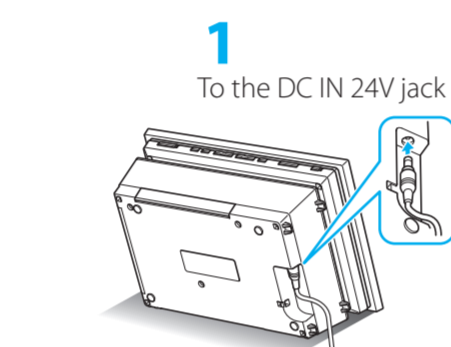

1 Insert the plug of the AC adaptor into the DC IN 24V jack on the back of this unit.

2 Connect the AC adaptor to the wall outlet.

→ This unit automatically turns on.

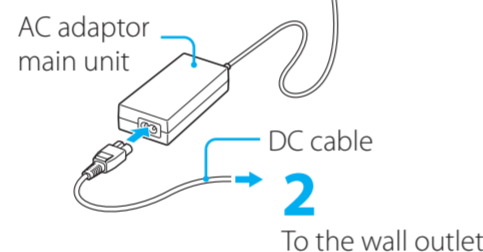

This unit automatically turns on when the AC adaptor is connected to the wall outlet. Step 3 is only required when this unit is turned off with the AC adaptor connected to the wall outlet.

3 Turn this unit on.

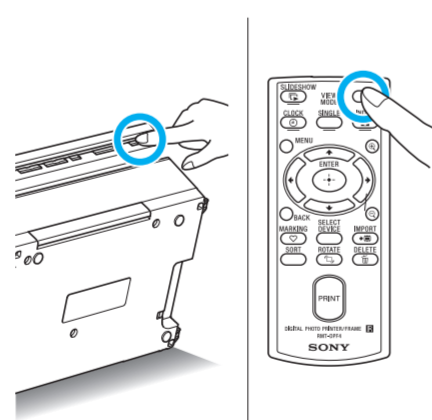

Press (on/standby).

→ The standby indicator on the (on/standby) of this unit lights up in green and the Sony logo at the bottom of the LCD lights up.

4 Setting the current date and time.

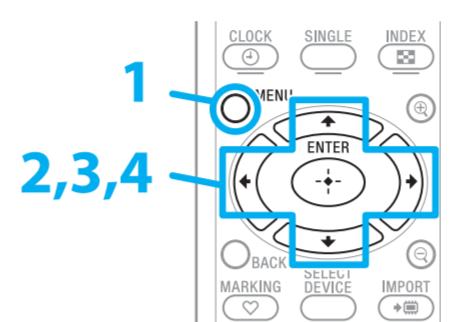

1 Press MENU.

2 Press ←/→ to select the (Settings) tab.

3 Press ↑/↓ to select [Date/time Settings] and then press (ENTER).

4 Set the current date and time following the guidance on the screen.

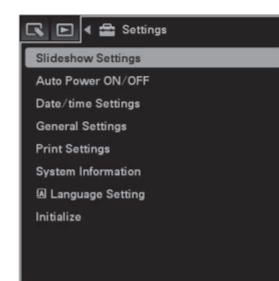

5 Inserting a memory card.

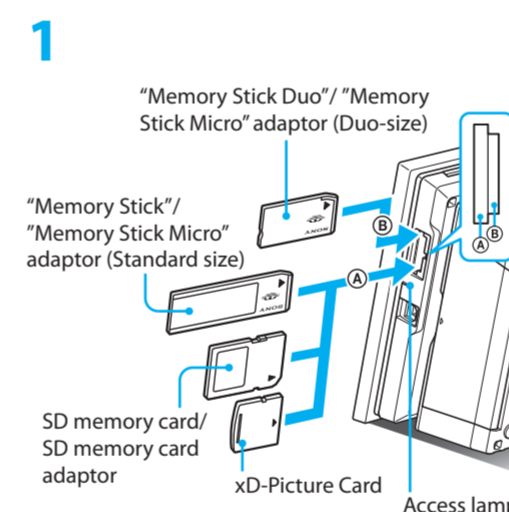

1 Insert a memory card firmly into the designated slot.

→ The access lamp flashes when the memory card is inserted correctly.

• When using a mini SD/SDHC ①, micro SD/SDHC ② or "Memory Stick Micro" media ③, be sure to insert it in an appropriate adaptor.

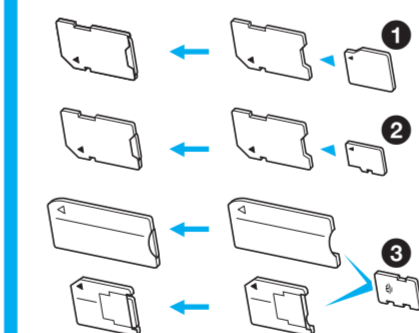

• If the access lamp does not flash, check if the memory card is inserted in the correct direction.

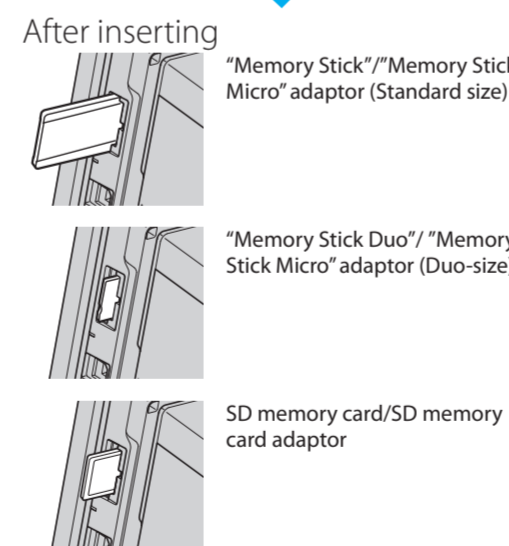

2 A slideshow of the images stored on the inserted memory card starts automatically.



Viewing images

1 Selecting view mode.

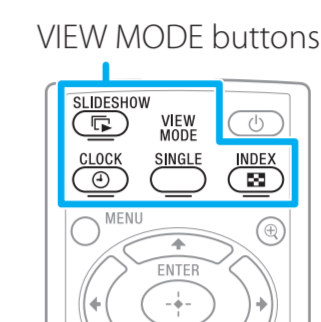

Press the button corresponding to view mode you want to select. For details, refer to page 26 to 31 in the Operating Instructions.

Buttons and display type of view mode

(Clock) Clock and Calendar

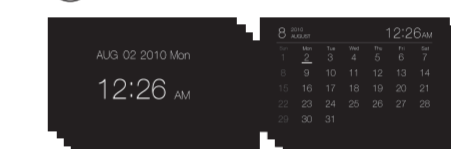

(Index) Index



(Single) single image display

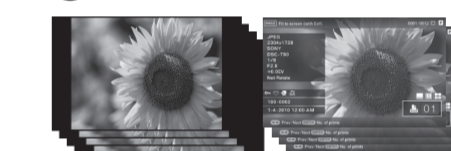

(Slideshow) Slideshow

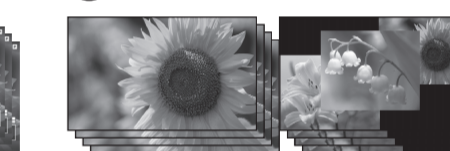

2 Selecting a style.

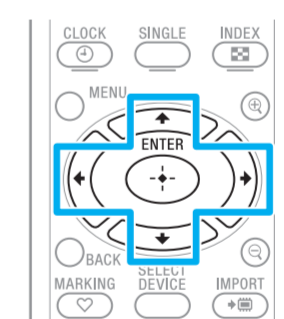

Press ←/→/↑/↓ to select a style and press (ENTER).



Styles

Various styles are available in each view mode. Select the style you want. For details on view styles, see the explanation of view mode in the Operating Instruction.

You can rotate this unit to portrait or landscape orientation. (The orientation of the image on the screen automatically changes according to the orientation of this unit.)

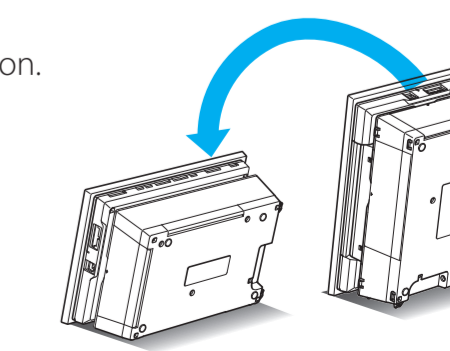

Checking the contents of the package

Digital Photo Printer/Frame (1)

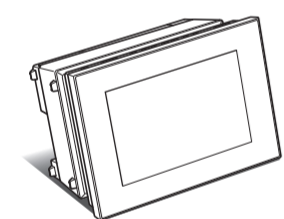

Cleaning cartridge (1)/  
Cleaning sheet (1)  
(Used for cleaning inside this unit.)

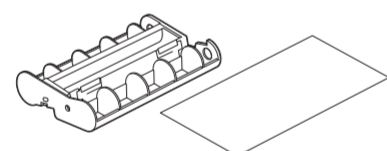

Remote control (1)



Operating Instructions (1)



Paper tray (1)

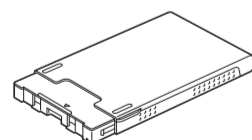

Read This First (this leaflet) (1)



AC adaptor (1)

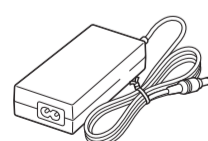

About the Print Packs (1)



Power cord (1)

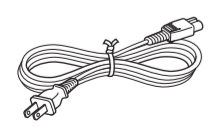

CD-ROM (1)

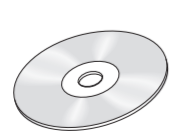

Warranty (1)  
(In some regions, the warranty is not supplied.)  
Sony End User Software License Agreement (1)

Note

The plug shape and specifications of the power cord differ depending on the region in which you purchased this unit.

## Before printing

**1** Lay this unit flat (print position) and open the paper tray compartment door.

**2** Tilt the screen up.

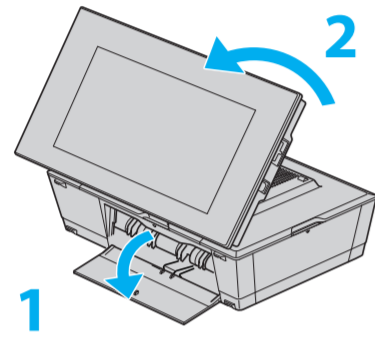

## Printing

**1** Inserting the print paper into the paper tray.

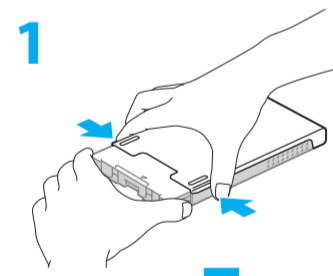

**1** Open the paper tray cover. Hold both sides of the paper tray cover (as shown with arrows) and open it.

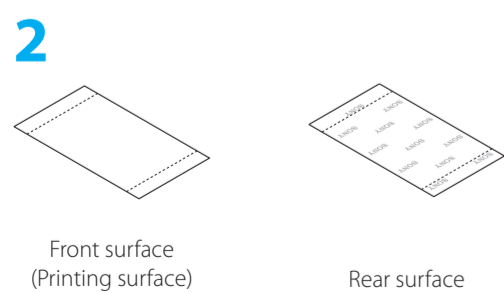
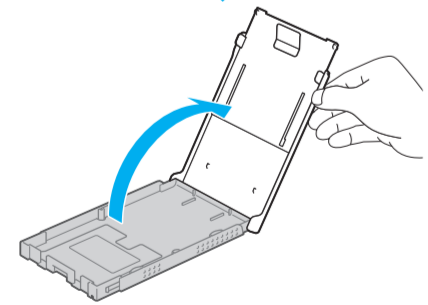

**2** Make sure the print paper is not upside down.

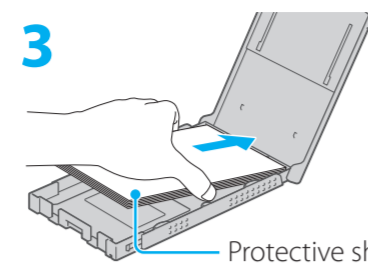

**3** Insert the print paper into the paper tray with the protective sheet facing up.

Protective sheet (If there is no protective sheet, insert the print paper into the paper tray with the printing surface (plain white side) facing up.)

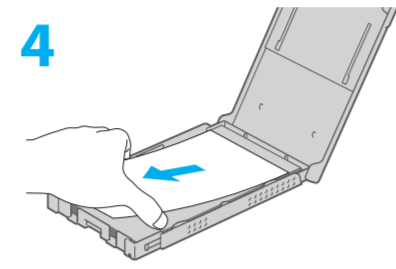

**4** Remove the protective sheet from the tray. You cannot print on a protective sheet. (Doing so may cause a malfunction.)

### Notes

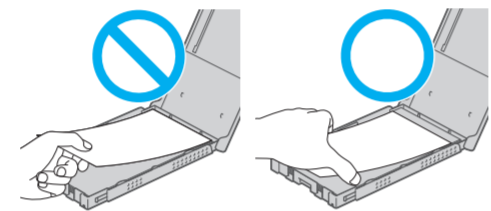

Do not touch the printing surface!



Do not cut off from perforated portions!

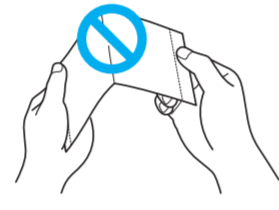

Do not bend!



Do not use used print paper!

- You can use Sony optional color print packs designed for this unit, only. You cannot use the other print packs. For color print packs you can use, refer to the "About the Print Packs" also supplied.
- You can set up to 20 sheets of print paper.
- Make sure the print paper is not upside down before printing.

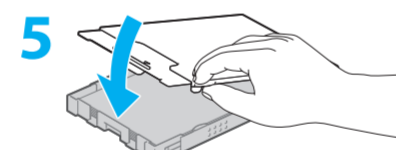

**5** Close the paper tray cover.

### If you cannot close the tray cover

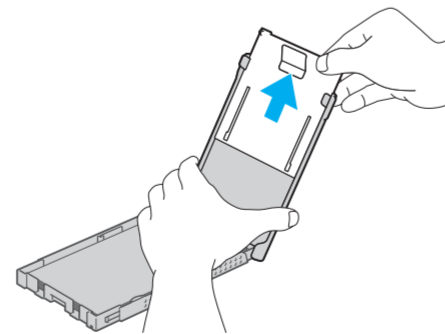

Stretch out the slide cover, and then close the tray cover.

**2** Insert the paper tray and ink ribbon until each clicks into place.

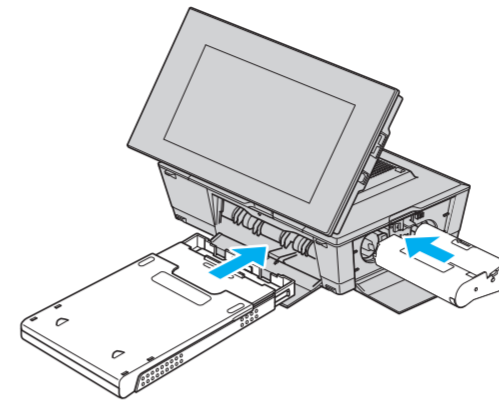

### Installation place for printing

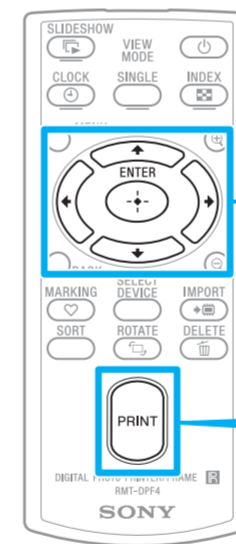
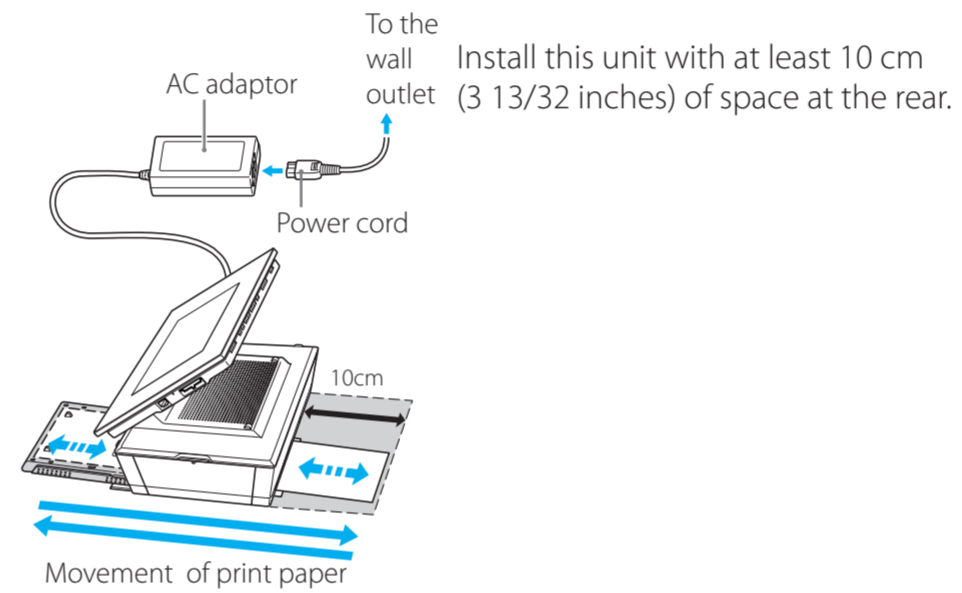

**3** Select an image for printing.

Press the ◀/▶ button repeatedly until the image that you want to print appears.

**4** Press PRINT.

## Cleaning

If white lines or period-like dots are printed on the pictures, clean the inside of this unit. For details, refer to page 97 in the Operating Instructions.

- 1 Remove any memory cards, USB cables, the ink ribbon, the paper tray, and print paper from this unit.
- 2 Place the cleaning sheet into the paper tray with the no-imprint side facing up.
- 3 Set the supplied cleaning cartridge and the paper tray into this unit and press PRINT.

## What you can print with this unit

Enjoy your printing in a variety of ways

### Creative Print

→ Pages 55 to 59 in the Operating Instructions



Calendar



Layout print



ID Photo

### Batch Print

→ Page 60 in the Operating Instructions



Index Print  
Print All  
DPOF Print

## The printing process

The printer employs a dye sublimation printing system. In this printing system, a thermal print head heats up as it passes over the yellow, magenta and cyan layer of the ink ribbon, causing the dyes to vaporize and permeate the surface of the print paper. A final cycle lays down a laminate layer to protect the printed surface.

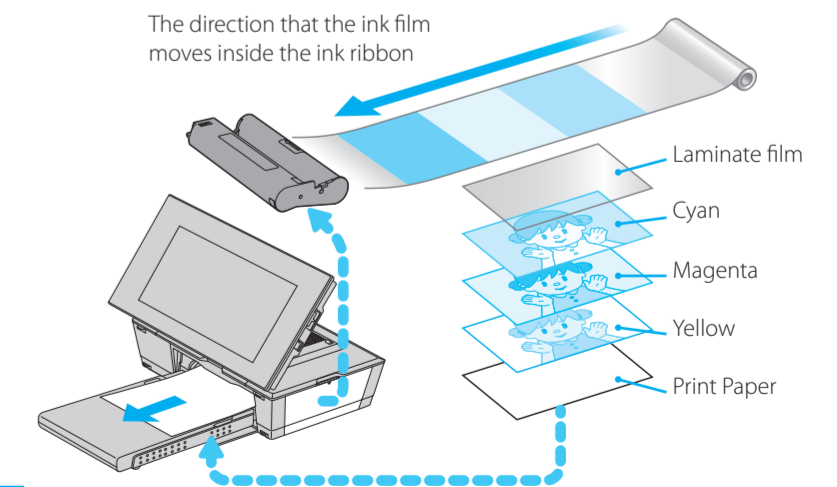

### Notes

- The ink ribbon cannot be reused. You cannot reuse it by rewinding.
- The number on the ink ribbon cartridge is the maximum number of sheets that can be printed with that cartridge. (e.g. SVM-F40P means you can print up to 40 sheets.)
- Print paper emerges from the back and front paper outlets each time a color is printed. Wait until printing is completed and the print paper is automatically ejected onto the paper tray.