

Panasonic®

OPERATING INSTRUCTIONS

Personal Computer

Model No. **CF-T7** series

Contents

Getting Started

Introduction	2
Read Me First	3
Description of Parts	9
First-time Operation	11

Getting Started

Useful Information

On-screen Manual	17
Handling and Maintenance	19
Expanding Memory	22
Hard Disk Backup/Restore Function	24
Hard Disk Data Erase Utility	25
Reinstalling Software	26

Useful Information

Troubleshooting

Troubleshooting (Basic)/Error Code/Message	28
Hardware Diagnostics	32

Troubleshooting

Appendix

LIMITED USE LICENSE AGREEMENT	34
Specifications	35

Appendix



For further information about the computer, you can refer to the on-screen manual.

To access the on-screen manual
→ page 17 "On-screen Manual"

Introduction

Thank you for purchasing this Panasonic computer. For optimum performance and safety, please read these instructions carefully.

■ Terms and illustrations in these instructions

CAUTION :	Conditions that may result in minor or moderate injury.
NOTE :	Useful and helpful information.
Enter :	Press [Enter] key.
Fn + F5 :	Press and hold [Fn] key, and then press [F5] key.
 (Start) - [All Programs] :	Click  (Start), and then click [All Programs].
→ :	Page in these Operating Instructions.
→  :	Reference to the on-screen manuals.

- Some illustrations are simplified to help your understanding and may look different from the actual unit.
- If you do not log on as an administrator, you cannot use some functions or cannot display some screens.
- Refer for the latest information about optional products to the catalogs, etc.
- In these instructions, the names and terms are referred as follows.
 - “Windows Vista® Business” as “Windows” or “Windows Vista”
- The display modes are referred as follows. () indicates the terms in [Intel® Graphics Media Accelerator Driver for mobile] screen. To display the screen, right-click the desktop and click [Graphics Properties].
 - Internal LCD (Notebook): The computer’s display
 - External display (Monitor): External display
 - Simultaneous display (Intel (R) Dual Display Clone): The same screen is displayed on the internal LCD and the external display.
 - Extended desktop: The extended working area across the internal LCD and the external display.

■ Copyright

This manual is copyrighted by Matsushita Electric Industrial Co., Ltd. with all rights reserved. No part of this manual may be reproduced in any form without the prior written permission of Matsushita Electric Industrial Co., Ltd.

No patent liability is assumed with respect to the use of the information contained herein.

© 2007 Matsushita Electric Industrial Co., Ltd. All Rights Reserved.

■ Disclaimer

Computer specifications and manuals are subject to change without notice. Matsushita Electric Industrial Co., Ltd. assumes no liability for damage incurred directly or indirectly from errors, omissions or discrepancies between the computer and the manuals.

■ Trademarks

Microsoft®, Windows®, Windows Vista®, IntelliMouse and the Windows logo are registered trademarks of Microsoft Corporation of the United States and/or other countries.

Intel, Core and Centrino are either registered trademarks or trademarks of Intel Corporation.

SDHC Logo is a trademark.



Adobe, the Adobe logo and Adobe Reader are either registered trademarks or trademarks of Adobe Systems Incorporated in the United States and/or other countries.

PhoenixBIOS, Phoenix Always and Recover Pro are trademarks and/or registered trademarks of Phoenix Technologies Ltd.

Bluetooth™ is a trademark owned by Bluetooth SIG, Inc., U.S.A. and licensed to Matsushita Electric Industrial Co., Ltd.

Computrace® is a registered trademark of Absolute® Software Corp.

Panasonic® is a registered trademark of Matsushita Electric Industrial Co., Ltd.

Names of products, brands, etc., appearing in this manual are trademarks or registered trademarks of their respective own companies.

Read Me First

Models for Europe

<Only for model with a “CE” mark on the bottom of the computer>



Declaration of Conformity (DoC)

“Hereby, we declare that this Personal Computer is in compliance with the essential requirements and other relevant provisions of the Directive 1999/5/EC.”

Hint:

If you want to get a copy of the original DoC of our products which relates to the R&TTE, please contact our web address: <http://www.doc.panasonic.de>

Contact and Pursuant to at the directive 2004/108/EC, article 9(2)
Panasonic Testing Centre
Panasonic Service Europe, a division of Panasonic Marketing Europe GmbH
Winsbergring 15, 22525 Hamburg, F.R. Germany

Network connection.

The terminal equipment is intended for connection to the following public network;

In all the countries of European Economical Area;

- Public Switched Telephony Networks

Technical Features.

The terminal equipment includes the following features;

- DTMF dialing

- Maximum bitrate receiving mode: 56 kbit/s

- Maximum bitrate sending mode: 33.6 kbit/s

This product is designed to interwork with the Public Switched Telecommunication Networks in UK, Ireland, Netherlands, Sweden, Denmark, Finland, Switzerland, Luxembourg, Belgium, France, Germany, Spain, Portugal, Iceland, Greece, Italy, Norway and Austria.

18-E-2

<Only for model with a “CE Ⓢ” mark on the bottom of the computer>



Declaration of Conformity (DoC)

Hereby, we declare that this Personal Computer is in compliance with the essential requirements and other relevant provisions of the Directive 1999/5/EC.

Hint:

If you want to get a copy of the original DoC of our products which relates to the R&TTE, please contact to our web address: <http://www.doc.panasonic.de>

Contact and Pursuant to at the directive 2004/108/EC, article 9(2)

Panasonic Testing Centre

Panasonic Service Europe, a division of Panasonic Marketing Europe GmbH

Winsbergring 15, 22525 Hamburg, F.R. Germany

25-E-1-2

Information of Countries intended for radio application:

The United Kingdom, The Federal Republic of Germany, The Kingdom of Belgium,
The Swiss Confederation, The Grand Duchy of Luxembourg, The Republic of Lithuania,
The Republic of Estonia, The Republic of Slovenia, The Republic of Latvia,
The Republic of Hungary, The Republic of Poland, Sweden, Italy, Ireland, Romania,
Czech Republic, Slovak Republic, The Netherlands, Portuguese Republic, France, Norway,
Austria, Finland, Spain, Denmark, Greece

25-E-2-2

Models for UK

Warning

This apparatus must be earthed for your safety.

To ensure safe operation the three-pin plug must be inserted only into a standard three-pin power point which is effectively earthed through the normal household wiring.

Extension cords used with the equipment must be three-core and be correctly wired to provide connection to earth.

Wrongly wired extension cords are a major cause of fatalities.

The fact that the equipment operates satisfactorily does not imply that the power point is earthed and that the installation is completely safe.

For your safety, if you have any doubt about the effective earthing of the power point, consult a qualified electrician.

Read Me First

FOR YOUR SAFETY PLEASE READ THE FOLLOWING TEXT CAREFULLY

This appliance is supplied with a moulded three pin mains plug for your safety and convenience.

A 3 amp fuse is fitted in this plug.

Should the fuse need to be replaced please ensure that the replacement fuse has a rating of 3 amps and that it is approved by ASTA or BSI to BS 1362.

Check for the ASTA mark  or the BSI mark  on the body of the fuse.

If the plug contains a removable fuse cover you must ensure that it is refitted when the fuse is replaced.

If you lose the fuse cover the plug must not be used until a replacement cover is obtained.

A replacement fuse cover can be purchased from your local Panasonic Dealer.

IF THE FITTED MOULDED PLUG IS UNSUITABLE FOR THE SOCKET OUTLET IN YOUR HOME THEN THE FUSE SHOULD BE REMOVED AND THE PLUG CUT OFF AND DISPOSED OF SAFELY.

THERE IS A DANGER OF SEVERE ELECTRICAL SHOCK IF THE CUT OFF PLUG IS INSERTED INTO ANY 13 AMP SOCKET.

If a new plug is to be fitted please observe the wiring code as shown below.

If in any doubt please consult a qualified electrician.

Warning: THIS APPLIANCE MUST BE EARTHED.

Important

The wires in this mains lead are coloured in accordance with the following code:

Green-and-yellow: Earth

Blue: Neutral

Brown: Live

As the colours of the wires in the mains lead of this apparatus may not correspond with the coloured markings identifying the terminals in your plug, proceed as follows:

The wire which is coloured GREEN-and-YELLOW must be connected to the terminal in the plug which is marked by the letter E or by the safety earth symbol  coloured GREEN or GREEN-and-YELLOW.

The wire which is coloured Blue must be connected to the terminal which is marked with the letter N or coloured BLACK.

The wire which is coloured Brown must be connected to the terminal which is marked with the letter L or coloured RED.

The mains plug on this equipment must be used to disconnect the mains power.

Please ensure that a socket outlet is available near the equipment and shall be easily accessible.

■ How to replace the fuse

Open the fuse compartment with a screwdriver and replace the fuse.

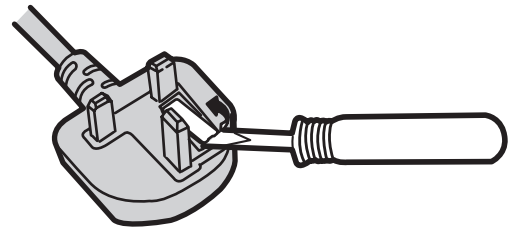

Warnings

- This equipment is not designed for connection to an IT power system.
(An IT system is a system having no direct connections between live parts and Earth; the exposed-conductive-parts of the electrical installation are earthed.)

An IT system is not permitted where the computer is directly connected to public supply systems in the U.K.)

- Disconnect the mains plug from the supply socket when the computer is not in use.

This equipment is produced to BS800/1983.

8-E-1

Important Safety Instructions

When using your telephone equipment, basic safety precautions should always be followed to reduce the risk of fire, electric shock and injury to persons, including the following:

1. Do not use this product near water, for example, near a bath tub, wash bowl, kitchen sink or laundry tub, in a wet basement or near a swimming pool.
2. Avoid using a telephone (other than a cordless type) during an electrical storm. There may be a remote risk of electric shock from lightning.
3. Do not use the telephone to report a gas leak in the vicinity of the leak.
4. Use only the power cord and batteries indicated in this manual. Do not dispose of batteries in a fire. They may explode. Check with local codes for possible special disposal instructions.

SAVE THESE INSTRUCTIONS

19-E-1

Information to the User

<Only for model with wireless LAN/Bluetooth>

This product and your Health

This product, like other radio devices, emits radio frequency electromagnetic energy. The level of energy emitted by this product however is far much less than the electromagnetic energy emitted by wireless devices like for example mobile phones.

Because this product operates within the guidelines found in radio frequency safety standards and recommendations, we believe this product is safe for use by consumers. These standards and recommendations reflect the consensus of the scientific community and result from deliberations of panels and committees of scientists who continually review and interpret the extensive research literature.

In some situations or environments, the use of this product may be restricted by the proprietor of the building or responsible representatives of the organization. These situations may for example include:

- Using this product on board of airplanes, or
- In any other environment where the risk of interference to other devices or services is perceived or identified as harmful.

If you are uncertain of the policy that applies on the use of wireless devices in a specific organization or environment (e.g. airports), you are encouraged to ask for authorization to use this product prior to turning on the product.

Regulatory Information

We are not responsible for any radio or television interference caused by unauthorized modification of this product. The correction of interference caused by such unauthorized modification will be the responsibility of the user. We and its authorized resellers or distributors are not liable for damage or violation of government regulations that may arise from failing to comply with these guidelines.

26-M-1

Lithium Battery

Lithium Battery!

This computer contains a lithium battery to enable the date, time, and other data to be stored. The battery should only be exchanged by authorized service personnel.

Warning! A risk of explosion from incorrect installation or misapplication may possibly occur.

15-E-1

Information on Disposal for Users of Waste Electrical & Electronic Equipment (private households)

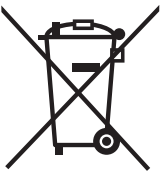

This symbol on the products and/or accompanying documents means that used electrical and electronic products should not be mixed with general household waste.

Please dispose of this item only in designated national waste electronic collection schemes, and not in the ordinary dust bin.

For business users in the European Union

If you wish to discard electrical and electronic equipment, please contact your dealer or supplier for further information.

Information on Disposal in other Countries outside the European Union

This symbol is only valid in the European Union.

If you wish to discard this product, please contact your local authorities or dealer and ask for the correct method of disposal.

36-E-1

Precautions

THIS PRODUCT IS NOT INTENDED FOR USE AS, OR AS PART OF, NUCLEAR EQUIPMENT/SYSTEMS, AIR TRAFFIC CONTROL EQUIPMENT/SYSTEMS, OR AIRCRAFT COCKPIT EQUIPMENT/SYSTEMS^{*1}. PANASONIC WILL NOT BE RESPONSIBLE FOR ANY LIABILITY RESULTING FROM THE USE OF THIS PRODUCT ARISING OUT OF THE FOREGOING USES.

^{*1} AIRCRAFT COCKPIT EQUIPMENT/SYSTEMS include Class2 Electrical Flight Bag (EFB) Systems and Class1 EFB Systems when used during critical phases of flight (e.g., during take-off and landing) and/or mounted on to the aircraft. Class1 EFB Systems and 2 EFB Systems are defined by FAA: AC (Advisory Circular) 120-76A or JAA: JAA TGL (Temporary Guidance Leaflets) No.36.

Panasonic cannot guarantee any specifications, technologies, reliability, safety (e.g. Flammability/Smoke/Toxicity/Radio Frequency Emission, etc) requirements related to aviation standards that exceed the specifications of our COTS (Commercial-Off-The-Shelf) products.

39-E-1

This computer is not intended for use in medical equipment including life-support systems, air traffic control systems, or other equipment, devices or systems that are involved with ensuring human life or safety. Panasonic cannot be held responsible in any way for any damages or loss resulting from the use of this computer in these types of equipment, devices or systems, etc.

If a Malfunction Occurs, Immediately Unplug the AC Plug and the Battery Pack

- This product is damaged
- Foreign object inside this product
- Smoke emitted
- Unusual smell emitted
- Unusually hot

Continuing to use this product while any of the above conditions are present may result in fire or electric shock.

- If a malfunction occurs, immediately turn the power off and unplug the AC plug, and then remove the battery pack. Then contact your technical support office.

Do Not Touch This Product and Cable When It Starts Thundering

Electric shock may result.

Do Not Connect the AC Adaptor to a Power Source Other Than a Standard Household AC Outlet

Otherwise, a fire due to overheating may result. Connecting to a DC/AC converter (inverter) may damage the AC adaptor. On an airplane, only connect the AC adaptor/charger to an AC outlet specifically approved for such use.

Do Not Do Anything That May Damage the AC Cord, the AC Plug, or the AC Adaptor

Do not damage or modify the cord, place it near hot tools, bend, twist, or pull it forcefully, place heavy objects on it, or bundle it tightly.

Continuing to use a damaged cord may result in fire, short circuit, or electric shock.

Do Not Pull or Insert the AC Plug If Your Hands Are Wet

Electric shock may result.

Clean Dust and Other Debris of the AC Plug Regularly

If dust or other debris accumulates on the plug, humidity, etc. may cause a defect in the insulation, which may result in a fire.

- Pull the plug, and wipe it with a dry cloth.
Pull the plug if the computer is not being used for a long period of time.

Insert the AC Plug Completely

If the plug is not inserted completely, fire due to overheating or electric shock may result.

- Do not use a damaged plug or loose AC outlet.

Do Not Place Containers of Liquid or Metal Objects on Top of This Product

If water or other liquid spills, or if paper clips, coins, or foreign matter get inside this product, fire or electric shock may result.

- If water spills in the keyboard, refer to page 21. If other foreign matter has found its way inside, immediately turn the power off and unplug the AC plug and remove the battery pack. Then contact your technical support office.

Do Not Disassemble This Product

There are high-voltage areas inside which may give you an electric shock if you should touch them. Do not touch the pins and circuit boards inside, and do not allow foreign matter to enter inside.

Also, remodeling or disassembly may cause a fire.

Keep SD Memory Cards Away from Infants and Small Children

Accidental swallowing will result in bodily injury.

In the event of accidental swallowing, see a doctor immediately.

Do Not Place This Product on Unstable Surfaces

If balance is lost, this product may fall over or drop, resulting in an injury.

Avoid Stacking

If balance is lost, this product may fall over or drop, resulting in an injury.

Do Not Keep This Product Wherever There is a Lot of Water, Moisture, Steam, Dust, Oily Vapors, etc.

Otherwise, possibly resulting in fire or electric shock.

Do Not Leave This Product in High Temperature Environment Such as in a Sun-Heated Car, for a Long Period of Time

Leaving this product where it will be exposed to extremely high temperatures such as in a sun-heated car or in direct sunlight may deform the cabinet and/or cause trouble in the internal parts. Continued use in such a resulting condition may lead to short-circuiting or insulation defects, etc. which may in turn lead to a fire or electric shocks.

Do Not Block the Ventilation Hole

Otherwise, heat will build up inside, possibly resulting in a fire.

Hold the Plug When Unplugging the AC Plug

Pulling on the cord may damage the cord, resulting in a fire or electric shock.

Do Not Move This Product While the AC Plug Is Connected

The AC cord may be damaged, resulting in fire or electric shock.

- If the AC cord is damaged, unplug the AC plug immediately.

Use Only the Specified AC Adaptor With This Product

Using an AC adaptor other than the one supplied (attached to your product or supplied by Panasonic) may result in a fire.

Do Not Subject the AC Adaptor to Any Strong Impact

Using the AC adaptor after a strong impact such as being dropped may result in electric shock, short circuit, or fire.

Take a Break of 10-15 Minutes Every Hour

Using this product for long periods of time may have detrimental health effects on the eyes or hands.

Do Not Turn the Volume Up to Loud When Using Headphones

Listening at high volumes that overstimulate the ear for long periods of time may result in loss of hearing.

Use the Modem with a Regular Telephone Line

Connection to an internal phone line (on-premise switches) of a company or business office, etc. or to a digital public phone or use in a country or area not supported by the computer may result in a fire or electric shocks.

Do Not Connect a Telephone Line, or a Network Cable Other Than the One Specified, into the LAN Port

If the LAN port is connected to a network such as the ones listed below, a fire or electric shock may result.

- Networks other than 1000BASE-T, 100BASE-TX or 10BASE-T
- Phone lines (IP phone (Internet Protocol Telephone), Telephone lines, internal phone lines (on-premise switches), digital public phones, etc.)

Do Not Use with Exposing the Skin to This Product for a Long Period of Time

Using this product with exposing the skin to the heat source of this product or AC adaptor for a long period of time can cause a low-temperature burn.

- Do not place the computer near a television or radio receiver.
- Keep the computer away from magnets. Data stored on the hard disk may be lost.

Interface Cable

Use of an interface cable longer than 3 m {9.84 feet} is not recommended.

11-E-1

Precautions (Battery Pack)

Do Not Use with Any Other Product

The battery pack is rechargeable and was intended for the specified product. If it is used with a product other than the one for which it was designed, electrolyte leakage, generation of heat, ignition or rupture may result.

Do Not Charge the Battery Using Methods Other Than Those Specified

If the battery is not charged using one of the specified methods, electrolyte leakage, generation of heat, ignition or rupture may result.

Do Not Throw the Battery Pack into a Fire or Expose It to Excessive Heat

Generation of heat, ignition or rupture may result.

Avoid Extreme Heat (Near the Fire, in Direct Sunlight, for Example)

Electrolyte leakage, generation of heat, ignition or rupture may result.

Do Not Insert Sharp Objects into the Battery Pack, Expose It to Bumps or Shocks, Disassemble, or Modify It

Electrolyte leakage, generation of heat, ignition or rupture may result.

Do Not Short the Positive (+) and Negative (-) Contacts

Generation of heat, ignition or rupture may result. Do not place the battery pack together with articles such as necklaces or hairpins when carrying or storing.

Do Not Use This Product with a Battery Pack Other Than the One Specified

Use only the specified battery pack (CF-VZSU51W/CF-VZSU52W) with your product. Use of battery packs other than those manufactured and supplied by Panasonic may present a safety hazard (generation of heat, ignition or rupture).

- Do not touch the terminals on the battery pack. The battery pack may no longer function properly if the contacts are dirty or damaged.
- Do not expose the battery pack to water, or allow it to become wet.
- If the battery pack will not be used for a long period of time (a month or more), charge or discharge (use) the battery pack until the remaining battery level becomes 30% to 40% and store it in a cool, dry place.
- This computer prevents overcharging of the battery by recharging only when the remaining power is less than approx. 95% (when Economy Mode (ECO) is enabled: 75%) of capacity.
- The battery pack is not charged when the computer is first purchased. Be sure to charge it before using it for the first time. When the AC adaptor is connected to the computer, charging begins automatically.

- Should the battery leak and the fluid get into your eyes, do not rub your eyes. Immediately flush your eyes with clear water and see a doctor for medical treatment as soon as possible.

NOTE

- The battery pack may become warm during recharging or normal use. This is completely normal.
- Recharging will not commence if internal temperature of the battery pack is outside of the allowable temperature range (0 °C to 55 °C). (→  *Reference Manual* "Battery Power") Once the allowable range requirement is satisfied, charging begins automatically. Note that the recharging time varies based on the usage conditions. (Recharging takes longer than usual when the temperature is 10 °C or below.)
- If the temperature is low, the operating time is shortened. Only use the computer within the allowable temperature range.
- The battery pack is a consumable item. If the amount of time the computer can be run by using a particular battery pack becomes dramatically shorter and repeated recharging does not restore its performance, the battery pack should be replaced with a new one.
- When transporting a spare battery inside a package, briefcase, etc., it is recommended that it be placed in a plastic bag so that its contacts are protected.
- Always power off the computer when it is not in use. Leaving the computer on when the AC adaptor is not connected will exhaust the remaining battery capacity.

Description of Parts

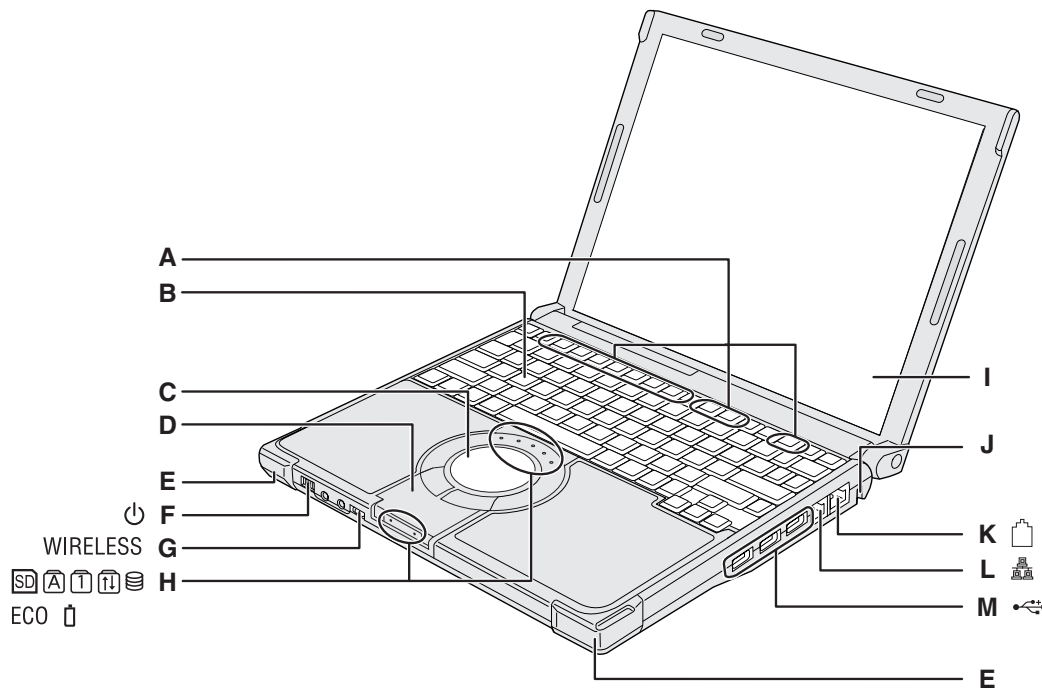

A : Function Key

→ Reference Manual "Key Combinations"

B : Keyboard

C : Touch Pad

→ Reference Manual "Using the Touch Pad"

D : Bluetooth Antenna

<Only for model with Bluetooth>

→ Supplementary Instructions of Bluetooth

E : Wireless LAN Antenna

<Only for model with wireless LAN>

→ Reference Manual "Wireless LAN"

F : Power Switch

→ page 12

Power Indicator

- Off: Power off/Hibernation
- Green: Power on
- Blinking green: Sleep

G : Wireless Switch

Switch the wireless devices to on (right side) or to off (left side).

<Only for model with wireless LAN/wireless WAN/Bluetooth>

→ Reference Manual "Disabling/Enabling Wireless Communication"

H : LED Indicator

: SD/SDHC Memory Card status

: Caps lock

: Numeric key (NumLk)

: Scroll lock (ScrLk)

: Hard disk drive status

ECO : Economy Mode (ECO) status

→ Reference Manual "Battery Power"

: Battery status

→ Reference Manual "Battery Power"

I : LCD/Touchscreen

→ Reference Manual "Using the Touchscreen"

J : Security Lock

You can connect a Kensington cable. Refer to the instruction manual of the cable. The security lock and cable is a theft prevention device. Matsushita Electric Industrial Co., Ltd. will bear no responsibility in the event of theft.

K : Modem Port

- Be sure to use the included modem telephone cable, and insert the ferrite core side of modem telephone cable into the modem port on the computer.
- Do not move/remove the ferrite core of modem telephone cable.

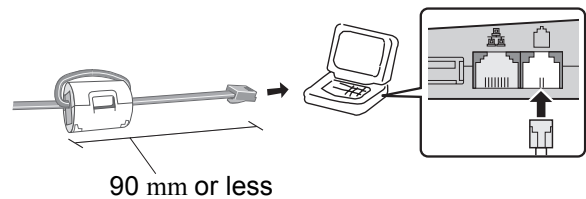

→ Reference Manual "Modem"

L : LAN Port

If the Mini Port Replicator is connected to the computer, connect the LAN cable to the LAN port on the Mini Port Replicator. You cannot use the LAN port on the computer.

→ Reference Manual "LAN"

M : USB Ports

→ Reference Manual "USB Devices"

Description of Parts

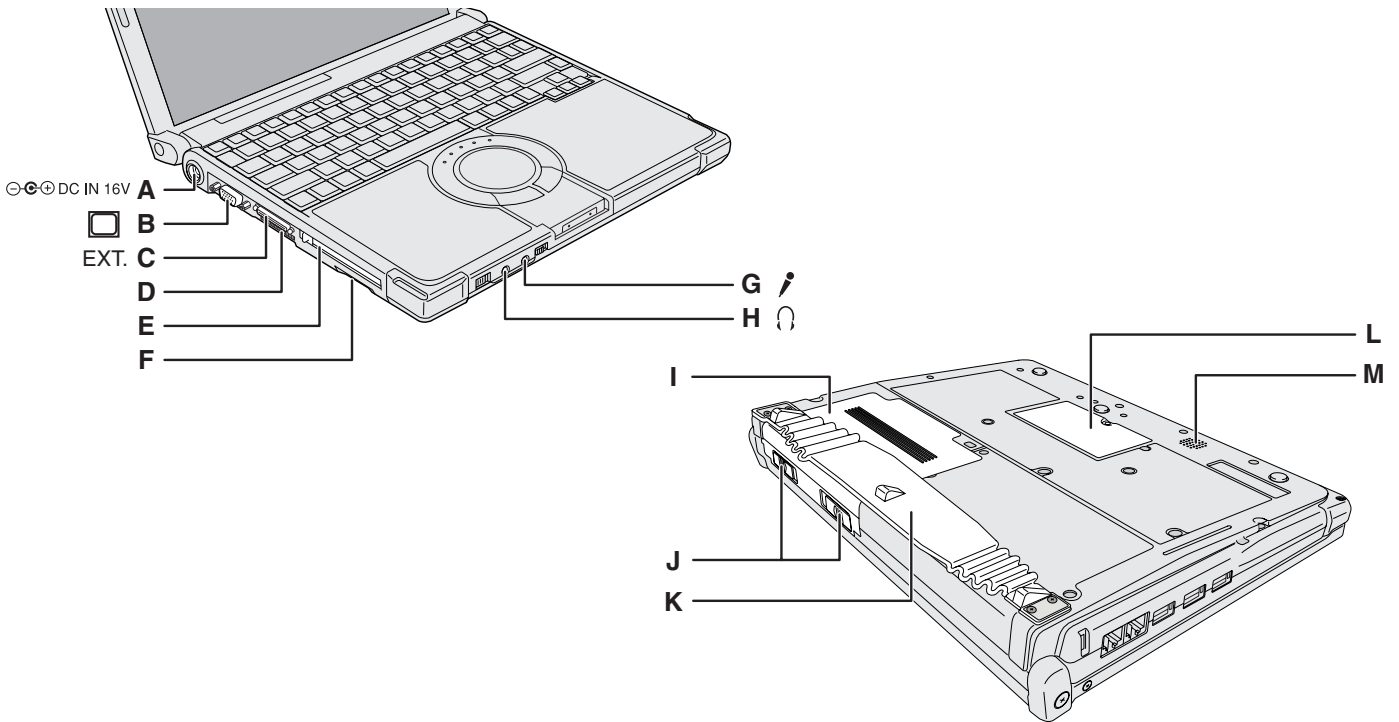

A : DC-IN Jack

B : External Display Port

If the Mini Port Replicator is connected to the computer, connect the external display to the external display port on the Mini Port Replicator. You cannot use the external display port on the computer.

→ *Reference Manual* "External Display"

C : Mini Port Replicator Connector

Connect the Mini Port Replicator (optional).

→ *Reference Manual* "Mini Port Replicator"

D : Ventilation Hole

E : PC Card Slot

→ *Reference Manual* "PC Cards"

F : SD Memory Card Slot

→ *Reference Manual* "SD/SDHC Memory Card"

G : Microphone Jack

A condenser microphone can be used. If other types of microphones are used, audio input may not be possible, or malfunctions may occur.

H : Headphone Jack

You can connect headphones or amplified speakers. When they are connected, audio from the internal speakers is not heard.

I : Battery Pack

→ page 11

→ *Reference Manual* "Battery Power"

J : Battery Latches

→ page 11

K : Hand Strap

→ page 16

L : RAM Module Slot

→ page 22

M : Speaker

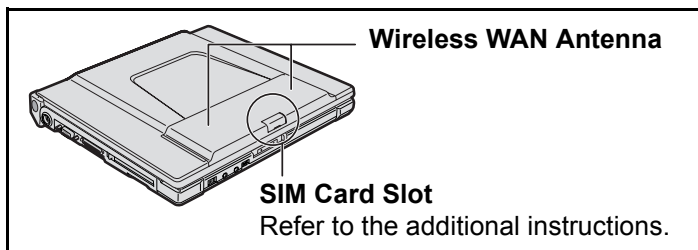

First-time Operation

■ Preparation

① Check and identify the supplied accessories.

If you do not find the described accessories, contact your technical support office.

- AC Adaptor 1
- AC Cord 1
- Battery Pack . . . 1
- Modem Telephone Cable 1

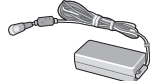

Model No: CF-AA1633A

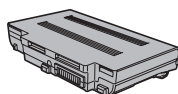

Model No: CF-VZSU51W



- Soft Cloth 1
- Stylus 1

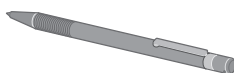
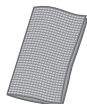

→ Reference Manual "Using the Touchscreen"

- Operating Instructions (This book) . . 1
- Windows® Book 1
- <For localized OS model>
- Product Recovery DVD-ROM Windows Vista® Business 1
- <For MUI OS model>
- Product Recovery DVD-ROM Windows Vista® Business 2

② Read the LIMITED USE LICENSE AGREEMENT before breaking the seal on the computer's packaging (→ page 34).

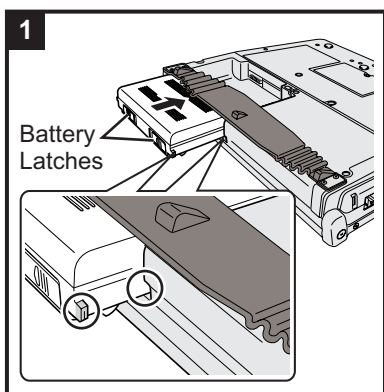

1 Insert the battery pack.

Slide the battery pack in parallel with the arrow direction and attach it so that the left and right projections on the new battery pack match the dents of the computer.

In case that the projection does not match the dents of the computer, detach the battery pack once, then slide it while pushing it lightly to avoid floating.

- To remove
Slide both the left and right latches to the unlocked position, and push out the battery pack in parallel with the computer.

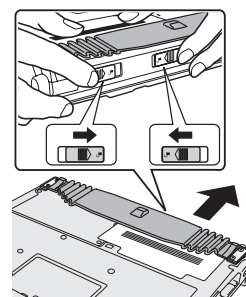

CAUTION

- Make sure the latches are securely locked. Otherwise the battery pack may fall when you carry the computer.
- Do not touch the terminals of the battery pack and the computer. Doing so can make the terminals dirty or damaged, and may cause malfunction of the battery pack and the computer.

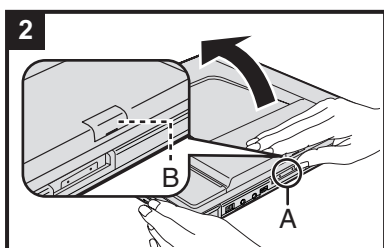

2 Open the display.

Hold the side of the computer with either of your hands and then hold and lift the A part to open the display.

- Be careful not to press the SIM card slot cover (B) by mistake.

CAUTION

- Do not open the display wider than necessary (140° or more), and do not apply excessive pressure to the LCD. Do not open or close the computer holding the edge of the LCD segment.

First-time Operation

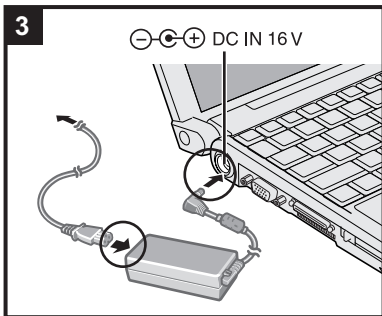

3 Connect your computer to a power outlet.



The battery charging starts automatically.

CAUTION

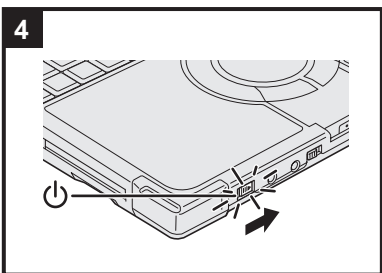
- **Do not disconnect the AC adaptor and do not switch the wireless switch to on until the first-time operation procedure is completed.**
- When using the computer for the first time, do not connect any peripheral device except the battery pack and AC adaptor.
- **Handling the AC adaptor**
 - Problems such as sudden voltage drops may arise during periods of thunder and lightning. Since this could adversely affect your computer, an uninterruptible power source (UPS) is highly recommended unless running from the battery pack alone.



4 Turn on the computer.

Slide and hold the power switch  for approximately one second until the power indicator  lights.

It takes approximately 5 minutes until the Windows setup screen appears. Do not touch the keys and touch pad until it appears.

CAUTION

- Do not slide the power switch repeatedly.
- The computer will forcibly be turned off if you slide and hold the power switch for four seconds or longer.
- Once you turn off the computer, wait for ten seconds or more before you turn on the computer again.
- Do not perform the following operation until the hard disk drive indicator  turns off.
 - Connecting or disconnecting the AC adaptor
 - Sliding the power switch
 - Touching the keyboard, touch pad or touchscreen
 - Closing the display
- Do not change the Setup Utility until completing step 5. If you do so, Windows setup may not operate properly.

5 <For MUI OS model> Select OS language.

- ① **Select OS language on “Select Language” screen and click [OK].**

The language setting will start by clicking [OK] on the confirmation screen. You can return to the “Select Language” screen by clicking [Cancel]. The language setting will be complete in approximately 20 minutes.
- ② **Click [OK] on the termination screen.**

The power of the computer goes off by clicking [OK].
- ③ **Turn on the computer.**
 - Carefully choose your language because you cannot change it later. If you set a wrong language, you need to reinstall Windows (→ page 26).

6 Setup Windows.

Follow the on-screen instructions.

- After turning on the computer, “Please wait a moment while Windows prepares to start for the first time” appears, and then a small circle circulates on the screen. This will take a few minutes.
- During setup of Windows, use the touch pad to move the cursor and to click an item.
- Do not change the settings on the screen where you select a country or region. You can set a country, region or keyboard layout in [Clock, Language, and Region] of [Control Panel] after the Windows setup is complete.
- Setup of Windows will take approximately 20 minutes.

Go to the next step, confirming each message on the display.

<For MUI OS model>

- If you select “Bulgarian” “Croatian” “Estonian” “Latvian” “Lithuanian” “Romanian” “Serbian Latin” “Slovak” “Slovenian” “Thai” “Ukrainian” or “Chinese-Hong-Kong” at the language selection in step 5, the language selection screen appears at the setup. Then, set the language selected at the language selection in step 5.
- For some languages, the characters on the key and inputted character may not match. Set the keyboard properly after the setup is complete. Then set the password.

CAUTION

- You cannot choose the following words for user name and password: CON, PRN, AUX, CLOCK\$, NUL, COM1 to COM9, LPT1 to LPT9.
- You can change the user name, password, image and security setting after setup of Windows.

7 <For MUI OS model> Install Adobe Reader.

NOTE

Install Adobe Reader to read the Important Tips and the Reference Manual.

Click  (Start) and input the following in [Start Search], then press **Enter**.

Arabic: [c:\util\reader\ar\setup.exe]
 Bulgarian: [c:\util\reader\bg\setup.exe]
 Chinese (Simplified): [c:\util\reader\sc\setup.exe]
 Chinese (Traditional): [c:\util\reader\tc\setup.exe]
 Croatian: [c:\util\reader\yx\setup.exe]
 Czech: [c:\util\reader\cs\setup.exe]
 Danish: [c:\util\reader\da\setup.exe]
 Dutch: [c:\util\reader\nl\setup.exe]
 English: [c:\util\reader\m\setup.exe]
 Estonian: [c:\util\reader\et\setup.exe]
 Finnish: [c:\util\reader\fi\setup.exe]
 French: [c:\util\reader\fr\setup.exe]
 German: [c:\util\reader\g\setup.exe]
 Greek: [c:\util\reader\el\setup.exe]
 Hebrew: [c:\util\reader\he\setup.exe]
 Hungarian: [c:\util\reader\hu\setup.exe]
 Italian: [c:\util\reader\it\setup.exe]
 Japanese: [c:\util\reader\ja\setup.exe]
 Korean: [c:\util\reader\ko\setup.exe]
 Latvian: [c:\util\reader\lv\setup.exe]
 Lithuanian: [c:\util\reader\lt\setup.exe]
 Norwegian: [c:\util\reader\no\setup.exe]
 Polish: [c:\util\reader\pl\setup.exe]
 Portuguese: [c:\util\reader\pt\setup.exe]
 Romanian: [c:\util\reader\ro\setup.exe]
 Russian: [c:\util\reader\ru\setup.exe]
 Slovak: [c:\util\reader\sk\setup.exe]
 Slovenian: [c:\util\reader\sl\setup.exe]
 Spanish: [c:\util\reader\es\setup.exe]
 Swedish: [c:\util\reader\s\setup.exe]
 Turkish: [c:\util\reader\tr\setup.exe]

8 Perform the touchscreen calibration.

- ① Click  (Start) - [Control Panel] - [Additional Options] - [Tablet Calibration].
- ② If [User Account Control] is displayed, click [Continue], or input password and click [OK].
- ③ Touch each “+” using the stylus.
“+” is displayed in order at 9 locations.

First-time Operation

NOTE

● PC Information Viewer

This computer periodically records the management information including the hard disk information such as number of hours powered-on, number of times powered-on, internal temperature, replacement sector. The maximum data volume for each record is 750 bytes. These information are only used for estimating the cause when the hard disk goes down by any possibility. They are never sent to outside via network nor used for any other purpose except for the purpose described the above.

To disable the function, add the check mark for [Disable the automatic save function for management information history] in [Hard Disk Status] of PC Information Viewer, and click [OK].

When you disable the function, information on how to use the hard disk is not displayed.

(→  Reference Manual “Check the Computer’s Usage Status” and  Hard Disk Handling)

● To conserve power, the following power saving methods are set at the time of purchase. (When AC adaptor is connected)

- The screen automatically turns off after 15 minutes of inactivity.
- The computer automatically enters sleep^{*1} after 20 minutes of inactivity.

^{*1} Refer to  Reference Manual “Sleep or Hibernation Functions” about resuming from sleep.

● Power consumption in each mode is as follows. (When AC adaptor is connected)

- When the screen is off Approx. 10 W
- In sleep Approx. 1.9 W
- The battery pack is fully charged (or not being charged) and the computer is off Approx. 0.9 W

● Note that the computer consumes electricity even when the computer power is off. If the battery pack is fully charged, the battery will be fully discharged in the following period of time:

When using the supplied battery pack (CF-VZSU51W)	When using the optional battery pack (CF-VZSU52W)
<ul style="list-style-type: none">• When power is off: Approx. 1.5 months• In sleep: Approx. 2 days^{*2}• In hibernation: Approx. 3 days^{*2}	<ul style="list-style-type: none">• When power is off: Approx. 0.7 months• In sleep: Approx. 1 days^{*2}• In hibernation: Approx. 1.5 days^{*2}

^{*2} If “Wake Up from wired LAN” is disabled, the period of time will become slightly longer.
If “Wake Up from wireless LAN” is enabled, the period of time will become shorter.

■ When Starting Up/Shutting Down

- Do not do the following
 - Connecting or disconnecting the AC adaptor
 - Sliding the power switch
 - Touching the keyboard, touch pad, touchscreen or external mouse
 - Closing the display

■ To change the partition structure

You can shrink a part of an existing partition to create unallocated disk space, from which you can create a new partition. This computer has a single partition in the default setting.

- ① Click  (Start) and right-click [Computer], then click [Manage].
 - A standard user needs to enter an administrator password.
- ② Click [Disk Management].
- ③ Right-click the partition for Windows (“c” drive in the default setting), and click [Shrink Volume].
 - The partition size depends on the computer specifications.
- ④ Input the size in [Enter the amount of space to shrink in MB] and click [Shrink].
 - You cannot input a larger number than the displayed size.
- ⑤ Right-click [Unallocated] (the shrunk space in the step ④) and click [New Simple Volume].
- ⑥ Follow the on-screen instructions to make the settings, and click [Finish].
Wait until formatting is completed.

NOTE

- You can create an additional partition using remaining unallocated space or newly creating unallocated space.
- To delete a partition, right-click the partition and click [Delete Volume] in the step ③.

Regarding Windows Vista

You can select the Classic view of Control Panel or the Classic Start menu. You can also change the way a user logs on or off. This manual explains using the Windows Vista default setting (not Classic view or Classic Start menu etc.).

● User Account Control

User Account Control is a new security component of Windows Vista to stop unauthorized changes to your computer. The User Account Control message will pop up every time you try making an important change to your computer.

● About Windows® Anytime Upgrade

• To upgrade the operating system to Windows Vista® Ultimate, you must purchase the license key at the Microsoft Windows® Anytime Upgrade web site and receive the Windows® Anytime Upgrade disc from Microsoft Corporation.

- ① In an Internet-connected environment, click  (Start) - [All Programs] - [Extras and Upgrades] - [Windows Anytime Upgrade].
- ② Click [Upgrade to Windows Vista Ultimate].
- ③ After carefully reading the on-screen instructions, click [Begin upgrade process].
- ④ Purchase the license key at the Microsoft Windows® Anytime Upgrade web site and receive the Windows® Anytime Upgrade disc from Microsoft Corporation.

• When you have upgraded the preinstalled “Windows Vista® Business” to “Windows Vista® Ultimate”, setup the chip set device in the following procedure.

- ① Click  (Start) and input [c:\util\drivers\intel\inf\setup.exe] in [Start Search], and press **Enter**.
 - A standard user needs to enter an administrator password.
 - Follow the on-screen instructions and setup the chip set device.

● If the computer becomes warm during usage

• Check the usage environment

- Avoid using the computer on a highly heat retentive surfaces (e.g., rubber pads). If possible, use the computer on surfaces that can dissipate heat, such as a steel desk.
- Do not use a keyboard cover, as this prevents heat dissipation.
- Always keep the display open in sleep.

• Check the following

- If the computer becomes warm while the screen saver is displayed, set the screen saver to [Windows Logo]. Screen savers that use 3-D images or other complex images increase the CPU utilization rate.
- If you are not using a wireless LAN, turn the wireless LAN off.
- Use recommended RAM module products. Non-recommended RAM modules may not operate properly, and may cause damage to your computer.

• Double-click  on the desktop and click [Power Saving Level : High]

Follow the on-screen instructions.

→  *Reference Manual* “Computing on the Road”

• Double-click  on the desktop and click [High speed], then click [OK].

- When you set [High speed], rotation of the cooling fan speeds up and the computer can be cooled down. Note that the battery operating time will be shorter.
- When you do not frequently use CPU or the rotation noise of the fan bothers you, set [Standard] or [Low speed] as necessary.

● Windows Sidebar

The Windows Sidebar does not appear in the default setting. To display it, click  (Start) - [All Programs] - [Accessories] - [Windows Sidebar].

To always display the sidebar:



- ① Right-click the sidebar icon  on the notification area, and click [Properties].
- ② Add a check mark for [Start Sidebar when Windows starts] and click [OK].

● Sound and Video

• When playing AVI files

When the computer is stressed with lots of application software running or when you are using the computer in hot location, the sound and images in AVI files may be cut during playback.



The following operations may improve the situation.

- Click  or  on the notification area, and click [High performance].
(When using the computer in hot location, lower the temperature in the environment to set [High performance]. Setting [High performance] in hot location does not improve the situation.)



First-time Operation

- When you play back AVI files with the Windows Media Player full screen, the audio and images may not match with each other. In this case, do either of the following for playback.
 - Play back with the Windows Media Player on the window display.
- When you play back motion image files such as DVD-Video, the following troubles may occur.
 - When using Windows Media Player, images are not played back smoothly.
- Sound (e.g. MP3, WMA) and video (e.g. MPG, WMV) recorded in PC Cards and SD Memory Cards may be interrupted during playback. If this happens, copy them to the hard disk drive and play back.
- Depending on the processing status on Windows, sound may be interrupted at Windows startup. You can mute the sound at startup.
 - ① Right-click the desktop and click [Personalize] - [Sounds].
 - ② Remove the check mark from [Play Windows Startup sound], and click [OK].

- **When Using Wireless LAN** <Only for model with wireless LAN>

- If you cannot communicate with the access point or if the access point is not detected, right-click  on the notification area and click [Connect to a network], and then click  in the [Connect to a network] screen.
- If you use the stealth type wireless LAN access point which restricts automatic detection of the wireless LAN access point, take the following procedure.

If you do not perform the procedure below, you may not be able to access the wireless LAN access point automatically or the wireless LAN access point may not be displayed on the [Connect to a network] screen.

- ① Click ,  or  on the notification area, click [Network and Sharing Center] - [Set up a connection or network] - [Manually connect to a wireless network] and click [Next].
- ② Input necessary information and add check marks for [Start this connection automatically] and [Connect even if the network is not broadcasting] and click [Next].

- **When the computer suddenly enters hibernation**

When you successively operate application software with CPU load in hot location, the internal temperature control function may work and the computer may enter hibernation.

If this occurs, wait for a while (approx. 5 minutes) before you turn on the computer.

- **Windows Update**

You can update to the latest patches and service packs for Windows with the following menus.

 (Start) - [All Programs] - [Windows Update]

Do not apply drivers even if a message to update a driver appears. If a driver update is required, contact your technical support office.

Using the Hand Strap

The hand strap is convenient for computing while standing.
To carry the computer, put your hand between the computer and the hand strap to prevent it from falling, and firmly hold the computer when using it.

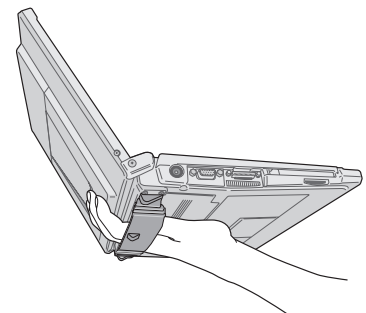

On-screen Manual

You can access the following manuals on the computer screen after completing the “First-time Operation”. When you access the on-screen manual for the first time, the License Agreement of the Adobe Reader may be displayed. Read it carefully and select [Accept] to proceed.

■ Reference Manual

The Reference Manual contains the practical information to help you fully enjoy the computer’s performance.

To access the Reference Manual:

Double-click  on the desktop.

Contents		
● Read Me First	● PC Cards	● Setup Utility
● Using the Touch Pad	● SD/SDHC Memory Card	● Loupe Utility
● Using the Touchscreen	● Mini Port Replicator	● DMI Viewer
● Display Rotation	● External Display	● Troubleshooting (Advanced)
● Key Combinations	● USB Devices	● Check the Computer’s Usage Status
● Battery Power	● Modem	● PC Information Popup
● Customizing the Power Setting	● LAN	● Protecting Your Computer from Viruses
● Computing on the Road	● Disabling/Enabling Wireless Communication	● Technical Information
● Sleep or Hibernation Functions	● Wireless LAN	
● Security Measures		

NOTE

- Windows-related files, which is mentioned in “Technical Information” on Reference Manual, are placed in folders below.

English

c:\windows\support\EN\migwiz,
c:\windows\support\EN\tools

Arabic

c:\windows\support\AR\migwiz,
c:\windows\support\AR\tools

Chinese -Simplified

c:\windows\support\XT\migwiz,
c:\windows\support\XT\tools

Chinese -Traditional

c:\windows\support\ZH\migwiz,
c:\windows\support\ZH\tools

Chinese -HongKong

c:\windows\support\HK\migwiz,
c:\windows\support\HK\tools

Dutch

c:\windows\support\NL\migwiz,
c:\windows\support\NL\tools

French

c:\windows\support\FR\migwiz,
c:\windows\support\FR\tools

German

c:\windows\support\DE\migwiz,
c:\windows\support\DE\tools

Hebrew

c:\windows\support\IW\migwiz,
c:\windows\support\IW\tools

Italian

c:\windows\support\IT\migwiz,
c:\windows\support\IT\tools

Japanese

c:\windows\support\JA\migwiz,
c:\windows\support\JA\tools

Korean

c:\windows\support\KO\migwiz,
c:\windows\support\KO\tools

Portuguese (Brazilian)

c:\windows\support\XC\migwiz,
c:\windows\support\XC\tools

Spanish

c:\windows\support\ES\migwiz,
c:\windows\support\ES\tools

Swedish

c:\windows\support\SV\migwiz,
c:\windows\support\SV\tools

Czech

c:\windows\support\CS\migwiz,
c:\windows\support\CS\tools

Danish

c:\windows\support\DA\migwiz,
c:\windows\support\DA\tools

Finnish

c:\windows\support\FI\migwiz,
c:\windows\support\FI\tools

Norwegian

c:\windows\support\NO\migwiz,
c:\windows\support\NO\tools

Russian

c:\windows\support\RU\migwiz,
c:\windows\support\RU\tools

Greek

c:\windows\support\EL\migwiz,
c:\windows\support\EL\tools

Hungarian

c:\windows\support\HU\migwiz,
c:\windows\support\HU\tools

Polish

c:\windows\support\PL\migwiz,
c:\windows\support\PL\tools

Portuguese

c:\windows\support\PT\migwiz,
c:\windows\support\PT\tools

Turkish

c:\windows\support\TR\migwiz,
c:\windows\support\TR\tools

Bulgarian

c:\windows\support\BG\migwiz,
c:\windows\support\BG\tools

Croatian

c:\windows\support\YX\migwiz,
c:\windows\support\YX\tools

Estonian

c:\windows\support\ET\migwiz,
c:\windows\support\ET\tools

Latvian

c:\windows\support\LV\migwiz,
c:\windows\support\LV\tools

Lithuanian

c:\windows\support\LT\migwiz,
c:\windows\support\LT\tools

Romanian

c:\windows\support\RO\migwiz,
c:\windows\support\RO\tools

Slovak

c:\windows\support\SK\migwiz,
c:\windows\support\SK\tools

Slovenian

c:\windows\support\SL\migwiz,
c:\windows\support\SL\tools

Thai

c:\windows\support\TH\migwiz,
c:\windows\support\TH\tools

Serbian

c:\windows\support\SR\migwiz,
c:\windows\support\SR\tools

Ukrainian

c:\windows\support\UK\migwiz,
c:\windows\support\UK\tools

■ Important Tips

The Important Tips will provide you with the helpful information about the battery. Read to use the battery pack in the optimum condition to obtain longer operation time.

To access the Important Tips:

Double-click  on the desktop.

- Alternatively click  (Start) - [All Programs] - [Panasonic] - [On-Line Manuals] - [Important Tips].

■ Hard Disk Handling

The Hard Disk Handling will provide you with the helpful information on how to use the hard disk.

To access the Hard Disk Handling:

Click  (Start) - [All Programs] - [Panasonic] - [On-Line Manuals] - [Hard Disk Handling].

■ Supplementary Instructions of Bluetooth <Only for model with Bluetooth>

The Supplementary Instructions will provide you with the helpful information about the Bluetooth.

To access the Supplementary Instructions of Bluetooth:

Click  (Start) - [All Programs] - [Panasonic] - [On-Line Manuals] - [Bluetooth Manual].

NOTE

- When Adobe Reader update notice is displayed, we recommend you follow the on-screen procedure to update. See <http://www.adobe.com/> for the latest version of Adobe Reader.

Handling and Maintenance

Operation Environment

- Place the computer on a flat stable surface. Do not place the computer upright. If the computer is exposed to an extremely strong impact, it may become inoperable.
 - Temperature: Operation: 5 °C to 35 °C
Storage: -20°C to 60 °C
 - Humidity: Operation: 30% to 80% RH (No condensation)
Storage: 30% to 90% RH (No condensation)
- Even within the above temperature/humidity ranges, using for a long time in an extreme environment will result in the product deterioration and will shorten the product life.
- Do not place the computer in the following areas, otherwise the computer may be damaged.
 - Near electronic equipment. Image distortion or noise may occur.
 - Near magnets or in magnetic fields.
 - In extremely high or low temperature.
 - As the computer can become hot during operation, keep it away from items that are sensitive to heat.

Handling Cautions

This computer is designed to minimize shock to parts such as the hard disk drive, but no warranty is provided against any trouble caused by shock. Be extremely careful when handling the computer.

- When carrying the computer:
 - Turn off the computer.
 - Remove all external devices, cables, cards and other protruding things.
 - Do not drop or hit the computer against solid objects.
 - Do not leave the display open.
 - Do not grip the display part.
- When you board an airplane, take the computer with you and never put it in your checked luggage. When using the computer on airplane, follow the airline's instructions.
- When carrying a spare battery, put it in a plastic bag to protect its terminals.
- This computer contains a magnet and magnetic products at the locations circled in the illustration at right. Avoid leaving metallic object or magnetic media in contact with these areas.
- The touch pad is designed to be used with a finger tip. Do not place any object on its surface and do not press down strongly with sharp-pointed or hard objects that may leave marks (e.g., nails, pencils and ball point pens).
- Avoid any harmful substances such as oil from getting into the touch pad. The cursor may not work correctly.
- If the computer is being carried in a soft bag with the battery pack removed, avoid undue pressure on the body of the computer in a crowded place, etc., as this may result in damage to the LCD.

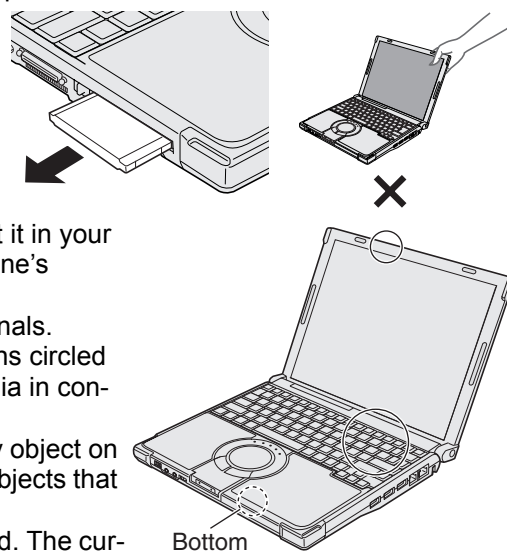

■ When using peripheral devices

Follow these instructions and the Reference Manual to avoid any damage to the devices. Carefully read the instruction manuals of the peripheral devices.

- Use the peripheral devices conforming to the computer's specifications.
- Connect to the connectors in the correct direction.
- If it is hard to insert, do not try forcibly but check the connector's shape, direction, alignment of pins, etc.
- If screws are included, fasten them securely.

■ Preventing your computer from unauthorized use via wireless LAN/wireless WAN/Bluetooth

<Only for model with wireless LAN/wireless WAN/Bluetooth>

- Before using wireless LAN/wireless WAN/Bluetooth, make the appropriate security settings such as data encryption.

■ Computrace® Software

Computrace® software tracks your stolen computer.

Perform the following steps before installing Computrace® software.

- Computrace® software is not included or installed in this computer.

Handling and Maintenance

CAUTION

- You will be unable to set [Computrace (R) BIOS Module] to [Disable] once you have set to [Enable]. Do not change the setting when not used.
 - Even if you have set [Computrace (R) BIOS Module] to [Enable], this setting may return to [Disable] after repairs to the motherboard, etc. have been made.

NOTE

- Consult Absolute Software Corp. before disposal.
- Refer to the following URL for Computrace[®] software for installation and available service regions. Note that this service is only available in certain regions.
<http://www.absolute.com>

- 1 Turn on or restart the computer, and press F2 while [Panasonic] boot screen is displayed.**

The Setup Utility starts up.

 - If the password is requested, enter the Supervisor Password.
- 2 Select the [Security] menu, then select [Computrace (R) Sub-Menu] and press Enter.**
- 3 Select [Computrace (R) BIOS Module], and set to [Enable].**
- 4 At the confirmation message, select [Execute] and press Enter.**
- 5 At the reconfirmation message, select [Execute] and press Enter.**
- 6 Press F10.**

At the confirmation message, select [Yes] and press Enter.
The computer restarts.

Maintenance

To clean display (LCD)

Use the soft cloth included with the computer (For more information, refer to “Suggestions About Cleaning the LCD Surface” that comes with the soft cloth.)

Cleaning the display while the power is on may cause the computer to malfunction. Also, dirt on the touchscreen is easier to see when the computer is powered off, and so is easier to clean.

To clean the touch pad

Wipe lightly with a gauze or other dry, soft cloth.

To clean areas other than the LCD panel and touch pad

Wet a soft cloth with water or a diluted kitchen cleanser (neutral), wring the cloth out thoroughly, and wipe the dirty area gently. Using a detergent other than a neutral kitchen cleanser (e.g., a weak alkali cleanser) may adversely affect painted surfaces.

CAUTION

- Do not use benzene, thinner, or rubbing alcohol since it may adversely affect the surface causing discoloration, etc. Do not use commercially-available household cleaners and cosmetics, as they may contain components harmful to the surface.
- Do not apply water or detergent directly to the computer, since liquid may enter inside of the computer and cause malfunction or damage.

If You Spill Water on the Keyboard

Note that repairs resulting from liquids being spilled on the computer are not free of charge, and not covered by warranty.

The keyboard on this computer incorporate a drain system (a moisture protection mechanism) that minimizes the amount of liquid reaching the inside of the computer even if water is spilled on the keyboard. Any water that comes in contact with the keyboard is drained off through holes in the bottom of the computer, so that virtually no water is left inside the computer. However, this is not a guarantee against damage to the hard disk or other internal parts, or against the loss or deletion of data.

The drain system is incorporated into only the keyboard. It does not apply to any other components.

- If you spill water or any other liquid on the keyboard, even a small amount, be sure to perform the following steps. Failure to perform these steps may result in damage to the computer. The drain system will not provide complete protection against water entering the computer.

1 Immediately turn off the computer, and remove the AC adaptor.

2 Wipe any water droplets off of the top of the keyboard using a soft, dry cloth.



3 Slowly lift up the computer, keeping it level, and wipe any water coming out of the holes on the bottom using a soft, dry cloth.

If the computer is tilted during this step, liquid may seep inside the computer resulting in damage.

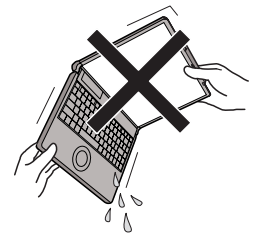

4 Keeping the computer level, move the computer to a dry place.

If the computer is placed back on the wet surface, water may seep inside the computer from the bottom.

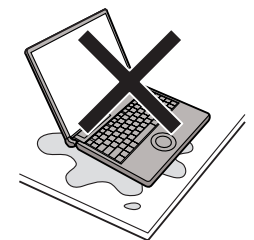
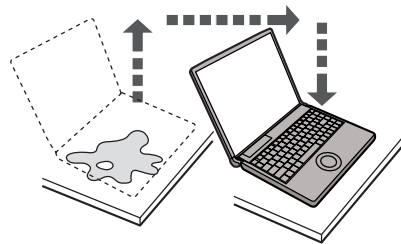

5 Remove the battery pack.

6 Be sure to contact your technical support office to have the computer checked for any malfunctions.

Expanding Memory

Use RAM modules that comply with the specifications below. Using any other module may cause malfunction or result in computer failure.

RAM module specifications:

DDR2 SDRAM, 200 pins, SO-DIMM, 1.8 V, PC2-4200

CAUTION

- Use recommended RAM module products. Do not use non-recommended RAM modules. Non-recommended RAM modules may not operate properly, and may cause damage to your computer. Some non-recommended RAM modules may overheat, causing the cover to warp. Refer to various sources for recommended RAM module.
- RAM modules are extremely sensitive to static electricity. There are cases where static electricity generated by the human body has adversely affected such RAM modules. When inserting or removing a RAM module, do not touch the terminals or internal components, insert objects other than the module, or allow foreign particles to enter. Doing so has been known to cause damage, fire or electric shock.
- Matsushita Electric Industrial Co., Ltd. will bear no responsibility whatsoever for failures or damage caused by the use of non-recommended RAM modules, or by incorrect installation or removal of such RAM modules. Before installing a RAM module, confirm the product type and the correct installation method.

Preparation

- ① Turn off your computer.
 - Do not use the sleep or hibernation.
- ② Disconnect the AC adaptor and remove the battery pack.
- ③ Remove the screw (A) and the cover on the bottom of the computer.
 - Use the appropriate screw driver so as not to strip the thread of screw.

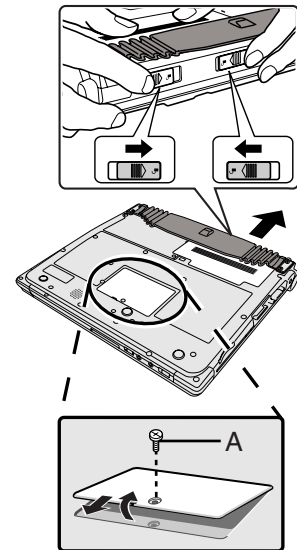

Inserting the RAM Module

- 1 Place the RAM module lightly in parallel with the RAM module slot so that the notch (B) of the RAM module and the protrusion (C) of the RAM module slot is in the same direction.
 - The gold terminals are visible at this point.
 - RAM module is at an angle of 20° - 30° with the horizontal line.

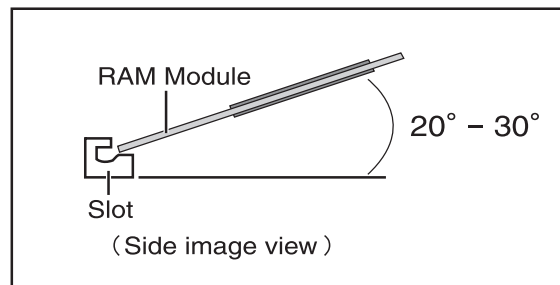
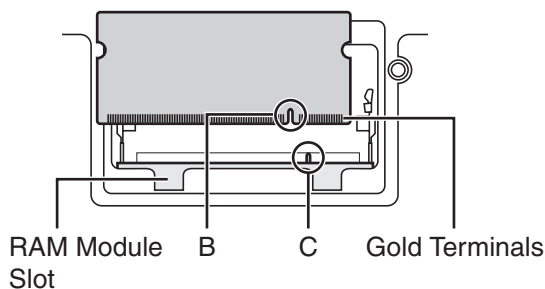

2 Insert the RAM module parallel to the slot firmly until the gold terminals are invisible.

- If it is hard to insert the RAM module, do not try forcibly but check the module's direction.

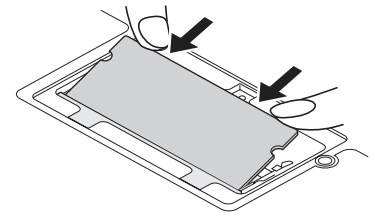

3 Press the RAM module down until the right and left hooks (D) lock into place.

- When pressing down the module, the right and left hooks will open slightly and will return after locking.
- If it is hard to press down the RAM module, do not try forcibly but check the module's direction.

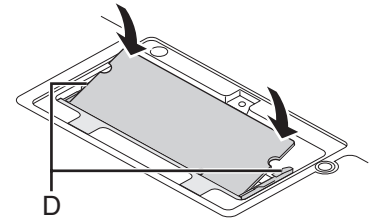

4 Set the cover and battery pack back.

NOTE

- If the RAM module is recognized correctly, the total size of this computer's memory and RAM module memory is displayed on the [Information] menu of the Setup Utility.
If the RAM module is not recognized, turn off the computer and insert it again.

Removing the RAM Module

1 Carefully open the left and right hooks (E).

The RAM module will be raised.

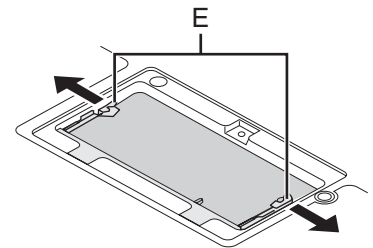

2 Carefully remove the RAM module from the slot.

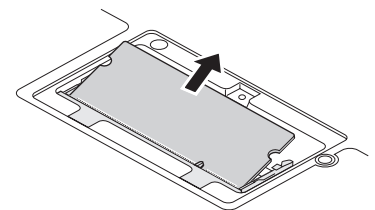

3 Set the cover and battery pack back.

Hard Disk Backup/Restore Function

[Backup and Restore Center] and [System Recovery Options] allow you create a backup of the entire hard disk data, which can be used to recover from hardware failure.

Matsushita Electric Industrial Co., Ltd. will bear no responsibility for any damage suffered (including loss of data) as a result of the use of this function.

Creating a backup of the hard disk data

To create a backup of the entire hard disk to another storage media (e.g., external hard disk): Use [Back up computer]. To create a backup of a file or a folder: Use [Back up files].

For further information, click  (Start) - [Control Panel] - [Back up your computer].

NOTE

- Connect the AC adaptor and do not remove it until backup is complete.

Restoring the hard disk data

NOTE

- This function does not work when you turn on the computer for the first time or just after you reinstall Windows. Start and shut down Windows Vista, and then you can use the function.
- When you forget the administrator account password or you need to restore the recovery partition, use Product Recovery DVD-ROM.
- Connect the AC adaptor and do not remove it until restoration is complete.

1 Turn on the computer, and press **F2** while [Panasonic] boot screen is displayed.

The Setup Utility starts up.

- If the password is requested, enter the Supervisor Password.

2 Press **F9**.

At the confirmation message, select [Yes] and press **Enter**.

3 Select the [Exit] menu.

4 Select [Repair Your Computer] and press **Enter**.

5 Click [Next] and click [Next].

6 Select user name and input password, then click [OK].

7 Click [Windows Complete PC Restore] and follow the on-screen instructions.

If you cannot proceed the above operation, restore the hard disk using Product Recovery DVD-ROM.

NOTE

You can restore the hard disk following the procedure below as well.

- On [Advanced Boot Options] screen
 - ① Perform the above procedure, steps 1 - 2.
 - ② Press **F10**.
At the confirmation message, select [Yes] and press **Enter**.
The computer will restart.
 - ③ When [Panasonic] boot screen disappears, press and hold **F8**.
If [Advanced Boot Options] screen is not displayed, the recovery partition may be damaged. In this case, restore the hard disk using Product Recovery DVD-ROM.
 - ④ Select [Repair Your Computer] and press **Enter**.
 - ⑤ Follow the on-screen instructions.
- How to use Product Recovery DVD-ROM
 - ① Perform the steps 1 to 6 of "Reinstalling Software" (→ page 26).
 - ② Click [Run "System Recovery Options".] and click [Next].
 - ③ Follow the on-screen instructions.

Hard Disk Data Erase Utility

When disposing the computer or transferring the ownership, erase all hard disk data in order to avoid data leakage. Even if you erase the data or initialize the hard disk using normal Windows commands, the data can be read with some special software. Use the hard disk data erase utility to erase the data completely. Note that transferring of the ownership without uninstalling the commercial software will be a violation of the software's license agreement.

The hard disk data erase utility erases data using an overwriting method, but there is a possibility that due to malfunctions or other operational errors, data may not be completely erased. There are also specialized devices that may be able to read data that has been erased using this method. If you need to erase highly confidential data, we recommend that you contact a company that specializes in this process. Matsushita Electric Industrial Co., Ltd. will bear no responsibility for losses or damages suffered as a result of the use of this utility.

NOTE

- This utility cannot erase data for specific partitions. The entire hard disk data including the data of the recovery partition will be erased.
- It will take 2 to 5 hours to erase the data. (Erasing time varies depending on the capacity of the hard disk.)

Preparation

- Prepare the Product Recovery DVD-ROM (included).
- Prepare the Panasonic CD/DVD drive (optional): CF-VDRRT1M, CF-VDRRT2W, CF-VDRRT3W, CF-VDRRT3U.
- Remove all peripherals (except for the CD/DVD drive).
- Connect the AC adaptor and do not remove it until hard disk data erase is complete.

1 Perform the steps 1 to 6 of “Reinstalling Software” (→ page 26).

- In step 3, you do not have to write down all of the contents of the Setup Utility.
- If [Enter Password] is displayed during the following procedures, input the Supervisor Password or the User Password.

2 Click [Erase the whole data on the Hard Disk for security] and click [Next].

3 At the confirmation message, click [YES].

4 Click [Continue].

5 Click [Continue] again.

6 Click [YES].

Erasing the hard disk data starts.

7 After erasing is completed, remove the Product Recovery DVD-ROM and click [OK].

Reinstalling Software

Reinstalling software will return the computer to the default condition. When you reinstall the software, the hard disk data will be erased.

Back up important data to other media or an external hard disk before reinstallation.

CAUTION

Do not delete the recovery partition on the hard disk. This partition contains data to help recover your system. The disk space in the partition is not available to store data.

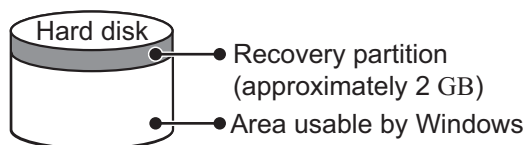

Preparation

- Prepare the Product Recovery DVD-ROM (included).
- Prepare the Panasonic CD/DVD drive (optional): CF-VDRRT1M, CF-VDRRT2W, CF-VDRRT3W, CF-VDRRT3U.
- Remove all peripherals (except for the CD/DVD drive).
- Connect the AC adaptor and do not remove it until reinstallation is complete.

- 1 Turn off the computer and connect the CD/DVD drive to the computer.**
- 2 Turn on the computer, and press F2 while [Panasonic] boot screen is displayed.**
The Setup Utility starts up.
 - If the password is requested, enter the Supervisor Password.
- 3 Write down all of the contents of the Setup Utility and press F9.**
At the confirmation message, select [Yes] and press Enter.
- 4 Select the [Boot] menu, then select [USB CDD] and press F6 until [USB CDD] is at the top of [Boot priority order].**
- 5 Set the Product Recovery DVD-ROM into the CD/DVD drive.**
- 6 Press F10.**
At the confirmation message, select [Yes] and press Enter.
The computer will restart.
- 7 Click [Reinstall Windows] and click [Next].**
The License Agreement screen appears.
- 8 Click [Yes, I agree to the provisions above and wish to continue!] and click [Next].**
- 9 Select the settings and click [Next].**
 - [Reinstall Windows to the whole Hard Disk to factory default.]
You will have a single partition.
 - [Reinstall Windows to the operating system partition.]
You can keep the partition structure.
- 10 At the confirmation message, click [YES].**
Reinstallation starts automatically. (It will take approximately 60 minutes.)
 - Do not interrupt reinstallation, for example by turning off the computer. Otherwise reinstallation may become unavailable as Windows may not start up or the data may be corrupted.
 - According to the instruction on the screen, switch Product Recovery DVD-ROM.
- 11 Remove the Product Recovery DVD-ROM, and then click [OK] to turn off the computer, then remove the CD/DVD drive.**
- 12 Turn on the computer, and press F2 while [Panasonic] boot screen is displayed.**
The Setup Utility starts up.
 - If the password is requested, enter the Supervisor Password.
- 13 Press F9.**
At the confirmation message, select [Yes] and then press Enter.
The Setup Utility settings excluding the password(s) will return to the default values.

14 Press F10.

At the confirmation message, select [Yes] and press Enter.
The Setup Utility will close, and the computer will restart.

15 Perform the first-time operation (→ page 12).

16 Start the Setup Utility and change the settings as necessary.

17 Perform Windows Update.

Troubleshooting (Basic)/Error Code/Message



Troubleshooting (Basic)

Follow the instructions below when a problem has occurred. There is also an advanced troubleshooting guide in the "Reference Manual". For a software problem, refer to the software's instruction manual. If the problem persists, contact your technical support office. You can also check the computer's status in the PC Information Viewer (→  Reference Manual "Check the Computer's Usage Status").

■ Starting Up and Sleep and Hibernation Mode

<p>The computer does not power on/ The power indicator or battery indicator is not lit.</p>	<ul style="list-style-type: none"> ● Connect the AC adaptor. ● Insert a fully charged battery. ● Remove the battery pack and the AC adaptor, then connect them again. ● If an additional RAM module has been inserted, remove the RAM module and check to see if the RAM module is the recommended one. ● When the CPU temperature is high, the computer may not start up to prevent overheating of the CPU. Wait until the computer cools down, and then turn the power on again. If the computer does not power on even after cooling down, contact your technical support office.
<p>Windows does not start up.</p>	<ul style="list-style-type: none"> ● When you turn on the computer for the first time after purchase Windows setup screen may not be displayed and [The computer restarted unexpectedly or encountered an unexpected error] message may appear. This message appears when the computer is forcibly turned off (e.g. The AC adaptor is removed. The battery becomes empty due to setup without connecting the AC adaptor.) and you cannot use Windows until reinstallation is complete. In this case, reinstall. ● When Windows does not start when resuming from hibernation, set the Product Recovery DVD-ROM and display [System Recovery Options] (→ page 24), and run [Startup Repair]. If the problem persists, perform reinstallation with the Product Recovery DVD-ROM. ● Remove all peripheral devices. <ul style="list-style-type: none"> • If a device is connected to the USB port, disconnect the device or set [Legacy USB Support] to [Disable] in the [Advanced] menu of the Setup Utility. ● If an additional RAM module has been inserted, remove the RAM module and check to see if the RAM module is the recommended one. ● If the power indicator is lit, slide the power switch for four seconds or longer to turn off, then turn on again. ● Using the following procedure, start up in Safe Mode, and check the error details. <ol style="list-style-type: none"> ① Turn on the computer, and when the [Panasonic] boot screen disappears (after entering the password*¹ if one is set) hold down F8. ② Release your finger when [Advanced Boot Options] is displayed, and with ↑ or ↓, select [Safe Mode], then press Enter. Follow the on-screen instructions. <p>*¹ Supervisor Password or User Password set with the Setup Utility</p> <ul style="list-style-type: none"> ● Press F9 in the Setup Utility (→ page 31 "To start the Setup Utility") to return the Setup Utility settings (excluding the passwords) to the default values. Start the Setup Utility and make the settings again.
<p>There is a beep sound, and either "Extended RAM Module Failed" or "Standard RAM Failed" appears.</p>	<ul style="list-style-type: none"> ● If "Extended RAM Module Failed" appears, the RAM module is not correctly inserted. Turn off the computer, check that the RAM module is a recommended module, then insert it correctly. ● If "Standard RAM Failed" appears, contact your technical support office.
<p>Cannot boot from optional CD/DVD drive.</p>	<ul style="list-style-type: none"> ● Make sure that the bootable CD/DVD is set properly. ● Start the Setup Utility, and confirm the following settings. <ul style="list-style-type: none"> • [USB Port] and [Legacy USB Support] are set to [Enable] in the [Advanced] menu. • [USB CDD] is the first device shown in [Boot priority order] in the [Boot] menu.
<p>You have forgotten the password.</p>	<ul style="list-style-type: none"> ● Supervisor Password or User Password: Contact your technical support office. ● Administrator password: <ul style="list-style-type: none"> • If you have another account with Administrator authority, log-on with it, then delete the password for the problem account. • If you have a password reset disk, click [Reset password] displayed after the password input error, then follow the on-screen instructions to set a new password. <p>If you cannot do either of the above, you will need to reinstall (→ page 26) and setup Windows.</p>
<p>"Remove disks or other media. Press any key to restart" or a similar message appears.</p>	<ul style="list-style-type: none"> ● A floppy disk is in the floppy disk drive and it does not contain system startup information. Remove the floppy disk and press any key. ● This message may appear with some devices connected to the USB port. Remove the device or set [Legacy USB Support] to [Disable] in the [Advanced] menu of the Setup Utility. ● If the problem persists after removing the disk, it may be a hard disk failure. Perform the reinstallation and return the hard disk to its condition at the time of purchase. (→ page 26) If the problem persists even after the reinstallation, contact your technical support office.

■ Starting Up and Sleep and Hibernation Mode

[Executing Battery Recalibration] screen appears.	<ul style="list-style-type: none"> ● The Battery Recalibration was canceled before Windows was shut down last time. To start up Windows, turn off the computer by the power switch, and then turn on.
The computer will not automatically enter sleep/hibernation.	<ul style="list-style-type: none"> ● If you connect to a network using wireless LAN function, perform access point settings. (→  Reference Manual "Wireless LAN") ● If you do not use wireless LAN function, turn off wireless LAN function. (→  Reference Manual "Disabling/Enabling Wireless Communication") ● Make sure that you are not using any software that regularly accesses the hard disk.
When logging on (e.g., resuming the computer), audio is distorted.	<ul style="list-style-type: none"> ● Perform the following steps to change the audio settings to prevent audio output. <ol style="list-style-type: none"> ① Right-click the desktop and click [Personalize] - [Sounds]. ② Remove the check mark from [Play Windows Startup sound], and click [OK].
Cannot resume.	<ul style="list-style-type: none"> ● One of the following operations may have been carried out. <ul style="list-style-type: none"> • In sleep mode, the AC adaptor or battery pack was disconnected, or a peripheral was connected or disconnected. • The power switch was slid for four seconds or longer to forcibly turn off the computer. Slide the power switch to turn on the computer. Data not saved will be lost.
Other startup problems.	<ul style="list-style-type: none"> ● Check to see if there was a disk error. <ol style="list-style-type: none"> ① Remove all peripheral devices including an external display. ② Click  (Start) - [Computer] and right-click [Local Disk (C:)], and click [Properties]. ③ Click [Tools] - [Check Now]. <ul style="list-style-type: none"> • A standard user needs to enter an administrator password. ④ Select the option in [Check disk options] and click [Start]. ● Start the computer in Safe Mode and check the error details. (→ page 28 "Windows does not start up")

■ Shutting Down

Windows does not shut down.	<ul style="list-style-type: none"> ● Remove all peripheral devices. ● Wait one or two minutes. It is not a malfunction.
-----------------------------	---

■ Password

Even after entering the password, a message appears requesting to type it again.	<ul style="list-style-type: none"> ● If  lights up, press NumLk to disable the ten-key mode, and then input. ● If  lights up, press Caps Lock to disable the Caps Lock mode, and then input.
--	--

■ Display



When the screen becomes black for a moment.	<ul style="list-style-type: none"> ● When you set [Intel video driver power saving function (Intel® Display Power Saving Technology)] of Power Saving Utility to [Enable], if you do the following operations, the screen becomes black for a moment, but this is not a malfunction. You can continue to use this. <ul style="list-style-type: none"> • Adjust the brightness of the screen with Fn + F1 / Fn + F2. • Remove and insert the AC adaptor. While you are using motion video playback software, benchmark software for graphic, if error screen is displayed or application software does not function normally, set [Intel video driver power saving function (Intel® Display Power Saving Technology)] to [Disable].
No display.	<ul style="list-style-type: none"> ● The external display is selected. Press Fn + F3 to switch the display. Wait until the display has been switched completely before pressing Fn + F3 again. ● The display is turned off by the power-saving function. To resume, do not press the direct selection keys, but press any other key like Ctrl. ● The computer entered sleep or hibernation by the power-saving function. To resume, slide the power switch. ● The screen may become darker. Press Fn + F2 to make the screen brighter.
The screen is disordered.	<ul style="list-style-type: none"> ● Changing the number of display colors and resolution may affect the screen. Restart the computer. ● The refresh rate of the internal LCD may be 40 hertz. Change the refresh rate of the internal LCD. <ol style="list-style-type: none"> ① Right-click the desktop and click [Graphics Properties]. ② Click [Display Devices] - [Display Settings]. ③ If [Refresh Rate] of the Notebook is [40 Hertz], change to [60 Hertz] and click [OK].
The external display does not work normally.	<ul style="list-style-type: none"> ● If the external display does not support the power saving function, it may not work normally when the computer enters the power saving mode. Turn off the external display.
The sidebar gadgets are not correctly displayed.	<ul style="list-style-type: none"> ● Log off and log on Windows, and display the sidebar again.

Troubleshooting (Basic)/Error Code/Message

■ Battery

The battery indicator is lights red.	<ul style="list-style-type: none"> ● The battery level is very low (the charge is approx. 9% or less). ● Connect the AC adaptor. You can use the computer when the indicator light is orange. If you do not have an AC adaptor, save your data and power off your computer. After replacing the battery pack with a fully charged one, turn your computer on again.
The battery indicator is blinking.	<ul style="list-style-type: none"> ● If blinking red: Quickly save your data and power off your computer. Remove the battery pack and disconnect the AC adaptor, then connect them again. If the problem persists, contact your technical support office. The battery pack or charging circuit may be defective. ● If blinking orange: <ul style="list-style-type: none"> • Battery cannot be recharged temporarily because the internal temperature of the battery pack is outside the acceptable temperature range for recharging. Your computer can be used normally in this state. Once the range requirement is satisfied, charging begins automatically. • Software applications and peripheral devices (USB devices, etc.) are consuming too much power. Exit the software applications currently running. Once the range requirement is satisfied, charging begins automatically.
The battery indicator is flashing.	<ul style="list-style-type: none"> ● The battery is recharging. If [Battery Charging Indicator] in [Main] menu of the Setup Utility is set to [Flashing], the indicator will alternately become lighter and darker.

■ Touch Pad/Touchscreen

The cursor does not work.	<ul style="list-style-type: none"> ● When using the external mouse, connect it correctly. ● Restart the computer by using the keyboard. Press  and press  three times, and press  to select [Restart] and press Enter. ● If the computer does not respond to keyboard commands, read "No response" (→ below).
Cannot input using the touch pad.	<ul style="list-style-type: none"> ● Set [Touch Pad] to [Enable] in the [Main] menu of the Setup Utility. ● The drivers for some mice may disable the touch pad. Check your mouse's operating instructions.
Cannot input using the touchscreen.	<ul style="list-style-type: none"> ● When mouse drivers are installed (i.e. IntelliMouse), the touchscreen does not work. Reinstall the touchscreen driver.
Cannot input using the touchscreen as the tablet mode.	<ul style="list-style-type: none"> ● Set [Touchscreen Mode] to [Auto] or [Tablet] in the [Main] menu of the Setup Utility.
Cannot point the correct position using the included stylus.	<ul style="list-style-type: none"> ● Perform the touchscreen calibration (→ page 13).

■ Reference Manual

The Reference Manual is not displayed.	<ul style="list-style-type: none"> ● Install Adobe Reader. <For localized OS model> <ol style="list-style-type: none"> ① Log on to Windows as an administrator. ② Click  (Start) and input "c:\util\reader\setup.exe" in [Start Search] then press Enter. ③ Update Adobe Reader to its latest version. If your computer is connected to the internet, start up Adobe Reader and click [Help] - [Check for Updates]. <For MUI OS model> (→ page 13)
--	---

■ Others

[System Restore] does not appear by pressing F8 .	<ul style="list-style-type: none"> ● The restoration program does not run after Windows Anytime Upgrade is executed. For further information, access the following web site: https://ewww.pavc.panasonic.co.jp/pc/itn/support/vistainfo.html
No response.	<ul style="list-style-type: none"> ● Press Ctrl+Shift+Esc to open Task Manager and close the software application that is not responding. ● An input screen (e.g., password input screen at startup) may be hidden behind another window. Press Alt+Tab to check. ● Slide the power switch for four seconds or longer to shut down the computer, and then slide the power switch to turn it on. If the application program does not work normally, uninstall and reinstall the program. To uninstall, click  (Start) - [Control Panel] - [Uninstall a program].
Unable to input password	<ul style="list-style-type: none"> ● Some keyboards have unusable keys (e.g. the "M" key on French keyboards). Use the other key when you press the key and the alarm sounds.

■ Others

The PC information viewer startup is slow.	<ul style="list-style-type: none"> ● It may take a minute or longer to start up depending on the network environment.
Cannot change the Windows language.	<ul style="list-style-type: none"> ● Reinstallation is necessary to change the Windows language (→ page 26).

Error Code/Message

Follow the instructions below when an error code or message appears. If the problem persists or if the error code/message displayed is not shown here, contact your technical support office.

Error Code/Message	Solution
0211 Keyboard error	<ul style="list-style-type: none"> ● Disconnect external keyboard.
0251 System CMOS checksum bad - Default configuration used	<p>An error has occurred in the memory of Setup Utility settings. This occurs when the memory content is changed by an unexpected program operation, etc.</p> <ul style="list-style-type: none"> ● Start the Setup Utility and return the settings to the default values, and then change the settings as necessary. ● If the problem persists, the internal clock battery may need to be replaced. Contact your technical support office.
0271 Check date and time settings	<p>The date and time settings are not correct.</p> <ul style="list-style-type: none"> ● Start the Setup Utility and set the correct date and time. ● If the problem persists, the internal clock battery may need to be replaced. Contact your technical support office.
0280 Previous boot incomplete - Default configuration used	<p>Startup has failed repeatedly, so the Setup Utility settings have been returned to the default values to startup the computer.</p> <ul style="list-style-type: none"> ● Start the Setup Utility and return the settings to the default values, and then change the settings as necessary.
Press <F2> to Setup	<ul style="list-style-type: none"> ● Write down the error details and press F2 to start the Setup Utility. Change the settings if necessary.
Operating System not found	<p>The operating system is not installed in the floppy disk or the hard disk that you are going to boot from.</p> <ul style="list-style-type: none"> ● If using a floppy disk, change the disk to the one you can use for boot. ● If using the hard disk, check if the hard disk is recognized in [Information] menu of the Setup Utility. If the hard disk is recognized, perform the reinstallation (→ page 26). If not, contact your technical support office. ● If a device is connected to the USB port, disconnect the device, or set [Legacy USB Support] to [Disable] in the [Advanced] menu of the Setup Utility.

■ To start the Setup Utility

- ① Restart the computer.
- ② Press **F2** while [Panasonic] boot screen is displayed.

Hardware Diagnostics

If the hardware installed in this computer is not operating properly, you can use the PC-Diagnostic Utility to determine whether or not there is a problem.

If the utility discovers a problem in the hardware, contact your technical support office.

Hardware that can be checked using the PC-Diagnostic Utility

Hardware below can be checked using this utility. (Software cannot be checked.)

- CPU
- Memory
- Hard Disk
- Video Controller
- Sound*¹
- Modem
- LAN
- Wireless LAN*²
- Wireless WAN*³
- Bluetooth*⁴
- USB
- PC Card Controller
- SD Card Controller
- Keyboard
- Touch Pad
- Touchscreen

*¹ When the PC-Diagnostic Utility is running, a loud beep will sound, so do not use headphones at this time. (The beep will not sound if mute is using Windows.)

*² Only for model with wireless LAN

*³ Only for model with wireless WAN

*⁴ Only for model with Bluetooth

- When the video diagnostic check is running, the display may be distorted, and when the audio diagnostic check is running, sounds may be generated from the speaker. These are not malfunctions.

Regarding the PC-Diagnostic Utility

NOTE

- For the hard disk only, you can select standard diagnostic check or extended diagnostic check. When the PC-Diagnostic Utility starts up, it will run the standard diagnostic check.
- We recommend that you use the touch pad for operations. When not using the touch pad, you can operate using the internal keyboard instead.

Operations	Touch pad operations	Internal keyboard operations
Select icon	Place the cursor above the icon	Press Space and then press → ← ↑ ↓ (☒ (close) cannot be selected)
Click the icon	Tap or click (right click cannot be used)	Press Space above the icon
Complete the PC- Diagnostic Utility and then restart the computer	Click ☒ (close)	Press Ctrl + Alt + Del

- If the touch pad does not operate properly, press **Ctrl + Alt + Del** to restart the computer, or slide the power switch to turn the power off, and then restart the PC-Diagnostic Utility.

Running the Diagnostic Check

Run this utility using the default settings in the Setup Utility.

If the Setup Utility or other settings will not allow a hardware to be executed, the hardware icon will be displayed in gray.

- 1 Connect the AC adaptor, and turn on the wireless switch.**
During the diagnostic check, do not remove the AC adaptor, or attach any peripheral devices.
- 2 Turn on or restart the computer, and press **F2** while [Panasonic] boot screen is displayed.**
The Setup Utility starts up.
 - If the password is requested, enter the Supervisor Password.
 - If you are using the computer after changing the settings from the status at the time of purchase, we recommend that you make a note of the settings that are changed.

3 Press **F9**.





At the confirmation message, select [Yes] and press **Enter**.

4 Press **F10**.

At the confirmation message, select [Yes] and press **Enter**.
The computer will restart.



5 Press **Ctrl + F7** while [Panasonic] boot screen is displayed.

When the PC-Diagnostic Utility starts up, it will automatically begin the diagnostic check for all hardware components.

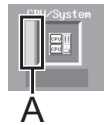
- If the password is requested, enter the password.
- The touch pad and the internal keyboard cannot be used until alternating blue and yellow colors are displayed on the left side of the hardware icon (A).
- By clicking the icon, you can execute the following operations:
 -  : Start the diagnostic check from the beginning
 -  : Stop the diagnostic check (You cannot restart the check partway through by clicking )
 -  : Display help (click the screen or press **Space** to return to the original diagnostic check screen)
- You can check the status of the diagnostic check by the display color on the left side of the hardware icon (A).
 - Aqua: Not running diagnostic check
 - Alternating blue and yellow: Currently running diagnostic check. The interval of the alternating colors differs depending on the type of diagnostic check currently running.
During memory diagnostic check, the display may freeze for a long period of time. Wait until the process is complete.
 - Green: No problems discovered
 - Red: Problems discovered



NOTE

- Using the following procedure, you can run a diagnostic check on a specified hardware component, or run an extended diagnostic check on the hard disk (The extended diagnostic check is only for the hard disk). The extended diagnostic check is more detailed, and so requires a longer period of time to run.
 - ① Click  to stop the diagnostic check.
 - ② Click the icon for the hardware that is not to be checked, so that the icon is displayed in gray (B).
When running a check on the hard disk, clicking the icon once will turn on the extended diagnostic check ("FULL" (C)) will be displayed below the icon); click again, and the icon will be displayed in gray.
 - ③ Click  to start the diagnostic check.

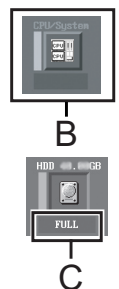

6 When all the hardware has been checked, confirm the diagnostic check results.

If the display is red and the message "Check Result TEST FAILED" is displayed, you can assume that there is a problem with the computer's hardware. Confirm which hardware component is displayed as red, and contact your technical support office.

If the display is green and the message "Check Result TEST PASSED" is displayed, the computer's hardware is operating normally. Continue using the computer as it is. If the computer still does not operate properly, reinstall the software. (→ page 26)

NOTE

- If you run a memory diagnostic check after installing a new RAM module (sold separately) and the message "Check Result TEST FAILED" is displayed:
Remove the additional RAM module and run the diagnostic check again. If the message "Check Result TEST FAILED" is still displayed, you can assume that there is a problem with the internal RAM module.

7 After the diagnostic check is complete, click (close), or press **Ctrl + Alt + Del** to restart the computer.

LIMITED USE LICENSE AGREEMENT

THE SOFTWARE PROGRAM(S) (“PROGRAMS”) FURNISHED WITH THIS PANASONIC® PRODUCT (“PRODUCT”) ARE LICENSED ONLY TO THE END-USER (“YOU”), AND MAY BE USED BY YOU ONLY IN ACCORDANCE WITH THE LICENSE TERMS DESCRIBED BELOW. YOUR USE OF THE PROGRAMS SHALL BE CONCLUSIVELY DEEMED TO CONSTITUTE YOUR ACCEPTANCE OF THE TERMS OF THIS LICENSE.

Matsushita Electric Industrial Co., Ltd. (“MEI”) has developed or otherwise obtained the Programs and hereby licenses their use to you. You assume sole responsibility for the selection of the Product (including the associated Programs) to achieve your intended results, and for the installation, use and results obtained therefrom.

LICENSE

- A. MEI hereby grants you a personal, non-transferable and non-exclusive right and license to use the Programs in accordance with the terms and conditions stated in this Agreement. You acknowledge that you are receiving only a LIMITED LICENSE TO USE the Programs and related documentation and that you shall obtain no title, ownership nor any other rights in or to the Programs and related documentation nor in or to the algorithms, concepts, designs and ideas represented by or incorporated in the Programs and related documentation, all of which title, ownership and rights shall remain with MEI or its suppliers.
- B. You may use the Programs only on the single Product which was accompanied by the Programs.
- C. You and your employees and agents are required to protect the confidentiality of the Programs. You may not distribute or otherwise make the Programs or related documentation available to any third party, by time-sharing or otherwise, without the prior written consent of MEI.
- D. You may not copy or reproduce, or permit to be copied or reproduced, the Programs or related documentation for any purpose, except that you may make one (1) copy of the Programs for backup purposes only in support of your use of the Programs on the single Product which was accompanied by the Programs. You shall not modify, or attempt to modify, the Programs.
- E. You may transfer the Programs and license them to another party only in connection with your transfer of the single Product which was accompanied by the Programs to such other party. At the time of such a transfer, you must also transfer all copies, whether in printed or machine readable form, of every Program, and the related documentation, to the same party or destroy any such copies not so transferred.
- F. You may not remove any copyright, trademark or other notice or product identification from the Programs and you must reproduce and include any such notice or product identification on any copy of any Program.

YOU MAY NOT REVERSE ASSEMBLE, REVERSE COMPILE, OR MECHANICALLY OR ELECTRONICALLY TRACE THE PROGRAMS, OR ANY COPY THEREOF, IN WHOLE OR IN PART.

YOU MAY NOT USE, COPY, MODIFY, ALTER, OR TRANSFER THE PROGRAMS OR ANY COPY THEREOF, IN WHOLE OR IN PART, EXCEPT AS EXPRESSLY PROVIDED IN THE LICENSE.

IF YOU TRANSFER POSSESSION OF ANY COPY OF ANY PROGRAM TO ANOTHER PARTY, EXCEPT AS PERMITTED IN PARAGRAPH E ABOVE, YOUR LICENSE IS AUTOMATICALLY TERMINATED.

TERM

This license is effective only for so long as you own or lease the Product, unless earlier terminated. You may terminate this license at any time by destroying, at your expense, the Programs and related documentation together with all copies thereof in any form. This license will also terminate effective immediately upon occurrence of the conditions thereof set forth elsewhere in this Agreement, or if you fail to comply with any term or condition contained herein. Upon any such termination, you agree to destroy, at your expense, the Programs and related documentation together with all copies thereof in any form.

YOU ACKNOWLEDGE THAT YOU HAVE READ THIS AGREEMENT, UNDERSTAND IT AND AGREE TO BE BOUND BY ITS TERMS AND CONDITIONS. YOU FURTHER AGREE THAT IT IS THE COMPLETE AND EXCLUSIVE STATEMENT OF THE AGREEMENT BETWEEN US, WHICH SUPERSEDES ANY PROPOSAL OR PRIOR AGREEMENT, ORAL OR WRITTEN, AND ANY OTHER COMMUNICATIONS BETWEEN US, RELATING TO THE SUBJECT MATTER OF THIS AGREEMENT.

Specifications

This page provides the specifications for the basic model CF-T7BWASZJE/CF-T7BWATFJE. The model number is different according to the unit configuration.

To check CPU speed, memory size and the hard disk drive (HDD) size:

Start the Setup Utility (→  *Reference Manual* “Setup Utility”) and select [Information] menu.

[CPU Speed]: CPU speed, [System Memory]: Memory size, [Hard Disk]: Hard disk drive size

■ Main Specifications

Model No.		CF-T7BWASZJE	CF-T7BWATFJE
CPU/ Secondary cache memory		Intel® Core™ 2 Duo Processor Ultra Low Voltage U7500 (1.06 GHz, 2 MB*1 L2 cache, 533 MHz FSB)	
Chip Set		Mobile Intel® GM965 Express chip set	
Main Memory*2		1 GB*1, DDR2 SDRAM (2 GB*1 Max.)	
Video Memory		UMA (251 MB*1 Max.)*3	
Hard Disk Drive		80 GB*4 Approx. 2 GB*4 are used as a recovery partition. (Users cannot use this partition.)	
Display Method		12.1 XGA type (TFT) (1024 × 768 dots)	
Internal LCD		65,536/16,777,216 colors (1024 × 768 dots)*5	
External Display*6		65,536/16,777,216 colors (800 × 600 dots/1024 × 768 dots/1280 × 768 dots/1280 × 1024 dots/1400 × 1050 dots/1440 × 900 dots/1600 × 1200 dots)	
Simultaneous Display on LCD + External Display*6		65,536/16,777,216 colors (800 × 600 dots/1024 × 768 dots)*5	
Wireless LAN		Intel® Wireless WiFi Link 4965AGN *7 (→ page 36)	
Bluetooth*8		→ page 36	
HSDPA		—	(→ <i>Supplementary Instructions for HSDPA/UMTS</i>)
LAN*9		IEEE 802.3 10Base-T, IEEE 802.3u 100Base-TX, IEEE 802.3ab 1000Base-T	
Modem		Data: 56 kbps (V.92) FAX: 14.4 kbps	
Sound		WAVE and MIDI playback, Intel® High Definition Audio subsystem support, Monaural Speaker (built in)	
Security Chip		TPM (TCG V1.2 compliant)*10	
Card Slots	PC Card Slot	× 1, Type I or Type II, Allowable current 3.3 V: 400 mA, 5 V: 400 mA	
	SD Memory Card Slot*11	× 1	
RAM Module Slot		× 1, DDR2 SDRAM, 200-pin, 1.8 V, SO-DIMM, PC2-4200 Compliant*12	
Interface		USB Ports × 3 (USB2.0 × 3)*13 / Modem Port (RJ-11) / LAN Port (RJ-45) *9 / External Display Port: Mini Dsub 15-pin female / Microphone Jack*14: Miniature jack, 3.5 DIA / Headphone Jack: Miniature jack, 3.5 DIA / Mini Port Replicator connector: Dedicated 50-pin male	
Keyboard/Pointing Device		84 keys/Touch Pad/Touchscreen (stylus (included) touch capable)	
Power Supply		AC adaptor or Battery pack	
AC Adaptor*15		Input: 100 V - 240 V AC, 50 Hz/60 Hz Output: 16 V DC, 3.75 A	
Battery Pack		Li-ion 10.8 V, 5.8 Ah	
Operating Time*16		Approx. 7 hours (Economy Mode (ECO) - Disable)	Approx. 6.5 hours (Economy Mode (ECO) - Disable)
Charging Time*17		Approx. 5 hours (Power off)/Approx. 6.5 hours (Power on)	
Power Consumption*18		Approx. 25 W*19 / Approx. 60 W (maximum when recharging in the ON state)	
Physical Dimensions (W × H × D)		272 mm × 27.9 mm (at the front)/48.3 mm (at the rear) × 214.3 mm (excluding protrusion)	272 mm × 36 mm (at the front)/49.3 mm (at the rear) × 214.3 mm (excluding protrusion)
Weight*20		Approx. 1385 g	Approx. 1465 g
Environment	Operation	Temperature	5°C to 35°C
		Humidity	30% to 80% RH (No condensation)
	Storage	Temperature	-20°C to 60°C
		Humidity	30% to 90% RH (No condensation)

Specifications

Model No.	CF-T7BWASZJE	CF-T7BWATFJE
OS*21	Windows Vista® Business	
Pre-installed Software*21	Microsoft® Internet Explorer 7.0 / DirectX 10 / Microsoft® Windows® Media Player 11 / Microsoft® Windows® Movie Maker 6.0 / Microsoft® .NET Framework 3.0 / Adobe Reader / Loupe Utility / Touch Pad Utility / DMI Viewer / PC Information Viewer / PC Information Popup / Display Rotation Tool / Hotkey Settings / Power Saving Utility / Fan Control Utility / LAN Power Saving Utility / Intel® Matrix Storage Manager / Wireless Switch Utility / Wireless Connection Disable Utility*22 / Bluetooth Stack for Windows by TOSHIBA*8 / Economy Mode (ECO) Setting Utility / Battery Recalibration Utility / Infineon TPM Professional Package V3.0*22	
	Setup Utility / Hard Disk Data Erase Utility*23 / PC-Diagnostic Utility*24	

■ Wireless LAN <Only for model with wireless LAN>

Data Transfer Rates	IEEE802.11a: 54/48/36/24/18/12/9/6 Mbps (automatically switched)*25 IEEE802.11b: 11/5.5/2/1 Mbps (automatically switched)*25 IEEE802.11g: 54/48/36/24/18/12/9/6 Mbps (automatically switched)*25
Standard Supported	IEEE802.11a/IEEE802.11b/IEEE802.11g
Transmission Method	OFDM system, DS-SS system
Wireless Channels Used	IEEE802.11a: Channels 36/40/44/48/52/56/60/64/100/104/108/112/116/120/124/128/132/136/140 IEEE802.11b/ IEEE802.11g: Channels 1 to 13
RF Frequency Band	IEEE802.11a: 5.18 - 5.32 GHz, 5.500 - 5.700 GHz IEEE802.11b/ IEEE802.11g: 2412 - 2472 MHz

■ Bluetooth™ <Only for model with Bluetooth>

Bluetooth Version	2.0 + EDR
Transmission Method	FHSS system
Wireless Channels Used	Channels 1 to 79
RF Frequency Band	2.402-2.48 GHz

*1 1 MB = 1,048,576 bytes / 1 GB = 1,073,741,824 bytes

*2 You can physically expand the memory up to 2 GB, but the total amount of usable memory available will be less depending on the actual system configuration.

*3 A segment of the main memory is allotted automatically depending on the computer's operating status. The size of the Video Memory cannot be set by the user. The size of Video memory is allotted depending on the operating system.

*4 1 GB = 1,000,000,000 bytes. Your operating system or some application software will report as fewer GB.



*5 A 16,777,216-color display is achieved by using the dithering function.

*6 Display may be impossible using some connected external displays.

*7 Only for model with wireless LAN. It does not correspond to IEEE802.11n.

*8 Only for model with Bluetooth.

*9 Some devices cannot be used depending on the port type.

*10 For information on TPM, click  (Start) and input "c:\util\drivers\tpm\README.pdf" in [Start Search], and press **Enter**, and refer to the  *Installation Manual* of "Trusted Platform Module (TPM)".

*11 This slot is compatible with High-Speed Mode. Operation has been tested and confirmed using Panasonic SD/SDHC Memory Cards with a capacity of up to 8 GB. Operation on other SD equipment is not guaranteed.

*12 Only a RAM module designed for DDR2 (PC2-4200) can be added (Panasonic : CF-BAK0512U, CF-BAK1024U). 172-pin Micro DIMM used in CF-T5/CF-W5 series cannot be used.

*13 Does not guarantee operation of all USB-compatible peripherals.

*14 Use a condenser-stereo microphone.

*15 <Only for North America>
The AC adaptor is compatible with power sources up to 240 V AC adaptor. This computer is supplied with a 125 V AC compatible AC cord.

20-M-2-1

*16 Measured using MobileMark™ 2007 (LCD brightness : 60 cd/m²).
Varies depending on the usage conditions, or when an optional device is attached.
When Economy Mode (ECO) is enabled, the operating time becomes approximately 20 % shorter than when it is disabled. When using the optional battery pack (CF-VZSU52W), operating time will be almost halved.

*17 Varies depending on the usage conditions, CPU speed, etc. It may take a long time to charge a fully discharged battery. When using the optional battery pack (CF-VZSU52W):
Approx. 4 hours (Power off)/Approx. 5 hours (Power on)

*18 Approx. 0.9 W when the battery pack is fully charged (or not being charged) and the computer is off.

*19 Rated power consumption.

23-E-1

*20 Average value. May differ depending on models.

*21 Operations of this computer are not guaranteed except for the pre-installed OS.

*22 Must be installed before use.

*23 The Product Recovery DVD-ROM is required.

*24 For startup methods, refer to "Hardware Diagnostics" (➔ page 32).

*25 These are speeds specified in IEEE802.11a+b+g standards. Actual speeds may differ.



As an ENERGY STAR® Partner, Matsushita Electric Industrial Co., Ltd. has determined that this product meets the ENERGY STAR® guidelines for energy efficiency.

Outline of the International ENERGY STAR® Office Equipment Program

The international ENERGY STAR® Office Equipment Program is an international program that promotes energy saving through the use of computers and other office equipment. The program backs the development and dissemination of products with functions that effectively reduce energy consumption. It is an open system in which business proprietors can participate voluntarily. The targeted products are office equipment such as computers, displays, printers, facsimiles, and copiers. Their standards and logos are uniform among participating nations.

22-E-1

Importer's name & address pursuant to the EU GPSD directive 2001/95/EC/Art.5
Panasonic Computer Products Europe, Panasonic Marketing Europe GmbH
Hagenauer Straße 43
65203 Wiesbaden
Germany