

DELUXE PET CRATE WITH TRAY

Model 94444

ASSEMBLY AND OPERATING INSTRUCTIONS

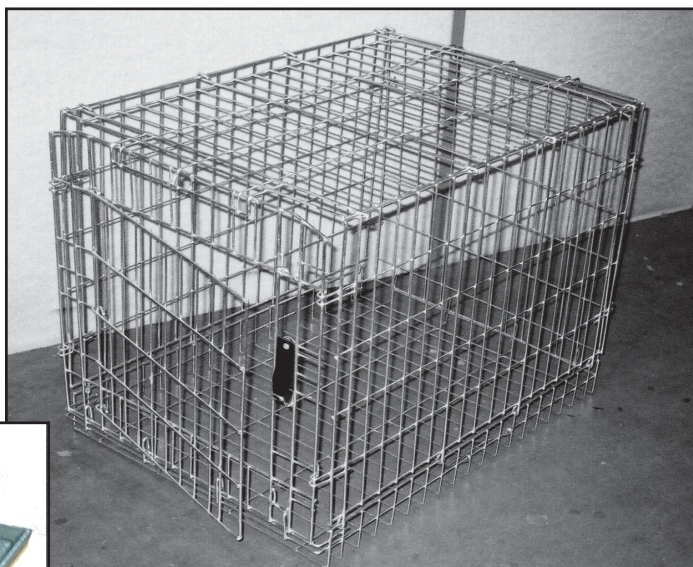

3491 Mission Oaks Blvd., Camarillo, CA 93011
Visit our Web site at <http://www.harborfreight.com>

Copyright © 2006 by Harbor Freight Tools®. All rights reserved. No portion of this manual or any artwork contained herein may be reproduced in any shape or form without the express written consent of Harbor Freight Tools.

For technical questions please call 1-800-444-3353

SPECIFICATIONS

ITEM	DESCRIPTION
Overall Dimensions	30"L X 20-7/8"W X 23-1/2"H
Materials	Steel Wire Cage with Welded Joints
Finish	Zinc Plated
Door Style	Spring Plastic and Hook Latch
Net Weight	16-1/2 Lbs.
Cage Wire Thickness	3/16"
Tray Dimensions	29-1/2" L X 20-7/8" W X 1" H

SAVE THIS MANUAL

You will need the manual for the safety warnings and precautions, assembly instructions, operating and maintenance procedures, parts list and diagram. Keep your invoice with this manual. Write the invoice number on the inside of the front cover. Keep the manual and invoice in a safe and dry place for future reference.

SAFETY WARNINGS AND PRECAUTIONS

1. **AVOID SHARP EDGES WHEN ASSEMBLING.**
2. **KEEP PRODUCT USAGE AREA CLEAN.**
3. **ALWAYS CHECK DOOR LOCK AND ASSEMBLY LATCHES.**
4. **CHECK FOR DAMAGED PARTS.** Before using this product, carefully check that it will operate properly and perform its intended function. Check for damaged parts and any other conditions that may affect its operation. Replace or repair damaged or worn parts immediately.
5. **REPLACEMENT PARTS AND ACCESSORIES.** When servicing, use only identical replacement parts.
6. **USE EXTREME CAUTION** when transporting animal in Wire Pet Cage. Do not lift cage with animal inside cage. Could cause back injury or injury to animal.
7. **DO NOT ALLOW CHILDREN TO STAND UPON OR CLIMB INTO WIRE PET CAGE.** Do not let children handle this product. Fingers can get pinched.
8. **FOR SMALL ANIMALS ONLY.** Maximum weight should not exceed 40 Lbs.

ASSEMBLY AND CAUTIONARY INSTRUCTIONS

1. The Wire Pet Cage (#1) comes collapsed for transportation and storage. This strong, durable steel Wire Pet Cage has good ventilation and visibility for your pet and is excellent for home and travel use. (See Figure 1).

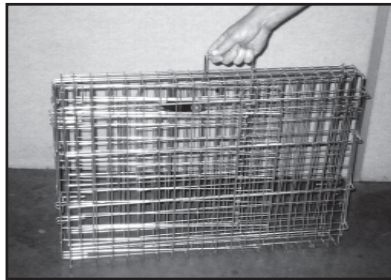

Figure 1

2. Open collapsed Wire Pet Cage (#1). Lift Back Side (#2) and snap into Latches (#5) securely. (See Figure 2 & 3).

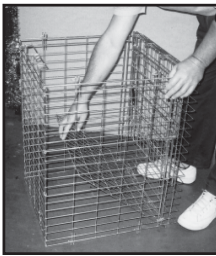

Figure 2

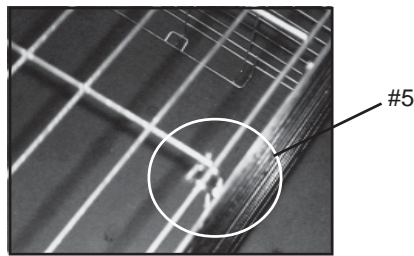

Figure 3

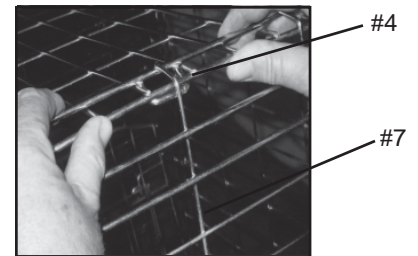

Figure 4

3. Lay Tray (#8) on the bottom of the Cage and latch sides around Tray. Please note that Tray MUST be inside Wire Pet Cage before the Cage is fully assembled.
4. Lift Front Side (#3) with Pet Cage Door (#7) and snap into Latch (#4) (See Figure 4). Be sure all sides are snapped into place. (See Figure 7).
5. Familiarize yourself with the Spring Plastic Hook Latch (#6) before placing animal in Wire Pet Cage (#1). Close Door (#7). Hook Latch (#6) points down. To lock and unlock, push black Hook Latch, lift up and drop in place. Reverse to unlock. Always check to make sure Door is properly closed and locked. (See Figure 5, 6 , 7).

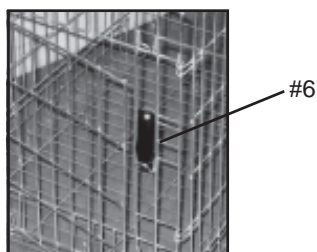

Figure 5

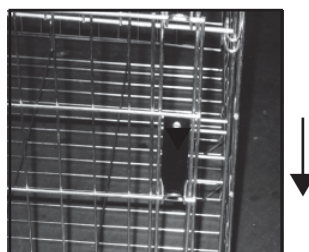

Figure 6

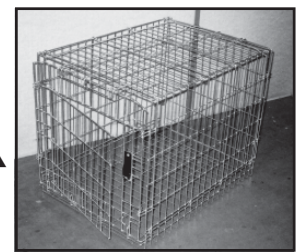
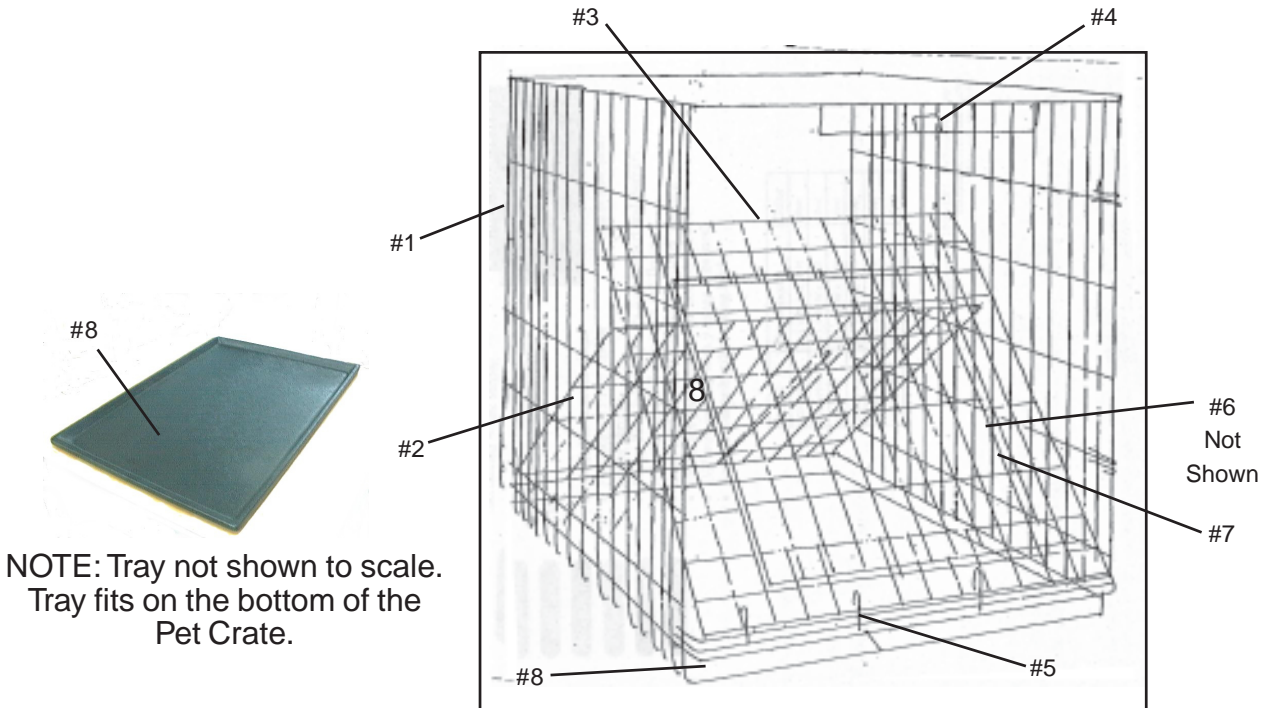

Figure 7

6. This is a temporary animal Pet Cage only. Always check that Hook Latch (#6) is locked after placing animal in Cage. Have water in Cage for your pet and never leave animal unattended in hot car. A piece of carpet remnant or appropriate padding (not included) should always be used to protect pet's paws.

PARTS LIST

PART #	DESCRIPTION	QTY
1	Wire Pet Cage (Top/Bottom and 2 Sides)	4
2	Back Side	1
3	Front Side	1
4	Latch (Top of Cage)	2
5	Latches (Bottom of Cage)	8
6	Spring Plastic and Hook Latch	1
7	Pet Cage Door	1
8	Tray	1



MAINTENANCE

1. For better and safer performance, keep all parts of this product clean and dry. Pet Crate can be hosed off to clean.
2. Periodically check to see that all hardware is in place.

PLEASE READ THE FOLLOWING CAREFULLY

THE MANUFACTURER AND/OR DISTRIBUTOR HAS PROVIDED THE PARTS DIAGRAM IN THIS MANUAL AS A REFERENCE TOOL ONLY. NEITHER THE MANUFACTURER NOR DISTRIBUTOR MAKES ANY REPRESENTATION OR WARRANTY OF ANY KIND TO THE BUYER THAT HE OR SHE IS QUALIFIED TO MAKE ANY REPAIRS TO THE PRODUCT OR THAT HE OR SHE IS QUALIFIED TO REPLACE ANY PARTS OF THE PRODUCT. IN FACT, THE MANUFACTURER AND/OR DISTRIBUTOR EXPRESSLY STATES THAT ALL REPAIRS AND PARTS REPLACEMENTS SHOULD BE UNDERTAKEN BY CERTIFIED AND LICENSED TECHNICIANS AND NOT BY THE BUYER. THE BUYER ASSUMES ALL RISK AND LIABILITY ARISING OUT OF HIS OR HER REPAIRS TO THE ORIGINAL PRODUCT OR REPLACEMENT PARTS THERETO, OR ARISING OUT OF HIS OR HER INSTALLATION OF REPLACEMENT PARTS THERETO.