

PA982 Ultra Rugged Mobile Computer

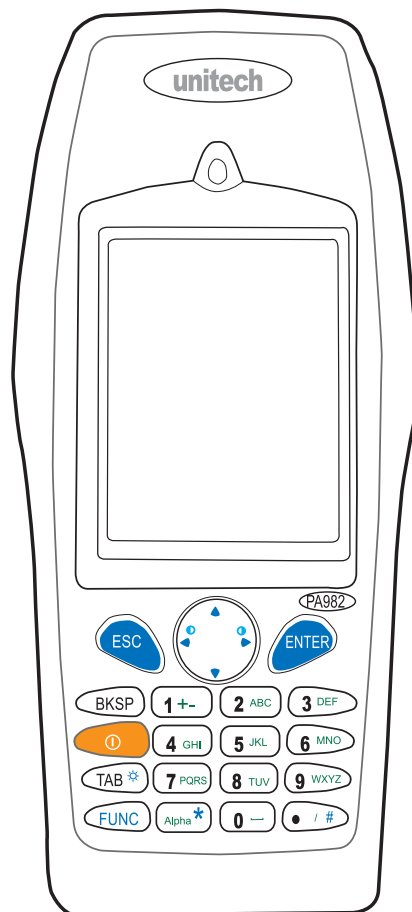

User's Manual



About This Manual

This manual explains how to install, operate and maintain the PA982 Ultra Rugged Mobile Computer. No part of this publication may be reproduced or used in any form, or by any electrical or mechanical means, without permission in writing from the manufacturer. This includes electronic or mechanical means, such as photocopying, recording, or information storage and retrieval systems. The material in this manual is subject to change without notice.

© Copyright 2006 unitech Electronics Co., Ltd. All rights reserved.

unitech global website address: <http://www.unitech-adc.com.tw>

Bluetooth is a registered trademark of Bluetooth SIG.



Microsoft, Windows and ActiveSync are either registered trademarks or trademarks of Microsoft Corporation. Other product names mentioned in this manual may be trademarks or registered trademarks of their respective companies and are hereby acknowledged.



unitech is a member of Oracle Embedded Software Licensing Program

Regulatory Compliance Statements

FCC Statement

This is a FCC Part 15 Class B product. In a domestic environment this product may cause radio interference, in which case the user may be required to take adequate measures.

Canadian Compliance Statement

This Class B Digital apparatus meets all requirements of the Canadian Interference-Causing Equipment Regulations.

Cet appareil numérique de la classe B respecte les exigences du Règlement sur le matériel brouilleur du Canada.

The device is certified to the requirements of RSS-139-1 for 2.4 GHz spread spectrum devices.

European Conformity Statement

Declaration of Conformity with Regard to the R&TTE 1999/5/EC and EMC 89/336/ EEC directives.

RoHS Statement



This device conforms to RoHS (Reduction Of Hazardous Substances) European Union regulations that set maximum concentration limits on hazardous materials used in electrical and electronic equipment.

Laser Information

The unitech PA982 series is certified in the U.S. to conform to the requirements of DHHS/CDRH 21CFR Subchapter J and to the requirements of IEC 825-1. Class II and Class 2 products are not considered to be hazardous. The PA982 series contains internally a Visible Laser Diode (VLD) whose emissions do not exceed the maximum limits as set forth in the above regulations. The scanner is designed so that there is no human access to harmful laser light during normal operation, user maintenance or during prescribed service operations.

The laser safety warning label required by the DHHS/IEC for the PA982 series's optional laser scanner module is located on the memory compartment cover, on the back of the unit.

CAUTION! Use of controls or adjustments or performance of procedures other than those specified herein may result in hazardous laser light. Use of optical instruments with the scanner will increase eye hazard. Optical instruments include binoculars, microscopes, and magnifying glasses. This does not include eye glasses worn by the user.

Battery Notices

This unit is equipped with a battery pack and backup battery. Both batteries will discharge after an extended period of not being used.

When both batteries are discharged, recharge the unit for 16 hours in order to fully charge the main battery and backup battery. There are two ways to recharge PA982:

1. Plug the synchronization cable to the PA982 and plug the 12V/2A AC-DC adapter to the power jack of the synchronization cable.
2. Place the PA982 into the docking station and plug the 12V/2A AC-DC adapter to the power jack of the docking station.

If the main battery is removed, the backup battery ensures the data on SDRAM is safe for up to 6 hours. To prevent data loss, do not leave the PA982 uncharged with the main battery removed for an extended period.

Refer to Chapter 7, Charging the battery

Battery Charge Notice

It is important to consider the environment temperature whenever you are charging the Lithium-Ion battery pack. The process is most efficient at normal room temperature or slightly cooler. It is essential that you charge batteries within the stated range of -5°C to 50°C. Charging batteries outside of the specified range could damage the batteries and shorten their charging life cycle.

Storage and Safety Notice

Although charged Lithium-Ion batteries may be left unused for several months, their capacity may be depleted due to build up of internal resistance. If this happens they will require recharging prior to use. Lithium-Ion batteries may be stored at temperatures between -20°C to 60°C, however they may be depleted more rapidly at the high end of this range. It is recommended to store batteries within normal room temperature.



Table of Contents

Preface

About This Manual	i
Regulatory Compliance Statements	i
FCC Statement	i
Canadian Compliance Statement	i
European Conformity Statement	i
RoHS Statement	i
Laser Information	ii
Battery Notices	ii
Battery Charge Notice	ii
Storage and Safety Notice	iii

Chapter 1

Getting Started	1
Introducing the PA982	1
Features	2
Package Contents	3
A Tour of the PA982	4
Front Left View	4
Back View	5
Setting up the PA982	6
Installing the Battery	6
Charging the Battery	9
<i>Charging the Battery using the Synchronization Power Cable</i>	9
<i>Charging the Battery with the Docking Station</i>	9
<i>Checking the Battery Status</i>	10
Connecting the PA982 to a PC	11
Turning the PA982 on for the First Time	11
<i>Powering On</i>	11
<i>Calibrating the PA982 Screen</i>	12
<i>Adjusting the Screen Brightness</i>	14

Chapter 2

Using the Hardware	15
Using the Alpha Key	15
Using Hotkeys	16
Using the Stylus	16
Using the Laser Scanner	17

Chapter 3	
Getting Connected	19
Establishing Device-PC Connection	19
Installing Microsoft ActiveSync	19
Connecting the Device to Your Computer	20
Using ActiveSync to Exchange Files	20
Infrared Connection	22
Bluetooth Connection	23
Installing the WLAN Card(Optional)	27
WiFi Connection	28
Chapter 4	
Barcode Scanner Programs	30
Scanner Settings	30
Scan2Key	30
Barcode Symbolologies	31
Chapter 5	
Advanced Settings	32
Adjusting Settings	32
Checking the Main and Backup Battery Status	33
Extending Battery Life	34
Changing the Automatic Power Settings	34
Reducing CPU Speed	34
Adjusting Backlight Setting	35
Performing a Hardware Reset	36
Performing a Cold Boot	37
Performing a Cold Boot using the Boot Mode Utility	37
Performing a Cold Boot using the Hardware Reset Button	37
Appendix	
System Specifications	39

Getting Started

Introducing the PA982

Thank you for purchasing the PA982 Ultra Rugged Mobile Computer. Your PA982 was designed for users needing a compact and durable portable computer for data collection and real time transactions.

Ultra-rugged Design

The unitech PA982 Ultra Rugged Mobile Computer is a compact mobile computing device designed for maximum durability. The PA982 is compliant with IP67 to resist water and dust and is industry tested to meet harsh environmental operation requirements including underwater submersion up to one meter.

Easy to Use

The unit is equipped with large display, touch screen, and a 22-key keypad. The keypad is watertight and has high visibility backlit keys that allow for operation in dim light conditions. The PA982 supports integrated long range scanners for fast and accurate data collection.

Advanced Power Capacity

The double cell 7.4V 2200mAh battery pack support operation up to 12 hours. An optional gun grip handle includes an additional battery for operation over extended periods.

Features

Powerful system

- Microsoft Windows CE 5.0 Professional Plus operating system
- Intel Xscale PXA255 processor with speed up to 400Mhz

System memory

- 64 MB SDRAM
- 64 MB Flash ROM

Display

- 3.5-inch QVGA LCD touch-sensitive screen
- 320 x 240 resolution

Barcode scanner

- Built-in Bar Code Scan Engine
- Long range capacity (optional)
- RFID reader (optional)
- Symbol SE1200 support
- UNITECH HAMSTER barcode decoder

Expansion slot

PCMCIA Type II slot

Wireless connectivity

- 802.11b/g (optional)
- Bluetooth wireless technology
- Infrared port

Communication

- USB Host & Client
- IrDA 1.2 (SIR) using the cradle
- GSM / GPRS (via expansion slot)
- VOIP support
- 802.11b/g (optional)
- Bluetooth version 1.2 (supports Bluetooth Printer, Bluetooth Modem, Bluetooth ActiveSync)

Battery life



- Batch usage with 50% backlight: 12 hours
- Charging time: 4 hours
- Embedded backup battery cell

User-friendly interface

- Quick launch hot keys for accessing often used system applications, calibration, and other device management tasks
- Keys for barcode scanning

Package Contents

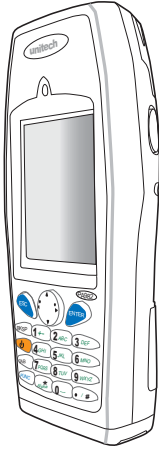
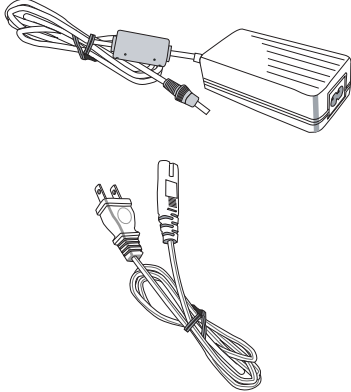
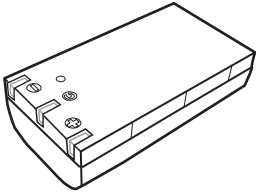
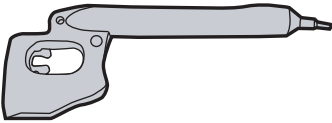
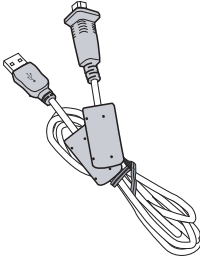
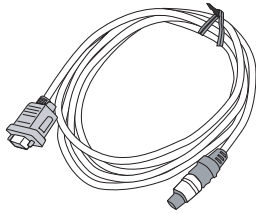
After opening the box, ensure the following accessories for the PA982 are present:

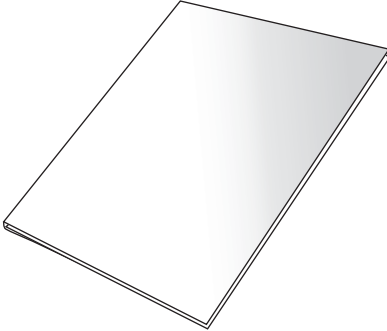
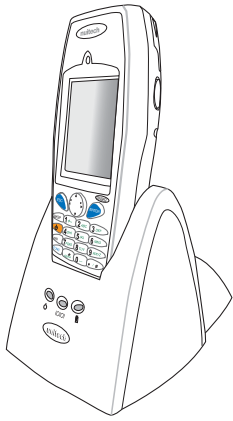
		
PA982 Terminal	Power Adapter and Cable	Battery Pack
		
Stylus	USB Cable (optional)	Synchronization and Power Cable
		
CD-ROM	Quick Reference Guide	Cradle (optional)

If anything is missing or appears damaged in any way, contact your dealer.

A Tour of the PA982

The following sections describe the main components and features of the PA982.

Front Left View

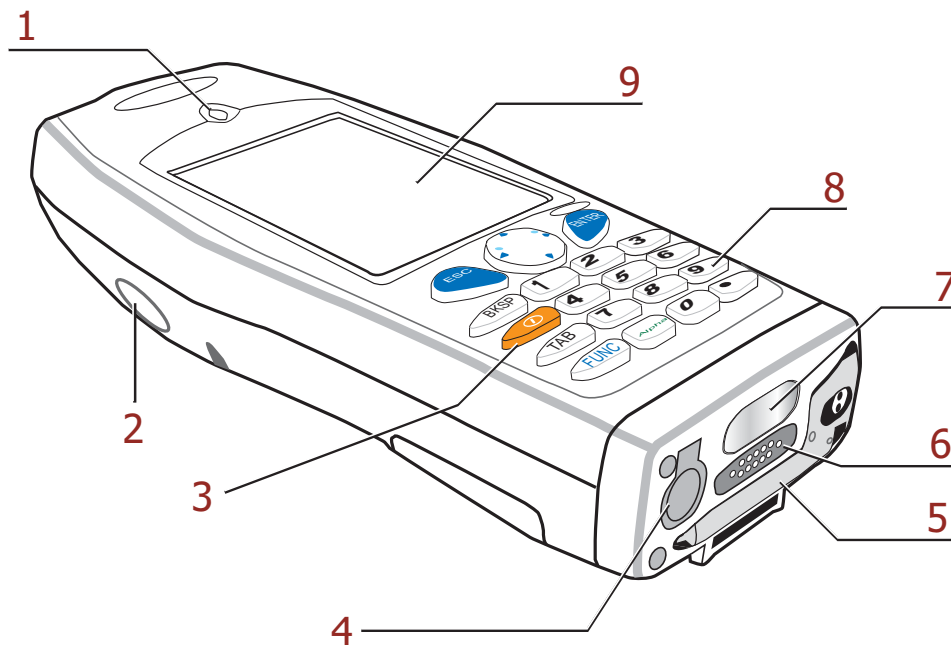

No.	Component	Description
1.	Status indicator	Indicates the battery charging and barcode scanning status. Green - Battery is fully charged or barcode scanning process is completed without error. Red - Battery is charging, barcode scanner is fired/activated.
2.	Left scanner trigger button	Press to activate the barcode laser scanner.
3.	Power button	If the device is off, press this button to turn it on. Alternatively, when the unit is on, this key must be pressed and held down for about two seconds in order to turn the device off.
4.	Universal connector	Connects your device to a synchronization power cable. This cable connects to the computer's com port and accepts the 12V AC adapter to provide power to the PA982. See page 9 for further instructions. The unit can simultaneously recharge and perform an Activesync operation.
5.	Stylus	Enables you to interact with the operating system. To use the stylus, remove it from its holder and hold it the same way you hold a pen or pencil.
6.	Desktop cradle connector	Enables you to interface with the optional desktop cradle.

7.	Infrared (IR) port	Uses infrared technology to transmit and receive data from other IR-enabled devices.
8.	Keypad	Keypad interface for controlling the PA982. See <i>Using the Hardware</i> on page 15 for more information.
9.	LCD Touch screen	Displays the applications and data stored on your device. It is touch-sensitive and responds to the stylus or finger.

Back View

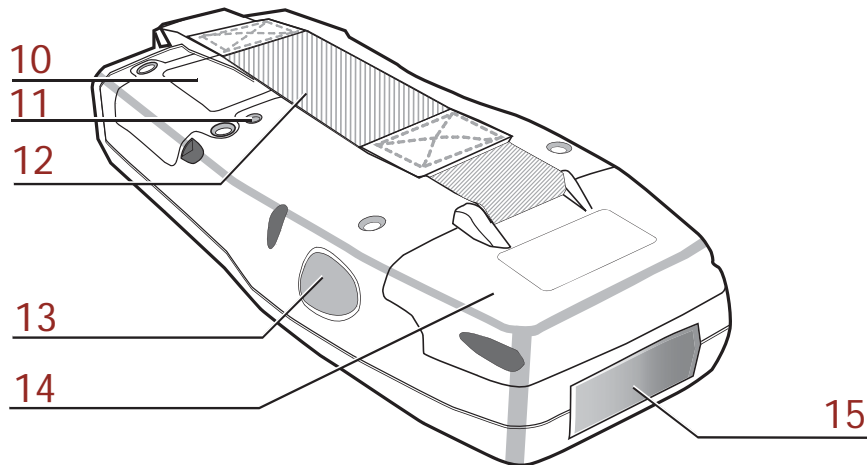

No.	Component	Description
10.	Battery compartment	Houses the removable and rechargeable 7.4V 2200mAh lithium-ion battery pack
11.	Reset button	Press the end of the stylus into the button to reset your device.
12.	Handstrap	Enables you to securely hold the PA982 while using it.
13.	Right scanner trigger button	Press to activate the barcode laser scanner.
14.	PCMCIA compartment	Open this compartment to access the PCMCIA slot.
15.	Barcode scanner window	Window where scan laser pass thru.

Setting up the PA982

This section explains how to install and charge the battery, how to check battery status, how to connect the PA982 to a PC, how to turn on the PA982 for the first time, how to install a PCMCIA card, and how to calibrate the screen.

Installing the Battery

WARNING! There is a risk of fire and burns if the battery pack is handled improperly. DO NOT disassemble, crush, puncture, short external contacts, or dispose the battery pack in fire or water. DO NOT attempt to open or service the battery pack. Dispose of used batteries according to local recycling guidelines in your area.

A backup battery cell is embedded into your device to prevent data loss in instances when the removable battery pack is removed or completely discharged. The backup battery will keep the data and system setting for up to 6 hours if the main battery is removed.

NOTE:

- To enable the internal battery cell to provide backup power supply, charge your device with the main battery pack for at least 16 hours.
- The first time you use the PA982, you must turn on the backup battery switch.
- The first time you use the PA982, you must activate the LCD heater switch. When activated, LCD heater will turn on automatically when the temperature is lower than -10°C.

1. Open the battery compartment by removing the four screws that secure the battery compartment cover (A) and removing the cover (B).

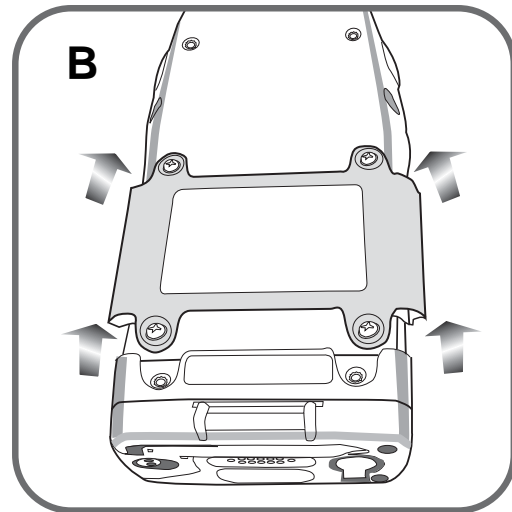
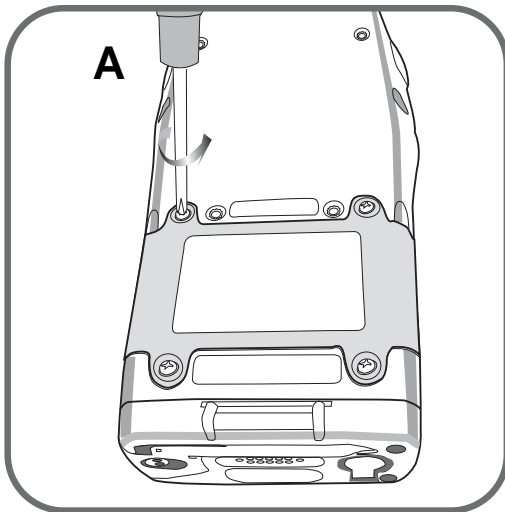

2. Locate the backup battery switch and LCD heater switch and turn them on.

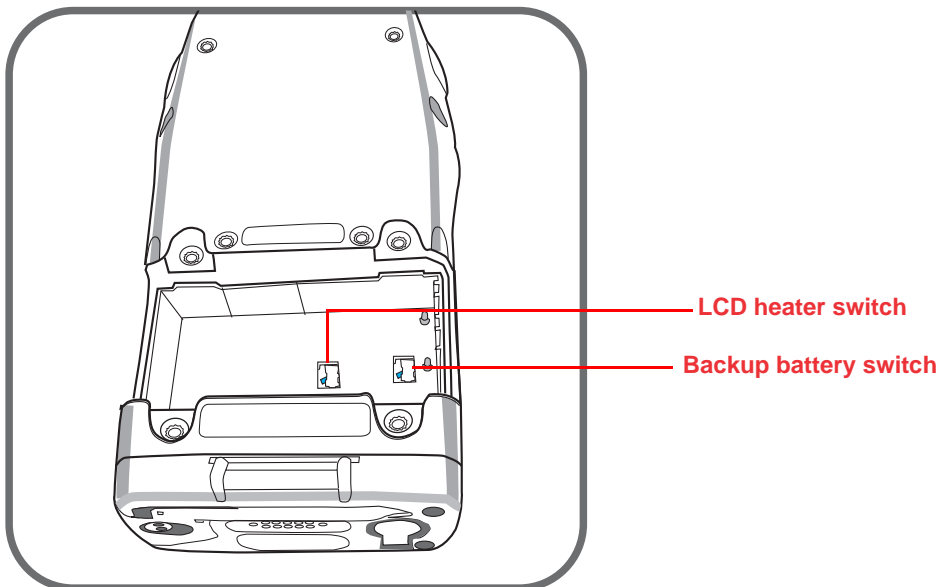

3. Position the battery pack, make sure the battery contacts are aligned with the contacts in the compartment, as shown in the following illustration.

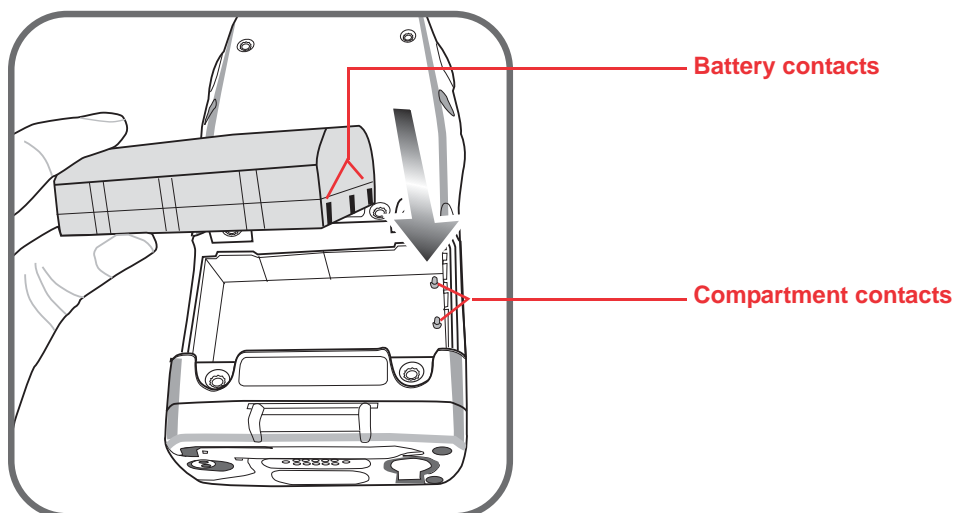

4. Place the battery pack into the battery bay and press the battery securely into the compartment.

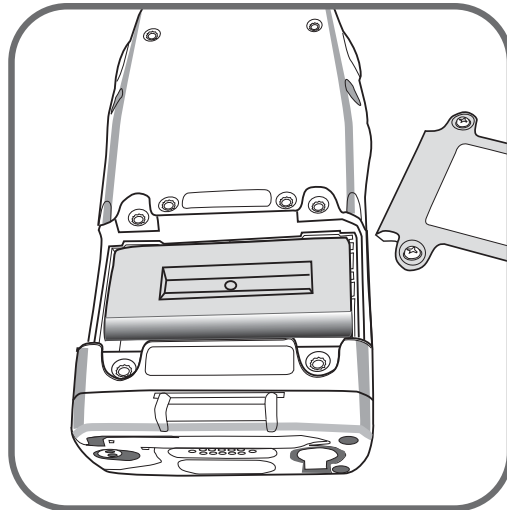

5. Replace the battery compartment cover and the four compartment screws.

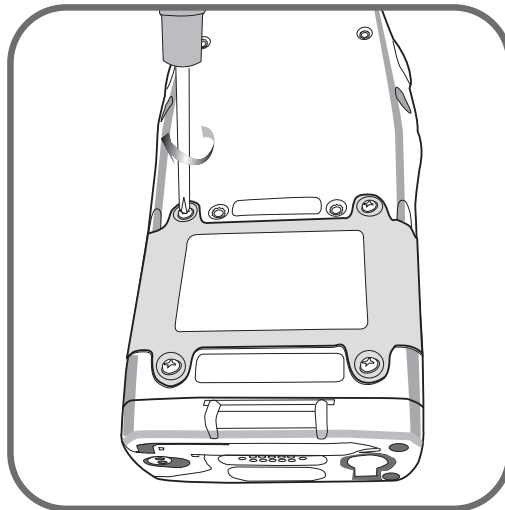

Charging the Battery

Before using the PA982 for the first time, you need to charge it for about 16 hours. After that, you can charge the PA982 every day to recharge the battery to full capacity. Charge the PA982 using the synchronization power cable or the docking station.

CAUTION! Operating the PA982 for the first time without the AC adapter, and without fully charging the backup battery may result in loss of data stored in RAM memory.

When the main battery is removed, the backup battery retains RAM data in memory for 6 hours; charge the battery as soon as possible to avoid the data loss in RAM memory.

Charging the Battery using the Synchronization Power Cable

1. Connect the synchronization power cable connector to the PA982 (1).
2. Plug the AC adapter cable into the power jack on the RS232 serial connector (2).
3. Connect the AC adapter into an electrical outlet (3).

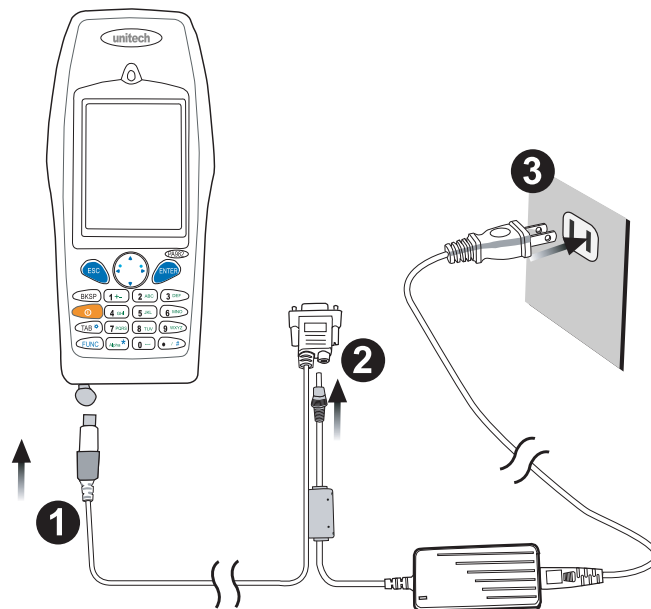

Charging the Battery with the Docking Station

1. Plug the AC adapter cable into the power jack on the docking station, then connect the AC adapter into an electrical outlet.

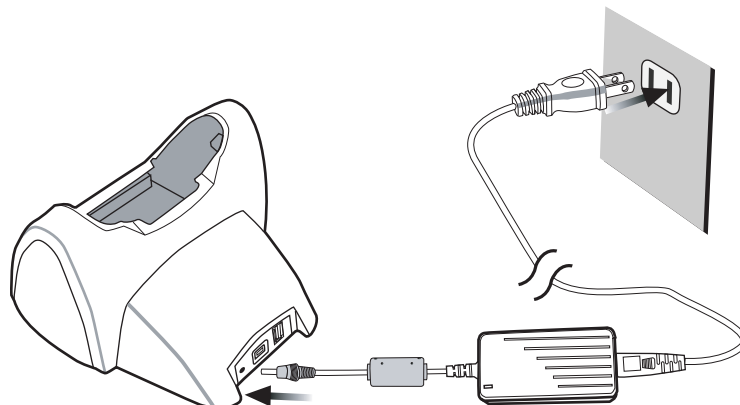



- Slide the device into the docking station until it clicks into place.



- The connection is secure when the bottom edge of the device is aligned with the docking station, and the LED indicator on the device lights up red.

LED Status

	LED		Meaning
PA982	Solid Red		Charging
	Solid Green		Charging complete
Docking Station		Power LED	Power is on
		Charging LED	Charging
		Sync LED	Synchronization is taking place Note: This LED is only applicable in the RS232 model.

Checking the Battery Status

If the main battery level becomes low in the course of normal use, a status icon  appears on the device screen system tray indicating low or very low battery status. In both cases, perform an ActiveSync operation to back up your data, then recharge your device as soon as possible.

If the battery level reaches a low status, the device will enter sleep mode and cannot be powered up until the battery is charged.

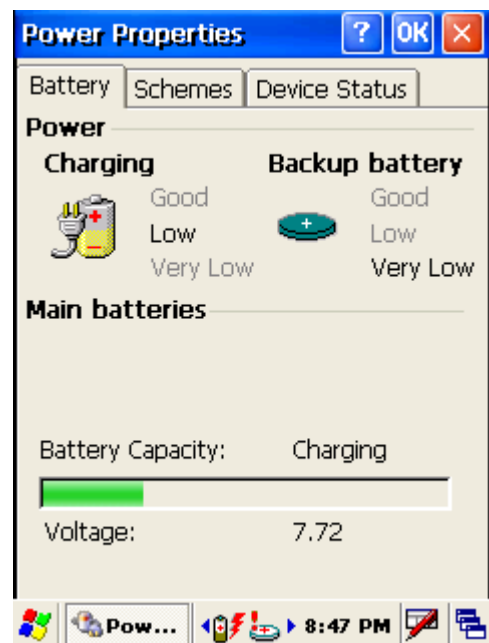

Main battery icon

Backup battery icon

Connecting the PA982 to a PC

Use the synchronization power cable to connect the PA982 to a PC to use with Active-Sync.

1. Connect the RS232 connector jack to the PA982 (1).
2. Plug the RS232 serial connector into a serial port on the PC and connect the AC adapter into the RS232 connector (2).
3. Connect the AC adapter into an electrical outlet (3).

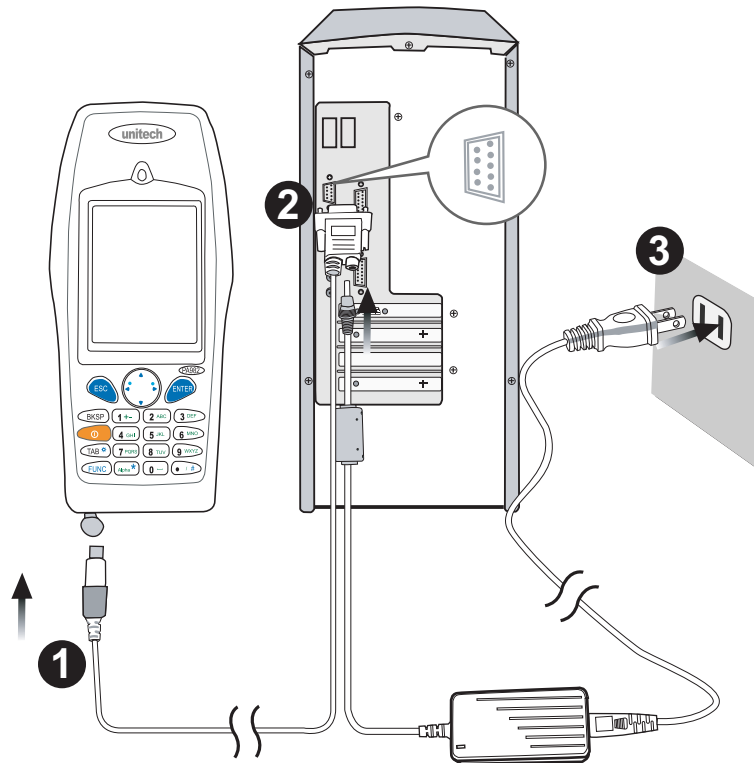

Turning the PA982 on for the First Time

After you have initially charged your device for about 16 hours, the device is ready to be used. You can now start up your device where you'll adjust the screen brightness, calibrate the display, and set up the system time zone, date and time.

Powering On

1. Turn on your device by pressing the power button on the front panel.

NOTE: The PA982 screen ships with a protective plastic film. You may remove this if desired by peeling from one corner. The screen will be more susceptible to scratching without the film, but will be more readable.

2. The unitech PA982 welcome screen appears for a moment followed by the calibration screen.

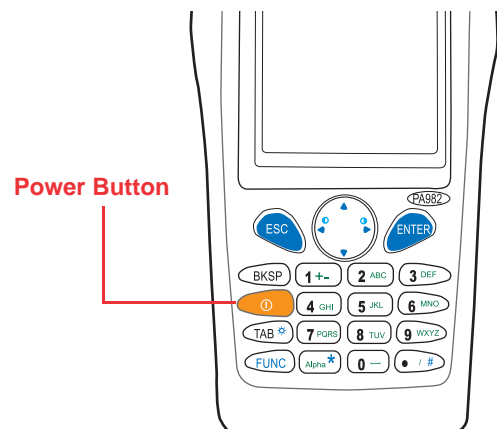

Calibrating the PA982 Screen

The calibrate screen automatically appears when the unit is powered-on for the first time or after the system is reset.

There are 2 ways to calibrate the screen:

A. Press Func Key + ESC Key.

B.

1. Tap **Start** → **Settings**, tap the **Control Panel** tab
2. Tap the **Stylus** icon.

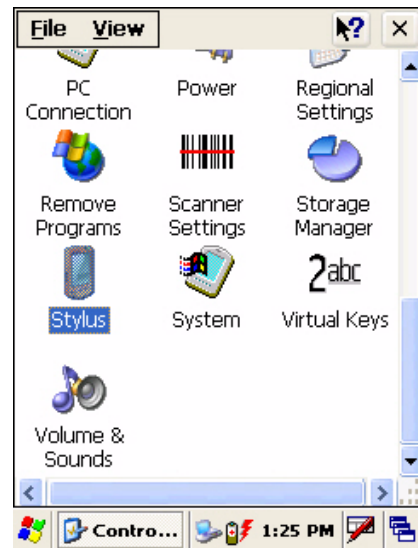

The Stylus Settings window appears.
This window enables you to calibrate the screen.



3. Tap **Recalibrate** to calibrate the screen.
The align screen window appears.
4. Tap the cross hair firmly and accurately.

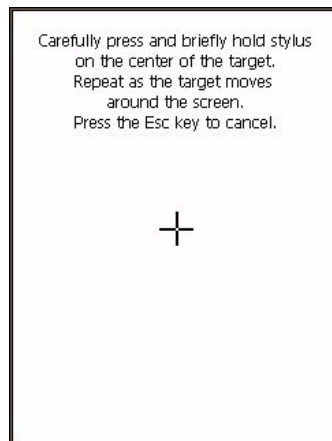

The cross hair moves to the next location.

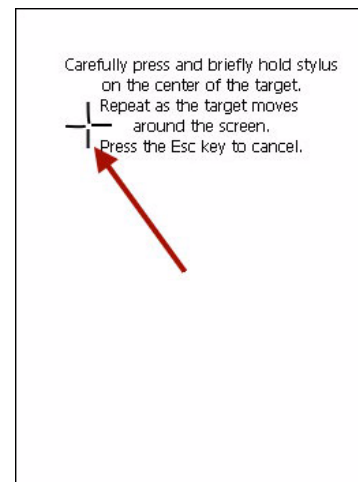

5. Continue tapping the cross hairs until the screen has been calibrated.

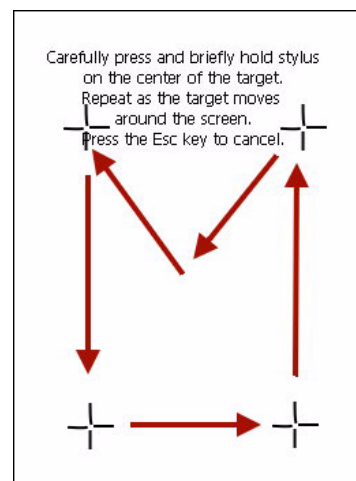

Adjusting the Screen Brightness



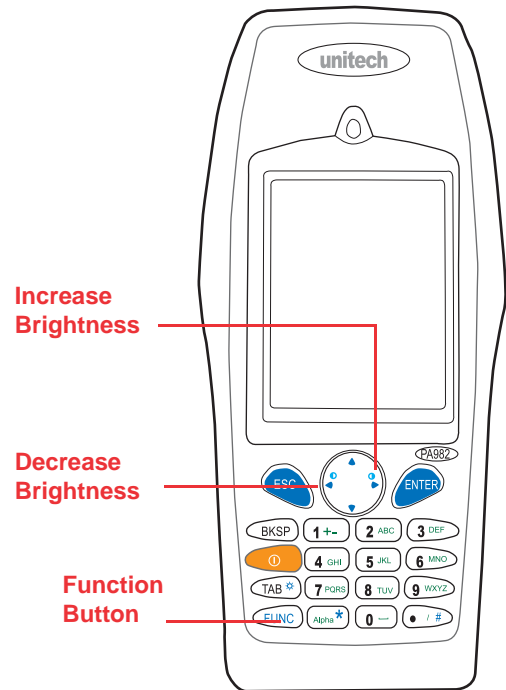





Adjust the screen brightness by pressing the Function button [FUNC] to enable the soft keys and pressing the left (decrease brightness) or right (increase brightness) cursor buttons.



Chapter 2

Using the Hardware

The following table describes the main keypad keys.

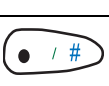
Key	Main Function
	Press this button to turn the PA982 on. Press and hold this button for two seconds to turn the PA982 off.
	Pressing this button corresponds to tapping the cancel or X button on the screen.
	Press the backspace key to erase characters.
	Press the function key to perform alternative key functions. Refer to <i>Using Hotkeys</i> on page 16.
	Use the tab key to toggle between fields or to tab forward in word processing applications.
	Press the enter key to confirm an action or entry by the user.
	Use the cursor keys to navigate in applications. Press and hold the Function key and then press the right and left arrows to raise and lower the screen brightness.
	Press the alpha key to toggle between numeric and alphabetic entry modes. This key also toggles between upper and lower case alphabetic characters.
	Press these keys to enter numbers or characters depending on whether the Alpha key has been pressed. Press the 0 key to enter a space.
	Press this key to add punctuation.



Using the Alpha Key

When the PA982 boots, the default condition is Numeric Mode on. When you toggle to Alpha Mode, the default condition is CAPS mode off.

Alpha Mode	Press alpha to alpha mode, the default condition is CAPS off.
CAPS	Press Alpha key twice to toggle CAPS

Using Hotkeys

The PA982 provides eight combination hot keys to activate specified screen setting functions or programs. These hotkeys are useful for calibrating the touch screen, toggling the backlight, and adjusting screen contrast when the menu-driven operation is disabled. Below is the list of hotkeys. To use them, press and hold the [FUNC] key in combination with the corresponding second key.

[FUNC] + [ESC]	Re-calibrate the touch screen.
[FUNC] + 	Decrease screen brightness
[FUNC] + 	Increase screen brightness
[FUNC] + [TAB*]	Toggle screen and LCD backlight.
[FUNC] + [6]	Open the Task manager
[FUNC] + [7]	Scanner Setting.exe
[FUNC] + [8]	Open the Power Properties dialog
[FUNC] + [9]	Open System Information
[FUNC] + [0]	Space
[FUNC] + [Cursor▲]	Toggle Display Backlight
[FUNC] + [Cursor▼]	Toggle Keypad LED Backlight

Using the Stylus

CAUTION! Never use anything other than the PA982 stylus on the screen. Using another object as a stylus could cause permanent damage.

1. Slide the stylus in the direction of the arrow (A) and then pull out (B) to remove the stylus from its holder.

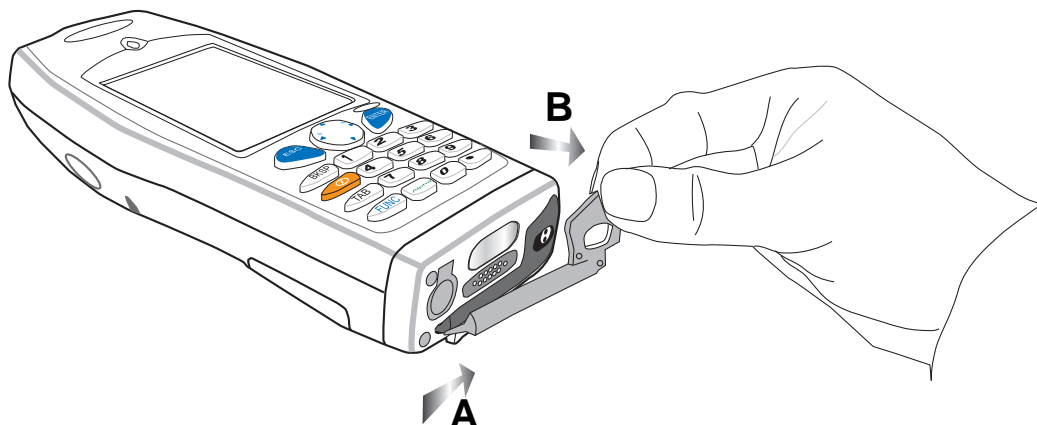

2. Hold the stylus as holding a pencil.
3. To make a choice from a menu, lightly tap the tip of the stylus on that choice.
4. To write data into a field on a form, use the stylus to print the letters or numbers.

Using the Laser Scanner

The PA982 has an integrated laser scanner which reads all major bar code labels with excellent performance.

NOTE: Reading software must be enabled in order to operate the scanner. This can be a user-loaded application or a pre-loaded utility such as Scanner Setting or Scan2key.

Activate the laser scanner by pressing either one of the trigger keys located on the left and right side of the unit.

The PA982 has a built-in Scanner Setting utility that allows you to test the device's barcode scan function.



1. To launch Scanner Settings, press [FUNC] + [7].

NOTE: Alternatively, tap **Start** → **Settings** → **System** → **Scanner Settings**.

2. The Scanner Control Panel opens.

From here you can configure barcode scanner parameters such as enabling or disabling barcode symbologies, setting data transmission options, configuring magnetic and proximity reading options, and setting power management options.

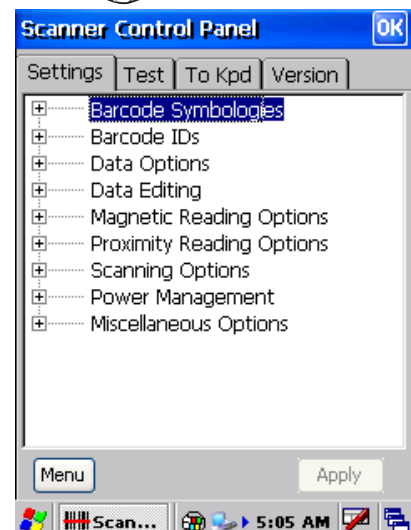

3. To test the barcode scanner, tap the Test tab.

4. Tap **Tools**

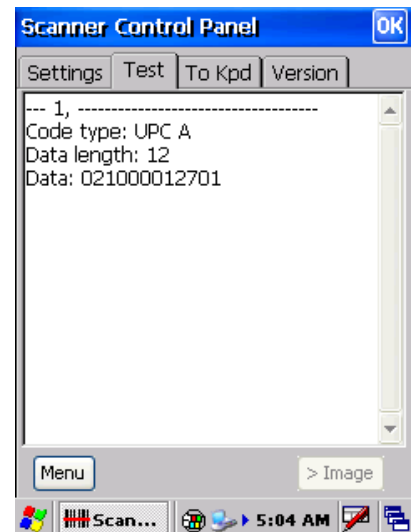

5. Tap **Enable Scan**.
6. To perform auto scan, Tap **Tools** → **Auto Scan** → Start **Auto- Scan**
7. Choose Interval : 3 secs
8. Tap : **Start**
9. Laser scans every 3 seconds and barcode is scanned automatically.
10. Tap **Tools** → **Auto-Scan** → **Stop Auto-Scan**
11. To enable the scanner outside of the test tab, user must enable **Scan2Key.exe**. This can be done via the **To Kpd** tab.
12. Check the box labeled “**Start Scan2Key When Exit**” and tap **OK** at the top right. The scanner will be enabled and scans will be directed to the keyboard buffer.

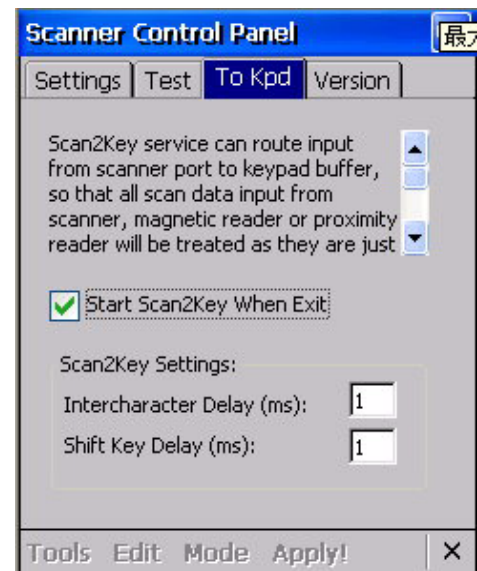
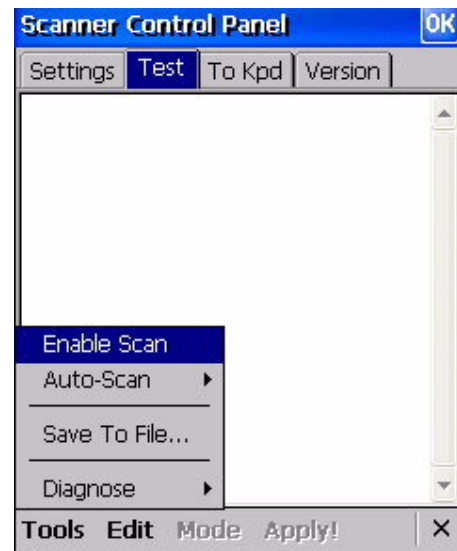

Getting Connected

The unitech PA982 enables users to link to a host computer using an RS-232, IrDA, or WLAN connection for data communication. This chapter provides an overview of PA982 communication options.

Establishing Device-PC Connection

Installing Microsoft ActiveSync

In order to exchange data between your computer and the PA982, Microsoft ActiveSync must be installed on your computer. Use the RS232 serial/charging cable that comes with your device or the docking station to connect the device to your computer.

NOTE: If you have a previous version of the Microsoft ActiveSync installed in your computer, uninstall it first before installing the latest version of Microsoft ActiveSync. The PA982 Ultra Rugged Mobile Computer requires ActiveSync version 4.2 or higher.

To install Microsoft ActiveSync on your computer:

1. Close any open programs, including those that run at startup, and disable any virus-scanning software.
2. Download the ActiveSync software from the Microsoft ActiveSync Download page at <http://www.microsoft.com/downloads/details.aspx?FamilyID=7269173a-28bf-4cac-a682-58d3233efb4c&DisplayLang=en>
3. Browse to the location of the downloaded file, and double-click it. The installation wizard begins.



4. Follow the instructions on the screen to install Microsoft ActiveSync.

Connecting the Device to Your Computer

1. After ActiveSync has been installed, connect the PA982 to your PC as described in *Connecting the PA982 to a PC* on page 11.
2. Turn the PA982 on.
3. ActiveSync starts automatically and configure the USB port to work with the PA982. The New Partnership setup wizard automatically starts.

NOTE: If ActiveSync doesn't start automatically, click **Start** → **Programs** → **Microsoft ActiveSync**. If a message appears indicating that it is unable to detect a connection, click the **Cancel** button and manually configure the communication settings.

4. Follow the onscreen instructions.
5. When the configuration process is complete, the ActiveSync window appears.

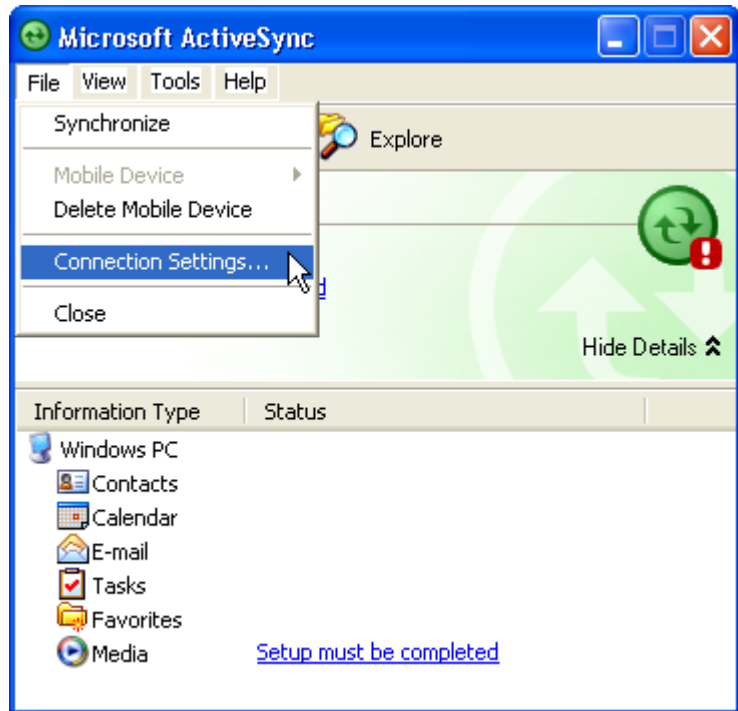

6. Synchronization will be initialized and will take place if you've chosen to synchronize periodically or upon connection.

NOTE: Your computer can create a partnership with multiple PA982s. Also, a PA982 can create a partnership with up to two computers.

Using ActiveSync to Exchange Files

You can use ActiveSync to exchange information from your device your computer and vice versa. Changes you make to the information on one location will not affect the information on the other one. If you want to automatically update information on both your device and computer, synchronize the information instead.

You can copy two types of information to your device: files and Pocket Access Windows CE Store information.

The following procedure only applies to copying files. Refer to the ActiveSync Help on your computer for instructions on how to copy Pocket Access Windows CE Store information.

NOTE: Files created on your computer may need to be converted by ActiveSync so that they can be viewed and edited on your device, and vice versa.

To copy files:

1. Connect your device to your computer.
2. In ActiveSync on your computer, click **Explore**.

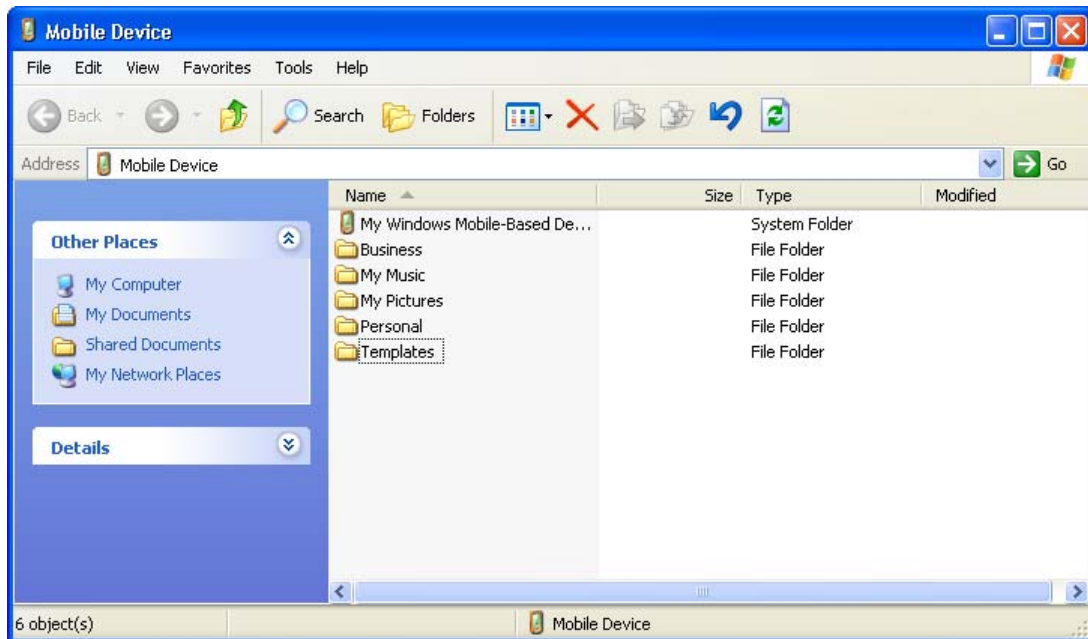

3. Locate the file that you want to copy on your device or computer.
4. Do either one of the following:
 - To copy the file to your device, right-click the file and click **Copy**. Place the cursor in the desired folder for your device, right-click, then click **Paste**.
 - To copy the file to your computer, right-click the file and click **Copy**. Place the cursor in the desired folder for your computer, right click, then click **Paste**.

Infrared Connection

The infrared port allows you to synchronize information with an infrared enabled computer. Align the infrared port of your device with the infrared port on the computer.

This method is ideal for quickly switching between multiple devices since there are no cables or adapters to change.

1. Perform the steps below on your computer:
 - a. Configure an infrared port on your computer following the manufacturer's instructions.
 - b. Once your computer's IR port is ready, open ActiveSync.
 - c. Click **File** → **Connection Settings**.

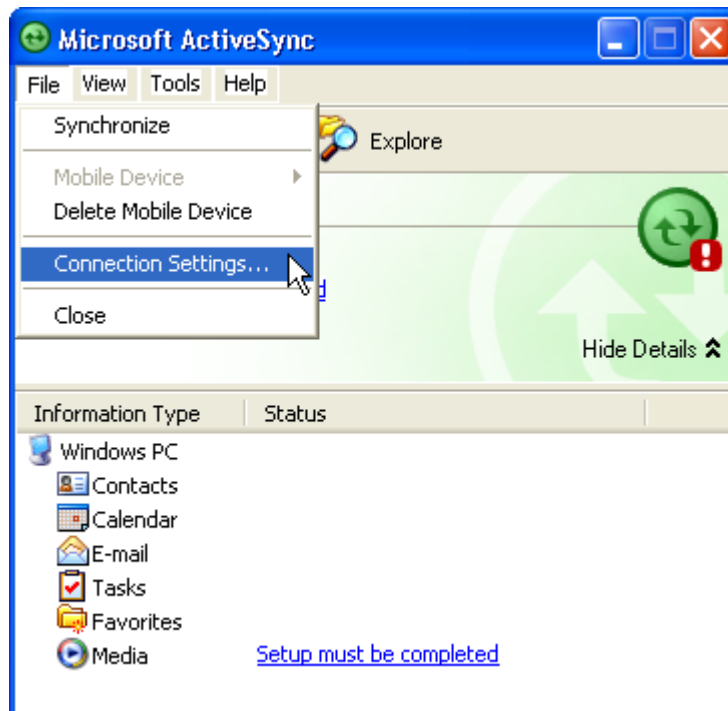

- d. Check **Allow connections to one of the following** and select **Infrared Port (IR)** from the drop-down list.
 - e. Click **OK**.

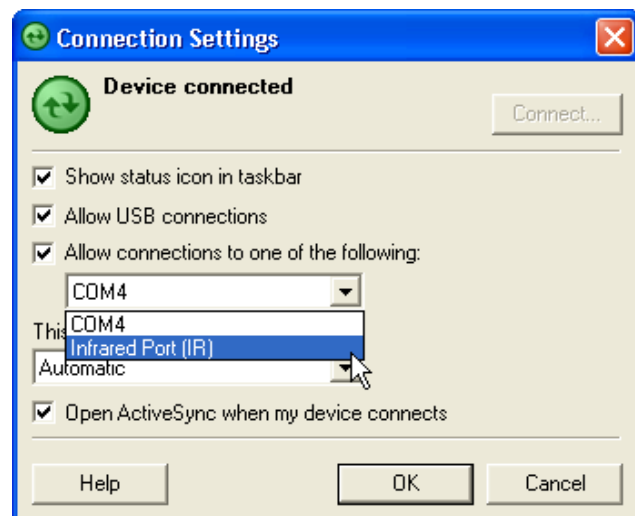

2. Perform the steps below on your device:
 - a. Align the IR port of your PA982 with the IR port on your computer so that they are unblocked and within close range.
 - b. Initiate connection by tapping **Start** → **Settings** → **Control Panel** → **PC Connection**.
 - c. Select **Enable direct connections to the desktop computer** using this check box.
 - d. Tap the **Change Connection**.
 - e. Select **IRDA**.
 - f. Tap **OK**.

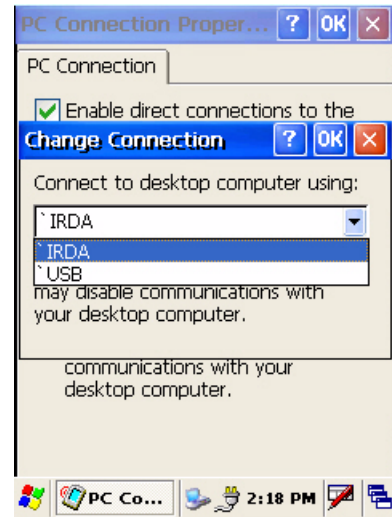

Bluetooth Connection

Your device is equipped with Bluetooth wireless technology that you can use to synchronize information with a computer equipped with a Bluetooth adapter or access point. Bluetooth wireless technology allows you to communicate with the computer whenever it is within range.

Follow these instructions to set up a Bluetooth connection.

1. Tap **Start** → **Programs** → **Bluetooth** → **BTPowerON** and check **Turn on Bluetooth module**. Tab **OK**.

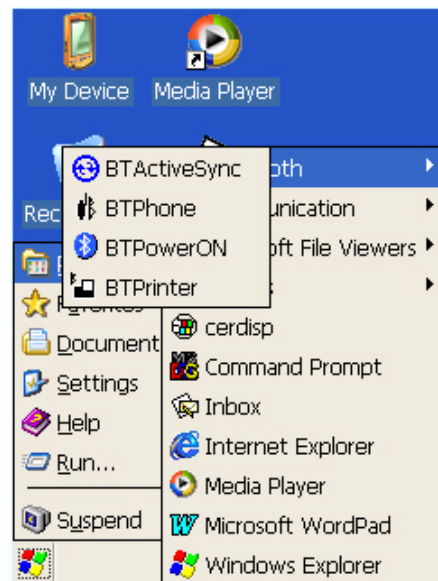
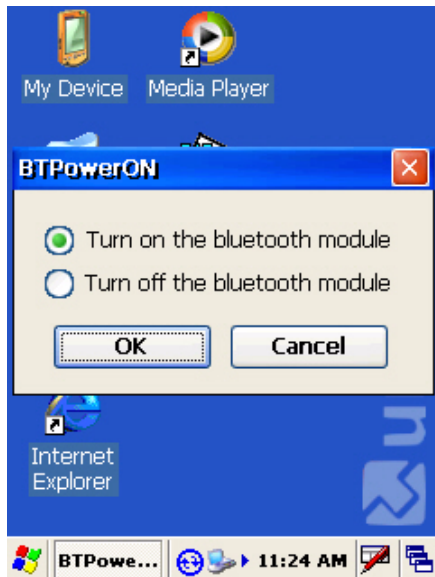

2. Tap **Start** → **Settings** → **Control Panel** → **Bluetooth Device Properties.**

3. Tap **Scan Device.**

4. Select a device from the list and select **Trusted.**

You are prompted for a passkey.

5. Enter the Passkey.

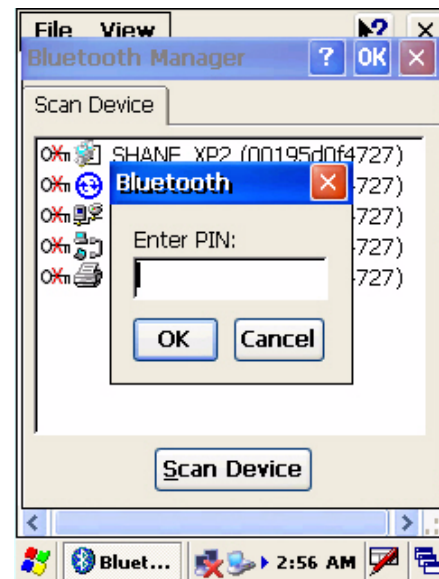
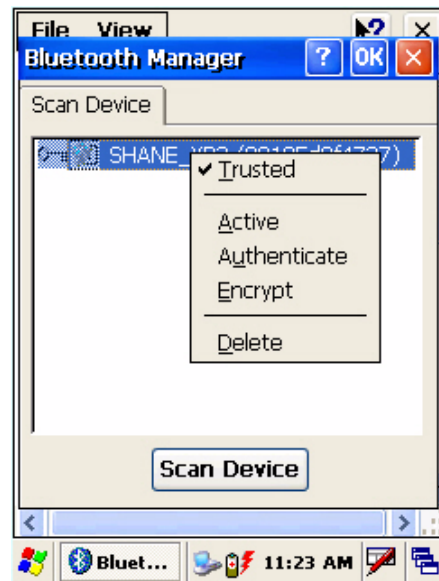

On the PC screen, you are prompted to enter the Bluetooth PIN Code Request.



6. Enter the same Bluetooth PIN Code as you entered in step 4.

7. On the PA982 select a device from the list and select **Active**.

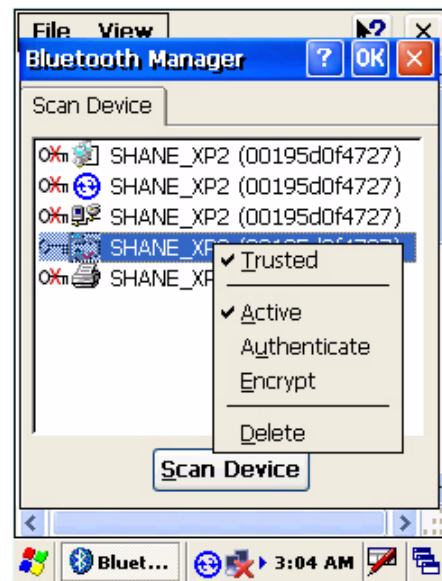

8. On your PC, click **ActiveSync** → **Connection Setting** → **Select your BT COM Port** → **OK**

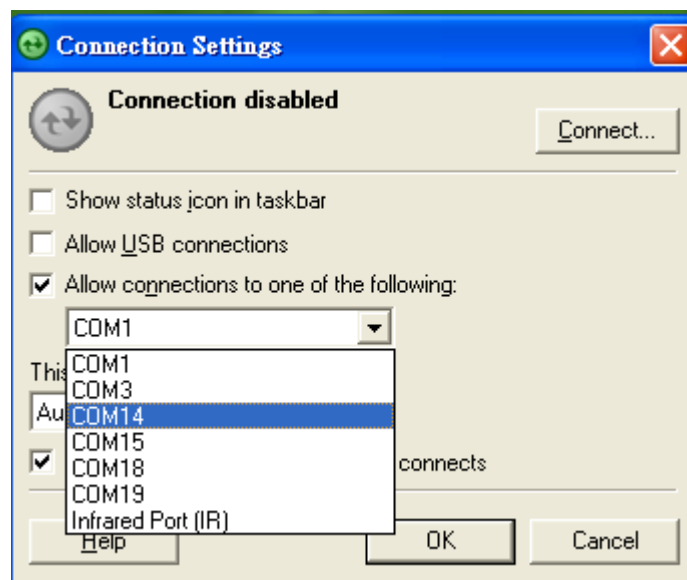

9. On the PA600 tap Start --> Program --> Bluetooth --> BTActiveSync.

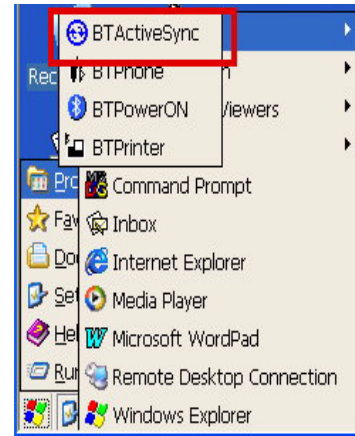

10. An icon appears on the taskbar. Double tap the icon.

11. You will see the Activesync window pops up. Tap **More**

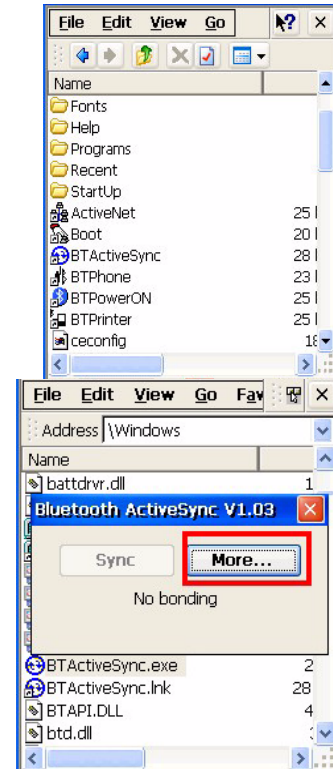

12. Tap **Inquiry**. Select the bluetooth device you want to sync. Tap **OK**.



13. Tap BTActiveSync icon again. Tap **Sync**.
14. Activesync begin.

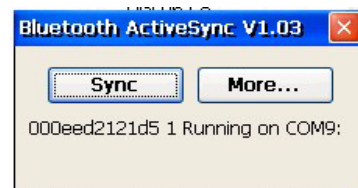

Installing the WLAN Card (Optional)

You can install an optional Wireless Local Area Network (WLAN) Card in the PA982 to provide wireless network function. Follow these instructions.

1. Remove the two screws securing the WLAN compartment cover.
2. Slide the WLAN card module into the PA982 as shown until the card's contacts are firmly connected.

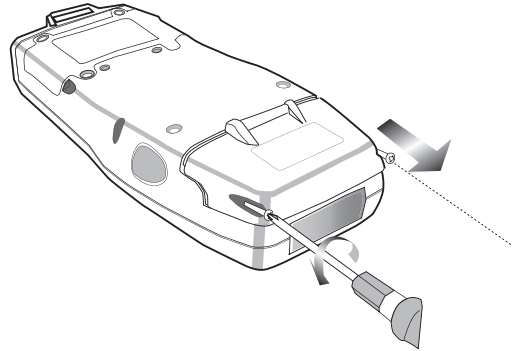
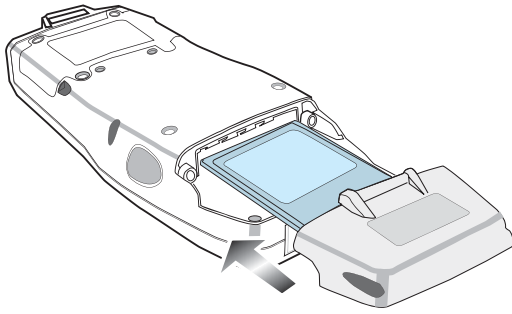

3. Replace the WLAN compartment cover screws.

NOTE: WiFi access requires a separate purchase of a service contract with a wireless service provider. Contact a wireless service provider for more information.

WiFi Connection

Unitech terminals come with built-in RF facility. This chapter guides the user on how to setup the RF setting.

1. Double tap the **Summit Client Utility**.



2. Under "Main" tab, for **Active Profile**, select "**ThirdPartyConfig**".



3. A Power Cycle is required to make settings activate properly. Tap "OK".



4. Tap "OK".



5. Warm Start the terminal



6. Once the RF card is detected, you will see the RF setting window pop up.

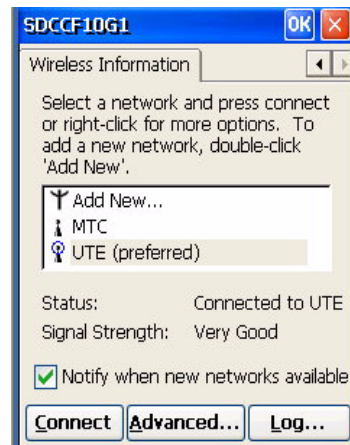

7. Tap "Add New"(Or double tap your preferred network) to add a new SSID.

8. Enter the SSID. Uncheck "The key is provided automatically".Enter the network key.

9. Tap OK. Start to search for RF signal and the RF is connected.

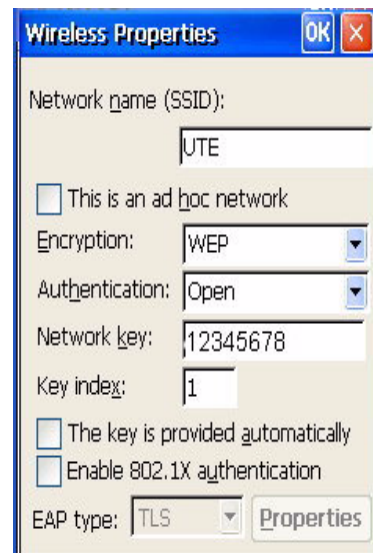

Barcode Scanner Programs

Scanner Settings

When it is necessary for the user to change the default barcode symbology for a different application, the Scanner Control Panel provides the ability to change default symbology, place delimiter characters behind scanned data, and save the settings.

Press [FUNC] + 7 to display the Scanner Control Panel.

NOTE: Alternatively, tap **Start** → **Settings** → **System** → **Scanner Settings** to display the Scanner Control Panel.

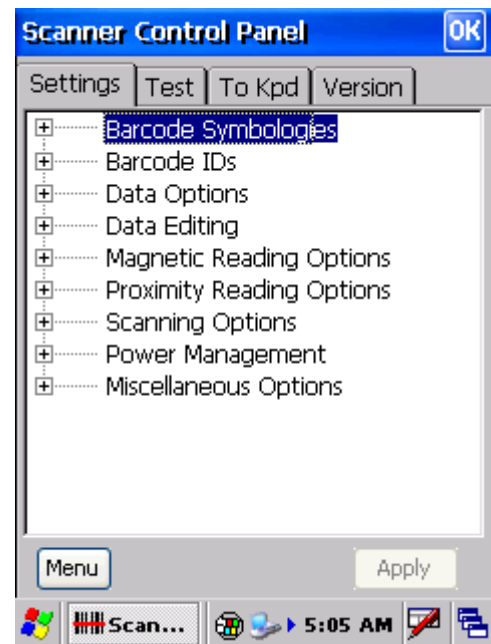

Scan2Key

The Scan2Key application routes input from a scanner port to a keypad buffer, making all input from the scanner emulate input from the keypad. Using Scan2Key, scanned data will be directed from the scanner port to any waiting (active/focused) text editor such as MS Mobile Word or a text box in an application.

Press [FUNC] + [7] to display the Scanner Control Panel, then tap **To Kpd** to access Scan2Key settings.

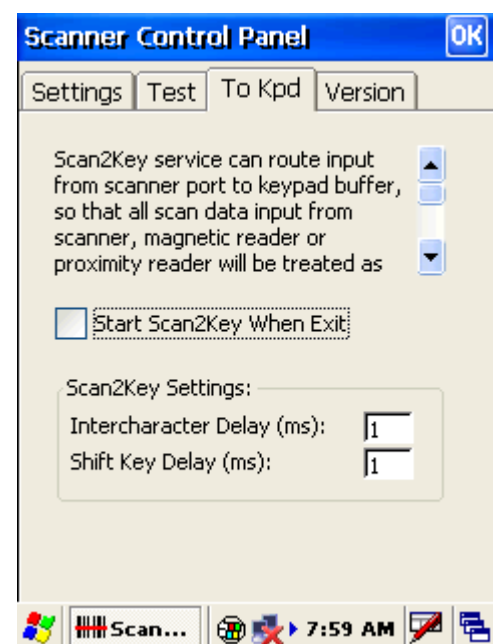

Barcode Symbologies

Symbology	Enable/Disable	Check Char/Digit verification	Transmit Check Char/digit	Max/Min Length	Transmit Leading Digit	Other
Bookland EAN	YES	—	—	—	—	—
Codabar	YES	YES	YES	—	—	Transmit Start/Stop bits, CLSI format, *data length
Code 11	YES	—	YES	—	—	* check digits, *data length
Code 128	YES	—	—	—	—	*data length
Code 32	YES	—	—	—	YES	Transmit Tailing digit
Code 39	YES	YES	—	—	—	For ASCII, Transmit Start/Stop bits, Function Code, Double label decoding, *data length, *double labels separator
Code 93	YES	—	Yes	—	—	*data length
Deta Code	YES	YES	YES	—	—	—
EAN 128	YES	—	Yes	—	—	Transmit Code ID, * Field separator
EAN 13	YES	YES	—	—	YES	—
EAN 8	YES	YES	—	—	YES	* Not suppress first or last digit, *data length
Interleaved 2 of 5	YES	YES	YES	—	—	Fixed Length, * Not suppress first or last digit, *data length
Label Code IV&V	YES	—	YES	—	—	—
MSI/Plessey	YES	—	YES	—	—	* Check digit double module 10, * data length
Standard 2 of 5	YES	YES	YES	—	—	Fixed Length, *Data Length
Telpen	YES	—	—	—	—	*Standard Character Set
UPC A	YES	—	YES	—	YES	—
UPC E	YES	—	YES	—	YES	Zero Expansion, NSC
UPC/EAN Group	—	—	—	—	—	Supplement 2, Supplement 5, Insert Space before supplement, most have supplement, *Add-on code try level

Note: *Value Adjustable Scanner Control Panel V3.0

Advanced Settings

Adjusting Settings

This section describes how to adjust the settings of your device to accommodate your work habits.

To access Settings, tap **Start** → **Settings** → **Control Panel**.

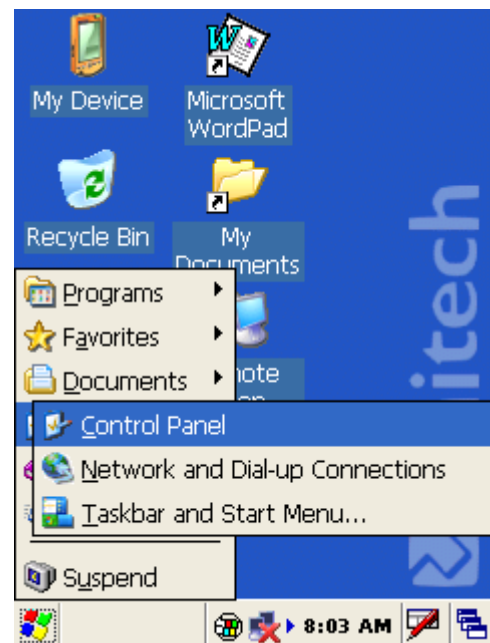

The Control Panel appears.

From here you can adjust such user configurable items as the backlight, auto power off timer, system volume, and processor speed. You can also assign functions to buttons, configure menus, enter owner information, and set up connections.

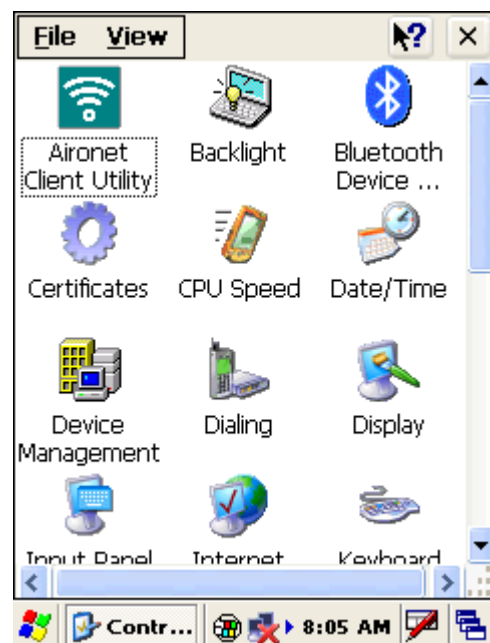

Checking the Main and Backup Battery Status

This section describes how to view the power level for both the main and backup battery. To minimize power consumption, you can define settings for the auto-off function and the processor's operation speed.

To check the main and backup battery status:

1. Tap **Start** → **Settings** → **Control Panel** → **Power**:

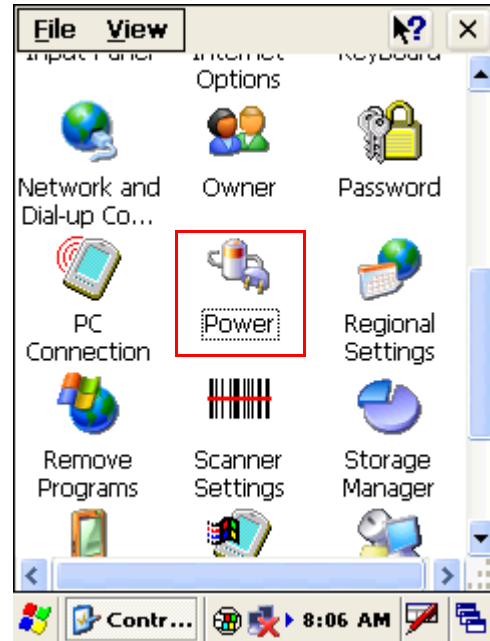

The Power Properties screen appears.

2. The battery menu item displays the status of the main and backup batteries.

On the screen shown here, the main battery is good, but the backup battery charge is very low. You should charge the backup battery as soon as possible in this case.

NOTE: It is necessary to charge the battery when the battery charge reaches below 10%. If the battery does not accept a charge, contact unitech Technical Support.

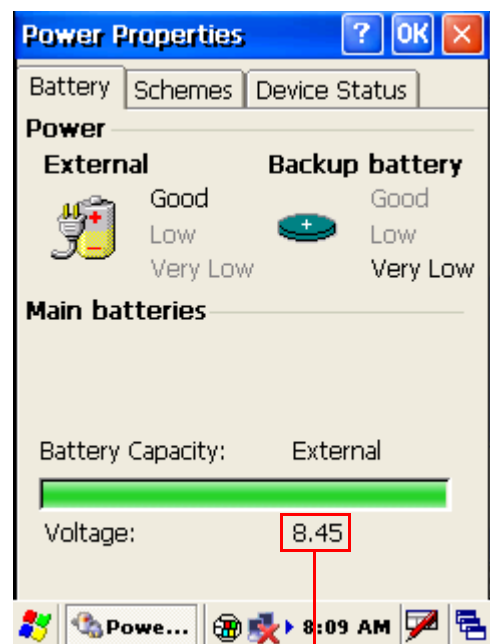

Main battery voltage

Extending Battery Life

You can extend the PA982 battery life by doing either of the following:

- Changing the automatic power settings
- Reducing CPU speed
- Minimizing the use of backlight

Changing the Automatic Power Settings

The PA982 enters idle mode when there is no task, or all tasks are waiting for input. In the default setting, the PA982 enters User Idle mode when there is no user input after one minute. The remains idle for 3 minutes and when there is no external charging power connected. Pressing the power button returns the PA982 to the same point at the time of automatic shutdown.

To change the automatic power settings:

1. In the Power Properties screen tap the **Schemes** tab.
2. Tap the automatic shut off time arrow to select from a list of time periods for the following modes:

- **User Idle:** the PA982 switches to User Idle mode when there is no user input after the selected time.
- **Switch state to System Idle:** the PA982 switches to from User Idle mode to System Idle mode when the system is inactive after the selected time.
- **Switch state to Suspend:** the PA982 switches from System Idle mode to Suspend mode when the system is inactive after the selected time.

The available time periods are 1, 2, 3, 4, 5, 10, 30 minutes and Never.

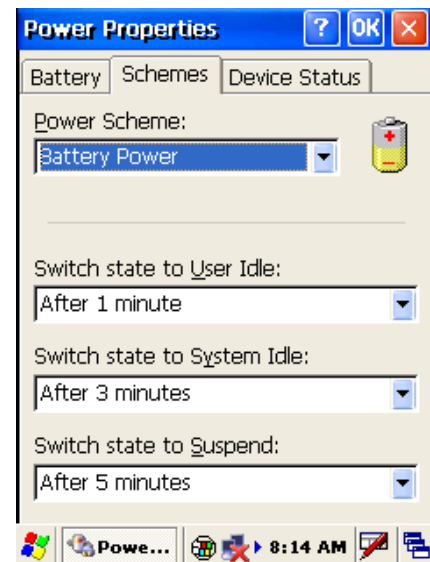

Reducing CPU Speed

Follow these instructions to reduce the CPU speed.

1. Tap **Start** → **Settings** → **Control Panel** → **CPU Speed**:
2. Select a lower CPU speed to conserve battery power

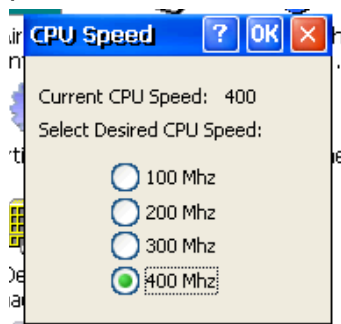

Adjusting Backlight Setting

The power consumption of the LCD backlight is high. To conserve battery power, turn off the backlight function if it is not necessary.

To change backlight settings:

1. Tap **Start** → **Settings** → **Control Panel**.
2. Tap **Backlight**.

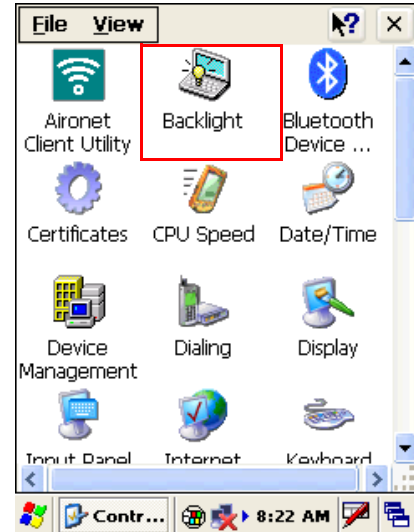

The Backlight screen appears.

3. Tap the **Battery Power** or **External Power** radio button and do any of the following:
 - Tap the **Dim backlight if device is not used for** check box and select the amount of time before the unit reduces the backlight intensity from the drop-down list.
 - Tap the **Turn off backlight if device is not used for** check box and select the amount of time before the unit turns off the backlight from the drop-down list.
 - Tap the **Turn on the backlight...** checkbox to activate the backlight when the screen is tapped or a button is pressed.
 - Use the slider bars to select the intensity of the backlight when it is fully on or dimmed.

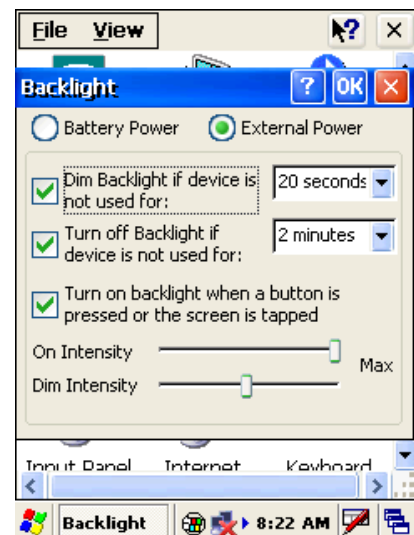

Performing a Hardware Reset

You may have to perform a reset if the device freezes (i.e., device no longer responds to the buttons on the screen). There are three ways to

Performing a Warm Boot

A warm boot allows your device to get a fresh start, similar to rebooting a computer. This will restart your device and adjust memory allocation. All records and entries are retained after a warm boot. Unsaved data in open programs may in some cases be lost.

1. Tap **Start** → **Programs** → **Utilities** → **Boot Mode**:

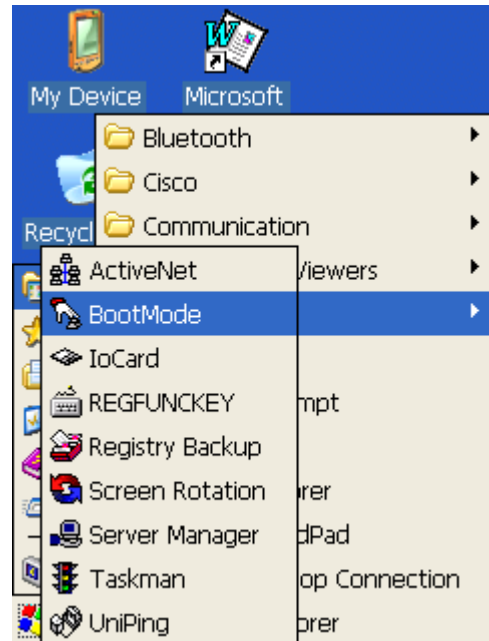

The BootMode screen opens.

2. Tap Warm Boot. The system is reset and you will lose all unsaved data.

Alternatively, to perform a warm boot, lightly press the tip of the stylus to the reset button located on the rear of the PA982.

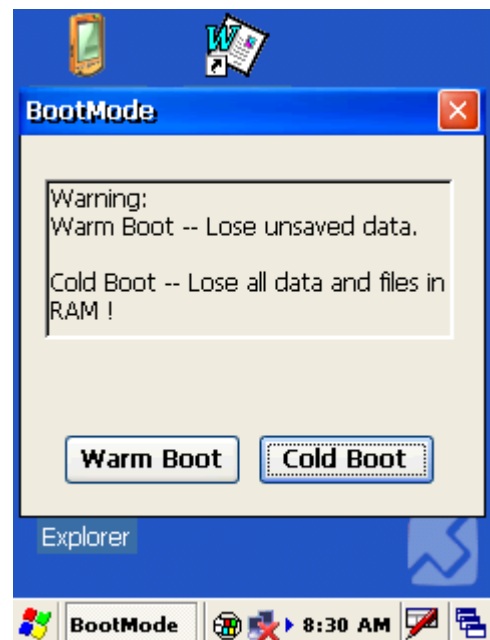
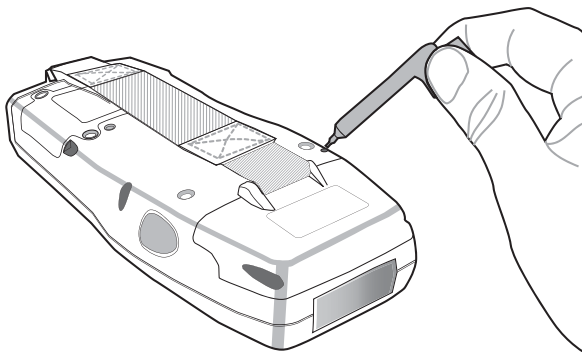

Performing a Cold Boot

A cold boot cuts off power to your device, erasing all records and entries, deleting all programs you have added, and restoring the device to default factory settings.

Never perform a cold boot unless a soft reset does not correct your problem. When you perform your next ActiveSync operation, you can restore any data that you previously synchronized to your computer or you can restore data that you backed up to a storage card.

You can perform a cold boot using the Boot Mode utility in the operating system, or by pressing the Cold Boot hardware reset button in the PCMCIA bay.

Performing a Cold Boot using the Boot Mode Utility

1. Tap **Start** → **Programs** → **Utilities** → **Boot Mode**:

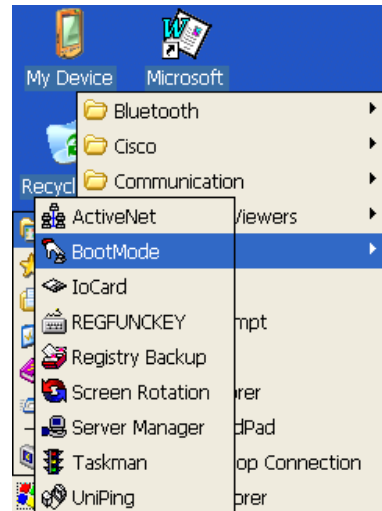

The BootMode screen opens.

2. Tap **Cold Boot**. The system is reset and you will lose all data including all files in the RAM memory.

NOTE: When you perform a hard reset, the date and time settings are not be retained. Formats, preferences, and other settings are restored to their default factory settings.

Performing a Cold Boot using the Hardware Reset Button

The hardware reset button enables you to reset the PA982 in the even that the operating system does not work or boot up.

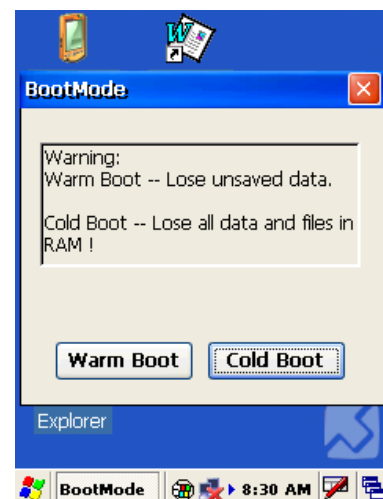

Remove the PCMCIA bay cover and press the white hardware reset button inside the PCMCIA bay with the tip of a screwdriver.

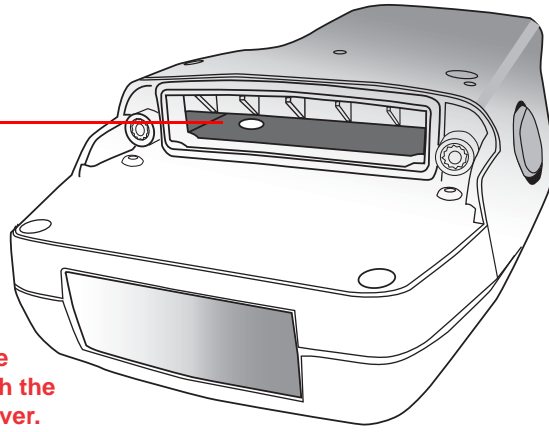

Appendix

System Specifications

Processing/Memory	CPU	Intel Xscale PXA255 400Mhz
	Memory	SDRAM: 64 MB Flash ROM: 64 MB
OS	Microsoft Windows CE 5.0 Professional Plus	
Keypad	22-key, including numeric key, alpha key and function key	
Display	240x320 QVGA, Color Transflective TFT with Touch Screen & backlight	
Scanner	Integrated liner barcode scanner Long Range (optional) RFID Reader (optional)	
Indicator	Dual color (red/green) LED	
Communication	USB Host & Client IrDA 1.2(SIR) through cradle GSM/GPRS (via expansion slot) 802.11b/g (optional) Bluetooth	
Audio	Speaker	
Expansion Slot	PCMCIA Type II slot	
Power Source	Main	Lithium-Ion @ 7.4V 2200mAh Main battery pack
	Backup	One rechargeable Li-ion backup battery
Enclosure	Weight	700g
	Dimension	Approximately L221.3 X H177.5 X W99.5mm
Environmental	Operating temperature	-30°C~ 50°C
	Storage temperature	-30°C~ 70°C
	Relative Humidity	5% ~ 95%(non-condensing)
	Drop test to Concrete	4 feet
	Environmental Sealing	IP67
Certification	CE, FCC, BSMI, VCCI, RoHS compliant	
Accessories	Desktop Cradle with power jack USB cable Synchronization and power cable AC/DC power adapter Gun grip handle with internal Li-ion battery	
Software	Microsoft Visual Studio 2005 Microsoft Windows CE 5.0 SDK unitech PA982 SDK VOIP (via 3rd party)	