

Ivy Bridge performance and extensive connectivity packed in a 3.5-litre chassis

The ultra-compact Shuttle Slim-PC Barebone XH61V is the ideal basis to set up a small, but powerful PC. Be it for the home environment in form of a HTPC, an office PC for enterprises or a platform to be used for industrial applications, the XH61V delivers. With Dual-LAN for server applications and two serial ports to connect it to professional devices, there is also two digital video outputs to use multiple monitors at once. Driven by a 22nm Intel Ivy Bridge processor and in a team with a 2.5" SSD, the XH61V is an efficient system that banks its reliability on Shuttle's well-tried heatpipe cooling.

Shuttle Slim-PC Barebone XH 61V

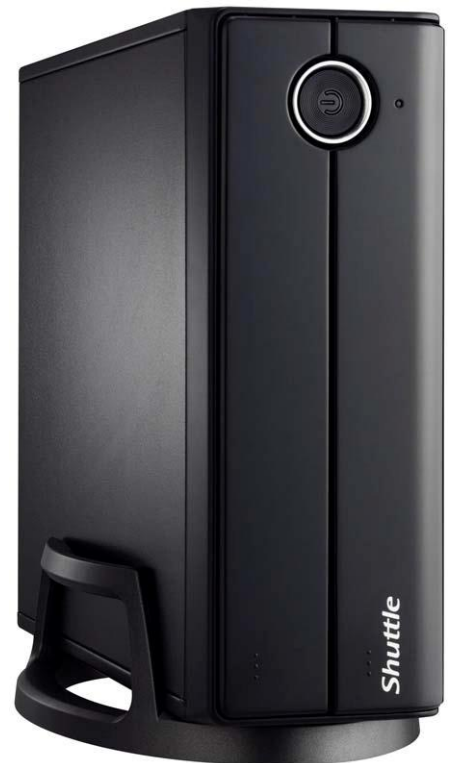

Feature Highlights

<i>Slim-Design</i>	<ul style="list-style-type: none"> • Slim 3.5 litre chassis, black • Dimensions: 24 x 20 x 7.2 cm (L/W/H) • Bays: 2x 6.35cm/2.5" for hard disks or SSDs and 1x slim optical drive
<i>Processor</i>	<ul style="list-style-type: none"> • Supports Socket 1155 CPUs, max. 65W TDP • Supports Core i7 / i5 / i3, Pentium, Celeron • Supports 32nm and 22nm processors • Including heat-pipe cooling system
<i>Chipset</i>	<ul style="list-style-type: none"> • Intel H61 Express Chipset
<i>Memory</i>	<ul style="list-style-type: none"> • 2x 204 pin SO-DIMM slots • Supports DDR3-1333/1600, max. 2x 8 GB
<i>Graphics</i>	<ul style="list-style-type: none"> • Integrated Intel HD graphics (features depends on processor) • Video-outputs: HDMI and DVI-I
<i>Drive Connectors</i>	<ul style="list-style-type: none"> • 3x SATA II (3 Gbit/s) with UEFI support • Two pre-installed SATA cables (HDD+ODD)
<i>Other Connectors</i>	<ul style="list-style-type: none"> • 5.1 HD Audio (digital audio via S/PDIF) • 2x USB 3.0, 4x USB 2.0, 2x USB 2.0 onboard • Dual Gigabit LAN (RJ45), supports WOL, PXE • 2x COM ports (RS232 + RS232/RS422/RS485)
<i>Power Supply</i>	<ul style="list-style-type: none"> • External 90W fanless power adapter
<i>Application</i>	<ul style="list-style-type: none"> • Home, office, vertical market

Images for illustration purposes only.
The optical drive and the vertical stand are available optionally.



Shuttle Slim-PC Barebone XH61V – Product Features



The 3.5-litre chassis - a clean and modern look

Shuttle has always placed great emphasis on the interior and exterior aesthetics of their Mini-PCs with the belief that a good blend of style and form factor allow the Mini-PC to be attractive, versatile and work well in almost any environment. And the XH61V was designed just like that and shines in a clean and modern appearance. The optical drive and front panel connectors are elegantly concealed behind drive doors to provide maximum protection. This tiny tot barely stands 7.3 cm in height with a volume of 3.5 litres.



What does Barebone mean?

The Shuttle Slim-PC Barebone XH61V consists of a stylish case with pre-installed mainboard, cooling system and external power adapter. Despite its small form factor it offers outstanding connectivity, functionality and performance. For a complete Mini-PC system, a few components still need to be added. The Mini-PC is customisable and takes socket 1155 processors, DDR3 SO-DIMM memories, slim-line SATA optical drive, 2.5" hard disk (or SSD). Once the desired operation system is installed, the XH61V is ready to use. Moreover, the system features pre-routed cables that are tied down from factory to reduce clutter, increase airflow and ease component installation.



Supports LGA1155 processors and up to 16 GB DDR3

A wide range of socket 1155 Intel processors is available starting from Celeron up to Core processors with a maximum TDP of 65W. Plus, the system memory can be installed according to individual needs up to a maximum capacity of 16 GB DDR3 memory.

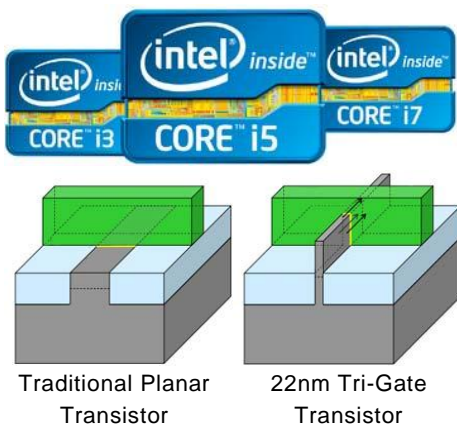

Supports Intel 22nm Ivy Bridge Processors

Ivy Bridge (IVB) is the codename for Intel's new 22nm processor microarchitecture introduced in April 2012 along with the 7-series chipsets. Ivy Bridge is the first chip to use Intel's 22nm tri-gate transistors, which will help scale frequency and reduce power consumption. At a high level Ivy Bridge looks a lot like Sandy Bridge - one monolithic die incorporates up to four CPU cores, the shared L3 cache, the memory controller, PCIe links and the graphics processor. Compared to its predecessor Sandy Bridge, the new design brings some improvements in overall performance, overclocking, power management and also features PCIe v3.0 and DDR3-1600 capability, an updated DirectX 11 graphics, new security features and CPU instructions. Ivy Bridge still uses the known LGA1155 socket.



Great Connectivity

On the front, elegantly hidden from view behind drive doors, the panel reveals two USB 2.0 ports for external drives, MP3 players etc. There are also two 3.5mm jacks for headphone and microphone. In addition, the back panel offers a wide range of I/O connectivity as well.



2x USB 3.0

The Shuttle Slim-PC Barebone XH61V sports two USB 3.0 ports besides four USB 2.0 ports. USB 3.0 achieves a maximum data rate of up to 5.0Gbps (640MBytes/sec) which is ten times faster than USB 2.0. USB 3.0 is fully compatible to USB 2.0. At a glance, USB 3.0 connectors seem no different to USB 2.0 connectors, however USB 3.0 connectors have 5 more pins placed inside the connector itself. USB 2.0 can provide a maximum of 500mA to the USB device while USB 3.0 can provide a maximum output of 900mA, which is important for portable hard drives. USB 3.0 also comes with better power saving features to let your devices run more efficiently when in idle mode.



Dual Gigabit LAN Network

Today's media-rich communications across the internet and within enterprises create new demands for clients in Local Area Networks. For that reason, Shuttle applies Gigabit LAN performance to their Mini-PCs and XH61V even supports two of them. Dual networking allows the computer to connect to a single network using two cables at once with an appropriate switch (teaming mode with load balancing or failover function) or to two different networks depending on the needs of the user.



Dual View Technology with HDMI and DVI (or VGA)

Dual View technology offers multiple display support on up to two separate monitors. This helps to improve on productivity by allowing for spreading multiple windows across two monitors while working with them simultaneously. XH61V features two video outputs: HDMI and DVI-I.

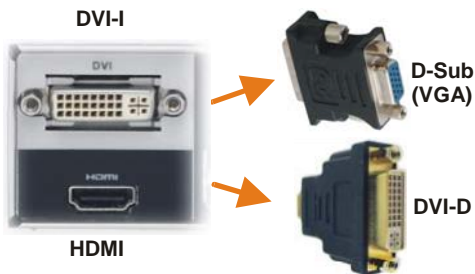

Video outputs

With optional adapters DVI-D devices can be connected to the HDMI port or VGA devices to the DVI-I port, respectively.

DVI-D means the connector only outputs digital video signals.

DVI-I means digital and analog video signals are put out.

HDMI supports digital video plus multi-channel digital audio output.

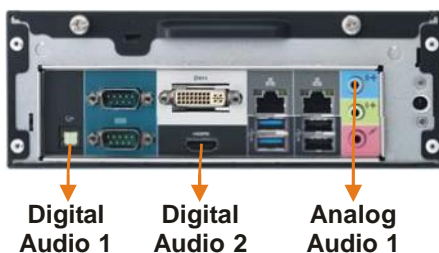

Digital Audio

Beside the analog audio, XH61V can provide digital multichannel audio in two ways: via the optical S/PDIF output (Toslink) or through HDMI. Therefore, two audio devices are shown in the Windows device manager. Connect the HDMI to your TV set and you will have both digital audio and video. For better audio experience you may use an audio receiver (amplifier) with a bunch of speakers around which is probably connected via S/PDIF. XH61V is flexible enough to support both options.



Two serial ports

Many PCs do not have these legacy ports any longer, since they have been superseded and replaced by USB for most consumer applications, but they are still commonly used for applications such as industrial automation systems, scientific analysis, POS systems and other industrial applications. XH61V features two serial RS-232 ports

which also support both 5 or 12V. The lower COM port also supports the RS422 and RS485 standard.



2x expansion slots for Mini-PCI-Express cards

XH61V features two expansion slots for Mini-PCIe cards. One is a half size slot dedicated for an optional Wireless LAN adapter. The second has full size format and not only features a PCIe interface, but also mSATA (Mini Serial ATA), supporting the new generation of Solid State Drives (SSD) in a compact Mini PCIe card form factor.

Photos: half size WLAN card (left) and mSATA SSD card (right).



Kensington Lock

This is a small, metal-reinforced hole as part of an anti-theft system. (The lock-and-cable are not included)



Heat pipe cooling

XH61V features a highly efficient heat pipe cooling. A heatpipe is a hollow tube containing a heat transfer liquid. As the liquid evaporates, it carries heat to the cool end, where it condenses and then returns to the hot end. Heatpipes thus have a much higher effective thermal conductivity than solid materials. Please keep the vent holes clear of obstructions.



Optional Stand for vertical operation (PS01)

XH61V can be used for horizontal operation by default. With the optional stand accessory (PS01), it can also be placed in vertical position.



Optional VESA mount (PV02)

Its optional VESA75/100 wallmount allows it to be installed on to walls or just affixed on the rear side of a monitor which is particularly interesting for the industry segment, company buildings and public institutions.

Connectivity / Applications

The XH61V's great connectivity makes it well-suited for a wide field of applications and external devices.

Point-of-Sales (POS)

Office Display

Dual Network

PC Speakers

Audio

USB 2.0

Peripherals

USB 3.0

USB Hard Disk

Home Cinema & Digital Signage

HDMI

Digital Audio

S/PDIF

Automation

RS232

RS422/485

DVI-I

2x RJ45

The XH61V is your powerful 3.5-litre Slim-PC solution for high performance driven applications, e.g.:

- Digital Signage
- In-store Audio/Video entertainment
- Gambling
- Home-Media
- Office
- Call Center
- Education
- Kiosk
- Point of Sales (POS)
- Medical
- Automation
- Small server

Shuttle 3.5-litre Slim-PC Barebones

Comparison with predecessor models

Barebone model	XG41	XH61	XH61V
Availability	June 2011	Dec. 2011	June 2012
UPC bar code	811686003472	811686003588	811686003830
Chassis	Steel, black 3.5L (24.2 x 20 x 7.3 cm)	Steel, black 3.5L (24.2 x 20 x 7.3 cm)	Steel, black 3.5L (24.2 x 20 x 7.3 cm)
Intel processor support	LGA775, max. 65W FSB: 800, 1066, 1333MHz Core 2 Duo, Pentium, Celeron	LGA1155, max. 65W 32nm Sandy Bridge Core i7, i5, i3, Pentium, Celeron	LGA1155, max. 65W 32nm Sandy Bridge 22nm Ivy Bridge Core i7, i5, i3, Pentium, Celeron
Processor cooling	Heatpipe cooling system with two 6 cm fans	Provided cooling fan: 80 x 80 x 15 mm	Heatpipe cooling system with two 6 cm fans
Chipset	Intel G41 + ICH7	Intel H61	Intel H61
Mainboard	Mini ITX All solid capacitors	Mini ITX All solid capacitors	Mini ITX All solid capacitors
Integrated graphics	GMA X4500, DX10	HD graphics (CPU)	HD graphics (CPU)
Memory support	Max. 2x 4GB DDR3-800/1066 240 pin DIMM	Max. 2x 8GB DDR3-1333 240 pin DIMM	Max. 2x 8GB DDR3-1333/1600 204 pin SO-DIMM
Audio codec	Realtek ALC662	Realtek ALC887	Realtek ALC662
Ethernet (LAN)	Dual Gigabit, Teaming 2x Realtek 8111E	Single Gigabit 1x Realtek 8111E	Dual Gigabit, Teaming 2x Realtek 8111E
Storage bays	1x Slim optical drive 2x 2.5" hard disk / SSD	1x Slim optical drive 1x 2.5" hard disk / SSD	1x Slim optical drive 2x 2.5" hard disk / SSD
Preinstalled SATA cables	2x (for Slim ODD & HDD)	2x (for Slim ODD & HDD)	2x (for Slim ODD & HDD)
Mini-PCIe slot	1x full/half size	None	1x half size 1x full size (mSATA)
Front panel	Power button Power & HDD LED 2x USB 2.0 2x Audio (Line-out/Mic)	Power button Power & HDD LED 2x USB 2.0 2x Audio (Line-out/Mic)	Power button Power & HDD LED 2x USB 2.0 2x Audio (Line-out/Mic)
Back Panel	HDMI DVI-I 4x USB 2.0 2x Gigabit LAN (RJ45) 3x Audio (Mic, Line in/out) Optical S/PDIF out RS232 + RS232/422/485 Hole for Kensington lock	HDMI D-Sub (VGA) 4x USB 2.0 1x Gigabit LAN (RJ45) 2x PS/2 (keyb.+mouse) 3x Audio (Mic, Line in/out) Hole for Kensington lock	HDMI DVI-I 2x USB 3.0 2x USB 2.0 2x Gigabit LAN (RJ45) 3x Audio (Mic, Line in/out) Optical S/PDIF out RS232 + RS232/422/485 Hole for Kensington lock
Onboard connectors	3x SATA 2.0 (300MB/s) 2x USB 2.0 Clear CMOS jumper	4x SATA 2.0 (300MB/s) 2x USB 2.0 S/PDIF out Clear CMOS jumper TPM header (7x2 pin)	3x SATA 2.0 (300MB/s) 2x USB 2.0 Clear CMOS jumper TPM header (10x2 pin)
External Power adapter	Output: 90W, 19V DC Input: 100~240VAC	Output: 90W, 19V DC Input: 100~240VAC	Output: 90W, 19V DC Input: 100~240VAC
Optional accessories	Vertical stand (PS01) VESA mount kit (PV02)	Vertical stand (PS01) VESA mount kit (PV02)	Vertical stand (PS01) VESA mount kit (PV02)

Shuttle Slim-PC Barebone XH61V Specifications

Chassis

Nettop PC, slim X-type chassis, black
 Dimensions: 24 x 200 x 72 mm (LWH) = 3.5 litres, Weight: 2.2 kg net, 3.5 kg gross
 Front doors for optical drive and front panel connectors
 Hole for Kensington Lock at the back panel
 Operation position horizontal or vertical with the optional stand PS01

Storage Bays

1x for optical drive (ODD) in slimline format with 12.7 mm height
 2x 6.35cm/2.5" for hard disk or SSD (max. height: 9.5 mm, upper bay: 12.7 mm)
 Two pre-installed SATA cables (ODD, HDD) and mounting screws included

Mainboard Chipset BIOS

Mini-ITX Mainboard "FH61V": 17 x 17 cm
 Chipset: Intel® H61 Express Chipset
 AMI BIOS in 8Mbit EEPROM with SPI interface
 All capacitors are high quality solid capacitors
 Supports hardware monitoring and watch dog functionality
 Supports Unified Extensible Firmware Interface (UEFI)**
 Supports resume after power failure

Power Adapter

External 90W power adapter (fanless)
 Input: 100~240V AC, 50/60 Hz
 Output: 19V DC, 4.74A, max. 90W
 Internal DC-DC daughter board

Processor Support

Socket 1155 (LGA 1155) supports the second and third generation of Intel Core i3 / i5 / i7 / Pentium / Celeron processors with a power consumption of up to 65W TDP
 - Codename "Sandy Bridge", 32nm process technology and
 - Codename "Ivy Bridge", 22nm process technology
 Not compatible with older Socket-1156 processors.
 The Processor integrates PCI-Express, memory controller and the graphics engine on the same die (depends on processor type)
 Please refer to the support list for detailed processor support information.

Heat-pipe Cooling

Processor cooling with heat pipe technology and two fans (6cm)

Memory Support

2x SO-DIMM slots with 204 pins
 Supports DDR3-1066/1333/1600 SDRAM memory (PC3-8500/10600/12800)
 The maximum memory clock rate depends on the processor type.
 Supports Dual Channel mode
 Supports max. 8 GB per DIMM, maximum total size of 16 GB
 Supports two unbuffered DIMM modules of 1.5V

<p><i>Mini-PCIe slots</i></p>	<p>XH61V features two Mini PCI Express expansion slots: 1) half size, supports PCIe 2.0 and USB 2.0, e.g. for WLAN cards [5] 2) full size, supports PCIe 2.0, SATA 3G and USB 2.0 e.g. for Mini SATA (mSATA) flash memory cards [6]</p>
<p><i>Integrated Graphics</i></p>	<p>The features of the integrated graphics function [3] depends on the used processor type. "Sandy Bridge" processor: Intel® HD Graphics 2000/3000, DirectX 10.1 "Ivy Bridge" processor: Intel® HD Graphics 2500/4000, DirectX 11 Maximum shared memory size: 1692MB Supports HDMI, max. resolution up to 1920x1200 @ 60Hz Supports DVI, max. resolution up to 1920x1200 @ 60Hz Supports D-Sub, max. resolution up to 2048x1536 @ 75Hz (optional VGA-to-DVI-adapter required) Supports Blu-ray Stereoscopic 3D with HDMI 1.4a [1] Supports HDCP function with DVI and HDMI ports Supports Full HD 1080p Blu-ray (BD) / HD-DVD playback with DVI and HDMI ports Supports Dual-Independent-Display via HDMI and DVI-I port HDMI supports HD video plus multi-channel digital audio via a single cable</p>
<p><i>Audio</i></p>	<p>Audio Realtek® ALC 662 6-channel High-Definition Audio Three analog audio connectors (3.5mm) at the Back-Panel: 1) Front Line out (head phone) 2) Rear Surround line-out (shared with microphone input) 3) Center line-out (shared with Line in) Digital audio output: S/PDIF (optical) and via HDMI</p>
<p><i>Mini-PCIe slots</i></p>	<p>XH61V features two Mini PCI Express expansion slots: 1) half size, supports PCIe 2.0 and USB 2.0, e.g. for WLAN cards [5] 2) full size, supports PCIe 2.0, SATA 3G and USB 2.0 e.g. for Mini SATA (mSATA) flash memory cards [6]</p>
<p><i>Dual Gigabit LAN Controller</i></p>	<p>Dual Realtek 8111E Ethernet network controller (Gigabit) Supports 10 / 100 / 1.000 MBit/s operation With two RJ45 ports (dual network) supports Teaming [4] Supports WAKE ON LAN (WOL) Supports network boot by Preboot eXecution Environment (PXE)</p>
<p><i>Drive Connectors</i></p>	<p>3x Serial-ATA II, 3 Gb/s (300 MB/s) bandwidth Supports Unified Extensible Firmware Interface (UEFI) [2] Note: This barebone system comes with two pre-installed SATA cables: for one 2.5" hard disk and for one optical slim drive.</p>
<p><i>Front Panel Connectors</i></p>	<p>Microphone input, Audio Line-out (headphone) 2x USB 2.0 Power button Power LED (blue), HDDLED (yellow)</p>

<p><i>Back Panel Connectors</i></p>	<p>DVI-I connector (supports VGA with optional adapter) HDMI 1.4 connector [1] (supports DVI-D with optional adapter) 2x USB 3.0, 2x USB 2.0 2x GigaBit LAN (RJ45) 2x RS232 serial ports (5V/12V, 1x switchable to RS422 / RS485) Audio Line-in, Audio Line-out, Audio Mic-in S/PDIF output (optical) Perforation for Wireless LAN antennas (2 holes) Hole for Kensington Lock</p>
<p><i>Other Onboard Connectors</i></p>	<p>6x USB 2.0 (two 2x5 pin header) - two of them are occupied by the front panel USB ports 2x5 pins + 3 pins power connectors 2x fan connectors (4 pin) - one is occupied for the system fans Clear CMOS jumper (2 pins) Connector for CMOS battery TPM module header (2x10 pins LPC interface) 2x front panel connectors (2x5 pins each, for audio and power button/LED)</p>
<p><i>Accessories</i></p>	<p>Multi-language user guide Driver DVD (Windows 7 32/64 bit, Windows Vista 32/64 bit and Windows XP 32 bit) 2x cable for SATA (preinstalled for 2.5 HDD/SSD drive and optical slim drive) 1x 4 pin to SATA power cable External power adapter with power cord CPU heat-pipe cooling system Screws</p>
<p><i>Optional Accessories</i></p>	<p>Vertical stand (PS01) VESA mount (PV02)</p>
<p><i>Conformity Certifications</i></p>	<p>EMI: FCC, CE, BSMI, C-Tick Safety: CB, BSMI, ETL Others: RoHS, Energy Star V5.0, EuP Lot 6 This device is classed as a technical information equipment (ITE) in class B and is intended for use in living room and office. The CE-mark approves the conformity by the EU-guidelines: - EMV-guideline 89/336/EEG electromagnetic tolerance - LVD-guideline 73/23/EEG use of electric devices within certain voltage-limits</p>

[1] HDMI version supported

HDMI 1.4 is only supported by all LGA1155 processors. Some models support HDMI 1.3 only.

[2] Unified Extensible Firmware Interface (UEFI) - required when booting from hard disks larger than 2.2 TB under Windows 64 bit operating systems such as Windows 7, Windows Vista SP1 and Windows Server 2008/2003 SP1.

[3] Integrated video outputs (HDMI and DVI-I)

Not all LGA1155 Intel processors support integrated graphics. Please check the specification of the used processor. If you want to use the video outputs, then please make sure, that the used processor provides integrated graphics.

[4] Teaming Modus

The teaming function allows you to group both available network adapters together to function as a single adapter - a method of creating a virtual LAN. The benefit of this approach is that it enables load balancing and failover.

[5] Optional Wireless LAN module: this Slim PC supports an optional WLAN module, which consists of a half-size Mini-PCIe card with IEEE 802.11n functionality and an external antenna with appropriate antenna cable.

[6] mini-SATA (mSATA) not to be confused with the "micro SATA" connector, is a newer industry standard which converts the electrical SATA interface (1.5 or 3.0 Gbit/s) to the physical "Mini PCI Express" mini card form factor.

Shuttle Slim-PC Barebone XH61V – Front and Back Panel

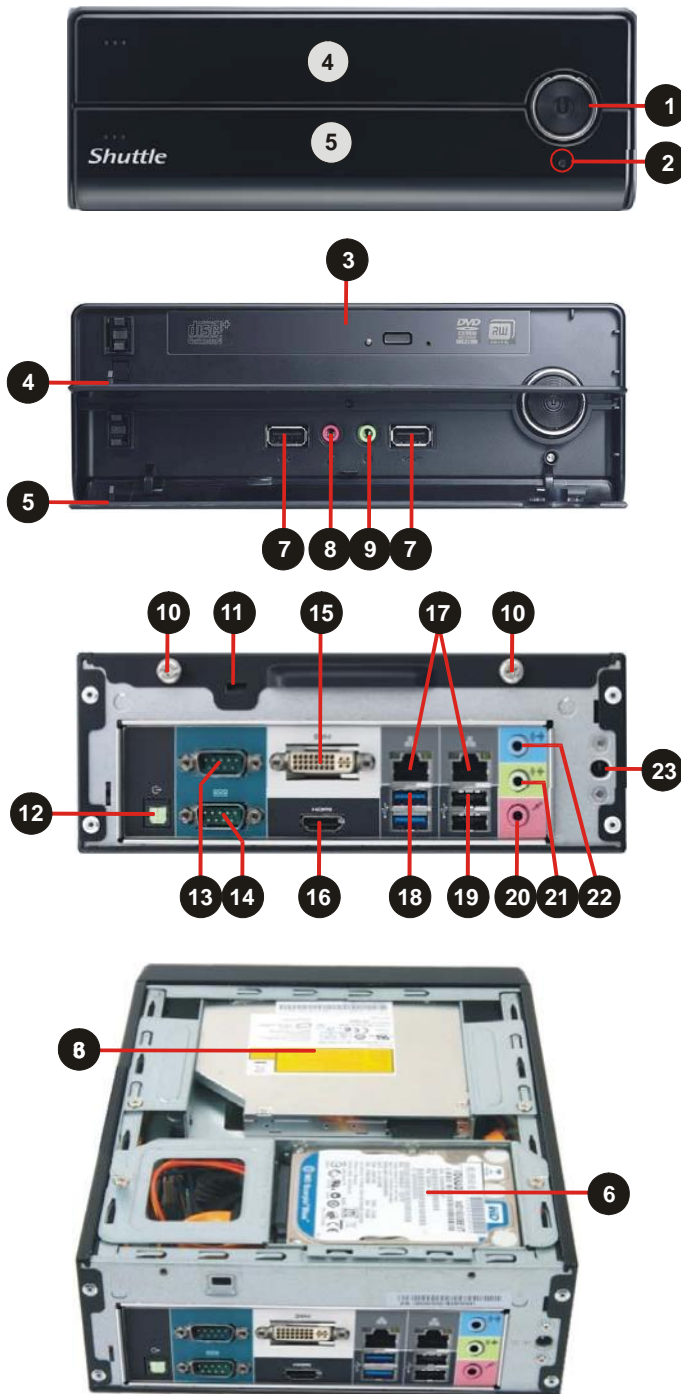

Front Panel

- 1 Power Button
- 2 Power LED
- 3 Bay for optical Slim DVD drive (the optical drive is not included)
- 4 Front door for DVD drive
- 5 Front door for I/O connectors
- 6 Two bays for 2.5" hard disk drives or SSDs
- 7 2x USB 2.0 ports
- 8 Microphone input
- 9 Headphone output

Back Panel

- 10 Two thumbscrews
- 11 Hole for Kensington Lock
- 12 Digital audio: S/PDIF (optical)
- 13 RS232 serial interface (COM port)
- 14 RS232 / RS422 / RS485 ser. (COM)
- 15 DVI-I – digital video output (supports VGA with optional adapter)
- 16 HDMI – digital video/audio output
- 17 Dual Gigabit network (RJ45)
- 18 2x USB 3.0
- 19 2x USB 2.0
- 20 Microphone input
- 21 Headphone / line-out
- 22 Audio line-in
- 23 Connector for the power adapter

Note: the storage drives (hard disk and optical slimline drive) are not included in the delivery of XH61V. For a second 2.5" drive you will need another SATA cable.



COM port Pin 9 Configuration

Pin 9 is a multi-functional signal. Based on Jumper 3 configuration on the mainboard, it can be configured as Ring Indicator (RI) or external power supply with either 5V or 12V voltage level (each COM port separately).

Shuttle Slim-PC Barebone XH61V – Mainboard

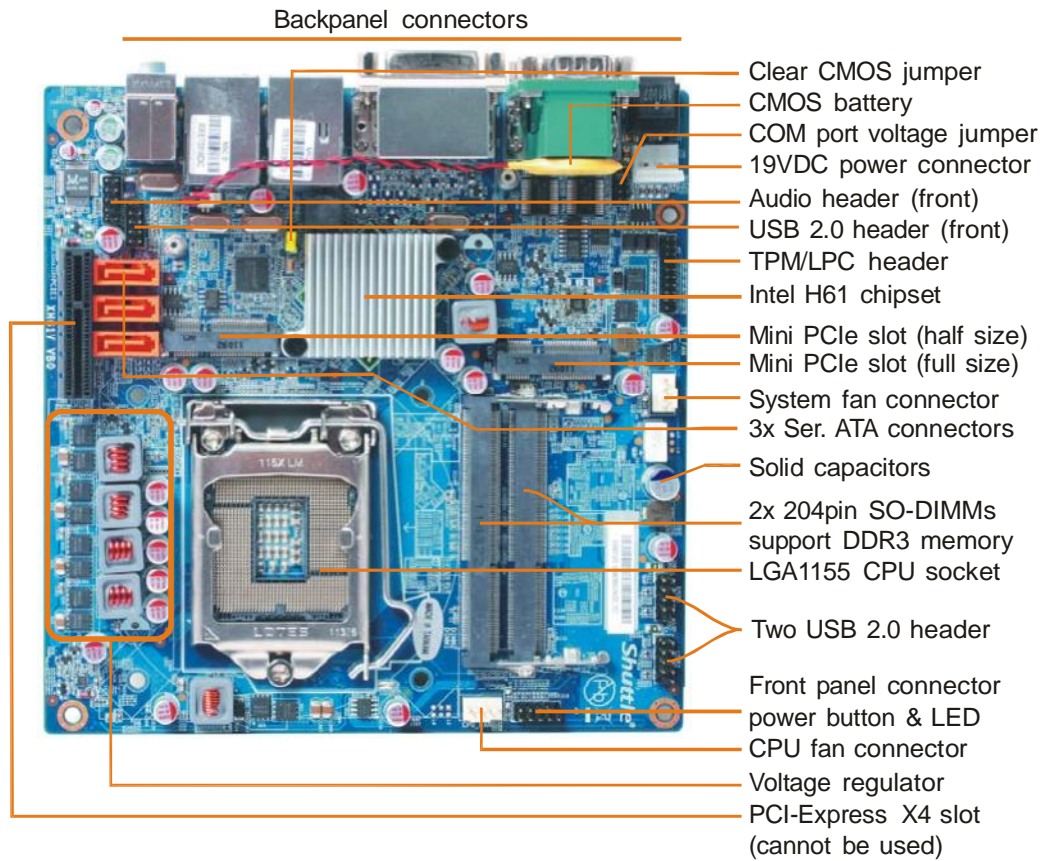

Supports three drives



XH61V supports one optical drive in 5.25" slim-line format and two 2.5" drives (e.g. hard disk and SSD). For the second 2.5" drive you will need an additional SATA cable and mounting screws.

Shuttle Slim-PC Barebone XH61V – Required Components

The following components need to be added to make it a fully-configured Mini-PC:

2.5" SATA-hard disk
and/or Solid State Disk (SSD)
(two drives supported,
max. height: 9.5mm and 12.7mm)

One or two DDR3-1333/1600 (SO-DIMM)
Memory modules max. 8GB each

Windows / Linux
Operating System

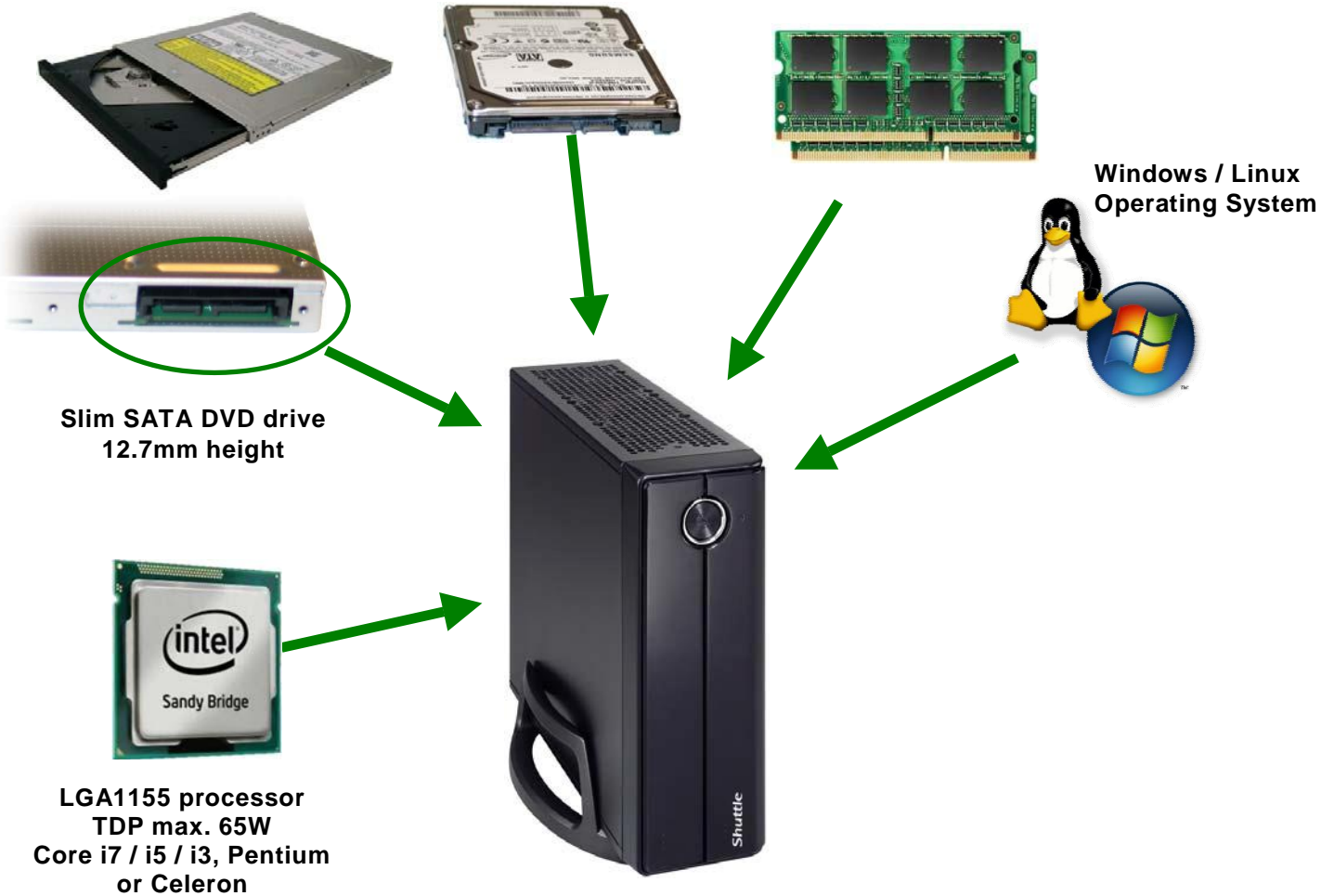

2rd Generation Intel Core Processor Family (max. 65W)

LGA1155 socket “32nm Sandy Bridge” processor overview (Date: May 2012)

Name	Model	Cores	HT	Clock	Turbo	Cache	TDP	Graphics	Graphics clock
Celeron	G440	1	-	1.6 GHz	-	1 MB	35W	HD	650~1000 MHz
	G460	1	Yes	1.8 GHz	-	1.5 MB	35W	HD	650~1000 MHz
	G530	2	-	2.4 GHz	-	2 MB	65W	HD	850~1000 MHz
	G530T	2	-	2.0 GHz	-	2 MB	35W	HD	650~1100 MHz
	G540	2	-	2.5 GHz	-	2 MB	65W	HD	850~1000 MHz
Pentium	G620T	2	-	2.2 GHz	-	3 MB	35W	HD	650~1100 MHz
	G620	2	-	2.6 GHz	-	3 MB	65W	HD	850~1100 MHz
	G630	2	-	2.7 GHz	-	3 MB	65W	HD	850~1100 MHz
	G630T	2	-	2.3 GHz	-	3 MB	35W	HD	650~1100 MHz
	G840	2	-	2.8 GHz	-	3 MB	65W	HD	850~1100 MHz
	G850	2	-	2.9 GHz	-	3 MB	65W	HD	850~1100 MHz
	G860	2	-	3.0 GHz	-	3 MB	65W	HD	850~1100 MHz
Core i3	2100T	2	Yes	2.5 GHz	-	3 MB	35W	HD 2000	650~1100 MHz
	2100	2	Yes	3.1 GHz	-	3 MB	45W	HD 2000	850~1100 MHz
	2105	2	Yes	3.1 GHz	-	3 MB	45W	HD 3000	850~1100 MHz
	2120	2	Yes	3.3 GHz	-	3 MB	45W	HD 2000	850~1100 MHz
	2120T	2	Yes	2.6 GHz	-	3 MB	35W	HD 2000	650~1100 MHz
	2125	2	Yes	3.3 GHz	-	3 MB	65W	HD 3000	850~1100 MHz
	2130	2	Yes	3.4 GHz	-	3 MB	65W	HD 2000	850~1100 MHz
Core i5	2390T	2	Yes	2.7 GHz	3.5 GHz	3 MB	35W	HD 2000	650~1100 MHz
	2400S	4	-	2.5 GHz	3.3 GHz	6 MB	65W	HD 2000	850~1100 MHz
	2405S	4	-	2.5 GHz	3.3 GHz	6 MB	65W	HD 3000	850~1100 MHz
	2500T	4	-	2.3 GHz	3.3 GHz	6 MB	45W	HD 2000	650~1250 MHz
	2500S	4	-	2.7 GHz	3.7 GHz	6 MB	65W	HD 2000	850~1100 MHz
Core i7	2600S	4	Yes	2.8 GHz	3.8 GHz	8 MB	65W	HD 2000	850~1100 MHz

Please refer to the support list for detailed processor support information at global.shuttle.com.

K = unlocked, S = Performance optimized lifestyle, T = Power optimized lifestyle, HT = Hyper Threading (SMT).

Intel HD graphics HD 3000/2000 supports 12/6 Execution Units (Shader-Quads) and DirectX 10.1.

HDMI 1.4a is only supported with 2nd Intel® Generation Core(TM) i3/i5/i7 Processors. Pentium and Celeron Processors support HDMI 1.3. Certain processor models do not include the integrated graphics.

Please refer to the support list for detailed processor support information at global.shuttle.com.

3rd Generation Intel Core Processor Family (max. 65W)

LGA1155 socket “22nm Ivy Bridge” processor overview (Date: May 2012)

Name	Model	Cores	HT	Clock	Turbo	Cache	TDP	Graphics	GPU-Turbo
Core i5	3450S	4	-	2.8 GHz	3.5 GHz	6 MB	65 W	HD 2500	1100 MHz
	3470S	4	-	2.9 GHz	3.6 GHz	6 MB	65 W	HD 2500	1100 MHz
	3550S	4	-	3.0 GHz	3.7 GHz	6 MB	65 W	HD 2500	1150 MHz
	3570T	4	-	2.3 GHz	3.3 GHz	6 MB	45 W	HD 2500	1150 MHz
Core i7	3770T	4	Yes	2.5 GHz	3.7 GHz	8 MB	45 W	HD 4000	1150 MHz
	3770S	4	Yes	3.1 GHz	3.9 GHz	8 MB	65 W	HD 4000	1150 MHz

K = unlocked, S = Performance optimized lifestyle, T = Power optimized lifestyle, HT = Hyper Threading (SMT).

Intel HD graphics HD 4000/2500 features 16/6 Execution Units (Shader-Quads) and supports DirectX 11/OpenGL 3.1.

All listed processors support the following memory standards: DDR3-1066, DDR3-1333, DDR3-1600.

Please refer to the support list for detailed processor support information at global.shuttle.com.