

Micro HiFi Component System

Operating Instructions

Owner's Record

The model and serial numbers are located at the rear. Record the serial number in the space provided below. Refer to them whenever you call upon your Sony dealer regarding this product.

Model No. CMT-CP11 Serial No. _____



CMT-CP11

WARNING

To prevent fire or shock hazard, do not expose the unit to rain or moisture.

To avoid electrical shock, do not open the cabinet. Refer servicing to qualified personnel only.

Do not install the appliance in a confined space, such as a bookcase or built-in cabinet.

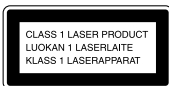

This appliance is classified as a **CLASS 1 LASER** product. The **CLASS 1 LASER PRODUCT MARKING** is located on the rear exterior.

NOTICE FOR THE CUSTOMERS IN THE U.S.A.

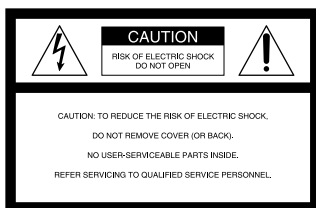

This symbol is intended to alert the user to the presence of uninsulated “dangerous voltage” within the product’s enclosure that may be of sufficient magnitude to constitute a risk of electric shock to persons.



This symbol is intended to alert the user to the presence of important operating and maintenance (servicing) instructions in the literature accompanying the appliance.

CAUTION

The use of optical instruments with this product will increase eye hazard.

INFORMATION

This equipment has been tested and found to comply with the limits for a Class B digital device, pursuant to Part 15 of the FCC Rules. These limits are designed to provide reasonable protection against harmful interference in a residential installation. This equipment generates, uses, and can radiate radio frequency energy and, if not installed and used in accordance with the instructions, may cause harmful interference to radio communications. However, there is no guarantee that interference will not occur in a particular installation. If this equipment does cause harmful interference to radio or television reception, which can be determined by turning the equipment off and on, the user is encouraged to try to correct the interference by one or more of the following measures:

- Reorient or relocate the receiving antenna.
- Increase the separation between the equipment and receiver.
- Connect the equipment into an outlet on a circuit different from that to which the receiver is connected.
- Consult the dealer or an experienced radio/TV technician for help.

CAUTION

You are cautioned that any changes or modifications not expressly approved in this manual could void your authority to operate this equipment.

NOTICE FOR THE CUSTOMERS IN CANADA

CAUTION

TO PREVENT ELECTRIC SHOCK, DO NOT USE THIS POLARIZED AC PLUG WITH AN EXTENSION CORD, RECEPTACLE OR OTHER OUTLET UNLESS THE BLADES CAN BE FULLY INSERTED TO PREVENT BLADE EXPOSURE.

This system is equipped with the Dolby® B-type noise reduction system.

* Dolby noise reduction manufactured under license from Dolby Laboratories Licensing Corporation. “DOLBY” and the double-D symbol  are trademarks of Dolby Laboratories Licensing Corporation.



A946

Table of Contents

Getting Started

Step 1: Hooking up the system	4
Step 2: Setting the time	6
Step 3: Presetting radio stations	
— Preset	7
Connecting optional components	8

Basic Operations

Playing a CD — Normal Play	11
Recording from a CD to a tape	
— CD Synchro Recording	12
Listening to the radio — Preset Tuning ..	13
Recording from the radio	15
Playing a tape	16

The CD Player

Checking the remaining playing time on the CD	18
Playing CD tracks repeatedly	
— Repeat Play	18
Playing CD tracks in random order	
— Shuffle Play	19
Playing CD tracks in a favorite order	
— Program Play	20

The Tape Deck

Recording to a tape manually	21
Recording your favorite CD tracks to a tape	
— Program Edit	22

Other Features

Adjusting the sound	23
Using the Radio Data System (RDS)*	24
Falling asleep to music	
— Sleep Timer	24
Waking up to music — Daily Timer	25
Timer-activated recording of radio programs — REC Timer	26

Additional Information

Precautions	28
Troubleshooting	29
Specifications	31
Parts identification for the remote	33
Index	34

* European model only

Step 1: Hooking up the system

Follow steps **1** through **4** of the procedure below to hook up your system using the supplied cords and accessories.

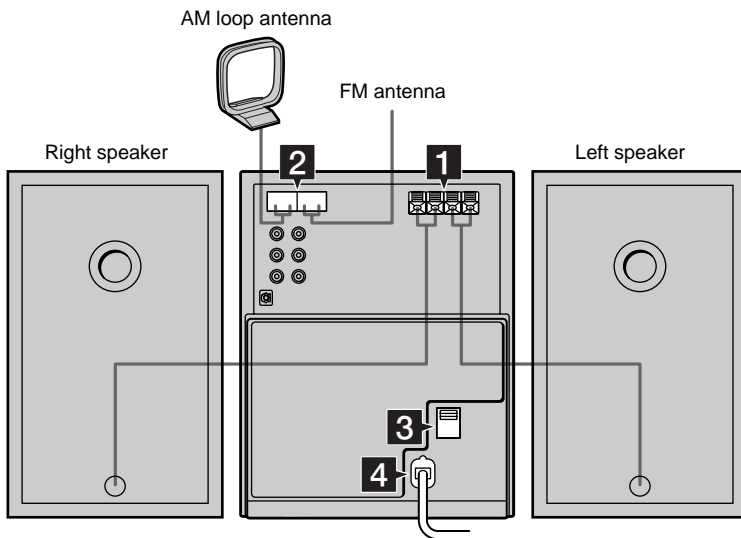

1 Connect the speakers.

Connect the right and left speaker cords to the SPEAKER terminals of the same color.

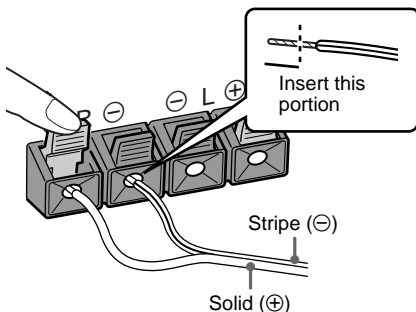

Note

Keep the speaker cords away from the antennas to prevent noise.

2 Connect the FM and AM antennas.

Set the AM loop antenna up before connecting it.

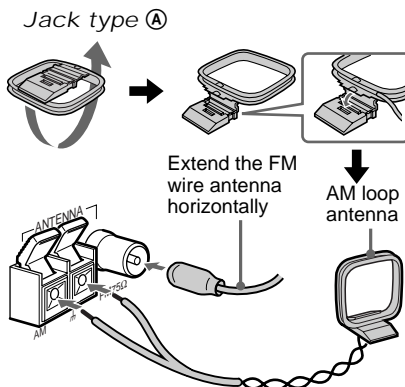

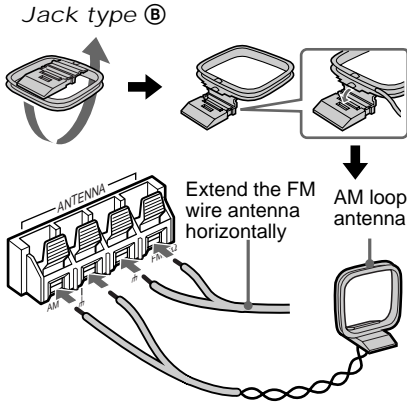

Inserting two size-AA (R6) batteries into the remote

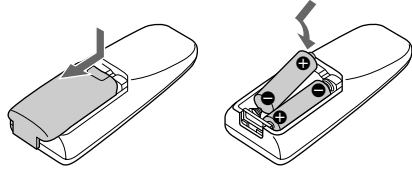

Tip

With normal use, the batteries should last for about six months. When the remote no longer operates the system, replace both batteries with new ones.

Notes on batteries

- Make sure the battery poles (plus/minus) are properly oriented.
- Do not use a new battery with an old one.
- Do not use different types of batteries together.
- If you do not use the remote for a long period of time, remove the batteries to prevent possible damage from battery leakage and corrosion.
- Do not use a battery that is leaking.
- If a battery has leaked, clean the battery compartment and replace all the batteries.
- Do not place the remote in an extremely hot or humid place.
- Do not expose the remote sensor to direct sunlight or lighting apparatuses. Doing so may cause a malfunction.

- 3** For models with a voltage selector, set **VOLTAGE SELECTOR** to the local power line voltage.



- 4** Connect the power cord to a wall outlet. If the plug does not fit the wall socket, detach the supplied plug adaptor (only for models equipped with an adaptor).

Step 2: Setting the time

Before you can use the system's timer functions, set the internal clock.

The clock uses a 24-hour system on the European model, and a 12-hour system on other models.

The 24-hour system is used here for illustration purposes.

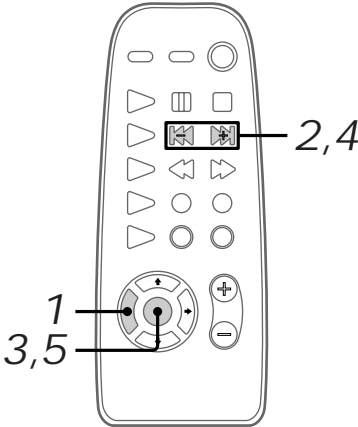

- 1 Press **TIMER SET**.
The hour indication flashes.



- 2 Press **◀◀/▶▶** repeatedly to set the hour.

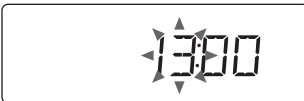

- 3 Press **ENTER**.
The minute indication flashes.



- 4 Press **◀◀/▶▶** repeatedly to set the minute.



- 5 Press **ENTER**.
The clock will begin operating.

To reset the system clock

You can reset the system clock even when the system is on or off.

- 1 Press **TIMER SET**.
- 2 Press **◀◀/▶▶** repeatedly until "SET CLOCK" appears, then press **ENTER**.
- 3 Repeat step 2 to 5 in "Step 2: Setting the time".

Tip

If you make a mistake, start over from step 1.

Step 3: Presetting radio stations — *Preset*

The system can store a total of 30 preset stations (20 for FM and 10 for AM). This section explains how to tune in stations and preset them.

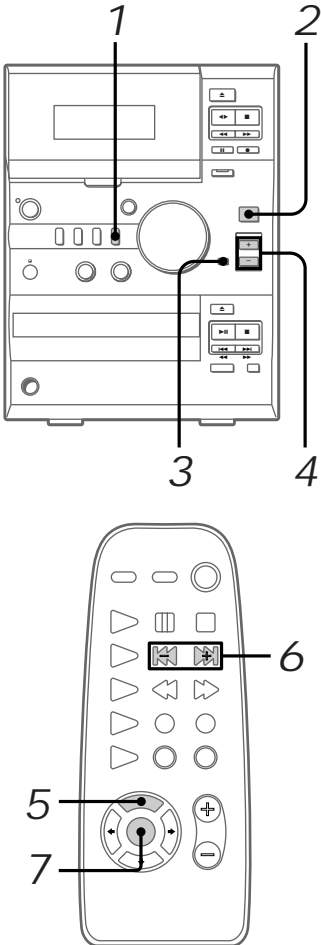

- 1 Press TUNER.
“TUNER” appears.
- 2 Press TUNER BAND to select FM or AM.
- 3 Press TUNING MODE repeatedly until “AUTO” appears.
- 4 Press TUNING +/- .
The frequency changes as the system scans for a station. Scanning stops automatically when a station is tuned in. At that time, “TUNED” and “STEREO” (for stereo programs only) appear.



- 5 Press MEMORY on the remote.
A preset number flashes.



- 6 Press <<</>>> on the remote repeatedly to select the preset number that you want.



- 7 Press ENTER on the remote.
The station is stored to the selected preset number.
- 8 Repeat steps 2 through 7 to preset other stations.

continued

Step 3: Presetting radio stations (continued)

To tune in a weak station

In step 3, press TUNING MODE repeatedly until “AUTO” and “PRESET” disappear, then press TUNING +/- repeatedly to tune in the station.

To change the preset number

Start over from step 2.

Tip

The preset stations are saved in the system’s memory for about two days even if you disconnect the power cord or a power failure occurs.

To change the AM tuning interval (not applicable on the European and Middle Eastern models)

The AM tuning interval is factory-preset to 9 kHz (or 10 kHz on North American model). To switch the AM tuning interval, tune in any AM station first, then turn off the system. Pressing TUNING + down, turn the system back on. When you change the interval, all the AM preset stations are erased. To change back to the original interval, tune in any AM station first, then turn off the system. Pressing TUNING – down, turn the system back on.

Connecting optional components

This section explains how to connect a variety of components to your system in order to enhance it. Refer to the instructions included with each component for details.

Connecting audio components

Connecting an MD deck for analog recording

You can connect an MD deck to the system with commercially available audio cords. Be sure to match the color-coded pins to the appropriate jacks. To listen to the MD deck after connecting it, press MD/VIDEO until “MD” appears.

To the audio input jacks on the MD deck

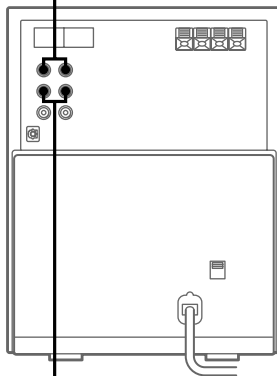

To the audio output jacks on the MD deck

Connecting an MD deck for digital recording

By connecting an MD deck to the system with a commercially available optical cable, you can make a digital recording from a CD.

To the digital input connector on the MD deck

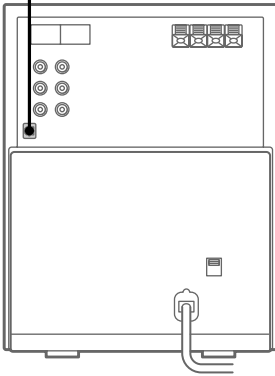

Connecting a VCR

You can connect a VCR to the system with a commercially available audio cord. Be sure to match the color-coded pins to the appropriate jacks. To listen to the VCR after connecting it, press MD/VIDEO until "VIDEO" appears.

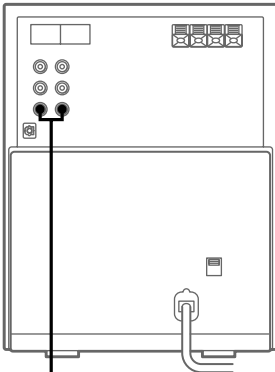

To the audio output jacks on the VCR

Connecting headphones

Connect headphones to the PHONES jack.

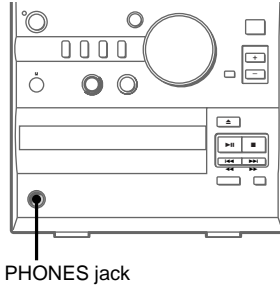

Connecting external antennas

You can connect an external antenna to your system to get better reception.

FM antenna

Connect a commercially available external FM antenna to the FM ANTENNA terminal(s) as shown below. You may also connect a TV antenna for the same purpose.

Jack type ①

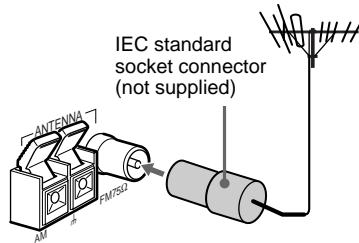

continued

Connecting optional components (continued)

Jack type ②

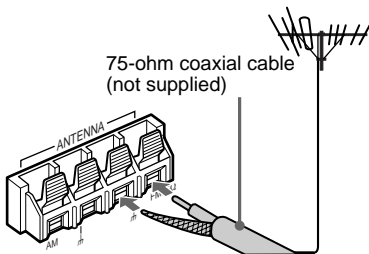

AM antenna

For the AM antenna, use a 6- to 15-meter, horizontally extended insulated wire, with one end connected to the AM ANTENNA terminals as shown below. Leave the supplied AM loop antenna connected.

Jack type ①

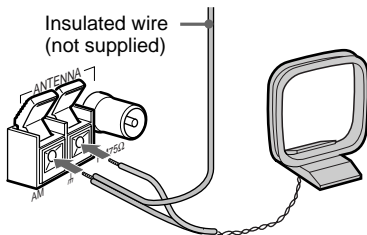

Jack type ②

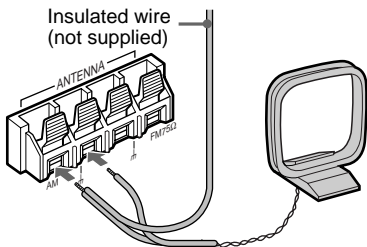

Playing a CD — Normal Play

Do the procedure below to play a CD starting from the first track.

To turn on the system, press I/⏻.

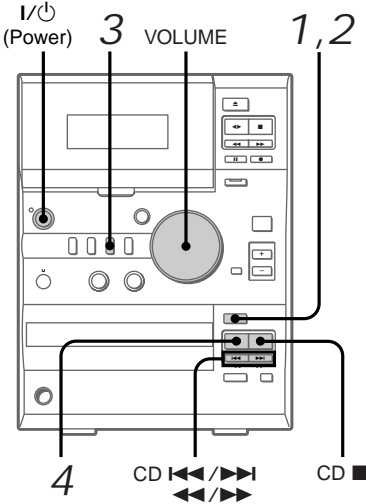

- Press CD ►►. Playback starts.

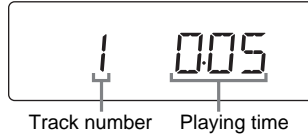

To	Do this
Stop playback	Press CD ■.
Pause	Press CD ►►. Press again to resume playback.
Select a track	During playback or pause, press CD ◀◀ or CD ▶▶ repeatedly until you find the desired track.
Locate a desired point in a track	During playback, press down CD ◀◀ or CD ▶▶ until you find the desired point.
Remove or replace the CD	Press CD EJECT ▲.
Adjust the volume	Turn VOLUME.

- Press CD EJECT ▲ and place a CD on the disc tray. The disc tray opens.

Place with the label side up. When you play a CD single (8 cm CD), place it on the inner circle of the tray.

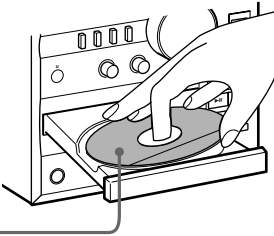

Tips

- If you press CD ►► when the power is off, the system automatically turns on and the CD starts playing if there is a CD on the disc tray (One Touch Play).
- To switch to the CD while listening to another source, press CD ►►. The CD will automatically start playing (Automatic Source Selection).
- “NO DISC” appears in the display if there is no CD on the disc tray.

- Press CD EJECT ▲ again to close the disc tray.
- Press CD. “CD” appears.

Recording from a CD to a tape

— CD Synchro Recording

The CD Synchro Recording function makes it easy to record from a CD to a tape. Both Type I (normal) and Type II (CrO₂) tapes can be used. To record only the tracks that you want, it is convenient to use the Program Edit function (see page 22).

To turn on the system, press I/⏻.

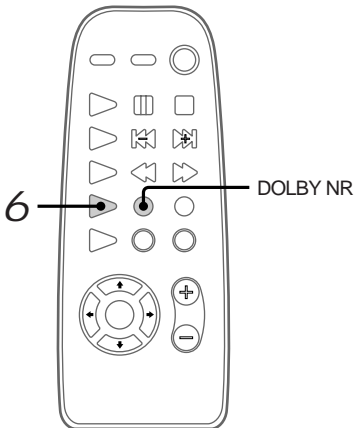
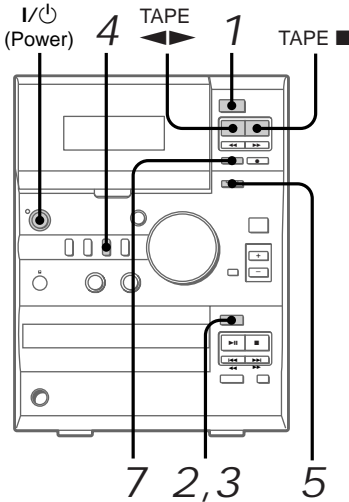

- 1 Press TAPE EJECT ▲ and insert a recordable tape into the cassette holder.

With the side you want to record on facing towards you

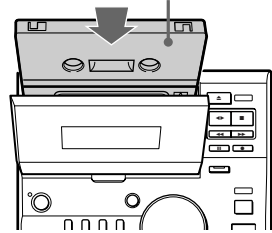

- 2 Press CD EJECT ▲ and place a CD on the disc tray.

Place with the label side up. When you play a CD single (8 cm CD), place it on the inner circle of the tray.

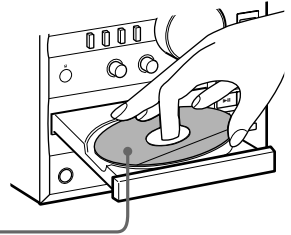

- 3 Press CD EJECT ▲ again to close the disc tray.

- 4 Press CD. "CD" appears.

- 5 Press CD SYNC. The tape stands by for recording and the CD stands by for playback. "REC" and "▶" (or "◀") appear, and the CD SYNC indicator lights up.

-
- 6 Press DIR MODE on the remote repeatedly to select “↔” to record on one side of the tape, or “↔)” or “(↔)” to record on both sides.
-

- 7 Press TAPE ■.
Recording starts.
-

To stop recording

Press TAPE ■.

Tips

- To record with the Dolby NR system on, press DOLBY NR on the remote before step 7. “□□” appears.
- To start recording on the side facing away from you, after doing step 5, press TAPE ◀▶ until “REC▶” changes to “◀REC.”

Note

You cannot listen to another source during CD Synchro Recording.

Listening to the radio

— Preset Tuning

Presetting radio stations in the system’s memory in advance makes it easy to tune in those stations later (see “Step 3: Presetting radio stations” on page 7).

To turn on the system, press I/⏻.

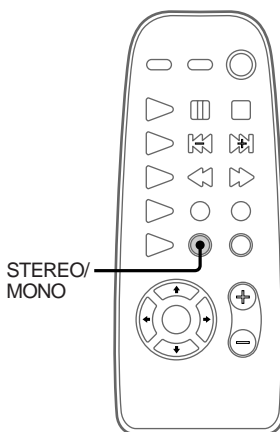
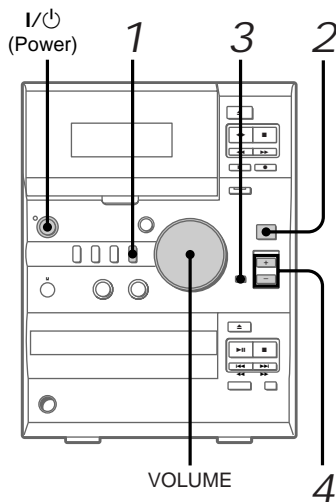

continued

Listening to the radio (continued)

- 1 Press TUNER.
“TUNER” appears.
- 2 Press TUNER BAND to select FM or AM.
- 3 Press TUNING MODE repeatedly until “PRESET” appears.
- 4 Press TUNING +/- repeatedly to display the preset number of the desired station.

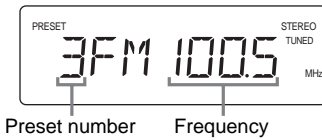

To	Do this
Turn off the radio	Press I/⏻.
Adjust the volume	Turn VOLUME.

To tune in a non-preset radio station

In step 3, press TUNING MODE repeatedly until “AUTO” and “PRESET” disappear, then press TUNING +/- repeatedly to tune in the desired station (Manual Tuning).

Tips

- If you press TUNER BAND when the power is off, the system automatically turns on and tunes in the station last received (One Touch Play).
- To switch to the radio while listening to another source, press TUNER BAND (Automatic Source Selection).
- If there is static during an FM broadcast, press STEREO/MONO on the remote until “MONO” appears. After “MONO” scrolls across the display, the frequency will appear. The broadcast will no longer be in stereo, but the reception will improve. Press this button again to restore the broadcast to stereo.
- To improve the reception, adjust the supplied antennas or connect an external antenna (see “Connecting external antennas” on page 9).

Recording from the radio

Do the procedure below to tune in a preset station (see page 13) and record from the radio to a tape. Both Type I (normal) and Type II (CrO₂) tapes can be used.

To turn on the system, press I/⏻.

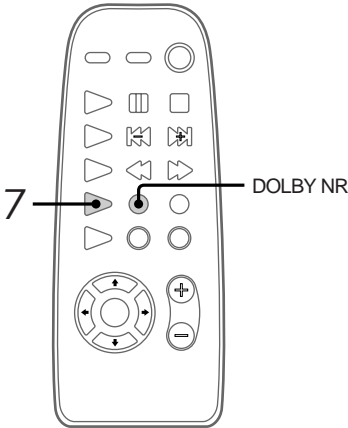
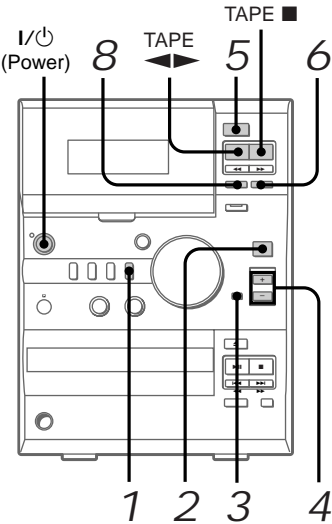

- 2 Press TUNER BAND to select FM or AM.
- 3 Press TUNING MODE repeatedly until "PRESET" appears.
- 4 Press TUNING +/- repeatedly to display the preset number of the desired station.

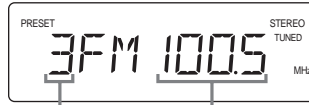

Preset number Frequency

- 5 Press TAPE EJECT ▲ and insert a recordable tape into the cassette holder.

With the side you want to record on facing towards you

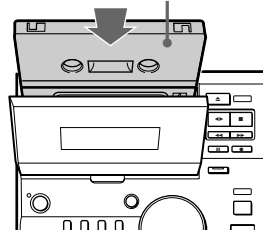

- 6 Press REC ●. The tape stands by for recording. "REC" and "▶" (or "◀") appear.
- 7 Press DIR MODE on the remote repeatedly to select "↔" to record on one side of the tape, or "↔" or "↔↔" to record on both sides.

continued

- 1 Press TUNER. "TUNER" appears.

Recording from the radio (continued)

- 8 Press **TAPE ■■**.
Recording starts.

To stop recording

Press **TAPE ■■**.

Tips

- To record from a non-preset station, press **TUNING MODE** repeatedly in step 3 until "AUTO" and "PRESET" disappear, then press **TUNING +/-** repeatedly to tune in the desired station.
- To record with the Dolby NR system on, press **DOLBY NR** on the remote before step 8. "DOLBY NR" appears.
- To start recording on the side facing away from you, after doing step 6, press **TAPE ◀▶** until "REC" changes to "4 REC."
- If you hear static while you are recording an AM radio program, adjust the AM antenna to improve the reception.

Playing a tape

The system can play three types of tapes: Type I (normal), Type II (CrO₂) and Type IV (metal). The system automatically detects the tape type so there is no need to specify it.

To turn on the system, press **I/⏻**.

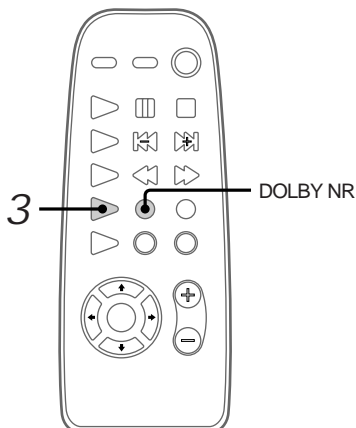
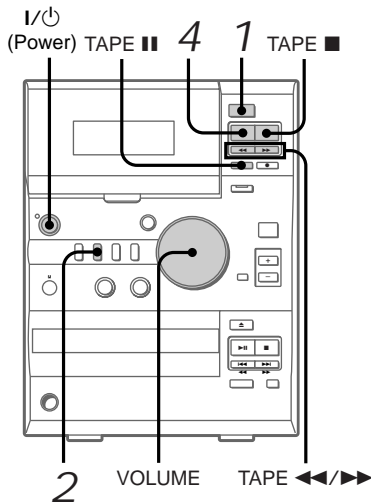

1 Press TAPE EJECT ▲ and insert a recorded tape into the cassette holder.

With the side you want to play facing towards you

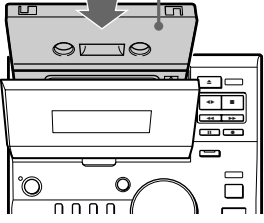

2 Press TAPE.
“TAPE” appears.

3 Press DIR MODE on the remote repeatedly to select “↔” to play one side of the tape, “↔↔” to play both sides, or “↔↔”* to play both sides repeatedly.
* The tape automatically stops after playing back five times.

4 Press TAPE ◀▶.
The tape starts playing.
To change the playback direction, press TAPE ◀▶ again. The reverse side will begin playing.

Tips

- If you press TAPE ◀▶ when the power is off, the system automatically turns on and starts playing the tape if there is a tape in the holder (One Touch Play).
- To switch to the tape while listening to another source, press TAPE ◀▶ while the tape is stopped. The tape will automatically start playing (Automatic Source Selection).
- To play a tape recorded with the Dolby NR system, press DOLBY NR on the remote before step 4. “NR” appears.

To	Do this
Stop playback	Press TAPE ■.
Pause	Press TAPE . Press again to resume playback.
Fast-forward or rewind	With the tape stopped, press TAPE ►► or TAPE ◀◀.
Remove or replace the tape	Press TAPE EJECT ▲.
Adjust the volume	Turn VOLUME.

Checking the remaining playing time on the CD

Do the procedure below to check the remaining playing time of the current track or the entire CD.

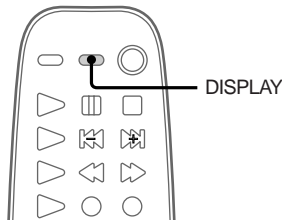

➔ Press DISPLAY.

Each time you press this button, the display changes as follows:

During playback

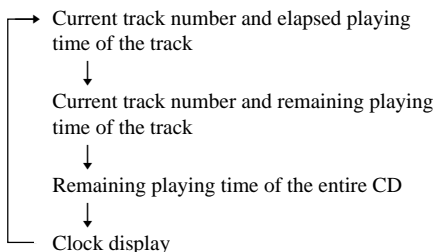

Tip

Each time you press DISPLAY while the CD (or tape) is stopped, the display changes as follows:

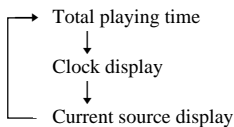

Note

If the CD contains 25 tracks or more, the remaining playing time of the current track will appear as “- - - - -” for each track starting with the 25th.

Playing CD tracks repeatedly — Repeat Play

The Repeat Play function lets you playback a single track or all the tracks on a CD repeatedly in Normal Play. You can also use Repeat Play function while in Shuffle Play or Program Play.

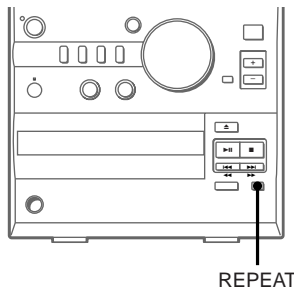

➔ Press REPEAT repeatedly during playback until “REPEAT” appears. Repeat Play starts. The following table describes the two repeat modes.

To repeat	Press
All the tracks on the CD	REPEAT repeatedly until “REPEAT” appears.
Only the currently playing track	REPEAT repeatedly until “REPEAT 1” appears.

To cancel Repeat Play

Press REPEAT repeatedly until “REPEAT” and “REPEAT 1” disappear.

Playing CD tracks in random order – Shuffle Play

You can use this function to playback all the tracks on a CD in random order.

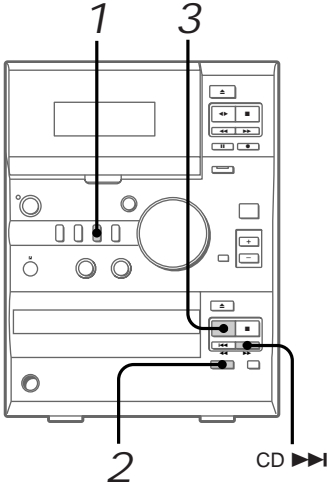

To cancel Shuffle Play

Press PLAY MODE repeatedly until “SHUFFLE” disappears.

Tips

- You can also start Shuffle Play during Normal Play by selecting “SHUFFLE”.
- To skip a track, press CD ►►.

Note

You cannot go back to the preceding track by pressing CD ◀◀.

1 Press CD.
“CD” appears.

2 Press PLAY MODE repeatedly until
“SHUFFLE” appears.

3 Press CD ►►.
Shuffle Play starts. “[]” appears while the next track is being selected, and all the tracks play in random order.

Playing CD tracks in a favorite order

— Program Play

You can make a program of up to 24 tracks on a CD in any order that you want. After setting the order, you can also make a synchronized tape recording of the tracks (see page 22).

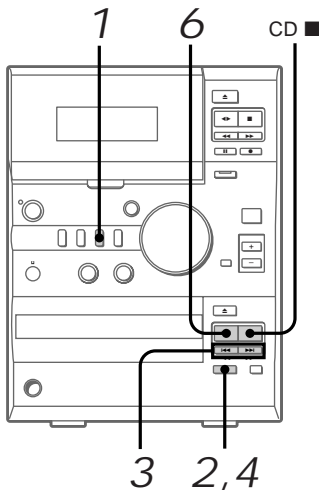

1 Press CD.
“CD” appears.

2 Press PLAY MODE repeatedly until “PGM” appears.

3 Press CD ◀◀ or CD ▶▶ repeatedly until the desired track number appears.

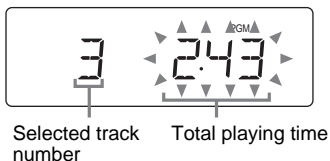

4 Press PLAY MODE.
The selected track is programmed. “STEP” appears, followed by the number of the selection just programmed.

5 To program additional tracks, repeat steps 3 and 4.

6 Press CD ▶▶.
Program Play starts. The tracks play in the order that they were programmed.

To cancel Program Play

Press PLAY MODE repeatedly until “PGM” disappears.

To	Do this
Add a track to the end of the program	Do steps 3 and 4 with Program Play stopped.
Erase the entire program	Press CD ■ with Program Play stopped.

Tips

- The program you made remains in the system’s memory until you turn off the system or remove the CD. After the program finishes, press CD ▶▶ to play the program again.
- When the total playing time of the programmed tracks exceeds 100 minutes, “- - -” appears in the display.
- If you try to program more than 24 tracks, “PGM FULL” appears in the display.

Recording to a tape manually

Do the procedure below to manually record from any source to a tape. For example, tracks from a CD, the radio, or from any of the connected components. This lets you record just the songs that you want from a CD.

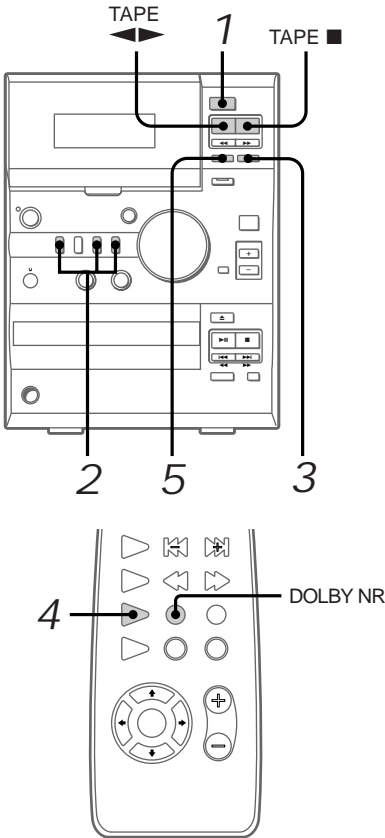

- 1 Press TAPE EJECT ▲ and insert a recordable tape.
- 2 Press the button of the source you want to record from.
 - CD: To record from the CD
 - TUNER: To record from the radio
 - MD/VIDEO: To record from optional component
- 3 Press REC ●. The tape stands by for recording. “REC” and “▶” (or “◀”) appear.
- 4 Press DIR MODE on the remote repeatedly to select “↔” to record on one side of the tape, or “↔↔” or “↔↔” to record on both sides.
- 5 Press TAPE ■. Recording starts.
- 6 Start playing the source you want to record from.

To	Press
Stop recording	TAPE ■.
Pause recording	TAPE ■■.

Tips

- To record with the Dolby NR system on, press DOLBY NR on the remote before step 5. “DOLBY NR” appears.
- To start recording on the side facing away from you, after doing step 3, press TAPE ◀ until “REC▶” changes to “◀REC”.

Recording your favorite CD tracks to a tape

— Program Edit

With Program Edit function, you can select only the CD tracks that you want using the Program Play function, then record the programmed tracks to a tape using the CD Synchro Recording function.

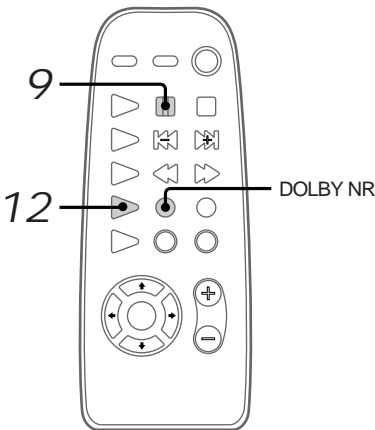
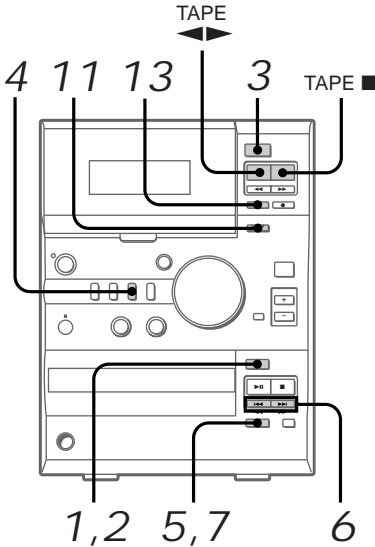

- 1 Press CD EJECT ▲ and place a CD.
- 2 Press CD EJECT ▲ again to close the disc tray.
- 3 Press TAPE EJECT ▲ and insert a recordable tape.
- 4 Press CD.
“CD” appears.
- 5 Press PLAY MODE repeatedly until “PGM” appears.
- 6 Press CD ◀◀ or CD ▶▶ repeatedly until the desired track number appears.



- 7 Press PLAY MODE.
- 8 Repeat steps 6 and 7 to add more tracks to be recorded.
- 9 Press  on the remote where you want the system to begin recording on the side facing away from you.

When the system detects this command, the CD pauses, the tape reverses direction, and then the system resumes recording with the next CD track on the tape side facing away from you.

10 Repeat steps 6 and 7 to select tracks to be recorded on the side of the tape facing away from you.

11 Press CD SYNC.
The tape stands by for recording and the CD stands by for playback.
“REC” and “▶” (or “◀”) appear, and the CD SYNC indicator lights up.

12 Press DIR MODE on the remote repeatedly to select “↔” to record on one side of the tape, or “↔▶” or “◀↔” to record on both sides.

13 Press TAPE ■.
Recording starts.

To stop recording

Press TAPE ■.

To cancel Program Edit

Press PLAY MODE repeatedly until “PGM” disappears.

Tips

- To record with the Dolby NR system on, press DOLBY NR on the remote before step 13. “DNR” appears.
- To start recording on the side facing away from you, after doing step 11, press TAPE ◀▶ until “REC▶” changes to “◀REC”.

Adjusting the sound

Not only can you adjust the bass and treble, you can use the DSG (Dynamic Sound Generator) function to enjoy a more powerful sound.

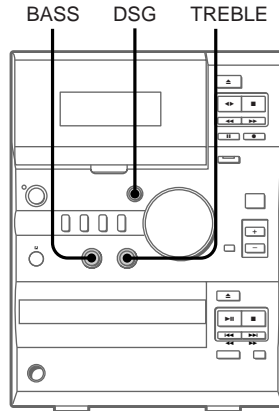

Generating a more dynamic sound

➔ Press DSG.

To cancel the DSG

Press DSG again.

Adjusting the bass

➔ Turn BASS.

You can adjust the bass in 7 steps (+3 ~ 0 ~ -3).

Adjusting the treble

➔ Turn TREBLE.

You can adjust the treble in 7 steps (+3 ~ 0 ~ -3).

Using the Radio Data System (RDS)

(European model only)

What is the Radio Data System?

Radio Data System (RDS)* is a broadcasting service that allows radio stations to send additional information along with the regular program signal.

Note

RDS may not work properly if the station you have tuned in is not transmitting the RDS signal properly or if the signal is weak.

* Not all FM stations provide RDS service, nor do they all provide the same types of services. If you are not familiar with the RDS system, check with your local radio stations for details on RDS services in your area.

Receiving RDS broadcasts

➔ Simply select a station from the FM band.

When you tune in a station that provides RDS services, the station name appears in the display.

To check the RDS information

Each time you press DISPLAY on the remote, the display changes as follows:

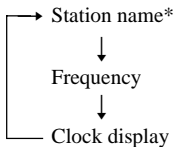

* If the RDS broadcast is not properly received, the station name may not appear in the display.

Falling asleep to music

— Sleep Timer

The Sleep Timer function lets you specify a sleep time, after which the system stops playing and turns off automatically. You can thus fall asleep to music.

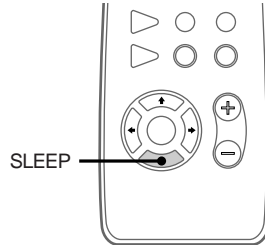

➔ Press SLEEP.

Each time you press this button, the sleep time changes as follows:

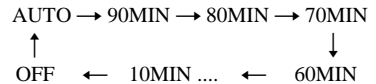

When you choose "AUTO"

The system turns off after the current CD or tape finishes playing (up to 100 minutes). The system also turns off when you manually stop the CD or tape.

To check the remaining sleep time

Press SLEEP once.

To change the sleep time

Press SLEEP repeatedly until the time you want appears.

To cancel the Sleep Timer function

Press SLEEP repeatedly until "OFF" appears.

Waking up to music

— Daily Timer

By setting the Daily Timer, you can make the system automatically turn on and off at specified times. To use this function, make sure that you have set the system clock correctly (see “Step 2: Setting the time” on page 6).

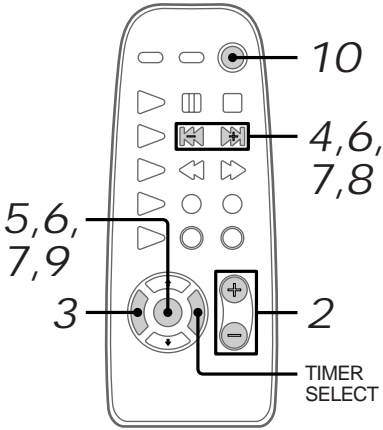

4 Press **⏮** or **⏭** repeatedly until “SET DAILY” appears. “SET DAILY” scrolls and “⊖ DAILY” appears in the display.

5 Press **ENTER**. “ON TIME” appears, then the hour indication flashes.



6 Set the starting time. Press **⏮** or **⏭** repeatedly to set the hour, then press **ENTER**. The minute indication begins flashing next.



Press **⏮** or **⏭** repeatedly to set the minute, then press **ENTER**. “OFF TIME” appears, then the hour indication flashes again.

7 Set the stopping time by repeating step 6.

8 Press **⏮** or **⏭** repeatedly until the music source you want appears. Each time you press the button, the display changes as follows:

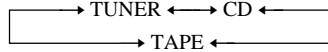

continued

- 1 Prepare the music source you want to listen to when the system turns on.
- CD: Place a CD. To start playing from a specific track, make a program (see “Playing CD tracks in a favorite order” on page 20).
 - Tape: Insert a tape with the side you want to play on facing towards you.
 - Radio: Tune in the preset radio station that you want (see “Listening to the radio” on page 13).

2 Press **VOL +/-** repeatedly to adjust the volume.

3 Press **TIMER SET**.

-
- 9 Press ENTER.
The starting time, the stopping time, and the music source appear in turn, then the original display returns.
-

- 10 Press I/⏻ to turn off the system.
-

To check the settings

Press TIMER SELECT repeatedly until “⌚ DAILY” appears in the display.

The preset items appear in turn.

To turn off the Daily Timer

Press TIMER SELECT repeatedly until “⌚ DAILY” disappears. To turn the timer on again, press TIMER SELECT repeatedly until “⌚ DAILY” appears, then press I/⏻ to turn off the system.

Tip

Once you set the Daily Timer, the time settings will remain in the system’s memory until you change them, even when you turn the system or the Daily Timer off. The settings that were last used will be in effect when you turn the timer on again.

Notes

- The system will turn on 15 seconds before the specified starting time.
- The timer will not operate if the starting time and the stopping time are the same.
- When you have set the Sleep Timer, the Daily Timer will not operate until the Sleep Timer function is turned off.
- You cannot operate the Daily Timer and the REC Timer (see this page) at the same time.

Timer-activated recording of radio programs — REC Timer

Set the REC Timer to make the system start recording from a preset radio station at a specified time (see “Step 3: Presetting radio stations” on page 7). To use this function, make sure that you have set the system clock correctly (see “Step 2: Setting the time” on page 6).

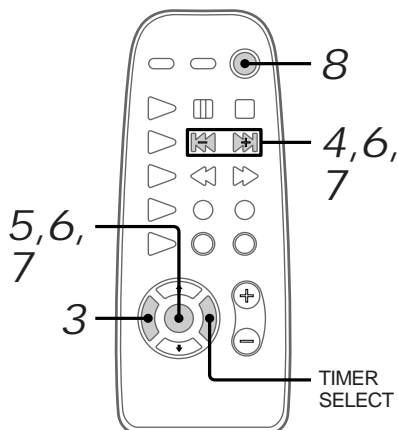

-
- 1 Tune in the preset radio station that you want to record from (see “Listening to the radio” on page 13).

 - 2 Insert a recordable tape with the side you want to record on facing towards you.

 - 3 Press TIMER SET.

-
- 4 Press **◀◀** or **▶▶** repeatedly until “SET REC” appears.
“SET REC” scrolls and “⊖ REC” appears in the display.
-

- 5 Press **ENTER**.
“ON TIME” appears, then the hour indication flashes.



- 6 Set the starting time.
Press **◀◀** or **▶▶** repeatedly to set the hour, then press **ENTER**.
The minute indication begins flashing next.



- Press **◀◀** or **▶▶** repeatedly to set the minute, then press **ENTER**.
“OFF TIME” appears, then the hour indication flashes again.
-

- 7 Set the stopping time by repeating step 6.
The starting time, the stopping time, “TUNER”, and the preset station appear in turn, then the original display returns.
-

- 8 Press **I/⏻** to turn off the system.
When recording starts, the volume level is automatically set to the minimum.
-

To check the settings

Press **TIMER SELECT** repeatedly until “⊖ REC” appears in the display.

The preset items appear in turn.

To turn off the REC Timer

Press **TIMER SELECT** repeatedly until “⊖ REC” disappears. To turn the timer on again, press **TIMER SELECT** repeatedly until “⊖ REC” appears, then press **I/⏻** to turn off the system.

Tip

Once you set the REC Timer, the time settings will remain in the system’s memory until you change them, even when you turn the system or the REC Timer off. The settings that were last used will be in effect when you turn the timer on again.

Notes

- The system will turn on 15 seconds before the specified starting time.
- If the power is on at the specified starting time, recording will not occur.
- The timer will not operate if the starting time and the stopping time are the same.
- When you have set the Sleep Timer, the REC Timer will not operate until the Sleep Timer function is turned off.
- You cannot operate the Daily Timer and the REC Timer at the same time.

Precautions

On operating voltage

Before operating the system, check that the operating voltage of your system is identical with the voltage of your local power supply.

On safety

- The unit is not disconnected from the AC power source (mains) as long as it is connected to the wall outlet, even if the unit itself has been turned off.
- Unplug the system from the wall outlet (mains) if it will not be used for an extended period of time. To disconnect the power cord (mains lead), pull it out by the plug. Never pull the cord itself.
- Should any solid object or liquid fall into the system, unplug the system and have it checked by qualified personnel before operating it any further.
- AC power cord must be changed only at the qualified service shop.

On placement

- Place the system in a location with adequate ventilation to prevent heat build-up in the system.
- Do not place the system in an inclined position.
- Do not place the system in locations where it is:
 - Extremely hot or cold
 - Dusty or dirty
 - Very humid
 - Subject to vibrations
 - Subject to direct sunlight

On operation

- If the system is brought directly from a cold place to a warm place, or is placed in a very damp room, moisture may condense on the lens inside the CD player. Should this occur, the system will not operate properly. Remove the CD and leave the system turned on for about an hour until the moisture evaporates.
- When moving the unit, remove any disc that may be on the disc tray.

If you have any questions or problems concerning your system, please consult your nearest Sony dealer.

Notes on CDs

- Before playing a CD, clean the CD surface with a cleaning cloth. Wipe the CD from the center out.
- Do not play a CD with tape, stickers, or adhesives on any of its surfaces as this may damage the system.
- Do not clean CDs with solvents such as benzene, thinner, commercially available cleaners or antistatic sprays intended for vinyl LPs.
- Do not expose CDs to direct sunlight or heat sources such as hot air ducts, or leave it in a car parked in direct sunlight.

To save a tape permanently

To prevent a tape from being accidentally recorded over, break off the cassette tabs from side A or side B as illustrated.

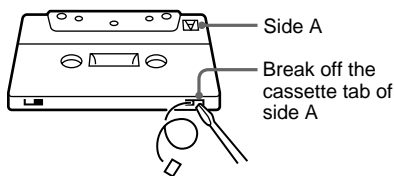
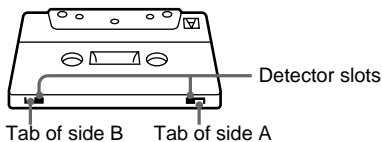

If you later want to reuse the tape for recording, cover the broken tab with adhesive tape. However, be careful not to cover the detector slots which allow the tape player to automatically detect the type of tape.

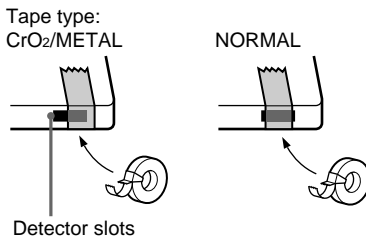

Before placing a cassette in the tape deck

Take up any slack in the tape. Otherwise the tape may get entangled in the tape deck's playing mechanism and become damaged.

When using a tape longer than 90 minutes

The tape is very elastic. Do not change the tape operations such as play, stop, and fast-winding etc. too frequently. The tape may get entangled in the tape deck's playing mechanism.

Cleaning the tape heads

Clean the tape heads after every 10 hours of use.

When the tape heads become dirty

- the sound becomes distorted
- the sound level decreases
- the sound drops out
- the tape does not erase completely
- the tape does not record

Make sure to clean the tape heads before making an important recording or after playing an old tape. Use a commercially available dry-type or wet-type cleaning cassette. For details, refer to the instructions of the cleaning cassette.

Demagnetizing the tape heads

Demagnetize the tape heads and the metal parts that have contact with the tape after every 20 to 30 hours of use with a commercially available demagnetizing cassette. For details, refer to the instructions of the demagnetizing cassette.

Cleaning the cabinet

Clean the cabinet, panel and controls with a soft cloth slightly moistened with mild detergent solution. Do not use any type of abrasive pad, scouring powder or solvent such as thinner, benzene or alcohol.

Troubleshooting

Should you encounter a problem with your system, do the following:

- 1 Make sure the power cord and speaker cords are correctly and firmly connected.
- 2 Find your problem in the troubleshooting checklist below and take the indicated corrective action.

If the problem persists after doing all of the above, consult your nearest Sony dealer.

General

There is no sound from the speakers.

- Adjust VOLUME.
- The headphones are connected.
- Check the speaker connections.

There is severe hum or noise.

- A TV or VCR is placed too close to the unit. Move the unit away from the TV or VCR.

“0:00” (or “AM 12:00”) flashes in the display.

- A power interruption has occurred. Set the clock (see page 6) and timer settings (see pages 25 and 26) again.

The timer does not function.

- Make sure the clock is correctly set (see page 6).

“☹ DAILY” and “☹ REC” do not appear when you press TIMER SELECT on the remote.

- Make sure each timer is correctly set (see pages 25 and 26).
- Make sure the clock is correctly set (see page 6).

The color on the TV screen is irregular.

- Move the speakers farther away from the TV set.

continued

The remote does not work.

- There is an obstacle between the remote and the unit.
 - You are not pointing the remote in the direction of the system's sensor.
 - The batteries in the remote have run down. Replace the batteries.
 - Make sure that the batteries are inserted correctly.
-

Speakers

Sound comes from only one channel, or the left and right volumes are unbalanced.

- Check the speaker connections and placement.
-

CD Player

The CD will not play.

- The CD is dirty.
 - The surface of the CD is scratched. Replace the CD.
 - The CD is inserted with the label side down.
 - Condensation has built up in the system. Remove the CD and leave the system turned on for about an hour until the moisture evaporates.
-

Play does not start from the first track.

- The player is in Program or Shuffle Play. Press PLAY MODE repeatedly until "PGM" and "SHUFFLE" disappear.
-

Tape Deck

Recording cannot be done.

- There is no tape in the cassette holder.
 - The record protect tab has been removed from the cassette (see page 28).
 - The tape has come to the end.
-

The tape does not record or play, or there is a decrease in sound level.

- The heads are dirty. Clean them (see page 29).
 - The record/playback heads are magnetized. Demagnetize them (see page 29).
-

The tape does not erase completely.

- The record/playback heads are magnetized. Demagnetize them (see page 29).
-

There is excessive wow or flutter, or the sound drops out.

- The capstans or pinch rollers are dirty. Clean them (see page 29).
-

Noise increases or the high frequencies are missing.

- The record/playback heads are magnetized. Demagnetize them (see page 29).
-

There is a severe hum or noise (“TUNED” or “STEREO” flashes).

- Adjust the antenna.
- The signal strength is too weak. Connect an external antenna (see page 9).
- Make sure that the antenna is connected properly.
- Do not bend or roll up the antenna.
- The two wires comprising the FM antenna have been pulled further apart since the system was first purchased. Repair or replace with a new one.
- The AM antenna wire is detached from the stand.

A stereo FM program cannot be received in stereo.

- Press STEREO/MONO on the remote until “STEREO” appears in the display.

Resetting the system

- 1 Disconnect the power cord from the wall outlet.
- 2 Press **I/⏻** down and connect the power cord to the wall outlet again.

The system is reset to the factory settings. All previous settings such as the preset stations, clock, and timers are cleared and must be set again.

Specifications

Amplifier section

For the U.S. model

AUDIO POWER SPECIFICATIONS POWER OUTPUT AND TOTAL HARMONIC DISTORTION:

With 6-ohm loads, both channels driven, from 70 - 20,000 Hz; rated 18 watts per channel minimum RMS power, with no more than 0.9% total harmonic distortion from 250 milliwatts to rated output.

North American model:

Continuous RMS power output (reference):
35 + 35 W
(6 ohms at 1 kHz, 10% THD)

Total harmonic distortion less than 0.07% (6 ohms at 1 kHz, 18 W)

European model:

DIN power output (rated): 30 + 30 W
(6 ohms at 1 kHz, DIN)

Continuous RMS power output (reference):
35 + 35 W
(6 ohms at 1 kHz, 10% THD)

Music power output (reference):
85 + 85 W

Other models:

The following measured at 230 V AC, 60 Hz
DIN power output (rated): 30 + 30 W
(6 ohms at 1 kHz, DIN)

Continuous RMS power output (reference):
35 + 35 W
(6 ohms at 1 kHz, 10% THD)

The following measured at 220 V AC, 60 Hz
DIN power output (rated): 24 + 24 W
(6 ohms at 1 kHz, DIN)

Continuous RMS power output (reference):
27 + 27 W
(6 ohms at 1 kHz, 10% THD)

Inputs

MD IN (phono jacks): Sensitivity 500 mV, impedance 47 kilohms

VIDEO IN (phono jacks): Sensitivity 250 mV, impedance 47 kilohms

Outputs

LINE OUT (phono jacks): Sensitivity 250 mV, impedance 1 kilohm

OPTICAL DIGITAL OUT (CD):
Optical

PHONES (stereo phone jack):
Accepts headphones with an impedance of 8 ohms or more

SPEAKER: Active speaker system, 6 ohms

Specifications (continued)

CD player section

System	Compact disc and digital audio system
Laser	Semiconductor laser ($\lambda = 780$ nm) Emission duration: continuous
Laser output	MAX 44.6 μ W* * This output is the value measured at a distance of 200 mm from the objective lens surface on the optical pick-up block with 7 mm aperture.
Wavelength	780 - 790 nm
Frequency response	2 Hz - 20 kHz (± 0.5 dB)

Tape player section

Recording system	4-track 2-channel stereo
Frequency response (DOLBY NR OFF)	50 - 13,000 Hz (± 3 dB), using a Sony TYPE I cassette 50 - 14,000 Hz (± 3 dB), using a Sony TYPE II cassette
Wow and flutter	$\pm 0.15\%$ W. Peak (IEC) 0.1% W. RMS (NAB) $\pm 0.2\%$ W. Peak (DIN)

Tuner section

FM stereo, FM/AM superheterodyne tuner

FM tuner section

Tuning range	
North American model:	87.5 - 108.0 MHz (100-kHz step)
Other models:	87.5 - 108.0 MHz (50-kHz step)
Antenna	FM wire antenna
Antenna terminals	75 ohm unbalanced
Intermediate frequency	10.7 MHz

AM tuner section

Tuning range	
North American model:	530 - 1,710 kHz (with the tuning interval set at 10 kHz) 531 - 1,710 kHz (with the tuning interval set at 9 kHz)
European model:	531 - 1,602 kHz (with the tuning interval set at 9 kHz)
Middle Eastern model:	531 - 1,602 kHz (with the tuning interval set at 9 kHz)
Other models:	530 - 1,710 kHz (with the tuning interval set at 10 kHz) 531 - 1,602 kHz (with the tuning interval set at 9 kHz)
Antenna	AM loop antenna, external antenna terminal
Intermediate frequency	450 kHz

Speakers

Speaker system	Two-way, bass reflex system
Speaker units	12 cm dia., cone type woofer 2.5 cm dia., semi-dome-type tweeter
Rated impedance	6 ohms
Dimensions (w/h/d)	Approx. 150 \times 252 \times 255 mm
Mass	Approx. 2.6 kg net per speaker

General

Power requirements	
North American model:	120 V AC, 60 Hz
European model:	230 V AC, 50/60 Hz
Australian model:	220 - 240 V AC, 50/60 Hz
Mexican model:	120 V AC, 60 Hz
Other models:	110 - 120 V or 220 - 240 V AC , 50/60 Hz Adjustable with voltage selector
Power consumption	70 W
Dimensions (w/h/d)	Approx. 190 \times 252 \times 310 mm incl. projecting parts and controls
Mass	Approx. 5.6 kg
Supplied accessories	Remote commander (1) AM loop antenna (1) FM wire antenna (1) Batteries (2)

Design and specifications are subject to change without notice.

Parts identification for the remote

You can also operate the system with the supplied remote.

Buttons marked with “*” are provided only on the remote.

TUNER

Remote Button(s)	Function
TUNER/BAND	Selects FM or AM.
TUNING MODE	Selects “AUTO”, “PRESET” or “MANUAL”.
MEMORY*	Presets a station.
STEREO/MONO*	Selects “STEREO” or “MONO”.
⏮/⏭	Selects a preset number.
⏪/⏩	Scans for a station or selects a preset station.

CD

Remote Button(s)	Function
CD ▷	Starts playback.
□	Stops playback.
⏮	Pauses playback.
⏮/⏭	Selects a track (AMS: Automatic Music Sensor).
⏪/⏩	Locates a desired point in a track.
CD REPEAT	Repeats playback.
PLAY MODE	Selects Shuffle, Program or Normal Play.
DISPLAY*	Changes the front panel display.

TAPE

Remote Button(s)	Function
TAPE ◀▶	Starts playback. Each time you press this button, the tape reverses direction.
□	Stops playback.
⏮	Pauses playback.
⏪/⏩	Fast-forwards or rewinds.
● REC	Records to tapes.
DIR MODE*	Selects “↔”, “↔” or “↔”.
DOLBY NR*	Turns on or off the Dolby NR system.

TIMER

Remote Button	Function
SLEEP*	Selects a sleep time.
TIMER SET*	Sets the time, Daily Timer or REC Timer.
TIMER SELECT*	Checks the settings and turns on or off the timer.

OTHERS

Remote Button(s)	Function
I/⏻	Turns on or off the system.
VOL +/-	Adjusts the volume.
DSG	Generates a more dynamic sound.

Index

A

Adjusting

- the bass 23
- the treble 23
- the volume 11, 14, 17

Antennas 4, 9, 10

Automatic Source Selection 11, 14, 17

B

Batteries 5

C

CD player 11, 12, 18

Clock setting 6

Connecting. *See* Hooking up

D, E, F, G

Daily Timer 25

H, I, J, K, L, M

Hooking up

- optional components 8
- the antenna 4, 9, 10
- the power cord 5
- the system 4

N

Normal Play 11

O

One Touch Play 11, 14, 17

P, Q

Playing

- a CD 11
- a tape 16
- tracks in random order (Shuffle Play) 19
- tracks in the desired order (Program Play) 20
- tracks repeatedly (Repeat Play) 18

Presetting radio stations 7

Preset Tuning 13

Program Edit 22

Program Play 20

Protecting recordings 28

R

Radio stations

- presetting 7
- tuning in 13

Recording

- a CD 12
- a radio program 15
- a tape manually 21
- CDs by specifying the track order 22
- timer-activated recording 26

Repeat Play 18

Resetting the system 31

S

Setting the time 6

Shuffle Play 19

Sleep Timer 24

Speakers 4

T

Tape deck 12, 15, 16, 21, 26

Timer

- falling asleep to music 24
- timer-activated recording 26
- waking up to music 25

Troubleshooting 29

Tuner 7, 13, 15

U, V, W, X, Y, Z

Using the display 18

Using the DSG 23

Using the RDS 24

Sony  line

<http://www.world.sony.com/>

Sony Corporation Printed in Korea
