

Panasonic®

OPERATING INSTRUCTIONS

Personal Computer

Model No. **CF-Y7** series

Contents

Getting Started

Introduction	2
Read Me First	3
Description of Parts	11
First-time Operation	13

Getting Started

Useful Information

On-screen Manual	18
Handling and Maintenance	19
Expanding Memory	22
Hard Disk Backup/Restore Function	24
Hard Disk Data Erase Utility	25
Reinstalling Software	26

Useful Information

Troubleshooting

Troubleshooting (Basic)/Error Code/Message	28
Hardware Diagnostics	32

Troubleshooting

Appendix

LIMITED USE LICENSE AGREEMENT	34
Specifications	36
LIMITED WARRANTY	39

Appendix

For further information about the computer, you can refer to the on-screen manual.







To access the on-screen manual
→ page 18 "On-screen Manual"

For your technical support office, refer to
"LIMITED WARRANTY."

Introduction

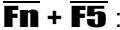
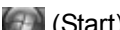
Thank you for purchasing this Panasonic computer. For optimum performance and safety, please read these instructions carefully.

■ Terms and illustrations in these instructions

 :	Conditions that may result in minor or moderate injury.
 :	Useful and helpful information.
 :	Press [Enter] key.
 :	Press and hold [Fn] key, and then press [F5] key.
 (Start) - [All Programs] :	Click  (Start), and then click [All Programs].
 :	Page in these Operating Instructions.
 :	Reference to the on-screen manuals.

- Some illustrations are simplified to help your understanding and may look different from the actual unit.
- If you do not log on as an administrator, you cannot use some functions or cannot display some screens.
- Refer for the latest information about optional products to the catalogs, etc.
- In these instructions, the names and terms are referred as follows.
 - “Windows Vista® Business” as “Windows” or “Windows Vista”
 - “WinDVD™ 8 (OEM Version)” as “WinDVD”
 - “B’s Recorder GOLD9 BASIC” as “B’s Recorder”
 - “B’s CLiP 7” as “B’s CLiP”
- The display modes are referred as follows. () indicates the terms in [Intel® Graphics Media Accelerator Driver for mobile] screen. To display the screen, right-click the desktop and click [Graphics Properties].
 - Internal LCD (Notebook): The computer’s display
 - External display (Monitor): External display
 - Simultaneous display (Intel (R) Dual Display Clone): The same screen is displayed on the internal LCD and the external display.
 - Extended Desktop: The extended working area across the internal LCD and the external display.

■ Copyright

This manual is copyrighted by Matsushita Electric Industrial Co., Ltd. with all rights reserved. No part of this manual may be reproduced in any form without the prior written permission of Matsushita Electric Industrial Co., Ltd.

No patent liability is assumed with respect to the use of the information contained herein.

© 2007 Matsushita Electric Industrial Co., Ltd. All Rights Reserved.

■ Disclaimer

Computer specifications and manuals are subject to change without notice. Matsushita Electric Industrial Co., Ltd. assumes no liability for damage incurred directly or indirectly from errors, omissions or discrepancies between the computer and the manuals.

■ Trademarks

Microsoft®, Windows®, Windows Vista and the Windows logo are registered trademarks of Microsoft Corporation of the United States and/or other countries.

Intel, Core and Centrino are either registered trademarks or trademarks of Intel Corporation.

SDHC Logo is a trademark.



Adobe, the Adobe logo and Adobe Reader are either registered trademarks or trademarks of Adobe Systems Incorporated in the United States and/or other countries.

PhoenixBIOS, Phoenix Always and Recover Pro are trademarks and/or registered trademarks of Phoenix Technologies Ltd.

Bluetooth™ is a trademark owned by Bluetooth SIG, Inc., U.S.A. and licensed to Matsushita Electric Industrial Co., Ltd.

InterVideo, WinDVD™, the InterVideo logo, Ulead and the Corel logo are trademarks or registered trademarks of Corel Corporation and/or its subsidiaries in Canada, the United States and/or other countries.

Computrace® is a registered trademark of Absolute® Software Corp.

Panasonic® is a registered trademark of Matsushita Electric Industrial Co., Ltd.

Names of products, brands, etc., appearing in this manual are trademarks or registered trademarks of their respective own companies.

Read Me First

Models for U.S.A.

<Only for model with a “FCC” mark on the bottom of the computer>

Federal Communications Commission Radio Frequency Interference Statement

Note: This equipment has been tested and found to comply with the limits for a Class B digital device, pursuant to Part 15 of the FCC Rules. These limits are designed to provide reasonable protection against harmful interference in a residential installation. This equipment generates, uses and can radiate radio frequency energy and, if not installed and used in accordance with the instructions, may cause harmful interference to radio communications. However, there is no guarantee that interference will not occur in a particular installation. If this equipment does cause harmful interference to radio or television reception, which can be determined by turning the equipment off and on, the user is encouraged to try to correct the interference by one or more of the following measures:

- Reorient or relocate the receiving antenna.
- Increase the separation between the equipment and receiver.
- Connect the equipment into an outlet on a circuit different from that to which the receiver is connected.
- Consult the Panasonic Service Center or an experienced radio/TV technician for help.

Warning

To assure continued compliance, use only shielded interface cables when connecting to a computer or peripheral. Also, any changes or modifications not expressly approved by the party responsible for compliance could void the user's authority to operate this equipment.

6-M-1

FCC RF Exposure Warning:

- This computer is provided with a PC Card slot that could be used with wireless transmitter(s), which will be specifically recommended, when they become available. Other third-party wireless transmitter(s) have not been RF exposure evaluated for use with this computer and may not comply with FCC RF exposure requirements.

<Only for model with wireless LAN/wireless WAN/Bluetooth>

- This equipment complies with FCC radiation exposure limits set forth for an uncontrolled environment.
- This equipment must be installed and operated in accordance with provided instructions and minimum 1.5 cm spacing must be provided between antenna and all person's body (excluding extremities of hands, wrist and feet) during wireless modes of operation.
- This transmitter must not be co-located or operated in conjunction with any other antenna or transmitter.

25-M-2-3

<Only for model with wireless LAN>

This product is restricted to indoor use due to its operation in the 5.15 to 5.25 GHz frequency range.

FCC requires this product to be used indoors for the frequency range 5.15 to 5.25 GHz to reduce the potential for harmful interference to co-channel Mobile Satellite systems.

High power radars are allocated as primary users of the 5.25 to 5.35 GHz and 5.65 to 5.85 GHz bands. These radar stations can cause interference with and /or damage this product.

25-M-W-1

This device complies with Part 15 of the FCC Rules.

Operation is subject to the following two conditions:

- (1) This device may not cause harmful interference, and
- (2) This device must accept any interference received, including interference that may cause undesired operation.

Responsible Party: Panasonic Corporation of North America
One Panasonic Way
Secaucus, NJ 07094
Tel No: 1-800-LAPTOP5 (1-800-527-8675)

6-M-1

FCC Regulation Notice for modem

This equipment contains a FCC approved modem.

FCC Tested To Comply
With FCC Standards
FOR HOME OR OFFICE USE

1. This equipment complies with CFR47 Part 68 rules. On the computer is a label that contains, among other information, the FCC registration number and ringer equivalence number (REN) for this equipment. If required, this information must be provided to the telephone company.
2. An FCC compliant telephone cord and modular plug is provided with this equipment. This equipment is designed to be connected to the telephone network or premises wiring using a compatible modular jack which is Part 68 compliant. See Installation Instructions for details.
3. The REN is used to determine the quantity of devices which may be connected to the telephone line. Excessive RENs on the telephone line may result in the devices not ringing in response to an incoming call. In most, but not all area, the sum of RENs should not exceed five (5.0). To be certain of the number of devices that may be connected to a line, as determined by the total RENs, contact the local telephone company.
4. If your telephone equipment cause harm to the telephone network, the telephone company will notify you in advice that temporary discontinuance of service may be required. But if advice notice isn't practical, the telephone company will notify the customer as soon as possible. Also, you will be advised of your right to file a complaint with the FCC if you believe it is necessary.
5. The telephone company may take changes in its facilities, equipment, operations or procedures that could affect the operation of the equipment. If this happens the telephone company will provide advance notice in order for you to make necessary modifications to maintain uninterrupted service.
6. If trouble is experienced with this equipment, for repair or warranty information, please contact Panasonic Corporation of North America at DIAL TOLL FREE 1-800-LAPTOP5 (1-800-527-8675). If the equipment is causing harm to the telephone network, the telephone company may request that you disconnect the equipment until the problem is resolved.
7. There are no user serviceable parts contained in this equipment.

Read Me First

8. This equipment may not be used on coin service provided by the telephone company. Connection to party lines is subject to state tariffs.
9. The Telephone Consumer Protection Act of 1991 makes it unlawful for any person to use a computer or other electronic device to send any message via a telephone fax machine unless such message clearly contains in a margin at the top or bottom of each transmitted page or on the first page of the transmission, the date and time it is sent and an identification of the business or other entry, or other individual sending the message and the telephone number of the sending machine or such business, other entity, or individual. In order to program this information into your fax software, you should refer to the manual of the Fax software being used.
10. According to the FCC's electrical safety advisory, we recommend that you may install an AC surge arrester in the AC outlet to which this equipment is connected. Telephone companies report that electrical surges, typically lightning transients, are very destructive to

customer terminal equipment connected to AC power sources and that this is a major nationwide problem.

“Caution : To reduce the risk of fire, use only No.26 AWG or larger telecommunication line cord.”

“ATTENTION : Pour réduire le risque d'incendie, utiliser uniquement des conducteurs de télécommunications 26 AWG ou de section supérieure.”

16-M-1

Notice for the products using LCD

This product has a fluorescent lamp that contains mercury. Disposal may be regulated in your community due to environmental considerations.

For disposal or recycling information, please contact your local authorities, or the Electronic Industries Alliance:

<<http://www.eiae.org/>>

24-M-1

<For USA-California Only>

This product contains a CR Coin Cell Lithium Battery which contains Perchlorate Material- special handling may apply.

See <http://www.dtsc.ca.gov/hazardouswaste/perchlorate/>

38-M-1

Safety Precautions

<Only for model with wireless WAN>

The following safety precautions must be observed during all phases of the operation, usage, service or repair of any Personal Computer or Handheld Computer incorporating Wireless WAN. Manufacturers of the cellular terminal are advised to convey the following safety information to users and operating personnel and to incorporate these guidelines into all manuals supplied with the product. Failure to comply with these precautions violates safety standards of design, manufacture and intended use of the product. Panasonic assumes no liability for customer failure to comply with these precautions.



When in a hospital or other health care facility, observe the restrictions on the use of mobiles. Switch Personal Computer or Handheld Computer incorporating Wireless WAN off, if instructed to do so by the guidelines posted in sensitive areas. Medical equipment may be sensitive to RF energy. The operation of cardiac pacemakers, other implanted medical equipment and hearing aids can be affected by interference from Personal Computer or Handheld Computer incorporating Wireless WAN placed close to the device. If in doubt about potential danger, contact the physician or the manufacturer of the device to verify that the equipment is properly shielded. Pacemaker patients are advised to keep their Personal Computer or Handheld Computer incorporating Wireless WAN away from the pacemaker, while it is on.



Switch off Personal Computer or Handheld Computer incorporating Wireless WAN before boarding an aircraft. Make sure it cannot be switched on inadvertently. The operation of wireless appliances in an aircraft is forbidden to prevent interference with communications systems. Failure to observe these instructions may lead to the suspension or denial of cellular services to the offender, legal action, or both.



Do not operate Personal Computer or Handheld Computer incorporating Wireless WAN in the presence of flammable gases or fumes. Switch off the cellular terminal when you are near petrol stations, fuel depots, chemical plants or where blasting operations are in progress. Operation of any electrical equipment in potentially explosive atmospheres can constitute a safety hazard.



Your Personal Computer or Handheld Computer incorporating Wireless WAN receives and transmits radio frequency energy while switched on. Remember that interference can occur if it is used close to TV sets, radios, computers or inadequately shielded equipment. Follow any special regulations and always switch off Personal Computer or Handheld Computer incorporating Wireless WAN wherever forbidden, or when you suspect that it may cause interference or danger.



Road safety comes first! Do not use a Personal Computer or Handheld Computer incorporating Wireless WAN while driving a vehicle. Do not place the computer with Wireless WAN in an area where it could cause personal injury to the driver or passengers. It is recommended to stow the unit in the boot or secure stowage area while driving. Do not place the computer with Wireless WAN in an area over an air bag or in the vicinity where an air bag may deploy. Air bags inflate with great force and if the computer with Wireless WAN is placed in the air bag deployment area may be propelled with great force and cause serious injury to occupants of the vehicle.

SOS

IMPORTANT!

Personal Computer or Handheld Computer incorporating Wireless WAN operate using radio signals and cellular networks cannot be guaranteed to connect in all conditions. Therefore, you should never rely solely upon any wireless device for essential communications, for example emergency calls.

Remember, in order to make or receive calls, Personal Computer or Handheld Computer incorporating Wireless WAN must be switched on and in a service area with adequate cellular signal strength.

Some networks do not allow for emergency calls if certain network services or phone features are in use (e.g. lock functions, fixed dialing etc.). You may need to deactivate those features before you can make an emergency call.

Some networks require that a valid SIM card be properly inserted in Personal Computer or Handheld Computer incorporating Wireless WAN.

27-1-2

Models for Canada

Industry Canada (IC) Notice for modem

This equipment contains an Industry Canada approved modem unit.

The Industry Canada label is affixed on the modem unit.

EQUIPMENT ATTACHEMENT LIMITATIONS

“NOTICE: The Industry Canada label identifies certified equipment. This certification means that the equipment meets telecommunications network protective, operational and safety requirements as prescribed in the appropriate Terminal Equipment Technical Requirements document(s). The Department does not guarantee the equipment will operate to the user’s satisfaction.

Before installing this equipment, users should ensure that it is permissible to be connected to the facilities of the local telecommunications company. The equipment must also be installed using an acceptable method of connection. The customer should be aware that compliance with the above conditions may not prevent degradation of service in some situations.

Repairs to certified equipment should be coordinated by a representative designated by the supplier. Any repairs or alterations made by the user to this equipment, or equipment malfunctions, may give the telecommunications company cause to request the user to disconnect the equipment.

Users should ensure for their own protection that the electrical ground connections of the power utility, telephone lines and internal metallic water pipe system, if present, are connected together. This precaution may be particularly important in rural areas. Caution: Users should not attempt to make such connections themselves, but should contact the appropriate electric inspection authority, or electrician, as appropriate.”

“NOTICE: The Ringer Equivalence Number (REN) assigned to each terminal device provides an indication of the maximum number of terminals allowed to be connected to a telephone interface. The termination on an interface may consist of any combination of devices subject only to the requirement that the sum of the Ringer Equivalence Numbers of all the devices does not exceed 5.”

REN: See bottom of the computer

RESTRICTIONS CONCERNANT LE RACCORDEMENT DE MATÉRIEL

“AVIS: L’étiquette d’Industrie Canada identifie le matériel homologué. Cette étiquette certifie que le matériel est conforme aux normes de protection, d’exploitation et de sécurité des réseaux de télécommunications, comme le prescrivent les documents concernant les exigences techniques relatives au matériel terminal. Le Ministère n’assure toutefois pas que le matériel fonctionnera à la satisfaction de l’utilisateur.

Avant d’installer ce matériel, l’utilisateur doit s’assurer qu’il est permis de le raccorder aux installations de l’entreprise locale de télécommunication. Le matériel doit également être installé en suivant une méthode acceptée de raccordement.

L’abonné ne doit pas oublier qu’il est possible que la conformité aux conditions énoncées ci-dessus n’empêche pas la dégradation du service dans certaines situations.

Les réparations de matériel homologué doivent être coordonnées par un représentant désigné par le fournisseur.

L’entreprise de télécommunications peut demander à l’utilisateur de débrancher un appareil à la suite de réparations ou de modifications effectuées par l’utilisateur ou à cause de mauvais fonctionnement.

Pour sa propre protection, l’utilisateur doit s’assurer que tous les fils de mise à la terre de la source d’énergie électrique, des lignes téléphoniques et des canalisations d’eau métalliques, s’il y en a, sont raccordés ensemble. Cette précaution est particulièrement importante dans les régions rurales. Avertissement: L’utilisateur ne doit pas tenter de faire ces raccordements lui-même; il doit avoir recours à un service d’inspection des installations électriques, ou à un électricien, selon le cas.”

“AVIS: L’indice d’équivalence de la sonnerie (IES) assigné à chaque dispositif terminal indique le nombre maximal de terminaux qui peuvent être raccordés à une interface. La terminaison d’une interface téléphonique peut consister en une combinaison de quelques dispositifs, à la seule condition que la somme d’indices d’équivalence de la sonnerie de tous les dispositifs n’excède pas 5.”

IES: Voir sous le fond de l’ordinateur

17-Ca-1

Read Me First

Canadian ICES-003

This Class B digital apparatus complies with Canadian ICES-003.

Cet appareil numérique de la classe B est conforme à la norme NMB-003 du Canada.

<Only for model with wireless LAN/Bluetooth>

7-M-2

Industry Canada

This product complies with RSS210 Industry Canada.

Operation is subject to the following two conditions;

- (1) this device may not cause interference, and
- (2) this device must accept any interference, including interference that may cause undesired operation of the device.

30-Ca-1-1

<Only for model with wireless LAN>

This product (local network devices) for the band 5150-5250 MHz is only indoor usage to reduce potential for harmful interference to co-channel Mobile Satellite systems.

High power radars are allocated as primary users (meaning they have priority) of 5250-5350 MHz and 5650-5850 MHz and these radars could cause interference and/or damage to LELAN devices.

30-Ca-2-1

Models for Europe

<Only for model with a "CE" mark on the bottom of the computer>



Declaration of Conformity (DoC)

"Hereby, we declare that this Personal Computer is in compliance with the essential requirements and other relevant provisions of the Directive 1999/5/EC."

Hint:

If you want to get a copy of the original DoC of our products which relates to the R&TTE, please contact our web address: <http://www.doc.panasonic.de>

Contact:

Panasonic Services Europe

A Division of Panasonic Marketing Europe GmbH

Panasonic Testing Centre

Network connection.

The terminal equipment is intended for connection to the following public network;

In all the countries of European Economical Area;

- Public Switched Telephony Networks

Technical Features.

The terminal equipment includes the following features;

- DTMF dialing
- Maximum bitrate receiving mode: 56 kbit/s
- Maximum bitrate sending mode: 33.6 kbit/s

This product is designed to interwork with the Public Switched Telecommunication Networks in UK, Ireland, Netherlands, Sweden, Denmark, Finland, Switzerland, Luxembourg, Belgium, France, Germany, Spain, Portugal, Iceland, Greece, Italy, Norway, Austria, Poland, Hungary, Czech, Slovakia, Slovenia, Estonia, Latvia, Lithuania, Cyprus, Malta, Romania, Bulgaria and Liechtenstein.

18-E-1

Important Safety Instructions / Importantes Mesures De Sécurité

When using your telephone equipment, basic safety precautions should always be followed to reduce the risk of fire, electric shock and injury to persons, including the following:

1. Do not use this product near water, for example, near a bath tub, wash bowl, kitchen sink or laundry tub, in a wet basement or near a swimming pool.
2. Avoid using a telephone (other than a cordless type) during an electrical storm. There may be a remote risk of electric shock from lightning.
3. Do not use the telephone to report a gas leak in the vicinity of the leak.
4. Use only the power cord and batteries indicated in this manual. Do not dispose of batteries in a fire. They may explode. Check with local codes for possible special disposal instructions.

SAVE THESE INSTRUCTIONS

19-E-1

Certaines mesures de sécurité doivent être prises pendant l'utilisation de matériel téléphonique afin de réduire les risques d'incendie, de choc électrique et de blessures. En voici quelquesunes:

1. Ne pas utiliser l'appareil près de l'eau, p.ex., près d'une baignoire, d'un lavabo, d'un évier de cuisine, d'un bac à laver, dans un sous-sol humide ou près d'une piscine.
2. Éviter d'utiliser le téléphone (sauf s'il s'agit d'un appareil sans fil) pendant un orage électrique. Ceci peut présenter un risque de choc électrique causé par la foudre.
3. Ne pas utiliser l'appareil téléphonique pour signaler une fuite de gaz s'il est situé près de la fuite.
4. Utiliser seulement le cordon d'alimentation et le type de piles indiqués dans ce manuel. Ne pas jeter les piles dans le feu: elles peuvent exploser. Se conformer aux règlements pertinents quant à l'élimination des piles.

CONSERVER CES INSTRUCTIONS

19-F-1

Getting Started

Information to the User

<Only for model with wireless LAN/wireless WAN/Bluetooth>

This product and your Health

This product, like other radio devices, emits radio frequency electromagnetic energy. The level of energy emitted by this product however is far much less than the electromagnetic energy emitted by wireless devices like for example mobile phones.

Because this product operates within the guidelines found in radio frequency safety standards and recommendations, we believe this product is safe for use by consumers. These standards and recommendations reflect the consensus of the scientific community and result from deliberations of panels and committees of scientists who continually review and interpret the extensive research literature.

In some situations or environments, the use of this product may be restricted by the proprietor of the building or responsible representatives of the organization. These situations may for example include:

- Using this product on board of airplanes, or
- In any other environment where the risk of interference to other devices or services is perceived or identified as harmful.

If you are uncertain of the policy that applies on the use of wireless devices in a specific organization or environment (e.g. airports), you are encouraged to ask for authorization to use this product prior to turning on the product.

Regulatory Information

We are not responsible for any radio or television interference caused by unauthorized modification of this product. The correction of interference caused by such unauthorized modification will be the responsibility of the user. We and its authorized resellers or distributors are not liable for damage or violation of government regulations that may arise from failing to comply with these guidelines.

26-M-1

Lithium Battery / Pile au lithium

Lithium Battery!

This computer contains a lithium battery to enable the date, time, and other data to be stored. The battery should only be exchanged by authorized service personnel. Warning! A risk of explosion from incorrect installation or misapplication may possibly occur.

15-E-1

Pile au lithium!

Le micro-ordinateur renferme une pile au lithium qui permet de sauvegarder certaines données, notamment la date et l'heure. La pile ne doit être remplacée que par un technicien qualifié.

Danger ! Risque d'explosion en cas de non respect de cette mise en garde!

15-F-1

Read Me First

CD/DVD Drive Caution

CAUTION!

THIS PRODUCT UTILIZES A LASER. USE OF CONTROLS, ADJUSTMENTS OR PERFORMANCE OF PROCEDURES OTHER THAN THOSE SPECIFIED HEREIN MAY RESULT IN HAZARDOUS RADIATION EXPOSURE. DO NOT OPEN COVERS AND DO NOT REPAIR YOURSELF. REFER SERVICING TO QUALIFIED PERSONNEL.

12-E-1

AVERTISSEMENT!

CET APPAREIL UTILISE UN LASER. L'UTILISATION DE COMMANDES OU DE RÉGLAGES OU L'EXÉCUTION DE PROCÉDURES AUTRES QUE CELLES SPÉCIFIÉES ICI PEUVENT PROVOQUER UNE EXPOSITION À DES RADIATIONS DANGEREUSES. NE PAS OUVRIR LES COUVERCLES NI ESSAYER DE RÉPARER SOIMÊME. CONFIER TOUT TRAVAIL D'ENTRETIEN À UN PERSONNEL QUALIFIÉ.

12-F-1

Bottom

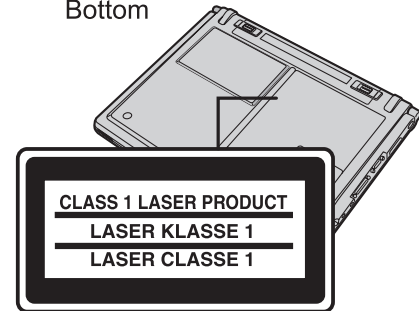

12-1-1

Information on Disposal for Users of Waste Electrical & Electronic Equipment (private households)

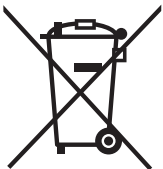

Information on Disposal in other Countries outside the European Union

This symbol is only valid in the European Union.

If you wish to discard this product, please contact your local authorities or dealer and ask for the correct method of disposal.

36-M-1

Precautions

THIS PRODUCT IS NOT INTENDED FOR USE AS, OR AS PART OF, NUCLEAR EQUIPMENT/SYSTEMS, AIR TRAFFIC CONTROL EQUIPMENT/SYSTEMS, OR AIRCRAFT COCKPIT EQUIPMENT/SYSTEMS^{*1}. PANASONIC WILL NOT BE RESPONSIBLE FOR ANY LIABILITY RESULTING FROM THE USE OF THIS PRODUCT ARISING OUT OF THE FOREGOING USES.

^{*1} AIRCRAFT COCKPIT EQUIPMENT/SYSTEMS include Class2 Electrical Flight Bag (EFB) Systems and Class1 EFB Systems when used during critical phases of flight (e.g., during take-off and landing) and/or mounted on to the aircraft. Class1 EFB Systems and 2 EFB Systems are defined by FAA: AC (Advisory Circular) 120-76A or JAA: JAA TGL (Temporary Guidance Leaflets) No.36.

Panasonic cannot guarantee any specifications, technologies, reliability, safety (e.g. Flammability/Smoke/Toxicity/Radio Frequency Emission, etc) requirements related to aviation standards that exceed the specifications of our COTS (Commercial-Off-The-Shelf) products.

This computer is not intended for use in medical equipment including life-support systems, air traffic control systems, or other equipment, devices or systems that are involved with ensuring human life or safety. Panasonic cannot be held responsible in any way for any damages or loss resulting from the use of this computer in these types of equipment, devices or systems, etc.

If a Malfunction Occurs, Immediately Unplug the AC Plug and the Battery Pack

- This product is damaged
- Foreign object inside this product
- Smoke emitted
- Unusual smell emitted
- Unusually hot

Continuing to use this product while any of the above conditions are present may result in fire or electric shock.

- If a malfunction occurs, immediately turn the power off and unplug the AC plug, and then remove the battery pack.

Then contact your technical support office.

Do Not Touch This Product and Cable When It Starts Thundering

Electric shock may result.

Do Not Connect the AC Adaptor to a Power Source Other Than a Standard Household AC Outlet

Otherwise, a fire due to overheating may result. Connecting to a DC/AC converter (inverter) may damage the AC adaptor. On an airplane, only connect the AC adaptor/charger to an AC outlet specifically approved for such use.

Do Not Do Anything That May Damage the AC Cord, the AC Plug, or the AC Adaptor

Do not damage or modify the cord, place it near hot tools, bend, twist, or pull it forcefully, place heavy objects on it, or bundle it tightly. Continuing to use a damaged cord may result in fire, short circuit, or electric shock.

Do Not Pull or Insert the AC Plug If Your Hands Are Wet
Electric shock may result.

Clean Dust and Other Debris of the AC Plug Regularly

If dust or other debris accumulates on the plug, humidity, etc. may cause a defect in the insulation, which may result in a fire.

- Pull the plug, and wipe it with a dry cloth.

Pull the plug if the computer is not being used for a long period of time.

Insert the AC Plug Completely

If the plug is not inserted completely, fire due to overheating or electric shock may result.

- Do not use a damaged plug or loose AC outlet.

Do Not Place Containers of Liquid or Metal Objects on Top of the Product

If water or other liquid spills, or if paper clips, coins, or foreign matter get inside this product, fire or electric shock may result.

- If water spills in the keyboard, refer to page 21. If other foreign matter has found its way inside, immediately turn the power off and unplug the AC plug and remove the battery pack. Then contact your technical support office.

Do Not Disassemble This Product

There are high-voltage areas inside which may give you an electric shock if you should touch them. Do not touch the pins and circuit boards inside, and do not allow foreign matter to enter inside.

Also, remodeling or disassembly may cause a fire.

Keep SD Memory Cards Away from Infants and Small Children

Accidental swallowing will result in bodily injury.

In the event of accidental swallowing, see a doctor immediately.

Do Not Place This Product on Unstable Surfaces

If balance is lost, this product may fall over or drop, resulting in an injury.

Avoid Stacking

If balance is lost, this product may fall over or drop, resulting in an injury.

Do Not Keep This Product Wherever There is a Lot of Water, Moisture, Steam, Dust, Oily Vapors, etc.

Otherwise, possibly resulting in fire or electric shock.

Do Not Leave This Product in High Temperature Environment Such as in a Sun-Heated Car, for a Long Period of Time

Leaving this product where it will be exposed to extremely high temperatures such as in a sun-heated car or in direct sunlight may deform the cabinet and/or cause trouble in the internal parts. Continued use in such a resulting condition may lead to short-circuiting or insulation defects, etc. which may in turn lead to a fire or electric shocks.

Do Not Block the Ventilation Hole

Otherwise, heat will build up inside, possibly resulting in a fire.

Hold the Plug When Unplugging the AC Plug

Pulling on the cord may damage the cord, resulting in a fire or electric shock.

Do Not Move This Product While the AC Plug Is Connected

The AC cord may be damaged, resulting in fire or electric shock.

- If the AC cord is damaged, unplug the AC plug immediately.

Use Only the Specified AC Adaptor With This Product

Using an AC adaptor other than the one supplied (attached to your product or supplied by Panasonic) may result in a fire.

Do Not Subject the AC Adaptor to Any Strong Impact

Using the AC adaptor after a strong impact such as being dropped may result in electric shock, short circuit, or fire.

Take a Break of 10-15 Minutes Every Hour

Using this product for long periods of time may have detrimental health effects on the eyes or hands.

Do Not Look into the CD/DVD Drive

Looking directly at the internal laser light source may result in damage to eyesight.

Do Not Use Discs That Are Cracked or Deformed

Because the discs rotate at high speeds, damaged discs may break apart causing injury.

- Discs that are not round and discs that have been repaired using adhesives are similarly dangerous, and so should not be used.

Do Not Turn the Volume Up to Loud When Using Headphones

Listening at high volumes that overstimulate the ear for long periods of time may result in loss of hearing.

Use the Modem with a Regular Telephone Line

Connection to an internal phone line (on-premise switches) of a company or business office, etc. or to a digital public phone or use in a country or area not supported by the computer may result in a fire or electric shocks.

Do Not Connect a Telephone Line, or a Network Cable Other Than the One Specified, into the LAN Port

If the LAN port is connected to a network such as the ones listed below, a fire or electric shock may result.

- Networks other than 1000BASE-T, 100BASE-TX or 10BASE-T
- Phone lines (IP phone (Internet Protocol Telephone), Telephone lines, internal phone lines (on-premise switches), digital public phones, etc.)

Do Not Use with Exposing the Skin to This Product for a Long Period of Time

Using this product with exposing the skin to the heat source of this product or AC adaptor for a long period of time can cause a low-temperature burn.

- Do not place the computer near a television or radio receiver.
- Keep the computer away from magnets. Data stored on the hard disk may be lost.

Precautions (Battery Pack)

Do Not Use with Any Other Product

The battery pack is rechargeable and was intended for the specified product. If it is used with a product other than the one for which it was designed, electrolyte leakage, generation of heat, ignition or rupture may result.

Do Not Charge the Battery Using Methods Other Than Those Specified

If the battery pack is not charged using one of the specified methods, electrolyte leakage, generation of heat, ignition or rupture may result.

Do Not Throw the Battery Pack into a Fire or Expose It to Excessive Heat

Generation of heat, ignition or rupture may result.

Avoid Extreme Heat (Near the Fire, in Direct Sunlight, for Example)

Electrolyte leakage, generation of heat, ignition or rupture may result.

Do Not Insert Sharp Objects into the Battery Pack, Expose It to Bumps or Shocks, Disassemble, or Modify It

Electrolyte leakage, generation of heat, ignition or rupture may result.

Do Not Short the Positive (+) and Negative (-) Contacts

Generation of heat, ignition or rupture may result. Do not place the battery pack together with articles such as necklaces or hairpins when carrying or storing.

Do Not Use This Product with a Battery Pack Other Than the One Specified

Use only the specified battery pack (CF-VZSU45) with your product. Use of battery packs other than those manufactured and supplied by Panasonic may present a safety hazard (generation of heat, ignition or rupture).

- Do not touch the terminals on the battery pack. The battery pack may no longer function properly if the contacts are dirty or damaged.
- Do not expose the battery pack to water, or allow it to become wet.
- If the battery pack will not be used for a long period of time (a month or more), charge or discharge (use) the battery pack until the remaining battery level becomes 30% to 40% and store it in a cool, dry place.
- This computer prevents overcharging of the battery by recharging only when the remaining power is less than approx. 95% (when Economy Mode (ECO) is enabled: 75%) of capacity.
- The battery pack is not charged when the computer is first purchased. Be sure to charge it before using it for the first time. When the AC adaptor is connected to the computer, charging begins automatically.

- Should the battery leak and the fluid get into your eyes, do not rub your eyes. Immediately flush your eyes with clear water and see a doctor for medical treatment as soon as possible.

NOTE

- The battery pack may become warm during recharging or normal use. This is completely normal.
- Recharging will not commence if internal temperature of the battery pack is outside of the allowable temperature range (0 °C to 55 °C {32 °F to 131 °F}). (→  Reference Manual "Battery Power") Once the allowable range requirement is satisfied, charging begins automatically. Note that the recharging time varies based on the usage conditions. (Recharging takes longer than usual when the temperature is 10 °C {50 °F} or below.)
- If the temperature is low, the operating time is shortened. Only use the computer within the allowable temperature range.
- The battery pack is a consumable item. If the amount of time the computer can be run by using a particular battery pack becomes dramatically shorter and repeated recharging does not restore its performance, the battery pack should be replaced with a new one.
- When transporting a spare battery inside a package, briefcase, etc., it is recommended that it be placed in a plastic bag so that its contacts are protected.
- Always power off the computer when it is not in use. Leaving the computer on when the AC adaptor is not connected will exhaust the remaining battery capacity.



A lithium ion battery that is recyclable powers the product you have purchased. Please call 1-800-8-BATTERY for information on how to recycle this battery.

L'appareil que vous vous êtes procuré est alimenté par une batterie au lithium-ion. Pour des renseignements sur le recyclage de la batterie, veuillez composer le 1-800-8-BATTERY.

48-M-1

Description of Parts

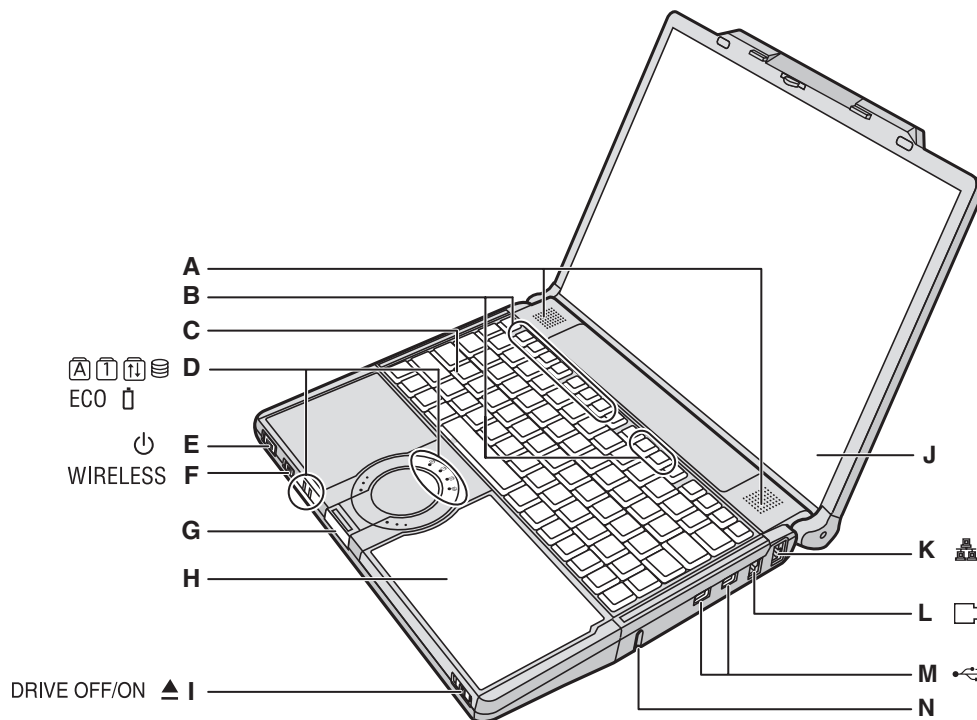

A : Speakers

B : Function Key

→ Reference Manual "Key Combinations"

C : Keyboard

D : LED Indicator

: Caps lock

: Numeric key (NumLk)

: Scroll lock (ScrLk)

: Hard disk drive status

ECO : Economy Mode (ECO) status

→ Reference Manual "Battery Power"

: Battery status

→ Reference Manual "Battery Power"

E : Power Switch

→ page 14

Power Indicator

• Off: Power off/Hibernation

• Green: Power on

• Blinking green: Sleep

F : Wireless Switch

Switch the wireless devices to on (right side) or to off (left side).

<Only for model with wireless LAN/wireless WAN/Bluetooth>

→ Reference Manual "Disabling/Enabling Wireless Communication"

G : Latch

When closing the display, press down firmly from above until the latch is firmly closed (locked).

H : CD/DVD Drive

→ Reference Manual "CD/DVD Drive"

I : CD/DVD Drive Power/Open Switch

- Slide the switch to the right to open the disc cover.
- Slide the switch to the left to turn on/off the drive power.

CD/DVD Drive Indicator

- Off: Drive power is off.
- Green: Drive power is on, but the drive is not accessed.
- Blinking green: Drive power is on, and the drive is being accessed.

J : LCD

K : LAN Port

If the Mini Port Replicator is connected to the computer, connect the LAN cable to the LAN port on the Mini Port Replicator. You cannot use the LAN port on the computer.

→ Reference Manual "LAN"

L : Modem Port

- Be sure to use the included modem telephone cable, and insert the ferrite core side of modem telephone cable into the modem port on the computer.
- Do not move/remove the ferrite core of modem telephone cable.

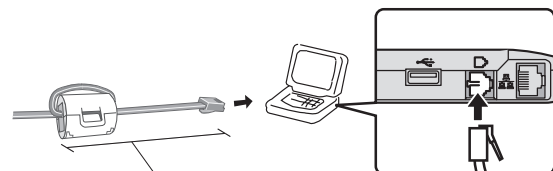

90 mm {3.5"} or less

→ Reference Manual "Modem"

M : USB Ports

→ Reference Manual "USB Devices"

N : Security Lock

You can connect a Kensington cable. Refer to the instruction manual of the cable. The security lock and cable is a theft prevention device. Matsushita Electric Industrial Co., Ltd. will bear no responsibility in the event of theft.

CAUTION

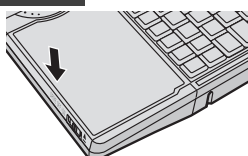

When closing the disc cover, press down near the drive power/open switch (position of the arrow) to ensure that the cover is locked.

Description of Parts

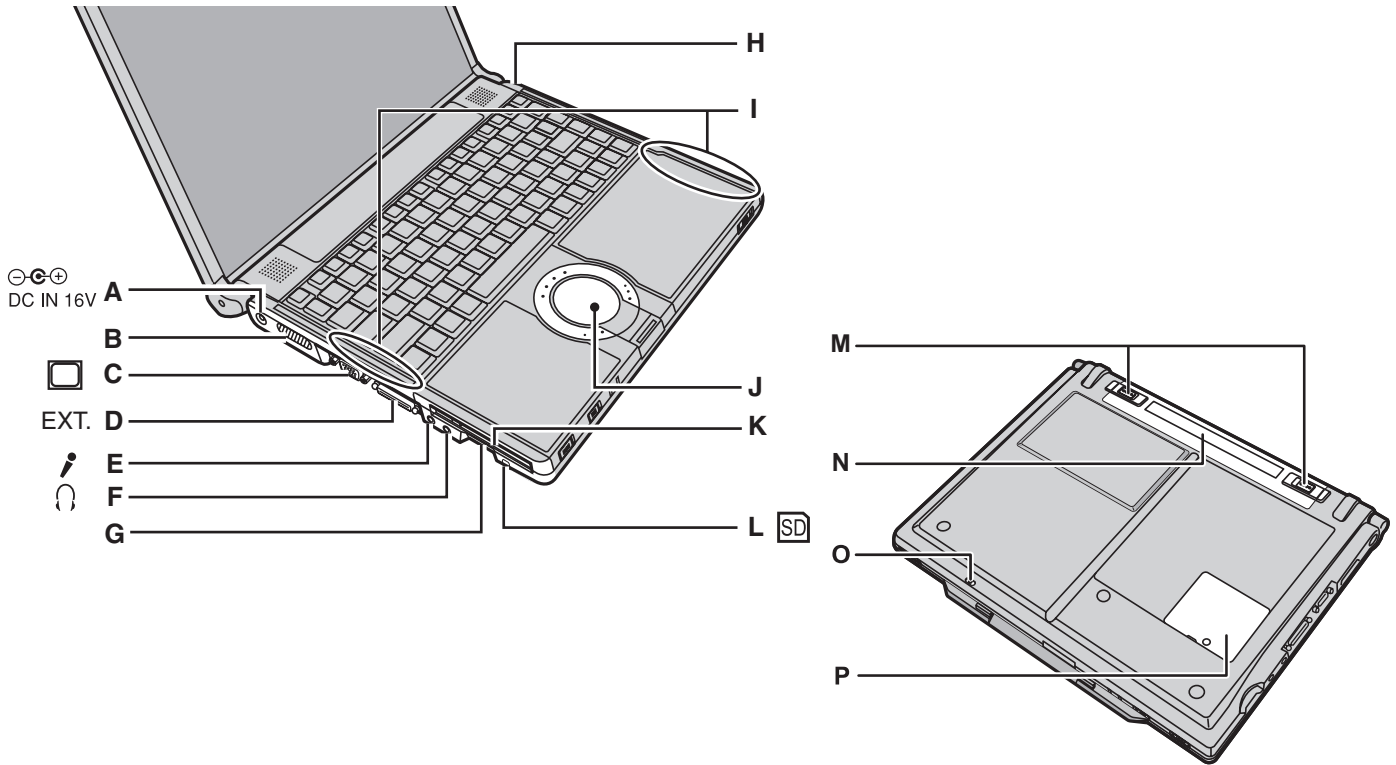

A : DC-IN Jack

B : Ventilation Hole

C : External Display Port

If the Mini Port Replicator is connected to the computer, connect the external display to the external display port on the Mini Port Replicator. You cannot use the external display port on the computer.

→ *Reference Manual* "External Display"

D : Mini Port Replicator Connector

Connect the Mini Port Replicator (optional).

→ *Reference Manual* "Mini Port Replicator"

E : Microphone Jack

A condenser microphone can be used. If other types of microphones are used, audio input may not be possible, or malfunctions may occur.

F : Headphone Jack

You can connect headphones or amplified speakers. When they are connected, audio from the internal speakers is not heard.

G : SD Memory Card Slot

→ *Reference Manual* "SD/SDHC Memory Card"

H : Bluetooth Antenna

<Only for model with Bluetooth>

→ *Supplementary Instructions* of Bluetooth

I : Wireless LAN Antenna

<Only for model with wireless LAN>

→ *Reference Manual* "Wireless LAN"

J : Touch Pad

→ *Reference Manual* "Using the Touch Pad"

K : PC Card Slot

→ *Reference Manual* "PC Cards"

L : SD Memory Card Indicator

Blinking: During access

M : Battery Latches

→ page 13

N : Battery Pack

For information on how to insert/remove the battery pack, refer to *Reference Manual* "Battery Power".

O : Emergency Hole

→ *Reference Manual* "CD/DVD Drive"

P : RAM Module Slot

→ page 22

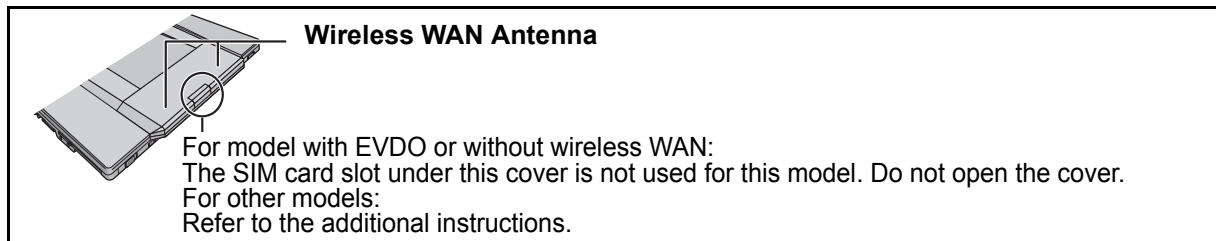

First-time Operation

■ Preparation

① Check and identify the supplied accessories.

If you do not find the described accessories, contact your technical support office.

- AC Adaptor 1
- AC Cord 1
- Battery Pack . . . 1
- Modem Telephone Cable 1

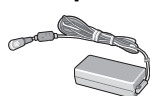

Model No: CF-AA1633A

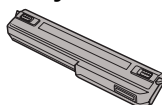

Model No: CF-VZSU45



- Operating Instructions (This book) . . 1
- Windows® Book 1
- Product Recovery DVD-ROM 1

● You will need the serial number when you reinstall B's Recorder or install B's CLiP (→ page 30).

② Read the LIMITED USE LICENSE AGREEMENT before breaking the seal on the computer's packaging (→ page 34).

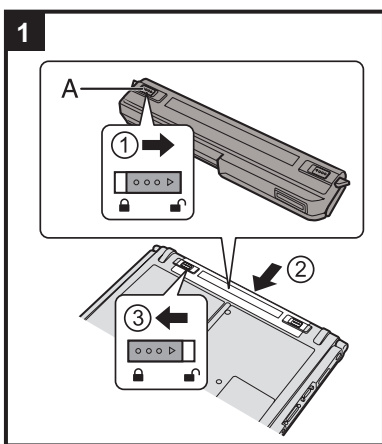

1 Insert the battery pack.

- ① Turn the computer over and slide the left latch (A) to the unlocked position (🔓).
- ② Insert the battery pack in the correct direction until it securely fits the connector.
- ③ Slide the left latch (A) to the locked position (🔒). (Right latch is locked automatically.)

CAUTION

- Make sure the latches are securely locked. Otherwise the battery pack may fall when you carry the computer.
- Do not touch the terminals of the battery pack and the computer. Doing so can make the terminals dirty or damaged, and may cause malfunction of the battery pack and the computer.

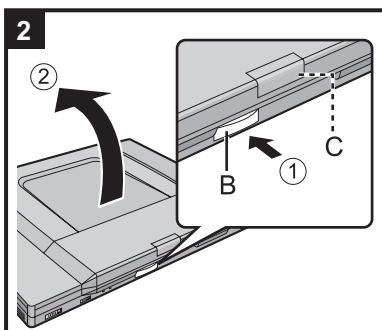

2 Open the display.

- ① Press and hold the latch (B) located at the front.
 - Be careful not to press the SIM card slot cover (C) by mistake.
- ② Lift open the display.

CAUTION

- Do not open the display wider than necessary (140° or more), and do not apply excessive pressure to the LCD. Do not open or close the computer holding the edge of the LCD segment.

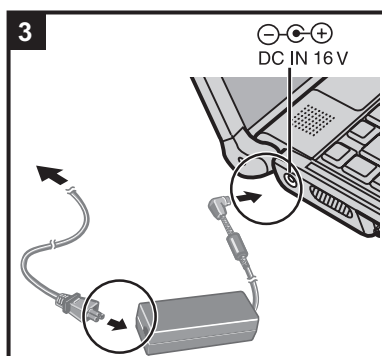

3 Connect your computer to a power outlet.

The battery charging starts automatically.

CAUTION



- Do not disconnect the AC adaptor and do not switch the wireless switch to on until the first-time operation procedure is completed.
- When using the computer for the first time, do not connect any peripheral device except the battery pack and AC adaptor.
- Handling the AC adaptor
 - Problems such as sudden voltage drops may arise during periods of thunder and lightning. Since this could adversely affect your computer, an uninterruptible power source (UPS) is highly recommended unless running from the battery pack alone.

First-time Operation

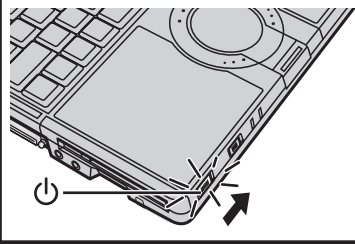
4



4 Turn on the computer.

Slide and hold the power switch  for approximately one second until the power indicator  lights.

It takes approximately 5 minutes until the Windows setup screen appears. Do not touch the keys and touch pad until it appears.

CAUTION

- Do not slide the power switch repeatedly.
- The computer will forcibly be turned off if you slide and hold the power switch for four seconds or longer.
- Once you turn off the computer, wait for ten seconds or more before you turn on the computer again.
- Do not perform the following operation until the hard disk drive indicator  turns off.
 - Connecting or disconnecting the AC adaptor
 - Sliding the power switch or CD/DVD drive power/open switch
 - Touching the keyboard or touch pad
 - Closing the display
- Do not change the Setup Utility until completing step 5. If you do so, Windows setup may not operate properly.

5 Setup Windows.

Follow the on-screen instructions.

- After turning on the computer, “Please wait a moment while Windows prepares to start for the first time” appears, and then a small circle circulates on the screen. This will take a few minutes.
- During setup of Windows, use the touch pad to move the cursor and to click an item.
- Do not change the settings on the screen where you select a country or region. You can set a country, region or keyboard layout in [Clock, Language, and Region] of [Control Panel] after the Windows setup is complete.
- Setup of Windows will take approximately 20 minutes.
Go to the next step, confirming each message on the display.

CAUTION

- You cannot choose the following words for user name and password: CON, PRN, AUX, CLOCK\$, NUL, COM1 to COM9, LPT1 to LPT9.
- You can change the user name, password, image and security setting after setup of Windows.
- Remember your password. If you forget the password, you cannot use the Windows. Creating a password reset disk beforehand is recommended.

6 Change the internal CD/DVD drive letter if necessary.

→  *Reference Manual* “CD/DVD Drive”

NOTE

● PC Information Viewer

This computer periodically records the management information including the hard disk information such as number of hours powered-on, number of times powered-on, internal temperature, replacement sector. The maximum data volume for each record is 750 byte. These information are only used for estimating the cause when the hard disk goes down by any possibility. They are never sent to outside via network nor used for any other purpose except for the purpose described the above.

To disable the function, add the check mark for [Disable the automatic save function for management information history] in [Hard Disk Status] of PC Information Viewer, and click [OK].

When you disable the function, information on how to use the hard disk is not displayed.

(→  *Reference Manual* “Check the Computer’s Usage Status” and  *Hard Disk Handling*)

● If you hear the sounds from CD/DVD drive

In the following situations, the sounds from the CD/DVD drive can be heard.

- Immediately after the CD/DVD drive is turned on
- Just after turning on the computer with [DVD Drive Power] set to [On] in the Setup Utility
- When a CD or DVD is playing

The sounds you hear are normal operating sounds created by the motor in the CD/DVD drive operating; it is not a malfunction.

- **To conserve power, the following power saving methods are set at the time of purchase (When AC adaptor is connected).**

- The screen automatically turns off after 15 minutes of inactivity.
- The computer automatically enters sleep^{*1} after 20 minutes of inactivity.

^{*1} Refer to  *Reference Manual* “Sleep or Hibernation Functions” about resuming from sleep.

- **Power consumption in each mode is as follows. (When AC adaptor is connected)**

- When the screen is off Approx. 12 W
- In sleep Approx. 1.9 W
- The battery pack is fully charged (or not being charged) and the computer is off Approx. 0.9 W

- **Note that the computer consumes electricity even when the computer power is off. If the battery pack is fully charged, the battery will be fully discharged in the following period of time:**

- When power is off: Approx. 2 months
- In sleep: Approx. 2 days^{*2}
- In hibernation: Approx. 3 days^{*2}

^{*2} If “Wake Up from wired LAN” is disabled, the period of time will become slightly longer.

If “Wake Up from wireless LAN” is enabled, the period of time will become shorter.

- **When the CD/DVD drive power is turned off, the message “The ‘MATSHITA DVD-XXX XXXX’ device can now be safely removed from the system” will appear, but the CD/DVD drive is an internal device, so it cannot be removed.**

■ When Starting Up/Shutting Down

- Do not do the following
 - Connecting or disconnecting the AC adaptor
 - Sliding the power switch or CD/DVD drive power/open switch
 - Touching the keyboard, touch pad or external mouse
 - Closing the display

■ To change the partition structure

You can shrink a part of an existing partition to create unallocated disk space, from which you can create a new partition. This computer has a single partition in the default setting.

- ① Click  (Start) and right-click [Computer], then click [Manage].
 - A standard user needs to enter an administrator password.
- ② Click [Disk Management].
- ③ Right-click the partition for Windows (“c” drive in the default setting), and click [Shrink Volume].
 - The partition size depends on the computer specifications.
- ④ Input the size in [Enter the amount of space to shrink in MB] and click [Shrink].
 - You cannot input a larger number than the displayed size.
- ⑤ Right-click [Unallocated] (the shrunk space in the step ④) and click [New Simple Volume].
- ⑥ Follow the on-screen instructions to make the settings, and click [Finish].
Wait until formatting is completed.

NOTE

- You can create an additional partition using remaining unallocated space or newly creating unallocated space.
- To delete a partition, right-click the partition and click [Delete Volume] in the step ③.

First-time Operation

Regarding Windows Vista

You can select the Classic view of Control Panel or the Classic Start menu. You can also change the way a user logs on or off. This manual explains using the Windows Vista default setting (not Classic view or Classic Start menu etc.).

● User Account Control

User Account Control is a new security component of Windows Vista to stop unauthorized changes to your computer. The User Account Control message will pop up every time you try making an important change to your computer.

● About Windows® Anytime Upgrade

• To upgrade the operating system to Windows Vista® Ultimate, you must purchase the license key at the Microsoft Windows® Anytime Upgrade web site and receive the Windows® Anytime Upgrade disc from Microsoft Corporation.

- ① In an Internet-connected environment, click  (Start) - [All Programs] - [Extras and Upgrades] - [Windows Anytime Upgrade].
- ② Click [Upgrade to Windows Vista Ultimate].
- ③ After carefully reading the on-screen instructions, click [Begin upgrade process].
- ④ Purchase the license key at the Microsoft Windows® Anytime Upgrade web site and receive the Windows® Anytime Upgrade disc from Microsoft Corporation.

• When you have upgraded the preinstalled “Windows Vista® Business” to “Windows Vista® Ultimate”, setup the chip set device in the following procedure.

- ① Click  (Start) and input [c:\util\drivers\intel\inf\setup.exe] in [Start Search], and press **Enter**.
 - A standard user needs to enter an administrator password.
 - Follow the on-screen instructions and setup the chip set device.

● If the computer becomes warm during usage

• Check the usage environment

- Avoid using the computer on a highly heat retentive surfaces (e.g., rubber pads). If possible, use the computer on surfaces that can dissipate heat, such as a steel desk.
- Do not use a keyboard cover, as this prevents heat dissipation.
- Always keep the display open in sleep.

• Check the following

- If the computer becomes warm while the screen saver is displayed, set the screen saver to [Windows Logo]. Screen savers that use 3-D images or other complex images increase the CPU utilization rate.
- If you are not using a wireless LAN, turn the wireless LAN off.
- Use recommended RAM module products. Non-recommended RAM modules may not operate properly, and may cause damage to your computer.

• Double-click  on the desktop and click [Power Saving Level : High]

Follow the on-screen instructions.

➔  *Reference Manual* “Computing on the Road”

• Double-click  on the desktop and click [High speed], then click [OK].

- When you set [High speed], rotation of the cooling fan speeds up and the computer can be cooled down. Note that the battery operating time will be shorter.
- When you do not frequently use CPU or the rotation noise of the fan bothers you, set [Standard] or [Low speed] as necessary.

● Windows Sidebar

The Windows Sidebar does not appear in the default setting. To display it, click  (Start) - [All Programs] - [Accessories] - [Windows Sidebar].

To always display the sidebar:



- ① Right-click the sidebar icon  on the notification area, and click [Properties].
- ② Add a check mark for [Start Sidebar when Windows starts] and click [OK].

● Sound and Video

• When playing AVI files



When the computer is stressed with lots of application software running or when you are using the computer in hot location, the sound and images in AVI files may be cut during playback.

The following operations may improve the situation.



- Click  or  on the notification area, and click [High performance]. (When using the computer in hot location, lower the temperature in the environment to set [High performance]. Setting [High performance] in hot location does not improve the situation.)

- When you play back AVI files with the Windows Media Player full screen, the audio and images may not match with each other. In this case, do either of the following for playback.
 - Play back with the Windows Media Player on the window display.
 - Use WinDVD for playback.
- When you play back motion image files such as DVD-Video, the following troubles may occur.
 - When using Windows Media Player, images are not played back smoothly.
 - When using WinDVD, the playback screen becomes suspended.

If this occurs, click  (Pause) of WinDVD and click  (Play). The sequel is played back.

- Sound (e.g. MP3, WMA) and video (e.g. MPG, WMV) recorded in PC Cards and SD Memory Cards may be interrupted during playback. If this happens, copy them to the hard disk drive and play back.
- Depending on the processing status on Windows, sound may be interrupted at Windows startup. You can mute the sound at startup.
 - ① Right-click the desktop and click [Personalize] - [Sounds].
 - ② Remove the check mark from [Play Windows Startup sound], and click [OK].
- **When Using Wireless LAN** <Only for model with wireless LAN>
 - If you cannot communicate with the access point or if the access point is not detected, right-click  on the notification area and click [Connect to a network], and then click  in the [Connect to a network] screen.
 - If you use the stealth type wireless LAN access point which restricts automatic detection of the wireless LAN access point, take the following procedure.

If you do not perform the procedure below, you may not be able to access the wireless LAN access point automatically or the wireless LAN access point may not be displayed on the [Connect to a network] screen.

 - ① Click ,  or  on the notification area, click [Network and Sharing Center] - [Set up a connection or network] - [Manually connect to a wireless network] and click [Next].
 - ② Input necessary information and add check marks for [Start this connection automatically] and [Connect even if the network is not broadcasting] and click [Next].

- **When the computer suddenly enters hibernation**

When you successively operate application software with CPU load in hot location, the internal temperature control function may work and the computer may enter hibernation.

If this occurs, wait for a while (approx. 5 minutes) before you turn on the computer.

- **Windows Update**

You can update to the latest patches and service packs for Windows with the following menus.

 (Start) - [All Programs] - [Windows Update]

Do not apply "Driver Updates" even if a message to update a driver appears. If a driver update is required, contact your technical support office.

On-screen Manual

You can access the following manuals on the computer screen after completing the “First-time Operation”. When you access the on-screen manual for the first time, the License Agreement of the Adobe Reader may be displayed. Read it carefully and select [Accept] to proceed.

■ Reference Manual

The Reference Manual contains the practical information to help you fully enjoy the computer’s performance.

To access the Reference Manual:

Double-click  on the desktop.

Contents		
● Read Me First	● PC Cards	● Loupe Utility
● Using the Touch Pad	● SD/SDHC Memory Card	● DMI Viewer
● Key Combinations	● Mini Port Replicator	● Troubleshooting (Advanced)
● Battery Power	● External Display	● Check the Computer’s Usage Status
● Customizing the Power Setting	● USB Devices	● PC Information Popup
● Computing on the Road	● Modem	● Protecting Your Computer from Viruses
● Sleep or Hibernation Functions	● LAN	● Technical Information
● Security Measures	● Disabling/Enabling Wireless Communication	
● CD/DVD Drive	● Wireless LAN	
● WinDVD	● Setup Utility	
● Writing to CD/DVD		

■ Important Tips

The Important Tips will provide you with the helpful information about the battery. Read to use the battery pack in the optimum condition to obtain longer operation time.

To access the Important Tips:

Double-click  on the desktop.

- Alternatively click  (Start) - [All Programs] - [Panasonic] - [On-Line Manuals] - [Important Tips].

■ Hard Disk Handling

The Hard Disk Handling will provide you with the helpful information on how to use the hard disk.

To access the Hard Disk Handling:

Click  (Start) - [All Programs] - [Panasonic] - [On-Line Manuals] - [Hard Disk Handling].

■ Supplementary Instructions of Bluetooth <Only for model with Bluetooth>

The Supplementary Instructions will provide you with the helpful information about the Bluetooth.

To access the Supplementary Instructions of Bluetooth:

Click  (Start) - [All Programs] - [Panasonic] - [On-Line Manuals] - [Bluetooth Manual].

NOTE

- When Adobe Reader update notice is displayed, we recommend you follow the on-screen procedure to update. See <http://www.adobe.com/> for the latest version of Adobe Reader.

Handling and Maintenance

Operation Environment

- Place the computer on a flat stable surface. Do not place the computer upright. If the computer is exposed to an extremely strong impact, it may become inoperable.
 - Temperature: Operation: 5 °C to 35 °C {41 °F to 95 °F}
Storage: -20°C to 60 °C {- 4 °F to 140 °F}
 - Humidity: Operation: 30% to 80% RH (No condensation)
Storage: 30% to 90% RH (No condensation)
- Even within the above temperature/humidity ranges, using for a long time in an extreme environment will result in the product deterioration and will shorten the product life.
- Do not place the computer in the following areas, otherwise the computer may be damaged.
 - Near electronic equipment. Image distortion or noise may occur.
 - Near magnets or in magnetic fields.
 - In extremely high or low temperature.
 - As the computer can become hot during operation, keep it away from items that are sensitive to heat.

Handling Cautions

This computer is designed to minimize shock to parts such as the hard disk drive, but no warranty is provided against any trouble caused by shock. Be extremely careful when handling the computer.

- When carrying the computer:
 - Turn off the computer.
 - Remove all external devices, cables, cards and other protruding things.
 - Remove a disc in the CD/DVD drive.
 - Do not drop or hit the computer against solid objects.
 - Do not leave the display open.
 - Do not pick up or hold the computer by the PC card slot or display parts.
- When you board an airplane, take the computer with you and never put it in your checked luggage. When using the computer on airplane, follow the airline's instructions.
- When carrying a spare battery, put it in a plastic bag to protect its terminals.
- This computer contains a magnet and magnetic products at the locations circled in the illustration at right. Avoid leaving metallic object or magnetic media in contact with these areas.
- The touch pad is designed to be used with a finger tip. Do not place any object on its surface and do not press down strongly with sharp-pointed or hard objects that may leave marks (e.g., nails, pencils and ball point pens).
- Avoid any harmful substances such as oil from getting into the touch pad. The cursor may not work correctly.
- If the computer is being carried in a soft bag with the battery pack removed, avoid undue pressure on the body of the computer in a crowded place, etc., as this may result in damage to the LCD.

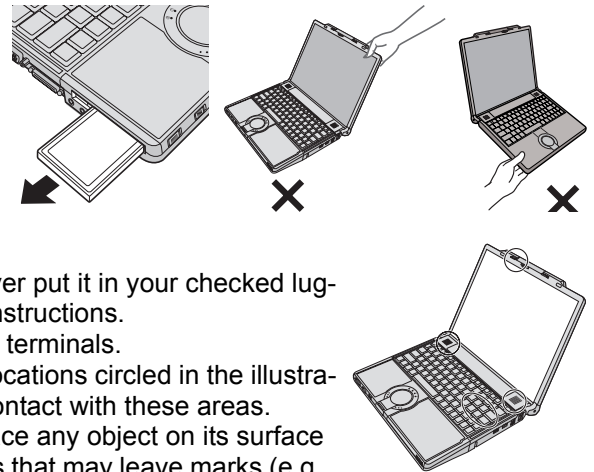

■ When using peripheral devices

Follow these instructions and the Reference Manual to avoid any damage to the devices. Carefully read the instruction manuals of the peripheral devices.

- Use the peripheral devices conforming to the computer's specifications.
- Connect to the connectors in the correct direction.
- If it is hard to insert, do not try forcibly but check the connector's shape, direction, alignment of pins, etc.
- If screws are included, fasten them securely.

■ Preventing your computer from unauthorized use via wireless LAN/wireless WAN/Bluetooth

<Only for model with wireless LAN/wireless WAN/Bluetooth>

- Before using wireless LAN/wireless WAN/Bluetooth, make the appropriate security settings such as data encryption.

■ Computrace® Software

Computrace® software tracks your stolen computer.

Perform the following steps before installing Computrace® software.

- Computrace® software is not included or installed in this computer.

Handling and Maintenance

CAUTION

- You will be unable to set [Computrace (R) BIOS Module] to [Disable] once you have set to [Enable]. Do not change the setting when not used.
 - Even if you have set [Computrace (R) BIOS Module] to [Enable], this setting may return to [Disable] after repairs to the motherboard, etc. have been made.

NOTE

- Consult Absolute Software Corp. before disposal.
- Refer to the following URL for Computrace® software for installation and available service regions. Note that this service is only available in certain regions.
<http://www.absolute.com>

- 1 Turn on or restart the computer, and press F2 while [Panasonic] boot screen is displayed.**

The Setup Utility starts up.

 - If the password is requested, enter the Supervisor Password.
- 2 Select the [Security] menu, then select [Computrace (R) Sub-Menu] and press Enter.**
- 3 Select [Computrace (R) BIOS Module], and set to [Enable].**
- 4 At the confirmation message, select [Execute] and press Enter.**
- 5 At the reconfirmation message, select [Execute] and press Enter.**
- 6 Press F10.**

At the confirmation message, select [Yes] and press Enter.
The computer restarts.

Maintenance

To clean the LCD panel and touch pad

Wipe lightly with a gauze or other dry, soft cloth.

To clean areas other than the LCD panel and touch pad

Wet a soft cloth with water or a diluted kitchen cleanser (neutral), wring the cloth out thoroughly, and wipe the dirty area gently. Using a detergent other than a neutral kitchen cleanser (e.g., a weak alkali cleanser) may adversely affect painted surfaces.

CAUTION

- Do not use benzene, thinner, or rubbing alcohol since it may adversely affect the surface causing discoloration, etc. Do not use commercially-available household cleaners and cosmetics, as they may contain components harmful to the surface.
- Do not apply water or detergent directly to the computer, since liquid may enter inside of the computer and cause malfunction or damage.

When Using the Computer with a Reduced Screen Resolution

When setting the screen resolution to a resolution below the LCD's resolution, e.g. 1024 × 768 pixels, the images appearing on the screen will be stretched. As a result, the characters displayed may appear blurred. This is normal, and not indicative of a malfunction.

To display large characters with no blurring

Try the following steps while keeping the LCD in its resolution (1400 × 1050).

- 1 Right-click the desktop and click [Personalize] - [Adjust font size (DPI)].**
 - A standard user needs to enter an administrator password.
- 2 Click [Larger scale (120 DPI)] and click [OK].**
 - To display enlarged font sizes in applications such as Internet Explorer:
Use the display enlargement function provided by the specific software application.
 - To magnify a part of the screen, use the Loupe Utility.

If You Spill Water on the Keyboard

Note that repairs resulting from liquids being spilled on the computer are not free of charge, and not covered by warranty.

The keyboard on this computer incorporates a drain system (a moisture protection mechanism) that minimizes the amount of liquid reaching the inside of the computer even if water is spilled on the keyboard. Any water that comes in contact with the keyboard is drained off through holes in the bottom of the computer, so that virtually no water is left inside the computer. However, this is not a guarantee against damage to the hard disk or other internal parts, or against the loss or deletion of data.

The drain system is incorporated into only the keyboard. It does not apply to any other components.

- If you spill water or any other liquid on the keyboard, even a small amount, be sure to perform the following steps. Failure to perform these steps may result in damage to the computer. The drain system will not provide complete protection against water entering the computer.

1 Immediately turn off the computer, and remove the AC adaptor.

2 Wipe any water droplets off of the top of the keyboard using a soft, dry cloth.



3 Slowly lift up the computer, keeping it level, and wipe any water coming out of the holes on the bottom using a soft, dry cloth.

If the computer is tilted during this step, liquid may seep inside the computer resulting in damage.

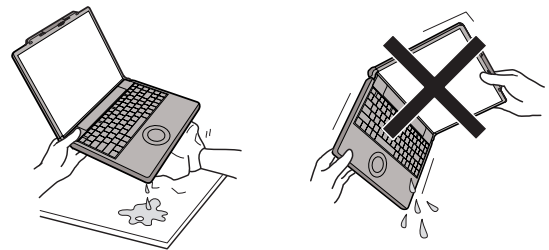

4 Keeping the computer level, move the computer to a dry place.

If the computer is placed back on the wet surface, water may seep inside the computer from the bottom.

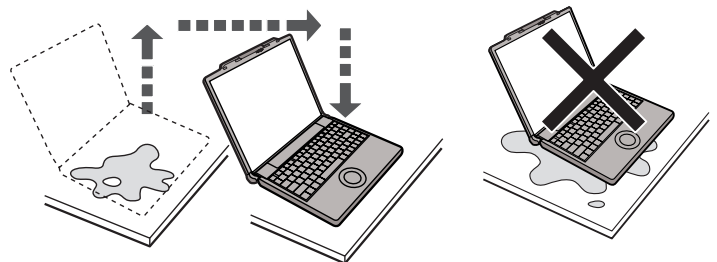

5 Insert the tip of a ball-point pen or other object into the emergency hole on the bottom of the computer, and move it in the direction of the arrow to open the disc cover.

The computer should be kept level, without tilting, while the disc cover is being opened. Move the computer to the edge of the desk or table to perform this operation.

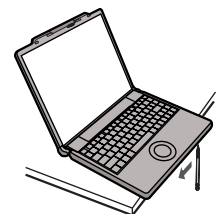

6 Check to see whether there is any water inside the CD/DVD drive.

If there is water inside, wipe it using a soft, dry cloth.

7 Remove the battery pack.

8 Be sure to contact your technical support office to have the computer checked for any malfunctions.

Expanding Memory

Use RAM modules that comply with the specifications below. Using any other module may cause malfunction or result in computer failure.

RAM module specifications:

DDR2 SDRAM, 172 pins, Micro DIMM, 1.8 V, PC2-4200

CAUTION

- Use recommended RAM module products. Do not use non-recommended RAM modules. Non-recommended RAM modules may not operate properly, and may cause damage to your computer. Some non-recommended RAM modules may overheat, causing the cover to warp. Refer to various sources for recommended RAM module.
- RAM modules are extremely sensitive to static electricity. There are cases where static electricity generated by the human body has adversely affected such RAM modules. When inserting or removing a RAM module, do not touch the terminals or internal components, insert objects other than the module, or allow foreign particles to enter. Doing so has been known to cause damage, fire or electric shock.
- Matsushita Electric Industrial Co., Ltd. will bear no responsibility whatsoever for failures or damage caused by the use of non-recommended RAM modules, or by incorrect installation or removal of such RAM modules. Before installing a RAM module, confirm the product type and the correct installation method.

Preparation

- ① Turn off your computer.
 - Do not use the sleep or hibernation.
- ② Disconnect the AC adaptor and remove the battery pack.
- ③ Remove the screw (A) and the cover on the bottom of the computer.
 - Use the appropriate screw driver so as not to strip the thread of screw.

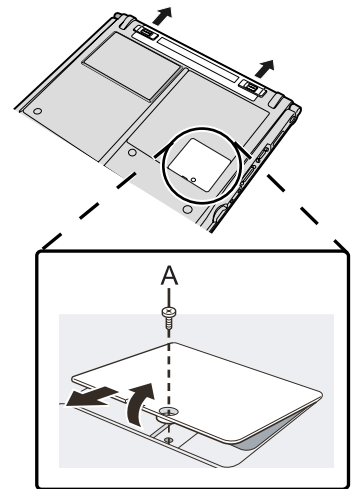

Inserting the RAM Module

- 1 **Place the RAM module lightly in parallel with the RAM module slot so that the notch (B) of the RAM module and the protrusion (C) of the RAM module slot is in the same direction.**
 - The gold terminals are visible at this point.
 - RAM module is at an angle of 20° - 30° with the horizontal line.

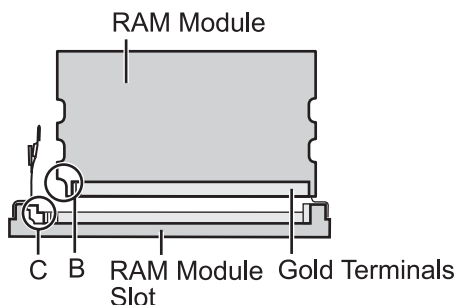

(Front image view)

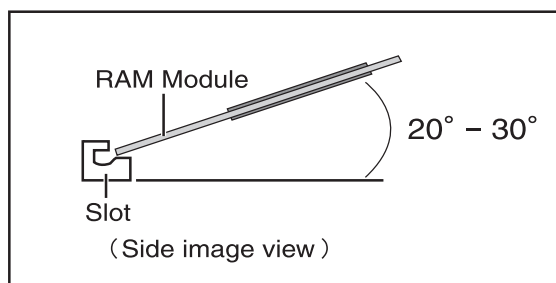

2 Insert the RAM module parallel to the slot firmly until the gold terminals are invisible.

- If it is hard to insert the RAM module, do not try forcibly but check the module's direction.

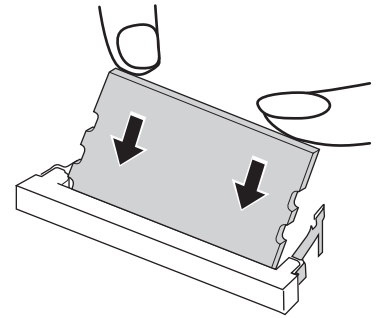

3 Press the RAM module down until the right and left hooks (D) lock into place.

- When pressing down the module, the right and left hooks will open slightly and will return after locking.
- If it is hard to press down the RAM module, do not try forcibly but check the module's direction.

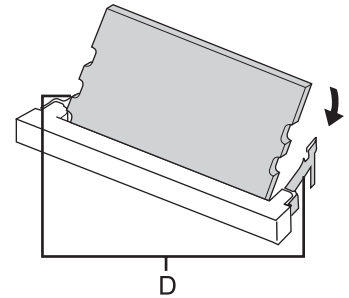

4 Set the cover and battery pack back.

NOTE

- If the RAM module is recognized correctly, the total size of this computer's memory and RAM module memory is displayed on the [Information] menu of the Setup Utility.
If the RAM module is not recognized, turn off the computer and insert it again.

Removing the RAM Module

1 Carefully open the left and right hooks (E).

The RAM module will be raised.

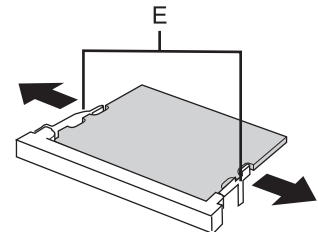

2 Carefully remove the RAM module from the slot.

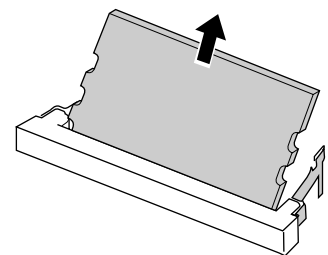

3 Set the cover and battery pack back.

Hard Disk Backup/Restore Function

[Backup and Restore Center] and [System Recovery Options] allow you create a backup of the entire hard disk data, which can be used to recover from hardware failure.

Matsushita Electric Industrial Co., Ltd. will bear no responsibility for any damage suffered (including loss of data) as a result of the use of this function.

Creating a backup of the hard disk data

To create a backup of the entire hard disk to another storage media (e.g., external hard disk): Use [Back up computer]. To create a backup of a file or a folder: Use [Back up files].

For further information, click  (Start) - [Control Panel] - [Back up your computer].

NOTE

- Connect the AC adaptor and do not remove it until backup is complete.

Restoring the hard disk data

NOTE

- This function does not work when you turn on the computer for the first time or just after you reinstall Windows. Start and shut down Windows Vista, and then you can use the function.
- When you forget the administrator account password or you need to restore the recovery partition, use Product Recovery DVD-ROM.
- Connect the AC adaptor and do not remove it until restoration is complete.

1 Turn on the computer, and press **F2** while [Panasonic] boot screen is displayed.

The Setup Utility starts up.

- If the password is requested, enter the Supervisor Password.

2 Press **F9**.

At the confirmation message, select [Yes] and press **Enter**.

3 Select the [Exit] menu.

4 Select [Repair Your Computer] and press **Enter**.

5 Click [Next] and click [Next].

6 Select user name and input password, then click [OK].

7 Click [Windows Complete PC Restore] and follow the on-screen instructions.

If you cannot proceed the above operation, restore the hard disk using Product Recovery DVD-ROM.

NOTE

You can restore the hard disk following the procedure below as well.

- On [Advanced Boot Options] screen
 - ① Perform the above procedure, steps 1 - 2.
 - ② Press **F10**.
At the confirmation message, select [Yes] and press **Enter**.
The computer will restart.
 - ③ When [Panasonic] boot screen disappears, press and hold **F8**.
If [Advanced Boot Options] screen is not displayed, the recovery partition may be damaged. In this case, restore the hard disk using Product Recovery DVD-ROM.
 - ④ Select [Repair Your Computer] and press **Enter**.
 - ⑤ Follow the on-screen instructions.
- How to use Product Recovery DVD-ROM
 - ① Perform the steps 1 to 9 of "Reinstalling Software" (→ page 26).
 - ② Click [Run "System Recovery Options".] and click [Next].
 - ③ Follow the on-screen instructions.

Hard Disk Data Erase Utility

When disposing the computer or transferring the ownership, erase all hard disk data in order to avoid data leakage. Even if you erase the data or initialize the hard disk using normal Windows commands, the data can be read with some special software. Use the hard disk data erase utility to erase the data completely. Note that transferring of the ownership without uninstalling the commercial software will be a violation of the software's license agreement.

The hard disk data erase utility erases data using an overwriting method, but there is a possibility that due to malfunctions or other operational errors, data may not be completely erased. There are also specialized devices that may be able to read data that has been erased using this method. If you need to erase highly confidential data, we recommend that you contact a company that specializes in this process. Matsushita Electric Industrial Co., Ltd. will bear no responsibility for losses or damages suffered as a result of the use of this utility.

NOTE

- Even if hard disk data erase is performed, the number of times of DVD's region code setting will not be reset.
- This utility cannot erase data for specific partitions. The entire hard disk data including the data of the recovery partition will be erased.
- It will take 2 to 5 hours to erase the data. (Erasing time varies depending on the capacity of the hard disk.)

Preparation

- Prepare the Product Recovery DVD-ROM (included).
 - Remove all peripherals.
 - Connect the AC adaptor and do not remove it until hard disk data erase is complete.
- 1 Perform the steps 1 to 9 of “Reinstalling Software” (→ page 26)**
 - In step 2, you do not have to write down all of the contents of the Setup Utility.
 - If [Enter Password] is displayed during the following procedures, input the Supervisor Password or the User Password.
 - 2 Click [Erase the whole data on the Hard Disk for security] and click [Next].**
 - 3 At the confirmation message, click [YES].**
 - 4 Click [Continue].**
 - 5 Click [Continue] again.**
 - 6 Click [YES].**
Erasing the hard disk data starts.
 - 7 After erasing is completed, remove the Product Recovery DVD-ROM and click [OK].**

Reinstalling Software

Reinstalling software will return the computer to the default condition. When you reinstall the software, the hard disk data will be erased.

Back up important data to other media or an external hard disk before reinstallation.

CAUTION

Do not delete the recovery partition on the hard disk. This partition contains data to help recover your system. The disk space in the partition is not available to store data.

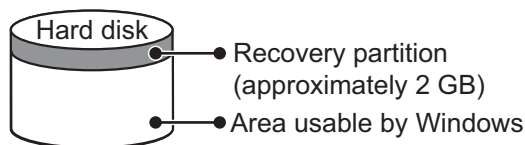

Preparation

- Prepare the Product Recovery DVD-ROM (included).
- Remove all peripherals.
- Connect the AC adaptor and do not remove it until reinstallation is complete.

NOTE

- Even if reinstallation is performed, the number of times of DVD's region code setting will not be reset.

- 1 Turn on the computer, and press F2 while [Panasonic] boot screen is displayed.**
The Setup Utility starts up.
 - If the password is requested, enter the Supervisor Password.
- 2 Write down all of the contents of the Setup Utility and press F9.**
At the confirmation message, select [Yes] and press Enter.
- 3 Select the [Main] menu, then select [DVD Drive Power] and press Enter.**
- 4 Select [On] and press Enter.**
- 5 Select the [Boot] menu, then select [Optical Drive] and press F6 until [Optical Drive] is at the top of [Boot priority order].**
- 6 Press F10.**
At the confirmation message, select [Yes] and press Enter.
The computer will restart.
- 7 Press F2 while [Panasonic] boot screen is displayed.**
 - If the password is requested, enter the Supervisor Password.
- 8 Set the Product Recovery DVD-ROM into the CD/DVD drive.**
 - When the disc cover does not open, confirm the following settings.
 - [DVD Drive] is set to [Enable] in the [Advanced] menu.
 - [DVD Drive Power] is set to [On] in the [Main] menu.If the setting has not been made, take the following steps.
 - ① Set [DVD Drive] to [Enable] and set [DVD Drive Power] to [On].
 - ② Press F10.
At the confirmation message, select [Yes] and press Enter.
The computer will restart.
 - ③ Press F2 while [Panasonic] boot screen is displayed.
 - ④ Set the Product Recovery DVD-ROM.
- 9 Press F10.**
At the confirmation message, select [Yes] and press Enter.
The computer will restart.
- 10 Click [Reinstall Windows] and click [Next].**
The License Agreement screen appears.
- 11 Click [Yes, I agree to the provisions above and wish to continue!] and click [Next].**

12 Select the settings and click [Next].

- [Reinstall Windows to the whole Hard Disk to factory default.]
You will have a single partition.
- [Reinstall Windows to the operating system partition.]
You can keep the partition structure.

13 At the confirmation message, click [YES].

Reinstallation starts automatically. (It will take approximately 30 minutes.)

- Do not interrupt reinstallation, for example by turning off the computer. Otherwise reinstallation may become unavailable as Windows may not start up or the data may be corrupted.

14 Remove the Product Recovery DVD-ROM, and then click [OK] to turn off the computer.

15 Turn on the computer, and press F2 while [Panasonic] boot screen is displayed.

The Setup Utility starts up.

- If the password is requested, enter the Supervisor Password.

16 Press F9.

At the confirmation message, select [Yes] and then press Enter.

The Setup Utility settings excluding the password(s) will return to the default values.

17 Press F10.

At the confirmation message, select [Yes] and press Enter.

The Setup Utility will close, and the computer will restart.

18 Perform the first-time operation (→ page 14).

19 Start the Setup Utility and change the settings as necessary.

20 Perform Windows Update.

Troubleshooting (Basic)/Error Code/Message



Troubleshooting (Basic)

Follow the instructions below when a problem has occurred. There is also an advanced troubleshooting guide in the "Reference Manual". For a software problem, refer to the software's instruction manual. If the problem persists, contact your technical support office. You can also check the computer's status in the PC Information Viewer (→  Reference Manual "Check the Computer's Usage Status").

■ Starting Up and Sleep and Hibernation Mode

<p>The computer does not power on/ The power indicator or battery indicator is not lit.</p>	<ul style="list-style-type: none"> ● Connect the AC adaptor. ● Insert a fully charged battery. ● Remove the battery pack and the AC adaptor, then connect them again. ● If an additional RAM module has been inserted, remove the RAM module and check to see if the RAM module is the recommended one. ● When the CPU temperature is high, the computer may not start up to prevent overheating of the CPU. Wait until the computer cools down, and then turn the power on again. If the computer does not power on even after cooling down, contact your technical support office.
<p>Windows does not start up.</p>	<ul style="list-style-type: none"> ● When you turn on the computer for the first time after purchase Windows setup screen may not be displayed and [The computer restarted unexpectedly or encountered an unexpected error] message may appear. This message appears when the computer is forcibly turned off (e.g. The AC adaptor is removed. The battery becomes empty due to setup without connecting the AC adaptor.) and you cannot use Windows until reinstallation is complete. In this case, reinstall. ● When Windows does not start when resuming from hibernation, set the Product Recovery DVD-ROM and display [System Recovery Options] (→ page 24), and run [Startup Repair]. If the problem persists, perform reinstallation with the Product Recovery DVD-ROM. ● Remove all peripheral devices. <ul style="list-style-type: none"> • If a device is connected to the USB port, disconnect the device or set [Legacy USB Support] to [Disable] in the [Advanced] menu of the Setup Utility. ● If an additional RAM module has been inserted, remove the RAM module and check to see if the RAM module is the recommended one. ● If the power indicator is lit, slide the power switch for four seconds or longer to turn off, then turn on again. ● Using the following procedure, start up in Safe Mode, and check the error details. <ol style="list-style-type: none"> ① Turn on the computer, and when the [Panasonic] boot screen disappears (after entering the password*¹ if one is set) hold down F8. ② Release your finger when [Advanced Boot Options] is displayed, and with ↑ or ↓, select [Safe Mode], then press Enter. Follow the on-screen instructions. <p>*¹ Supervisor Password or User Password set with the Setup Utility</p> <ul style="list-style-type: none"> ● Press F9 in the Setup Utility (→ page 31 "To start the Setup Utility") to return the Setup Utility settings (excluding the passwords) to the default values. Start the Setup Utility and make the settings again.
<p>There is a beep sound, and either "Extended RAM Module Failed" or "Standard RAM Failed" appears.</p>	<ul style="list-style-type: none"> ● If "Extended RAM Module Failed" appears, the RAM module is not correctly inserted. Turn off the computer, check that the RAM module is a recommended module, then insert it correctly. ● If "Standard RAM Failed" appears, contact your technical support office.
<p>Cannot boot from internal CD/DVD drive.</p>	<ul style="list-style-type: none"> ● Make sure that the bootable CD/DVD is set properly. ● Start the Setup Utility, and confirm the following settings. <ul style="list-style-type: none"> • [DVD Drive] is set to [Enable] in the [Advanced] menu. • [DVD Drive Power] is set to [On] in the [Main] menu. • [Optical Drive] is the first device shown in [Boot priority order] in the [Boot] menu. ● Bootable CD/DVD created using B's Recorder in the CF-W4/CF-W5/CF-Y4/CF-Y5 series cannot be used on this computer. If you want to share bootable CD/DVD with those series, create a new bootable CD/DVD. ● When an external CD/DVD drive is connected, you cannot boot from the internal CD/DVD drive.
<p>You have forgotten the password.</p>	<ul style="list-style-type: none"> ● Supervisor Password or User Password: Contact your technical support office. ● Administrator password: <ul style="list-style-type: none"> • If you have another account with Administrator authority, log-on with it, then delete the password for the problem account. • If you have a password reset disk, click [Reset password] displayed after the password input error, then follow the on-screen instructions to set a new password. <p>If you cannot do either of the above, you will need to reinstall (→ page 26) and setup Windows.</p>

■ Starting Up and Sleep and Hibernation Mode

<p>“Remove disks or other media. Press any key to restart” or a similar message appears.</p>	<ul style="list-style-type: none"> ● A floppy disk is in the floppy disk drive and it does not contain system startup information. Remove the floppy disk and press any key. ● This message may appear with some devices connected to the USB port. Remove the device or set [Legacy USB Support] to [Disable] in the [Advanced] menu of the Setup Utility. ● If the problem persists after removing the disk, it may be a hard disk failure. Perform the reinstallation and return the hard disk to its condition at the time of purchase. (→ page 26) If the problem persists even after the reinstallation, contact your technical support office.
<p>[Executing Battery Recalibration] screen appears.</p>	<ul style="list-style-type: none"> ● The Battery Recalibration was canceled before Windows was shut down last time. To start up Windows, turn off the computer by the power switch, and then turn on.
<p>The computer will not automatically enter sleep/hibernation.</p>	<ul style="list-style-type: none"> ● If you connect to a network using wireless LAN function, perform access point settings. (→  Reference Manual “Wireless LAN”) ● If you do not use wireless LAN function, turn off wireless LAN function. (→  Reference Manual “Disabling/Enabling Wireless Communication”) ● Make sure that you are not using any software that regularly accesses the hard disk.
<p>When logging on (e.g., resuming the computer), audio is distorted.</p>	<ul style="list-style-type: none"> ● Perform the following steps to change the audio settings to prevent audio output. <ol style="list-style-type: none"> ① Right-click the desktop and click [Personalize] - [Sounds]. ② Remove the check mark from [Play Windows Startup sound], and click [OK].
<p>Cannot resume.</p>	<ul style="list-style-type: none"> ● One of the following operations may have been carried out. <ul style="list-style-type: none"> • In sleep mode, the AC adaptor or battery pack was disconnected, or a peripheral was connected or disconnected. • The power switch was slid for four seconds or longer to forcibly turn off the computer. Slide the power switch to turn on the computer. Data not saved will be lost.
<p>Other startup problems.</p>	<ul style="list-style-type: none"> ● Check to see if there was a disk error. <ol style="list-style-type: none"> ① Remove all peripheral devices including an external display. ② Click  (Start) - [Computer] and right-click [Local Disk (C:)], and click [Properties]. ③ Click [Tools] - [Check Now]. <ul style="list-style-type: none"> • A standard user needs to enter an administrator password. ④ Select the option in [Check disk options] and click [Start]. ● Start the computer in Safe Mode and check the error details. (→ page 28 “Windows does not start up”)

■ Shutting Down

<p>Windows does not shut down.</p>	<ul style="list-style-type: none"> ● Remove all peripheral devices. ● Wait one or two minutes. It is not a malfunction.
------------------------------------	-------------------------------------------------------------------------------------------------------------------------------------------------

■ Password

<p>Even after entering the password, a message appears requesting to type it again.</p>	<ul style="list-style-type: none"> ● If  lights up, press NumLk to disable the ten-key mode, and then input. ● If  lights up, press Caps Lock to disable the Caps Lock mode, and then input.
-----------------------------------------------------------------------------------------	----------------------------------------------------------------------------------------------------------------------------------------------------------------------------------------------------------------------------------------------------------------------------------------------------------------------------------------------------------------------------------------------------------

■ Display

<p>When the screen becomes black for a moment.</p>	<ul style="list-style-type: none"> ● When you set [Intel video driver power saving function (Intel® Display Power Saving Technology)] of Power Saving Utility to [Enable], if you do the following operations, the screen becomes black for a moment, but this is not a malfunction. You can continue to use this. <ul style="list-style-type: none"> • Adjust the brightness of the screen with Fn + F1 / Fn + F2. • Remove and insert the AC adaptor. <p>While you are using motion video playback software, benchmark software for graphic, if error screen is displayed or application software does not function normally, set [Intel video driver power saving function (Intel® Display Power Saving Technology)] to [Disable].</p>
<p>No display.</p>	<ul style="list-style-type: none"> ● The external display is selected. Press Fn + F3 to switch the display. Wait until the display has been switched completely before pressing Fn + F3 again. ● The display is turned off by the power-saving function. To resume, do not press the direct selection keys, but press any other key like Ctrl. ● The computer entered sleep or hibernation by the power-saving function. To resume, slide the power switch. ● The screen may become darker. Press Fn + F2 to make the screen brighter.
<p>The screen is disordered.</p>	<ul style="list-style-type: none"> ● Changing the number of display colors and resolution may affect the screen. Restart the computer. ● The refresh rate of the internal LCD may be 40 hertz. Change the refresh rate of the internal LCD. <ol style="list-style-type: none"> ① Right-click the desktop and click [Graphics Properties]. ② Click [Display Devices] - [Intel(R) Dual Display Clone] - [Display Settings]. ③ If [Refresh Rate] of the Notebook is [40 Hertz], change to [60 Hertz] and click [OK].

Troubleshooting (Basic)/Error Code/Message



■ Display

The external display does not work normally.	<ul style="list-style-type: none"> ● If the external display does not support the power saving function, it may not work normally when the computer enters the power saving mode. Turn off the external display.
The sidebar gadgets are not correctly displayed.	<ul style="list-style-type: none"> ● Log off and log on Windows, and display the sidebar again.

■ Battery

The battery indicator is lights red.	<ul style="list-style-type: none"> ● The battery level is very low (the charge is approx. 9% or less). ● Connect the AC adaptor. You can use the computer when the indicator light is orange. If you do not have an AC adaptor, save your data and power off your computer. After replacing the battery pack with a fully charged one, turn your computer on again.
The battery indicator is blinking.	<ul style="list-style-type: none"> ● If blinking red: Quickly save your data and power off your computer. Remove the battery pack and disconnect the AC adaptor, then connect them again. If the problem persists, contact your technical support office. The battery pack or charging circuit may be defective. ● If blinking orange: <ul style="list-style-type: none"> • Battery cannot be recharged temporarily because the internal temperature of the battery pack is outside the acceptable temperature range for recharging. Your computer can be used normally in this state. Once the range requirement is satisfied, charging begins automatically. • Software applications and peripheral devices (USB devices, etc.) are consuming too much power. Exit the software applications currently running. Once the range requirement is satisfied, charging begins automatically.
The battery indicator is flashing.	<ul style="list-style-type: none"> ● The battery is recharging. If [Battery Charging Indicator] in [Main] menu of the Setup Utility is set to [Flashing], the indicator will alternately become lighter and darker.

■ Touch Pad

The cursor does not work.	<ul style="list-style-type: none"> ● When using the external mouse, connect it correctly. ● Restart the computer by using the keyboard. Press  and press  three times, and press  to select [Restart] and press Enter. ● If the computer does not respond to keyboard commands, read "No response" (→ below).
Cannot input using the touch pad.	<ul style="list-style-type: none"> ● Set [Touch Pad] to [Enable] in the [Main] menu of the Setup Utility. ● The drivers for some mice may disable the touch pad. Check your mouse's operating instructions.

■ Reference Manual

The Reference Manual is not displayed.	<ul style="list-style-type: none"> ● Install Adobe Reader. <ol style="list-style-type: none"> ① Log on to Windows as an administrator. ② Click  (Start) and input "c:\util\reader\setup.exe" in [Start Search] then press Enter. ③ Update Adobe Reader to its latest version. If your computer is connected to the internet, start up Adobe Reader and click [Help] - [Check for Updates].
----------------------------------------	-------------------------------------------------------------------------------------------------------------------------------------------------------------------------------------------------------------------------------------------------------------------------------------------------------------------------------------------------------------------------------------------------------------------------------------------------------------------------------------------------------------------------------------------

■ Reinstalling B's Recorder/B's CLiP

A serial number is requested when reinstalling.	<ul style="list-style-type: none"> ● Input the following serial number. B's Recorder: B's CLiP:
-------------------------------------------------	------------------------------------------------------------------------------------------------------------------------

■ Others

[System Restore] does not appear by pressing F8 .	<ul style="list-style-type: none"> ● The restoration program does not run after Windows Anytime Upgrade is executed. For further information, access the following web site: https://www.pavc.panasonic.co.jp/pc/itn/support/vistainfo.html
No response.	<ul style="list-style-type: none"> ● Press Ctrl+Shift+Esc to open Task Manager and close the software application that is not responding. ● An input screen (e.g., password input screen at startup) may be hidden behind another window. Press Alt+Tab to check. ● Slide the power switch for four seconds or longer to shut down the computer, and then slide the power switch to turn it on. If the application program does not work normally, uninstall and reinstall the program. To uninstall, click  (Start) - [Control Panel] - [Uninstall a program].
The PC information viewer startup is slow.	<ul style="list-style-type: none"> ● It may take a minute or longer to start up depending on the network environment.

■ Others

The computer does not recognize the CD/DVD drive.	<ul style="list-style-type: none"> ● Restart the computer. After the computer restarts, it may recognize a CD/DVD drive.
---------------------------------------------------	-----------------------------------------------------------------------------------------------------------------------------------------

Error Code/Message

Follow the instructions below when an error code or message appears. If the problem persists or if the error code/message displayed is not shown here, contact your technical support office.

Error Code/Message	Solution
0211 Keyboard error	<ul style="list-style-type: none"> ● Disconnect external keyboard.
0251 System CMOS checksum bad - Default configuration used	<p>An error has occurred in the memory of Setup Utility settings. This occurs when the memory content is changed by an unexpected program operation, etc.</p> <ul style="list-style-type: none"> ● Start the Setup Utility and return the settings to the default values, and then change the settings as necessary. ● If the problem persists, the internal clock battery may need to be replaced. Contact your technical support office.
0271 Check date and time settings	<p>The date and time settings are not correct.</p> <ul style="list-style-type: none"> ● Start the Setup Utility and set the correct date and time. ● If the problem persists, the internal clock battery may need to be replaced. Contact your technical support office.
0280 Previous boot incomplete - Default configuration used	<p>Startup has failed repeatedly, so the Setup Utility settings have been returned to the default values to startup the computer.</p> <ul style="list-style-type: none"> ● Start the Setup Utility and return the settings to the default values, and then change the settings as necessary.
Press <F2> to Setup	<ul style="list-style-type: none"> ● Write down the error details and press F2 to start the Setup Utility. Change the settings if necessary.
Operating System not found	<p>The operating system is not installed in the floppy disk or the hard disk that you are going to boot from.</p> <ul style="list-style-type: none"> ● If using a floppy disk, change the disk to the one you can use for boot. ● If using the hard disk, check if the hard disk is recognized in [Information] menu of the Setup Utility. If the hard disk is recognized, perform the reinstallation (→ page 26). If not, contact your technical support office. ● If a device is connected to the USB port, disconnect the device, or set [Legacy USB Support] to [Disable] in the [Advanced] menu of the Setup Utility.

■ To start the Setup Utility

- ① Restart the computer.
- ② Press **F2** while [Panasonic] boot screen is displayed.

Hardware Diagnostics

If the hardware installed in this computer is not operating properly, you can use the PC-Diagnostic Utility to determine whether or not there is a problem.

If the utility discovers a problem in the hardware, contact your technical support office.

Hardware that can be checked using the PC-Diagnostic Utility

Hardware below can be checked using this utility. (Software cannot be checked.)

- CPU
- Memory
- Hard Disk
- CD/DVD Drive
- Video Controller
- Sound*¹
- Modem
- LAN
- Wireless LAN*²
- Wireless WAN*³
- Bluetooth*⁴
- USB
- PC Card Controller
- SD Card Controller
- Keyboard
- Touch Pad

*¹ When the PC-Diagnostic Utility is running, a loud beep will sound, so do not use headphones at this time. (The beep will not sound if mute is using Windows.)

*² Only for model with wireless LAN

*³ Only for model with wireless WAN

*⁴ Only for model with Bluetooth

- When the video diagnostic check is running, the display may be distorted, and when the audio diagnostic check is running, sounds may be generated from the speakers. These are not malfunctions.

Regarding the PC-Diagnostic Utility

NOTE

- For the hard disk only, you can select standard diagnostic check or extended diagnostic check. When the PC-Diagnostic Utility starts up, it will run the standard diagnostic check.
- We recommend that you use the touch pad for operations. When not using the touch pad, you can operate using the internal keyboard instead.

Operations	Touch pad operations	Internal keyboard operations
Select icon	Place the cursor above the icon	Press Space and then press → ← ↑ ↓ (☒ (close) cannot be selected)
Click the icon	Tap or click (right click cannot be used)	Press Space above the icon
Complete the PC- Diagnostic Utility and then restart the computer	Click ☒ (close)	Press Ctrl + Alt + Del .

- If the touch pad does not operate properly, press **Ctrl + Alt + Del** to restart the computer, or slide the power switch to turn the power off, and then restart the PC-Diagnostic Utility.

Running the Diagnostic Check

Run this utility using the default settings in the Setup Utility.

If the Setup Utility or other settings will not allow a hardware to be executed, the hardware icon will be displayed in gray.

- 1 Connect the AC adaptor, and turn on the wireless switch.**
During the diagnostic check, do not remove the AC adaptor, or attach any peripheral devices.
- 2 Turn on or restart the computer, and press **F2** while [Panasonic] boot screen is displayed.**
The Setup Utility starts up.
 - If the password is requested, enter the Supervisor Password.
 - If you are using the computer after changing the settings from the status at the time of purchase, we recommend that you make a note of the settings that are changed.

3 Press **F9**.

At the confirmation message, select [Yes] and press **Enter**.

4 Select the [Main] menu, set [DVD Drive Power] to [On].





5 Press **F10**.

At the confirmation message, select [Yes] and press **Enter**.

The computer will restart.



6 Press **Ctrl + F7** while [Panasonic] boot screen is displayed.

When the PC-Diagnostic Utility starts up, it will automatically begin the diagnostic check for all hardware components.

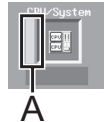
- If the password is requested, enter the password.
- The touch pad and the internal keyboard cannot be used until alternating blue and yellow colors are displayed on the left side of the hardware icon (A).
- By clicking the icon, you can execute the following operations:
 -  : Start the diagnostic check from the beginning
 -  : Stop the diagnostic check (You cannot restart the check partway through by clicking )
 -  : Display help (click the screen or press **Space** to return to the original diagnostic check screen)
- You can check the status of the diagnostic check by the display color on the left side of the hardware icon (A).
 - Aqua: Not running diagnostic check
 - Alternating blue and yellow: Currently running diagnostic check. The interval of the alternating colors differs depending on the type of diagnostic check currently running.
During memory diagnostic check, the display may freeze for a long period of time. Wait until the process is complete.
 - Green: No problems discovered
 - Red: Problems discovered



NOTE

- Using the following procedure, you can run a diagnostic check on a specified hardware component, or run an extended diagnostic check on the hard disk (The extended diagnostic check is only for the hard disk). The extended diagnostic check is more detailed, and so requires a longer period of time to run.
 - ① Click  to stop the diagnostic check.
 - ② Click the icon for the hardware that is not to be checked, so that the icon is displayed in gray (B). When running a check on the hard disk, clicking the icon once will turn on the extended diagnostic check ("FULL" (C) will be displayed below the icon); click again, and the icon will be displayed in gray.
 - ③ Click  to start the diagnostic check.

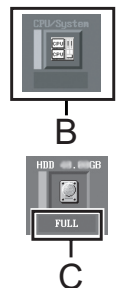

7 When all the hardware has been checked, confirm the diagnostic check results.

If the display is red and the message "Check Result TEST FAILED" is displayed, you can assume that there is a problem with the computer's hardware. Confirm which hardware component is displayed as red, and contact your technical support office.

If the display is green and the message "Check Result TEST PASSED" is displayed, the computer's hardware is operating normally. Continue using the computer as it is. If the computer still does not operate properly, reinstall the software. (→ page 26)

NOTE

- If you run a memory diagnostic check after installing a new RAM module (sold separately) and the message "Check Result TEST FAILED" is displayed:
Remove the additional RAM module and run the diagnostic check again. If the message "Check Result TEST FAILED" is still displayed, you can assume that there is a problem with the internal RAM module.

8 After the diagnostic check is complete, click (close), or press **Ctrl + Alt + Del** to restart the computer.

NOTE

- When you set [DVD Drive Power] to [On] in the [Main] menu of Setup Utility, you will hear operation sound from CD/DVD drive soon after the computer starts the startup procedure. To avoid the sound when the computer is starting up, set [DVD Drive Power] to [Off].

LIMITED USE LICENSE AGREEMENT

THE SOFTWARE PROGRAM(S) (“PROGRAMS”) FURNISHED WITH THIS PANASONIC® PRODUCT (“PRODUCT”) ARE LICENSED ONLY TO THE END-USER (“YOU”), AND MAY BE USED BY YOU ONLY IN ACCORDANCE WITH THE LICENSE TERMS DESCRIBED BELOW. YOUR USE OF THE PROGRAMS SHALL BE CONCLUSIVELY DEEMED TO CONSTITUTE YOUR ACCEPTANCE OF THE TERMS OF THIS LICENSE.

Matsushita Electric Industrial Co., Ltd. (“MEI”) has developed or otherwise obtained the Programs and hereby licenses their use to you. You assume sole responsibility for the selection of the Product (including the associated Programs) to achieve your intended results, and for the installation, use and results obtained therefrom.

LICENSE

- A. MEI hereby grants you a personal, non-transferable and non-exclusive right and license to use the Programs in accordance with the terms and conditions stated in this Agreement. You acknowledge that you are receiving only a LIMITED LICENSE TO USE the Programs and related documentation and that you shall obtain no title, ownership nor any other rights in or to the Programs and related documentation nor in or to the algorithms, concepts, designs and ideas represented by or incorporated in the Programs and related documentation, all of which title, ownership and rights shall remain with MEI or its suppliers.
- B. You may use the Programs only on the single Product which was accompanied by the Programs.
- C. You and your employees and agents are required to protect the confidentiality of the Programs. You may not distribute or otherwise make the Programs or related documentation available to any third party, by time-sharing or otherwise, without the prior written consent of MEI.
- D. You may not copy or reproduce, or permit to be copied or reproduced, the Programs or related documentation for any purpose, except that you may make one (1) copy of the Programs for backup purposes only in support of your use of the Programs on the single Product which was accompanied by the Programs. You shall not modify, or attempt to modify, the Programs.
- E. You may transfer the Programs and license them to another party only in connection with your transfer of the single Product which was accompanied by the Programs to such other party. At the time of such a transfer, you must also transfer all copies, whether in printed or machine readable form, of every Program, and the related documentation, to the same party or destroy any such copies not so transferred.
- F. You may not remove any copyright, trademark or other notice or product identification from the Programs and you must reproduce and include any such notice or product identification on any copy of any Program.

YOU MAY NOT REVERSE ASSEMBLE, REVERSE COMPILE, OR MECHANICALLY OR ELECTRONICALLY TRACE THE PROGRAMS, OR ANY COPY THEREOF, IN WHOLE OR IN PART.

YOU MAY NOT USE, COPY, MODIFY, ALTER, OR TRANSFER THE PROGRAMS OR ANY COPY THEREOF, IN WHOLE OR IN PART, EXCEPT AS EXPRESSLY PROVIDED IN THE LICENSE.

IF YOU TRANSFER POSSESSION OF ANY COPY OF ANY PROGRAM TO ANOTHER PARTY, EXCEPT AS PERMITTED IN PARAGRAPH E ABOVE, YOUR LICENSE IS AUTOMATICALLY TERMINATED.

TERM

This license is effective only for so long as you own or lease the Product, unless earlier terminated. You may terminate this license at any time by destroying, at your expense, the Programs and related documentation together with all copies thereof in any form. This license will also terminate effective immediately upon occurrence of the conditions thereof set forth elsewhere in this Agreement, or if you fail to comply with any term or condition contained herein. Upon any such termination, you agree to destroy, at your expense, the Programs and related documentation together with all copies thereof in any form.

YOU ACKNOWLEDGE THAT YOU HAVE READ THIS AGREEMENT, UNDERSTAND IT AND AGREE TO BE BOUND BY ITS TERMS AND CONDITIONS. YOU FURTHER AGREE THAT IT IS THE COMPLETE AND EXCLUSIVE STATEMENT OF THE AGREEMENT BETWEEN US, WHICH SUPERSEDES ANY PROPOSAL OR PRIOR AGREEMENT, ORAL OR WRITTEN, AND ANY OTHER COMMUNICATIONS BETWEEN US, RELATING TO THE SUBJECT MATTER OF THIS AGREEMENT.

About Intel® software products

The enclosed software products and documentation were developed at private expense, and are provided with “RESTRICTED RIGHTS.” Use, duplication or disclosure by the government is subject to restrictions as set forth in FAR 52.227-14 and DFARS 252.227-7013 et. seq. or its successor. The use of this product by the government constitutes acknowledgment of Intel’s proprietary rights in the product.

Contrat de licence d'usage limité

Le(s) logiciel(s) (les "Logiciels") fournis avec ce produit Panasonic® (le "Produit") sont exclusivement concédés en licence à l'utilisateur ultime ("vous"), et ils ne peuvent être utilisés que conformément aux clauses contractuelles cidessous. En utilisant les logiciels, vous vous engagez de manière définitive à respecter les termes, clauses et conditions des présentes.

Matsushita Electric Industrial Co., Ltd. ("MEI") a mis au point ou obtenu les Logiciels et vous en concède l'utilisation par les présentes. Vous assumez l'entière responsabilité du choix de ce Produit (y compris des Logiciels associés) pour obtenir les résultats escomptés, ainsi que de l'installation, de l'utilisation et des résultats obtenus.

Licence

- A. MEI vous octroie par les présentes le droit et la licence personnels, non cessibles et non exclusifs d'utiliser les Logiciels conformément aux termes, clauses et conditions de ce contrat. Vous reconnaissez ne recevoir qu'un droit limité d'utiliser les Logiciels et la documentation les accompagnant et vous vous engagez à n'obtenir aucun droit de titre, propriété ni aucun autre droit vis-à-vis des Logiciels et de la documentation les accompagnant ni vis-à-vis des algorithmes, concepts, dessins, configurations et idées représentés par ou incorporés dans les Logiciels et la documentation les accompagnant, dont les titres, propriété et droits resteront tous à MEI ou à leurs propriétaires.
- B. Vous ne pouvez utiliser les Logiciels que sur le Produit unique qui est accompagné par les Logiciels.
- C. Vous et vos employés ou agents êtes requis de protéger la confidentialité des Logiciels. Vous ne pouvez ni distribuer ni mettre les Logiciels et la documentation les accompagnant à la disposition d'un tiers, par partage de temps ou de quelque autre manière que ce soit, sans l'autorisation écrite préalable de MEI.
- D. Vous ne pouvez ni copier ni reproduire ni permettre la copie ni la reproduction des Logiciels ni de la documentation les accompagnant pour quelque fin que ce soit, à l'exception d'une (1) copie des Logiciels à des fins de sauvegarde uniquement pour soutenir votre utilisation des Logiciels sur le Produit unique qui est accompagné par les Logiciels. Vous ne pouvez ni modifier ni tenter de modifier les Logiciels.
- E. Vous ne pouvez céder les Logiciels et en octroyer la licence à une autre partie qu'en rapport avec votre cession du Produit unique qui est accompagné par les Logiciels à cette autre partie. Au moment de cette cession, vous devez céder également toutes les copies, que ce soit sous forme imprimée ou lisible par la machine, de tous les Logiciels ainsi que de la documentation les accompagnant, à la même partie ou détruire les copies non cédées.
- F. Vous ne pouvez retirer aucune marque de droits d'auteur, marque de commerce ou autre ni aucune identification de produit des Logiciels et vous devez reproduire et inclure toutes ces notices ou identifications de produit sur toutes les copies des Logiciels.

Vous ne pouvez assembler en sens inverse, compiler en sens inverse ni retracer les Logiciels ni aucune de leurs copies, de façon électronique ou mécanique, en tout ou en partie.

Vous ne pouvez utiliser, copier, modifier, altérer ni céder les Logiciels ni aucune de leurs copies, en tout ou en partie, à l'exception de ce qui est expressément stipulé dans ce contrat.

Si vous cédez la possession de toute copie ou de tout Logiciel à une autre partie, à l'exception de ce qui est autorisé au paragraphe E ci-dessus, votre licence est automatiquement résiliée.

Termes, clauses et conditions

Cette licence n'est effective que pour la durée de possession ou de crédit-bail du Produit, à moins d'une résiliation antérieure. Vous pouvez résilier cette licence à tout moment en détruisant, à vos frais, les Logiciels et la documentation les accompagnant avec toutes leurs copies, sous quelque forme que ce soit. Cette licence sera également résiliée, avec application immédiate, si les conditions de résiliation définies ailleurs dans ce contrat se sont réalisées ou si vous ne respectez pas les termes, clauses et conditions qui y sont contenues. Au moment de la résiliation, vous acceptez de détruire, à vos frais, les Logiciels et la documentation les accompagnant avec toutes leurs copies, sous quelque forme que ce soit.

Vous reconnaissez avoir lu ce contrat, en avoir compris toute la substance et avoir accepté de respecter ses termes, clauses et conditions. Vous reconnaissez en outre qu'ils sont la description complète et exclusive du contrat conclu entre nous, contrat qui remplace et annule toute proposition ou contrat précédent, écrit ou oral, et toute autre communication entre nous, relativement à l'objet du présent contrat.

Specifications

To check CPU speed, memory size and the hard disk drive (HDD) size:

Start the Setup Utility (→  *Reference Manual* "Setup Utility") and select [Information] menu.

[CPU Speed]: CPU speed, [System Memory]: Memory size, [Hard Disk]: Hard disk drive size

■ Main Specifications

Model No.		CF-Y7BWAZZJM
CPU/ Secondary cache memory		Intel® Core™ 2 Duo Processor Low Voltage L7500 (1.6 GHz, 4 MB ^{*1} L2 cache, 800 MHz FSB)
Chip Set		Mobile Intel® GM965 Express chip set
Main Memory ^{*2}		1 GB ^{*1} , DDR2 SDRAM (2 GB ^{*1} Max.)
Video Memory		UMA (251 MB ^{*1} Max.) ^{*3}
Hard Disk Drive		80 GB ^{*4} Approx. 2 GB ^{*4} are used as a recovery partition. (Users cannot use the partition.)
CD/DVD Drive		DVD MULTI Drive built-in, Buffer underrun error prevention function: Supported
Continuous Data Transfer Speed ^{*5*6}	Reading ^{*7}	●DVD-RAM ^{*8} : 2X (4.7 GB ^{*4})/1X (2.6 GB ^{*4}) ●DVD-R ^{*9} : 4X (Max.) ●DVD-RW: 4X (Max.) ●DVD-ROM: 8X (Max.) ●CD-ROM: 24X (Max.) ●CD-R: 24X (Max.) ●CD-RW: 20X (Max.) ●+R: 4X (Max.) ●+R DL: 4X (Max.) ●+RW: 4X (Max.)
	Writing ^{*10}	●DVD-RAM ^{*8} : 2X (4.7 GB ^{*4}) ●DVD-R: 1X/2X/2-4X ●DVD-RW: 1X/2X ●+R: 2.4X/2.4-4X ●+RW ^{*11} : 2.4X ●CD-R: 4X/8X/8-16X/8-24X ●CD-RW: 4X ●High-Speed CD-RW: 4X/8X/10X ●Ultra-Speed CD-RW: 8X/10X
Supported Discs/Format ^{*6}	Reading	●DVD-ROM (Single Layer, Dual Layer) ●DVD-Video ●DVD-R ^{*9} (1.4 GB, 3.95 GB, 4.7 GB) ^{*4} ●DVD-RW (Ver.1.1/1.2 1.4 GB, 2.8 GB, 4.7 GB, 9.4 GB) ^{*4} ●DVD-RAM ^{*8} (1.4 GB, 2.8 GB, 2.6 GB, 5.2 GB, 4.7 GB, 9.4 GB) ^{*4} ●+R (4.7 GB) ^{*4} ●+R DL (8.5 GB) ^{*4} ●+RW (4.7 GB) ^{*4} ●CD-Audio ●CD-ROM (XA compatible) ●CD-R ●Photo CD (multiple session compatible) ●Video CD ●CD-EXTRA ●CD-RW ●CD-TEXT
	Writing	●DVD-RAM ^{*8} (1.4 GB, 2.8 GB, 4.7 GB, 9.4 GB) ^{*4} ●DVD-R (1.4 GB, 4.7 GB for General) ^{*4} ●DVD-RW (Ver.1.1/1.2 1.4 GB, 2.8 GB, 4.7 GB, 9.4 GB) ^{*4} ●+R (4.7 GB) ^{*4} ●+RW ^{*11} (4.7 GB ^{*4}) ●CD-R ●CD-RW
Display Method		14.1 SXGA+ type (TFT) (1400 × 1050 dots)
Internal LCD		65,536/16,777,216 colors (1400 × 1050 dots) ^{*12}
External Display ^{*13}		65,536/16,777,216 colors (800 × 600 dots/1024 × 768 dots/1280 × 768 dots/1280 × 1024 dots/1400 × 1050 dots/1440 × 900 dots/1600 × 1200 dots/2048 × 1536 dots (60 Hz) ^{*14})
Simultaneous Display on LCD + External Display ^{*13}		65,536/16,777,216 colors (800 × 600 dots/1024 × 768 dots/1280 × 768 dots/1280 × 1024 dots/1400 × 1050 dots) ^{*12}
Wireless LAN		Intel® Wireless WiFi Link 4965AGN ^{*15} (→ page 37)
Bluetooth ^{*16}		→ page 37
LAN ^{*17}		IEEE 802.3 10Base-T, IEEE 802.3u 100Base-TX, IEEE 802.3ab 1000Base-T
Modem		Data: 56 kbps (V.92) FAX: 14.4 kbps
Sound		WAVE and MIDI playback, Intel® High Definition Audio subsystem support, Stereo Speakers (built in)
Security Chip		TPM (TCG V1.2 compliant) ^{*18}
Card Slots	PC Card Slot	× 1, Type I or Type II, Allowable current 3.3 V: 400 mA, 5 V: 400 mA
	SD Memory Card Slot ^{*19}	× 1
RAM Module Slot		× 1, DDR2 SDRAM 172-pin, 1.8 V, Micro DIMM, PC2-4200 Compliant ^{*20}
Interface		USB Ports × 2 (USB2.0 × 2) ^{*21} / Modem Port (RJ-11) / LAN Port (RJ-45) ^{*17} / External Display Port: Mini Dsub 15-pin female / Microphone Jack ^{*22} : Miniature jack, 3.5 DIA / Headphone Jack: Miniature jack, 3.5 DIA / Mini Port Replicator connector: Dedicated 50-pin male
Keyboard/Pointing Device		87 keys/Touch Pad
Power Supply		AC adaptor or Battery pack
AC Adaptor ^{*23}		Input: 100 V - 240 V AC, 50 Hz/60 Hz Output: 16 V DC, 3.75 A

Battery Pack			Li-ion 10.65 V, 5.7 Ah
Operating Time ^{*24}			Approx. 5 hours (Economy Mode (ECO) - Disable)
Charging Time ^{*25}			Approx. 5 hours (Power off)/Approx. 6.5 hours (Power on)
Power Consumption ^{*26}			Approx. 35 W ^{*27} / Approx. 60 W (maximum when recharging in the ON state)
Physical Dimensions (W × H × D)			309.6 mm × 35.2 mm (at the front)/45.1 mm (at the rear) × 253.6 mm (excluding protrusion) {12.2 " × 1.4 " / 1.8 " × 10.0 "}
Weight ^{*28}			Approx. 1670 g {3.7 lb.}
Environment	Operation	Temperature	5°C to 35°C {41°F to 95°F}
		Humidity	30% to 80% RH (No condensation)
	Storage	Temperature	-20°C to 60°C {-4°F to 140°F}
		Humidity	30% to 90% RH (No condensation)
OS ^{*29}			Windows Vista [®] Business
Pre-installed Software ^{*29}			Microsoft [®] Internet Explorer 7.0 / DirectX 10 / Microsoft [®] Windows [®] Media Player 11 / Microsoft [®] Windows [®] Movie Maker 6.0 / Microsoft [®] .NET Framework 3.0 / Adobe Reader / Loupe Utility / Touch Pad Utility / DMI Viewer / PC Information Viewer / PC Information Popup / WinDVD™ 8 (OEM Version) / B's Recorder GOLD9 BASIC / B's CLiP 7 ^{*30} / Hotkey Settings / Optical Disc Drive Letter-Setting Utility / Optical Disc Drive Power-Saving Utility / Power Saving Utility / Fan Control Utility / LAN Power Saving Utility / Intel [®] Matrix Storage Manager / Wireless Switch Utility / Wireless Connection Disable Utility ^{*31} / Bluetooth Stack for Windows by TOSHIBA ^{*16} / Economy Mode (ECO) Setting Utility / Battery Recalibration Utility / Infineon TPM Professional Package V3.0 ^{*31}
			Setup Utility / Hard Disk Data Erase Utility ^{*32} / PC-Diagnostic Utility ^{*33}

■ Wireless LAN <Only for model with wireless LAN>

Data Transfer Rates	IEEE802.11a: 54/48/36/24/18/12/9/6 Mbps (automatically switched) ^{*34} IEEE802.11b: 11/5.5/2/1 Mbps (automatically switched) ^{*34} IEEE802.11g: 54/48/36/24/18/12/9/6 Mbps (automatically switched) ^{*34}
Standard Supported	IEEE802.11a/IEEE802.11b/IEEE802.11g
Transmission Method	OFDM system, DS-SS system
Wireless Channels Used	IEEE802.11a: Channels 36/40/44/48/52/56/60/64/149/153/157/161/165 IEEE802.11b/ IEEE802.11g: Channels 1 to 11
RF Frequency Band	IEEE802.11a: 5.18 - 5.32 GHz, 5.745 - 5.825 GHz IEEE802.11b/ IEEE802.11g: 2412 - 2462 MHz

■ Bluetooth™ <Only for model with Bluetooth>

Bluetooth Version	2.0 + EDR
Transmission Method	FHSS system
Wireless Channels Used	Channels 1 to 79
RF Frequency Band	2.402-2.48 GHz

^{*1} 1 MB = 1,048,576 bytes / 1 GB = 1,073,741,824 bytes

^{*2} You can physically expand the memory up to 2 GB, but the total amount of usable memory available will be less depending on the actual system configuration.

^{*3} A segment of the main memory is allotted automatically depending on the computer's operating status. The size of the Video Memory cannot be set by the user. The size of Video memory is allotted depending on the operating system.

^{*4} 1 GB = 1,000,000,000 bytes. Your operating system or some application software will report as fewer GB.

^{*5} Data transfer speeds indicate values measured by Matsushita Electric Industrial Co., Ltd. The data transfer rate of DVD per 1X speed is 1,350 KB/s. The data transfer rate of CD per 1X speed is 150 KB/s.



^{*6} Performance of CD-R, CD-RW, DVD-RAM, DVD-R, DVD-RW, +R, +R DL, and +RW cannot be guaranteed depending on writing status and recording format. Also, some data cannot be played back depending on the disc, settings, and environment being used.

Does not support writing to DVD-R DL/+R DL (dual layer discs) or reading from DVD-R DL.

^{*7} If an unbalanced disc (e.g., a disc with which the balance has been displaced from the center) is inserted, the speed may become slower if there are large vibrations while the disc is rotating.

^{*8} Only non-cartridge type or removable cartridge type can be used. When writing to DVD-RAM, use only discs up to 3X. This application cannot be used with 5X DVD-RAM media (2-5X discs, etc.).

Specifications

- *9 DVD-R is compatible with 4.7 GB (for General) playback. DVD-R (for Authoring) playback is compatible with discs recorded using Disc-at-Once recording.
- *10 Depending on the disc, the writing speed may become slower.
- *11 Does not support writing to High Speed +RW.
- *12 A 16,777,216 color display is achieved by using the dithering function.
- *13 Display may be impossible using some connected external displays.
- *14 When using an external display with a resolution of 2048 x 1536 dots, use a display that supports a 60 Hz refresh rate. If an external display that does not support a 60 Hz refresh rate is used, images may not be displayed properly.
- *15 Only for model with wireless LAN.
It does not correspond to IEEE802.11n.
- *16 Only for model with Bluetooth.
- *17 Some devices cannot be used depending on the port type.
- *18 For information on TPM, click  (Start) and input "c:\util\drivers\tpm\README.pdf" in [Start Search], and press **Enter**, and refer to the  *Installation Manual* of "Trusted Platform Module (TPM)".
- *19 This slot is compatible with High-Speed Mode. Operation has been tested and confirmed using Panasonic SD/SDHC Memory Cards with a capacity of up to 8 GB. Operation on other SD equipment is not guaranteed.
- *20 Only a RAM module designed for DDR2 (PC2-4200) can be added (Panasonic : CF-BAW0512AU, CF-BAW1024AU). JEDEC standard 214 pin Micro DIMM cannot be used. PC2100 / PC2700 / PC2-3200 172 pin Micro DIMM cannot be used.
- *21 Does not guarantee operation of all USB-compatible peripherals.
- *22 Use a condenser-stereo microphone.
- *23 <Only for North America>
The AC adaptor is compatible with power sources up to 240 V AC adaptor. This computer is supplied with a 125 V AC compatible AC cord. 20-M-2-1
- *24 Measured using MobileMark™ 2007 (LCD brightness : 60 cd/m²).
Varies depending on the usage conditions, or when an optional device is attached.
When Economy Mode (ECO) is enabled, the operating time becomes approximately 20% shorter than when it is disabled. 23-E-1
- *25 Varies depending on the usage conditions, CPU speed, etc. It may take a long time to charge a fully discharged battery.
- *26 Approx. 0.9 W when the battery pack is fully charged (or not being charged) and the computer is off.
- *27 Rated power consumption.
- *28 Average value. May differ depending on models.
- *29 Operations of this computer are not guaranteed except for the pre-installed OS.
- *30 Must be installed before use.
- ① Click  (Start) and input "c:\util\bha\clip\english", and press **Enter**.
 - ② Right-click [setup] in [english] folder and click [Run as administrator].
If there are two or more "setup" files, right-click the file whose [Type] is [Application].
B's CLiP stored in the computer does not support CD-R, DVD-R and +R.
- *31 Must be installed before use.
- *32 The Product Recovery DVD-ROM is required.
- *33 For startup methods, refer to "Hardware Diagnostics" (➔ page 32).
- *34 These are speeds specified in IEEE802.11a+b+g standards. Actual speeds may differ.

LIMITED WARRANTY

For U.S.A.

Panasonic Computer Solutions Company - Worldwide Product Warranties

Section 1 - Limited Warranty - Hardware

Panasonic Computer Solutions Company (referred to as "Panasonic") will repair the products listed below with new or rebuilt parts, free of charge in the U.S.A. or other Panasonic approved location for the period specified below from the date of original purchase in the event of a defect in materials or workmanship. These warranties are extended solely to the original purchaser. A purchase receipt or other proof of date of original purchase will be required before warranty performance is rendered.

- Laptop Computers – 3 Years
- PDRC - LCD and Keyboard Assemblies – 3 Years
- MDWD – Mobile Computer and Wireless Display Assemblies (CF-07/CF-08) - 3 Years
- Hand-held Computers (P1/P2) – 1 Year
- Arbitrator Video Camera – 1 Year
- Arbitrator Recorder Unit – 1 Year
- Arbitrator Remote Control Panel – 1 Year
- Arbitrator Wireless Receiver Unit – 1 Year
- Arbitrator P2 Card(s) (All Sizes) – 1 Year
- Arbitrator Wireless Microphone(s) / Transmitter – 90 Days
- Arbitrator System Component Interconnect Cables – 90 days

Main Battery

The battery supplied with the product is covered under the warranty for one (1) year from date of purchase, except as excluded in Section 3. Batteries purchased separately are covered under the warranty for one (1) year from the date of purchase. A battery furnished under the warranty is covered for the remaining period of the one year warranty on the original or purchased battery.

Options and Accessories

The below listed Panasonic brand or supplied options and accessories are covered under this limited warranty for the period specified from the date of purchase or as specifically stated:

- AC Adaptor / Power Cord – 3 Years
- Memory Card (Panasonic Brand) – 3 Years
- Car Mount Docking Station PCB or Complete Vehicle Docking Station – 3 Years
- Port Replicator / I-O Box / Device Cradle (like CF-08) – 3 Years
- Antenna Pass-through Cable – 3 Years
- Backlit or Full-sized keyboard - 3 Years or assumes warranty of the unit in which it is installed
- Integrated Panasonic supplied options and kits including, but not limited to Wireless WAN, Media Bay Drives (Floppy, CD/DVD), GPS, Bluetooth, Smartcard Reader, and Fingerprint readers – 3 Years or assumes warranty period of the unit in which it is installed provided the integration was performed by Panasonic or an Authorized Options Integrator.
- Hard Drive (separately purchased) – 1 Year
- External USB Drives (CD / DVD / Floppy / Hard Drive) – 1 Year
- Optional Battery – 1 Year
- Battery Charger – 1 Year
- Standard or Digitizer Stylus Pens – 90 Days (physical damage excluded)

Section 2 - Limited Warranty - Software

Panasonic Computer Solutions Company (referred to as "Panasonic") warrants to you only that the disk(s) or other media on which the Programs are furnished will be free from defects in material and workmanship under normal use for a period of sixty (60) days from the date of delivery thereof to you, as evidenced by your purchase receipt.

This is the only warranty Panasonic makes to you. Panasonic does not warrant that the functions contained in the Programs will meet your requirements or that the operation of the Programs will be uninterrupted or error free. Panasonic shall have no obligation for any defects in the disk(s) or other media on which the Programs are furnished resulting from your storage thereof, or for defects that have been caused by operation of the disk(s) or other media.

Panasonic's entire liability and your exclusive remedy under this warranty shall be limited to the replacement, in the United States or other Panasonic designated location, of any defective disk or other media which is returned to Panasonic's Authorized Service Center, together with a copy of the purchase receipt, within the aforesaid warranty period. The customer is responsible for ensuring that all data is backed up and made secure during normal use and before sending a unit for service.

LIMITED WARRANTY

Section 3 - Limited Warranty Exclusions

Specifically excluded from the warranty are:

- All consumable items; such as screen protection films, logo badges, labels, cleaning cloths, carry cases, manuals, cables, straps, belts, holsters, tethers, and harnesses and any other options and accessories not listed above or covered under a separate warranty.
- Failures related to the product operating system, hard drive image, software setup, software program, virus, other program(s) or file(s) on the hard drive or in any computer memory location.
- Failures due to BIOS settings or changes, as well as any cosmetic or physical damage to the unit.
- Any unit or device with a missing or altered model number or serial number label
- Damage which occurs in shipment
- Failures which are caused by products not supplied by Panasonic
- Failures which result from alteration, accident, misuse, introduction of liquid or other foreign matter into the unit, abuse, neglect, installation, maladjustment of consumer controls, improper maintenance or modification, use not in accordance with product use instructions
- Failures due to service by anyone other than a Panasonic Authorized Service Provider
- Failures caused by improper integration by any company other than Panasonic Configuration and Integration Centers.
- Damage, failure, or loss due to the unit being stolen, lost, misplaced, or used by anyone other than the original purchaser
- Damage that is attributable to acts of God

This warranty only covers failures due to defects in materials or workmanship which occur during normal use.

THIS PRODUCT IS NOT INTENDED FOR USE AS, OR AS PART OF, NUCLEAR EQUIPMENT/SYSTEMS, AIR TRAFFIC CONTROL EQUIPMENT/SYSTEMS, OR AIRCRAFT COCKPIT EQUIPMENT/SYSTEMS^{*1}. PANASONIC WILL NOT BE RESPONSIBLE FOR ANY LIABILITY RESULTING FROM THE USE OF THIS PRODUCT ARISING OUT OF THE FOREGOING USES.

^{*1} AIRCRAFT COCKPIT EQUIPMENT/SYSTEMS include Class2 Electrical Flight Bag (EFB) Systems and Class1 EFB Systems when used during critical phases of flight (e.g., during take-off and landing) and/or mounted on to the aircraft. Class1 EFB Systems and 2 EFB Systems are defined by FAA: AC (Advisory Circular) 120-76A or JAA: JAA TGL (Temporary Guidance Leaflets) No.36

Other Limits and Exclusions: There are no other express warranties except as listed above.

PANASONIC SHALL NOT BE LIABLE FOR LOSS OF DATA OR OTHER INCIDENTAL OR CONSEQUENTIAL DAMAGES RESULTING FROM THE USE OF THIS PRODUCT, OR ARISING OUT OF ANY BREACH OF THIS WARRANTY. ALL EXPRESS AND IMPLIED WARRANTIES, INCLUDING THE WARRANTIES OF MERCHANTABILITY AND FITNESS FOR A PARTICULAR PURPOSE ARE LIMITED TO THE APPLICABLE WARRANTY PERIOD SET FORTH ABOVE. Some states do not allow the exclusion or limitation of incidental or consequential damages, or limitations on how long an implied warranty lasts, so the above limitations or exclusions may not apply to you.

This limited warranty gives you specific legal rights, and you may also have other rights which vary from state to state.

For technical support or to arrange for service on your Panasonic computer product, call our toll-free 24 hour hotline at 1-800-LAPTOP5.

DIAL TOLL FREE: 1-800-LAPTOP5 (1-800-527-8675) Web Site : www.panasonic.com/toughbook

For Canada

PANASONIC COMPUTER AND PERIPHERALS LIMITED WARRANTY

Coverage – Panasonic Canada Inc. (“PCI”) warrants to you, the first end user customer, this computer product (excluding software media), when purchased from PCI or from a PCI authorized reseller, to be free from defects in materials and workmanship under normal use, subject to the terms set forth below, during the period of warranty coverage specified.

Scope of Coverage	Period of Coverage	Type of Failure Coverage
<ul style="list-style-type: none"> Laptop Computers (except Battery) and AC Adaptor Factory/PCI installed options including Wireless WAN, GPS, Bluetooth, Fingerprint reader, Backlit keyboard, Memory Card and Media Bay Drives (Floppy, CD/DVD) Mobile Wireless Display PDRC – LCD and Keyboard Assemblies Port Replicator 	Three (3) Years from Date of Original End User Customer Purchase	Defective Materials or Workmanship
<ul style="list-style-type: none"> Hand-held Computers Battery Battery charger Auto Adaptor External USB Drives 	One (1) Year from Date of Original End User Customer Purchase	Defective Materials or Workmanship
<ul style="list-style-type: none"> Standard or Digitizer Stylus Pen 	Ninety (90) Days from Date of Original End User Customer Purchase	Defective Materials or Workmanship
<ul style="list-style-type: none"> All consumable items including protection film, cleaning cloth, carry case, tether and harness 	No Coverage	

Remedy – In the event of a warranty claim, contact PCI’s representatives within the applicable warranty period, identifying the nature of the defect claimed, at 1-800-668-8386 between 9:00 A.M. and 5:00 P.M., Eastern Time Zone, Mon. – Fri. (excluding holidays) for instructions on how to obtain service. A purchase receipt or other proof of date of original purchase is required before warranty service is performed. Defective parts covered by this Limited Warranty will be repaired or replaced with new or comparable rebuilt parts on an exchange basis. Warranty replacement or repair is subject to the terms of this Limited Warranty for the balance of the original period of warranty coverage.

No Coverage – This Limited Warranty does not cover products purchased outside Canada. Neither does it cover damage to, failure of, or defects in a product or accessory through mishandling, improper installation, abnormal use, misuse, neglect, accident, introduction of liquid or other foreign matter into the product, alteration or servicing by anyone not authorized by PCI, or act of God. THIS PRODUCT IS NOT INTENDED FOR USE AS, OR AS PART OF, NUCLEAR EQUIPMENT/SYSTEMS, AIR TRAFFIC CONTROL EQUIPMENT/SYSTEMS, OR AIRCRAFT COCKPIT EQUIPMENT/SYSTEMS². PANASONIC WILL NOT BE RESPONSIBLE FOR ANY LIABILITY RESULTING FROM THE USE OF THIS PRODUCT ARISING OUT OF THE FOREGOING USES.

² AIRCRAFT COCKPIT EQUIPMENT/SYSTEMS include Class2 Electrical Flight Bag (EFB) Systems and Class1 EFB Systems when used during critical phases of flight (e.g., during take-off and landing) and/or mounted on to the aircraft. Class1 EFB Systems and 2 EFB Systems are defined by FAA: AC (Advisory Circular) 120-76A or JAA: JAA TGL (Temporary Guidance Leaflets) No.36

IF YOU SHIP THE PRODUCT FOR WARRANTY SERVICE

Carefully pack the product, preferably in the original carton. Include details of defect claimed and proof of date of original purchase. No liability is assumed for loss or damage to the product while in transit, if you chose your own transportation carrier.

SOFTWARE MEDIA LIMITED WARRANTY

Coverage – PCI warrants to you, the first end user customer, that the disk(s) or other media on which software program(s) is/are supplied will be free from defects in materials and workmanship under normal use in Canada for a period of sixty (60) days from date of receipt as evidenced by your purchase receipt for your Panasonic Computer product.

THIS IS THE ONLY WARRANTY THAT PCI MAKES RESPECTING THE SOFTWARE MEDIA. PCI does not warrant the software. Please refer to the software licensor’s written warranty (accompanying the copy of the software) for any software warranty claim.

Claim Procedure – In the event of a defect in material or workmanship in the media during the sixty (60) day warranty period, and you return it, transportation costs prepaid, to Panasonic Canada Inc., Computer Products Marketing, 5770 Ambler Drive, Mississauga, Ontario L4W 2T3, within the warranty period, together with a copy of your purchase receipt, and an explanation of the suspected defect, PCI will replace in Canada the defective disk(s) or other media.

Remedy – PCI’s entire liability, and your only remedy for any breach of this software media warranty is limited to replacement of the media only. It does not cover any other damages, including, but not limited to, loss of use or profit loss, or special, indirect or consequential damages, or other claims, whether or not of similar character.

No Coverage – This limited warranty does not apply if the disk(s) or other media has been used in other than a Panasonic product, or in environmental conditions other than those specified by PCI or the manufacturer, or if subjected to misuse, neglect, mishandling, modification or attempted modification of the program, or if damaged by accident or act of God. PCI is not responsible for damage to or loss of any program, data or removable storage media.

GENERAL

NO OTHER WARRANTIES – PCI DISCLAIMS ALL OTHER WARRANTIES, EITHER EXPRESS OR IMPLIED, INCLUDING, BUT NOT LIMITED TO, IMPLIED WARRANTIES OF MERCHANTABILITY AND FITNESS FOR A PARTICULAR PURPOSE, WITH RESPECT TO THE SOFTWARE, SOFTWARE MEDIA, COMPUTER PRODUCT, OPTIONS AND ACCESSORIES.

NO LIABILITY FOR CONSEQUENTIAL DAMAGES – IN NO EVENT SHALL PCI BE LIABLE FOR ANY SPECIAL, INDIRECT OR CONSEQUENTIAL DAMAGES ARISING FROM ANY BREACH OF THE LIMITED WARRANTIES SET OUT IN THIS DOCUMENT, OR FROM THE USE OF THE COMPUTER PRODUCT, INCLUDING, WITHOUT LIMITATION, LOSS OF DATA, BUSINESS, PROFIT OR GOODWILL.

IN ANY EVENT, PCI’S MAXIMUM LIABILITY FOR ANY BREACH SHALL NOT EXCEED THE AMOUNT ACTUALLY PAID BY YOU FOR THE COMPUTER PRODUCT.

NO ACTION, REGARDLESS OF ITS BASIS, MAY BE BEGUN AGAINST PCI MORE THAN TWO (2) YEARS AFTER THE CAUSE OF ACTION AROSE.

Statutory Warranties – Some jurisdictions do not allow these limitations or exclusions, so they may not apply to you.

GARANTIE LIMITÉE

Pour le Canada

GARANTIE LIMITÉE – ORDINATEURS ET PÉRIPHÉRIQUES PANASONIC

Couverture – Panasonic Canada Inc. (« PCI ») garantit à l'acheteur original que ce produit informatique (à l'exclusion des supports des logiciels) est, au moment de sa vente par PCI ou d'un revendeur agréé par PCI, exempt de défauts de pièces et de fabrication dans les conditions normales d'utilisation, et ce, pendant la période de couverture de la garantie, sous réserve des modalités décrites ci-dessous.

Éléments couverts	Durée de couverture	Type de couverture
<ul style="list-style-type: none">• Ordinateurs blocs-notes (sauf batteries) et adaptateur secteur• Options installées en usine/par PCI incluant : WAN sans fil, GPS, Bluetooth, lecteur d'empreintes digitales, clavier rétroéclairé, carte mémoire et lecteurs (disquettes, CD/DVD)• Écran mobile sans fil• Ensembles PDRC – ACL et clavier• Duplicateur de port	Trois (3) ans à partir de la date d'achat original.	Défauts de pièces et de fabrication
<ul style="list-style-type: none">• Ordinateurs de poche• Batterie• Chargeur de batterie• Adaptateur pour voiture• Périphériques USB	Un (1) an à partir de la date d'achat original.	Défauts de pièces et de fabrication
<ul style="list-style-type: none">• Stylo pointeur standard ou pour numériseur graphique	Quatre-vingt-dix (90) jours à partir de la date d'achat original.	Défauts de pièces et de fabrication
<ul style="list-style-type: none">• Tous les articles consommables incluant les pellicules protectrices, chiffons de nettoyage, étuis de transport, longes et sangles	Aucune couverture	

Recours – Pour obtenir des informations sur la marche à suivre dans le cas où une réclamation en vertu de la garantie deviendrait nécessaire, communiquez par téléphone avec un représentant de PCI au 1-800-668-8386, entre 9h00 et 17h00 (heure de l'Est) du lundi au vendredi (sauf les jours fériés), avant l'échéance de la garantie applicable, en prenant soin d'identifier la nature de la défaillance. Un reçu ou toute autre pièce justificative de la date d'achat original sera exigé avant toute réparation. Toute pièce défectueuse couverte par la présente garantie limitée sera réparée ou remplacée par une pièce neuve ou remise à neuf. Le remplacement ou la réparation sera fait conformément aux modalités de la présente garantie limitée pendant la durée restante de la période originale de la garantie.

Produits non couverts – La présente garantie limitée ne couvre pas les produits achetés à l'extérieur du Canada. Elle ne couvre pas non plus les dommages, la défaillance ou les défauts attribuables à une manutention inadéquate, une mauvaise installation, une utilisation anormale ou abusive, de la négligence, un accident, un déversement ou la pénétration d'un objet étranger, une modification, un cas fortuit ou une réparation effectuée par une personne non agréée par PCI.

CE PRODUIT N'EST PAS DESTINÉ À ÊTRE UTILISÉ, EN TOUT OU EN PARTIE, COMME SYSTÈME/ÉQUIPEMENT NUCLÉAIRE, SYSTÈME/ÉQUIPEMENT DE CONTRÔLE DU TRAFFIC AÉRIEN OU SYSTÈME/ÉQUIPEMENT DE POSTE DE PILOTAGE D'AVION*³. PANASONIC DÉCLINE TOUTE RESPONSABILITÉ CONCERNANT L'UTILISATION DE CE PRODUIT DANS LES CAS SUSMENTIONNÉS.

*³ Les SYSTÈMES/ÉQUIPEMENTS DE POSTE DE PILOTAGE D'AVION sont dotés de systèmes OEPP (organiseur électronique de poste de pilotage) de classe 2 et de classe 1 utilisés pendant des phases critiques de vol (par exemple, pendant le décollage et l'atterrissage) et (ou) montés sur l'avion. Les systèmes OEPP de classe 1 et de classe 2 sont définis par le circulaire d'information FAA : AC (Advisory Circular) 120-76 A ou le feuillet n°36 JAA :JAA TGL (Temporary Guidance Leaflets) No 36.

EXPÉDITION DU PRODUIT POUR SERVICE SOUS GARANTIE

Emballer soigneusement le produit, de préférence dans son emballage d'origine. Joignez une description de la défaillance de même qu'une pièce justificative de la date d'achat. Panasonic Canada Inc. ne peut être tenue responsable pour tout dommage ou perte subi pendant le transport si vous avez choisi le transporteur.

GARANTIE LIMITÉE – SUPPORTS DES LOGICIELS

Couverture – Panasonic Canada Inc. (« PCI ») garantit à l'acheteur original que la ou les disquettes ou tout autre support sur lequel le ou les programmes sont fournis sont exempts de défauts de pièces et de fabrication dans des conditions normales d'utilisation au Canada, et ce, pour une période de soixante (60) jours suivant la date de réception indiquée sur la preuve d'achat.

LA PRÉSENTE GARANTIE EST LA SEULE OFFERTE PAR PCI COUVRANT LES SUPPORTS DE LOGICIELS. PCI ne garantit pas les logiciels. Reportez-vous à la garantie écrite du concédant de licence d'utilisation du logiciel (qui accompagne la copie du logiciel) pour toute réclamation en vertu de la garantie.

Réclamation – marche à suivre – Panasonic Canada Inc. remplacera toute disquette ou support défectueux si l'article en question est retourné, port payé, à son service de Marketing – produits informatiques, 5770 Ambler Drive, Mississauga (Ontario) L4W 2T3, dans les soixante (60) jours suivant la date d'achat original. Joignez à votre envoi une pièce justificative de votre achat et une description du problème.

Recours – La responsabilité de PCI - et votre seul recours - dans le cas de toute défaillance couverte par la garantie sur ce support de logiciel est limitée au seul remplacement du support. Elle ne couvre aucun autre dommage, y compris, mais non exclusivement, la perte d'usage ou de profits, ni aucun dommage spécial, indirect ou consécutif, ni aucune autre réclamation de nature similaire ou autre.

Produits non couverts – La présente garantie limitée ne s'applique pas si la ou les disquettes ou autre support ont été utilisés dans un produit d'une marque autre que Panasonic ou dans des conditions environnementales autres que celles spécifiées par PCI ou le fabricant, ou soumis à une mauvaise utilisation, à la négligence, à une manutention inadéquate ou encore si le programme a été modifié ou subi une tentative de modification ou des dommages attribuables à un accident ou à un cas fortuit. De plus, PCI n'assume aucune responsabilité pour toute perte de, ou tout dommage à, un programme, des données ou un support de sauvegarde amovible.

GÉNÉRALITÉS

PCI NE RECONNAÎT AUCUNE AUTRE GARANTIE, EXPLICITE OU IMPLICITE, Y COMPRIS, MAIS NON EXCLUSIVEMENT, LES GARANTIES IMPLICITES DE VALEUR COMMERCIALE ET D'UTILITÉ À UNE FIN QUELCONQUE, À L'ÉGARD DU LOGICIEL, SUPPORTS DE LOGICIELS, PRODUITS INFORMATIQUES, PÉRIPHÉRIQUES ET ACCESSOIRES.

SOUS AUCUNE CIRCONSTANCE PCI NE POURRA ÊTRE TENUE RESPONSABLE DES DOMMAGES SPÉCIAUX, INDIRECTS OU CONSÉCUTIFS ATTRIBUABLES À UN MANQUEMENT AUX GARANTIES LIMITÉES DÉCRITES DANS LE PRÉSENT DOCUMENT OU À L'UTILISATION DU PRODUIT INFORMATIQUE, Y COMPRIS, SANS RESTRICTION, LA Perte DE DONNÉES, D'AFFAIRES, D'ACHALANDAGE OU DE PROFIT. DANS TOUS LES CAS, LA RESPONSABILITÉ MAXIMALE DE PCI POUR TOUT MANQUEMENT NE POURRA EXCÉDER LE PRIX DE VENTE DU PRODUIT INFORMATIQUE.

AUCUNE RÉCLAMATION, SANS ÉGARD À SES MOTIFS, NE POURRA ÊTRE FAITE AUPRÈS DE PCI PLUS DE DEUX (2) ANS APRÈS LES FAITS INVOQUÉS À LA BASE D'UNE TELLE RÉCLAMATION.

Garantie statutaires – Certaines juridictions interdisent de telles limitations ou exclusions; aussi, pourraient-elles ne pas s'appliquer.



As an ENERGY STAR[®] Partner, Matsushita Electric Industrial Co., Ltd. has determined that this product meets the ENERGY STAR[®] guidelines for energy efficiency.

Outline of the International ENERGY STAR[®] Office Equipment Program

The international ENERGY STAR[®] Office Equipment Program is an international program that promotes energy saving through the use of computers and other office equipment. The program backs the development and dissemination of products with functions that effectively reduce energy consumption. It is an open system in which business proprietors can participate voluntarily. The targeted products are office equipment such as computers, displays, printers, facsimiles, and copiers. Their standards and logos are uniform among participating nations.

For information about ENERGY STAR[®], refer to the following web site:

Web site: www.energystar.gov

22-M-1

Panasonic Computer Solutions Company
3 Panasonic Way, Panazip 2F-5,
Secaucus, NJ 07094

Panasonic Canada Inc.
5770 Ambler Drive Mississauga,
Ontario L4W 2T3

