

FC-200V

FC-100V

User's Guide

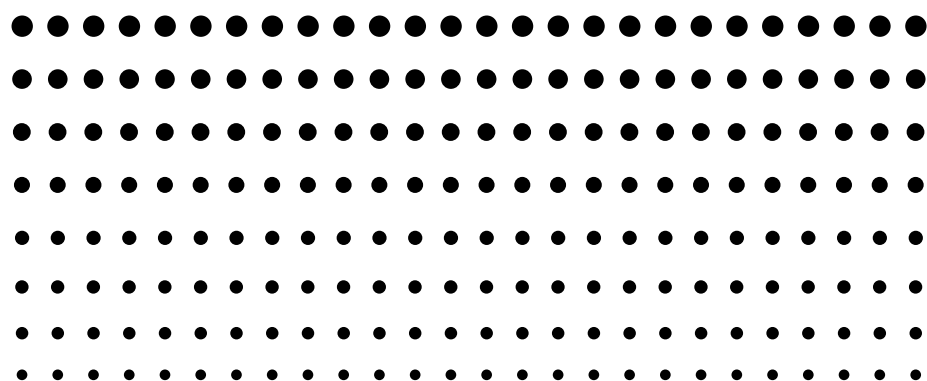

CASIO Worldwide Education Website

<http://edu.casio.com>

CASIO EDUCATIONAL FORUM

<http://edu.casio.com/forum/>

Important!

CASIO COMPUTER CO., LTD. makes no guarantees concerning accuracy of the contents of this manual or their suitability for any commercial purpose or other particular purpose, or concerning the accuracy of calculation results (such as financial calculation simulation results) produced by this calculator.

- Financial calculation rules and practices can differ according to country, geographic area, or financial institution. It is up to you to determine whether the calculation results produced by this calculator are compatible with the financial calculation rules that apply to you.



Manufacturer:

CASIO COMPUTER CO., LTD.

6-2, Hon-machi 1-chome

Shibuya-ku, Tokyo 151-8543, Japan

Responsible within the European Union:

CASIO EUROPE GmbH

Casio-Platz 1

22848 Norderstedt, Germany



**Batterij niet weggooien,
maar inleveren als**

KCA

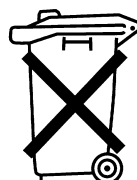

About this Manual

- This User’s Guide covers use and operation of the CASIO FC-200V and FC-100V. Operations apply to both models, except in cases indicated by the text “FC-200V only”.
- Keycap markings indicate what a key inputs or what function it performs.

Example: $\boxed{1}$, $\boxed{2}$, $\boxed{+}$, $\boxed{-}$, \boxed{AC} , etc.

- Pressing the $\overset{\text{SHIFT}}{\boxed{}}$ or $\overset{\text{ALPHA}}{\boxed{}}$ key followed by a second key performs the alternate function of the second key. The alternate function is indicated by the text printed above the key.

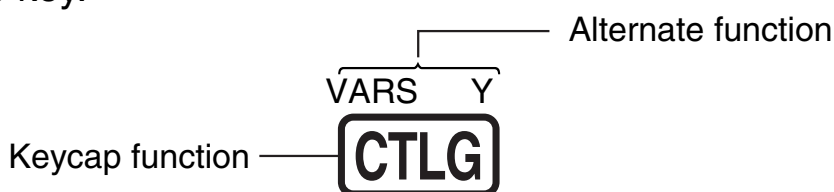

- The following shows what the different colors of the alternate function key text mean.

If key marking text is this color:	It means this:
Yellow	Press $\overset{\text{SHIFT}}{\boxed{}}$ and then the key to access the applicable function.
Red	Press $\overset{\text{ALPHA}}{\boxed{}}$ and then the key to input the applicable variable or constant.

- In this manual, a $\overset{\text{SHIFT}}{\boxed{}}$ key operation is shown as $\boxed{\text{SHIFT}}$, while an $\overset{\text{ALPHA}}{\boxed{}}$ key operation is shown as $\boxed{\text{ALPHA}}$.
- The following shows an example of how an alternate function operation is represented in this User’s Guide.

Example: $\boxed{\text{SHIFT}}$ $\boxed{\text{STAT}}$ (S-MENU)

|

Indicates the function that is accessed by the key operation ($\boxed{\text{SHIFT}}$ $\boxed{\text{STAT}}$) before it. Note that this is not part of the actual key operation you perform.

- The following shows an example of how a key operation to select an on-screen menu item is represented in this User's Guide.

Example: $\boxed{1}$ (1-VAR)

└───┘
┆
Indicates the menu item that is selected by the number key operation ($\boxed{1}$) before it. Note that this is not part of the actual key operation you perform.

- The cursor key is marked with four arrows, indicating direction, as shown in the illustration nearby. In this User's Guide, cursor key operation is indicated as \triangleup , \triangledown , \triangleleft , and \triangleright .

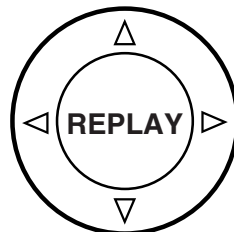

Some examples in this manual start out assuming that the calculator is set to a particular angle unit. This is indicated by the following marks.

$\boxed{\text{Deg}}$: Degrees

$\boxed{\text{Rad}}$: Radians

- The displays and illustrations (such as key markings) shown in this User's Guide are for illustrative purposes only, and may differ somewhat from the actual items they represent.
- The contents of this manual are subject to change without notice.
- In no event shall CASIO Computer Co., Ltd. be liable to anyone for special, collateral, incidental, or consequential damages in connection with or arising out of the purchase or use of this product and items that come with it. Moreover, CASIO Computer Co., Ltd. shall not be liable for any claim of any kind whatsoever by any other party arising out of the use of this product and the items that come with it.

Initializing the Calculator

Perform the following procedure when you want to initialize the calculator and return the calculation mode and setup to their initial default settings. Note that this operation also clears all data currently in calculator memory.

1. **ON** **SHIFT** **9** (CLR)
2. “All:EXE” (**▼** **▲**), then **EXE**.
3. **EXE** (Yes)
4. **AC**

- To cancel initialization without doing anything, press **ESC** (Cancel) instead of **EXE** (Yes).

This setting:
Calculation Mode

Is initialized to this:
COMP

This setting:

Is initialized to this:

Payment
Date Mode
dn
Periods/Y
Bond Date
Date Input
PRF/Ratio
B-Even
Digit Sep.
Angle
Display Digits
STAT

End
365
CI
Annual (FC-200V only)
Date (FC-200V only)
MDY
PRF (FC-200V only)
Quantity (FC-200V only)
Off
Deg
Norm1
Off

- For information about memory, see “Using Calculator Memory” on page E-35.
- For information about shortcut keys settings, see “Shortcuts” on page E-94.

Safety Precautions

Be sure to read the following safety precautions before using this calculator. Keep this manual handy for later reference.



Caution

This symbol is used to indicate information that can result in personal injury or material damage if ignored.

Battery

- After removing the battery from the calculator, put it in a safe place where it will not get into the hands of small children and accidentally swallowed.
- Keep batteries out of the reach of small children. If accidentally swallowed, consult with a physician immediately.
- Never charge the battery, try to take the battery apart, or allow the battery to become shorted. Never expose the battery to direct heat or dispose of it by incineration.
- Improperly using a battery can cause it to leak and damage nearby items, and can create the risk of fire and personal injury.
 - Always make sure that the battery's positive \oplus and negative \ominus ends are facing correctly when you load it into the calculator.
 - Remove the battery if you do not plan to use the calculator for a long time.
 - Use only the type of battery specified for this calculator in this manual.

Disposing of the Calculator

- Never dispose of the calculator by burning it. Doing so can cause certain components to suddenly burst, creating the risk of fire and personal injury.

Handling Precautions

- **Be sure to press the  key before using the calculator for the first time.**
- **Even if the calculator is operating normally, replace the battery at least once every three years (FC-200V) or two years (FC-100V).**

A dead battery can leak, causing damage to and malfunction of the calculator. Never leave a dead battery in the calculator.
- **The battery that comes with this unit discharges slightly during shipment and storage. Because of this, it may require replacement sooner than the normal expected battery life.**
- **Low battery power can cause memory contents to become corrupted or lost completely. Always keep written records of all important data.**
- **Avoid use and storage of the calculator in areas subjected to temperature extremes.**

Very low temperatures can cause slow display response, total failure of the display, and shortening of battery life. Also avoid leaving the calculator in direct sunlight, near a window, near a heater or anywhere else it might be exposed to very high temperatures. Heat can cause discoloration or deformation of the calculator's case, and damage to internal circuitry.
- **Avoid use and storage of the calculator in areas subjected to large amounts of humidity and dust.**

Take care never to leave the calculator where it might be splashed by water or exposed to large amounts of humidity or dust. Such conditions can damage internal circuitry.
- **Never drop the calculator or otherwise subject it to strong impact.**
- **Never twist or bend the calculator.**

Avoid carrying the calculator in the pocket of your trousers or other tight-fitting clothing where it might be subjected to twisting or bending.
- **Never try to take the calculator apart.**

- **Never press the keys of the calculator with a ballpoint pen or other pointed object.**
- **Use a soft, dry cloth to clean the exterior of the calculator.**

If the calculator becomes very dirty, wipe it off with a cloth moistened in a weak solution of water and a mild neutral household detergent. Wring out all excess liquid before wiping the calculator. Never use thinner, benzene or other volatile agents to clean the calculator. Doing so can remove printed markings and can damage the case.

Contents

About this Manual	1
Initializing the Calculator	3
Safety Precautions	4
Handling Precautions	5
Before Using the Calculator	10
■ Removing the Hard Case	10
■ Turning Power On and Off	10
■ Adjusting Display Contrast	10
■ About the Display	11
■ Display Indicators	11
Calculation Modes and Calculator Setup	13
■ Calculation Modes	13
■ Using the Setup Screen	13
Inputting Expressions and Values	23
■ Inputting a Calculation Expression Using Standard Format	23
■ Correcting an Expression	25
■ Displaying the Location of an Error	27
Basic Calculations	28
■ Arithmetic Calculations	28
■ Percent Calculations	29
Using Multi-statements in Calculations	32
Using Calculation History Memory and Replay	33
Using Calculator Memory	35
■ Answer Memory (Ans)	35
■ Independent Memory (M)	37
■ Variables (A, B, C, D, X, Y)	38
■ Financial Calculation Variables (VARs)	40
■ Clearing Memory Contents	41

Financial Calculation	42
■ Simple Interest Mode	42
■ Compound Interest Mode	44
■ Cash Flow Mode	50
■ Amortization Mode	55
■ Conversion Mode	59
■ Cost/Sell/Margin Mode	61
■ Day Calculation Mode	64
■ Depreciation Mode (FC-200V only)	66
■ Bond Mode (FC-200V only)	71
■ Break-Even Mode (FC-200V only)	78
■ BEV Sub-mode (Break-Even Mode 1)	78
■ Margin of Safety Sub-mode (Break-Even Mode 2)	82
■ Degree of Operating Leverage Sub-mode (Break-Even Mode 3)	84
■ Degree of Financial Leverage Sub-mode (Break-Even Mode 4)	86
■ Degree of Combined Leverage Sub-mode (Break-Even Mode 5)	88
■ Quantity Conversion Sub-mode (Break-Even Mode 6)	90
Shortcuts	94
■ Custom Shortcut Keys	94
■ Function Shortcut Keys	96
Function Calculations	98
■ Pi (π) and Natural Logarithm Base e	98
■ Trigonometric and Inverse Trigonometric Functions	98
■ Hyperbolic and Inverse Hyperbolic Functions	99
■ Converting an Input Value to the Calculator's Default Angle Unit	99
■ Exponential Functions and Logarithmic Functions	100
■ Power Functions and Power Root Functions	101
■ Rectangular-Polar Coordinate Conversion	103
■ Other Functions	104

Statistical Calculation	108
■ Statistical Calculation Types	108
■ Inputting Sample Data	108
■ STAT Calculation Screen	111
■ Using the STAT Menu	112
Technical Information	134
■ Calculation Priority Sequence	134
■ Stack Limitations	136
■ Calculation Ranges, Number of Digits, and Precision	137
■ Special Financial Calculation Error Messages ..	139
■ Error Messages	140
■ Before assuming malfunction of the calculator...	142
Reference	143
■ Power Requirements and Battery Replacement	143
Specifications	146

Before Using the Calculator

■ Removing the Hard Case

Before using the calculator, slide its hard case downwards to remove it, and then affix the hard case to the back of the calculator as shown in the illustration below.

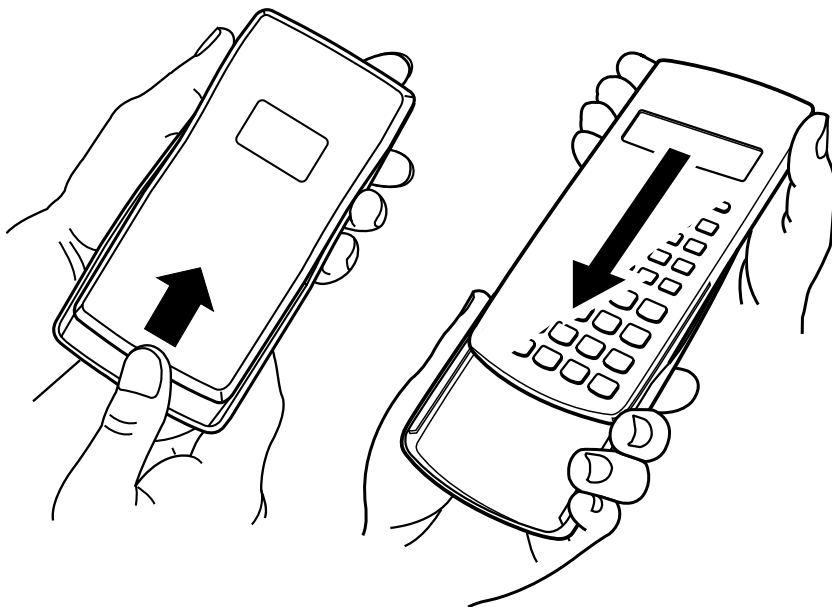

■ Turning Power On and Off

- Press **[ON]** to turn on the calculator.
- Press **[SHIFT]** **[AC]** (OFF) to turn off the calculator.

■ Adjusting Display Contrast

1. Press **[SETUP]**.
2. Use **[▼]** to select “CONTRAST:EXE”, and then press **[EXE]**.

This displays the contrast adjustment screen. Use **[◀]** and **[▶]** to adjust display contrast. After the setting is the way you want, press **[ESC]**.

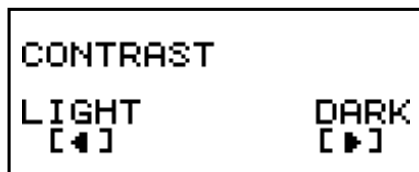

Important!

- If adjusting display contrast does not improve display readability, it probably means that battery power is low. Replace the battery.

■ About the Display

Your calculator has a 31-dot × 96-dot LCD screen.

Example:

Input expression — Pol(J(2),J(2))^D ▲

Calculation result — { r = 2
θ = 45

Financial Calculation Mode — Compound Int.^D ▼
Set Fnd
n = 0
I% = 0

■ Display Indicators

Sample Display:

STAT D

This indicator:	Means this:	Page:
S	The keypad has been shifted by pressing the SHIFT key. The keypad will unshift and this indicator will disappear when you press a key.	E-1
A	The alpha input mode has been entered by pressing the ALPHA key. The alpha input mode will be exited and this indicator will disappear when you press a key.	
M	There is a value stored in independent memory.	E-37
STO	The calculator is standing by for input of a variable name to assign a value to the variable. This indicator appears after you press SHIFT RCL (STO).	E-37 E-38 E-94
RCL	The calculator is standing by for input of a variable name to recall the variable's value. This indicator appears after you press RCL .	

This indicator:	Means this:	Page:
STAT	The calculator is in the STAT Mode.	E-108
360	360 days in a year.	E-15
SI	Simple interest for interest calculations of odd (partial) months.	
DMY	Day, month, year (DMY) as the date format.	
D	The default angle unit is degrees.	
R	The default angle unit is radians.	
G	The default angle unit is grads.	
FIX	A fixed number of decimal places is in effect.	
SCI	A fixed number of significant digits is in effect.	
▼▲	Calculation history memory data is available and can be replayed, or there is more data above/below the current screen.	E-33
Disp	The display currently shows an intermediate result of a multi-statement calculation.	E-32

Important!

- For a very complex calculation or some other type of calculation that takes a long time to execute, the display may show only the above indicators (without any value) while it performs the calculation internally.

Calculation Modes and Calculator Setup

■ Calculation Modes

When you want to perform this type of operation:	Press this key:	Page:
Simple interest calculations	SMPL	E-42
Compound interest calculations	CMPD	E-44
Cash flow calculations	CASH	E-50
Amortization calculations	AMRT	E-55
General and function calculations	COMP	E-28 E-98
Statistical and regression calculations	STAT	E-108
Interest rate conversion calculations	CNVR	E-59
Cost, selling price, or margin calculations	COST	E-61
Day or date calculations	DAYS	E-64
Depreciation calculations (FC-200V only)	DEPR	E-66
Purchase price and annual yield calculations (FC-200V only)	BOND	E-71
Break-even point calculations (FC-200V only)	BEVN	E-78

■ Using the Setup Screen

The setup screen lets you configure various conditions and screen settings used for calculations. You can also use the setup screen to adjust display contrast.

◆ Displaying the Setup Screen

There are two different ways to display the setup screen.

- Pressing the **SETUP** key
- Selecting the “Set:” item on the menu screen that appears when you enter some modes.

The following are the procedures you need to perform to access and use the setup screen using the above operations.

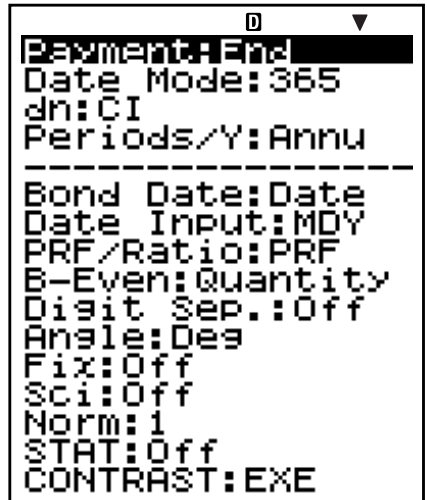

FC-200V

Important!

All of the example procedures presented in this manual use the **SETUP** key procedure to display the setup screen.

To display the setup screen with the **SETUP key**

1. Press the **SETUP** key.
This displays a menu of setup items.
 - See “Setup Screen Settings” on page E-15 for a complete list of menu items.
2. Use **▲** **▼** to select the setup item whose setting you want to change, and then press **EXE**.
This displays a screen for configuring the setting of the setup item you selected.
3. Configure the setting you want.
 - You can select a setting by with the cursor and then press **EXE** , or you can input the number that corresponds to the setting you want to select.
 - See “Configuring Settings” on page E-16 for information about configuring each setting.

To display the setup screen by selecting “Set:” on a mode menu

Important!

The following procedure is possible only when there is a “Set:” item on the menu that initially appears when you enter a mode. It is not available in all modes.

1. On the menu that appears when you initially enter a mode, use \blacktriangle \blacktriangledown to select “Set.”, and then press $\boxed{\text{EXE}}$.
 - This displays a setup screen of settings that apply to the current mode only. The content of the setup screen depends on what mode you are currently in.
2. Use \blacktriangle \blacktriangledown to select the setup item whose setting you want to change. You can also select a setup item by inputting the applicable number.
 - See “Setup Screen Settings” below for information about configuring each setting.

◆ Setup Screen Settings

No.	Setup Screen Item	Description	Page
①	Payment	Payment date (beginning of term/end of term)	E-16
②	Date Mode	Number of days in a year	E-16
③	dn	Odd period interest calculation	E-16
④	Periods/Y	Number of payment periods per year	E-17
⑤	Bond Date	Date or number of coupon payments specification	E-17
⑥	Date Input	Date format	E-18
⑦	PRF/Ratio	Profit or profit ratio specification	E-18
⑧	B-Even	Sales quantity or sales amount specification	E-18
⑨	Digit Sep.	3-digit separator symbol	E-19
⑩	Angle	Angle unit	E-19
⑪	Fix	Number of decimal places	E-20
⑫	Sci	Number of significant digits	E-20
⑬	Norm	Value range for exponential format	E-21
⑭	STAT	Statistical display	E-21
⑮	CONTRAST	Contrast adjustment	E-22



◆ Configuring Settings

① **Payment:** Compound Interest (CMPD) Mode, Amortization (AMRT) Mode





This setting specifies the payment date.

1:Begin Beginning of period

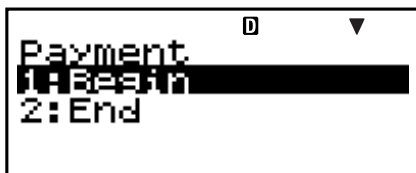
2:End End of period

1. Use   to select “Payment”, and then press .





2. Press  (1:Begin) or  (2:End) to select the setting you want.
 - You can also use   to select a setting and then press .

② **Date Mode:** Simple Interest (SMPL) Mode, Day Calculation (DAYS) Mode, Bond (BOND) Mode (FC-200V only)





This setting specifies the number of days in a year.

1:360 360 days

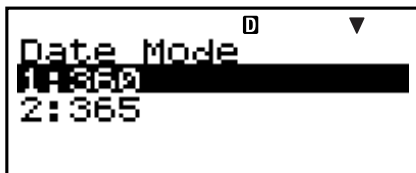
2:365 365 days

1. Use   to select “Date Mode”, and then press .



2. Press  (1:360) or  (2:365) to select the setting you want.
 - You can also use   to select a setting and then press .

③ **dn:** Compound Interest (CMPD) Mode

This setting specifies whether simple interest or compound interest for interest calculations of odd (partial) months.

1:CI Compound interest

2:SI Simple interest

1. Use   to select “dn”, and then press .

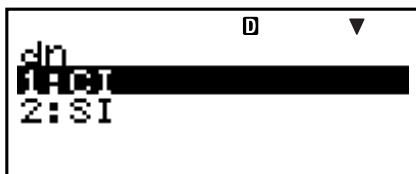

2. Press **[1]** (1:Cl) or **[2]** (2:Sl) to select the setting you want.
 - You can also use **▲** **▼** to select a setting and then press **[EXE]**.

④ Periods/Y: Bond (BOND) Mode (FC-200V only)

This setting specifies once a year (Annual) or twice a year (Semi-Annual) coupon payments.

- 1:Annual One coupon payment per year
- 2:Semi One coupon payment every six months

1. Use **▲** **▼** to select “Periods/Y”, and then press **[EXE]**.



2. Press **[1]** (1:Annual) or **[2]** (2:Semi) to select the setting you want.
 - You can also use **▲** **▼** to select a setting and then press **[EXE]**.

⑤ Bond Date: Bond (BOND) Mode (FC-200V only)

This setting specifies use of either a date (Date) or a number of payments (Term) as the term for bond calculations.

- 1:Date Date
- 2:Term Number of payments

1. Use **▲** **▼** to select “Bond Date”, and then press **[EXE]**.





2. Press **[1]** (1:Date) or **[2]** (2:Term) to select the setting you want.
 - You can also use **▲** **▼** to select a setting and then press **[EXE]**.



⑥ **Date Input:** Day Calculation (DAYS) Mode, Bond (BOND) Mode (FC-200V only)

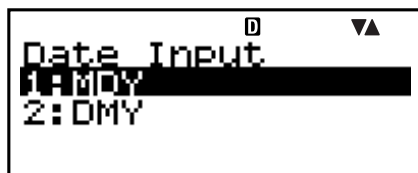

This setting specifies either month, day, year (MDY) or day, month, year (DMY) as the date format.

- 1:MDY Month, day, year 06012006 (June 1, 2006)
- 2:DMY Day, month, year 01062006 (June 1, 2006)

1. Use   to select “Date Input”, and then press .





2. Press  (1:MDY) or  (2:DMY) to select the setting you want.

- You can also use   to select a setting and then press .



⑦ **PRF/Ratio:** Break-Even Point Calculation (BEV) Sub-mode of Break-Even (BEVN) Mode (FC-200V only)



This setting specifies use of either profit (PRF) or profit ratio ($r\%$) for break-even point calculations.

- 1:PRF Profit
- 2: $r\%$ Profit ratio

1. Use   to select “PRF/Ratio”, and then press .



2. Press  (1:PRF) or  (2: $r\%$) to select the setting you want.

- You can also use   to select a setting and then press .

⑧ **B-Even:** Break-Even Point Calculation (BEV) Sub-mode of Break-Even (BEVN) Mode (FC-200V only)

This setting specifies use of either sales quantity (Quantity) or sales amount (Sales) for break-even point calculations.

- 1: Quantity Sales quantity
- 2: Sales Sales amount

- Use \blacktriangle \blacktriangledown to select “B-Even”, and then press $\boxed{\text{EXE}}$.

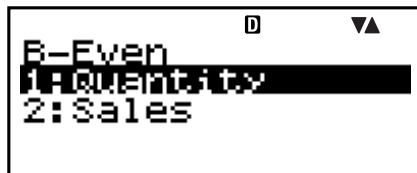

- Press $\boxed{1}$ (1:Quantity) or $\boxed{2}$ (2:Sales) to select the setting you want.
 - You can also use \blacktriangle \blacktriangledown to select a setting and then press $\boxed{\text{EXE}}$.

⑨ Digit Sep.: All modes except for the STAT Mode and COMP Mode

This setting specifies what type of 3-digit separator should be used. Note that the 3-digit separator is not displayed after you specify a number of significant digits with **⑫ Sci.**

- | | | |
|---------------|-------------------|---------|
| 1:Superscript | Superscript comma | 123'456 |
| 2:Subscript | Subscript comma | 123,456 |
| 3:Off | Separator off | 123456 |

- Use \blacktriangle \blacktriangledown to select “Digit Sep.”, and then press $\boxed{\text{EXE}}$.

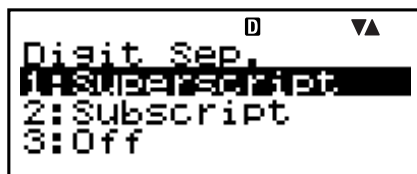

- Press $\boxed{1}$ (1:Superscript), $\boxed{2}$ (2:Subscript), or $\boxed{3}$ (3:Off) to select the setting you want.
 - You can also use \blacktriangle \blacktriangledown to select a setting and then press $\boxed{\text{EXE}}$.

⑩ Angle: All modes

This setting specifies the angle unit used for trigonometric functions.

$$90^\circ = \frac{\pi}{2} \text{ radians} = 100 \text{ grads}$$

- | | |
|-------|---------|
| 1:Deg | Degrees |
| 2:Rad | Radians |
| 3:Gra | Grads |

- Use \blacktriangle \blacktriangledown to select “Angle”, and then press $\boxed{\text{EXE}}$.

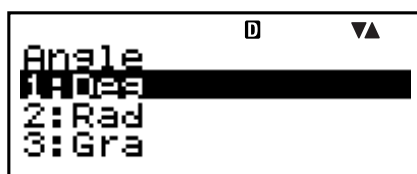

- Press **[1]** (1:Deg), **[2]** (2:Rad), or **[3]** (3:Gra) to select the setting you want.
 - You can also use **▲** **▼** to select a setting and then press **[EXE]**.

⑪ Fix: All modes

This setting specifies a fixed number of digits to the right of the decimal place. Calculation results are rounded off to the specified number of digits before being displayed.

- Changing this setting automatically cancels any previous settings made for **⑫ Sci** and **⑬ Norm**.
- Specify the number of decimal places by inputting a value in the range of 0 (round off and then cut fraction part) to 9 (nine decimal places).

- Use **▲** **▼** to select “Fix”, and then press **[EXE]**.

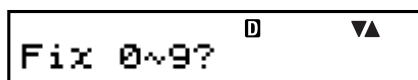

- Input a value from 0 to 9 to specify the number of decimal places.

$$\begin{aligned} \text{Example: } 100 \div 7 &= 14.286 \text{ (Fix 3)} \\ &= 14.29 \text{ (Fix 2)} \end{aligned}$$

⑫ Sci: All modes

This setting specifies the number of significant digits. Calculation results are rounded off to the specified number of digits before being displayed.

- Changing this setting automatically cancels any previous settings made for **⑪ Fix** and **⑬ Norm**.
- You can specify anywhere from 1 significant digit (by inputting 1) to 10 significant digits (by inputting 0).

- Use **▲** **▼** to select “Sci”, and then press **[EXE]**.

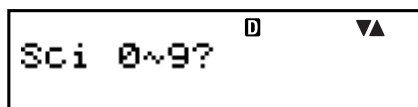

- Input a value from 0 to 9 to specify the number of significant digits.

$$\begin{aligned} \text{Example: } 10 \div 7 &= 1.4286 \times 10^0 \text{ (Sci 5)} \\ &= 1.429 \times 10^0 \text{ (Sci 4)} \end{aligned}$$

⑬ Norm: All modes

This setting specifies the range that determines when display of values switches to exponential format.

- Changing this setting automatically cancels any previous settings made for ⑪ Fix and ⑫ Sci.

$$\text{Norm1: } 10^{-2} > |x|, |x| \geq 10^{10}$$

$$\text{Norm2: } 10^{-9} > |x|, |x| \geq 10^{10}$$

$$\begin{aligned} \text{Example: } 1 \div 200 &= 5 \times 10^{-3} \text{ (Norm1)} \\ &= 0.005 \text{ (Norm2)} \end{aligned}$$

1. Use \blacktriangle \blacktriangledown to select “Norm”, and then press $\boxed{\text{EXE}}$.

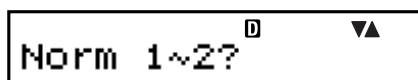

2. Press $\boxed{1}$ (Norm1) or $\boxed{2}$ (Norm2).

⑭ STAT: Statistics (STAT) Mode, Cash Flow (CASH) Mode

This setting controls whether a frequency (FREQ) column is included in the STAT Mode DataEditor.

- The Cash Flow (CASH) Mode uses the same DataEditor as the STAT Mode. Turning on display of the frequency column reduces the maximum number of data items that can be input for investment appraisal.

1:On Frequency (FREQ) column display on

2:Off Frequency (FREQ) column display off

1. Use \blacktriangle \blacktriangledown to select “STAT”, and then press $\boxed{\text{EXE}}$.

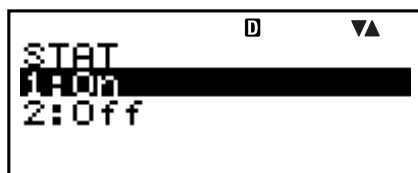

2. Press $\boxed{1}$ (1:On) or $\boxed{2}$ (2:Off) to select the setting you want.

- You can also use \blacktriangle \blacktriangledown to select a setting and then press $\boxed{\text{EXE}}$.

Important!

- This operation clears DataEditor data. Note that data is cleared even if you select the setting that corresponds to the current FREQ column display status. Selecting “On” while FREQ column display is currently turned on, for example, will clear DataEditor data.

⑮ **CONTRAST:** All modes

Select this setting when you want to adjust screen contrast and make display figures lighter or darker.

1. Use \blacktriangle \blacktriangledown to select “CONTRAST”, and then press $\boxed{\text{EXE}}$.

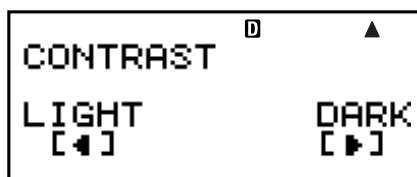

2. Use \blacktriangleleft and \blacktriangleright to adjust display contrast.
3. Press $\boxed{\text{ESC}}$.

Note

- On a setting screen, the cursor mark displayed on the upper right of a screen cannot be used.

◆ **Initializing the Setup Screen Settings**

1. $\boxed{\text{ON}}$ $\boxed{\text{SHIFT}}$ $\boxed{9}$ (CLR)
 2. “Setup:EXE” (\blacktriangle \blacktriangledown), then $\boxed{\text{EXE}}$.
 3. $\boxed{\text{EXE}}$ (Yes)
 4. $\boxed{\text{AC}}$
- To cancel initialization without doing anything, press $\boxed{\text{ESC}}$ (Cancel) instead of $\boxed{\text{EXE}}$ (Yes).
 - The calculator will automatically enter the COMP Mode after you initialize the setup screen settings.

Inputting Expressions and Values

■ Inputting a Calculation Expression Using Standard Format

Your calculator lets you input calculation expressions just as they are written. Then simply press the **EXE** key to execute it. The calculator automatically judges the calculation priority sequence for addition, subtraction, multiplication, and division, functions, and parentheses.

Example: $2(5 + 4) - 2 \times (-3) =$

2	(5	+	4)	-	2(5+4)-2×-3	▲
2	×	(-)	3	EXE	24			

◆ Inputting a Function with Parenthesis

When you input any of the functions shown below, it is automatically input with the open parenthesis (() character. Next, you need to input the argument and the closing parenthesis ()).

sin(, cos(, tan(, sin ⁻¹ (, cos ⁻¹ (, tan ⁻¹ (, sinh(, cosh(, tanh(, sinh ⁻¹ (, cosh ⁻¹ (, tanh ⁻¹ (, log(, ln(, e [^] (, 10 [^] (, [^] (, ³ √(, ^x √(, Abs(, Pol(, Rec(, Rnd(
--

Example: sin 30 =

Deg

1. **CTLG**
2. "sin(" (▲▼), then **EXE**.
3. **3** **0** **)** **EXE**

sin(30)	0	▲
		0.5

- Some commonly used functions can also be input using a direct key operation.

Example: sin 30 =

1. **SHIFT** **1** (sin)
2. **3** **0** **)** **EXE**

◆ Omitting the Multiplication Sign

You can omit the multiplication sign (\times) in any of the following cases.

- Before an open parentheses ($($): $2 \times (5 + 4)$, etc.
- Before a function with parenthesis: $2 \times \sin(30)$, $2 \times \sqrt{\quad}(3)$, etc.
- Before a variable name, constant, or random number: $20 \times A$, $2 \times \pi$, etc.

◆ Final Closed Parenthesis

You can omit one or more closed parentheses that come at the end of a calculation, immediately before the $\boxed{\text{EXE}}$ key is pressed. For details, see “Omitting a Final Closed Parenthesis” on page E-29.

◆ Displaying a Long Expression

The display can show up to 14 characters at a time. Inputting the 15th character causes the expression to shift to the left. At this time, the \blacktriangleleft indicator appears to the left of the expression, indicating that it runs off the left side of the screen.

Input expression: $1111 + 2222 + 3333 + 444$

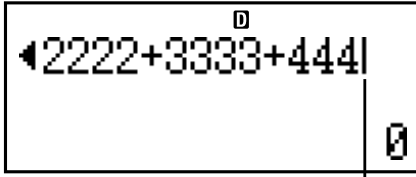
Displayed portion: 

- When the \blacktriangleleft indicator is displayed, you can scroll left and view the hidden part by pressing the \blacktriangleleft key. This will cause the \blacktriangleright indicator to appear to the right of the expression. At this time, you can use the \blacktriangleright key to scroll back.

◆ Number of Input Characters (Bytes)

- You can input up to 99 bytes of data for a single expression. Basically, each key operation uses up one byte. A function that requires two key operations to input (like $\boxed{\text{SHIFT}} \boxed{1}$ (sin)) also uses only one byte.

- Normally the input cursor appears as a straight vertical (|) or horizontal (—) flashing line on the display screen. When there are 10 or fewer bytes of input remaining in the current expression, the cursor changes shape to ■ to let you know. If the ■ cursor appears, terminate the expression at a convenient point and calculate the result.
- Each expression in calculation history memory (page E-33) can contain up to 76 bytes of data. Up to 89 bytes of data can be assigned to each custom shortcut key (page E-94).

■ Correcting an Expression

This section explains how to correct an expression as you are inputting it. The procedure you should use depends on whether you have insert or overwrite selected as the input mode.

◆ About the Insert and Overwrite Input Modes

With the insert mode, the displayed characters shift to the left to make room when you input a new character. With the overwrite mode, any new character you input replaces the character at the current cursor position.

- The cursor is a vertical flashing line (|) when the insert mode is selected. The cursor is a horizontal flashing line (—) when the overwrite mode is selected.
- The initial default is the insert mode. You can switch between the insert mode and the overwrite mode by pressing **SHIFT** **DEL** (INS).

◆ Changing the Character or Function You Just Input

Example: To correct the expression 369×13 so it becomes 369×12

3 6 9 X 1 3	$369 \times 13 $
DEL	$369 \times 1 $
2	$369 \times 12 $

◆ Deleting a Character or Function

Example: To correct the expression $369 \times \times 12$ so it becomes 369×12

Insert Mode:

3 **6** **9** **X** **X** **1** **2** 369××12|^D

◀ **◀** 369××|12^D

DEL 369×12^D

Overwrite Mode:

3 **6** **9** **X** **X** **1** **2** 369××12_^D

◀ **◀** **◀** 369××12^D

DEL 369×12^D

◆ Correcting a Calculation

Example: To correct $\cos(60)$ so it becomes $\sin(60)$

Insert Mode:

SHIFT **2** (cos) **6** **0** **)** cos(60)|^D

◀ **◀** **◀** **DEL** |60)^D

SHIFT **1** (sin) sin(|60)^D

Overwrite Mode:

SHIFT **2** (cos) **6** **0** **)** cos(60)_^D

◀ **◀** **◀** **◀** _cos(60)^D

SHIFT **1** (sin) sin(60)^D

◆ Inserting input into a Calculation

Always use the insert mode for this operation. Use ◀ or ▶ to move the cursor to the location where you want to insert new input, and then input what you want.

■ Displaying the Location of an Error

If an error message (like “Math ERROR” or “Syntax ERROR”) appears when you press [EXE], press ◀ or ▶. This will display the part of the calculation where the error occurred, with the cursor positioned at the error location. You can then make necessary corrections.

Example: When you input $14 \div 0 \times 2 =$ by mistake instead of $14 \div 10 \times 2 =$

Insert Mode:

[1] [4] [÷] [0] [×] [2] [EXE]

```
Math ERRORD
[AC] :Cancel
[←][→]:Goto
```

Press ▶ or ◀.

```
14÷0|×2D
```

This is causing the error.

◀ [1]

```
14÷10×2D
```

[EXE]

```
14÷10×2D ▲
2.8
```

You can also exit the error screen by pressing [AC], which clears the calculation.

Basic Calculations

This section explains how to perform arithmetic and percent calculations.

All calculations in this section are performed in the COMP Mode (**COMP**).

■ Arithmetic Calculations

Use the **+**, **-**, **×**, and **÷** keys to perform arithmetic calculations.

Example: $7 \times 8 - 4 \times 5 = 36$

7 **×** **8** **-** **4** **×** **5** **EXE**

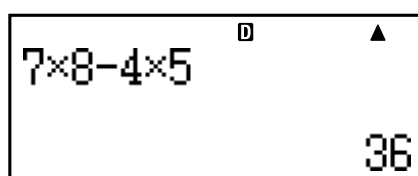

7x8-4x5
36

- The calculator automatically judges the calculation priority sequence. For more information, see “Calculation Priority Sequence” on page E-134.

◆ Number of Decimal Places and Number of Significant Digits

You can specify a fixed number of decimal places and significant digits for the calculation result.

Example: $1 \div 6 =$

Initial default setting (Norm1)

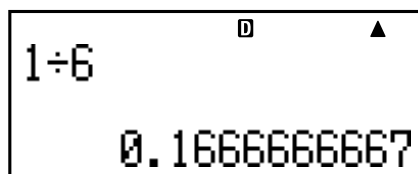

1÷6
0.1666666667

3 decimal places (Fix3)

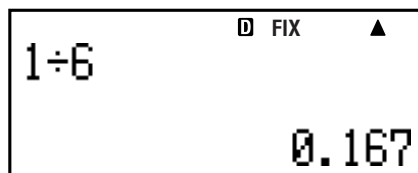

1÷6
0.167

3 significant digits (Sci3)

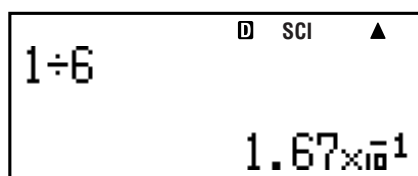

1÷6
 1.67×10^{-1}

- For more information, see “Configuring Settings” on page E-16.

◆ Omitting a Final Closed Parenthesis

You can omit any closed parenthesis () immediately preceding operation of the **EXE** key at the end of a calculation.

Example: $(2 + 3) \times (4 - 1) = 15$

(2 + 3) ×
(4 - 1) **EXE**

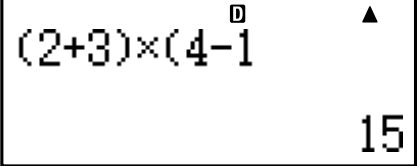

■ Percent Calculations

Example 1: $2\% = 0.02$

2 **SHIFT** ((%) **EXE**



Example 2: $150 \times 20\% = 30$

1 5 0 × 2 0
SHIFT ((%) **EXE**

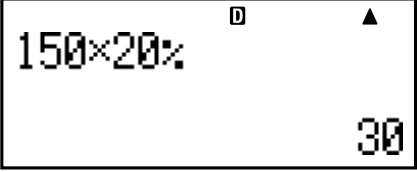

Example 3: To calculate what percentage of 880 is 660.

6 6 0 ÷ 8 8 0
SHIFT ((%) **EXE**

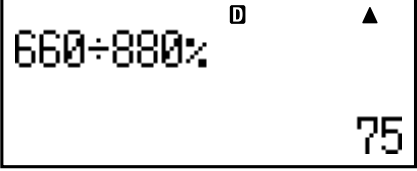

Example 4: To increase 2500 by 15%.

2 5 0 0 +
2 5 0 0 ×
1 5 **SHIFT** ((%) **EXE**

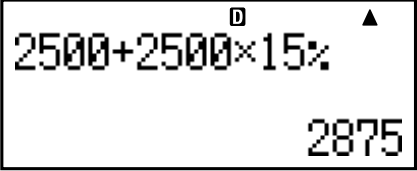

Example 5: To discount 3500 by 25%.

3	5	0	0	-	$3500 - 3500 \times 25\%$ 2625
3	5	0	0	X	
2	5	SHIFT	((%)	

Example 6: To discount the sum of 168, 98, and 734 by 20%.

1	6	8	+	9	8	+	$168 + 98 + 734$ 1000
			7	3	4	EXE	

-	Ans	X	2	0	SHIFT	((%)	EXE	$\text{Ans} - \text{Ans} \times 20\%$ 800

Example 7: If 300 grams are added to a test sample originally weighing 500 grams, what is the percentage increase in weight?

3	0	0	+	5	0	0	$300 + 500 \Delta\%$ 160
			SHIFT	.	(\Delta\%)		

Example 8: What is the percentage change when a value is increased from 40 to 46? How about to 48?

Insert Mode:

4	6	-	4	0	$46 - 40 \Delta\%$ 15
		SHIFT	.	(\Delta\%)	

▶	▶	▶	DEL	8	EXE	$48 - 40 \Delta\%$ 20

Example 9: To calculate the selling price and profit when the purchase price is \$480 and the profit rate to the selling price is 25%.

$480 \times 25\%$
 4 8 0 \times 2 5
 SHIFT \cdot ($\Delta\%$)

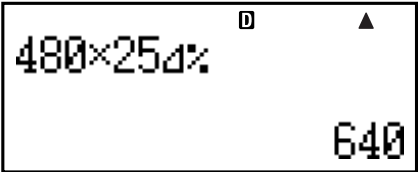

$480 \div 25\%$
 4 8 0 \div 2 5
 SHIFT \cdot ($\Delta\%$)

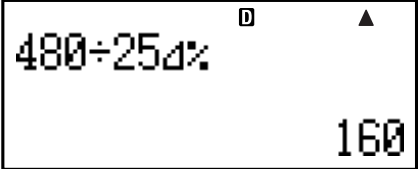

Example 10: To calculate the bargain price and loss when the purchase price is \$130 and the loss rate is 4%.

$130 \times -4\%$
 1 3 0 \times (-) 4
 SHIFT \cdot ($\Delta\%$)

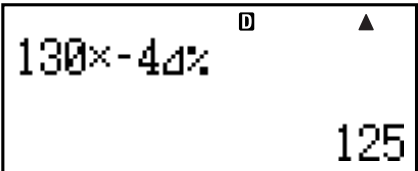

$130 \div -4\%$
 1 3 0 \div (-) 4
 SHIFT \cdot ($\Delta\%$)

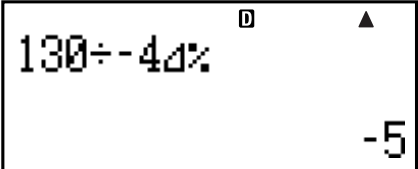

Using Multi-statements in Calculations

You can use the colon character (:) to connect two or more expressions and execute them in sequence from left to right when you press **EXE**.

Example: To create a multi-statement that performs the following two calculations: $3 + 3$ and 3×3

Insert Mode:

1. **3** **+** **3**
2. **CTLG**
3. “:” (**▲** **▼**), then **EXE**.
4. **3** **×** **3**

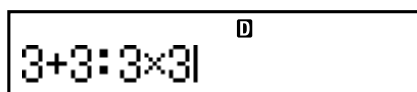

3+3:3x3| ^D



EXE 3+3 ^D ▲Disp
6

“Disp” indicates this is an intermediate result of a multi-statement.

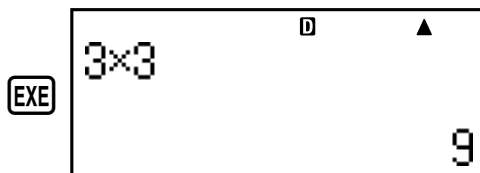

EXE 3x3 ^D ▲
9

Using Calculation History Memory and Replay

Calculation history memory maintains a record of each calculation expression you input and execute, and its result.

You can use calculation history memory in the COMP Mode (**COMP**) only.

◆ Recalling Calculation History Memory Contents

Press **▲** to back-step through calculation history memory contents. Calculation history memory shows both calculation expressions and results.

Example:

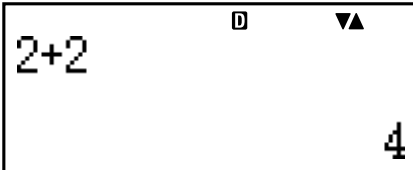
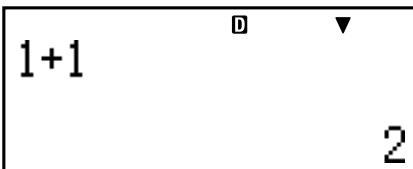
1	+	1	EXE	
2	+	2	EXE	
3	+	3	EXE	
	▲			
	▲			

- Note that calculation history memory contents are cleared whenever you turn off the calculator, press the **ON** key, change to another mode, or perform the operation under “Initializing the Calculator” (page E-3) or “Initializing the Setup Screen Settings” (page E-22).
- Calculation history memory is limited. When the calculation you are performing causes calculation history memory to become full, the oldest calculation is deleted automatically to make room for the new calculation.

◆ Replay Function

While a calculation result is on the display, you can press ◀ or ▶ to edit the expression you used for the previous calculation.

Example: $4 \times 3 + 2.5 = 14.5$

$4 \times 3 - 7.1 = 4.9$

4 × 3 + 2.5 = 14.5

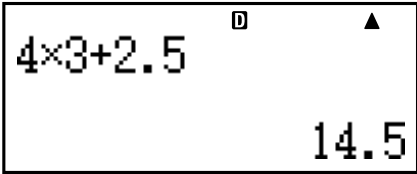

AC



◀

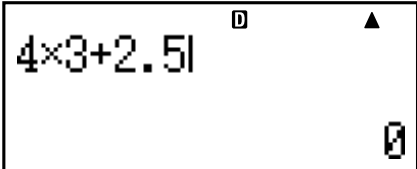

DEL DEL DEL DEL

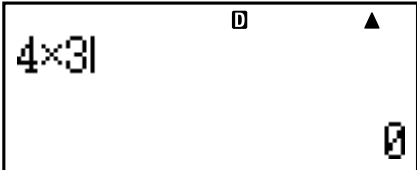

- 7 . 1 =

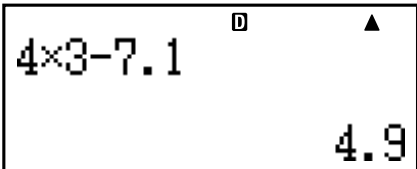

Using Calculator Memory

Memory Name	Description
Answer Memory	Stores the last calculation result obtained.
Independent Memory	Calculation results can be added to or subtracted from independent memory. The “M” display indicator indicates data in independent memory.
Variables	Six variables named A, B, C, D, X, and Y can be used for storage of individual values.
VARs	The following are the names of the financial calculation variables: n , $I\%$, PV, PMT, FV, P/Y, C/Y, PM1, PM2, Dys.

This section uses the COMP Mode (**COMP**) to demonstrate how you can use memory.

■ Answer Memory (Ans)

◆ Answer Memory Overview

- Answer Memory contents are updated whenever you execute a calculation using any one of the following keys: **EXE**, **SOLVE**, **M+**, **SHIFT** **M+** (**M-**), **RCL**, or **SHIFT** **RCL** (**STO**). Answer Memory can hold up to 15 digits.
- Answer Memory contents do not change if an error occurs during the current calculation.
- Answer Memory contents are maintained even if you press the **AC** key, change the calculation mode, or turn off the calculator.
- When multiple results are obtained (in polar coordinate calculations, when “ALL:Solve” is selected in the Simple Interest Mode, etc.), the result that is displayed at the top of the screen is the one stored in Answer Memory.

◆ Using Answer Memory to Perform a Series of Calculations

Example: To divide the result of 3×4 by 30

$\boxed{3} \boxed{\times} \boxed{4} \boxed{\text{EXE}}$

3×4	0	▲
		12

(Continuing) $\boxed{\div} \boxed{3} \boxed{0} \boxed{\text{EXE}}$

Ans÷30	0	▲
		0.4

Pressing $\boxed{\div}$ automatically inputs “Ans” command.

- With the above procedure, you need to perform the second calculation immediately after the first one. If you need to recall Answer Memory contents after pressing $\boxed{\text{AC}}$, press the $\boxed{\text{Ans}}$ key.

◆ Inputting Answer Memory Contents into an Expression

Example: To perform the calculations shown below:

$$123 + 456 = \underline{579} \qquad 789 - \underline{579} = 210$$

$\boxed{1} \boxed{2} \boxed{3} \boxed{+} \boxed{4} \boxed{5} \boxed{6} \boxed{\text{EXE}}$

123+456	0	▲
		579

$\boxed{7} \boxed{8} \boxed{9} \boxed{-} \boxed{\text{Ans}} \boxed{\text{EXE}}$

789-Ans	0	▲
		210

■ Independent Memory (M)

You can add calculation results to or subtract results from independent memory. The “M” appears on the display when independent memory contains a value.

◆ Independent Memory Overview

- The following is a summary of the different operations you can perform using independent memory.

To do this:	Perform this key operation:
Add the displayed value or result of the expression to independent memory	M+
Subtract the displayed value or result of the expression from independent memory	SHIFT M+ (M-)
Recall current independent memory contents	ALPHA M+ (M)
Assign a specific value or result of the expression to independent memory	1. 3 + 5 (for example) 2. SHIFT RCL (STO) 3. “M:”(▲ ▼), then EXE . 4. EXE (Yes)

- You can also store financial calculation value in independent memory.

Example: In the SMPL Mode, store the value of SI in independent memory (M)

1. Enter the SMPL Mode for calculation of simple interest (SI). See pages E-42 and E-43 for more information.
2. **SHIFT RCL** (STO)
3. “SI”(▲ ▼), then **EXE**.
4. “M:”(▲ ▼), then **EXE**.
5. **EXE** (Yes)

$SI = -164.3835616$ $SFV = -10164.38356$
--

- A number sign (#) next to the independent memory variable name indicates that it already contains data. Performing the following steps will replace any existing data with the new data.

- The “M” indicator appears in the upper left of the display when there is any value other than zero stored in independent memory.
- Independent memory contents are maintained even if you press the **AC** key, change the calculation mode, or turn off the calculator.

◆ Calculation Examples Using Independent Memory

- If the “M” indicator is on the display, perform the procedure under “Clearing Independent Memory” before performing this example.

Example:	$23 + 9 = 32$	2 3 + 9 M+
	$53 - 6 = 47$	5 3 - 6 M+
	$\text{—) } 45 \times 2 = 90$	4 5 × 2 SHIFT M+ (M-)
	$99 \div 3 = 33$	9 9 ÷ 3 M+
	<hr/>	
	(Total) 22	ALPHA M+ (M) EXE

◆ Clearing Independent Memory

1. **0**
 2. **SHIFT** **RCL** (**STO**)
 3. “M:” (**▲** **▼**), then **EXE**.
 4. **EXE** (Yes)
- This clears independent memory and causes the “M” indicator to disappear from the display.

■ Variables (A, B, C, D, X, Y)

◆ Variable Overview

- You can assign a specific value or a calculation result to a variable.

Example: To assign the result of $3 + 5$ to variable A.

1. **3** **+** **5**
2. **SHIFT** **RCL** (**STO**)
3. “A:” (**▲** **▼**), then **EXE**.
4. **EXE** (Yes)

- Use the following procedure when you want to check the contents of a variable.

Example: To recall the contents of variable A

[ALPHA] **[CNVR]** (A)

- The following shows how you can include variables inside of an expression.

Example: To multiply the contents of variable A by the contents of variable B

[ALPHA] **[CNVR]** (A) **[X]** **[ALPHA]** **[COST]** (B) **[EXE]**

- You can also assign a financial calculation value to a variable.

Example: In the CMPD Mode, assign the value of PMT to variable “A”.

1. CMPD mode: “PMT”
(**[▲]** **[▼]**).
2. **[SHIFT]** **[RCL]** (STO)
3. “A:” (**[▲]** **[▼]**), then **[EXE]**.
4. **[EXE]** (Yes)

D ▲
PMT=-5000
FV=100000
P/Y=12
C/Y=12

- A number sign (#) next to a variable name indicates that there is already data assigned to the variable. Performing the following steps will replace any existing data with the new data.
- Variable contents are maintained even if you press the **[AC]** key, change the calculation mode, or turn off the calculator.

Example: $\frac{9 \times 6 + 3}{5 \times 8} = 1.425$

1. **[9]** **[X]** **[6]** **[+]** **[3]**
2. **[SHIFT]** **[RCL]** (STO)
3. “B:” (**[▲]** **[▼]**), then **[EXE]**.
4. **[EXE]** (Yes)
5. **[5]** **[X]** **[8]**
6. **[SHIFT]** **[RCL]** (STO)
7. “C:” (**[▲]** **[▼]**), then **[EXE]**.
8. **[EXE]** (Yes)

D ▲
9×6+3→B
57

D ▲
5×8→C
40

9. **ALPHA** **COST** (B) **÷** **ALPHA** **DAYS** (C)
EXE

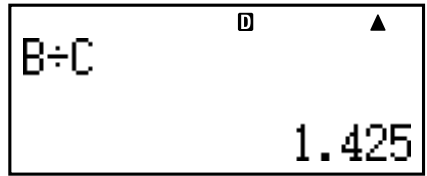

■ Financial Calculation Variables (VARs)

- The following are the names of the financial calculation variables (VARs):
n, I%, PV, PMT, FV, P/Y, C/Y, PM1, PM2, Dys.
- Financial calculation variables are used in financial calculations to store values. See the sections that describe the various modes for information about which variables are used in each mode.
- In the COMP Mode, the above variables are used as arithmetic variables, and are referred to as such in the section explaining the COMP Mode.

◆ To select an financial calculation variable in the COMP mode

1. Press **SHIFT** **CTLG** (VARs).



2. On the menu screen that appears, use **▲** **▼** to move the highlighting to the variable you want to select, and then press **EXE**.

◆ Clearing the Contents of VARs Memories Only

1. **ON** **SHIFT** **9** (CLR)
 2. “VARs:EXE” (**▲** **▼**), then **EXE**.
 3. **EXE** (Yes)
 4. **AC**
- To cancel the clear operation without doing anything, press **ESC** (Cancel) instead of **EXE** (Yes).
 - VARs Memory Initial Default Values
- | | |
|---|---|
| P/Y, C/Y | 1 |
| <i>n</i> , I%, PV, PMT, FV, PM1, PM2, Dys | 0 |

■ Clearing Memory Contents

Use the following procedure to clear the contents of Answer Memory, independent memory, and all of the variables.

This procedure does not clear VARS memory contents. See “Clearing the Contents of VARS Memories Only” for more information.

1. **ON** **SHIFT** **9** (CLR)
 2. “Memory:EXE” (**▲** **▼**), then **EXE**.
 3. **EXE** (Yes)
 4. **AC**
- To cancel the clear operation without doing anything, press **ESC** (Cancel) instead of **EXE** (Yes).

Financial Calculation

■ Simple Interest Mode

- The Simple Interest (SMPL) Mode lets you calculate the interest amount and/or simple future value (principal and interest amount).

◆ Entering the SMPL Mode

- Press **[SMPL]** to enter the SMPL Mode.

Value Input Screen

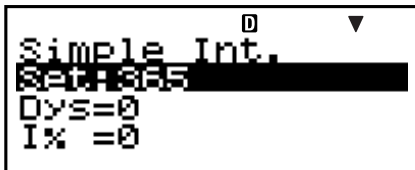

```
Simple Int.
Set: 365
Dys=0
I% =0
```

◆ Setting Values

No.	Display	Name	Values Used in Examples
①	Set*	Days in Year (Date Mode)	365
②	Dys	Number of Interest Periods (Number of Days)	120
③	I%	Interest Rate (Annual)	5%
④	PV	Principal (Present Value)	\$10,000

* For information about specifying the Date Mode, see the “Date Mode” item under “Configuring Settings” on page E-16.

◆ Basic SMPL Mode Procedure

Example 1: To calculate the interest amount (SI), and the simple future value (SFV)

1. Input the values for ①, ②, ③, and ④ from the Setting Values table above.

- For this example, use **▲ ▼** to select ① “Set:”, and then press **[EXE]**.

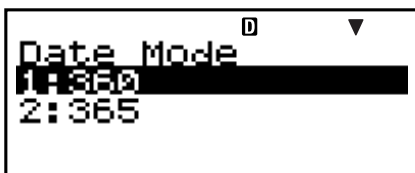

```
Date Mode
1: 365
2: 365
```

- Press **[2]** to select “365”.
- Use **[▲]** **[▼]** to select **(2)** “Dys”, input 120, and then press **[EXE]**.

```

Simple Int.
Set:365
Dys=120
I% =0

```

- Use **[▲]** **[▼]** to select **(3)** “I%”, input 5, and then press **[EXE]**.
- Use **[▲]** **[▼]** to select **(4)** “PV”, input 10000, and then press **[EXE]**.

2. Select the value you want to calculate.

- For this example, use **[▲]** **[▼]** to select “ALL: Solve”.

```

PV =10000
SI :Solve
SFV:Solve
ALL:Solve

```

3. Press **[SOLVE]** to perform the calculation.

```

SI =-164.3835616
SFV=-10164.38356

```

- Pressing the **[ESC]** key returns to the value input screen.
- To solve for the items that have “Solve” specified (such as “ALL:Solve”), you can press **[EXE]** instead of **[SOLVE]**.

◆ Other SMPL Mode Calculations

Example 2: To calculate the simple interest (SI) amount only

- In step 2 of the basic procedure (Example 1), select “SI:Solve”.

Example 3: To calculate the simple future value (SFV) only

- In step 2 of the basic procedure (Example 1), select “SFV:Solve”.

```

SI =-164.3835616

```

```

SFV=-10164.38356

```

◆ SMPL Mode Financial Calculation Variables (VARS)

- Variables *Dys*, *I%*, and *PV* are used in the SMPL Mode.
- The values of SMPL Mode variables are retained even if you change to another mode. Note, however, that SMPL Mode variables are also used by other modes, so performing an input or calculation operation may change the values assigned to them.
- Though SMPL Mode variables are financial calculation variables, they are also used by arithmetic and function operations in the COMP Mode.

◆ Calculation Formulas

$$\text{365-day Mode} \quad SI' = \frac{\text{Dys}}{365} \times PV \times i \quad \left(i = \frac{I\%}{100} \right)$$

$$\text{360-day Mode} \quad SI' = \frac{\text{Dys}}{360} \times PV \times i \quad \left(i = \frac{I\%}{100} \right)$$

$$SI = -SI'$$

$$SFV = -(PV + SI')$$

SI : simple interest

Dys : number of interest periods

PV : principal

I% : interest rate (annual)

SFV : principal plus interest

■ Compound Interest Mode

- The Compound Interest (CMPD) Mode lets you calculate any one of the following values, by inputting values for the other four: number of payments, interest rate, principal, payment amount, and future value (principal and interest, or final payment amount).

◆ Entering the CMPD Mode

- Press **[CMPD]** to enter the CMPD Mode.

Value Input Screen

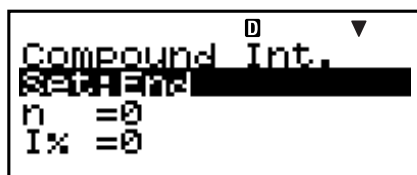

◆ Setting Values

No.	Display	Name	Values Used in Examples
①	Set* ¹	Payment Period (Payment)	End
②	n	Number of Payments	48
③	I%	Interest Rate	4%
④	PV	Present Value (Principal)	-\$1,000
⑤	PMT	Payment Amount	-\$300
⑥	FV	Future Value (Principal and Interest, or Final Payment Amount)	\$16,760
⑦	P/Y	Number of Annual Payments (PMT)	12
⑧	C/Y* ²	Number of Annual Compoundings	12

*¹ • For information about specifying the payment period, see the “Payment” item under “Configuring Settings” on page E-16.

- In the case of compound interest calculations, you can also use the compound interest mode (dn) setting on the setup screen for interest calculations of odd (partial) months. See the explanation of the compound interest mode (dn) setting (page E-16) for more information.

*² Specify 2 for semiannual compound interest, or 12 for monthly compound interest.

Note

- After specifying the ① Payment Period (Payment) and inputting values for ⑦ Number of Annual Payments (P/Y) and ⑧ Number of Annual Compoundings, you can calculate any one of the following by inputting values for the other four: Number of Payments, Interest Rate, Principal, Payment Amount, Future Value (principal and interest, or final payment amount).
- Input money paid out as a negative value, using the $\boxed{-}$ key to input the minus sign.

◆ Basic CMPD Mode Procedure

Example 1: To calculate the future value (FV) of an investment vehicle that pays an annual interest rate of 4%, when the initial deposit is \$1,000 and additional deposits of \$300 are made each month

1. Input the required values from the Setting Values table (page E-45).

- For this example, use \blacktriangle \blacktriangledown to select ① “Set:”, and then press $\boxed{\text{EXE}}$.

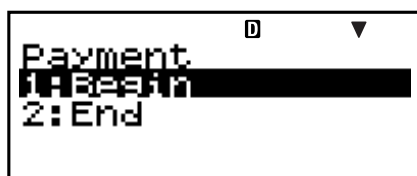

```
Payment 0 ▼
1:Begin
2:End
```

- Press $\boxed{2}$ to select “End”.
- Use \blacktriangle \blacktriangledown to select ② “n”, input 48, and then press $\boxed{\text{EXE}}$.

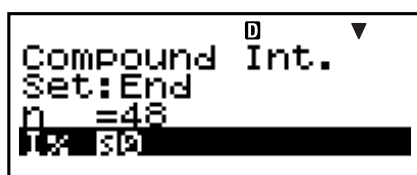

```
Compound Int. 0 ▼
Set:End
n=48
ix 50
```

- Use \blacktriangle \blacktriangledown to select ③ “I%”, input 4, and then press $\boxed{\text{EXE}}$.
- Use \blacktriangle \blacktriangledown to select ④ “PV”, input -1000, and then press $\boxed{\text{EXE}}$.
- Use \blacktriangle \blacktriangledown to select ⑤ “PMT”, input -300, and then press $\boxed{\text{EXE}}$.
- Use \blacktriangle \blacktriangledown to select ⑦ “P/Y”, input 12, and then press $\boxed{\text{EXE}}$.
- Use \blacktriangle \blacktriangledown to select ⑧ “C/Y”, input 12, and then press $\boxed{\text{EXE}}$.

Input Precautions

- Before specifying the number of months when there is a partial month, see “Calculating the Number of Months when a Partial Month is Included” (page E-47).
- Input money paid out as a negative value, using the $\boxed{(-)}$ key to input the minus sign.

2. Select the value you want to calculate.

- For this example, use \blacktriangle \blacktriangledown to select “FV”.

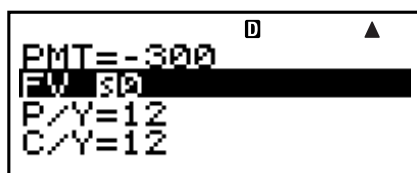

```
PMT=-300 0 ▲
FV 50
P/Y=12
C/Y=12
```

- Press **[SOLVE]** to perform the calculation.

```

PMT=-300
FV=16761.07897
P/Y=12
C/Y=12
  
```

◆ Calculating the Number of Payments (n), Interest Rate ($I\%$), Present Value (Principal: PV), and Payment Amount (PMT)

- Use the same procedure as shown under “Example 1” (page E-46), substituting the required values.

◆ Calculating the Number of Months when a Partial Month is Included

The following example shows how to calculate the number of months (number of days/total days in the month) for the number of payments (n) when a partial month is include.

Example 1: When the payment period is 16 months and 20 days

- When $P/Y=12$, n can be thought of as being the payment period (number of months).

- Use **[▲]** **[▼]** to select “ n ”.
- Input the division operation that divides the number of days in the partial month (20 in this example) by the total number of days in the month.

- This example assumes that there are 30 days in the month.

```

Compound Int.
Set:End
n =20÷30
I% =0
  
```

- Add the number of full months (16 in this example).

```

Compound Int.
Set:End
n =20÷30+16
I% =0
  
```

- Press **[EXE]**.

```

Compound Int.
Set:End
n =16.66666667
I% =0
  
```

Note

- When n includes a fractional part (odd period), the calculator always assumes the odd period occurs before the first full payment period.

◆ Selecting Interest Calculation for a Period with a Partial Month

- You can select compound interest or simple interest to calculate interest for a period with a partial month. Before performing each type of calculation, first use Configuring Settings (page E-16) to select either compound interest or simple interest for the dn setting.

◆ CMPD Mode Financial Calculation Variables (VARS)

- Variables n , $I\%$, PV , PMT , FV , P/Y , and C/Y are used in the CMPD Mode.
- The values of CMPD Mode variables are retained even if you change to another mode. Note, however, that CMPD Mode variables are also used by other modes, so performing an input or calculation operation may change the values assigned to them.
- Though CMPD Mode variables are financial calculation variables, they are also used by arithmetic and function operations in the COMP Mode.

◆ Calculation Formulas

- **PV, PMT, FV, n**

$$\underline{I\% \neq 0}$$

$$PV = \frac{-\alpha \times PMT - \beta \times FV}{\gamma}$$

$$PMT = \frac{-\gamma \times PV - \beta \times FV}{\alpha}$$

$$FV = \frac{-\gamma \times PV - \alpha \times PMT}{\beta}$$

$$n = \frac{\log \left\{ \frac{(1+iS) \times PMT - FV \times i}{(1+iS) \times PMT + PV \times i} \right\}}{\log(1+i)}$$

$$\underline{I\% = 0}$$

$$PV = - (PMT \times n + FV)$$

$$PMT = - \frac{PV + FV}{n}$$

$$FV = - (PMT \times n + PV)$$

$$n = - \frac{PV + FV}{PMT}$$

$$\alpha = (1 + i \times S) \times \frac{1 - \beta}{i}, \beta = (1 + i)^{(-Intg(n))}$$

$$\gamma = \begin{cases} (1 + i)^{Frac(n)} & \dots\dots\dots dn : CI \text{ (Setup Screen)} \\ 1 + i \times Frac(n) & \dots\dots\dots dn : SI \text{ (Setup Screen)} \end{cases}$$

$$S = \begin{cases} 0 & \dots\dots\dots \text{Payment : End} \\ & \text{(Setup Screen)} \\ 1 & \dots\dots\dots \text{Payment : Begin} \\ & \text{(Setup Screen)} \end{cases}$$

$$i = \begin{cases} \frac{I\%}{100} & \dots\dots\dots (P/Y = C/Y = 1) \\ \left(1 + \frac{I\%}{100 \times [C/Y]}\right)^{\frac{C/Y}{P/Y}} - 1 & \dots\dots \text{(Other than those above)} \end{cases}$$

• I%

i (effective interest rate)

i (effective interest rate) is calculated using Newton's Method.

$$\gamma \times PV + \alpha \times PMT + \beta \times FV = 0$$

To I% from i (effective interest rate)

$$I\% = \begin{cases} i \times 100 & \dots\dots\dots (P/Y = C/Y = 1) \\ \left\{ \left(1 + i\right)^{\frac{P/Y}{C/Y}} - 1 \right\} \times C/Y \times 100 & \dots\dots \text{(Other than those above)} \end{cases}$$

- n : Number of Payments
- $I\%$: Interest Rate
- PV : Present Value (Principal)
- PMT : Payment Amount
- FV : Future Value (Principal and Interest, or Final Payment Amount)
- P/Y : Number of Annual Payments (PMT)
- C/Y : Number of Annual Compoundings

Note

- This calculator performs interest ($I\%$) calculations using Newton's Method, which produces approximate values whose precision can be affected by various calculation conditions. Because of this, interest calculation results produced by this calculator should be used keeping the above limitation in mind, or the results should be verified.
- When you use \blacktriangle and \blacktriangledown to select an item that can be calculated, the "=" changes to "**S**". You can perform a calculation by inputting the required values for the other items, and then pressing the **SOLVE** key. Performing the calculation causes the "**S**" to change back to "=".

■ Cash Flow Mode

- The Cash Flow (CASH) mode calculates the total of income and expenses over a fixed period, and then uses the discounted cash flow (DCF) method to perform investment appraisal. The following four items are appraised.

NPV : Net Present Value

IRR : Internal Rate of Return

PBP : Payback Period*

NFV : Net Future Value

- * The payback period (PBP) can also be called the "discounted payback period" (DPP). When the annual interest rate ($I\%$) is zero, the PBP is called the "simple payback period" (SPP).

◆ Entering the CASH Mode

- Press **CASH** to enter the CASH Mode.

Value Input Screen

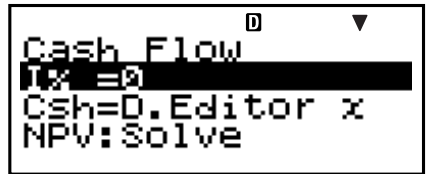

A cash flow diagram like the one shown below helps to visualize the movement of funds.

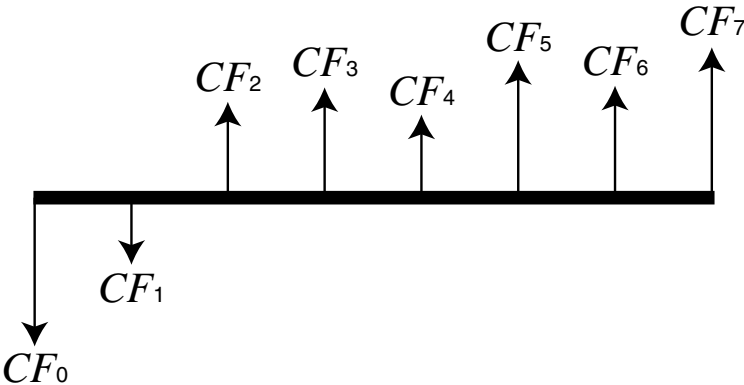

With this graph, the initial investment amount is represented by CF_0 . The cash flow one year later is shown by CF_1 , two years later by CF_2 , and so on.

◆ Setting Values

No.	Display	Name	Values Used in Examples
①	I%	Annual Interest	3%

◆ Receipt and Payment Summary

Period	Receipt/Payment	Values Used in Examples
CF_0	Payment	-\$10,000
CF_1	Payment	-\$1,000
CF_2	Receipt	\$4,500
CF_3	Receipt	\$5,000
CF_4	Receipt	\$4,000

- Input money paid out as a negative value, using the **(-)** key to input the minus sign.

◆ Basic CASH Mode Procedure

Example 1: To calculate net present value (NPV)

1. Input the annual interest (I%), and then receipt and payment values provided on page E-51.

- Use \blacktriangle \blacktriangledown to select ① “I%”, input 3, and then press $\boxed{\text{EXE}}$.

Cash Flow D \blacktriangledown
 I% = 3
 Csh=D, Editor x
 NPV: Solve

- Use \blacktriangle \blacktriangledown to select “Csh =D.Editor x”, and then press $\boxed{\text{EXE}}$.

D
 | x |
 1 2 3 |

This displays the DataEditor. Only the x -column is used for calculation. Any values in the y -column and FREQ-column are not used.

Note

- The STAT editor and the D.Editor x of the CASH Mode use the same memory area to store data.

- -10000 $\boxed{\text{EXE}}$ (CF_0)
 Input money paid out as a negative value, using the $\boxed{-}$ key to input the minus sign.

D
 | x |
 1 2 3 | -10000 |

- -1000 $\boxed{\text{EXE}}$ (CF_1)
- 4500 $\boxed{\text{EXE}}$ (CF_2)
- 5000 $\boxed{\text{EXE}}$ (CF_3)
- 4000 $\boxed{\text{EXE}}$ (CF_4)

D
 | x |
 4 5 6 | 5000 |
 | 4000 |

2. Press $\boxed{\text{ESC}}$ to return to the value input screen.
3. Select the value you want to calculate.

- For this example, use \blacktriangle \blacktriangledown to select “NPV: Solve”.

Cash Flow D \blacktriangle
 I% = 3
 Csh=D, Editor x
 NPV: Solve

4. Press $\boxed{\text{SOLVE}}$ to perform the calculation.

D
 NPV=1400.464293

- Pressing the $\boxed{\text{ESC}}$ key returns to the value input screen.

◆ Other CASH Mode Calculations

Example 2: To calculate the internal rate of return (IRR)

- In step 3 of the basic procedure (Example 1), select “IRR:Solve”.
- The IRR calculation result is assigned to financial variable (VARS) I%.

Example 3: To calculate the payback period (PBP)

- In step 3 of the basic procedure (Example 1), select “PBP:Solve”.

Example 4: To calculate net future value (NFV)

- In step 3 of the basic procedure (Example 1), select “NFV: Solve”.

◆ Maximum Number of DataEditor Items

Maximum Number of Data Items	DataEditor Screen
80	X
40	X, Y or X, FREQ
26	X, Y, FREQ

- Only the x -column is used for calculation. Any values in the y -column and FREQ-column are not used.
- Normally, you will be able to input up to 80 data items in the DataEditor.
- To maximize the number of data items you can input, enter the STAT Mode, select “1-VAR”, and then use the setup screen to select “Off” for the “STAT” setting (page E-21).
- Values you input while “1-VAR” is selected are cleared when “2-VAR” is selected in the STAT Mode. Conversely, values you input while “2-VAR” is selected are cleared when “1-VAR” is selected in the STAT Mode.

◆ CASH Mode Financial Calculation Variables (VARS)

- Variable I% is used in the CASH Mode.
- The value of the CASH Mode variable is retained even if you change to another mode. Note, however, that I% is also used by other modes, so performing an input or calculation operation may change the value assigned to it.

- Though $I\%$ is a financial calculation variable, it is also used by arithmetic and function operations in the COMP Mode.

◆ Calculation Formulas

• NPV

$$NPV = CF_0 + \frac{CF_1}{(1+i)} + \frac{CF_2}{(1+i)^2} + \frac{CF_3}{(1+i)^3} + \dots + \frac{CF_n}{(1+i)^n} \quad \left(i = \frac{I\%}{100} \right)$$

n : natural number up to 79

• NFV

$$NFV = NPV \times (1+i)^n$$

• IRR

IRR is calculated using Newton's Method.

$$0 = CF_0 + \frac{CF_1}{(1+i)} + \frac{CF_2}{(1+i)^2} + \frac{CF_3}{(1+i)^3} + \dots + \frac{CF_n}{(1+i)^n}$$

In this formula, $NPV = 0$, and the value of IRR is equivalent to $i \times 100$. It should be noted, however, that minute fractional values tend to accumulate during the subsequent calculations performed automatically by the calculator, so NPV never actually reaches exactly zero. IRR becomes more accurate the closer that NPV approaches to zero.

• PBP

$$PBP = \begin{cases} 0 & \dots \dots \dots (CF_0 \geq 0) \\ n - \frac{NPV_n}{NPV_{n+1} - NPV_n} & \dots \dots \dots \text{(Other than those above)} \end{cases}$$

$$NPV_n = \sum_{k=0}^n \frac{CF_k}{(1+i)^k}$$

n : Smallest positive integer that satisfies the conditions $NPV_n \leq 0$, $NPV_{n+1} \geq 0$, or 0.

■ Amortization Mode

- The Amortization (AMRT) Mode lets you calculate the principal balance, and the interest portion and principal portion of monthly payments, as well as interest and principal amounts paid to date.

BAL : Principal balance upon completion of payment PM2

INT : Interest portion of payment PM1

PRN : Principal portion of payment PM1

ΣINT : Total interest paid from payment PM1 to payment PM2

ΣPRN : Total principal paid from payment PM1 to payment PM2

◆ Entering the AMRT Mode

- Press **AMRT** to enter the AMRT Mode.

Value Input Screen

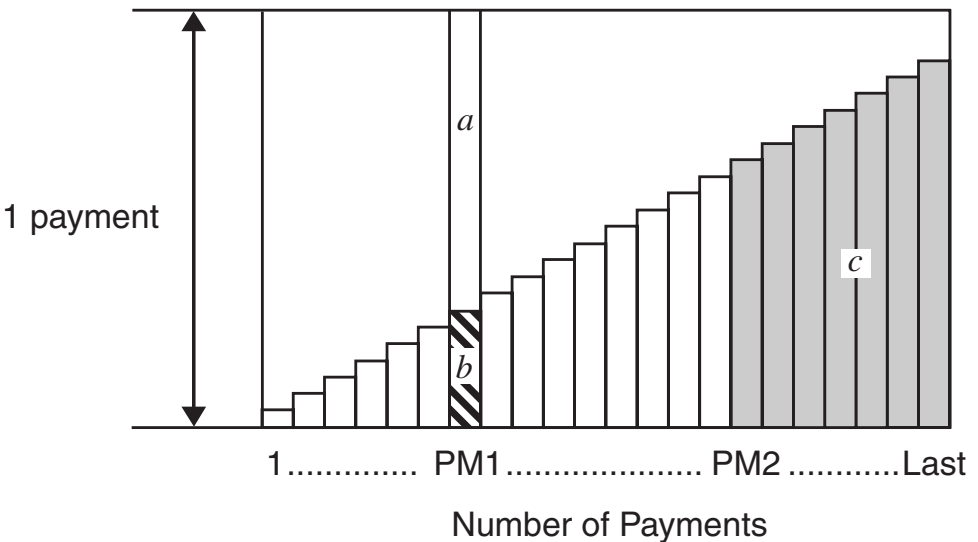

a : Interest portion of payment PM1 (INT)

b : Principal portion of payment PM1 (PRN)

c : Principal balance upon completion of payment PM2 (BAL)

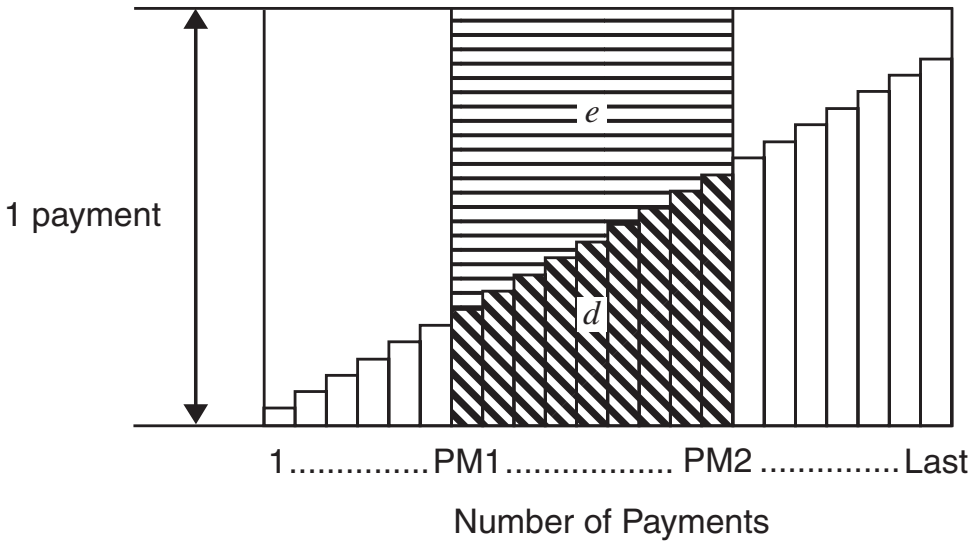

d : Total principal paid from payment PM1 to payment PM2 (ΣPRN)

e : Total interest paid from payment PM1 to payment PM2 (ΣINT)

◆ Setting Values

No.	Display	Name	Values Used in Examples
①	Set ^{*1}	Payment Period (Payment)	End
②	PM1	Payment PM1 (Number of Payments)	15
③	PM2 ^{*2}	Payment PM2 (Number of Payments)	28
④	n^{*3}	Number of Payments (Number of Months)	—
⑤	I%	Interest Rate (Annual)	2%
⑥	PV	Principal	\$100,000
⑦	PMT	Payment Amount	-\$920
⑧	FV^{*3}	Ending Balance after Last Payment (Future Value)	—
⑨	P/Y	Number of Annual Payments (PMT)	12
⑩	C/Y ^{*4}	Number of Annual Compoundings	12

- *1 For information about specifying the payment period, see the “Payment” item under “Configuring Settings” on page E-16.
 - *2 Make sure the payment you specify for PM2 comes after the payment you specify for PM1.
 - *3 This variable is used by other modes. The value that initially appears may be a value that was input or calculated in another mode.
 - *4 Specify 2 for semiannual compound interest, or 12 for monthly compound interest.
- Input money paid out as a negative value, using the $\boxed{\ominus}$ key to input the minus sign.

◆ Basic AMRT Mode Procedure

Example 1: To calculate the principal balance (BAL) after payment 28

1. Input the values for ①, ②, ③, ⑤, ⑥, ⑦, ⑨, and ⑩ from the Setting Values table (page E-56).

- For this example, use $\boxed{\blacktriangle}$ $\boxed{\blacktriangledown}$ to select ① “Set:”, and then press $\boxed{\text{EXE}}$.

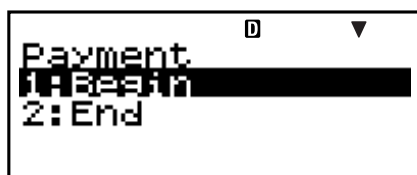

- Press $\boxed{2}$ to select “End”.
- Use $\boxed{\blacktriangle}$ $\boxed{\blacktriangledown}$ to select ② “PM1”, input 15, and then press $\boxed{\text{EXE}}$.

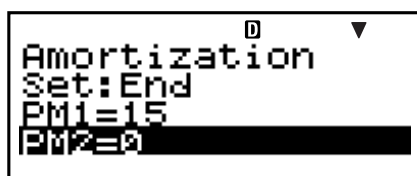

- Use $\boxed{\blacktriangle}$ $\boxed{\blacktriangledown}$ to select ③ “PM2”, input 28, and then press $\boxed{\text{EXE}}$.
- Use $\boxed{\blacktriangle}$ $\boxed{\blacktriangledown}$ to select ⑤ “I%”, input 2, and then press $\boxed{\text{EXE}}$.
- Use $\boxed{\blacktriangle}$ $\boxed{\blacktriangledown}$ to select ⑥ “PV”, input 100000, and then press $\boxed{\text{EXE}}$.
- Use $\boxed{\blacktriangle}$ $\boxed{\blacktriangledown}$ to select ⑦ “PMT”, input -920, and then press $\boxed{\text{EXE}}$.
- Use $\boxed{\blacktriangle}$ $\boxed{\blacktriangledown}$ to select ⑨ “P/Y”, input 12, and then press $\boxed{\text{EXE}}$.
- Use $\boxed{\blacktriangle}$ $\boxed{\blacktriangledown}$ to select ⑩ “C/Y”, input 12, and then press $\boxed{\text{EXE}}$.

2. Select the value you want to calculate.

- For this example, use \uparrow \downarrow to select “BAL: Solve”.

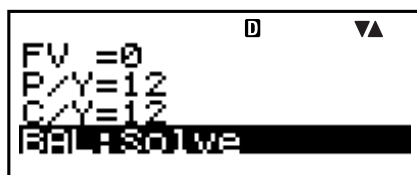

3. Press **SOLVE** to perform the calculation.

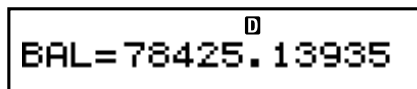

- Pressing the **ESC** key returns to the value input screen.

◆ Other AMRT Mode Calculations

Example 2: To calculate the interest amount (INT) included in payment 15 (PM1)

- In step 2 of the basic procedure (Example 1), select “INT:Solve”.

Example 3: To calculate the principal amount (PRN) included in payment 15 (PM1)

- In step 2 of the basic procedure (Example 1), select “PRN:Solve”.

Example 4: To calculate total interest paid (Σ INT) from payment 15 (PM1) to payment 28 (PM2)

- In step 2 of the basic procedure (Example 1), select “ Σ INT:Solve”.

Example 5: To calculate total principal paid (Σ PRN) from payment 15 (PM1) to payment 28 (PM2)

- In step 2 of the basic procedure (Example 1), select “ Σ PRN:Solve”.

◆ AMRT Mode Financial Calculation Variables (VARS)

- Variables PM1, PM2, n , I%, PV, PMT, FV, P/Y, and C/Y are used in the AMRT Mode.
- The values of AMRT Mode variables are retained even if you change to another mode. Note, however, that AMRT Mode variables are also used by other modes, so performing an input or calculation operation may change the values assigned to them.
- Though AMRT Mode variables are financial calculation variables, they are also used by arithmetic and function operations in the COMP Mode.

◆ Calculation Formulas

a: Interest portion of payment PM1 (INT)

$$INT_{PM1} = |BAL_{PM1-1} \times i| \times (PMT \text{ sign})$$

b: Principal portion of payment PM1 (PRN)

$$PRN_{PM1} = PMT + BAL_{PM1-1} \times i$$

c: Principal balance upon completion of payment PM2 (BAL)

$$BAL_{PM2} = BAL_{PM2-1} + PRN_{PM2}$$

d: Total principal paid from payment PM1 to payment PM2 (ΣPRN)

$$\sum_{PM1}^{PM2} PRN = PRN_{PM1} + PRN_{PM1+1} + \dots + PRN_{PM2}$$

e: Total interest paid from payment PM1 to payment PM2 (ΣINT)

• *a* + *b* = one repayment (PMT)

$$\sum_{PM1}^{PM2} INT = INT_{PM1} + INT_{PM1+1} + \dots + INT_{PM2}$$

$$BAL_0 = PV \dots \dots \dots \text{Payment: End} \\ \text{(Setup Screen)}$$

$$INT_1 = 0, PRN_1 = PMT \dots \text{Payment: Begin} \\ \text{(Setup Screen)}$$

■ Converting between the Nominal Interest Rate and Effective Interest Rate

The nominal interest rate (*I*% value input by user) is converted to an effective interest rate (*I*%') for installment loans where the number of annual payments is different from the number of annual compoundings calculation periods.

$$I\% ' = \left\{ \left(1 + \frac{I\%}{100 \times [C / Y]} \right)^{\frac{[C / Y]}{[P / Y]}} - 1 \right\} \times 100$$

The following calculation is performed after conversion from the nominal interest rate to the effective interest rate, and the result is used for all subsequent calculations.

$$i = I\% ' \div 100$$

■ Conversion Mode

• The Conversion (CNVR) Mode lets you convert between the nominal interest rate (APR) and effective interest rate (EFF).

◆ Entering the CNVR Mode

- Press **[CNVR]** to enter the CNVR Mode.

Value Input Screen

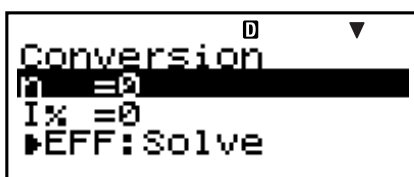

◆ Setting Values

No.	Display	Name	Values Used in Examples
①	n	Number of Annual Compoundings	6
②	I%	Interest Rate (Annual)	3%

◆ Basic CNVR Mode Procedure

Example 1: To convert a nominal interest rate (APR) to an effective interest rate (EFF)

1. Input the number of annual compoundings (n) and interest rate (I%) values from the Setting Values table above.

- For this example, use **▲ ▼** to select ① “ n ”, input 6, and then press **[EXE]**.

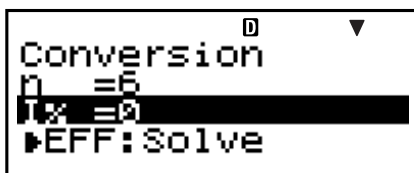

- Use **▲ ▼** to select ② “I%”, input 3, and then press **[EXE]**.

2. Select the value you want to calculate.

- For this example, use **▲ ▼** to select “EFF: Solve”.

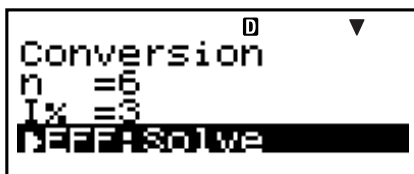

3. Press **[SOLVE]** to perform the calculation.

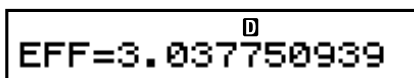

- Pressing the **[ESC]** key returns to the value input screen.

◆ Other CNVR Mode Calculations

Example 2: To convert an effective interest rate (EFF) to a nominal interest rate (APR)

- In step 2 of the basic procedure (Example 1), select “APR: Solve”.

◆ CNVR Mode Financial Calculation Variables (VARS)

- Variables n and $I\%$ are used in the CNVR Mode.
- A value is assigned to $I\%$ whenever you perform an EFF or APR calculation in the CNVR Mode.
- The values of CNVR Mode variables are retained even if you change to another mode. Note, however, that CNVR Mode variables are also used by other modes, so performing an input or calculation operation may change the values assigned to them.
- Though CNVR Mode variables are financial calculation variables, they are also used by arithmetic and function operations in the COMP Mode.

◆ Calculation Formulas

$$EFF = \left[\left(1 + \frac{APR/100}{n} \right)^n - 1 \right] \times 100$$

$$APR = \left[\left(1 + \frac{EFF}{100} \right)^{\frac{1}{n}} - 1 \right] \times n \times 100$$

APR : nominal interest rate (%)

EFF : effective interest rate (%)

n : number of annual compoundings

■ Cost/Sell/Margin Mode

- The Cost/Sell/Margin (COST) Mode lets you calculate cost, selling price, or margin after inputting the other two values. You can input the cost and selling price, for example, and calculate the margin.

◆ Entering the COST Mode

- Press **[COST]** to enter the COST Mode.

Value Input Screen

```

Cst/Sel/Mrg
CST=40
SEL=0
MRG=0
    
```

◆ Setting Values

No.	Display	Name	Values Used in Examples
①	CST	Cost	\$40
②	SEL	Selling Price	\$100
③	MRG	Margin	60%

◆ Basic COST Mode Procedure

Example 1: To calculate the margin (MRG)

1. Input the cost (CST) and selling price (SEL) values from the Setting Values table above.

- For this example, use **▲ ▼** to select ① “CST”, input 40, and then press **[EXE]**.

```

Cst/Sel/Mrg
CST=40
SEL=0
MRG=0
    
```

- Use **▲ ▼** to select ② “SEL”, input 100, and then press **[EXE]**.

2. Select the value you want to calculate.

- For this example, use **▲ ▼** to select ③ “MRG”.

```

Cst/Sel/Mrg
CST=40
SEL=100
MRG=0
    
```

3. Press **[SOLVE]** to perform the calculation.

```

Cst/Sel/Mrg
CST=40
SEL=100
MRG=60
    
```

◆ Other COST Mode Calculations

Example 2: To calculate the cost based on margin and selling price

1. Input the margin (MRG) and selling price (SEL) values in step 1 of the basic procedure (Example 1).
2. Select ① “CST” in step 2.

Example 3: To calculate the selling price (SEL) based on margin and cost

1. Input the margin (MRG) and cost (CST) values in step 1 of the basic procedure (Example 1).
2. Select ② “SEL” in step 2.

◆ COST Mode Financial Calculation Variables (VARS)

- Variables CST, SEL, and MRG are used in the COST Mode.
- These variables are used in the COST Mode only, and their values are retained even when you change to another mode.

◆ Calculation Formulas

$$CST = SEL \left(1 - \frac{MRG}{100}\right)$$

$$SEL = \frac{CST}{1 - \frac{MRG}{100}}$$

$$MRG(\%) = \left(1 - \frac{CST}{SEL}\right) \times 100$$

CST : cost

SEL : selling price

MRG : margin

■ Day Calculation Mode

- The Day Calculation (DAYS) Mode lets you calculate the number of dates from one date to another, the date that falls on a specific number of days after a starting date, and the date that falls on a specific number of data prior to an ending date.
- Starting date (d1) and ending date (d2) calculations are possible within the range of January 1, 1901 through December 31, 2099.

◆ Entering the DAYS Mode

- Press **[DAYS]** to enter the DAYS Mode.

Value Input Screen

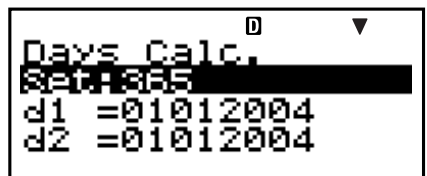

◆ Setting Values

No.	Display	Name	Values Used in Examples
①	Set* ¹	Days in Year (Date Mode)	365
②	d1* ²	Starting Date (Month, Day, Year)	11052004 (November 5, 2004)
③	d2* ²	Ending Date (Month, Day, Year)	04272005 (April 27, 2005)
④	Dys	Number of Days (Duration)	173

*¹ • For information about specifying the Date Mode, see the “Date Mode” item under “Configuring Settings” on page E-16.

- The following rules apply when a 360-day year is specified.

When the starting date (d1) is the 31st of a month, the calculation is performed using the 30th of the same month.

When the ending date (d2) is the 31st of a month, the calculation is performed using the 1st of the following month.

- *2 • You must input two digits for the month and day. This means you should include a leading zero for values from 1 through 9 (01, 02, 03... etc.).
- You can specify either month, day, year (MDY) or day, month, year (DMY) as the date input format. See the “Date Input” setting under “Configuring Settings” (page E-16).

Note

- After specifying the ① Days in Year (Date Mode) in the Day Calculation Mode, you can calculate any one of the following three values by inputting values for the other two: ② Starting Date (d1), ③ Ending Date (d2), and ④ Number of Days (Dys).

◆ Basic DAYS Mode Procedure

Example 1: To calculate the number of days between two dates

1. Input the required values from the Setting Values table (page E-64).

- For this example, use to select ① “Set:”, and then press **EXE**.

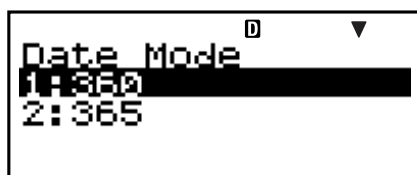

- Press **2** to select “365”.
- Use to select ② “d1”, input 11052004, and then press **EXE**.

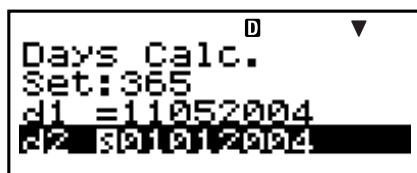

- Use to select ③ “d2”, input 04272005, and then press **EXE**.

2. Select the value you want to calculate.

- For this example, use to select “Dys”.

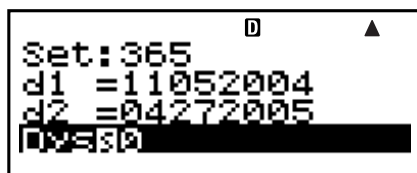

3. Press **SOLVE** to perform the calculation.

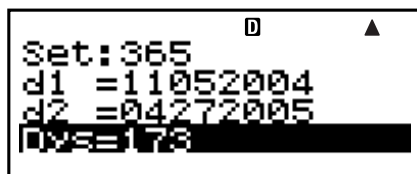

◆ Other DAYS Mode Calculations

Note

- For Example 2 and Example 3, use the setup screen to change the “Date Mode” setting to “365”.
- Calculation results “d1” and “d2” are not stored in Answer Memory.

Example 2: To calculate date that falls a specific number of days (Dys) from a starting date (d1)

1. In step 1 of the basic procedure (Example 1), input 173 for Dys and do not input anything for d2.
2. In step 2, select “d2”.

Example 3: To calculate the date that falls a specific number of days (Dys) before an ending date (d2)

1. In step 1 of the basic procedure (Example 1), input 173 for Dys and do not input anything for d1.
2. In step 2, select “d1”.

◆ DAYS Mode Financial Calculation Variables (VARS)

- Variables d1, d2, and Dys are used in the DAYS Mode.
- The values of DAYS Mode variables are retained even if you change to another mode. Note, however, that DAYS Mode variables are also used by other modes, so performing an input or calculation operation may change the values assigned to them.
- Though DAYS Mode variables are financial calculation variables, variable “Dys” can be recalled in the COMP Mode.

■ Depreciation Mode (FC-200V only)

- The Depreciation (DEPR) Mode lets you use any of the four methods for depreciation.

SL : Straight-Line Method

FP : Fixed Percentage Method

SYD : Sum-of-the-Year’s Digits Method

DB : Declining Balance Method

◆ Entering the DEPR Mode

- Press **[DEPR]** to enter the DEPR Mode.

Value Input Screen

Depreciation	
n	=0
$I\%$	=0
PV	=0

◆ Setting Values

No.	Display	Name	Values Used in Examples
①	n	Useful Life	6
②	$I\%^{*1}$	Depreciation Ratio	25%
		Factor	200
③	PV	Original Cost (Basis)	\$150,000
④	FV	Residual Book Value	\$0
⑤	j	Year for Calculation of Depreciation Cost	Year 3
⑥	$YR1$	Number of Months in the First Year of Depreciation	2

*¹ Depreciation ratio in the case of the fixed percent (FP) method, depreciation factor in the case of the declining balance (DB) method. Specifying 200 for the depreciation factor while declining balance (DB) depreciation is being calculated causes depreciation to be calculated using the double declining balance (DDB) method.

◆ Basic DEPR Mode Procedure

Example 1: To calculate depreciation using Straight-Line depreciation

1. Input the values for ①, ②, ③, ④, ⑤, and ⑥ from the Setting Values table above.

- For this example, use **▲ ▼** to select ① " n ", input 6, and then press **[EXE]**.

Depreciation	
n	=6
$I\%$	=0
PV	=0

- Use \blacktriangle \blacktriangledown to select ② “I%”, input 25, and then press $\boxed{\text{EXE}}$.
- Note that you need to input ② “I%” only when you are using the fixed percent (FP) or declining balance (DB) method.
- Use \blacktriangle \blacktriangledown to select ③ “PV”, input 150000, and then press $\boxed{\text{EXE}}$.
- Use \blacktriangle \blacktriangledown to select ④ “FV”, input 0, and then press $\boxed{\text{EXE}}$.
- Use \blacktriangle \blacktriangledown to select ⑤ “j”, input 3, and then press $\boxed{\text{EXE}}$.
- Use \blacktriangle \blacktriangledown to select ⑥ “YR1”, input 2, and then press $\boxed{\text{EXE}}$.

2. Select the value you want to calculate.

- For this example, use \blacktriangle \blacktriangledown to select “SL:Solve”.

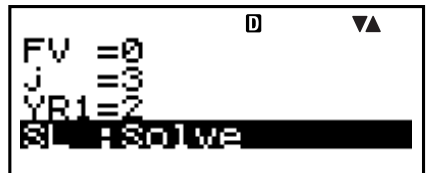

3. Press $\boxed{\text{SOLVE}}$ to perform the calculation.

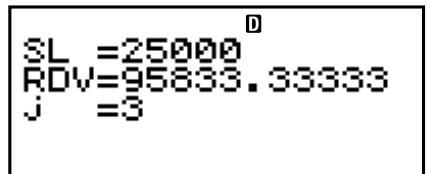

- Pressing the $\boxed{\text{ESC}}$ key returns to the value input screen.

◆ Other DEPR Mode Calculations

Example 2: To use the fixed percent method with a depreciation ratio is 25%

- In step 2 of the basic procedure (Example 1), select “FP: Solve”.

Example 3: To use the sum-of-the-year’s digits method

- In step 2 of basic procedure (Example 1), select “SYD:Solve”.

Example 4: To use the double declining balance method

1. In step 1 of the basic procedure (Example 1), input 200 for “I%”.
2. In step 2, select “DB:Solve”.

◆ DEPR Mode Financial Calculation Variables (VARS)

- Variables n , $I\%$, PV , and FV are used in the DEPR Mode.
- The values of DEPR Mode variables are retained even if you change to another mode. Note, however, that DEPR Mode variables are also used by other modes, so performing an input or calculation operation may change the values assigned to them.
- Though DEPR Mode variables are financial calculation variables, they are also used by arithmetic and function operations in the COMP Mode.

◆ Calculation Formulas

Depreciation for an item acquired part way through a year can be calculated by month.

• Straight-Line Method

The straight-line method calculates depreciation for a given period.

$$SL_1 = \frac{(PV-FV)}{n} \cdot \frac{YR1}{12}$$

$$SL_j = \frac{(PV-FV)}{n}$$

$$SL_{n+1} = \frac{(PV-FV)}{n} \cdot \frac{12-YR1}{12}$$

$$(YR1 \neq 12)$$

SL_j : depreciation charge for the j th year

n : useful life

PV : original cost (basis)

FV : residual book value

j : year for calculation of depreciation cost

$YR1$: number of months in the first year of depreciation

• **Fixed Percentage Method**

Fixed percentage method can be used to calculate depreciation for a given period, or to calculate the depreciation rate.

$$FP_1 = PV \times \frac{I\%}{100} \times \frac{YR1}{12}$$

$$FP_j = (RDV_{j-1} + FV) \times \frac{I\%}{100}$$

$$FP_{n+1} = RDV_n \quad (YR1 \neq 12)$$

$$RDV_1 = PV - FV - FP_1$$

$$RDV_j = RDV_{j-1} - FP_j$$

$$RDV_{n+1} = 0 \quad (YR1 \neq 12)$$

FP_j : depreciation charge for the j th year

RDV_j : remaining depreciable value at the end of j th year

$I\%$: depreciation ratio

• **Sum-of-the-Year's Digits Method**

The sum-of-the-year's-digits method calculates depreciation for a given period.

$$Z = \frac{n(n+1)}{2}$$

$$n' = n - \frac{YR1}{12}$$

$$Z' = \frac{(Intg(n') + 1)(Intg(n') + 2 \times Frac(n'))}{2}$$

$$SYD_1 = \frac{n}{Z} \times \frac{YR1}{12} (PV - FV)$$

$$SYD_j = \left(\frac{n' - j + 2}{Z'} \right) (PV - FV - SYD_1) \quad (j \neq 1)$$

$$SYD_{n+1} = \left(\frac{n' - (n+1) + 2}{Z'} \right) (PV - FV - SYD_1) \times \frac{12 - YR1}{12} \quad (YR1 \neq 12)$$

$$RDV_1 = PV - FV - SYD_1$$

$$RDV_j = RDV_{j-1} - SYD_j$$

SYD_j : depreciation charge for the j th year

RDV_j : remaining depreciable value at the end of j th year

• Declining Balance Method

The declining balance method calculates depreciation for a given period.

$$DB_1 = PV \times \frac{I\%}{100n} \times \frac{YR1}{12}$$

$$RDV_1 = PV - FV - DB_1$$

$$DB_j = (RDV_{j-1} + FV) \times \frac{I\%}{100n}$$

$$RDV_j = RDV_{j-1} - DB_j$$

$$DB_{n+1} = RDV_n \quad (YR1 \neq 12)$$

$$RDV_{n+1} = 0 \quad (YR1 \neq 12)$$

DB_j : depreciation charge for the j th year

RDV_j : remaining depreciable value at the end of j th year

$I\%$: factor

■ Bond Mode (FC-200V only)

- The Bond (BOND) Mode lets you calculate purchase price and annual yield.

◆ Entering the BOND Mode

- Press **[BOND]** to enter the BOND Mode.

Value Input Screen

Bond Calc.	
Set Annual Date	
d1	=01012004
d2	=01012004

◆ Setting Values

No.	Display	Name	Values Used in Examples
①	Set* ¹	Periods/Y	Annual
		Bond Date	Date
②	d1* ²	Purchase Date (Month, Day, Year)	06012004 (June 1, 2004)
③	d2* ^{2*3}	Redemption Date (Month, Day, Year)	12152006 (December 15, 2006)

No.	Display	Name	Values Used in Examples
④	n	Number of Coupon Payments Until Maturity	3
⑤	RDV* ⁴	Redemption Price per \$100 of face value	\$100
⑥	CPN* ⁵	Coupon Rate	3%
⑦	PRC* ⁶	Price per \$100 of face value	-97.61645734
⑧	YLD	Annual Yield	4%

- *¹ • You can specify a date (Date) or a number of coupon payments (Term) as the term for bond calculations. See the “Bond Date” setting under “Configuring Settings” (page E-16).
- You can specify once a year (Annual) or once every six months (Semi-Annual) as the number of coupon payments per year. See the “Periods/Y” setting under “Configuring Settings” (page E-16).
- *² • You must input two digits for the month and day. This means you should include a leading zero for values from 1 through 9 (01, 02, 03... etc.)
- You can specify either month, day, year (MDY) or day, month, year (DMY) as the date input format. See the “Date Input” setting under “Configuring Settings” (page E-16).
- *³ When calculating the yield on call, input the call date for d2.
- *⁴ When calculating the yield of maturity, input 100 for RDV.
- *⁵ In the case of a zero coupon, input 0 for CPN.
- *⁶ • When calculating the redemption price per \$100 of face value (PRC), you can also calculate accrued interest (INT) and purchase price including accrued interest (CST).
- Input money paid out as a negative value, using the  key to input the minus sign.

Note

- You can specify a starting date (d1) in the range of January 1, 1902 through December 30, 2097.
- You can specify an ending date (d2) in the range of January 2, 1902 through December 31, 2097.
- Input money paid out as a negative value, using the $\boxed{-}$ key to input the minus sign.

◆ Other Setup Items

- The initial setting of Date Mode is 365 (365-day year). See the “Date Mode” setting under “Configuring Settings” (page E-16).
- To display the Setup screen, press $\boxed{\text{SETUP}}$.

◆ Basic BOND Mode Procedure

Example 1: To calculate the bond purchase price (PRC) based on a specific date (Date)

1. Input the values required for the calculation from the Setting Values table (pages E-71, E-72). Input ①, ②, ③, ⑤, ⑥, and ⑧ if “Date” is selected for “Bond Date”, or ①, ④, ⑤, ⑥, and ⑧ if “Term” is selected for “Bond Date”. On the setup screen, specify “365” for the “Date Mode” setting.

- For this example, use $\boxed{\blacktriangle}$ $\boxed{\blacktriangledown}$ to select ① “Set:”, and then press $\boxed{\text{EXE}}$.



```
Periods/Year
Bond Date:Date
```

- Use $\boxed{\blacktriangle}$ $\boxed{\blacktriangledown}$ to select “Periods/Y”, and then press $\boxed{\text{EXE}}$.



```
Periods/Year
1:Annual
```

- Press $\boxed{1}$ to select “Annual”.
- Use $\boxed{\blacktriangle}$ $\boxed{\blacktriangledown}$ to select ① “Set:”, and then press $\boxed{\text{EXE}}$.
- Use $\boxed{\blacktriangle}$ $\boxed{\blacktriangledown}$ to select “Bond Date”, and then press $\boxed{\text{EXE}}$.



```
Bond Date
1:Date
```

- Press **[1]** to select “Date”.
- Use **[▲]** **[▼]** to select **(2)** “d1”, input 06012004, and then press **[EXE]**.

```

Bond Calc.
Set: Annu/Date
d1 = 06012004
d2 = 12152006
  
```

- Use **[▲]** **[▼]** to select **(3)** “d2”, input 12152006, and then press **[EXE]**.
- Use **[▲]** **[▼]** to select **(5)** “RDV”, input 100, and then press **[EXE]**.
- Use **[▲]** **[▼]** to select **(6)** “CPN”, input 3, and then press **[EXE]**.
- Use **[▲]** **[▼]** to select **(8)** “YLD”, input 4, and then press **[EXE]**.

2. Select the value you want to calculate.

- For this example, use **[▲]** **[▼]** to select “PRC”.

```

RDV=100
CPN=3
PRC=0
YLD=4
  
```

3. Press **[SOLVE]** to perform the calculation.

```

PRC=-97.61645734
INT=-1.385245902
CST=-99.00170324
  
```

- Pressing the **[ESC]** key returns to the value input screen.

◆ Other BOND Mode Calculations

- Before performing a calculation based on a specific number of payments (Term), be sure to specify “360” for “Date Mode”, and “Annual” for “Periods/Y” (number of coupon payments per year).

Example 2: To calculate the annual yield (YLD) based on a specific date (Date)

1. In step 1 of the basic procedure (Example 1), input -97.61645734 for PRC and do not input anything for YLD.
2. In step 2, select “YLD”.
 - Input money paid out as a negative value, using the **[(-)]** key to input the minus sign.

Example 3: To calculate a bond purchase price (PRC) based on a specific number of payments (Term)

1. In step 1 of the basic procedure (Example 1), select **2** (Term) for “Bond Date”.
 - This replaces input items d1 and d2 with input item n .
2. Input 3 for item n .

Example 4: To calculate the annual yield (YLD) based on a specific number of payments (Term)

1. In step 1 of the basic procedure (Example 1), select **2** (Term) for “Bond Date”.
 - This replaces input items d1 and d2 with input item n .
2. Use **▲ ▼** to select **4** “ n ”, input 3, and then press **EXE**.
3. Input -97.61645734 for PRC, without inputting anything for YLD.
4. In step 2, select “YLD”.

◆ BOND Mode Financial Calculation Variables (VARS)

- The values of the following BOND Mode variables are retained even if you change to another mode: n , d1, d2.
- Note, however, that n , d1, and d2 are also used by other modes, so performing an input or calculation operation may change the values assigned to them.
- Though n is a financial calculation variable, its contents can also be recalled in the COMP Mode.
- The following variables are used in the BOND Mode. Their values are not retained if you change to another mode: RDV, CPN, PRC, YLD.

◆ Calculation Formulas

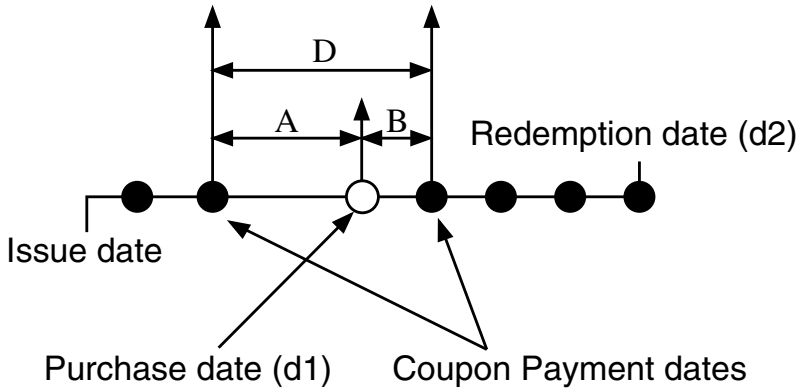

PRC : price per \$100 of face value

CPN : coupon rate (%)

YLD : annual yield (%)

A : accrued days

M : number of coupon payments per year
(1 = Annual, 2 = Semi-Annual)

N : number of coupon payments until maturity
(*n* is used when "Term" is specified for "Bond Date" on the setup screen.)

RDV : redemption price per \$100 of face value

D : number of days in coupon period where settlement occurs

B : number of days from purchase date until next coupon payment date = $D - A$

INT : accrued interest

CST : price including interest

• Price per \$100 of face value (PRC)

Date (Using the Setup Screen: Bond Date)

- For one or fewer coupon period to redemption

$$PRC = - \frac{RDV + \frac{CPN}{M}}{1 + \left(\frac{B}{D} \times \frac{YLD/100}{M} \right)} + \left(\frac{A}{D} \times \frac{CPN}{M} \right)$$

- For more than one coupon period to redemption

$$PRC = - \frac{RDV}{\left(1 + \frac{YLD/100}{M}\right)^{(N-1+B/D)}} - \sum_{k=1}^N \frac{\frac{CPN}{M}}{\left(1 + \frac{YLD/100}{M}\right)^{(k-1+B/D)}} + \frac{A}{D} \times \frac{CPN}{M}$$

$$INT = - \frac{A}{D} \times \frac{CPN}{M}$$

$$CST = PRC + INT$$

Term (Using the Setup Screen: Bond Date)

$$PRC = - \frac{RDV}{\left(1 + \frac{YLD/100}{M}\right)^n} - \sum_{k=1}^n \frac{\frac{CPN}{M}}{\left(1 + \frac{YLD/100}{M}\right)^k}$$

$$INT = 0$$

$$CST = PRC$$

• Annual Yield (YLD)

YLD is calculated using Newton's Method.

Note

- This calculator performs annual yield (YLD) calculations using Newton's Method, which produces approximate values whose precision can be affected by various calculation conditions. Because of this, annual yield calculation results produced by this calculator should be used keeping the above limitation in mind, or the results should be verified.

■ Break-Even Mode (FC-200V only)

- The Break-Even (BEVN) Mode has six sub-modes that you can use to perform various break-even point calculations.

◆ Entering the BEVN Mode

- Press **[BEVN]** to enter the BEVN Mode.

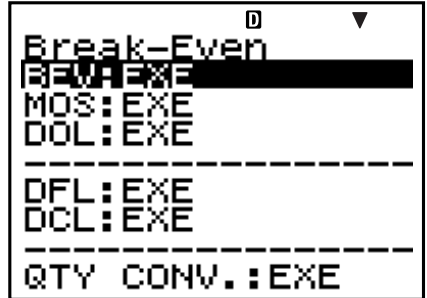

◆ BEVN Mode Sub-modes

BEV: Break-even point sales quantity and sales amount, sales quantity and sales amount that attains a profit target, sales quantity and sales amount that attains a profit ratio

MOS: Margin of Safety

DOL: Degree of Operating Leverage

DFL: Degree of Financial Leverage

DCL: Degree of Combined Leverage

QTY CONV. (Quantity Conversion):

Sales quantity and related values

- Use **[▲]** **[▼]** to select the sub-mode you want, and then press **[EXE]** to enter it.

■ BEV Sub-mode (Break-Even Mode 1)

- Use the BEV sub-mode to calculate the break-even point sales quantity and sales amount, sales quantity and sales amount that attains a profit target, and sales quantity and sales amount that attains a profit ratio.
- The “break-even point” is the point where profit is 0 or the profit ratio is 0%.

◆ Entering the BEV Sub-mode

1. Press **[BEVN]** to enter the Break-Even Mode.
2. Use **[▲]** **[▼]** to select “BEV:EXE”.



3. Press **[EXE]**.

Value Input Screen

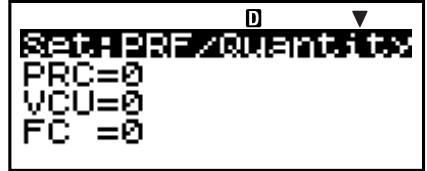

◆ Setting Values

No.	Display	Name	Values Used in Examples
①	Set* ¹	Profit or Profit Ratio (PRF/Ratio)	PRF (Profit)
		Sales Quantity or Sales Amount (B-Even)	Quantity (Sales Quantity)
②	PRC	Sales Price	\$100/unit
③	VCU	Unit Variable Cost	\$50/unit
④	FC	Fixed Cost	\$100,000
⑤	PRF* ²	Profit	\$400,000
	r%* ²	Profit Ratio	40%
⑥	QBE* ³	Sales Quantity	10,000 units
	SBE* ³	Sales Amount	\$1,000,000

- *¹
- You can configure break-even point calculations to use profit (PRF) or profit ratio (r%). See the “PRF/Ratio” setting under “Configuring Settings” (page E-16).
 - You can configure break-even point calculations to use sales quantity (Quantity) or sales amount (Sales). See the “B-Even” setting under “Configuring Settings” (page E-16).
- *² This item becomes profit ratio (r%) when “Ratio” is selected for “PRF/Ratio”.
- *³ This item becomes break-even sales amount (SBE) when “Sales” is selected for “B-Even”.

◆ Basic BEV Sub-mode Procedure

Example 1: To calculate the break-even point sales quantity (QBE)

1. Input the values for ①, ②, ③, ④, and ⑤ from the Setting Values table (page E-79).

- For this example, use \blacktriangle \blacktriangledown to select ① “Set:”, and then press **EXE**.

```

      0
PRF/RatioPRF
E-Even:Quantity
    
```

- Use \blacktriangle \blacktriangledown to select “PRF/Ratio”, and then press **EXE**.

```

      0
PRF/Ratio
1:PRF
2:r%
    
```

- Press **1** to select “PRF”.

- Use \blacktriangle \blacktriangledown to select ① “Set:”, and then press **EXE**.

- Use \blacktriangle \blacktriangledown to select “B-Even”, and then press **EXE**.

```

      0
E-Even
1:Quantity
2:Sales
    
```

- Press **1** to select “Quantity”.

- Use \blacktriangle \blacktriangledown to select ② “PRC”, input 100, and then press **EXE**.

```

      0
Set:PRF/Quantity
PRC=100
VCU=50
FC =0
    
```

- Use \blacktriangle \blacktriangledown to select ③ “VCU”, input 50, and then press **EXE**.

- Use \blacktriangle \blacktriangledown to select ④ “FC”, input 100000, and then press **EXE**.

- Use \blacktriangle \blacktriangledown to select ⑤ “PRF” or “r%”, input 0, and then press **EXE**.

2. Select the value you want to calculate.

- For this example, use \blacktriangle \blacktriangledown to select ⑥ “QBE”.

```

      0
VCU=50
FC =100000
PRF=0
QBE=50
    
```

3. Press **SOLVE** to perform the calculation.

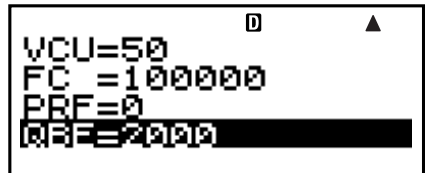

A calculator display showing the following values: VCU=50, FC=100000, PRF=0, and QBE=2000. The QBE=2000 line is highlighted with a black background.

◆ Other BEV Sub-mode Calculations

Example 2: To calculate the break-even point sales amount (SBE)

1. Select **2** (Sales) for “B-Even” in step 1 of the basic procedure (Example 1).
2. In step 2, select “SBE”.

Example 3: To calculate the sales quantity (QBE) required to attain a profit target (\$400,000)

- Input 400000 for PRF in step 1 of the basic procedure (Example 1).

Example 4: To calculate the sales amount (SBE) required to attain a profit target (\$400,000)

1. Select **2** (Sales) for “B-Even” and input 400000 for PRF in step 1 of the basic procedure (Example 1).
2. In step 2, select “SBE”.

Example 5: To calculate the sales quantity (QBE) required to attain a profit ratio target (40%)

- Select **2** ($r\%$) for “PRF/Ratio” and input 40 for $r\%$ in step 1 of the basic procedure (Example 1).

Example 6: To calculate the sales amount (SBE) required to attain a profit ratio target (40%)

1. Select **2** ($r\%$) for “PRF/Ratio” and **2** (Sales) for “B-Even”, and input 40 for $r\%$ in step 1 of the basic procedure (Example 1).
2. In step 2, select “SBE”.

Example 7: To calculate other values besides sales quantity and sales amount

- You can calculate any one of the following five values by inputting values the other four: **2** Sales Price, **3** Unit Variable Cost, **4** Fixed Cost, **5** Profit or Profit Ratio, **6** Sales Quantity or Sales Amount.

◆ BEV Sub-mode Financial Calculation Variables (VARS)

- Variables PRC, VCU, FC, PRF, $r\%$, QBE, and SBE are used in the BEV sub-mode.
- BEV sub-mode variable contents are cleared whenever you change to another mode other than the BEVN Mode sub-modes (BEV, MOS, DOL, DFL, DCL, QTY CONV.).

◆ Calculation Formulas

- Profit (Setup Screen PRF/Ratio Setting: PRF)

$$QBE = \frac{FC + PRF}{PRC - VCU}$$

$$SBE = \frac{FC + PRF}{PRC - VCU} \times PRC$$

- Profit Ratio (Setup Screen PRF/Ratio Setting: $r\%$)

$$QBE = \frac{FC}{PRC \times \left(1 - \frac{r\%}{100}\right) - VCU}$$

$$SBE = \frac{FC}{PRC \times \left(1 - \frac{r\%}{100}\right) - VCU} \times PRC$$

QBE : Sales Quantity

FC : Fixed Cost

PRF : Profit

PRC : Sales Price

VCU : Unit Variable Cost

SBE : Sales Amount

$r\%$: Profit Ratio

■ Margin of Safety Sub-mode (Break-Even Mode 2)

- The Margin of Safety (MOS) sub-mode lets you calculate how much sales can be reduced before losses start to be sustained, in the case that the expected sales amount is not attained.

◆ Entering the MOS Sub-mode

1. Press **[BEVN]** to enter the Break-Even Mode.
2. Use **[▲]** **[▼]** to select “MOS:EXE”.



3. Press **[EXE]**.

Value Input Screen

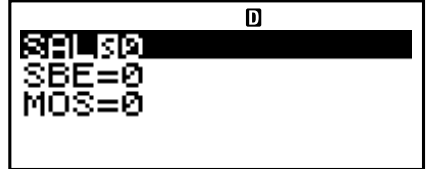

◆ Setting Values

No.	Display	Name	Values Used in Examples
①	SAL	Sales Amount	\$1,200,000
②	SBE	Break-even Sales Amount	\$1,000,000
③	MOS	Margin of Safety	0.1667(16.67%)

◆ Basic MOS Sub-mode Procedure

Example 1: To calculate the margin of safety (MOS)

1. Input the required values from the Setting Values table above.

- For this example, use **[▲]** **[▼]** to select ① “SAL”, input 1200000, and then press **[EXE]**.



- Use **[▲]** **[▼]** to select ② “SBE”, input 1000000, and then press **[EXE]**.

2. Select the value you want to calculate.

- For this example, use **[▲]** **[▼]** to select ③ “MOS”.

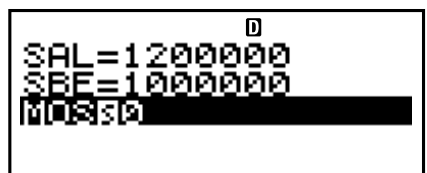

3. Press **[SOLVE]** to perform the calculation.

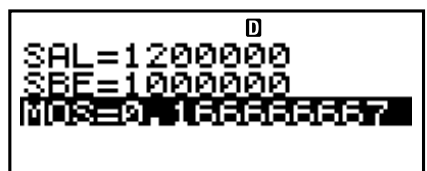

◆ Other MOS Sub-mode Calculations

Example 2: To calculate a sales amount (SAL) or break-even sales amount (SBE)

- Use the basic procedure (Example 1), substituting the required values.

◆ MOS Sub-mode Financial Calculation Variables (VARs)

- Variables SAL, SBE, and MOS are used in the MOS sub-mode.
- MOS sub-mode variable contents are cleared whenever you change to another mode other than the BEVN Mode sub-modes (BEV, MOS, DOL, DFL, DCL, QTY CONV.).

◆ Calculation Formula

$$MOS = \frac{SAL - SBE}{SAL}$$

SAL : Sales Amount

SBE : Break-even Sales Amount

MOS: Margin of Safety

■ Degree of Operating Leverage Sub-mode (Break-Even Mode 3)

- The Degree of Operating Leverage (DOL) sub-mode lets you calculate how profit changes relative to a change in the sales amount.

◆ Entering the DOL Sub-mode

1. Press **[BEVN]** to enter the Break-Even Mode.

2. Use **▲ ▼** to select "DOL:EXE".



3. Press **[EXE]**.

Value Input Screen

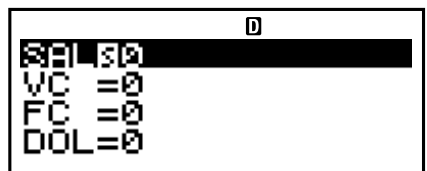

◆ Setting Values

No.	Display	Name	Values Used in Examples
①	SAL	Sales Amount	\$1,200,000
②	VC	Variable Cost	\$600,000
③	FC	Fixed Cost	\$200,000
④	DOL	Degree of Operating Leverage	1.5

◆ Basic DOL Sub-mode Procedure

Example 1: To calculate the degree of operating leverage (DOL)

1. Input the required values from the Setting Values table above.

- For this example, use \blacktriangle \blacktriangledown to select ① “SAL”, input 1200000, and then press $\boxed{\text{EXE}}$.

A calculator display showing the input of SAL. The screen displays: SAL=1200000, VC=0, FC=0, and DOL=0. The VC=0 line is highlighted with a black bar.

- Use \blacktriangle \blacktriangledown to select ② “VC”, input 600000, and then press $\boxed{\text{EXE}}$.
- Use \blacktriangle \blacktriangledown to select ③ “FC”, input 200000, and then press $\boxed{\text{EXE}}$.

2. Select the value you want to calculate.

- For this example, use \blacktriangle \blacktriangledown to select ④ “DOL”.

A calculator display showing the input of VC and FC. The screen displays: SAL=1200000, VC=600000, FC=200000, and DOL=0. The DOL=0 line is highlighted with a black bar.

3. Press $\boxed{\text{SOLVE}}$ to perform the calculation.

A calculator display showing the final result. The screen displays: SAL=1200000, VC=600000, FC=200000, and DOL=1.5. The DOL=1.5 line is highlighted with a black bar.

◆ Other DOL Sub-mode Calculations

Example 2: To calculate the sales amount (SAL), variable cost (VC), and fixed cost (FC)

- Use the basic procedure (Example 1), substituting the required values.

◆ DOL Sub-mode Financial Calculation Variables (VARs)

- Variables SAL, VC, FC, and DOL are used in the DOL sub-mode.
- DOL sub-mode variable contents are cleared whenever you change to another mode other than the BEVN Mode sub-modes (BEV, MOS, DOL, DFL, DCL, QTY CONV.).

◆ Calculation Formula

$$DOL = \frac{SAL - VC}{SAL - VC - FC}$$

SAL : Sales Amount

VC : Variable Cost

FC : Fixed Cost

DOL: Degree of Operating Leverage

■ Degree of Financial Leverage Sub-mode (Break-Even Mode 4)

- The Degree of Financial Leverage (DFL) sub-mode lets you calculate the influence of interest on earnings before interest and taxes (EBIT).

◆ Entering the DFL Sub-mode

1. Press **[BEVN]** to enter the Break-Even Mode.
2. Use **[▲]** **[▼]** to select "DFL:EXE".

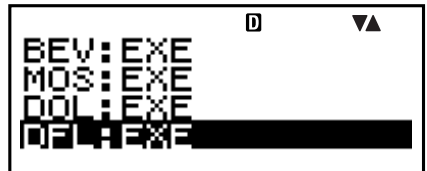

3. Press **[EXE]**.

Value Input Screen

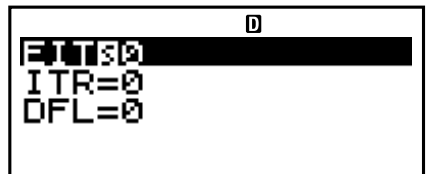

◆ Setting Values

No.	Display	Name	Values Used in Examples
①	EIT	Earnings Before Interest and Taxes (EBIT)	\$400,000
②	ITR	Interest	\$80,000
③	DFL	Degree of Financial Leverage	1.25

◆ Basic DFL Sub-mode Procedure

Example 1: To calculate the degree of financial leverage (DFL)

1. Input the required values from the Setting Values table (page E-86).

- For this example, use \blacktriangle \blacktriangledown to select ① “EIT”, input 400000, and then press $\boxed{\text{EXE}}$.

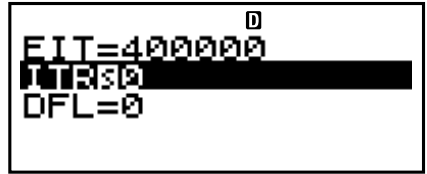

EIT=400000⁰
ITR=80000
DFL=0

- Use \blacktriangle \blacktriangledown to select ② “ITR”, input 80000, and then press $\boxed{\text{EXE}}$.

2. Select the value you want to calculate.

- For this example, use \blacktriangle \blacktriangledown to select ③ “DFL”.

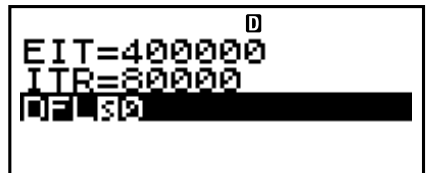

EIT=400000⁰
ITR=80000
DFL=0

3. Press $\boxed{\text{SOLVE}}$ to perform the calculation.



EIT=400000⁰
ITR=80000
DFL=1.25

◆ Other DFL Sub-mode Calculations

Example 2: To calculate earnings before interest and taxes (EBIT), and interest (ITR)

- Use the basic procedure (Example 1), substituting the required values.

◆ DFL Sub-mode Financial Calculation Variables (VARS)

- Variables EIT, ITR, and DFL are used in the DFL sub-mode.
- DFL sub-mode variable contents are cleared whenever you change to another mode other than the BEVN Mode sub-modes (BEV, MOS, DOL, DFL, DCL, QTY CONV.).

◆ Calculation Formula

$$DFL = \frac{EIT}{EIT - ITR}$$

EIT : Earnings Before Interest and Taxes (EBIT)

ITR : Interest

DFL : Degree of Financial Leverage

■ Degree of Combined Leverage Sub-mode (Break-Even Mode 5)

- The Degree of Combined Leverage (DCL) sub-mode lets you calculate the degree of operating leverage (percent change in profit due to a change in sales amount), with interest taken into consideration.

◆ Entering the DCL Sub-mode

1. Press **[BEVN]** to enter the Break-Even Mode.

2. Use **▲** **▼** to select
“DCL:EXE”.

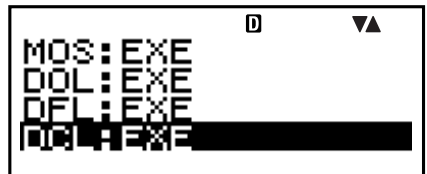

3. Press **[EXE]**.

Value Input Screen

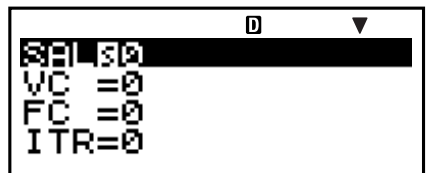

◆ Setting Values

No.	Display	Name	Values Used in Examples
①	SAL	Sales Amount	\$1,200,000
②	VC	Variable Cost	\$600,000
③	FC	Fixed Cost	\$200,000
④	ITR	Interest	\$100,000
⑤	DCL	Degree of Combined Leverage	2

◆ Basic DCL Sub-mode Procedure

Example 1: To calculate the degree of combined leverage (DCL)

1. Input the required values from the Setting Values table (page E-88).

- For this example, use \blacktriangle \blacktriangledown to select ① “SAL”, input 1200000, and then press $\boxed{\text{EXE}}$.

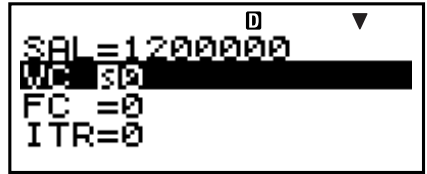

A calculator screen showing the following values: SAL = 1200000, VC = 50, FC = 0, and ITR = 0. The cursor is positioned at the end of the SAL line.

- Use \blacktriangle \blacktriangledown to select ② “VC”, input 600000, and then press $\boxed{\text{EXE}}$.
- Use \blacktriangle \blacktriangledown to select ③ “FC”, input 200000, and then press $\boxed{\text{EXE}}$.
- Use \blacktriangle \blacktriangledown to select ④ “ITR”, input 100000, and then press $\boxed{\text{EXE}}$.

2. Select the value you want to calculate.

- For this example, use \blacktriangle \blacktriangledown to select ⑤ “DCL”.

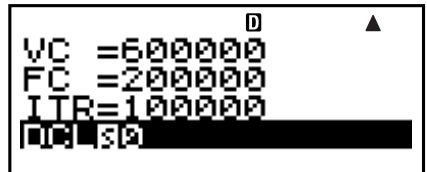

A calculator screen showing the following values: VC = 600000, FC = 200000, ITR = 100000, and DCL = 50. The cursor is positioned at the end of the DCL line.

3. Press $\boxed{\text{SOLVE}}$ to perform the calculation.

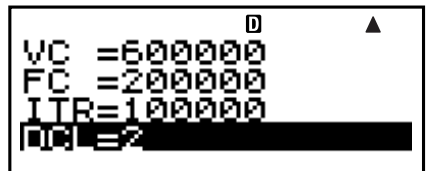

A calculator screen showing the following values: VC = 600000, FC = 200000, ITR = 100000, and DCL = 2. The cursor is positioned at the end of the DCL line.

◆ Other DCL Sub-mode Calculations

Example 2: To calculate the sales amount (SAL), variable cost (VC), fixed cost (FC), and interest (ITR)

- Use the basic procedure (Example 1), substituting the required values.

◆ DCL Sub-mode Financial Calculation Variables (VARS)

- Variables SAL, VC, FC, ITR, and DCL are used in the DCL sub-mode.
- DCL sub-mode variable contents are cleared whenever you change to another mode other than the BEVN Mode sub-modes (BEV, MOS, DOL, DFL, DCL, QTY CONV.).

◆ Calculation Formula

$$DCL = \frac{SAL - VC}{SAL - VC - FC - ITR}$$

SAL : Sales Amount

VC : Variable Cost

FC : Fixed Cost

ITR : Interest

DCL : Degree of Combined Leverage

■ Quantity Conversion Sub-mode (Break-Even Mode 6)

- The Quantity Conversion (QTY CONV.) sub-mode lets you calculate the sales amount, sales price, or sales quantity after inputting the other two values.
- You can also calculate the variable cost, unit variable cost, or sales quantity after inputting the other two values.

◆ Entering the QTY CONV. Sub-mode

1. Press **[BEVN]** to enter the Break-Even Mode.
2. Use **[▲]** **[▼]** to select “QTY CONV.:EXE”.
3. Press **[EXE]**.



Value Input Screen

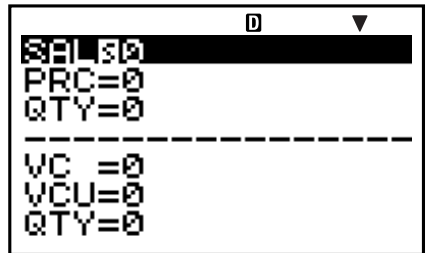

◆ Setting Values

No.	Display	Name	Values Used in Examples
①	SAL	Sales Amount	\$100,000
②	PRC	Sales Price	\$200/unit
③	QTY	Sales Quantity	500 units
④	VC	Variable Cost	\$15,000
⑤	VCU	Unit Variable Cost	\$30/unit
⑥	QTY	Sales Quantity	500 units

◆ Basic QTY CONV. Sub-mode Procedure

Example 1: To calculate the sales quantity (QTY) from the sales amount and sales price

1. Input the required values from among ①, ②, and ③ in the Setting Values table above.

- In this example, use \blacktriangle \blacktriangledown to select ① “SAL”, input 100000, and then press $\boxed{\text{EXE}}$.

A calculator display showing the following values: SAL=100000, PRC=200, and QTY=0. The display is in a sub-mode with a small 'D' in the top right corner and a downward arrow. A dashed line is at the bottom.

- Use \blacktriangle \blacktriangledown to select ② “PRC”, input 200, and then press $\boxed{\text{EXE}}$.

2. Select the value you want to calculate.

- In this example, use \blacktriangle \blacktriangledown to select ③ “QTY”.

A calculator display showing the following values: SAL=100000, PRC=200, and QTY=500. The display is in a sub-mode with a small 'D' in the top right corner and a downward arrow. A dashed line is at the bottom.

3. Press $\boxed{\text{SOLVE}}$ to perform the calculation.

A calculator display showing the following values: SAL=100000, PRC=200, and QTY=500. The display is in a sub-mode with a small 'D' in the top right corner and a downward arrow. A dashed line is at the bottom.

- The result of a ③ “QTY” (sales quantity) calculation is also assigned to variable ⑥ “QTY”.

Example 2: To calculate the sales amount (SAL) and sales price (PRC)

- Use the same procedure as Example 1, substituting the required values.

Example 3: To calculate the sales quantity (QTY) from variable cost and unit variable cost

1. Input the required values from among ④, ⑤, and ⑥ in the Setting Values table (page E-91).

- In this example, use \blacktriangle \blacktriangledown to select ④ “VC”, input 15000, and then press $\boxed{\text{EXE}}$.

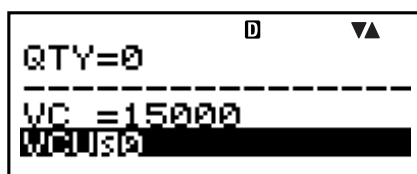

Calculator screen showing: QTY=0, VC=15000, VCU=30. The cursor is positioned at the end of the VCU=30 line.

- Use \blacktriangle \blacktriangledown to select ⑤ “VCU”, input 30, and then press $\boxed{\text{EXE}}$.

2. Select the value you want to calculate.

- In this example, use \blacktriangle \blacktriangledown to select ⑥ “QTY”.

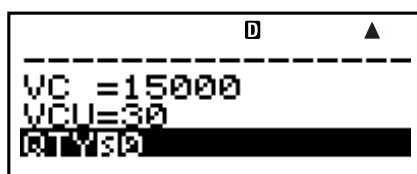

Calculator screen showing: VC=15000, VCU=30, QTY=30. The cursor is positioned at the end of the QTY=30 line.

3. Press $\boxed{\text{SOLVE}}$ to perform the calculation.

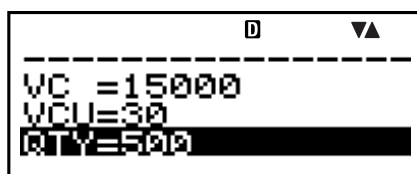

Calculator screen showing: VC=15000, VCU=30, QTY=500. The cursor is positioned at the end of the QTY=500 line.

- The result of a ⑥ “QTY” (sales quantity) calculation is also assigned to variable ③ “QTY”.

Example 4: To calculate the variable cost (VC) and unit variable cost (VCU)

- Use the same procedure as Example 3, substituting the required values.

◆ QTY CONV. Sub-mode Financial Calculation Variables (VARS)

- Variables SAL, PRC, QTY, VC, and VCU are used in the QTY CONV. sub-mode.
- QTY CONV. sub-mode variable contents are cleared whenever you change to another mode other than the BEVN Mode sub-modes (BEV, MOS, DOL, DFL, DCL, QTY CONV.).

◆ Calculation Formulas

$$SAL = PRC \times QTY$$

$$VC = VCU \times QTY$$

SAL : Sales Amount

PRC : Sales Price

QTY : Sales Quantity

VC : Variable Cost

VCU : Unit Variable Cost

Shortcuts

■ Custom Shortcut Keys

You can assign a mode, setup information, a value, or a calculation expression to a shortcut key for instant access whenever you need it. This feature comes in handy when you need to often perform the same calculation or input the same data.

◆ Using Shortcut Keys

Example: To configure the shortcut keys to simplify calculation of the value of the following installment savings plan

Compound annual interest rate (I%): 3%
Payment period (Payment): End
Initial deposit (PV): -\$1,000
Monthly deposit (PMT): -\$50
Number of annual payments (P/Y): 12
Number of annual compoundings (C/Y): 12

Tax on interest (10%)

● To configure the SHORTCUT1 key

1. Press **[CMPD]** to enter the Compound Interest Mode.
2. Input the applicable values for Payment, I%, PV, PMT, P/Y, and C/Y.
 - See “Compound Interest Mode” (page E-44) for more information.
3. Use **▲** **▼** to select “n”.

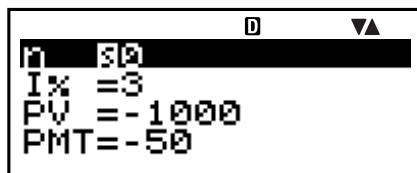

```
          D  ▼▲
n  50
I% = 3
PV = -1000
PMT = -50
```

4. Press **[SHIFT]** **[RCL]** (STO).
 - A number sign (#) next to “Shortcut1” or “Shortcut2” indicates that there is already data assigned to the key. Performing the following steps will replace any existing data with the new data.

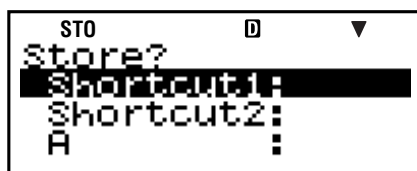

```
          D  ▼
STO
Store?
Shortcut1:
Shortcut2:
A          :
```

- Use \blacktriangle \blacktriangledown to select “Shortcut1”, and then press $\boxed{\text{EXE}}$.

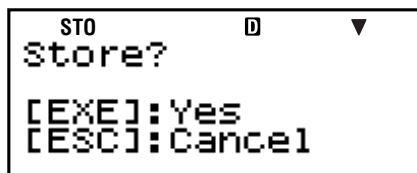

- In response to the confirmation screen that appears, press $\boxed{\text{EXE}}$ (Yes).
 - If you want to cancel this operation without assigning anything to $\boxed{\text{SHORTCUT1}}$ (Shortcut1) key, press $\boxed{\text{ESC}}$ instead of $\boxed{\text{EXE}}$ in step 6.

• **To configure the SHORTCUT2 key**

- Press $\boxed{\text{COMP}}$ to enter the COMP Mode.
- Input the formula shown below.

$$\frac{(FV - ((-PV) + (-PMT) \times n)) \times 0.9 + ((-PV) + (-PMT) \times n)}{0.9 + ((-PV) + (-PMT) \times n)}$$

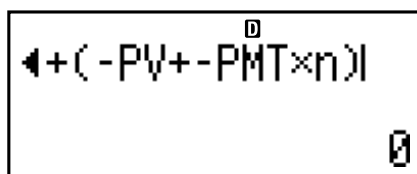

- “FV”, “PV” and “n” are financial calculation variables (VARS).
- Perform the same operation as steps 4, 5, and 6 under “To configure the SHORTCUT1 key” to assign the above formula to “Shortcut2”.

• **To use the configured shortcut keys in a calculation**

Example: To calculate the value of the savings plan after five years ($n = 60$ months)

- Press $\boxed{\text{SHORTCUT1}}$ (Shortcut1).
 - This enters the mode (CMPD) and configures the settings assigned to the $\boxed{\text{SHORTCUT1}}$ (Shortcut1) key, and selects “n” for input.

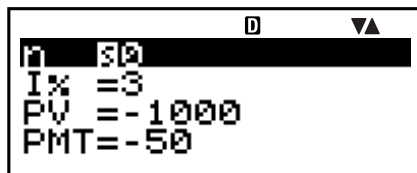

- Input 60, and then press $\boxed{\text{EXE}}$.
 - Since all other input is performed by the data assigned to the $\boxed{\text{SHORTCUT1}}$ (Shortcut1) key, this is the only input required. To calculate the value for a different length of time, simply input the applicable number of months.

- Use \blacktriangle \blacktriangledown to select “FV”, and then press $\boxed{\text{SOLVE}}$ to perform the calculation.
 - This calculates the future value of the investment after five years. The result appears on the display and is stored in Answer Memory (Ans).

I% = 3
 PV = -1000
 PMT = -50
 FV = 4354.557171

- Press $\boxed{\text{SHORT CUT 2}}$ (Shortcut2).
 - This recalls the formula (for calculating tax) assigned to the $\boxed{\text{SHORT CUT 2}}$ (Shortcut2) key.

$\blacktriangleleft + (-PV + -PMT \times n) |$

- Press $\boxed{\text{EXE}}$.
 - Pressing the $\boxed{\text{EXE}}$ key calculates the net amount received after application of a 10% tax to the interest amount.

$\blacktriangleleft ((FV - (-PV + -PMT \times n) \times 0.1)$
 4354.557171

◆ Initializing the Custom Shortcut Settings

- $\boxed{\text{ON}}$ $\boxed{\text{SHIFT}}$ $\boxed{9}$ (CLR)
- “Shortcut:EXE” (\blacktriangle \blacktriangledown), then $\boxed{\text{EXE}}$.
- $\boxed{1}$ (Shortcut1) or $\boxed{2}$ (Shortcut2)
- $\boxed{\text{AC}}$

Note

- STAT Mode data and operations cannot be assigned to the custom shortcut keys in the STAT Mode.
- In the CASH Mode, you cannot assign receipt and payment amounts (for input on the value input screen) to custom shortcut keys.
- Calculation history memory contents (page E-33) cannot be assigned to a shortcut key.
- Contrast data and operations cannot be assigned to the custom shortcut keys.

■ Function Shortcut Keys

In the COMP Mode, the $\boxed{\text{SHORT CUT 1}}$ (Shortcut1) and $\boxed{\text{SHORT CUT 2}}$ (Shortcut2) keys become “function shortcut” keys named “FMEM1” and “FMEM2”.

• To configure an FMEM key

Example: To assign the function “ \sin^{-1} ” to the FMEM1 key

1. Press **[COMP]** to enter the COMP Mode.

2. (1) **[CTLG]**

(2) “ \sin^{-1} ” (**[▲]** **[▼]**), then **[EXE]**.

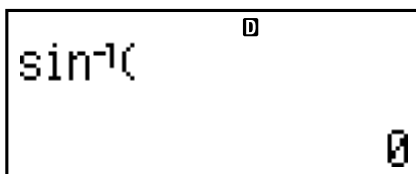

3. Press **[SHIFT]** **[RCL]** (STO).

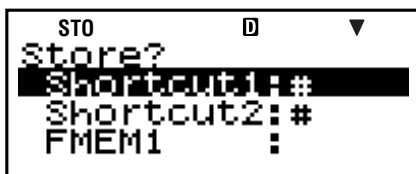

- A number sign (#) next to “FMEM1” or “FMEM2” indicates that there is already data assigned to the key. Performing the following steps will replace any existing data with the new data.

4. Use **[▲]** **[▼]** to select “FMEM1”, and then press **[EXE]**.

5. In response to the confirmation screen that appears, press **[EXE]** (Yes).

- If you want to cancel this operation without assigning anything to the FMEM1 key, press **[ESC]** instead of **[EXE]** in step 5.

• To use the configured function memory key in a calculation

Example: To recall the inverse sin function assigned to the FMEM1 key

• Press **[SHIFT]** **[SHORT CUT 1]** (FMEM1).

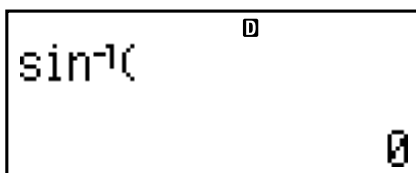

◆ Initializing the Function Shortcut Settings

1. **[ON]** **[SHIFT]** **[9]** (CLR)

2. “FMEM:EXE” (**[▲]** **[▼]**), then **[EXE]**.

3. **[1]** (FMEM1) or **[2]** (FMEM2)

4. **[AC]**

Function Calculations

This section explains how to use the calculator's built-in functions.

- Certain function calculations may take some time to display calculation results. Before performing an operation, be sure to wait until execution of the current operation is complete. You can interrupt an ongoing operation by pressing **[AC]**.
- Pressing **[CTLG]** will display a menu of functions that you can use to select the one you want to input. You can also use a direct key operation to input the following functions.

FC-200V

Rnd(, sin(, cos(, tan(, x^2 , $\sqrt{\quad}$ (, \wedge (, e^{\wedge} (, ln(

FC-100V

Rnd(, sin(, cos(, tan(, e^{\wedge} (, 10^{\wedge} (, \wedge (, ln(, log(, $x\sqrt{\quad}$ (

All calculations in this section are performed in the COMP Mode (**[COMP]**).

■ Pi (π) and Natural Logarithm Base e

You can input pi (π) or natural logarithm base e into a calculation. The following shows the required key operations and the values this calculator uses for pi (π) and e .

$$\pi = 3.14159265358980 \text{ ([SHIFT] [x10^x] (\pi))}$$

$$e = 2.71828182845904 \text{ ([ALPHA] [x10^x] (e))}$$

■ Trigonometric and Inverse Trigonometric Functions

The angle unit required by trigonometric and inverse trigonometric functions is one specified as the calculator's default angle unit. Before performing a calculation, be sure to specify the default angle unit you want to use. See "Configuring Settings" (page E-16) for more information.

Example: $\sin 30 = 0.5$, $\sin^{-1}0.5 = 30$

Deg

SHIFT **1** (sin) **3** **0** **)** **EXE**

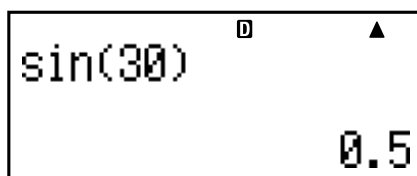

Calculator display showing the calculation of $\sin(30)$. The screen displays "sin(30)" and the result "0.5".

1. **CTLG**

2. “ \sin^{-1} ” (**▲** **▼**), then **EXE**.

3. **0** **.** **5** **)** **EXE**

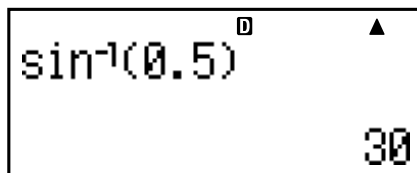

Calculator display showing the calculation of $\sin^{-1}(0.5)$. The screen displays "sin⁻¹(0.5)" and the result "30".

■ Hyperbolic and Inverse Hyperbolic Functions

Example: $\sinh 1 = 1.175201194$, $\cosh^{-1} 1 = 0$

1. **CTLG**

2. “sinh” (**▲** **▼**), then **EXE**.

3. **1** **)** **EXE**

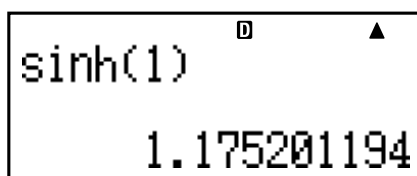

Calculator display showing the calculation of $\sinh(1)$. The screen displays "sinh(1)" and the result "1.175201194".

1. **CTLG**

2. “ \cosh^{-1} ” (**▲** **▼**), then **EXE**.

3. **1** **)** **EXE**

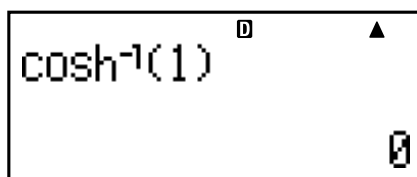

Calculator display showing the calculation of $\cosh^{-1}(1)$. The screen displays "cosh⁻¹(1)" and the result "0".

■ Converting an Input Value to the Calculator’s Default Angle Unit

After inputting a value, press **SHIFT** **Ans** (**DRG** **▶**) to display the angle unit specification menu shown below. Press the number key that corresponds to the angle unit of the input value. The calculator will automatically convert it to the calculator’s default angle unit.

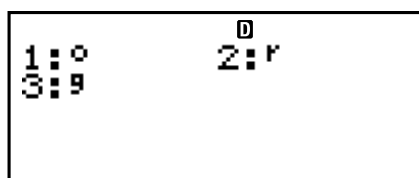

Angle unit specification menu showing options: 1:°, 2:r, 3:g.

Example 1: To convert the following values to degrees:

$$\frac{\pi}{2} \text{ radians} = 90^\circ, 50 \text{ grads} = 45^\circ$$

The following procedure assumes that the calculator’s default angle unit is degrees.

Deg

() SHIFT $\times 10^x$ (π) \div 2)
SHIFT Ans (DRG▶) 2 (r) EXE

$(\pi \div 2)^r$
90

5 0 SHIFT Ans (DRG▶)
3 (g) EXE

50^g
45

Example 2: $\cos(\pi \text{ radians}) = -1$, $\cos(100 \text{ grads}) = 0$

Deg

SHIFT 2 (cos) SHIFT $\times 10^x$ (π)
SHIFT Ans (DRG▶) 2 (r)) EXE

$\cos(\pi^r)$
-1

SHIFT 2 (cos) 1 0 0
SHIFT Ans (DRG▶) 3 (g)) EXE

$\cos(100^g)$
0

Example 3: $\cos^{-1}(-1) = 180$

$$\cos^{-1}(-1) = \pi$$

Deg

1. CTLG
2. “ \cos^{-1} ” (\blacktriangle \blacktriangledown), then EXE.
3. (←) 1) EXE

$\cos^{-1}(-1)$
180

Rad

1. CTLG
2. “ \cos^{-1} ” (\blacktriangle \blacktriangledown), then EXE.
3. (←) 1) EXE

$\cos^{-1}(-1)$
3.141592654

■ Exponential Functions and Logarithmic Functions

- For the logarithmic function “log(”, you can specify base m using the syntax “log(m, n)”.
If you input only a single value, a base of 10 is used for the calculation.
- “ln(” is a natural logarithm function with base e .

Example 1: $\log_2 16 = 4$

1. **CTLG**
2. “log(” (\blacktriangle \blacktriangledown), then **EXE**.
3. **2** **SHIFT** **)** (**,**) **1** **6** **)** **EXE**

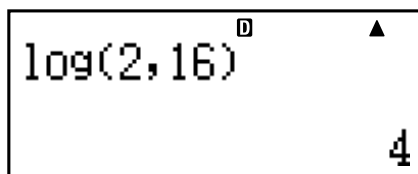

A calculator display showing the function log(2,16) with a result of 4. The display has a 'D' indicator at the top right and a small triangle at the top right. The number 4 is shown at the bottom right.

Example 2: $\log 16 = 1.204119983$

1. **CTLG**
2. “log(” (\blacktriangle \blacktriangledown), then **EXE**.
3. **1** **6** **)** **EXE**

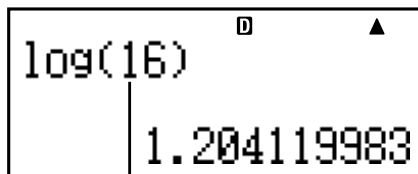

A calculator display showing the function log(16) with a result of 1.204119983. The display has a 'D' indicator at the top right and a small triangle at the top right. The result is shown in the lower half of the display.

A base of 10 (common logarithm) is used if no base is specified.

Example 3: $\ln 90 (= \log_e 90) = 4.49980967$

1. **CTLG**
2. “ln(” (\blacktriangle \blacktriangledown), then **EXE**.
3. **9** **0** **)** **EXE**

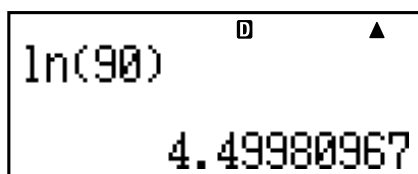

A calculator display showing the function ln(90) with a result of 4.49980967. The display has a 'D' indicator at the top right and a small triangle at the top right. The result is shown in the lower half of the display.

Example 4: $\ln e = 1$

1. **CTLG**
2. “ln(” (\blacktriangle \blacktriangledown), then **EXE**.
3. **ALPHA** **$\times 10^x$** (**e**) **)** **EXE**

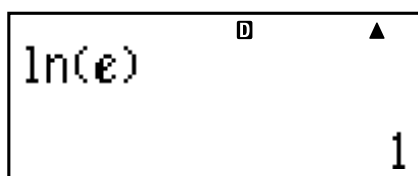

A calculator display showing the function ln(e) with a result of 1. The display has a 'D' indicator at the top right and a small triangle at the top right. The result is shown at the bottom right.

Example 5: $e^{10} = 22026.46579$

1. **CTLG**
2. “e^(” (\blacktriangle \blacktriangledown), then **EXE**.
3. **1** **0** **)** **EXE**

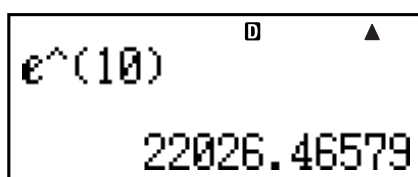

A calculator display showing the function e^(10) with a result of 22026.46579. The display has a 'D' indicator at the top right and a small triangle at the top right. The result is shown in the lower half of the display.

■ Power Functions and Power Root Functions

Example 1: $1.2 \times 10^3 = 1200$

1. **1** **.** **2** **\times** **CTLG**
2. “10^(” (\blacktriangle \blacktriangledown), then **EXE**.
3. **3** **)** **EXE**

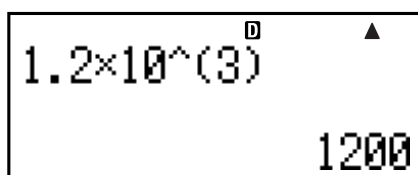

A calculator display showing the function 1.2x10^(3) with a result of 1200. The display has a 'D' indicator at the top right and a small triangle at the top right. The result is shown at the bottom right.

Example 2: $(1 + 1)^{2+2} = 16$

1. $($ 1 $+$ 1 $)$ CTLG
2. “ \wedge ” (\blacktriangle \blacktriangledown), then EXE .
3. 2 $+$ 2 $)$ EXE

A calculator display showing the expression $(1+1)^{(2+2)}$ and the result 16. The expression is entered in a single line, with the exponentiation symbol \wedge and the closing parenthesis $)$ appearing above the line. The result 16 is shown in the bottom right corner.

Example 3: $2^3 = 8$

1. 2 CTLG
2. “ $^$ ” (\blacktriangle \blacktriangledown), then EXE .
3. EXE

A calculator display showing the expression 2^3 and the result 8. The expression is entered in a single line, with the exponentiation symbol \wedge appearing above the line. The result 8 is shown in the bottom right corner.

Example 4: $(\sqrt{2} + 1)(\sqrt{2} - 1) = 1$

1. $($ CTLG
2. “ $\sqrt{}$ ” (\blacktriangle \blacktriangledown), then EXE .
3. 2 $)$ $+$ 1 $)$ $($ CTLG
4. “ $\sqrt{}$ ” (\blacktriangle \blacktriangledown), then EXE .
5. 2 $)$ $-$ 1 $)$ EXE

A calculator display showing the expression $(\sqrt{2}+1)(\sqrt{2}-1)$ and the result 1. The expression is entered in a single line, with the square root symbols $\sqrt{}$ appearing above the line. The result 1 is shown in the bottom right corner.

Example 5: $5\sqrt[3]{32} = 2$

1. 5 CTLG
2. “ $^x\sqrt{}$ ” (\blacktriangle \blacktriangledown), then EXE .
3. 3 2 $)$ EXE

A calculator display showing the expression $5^x\sqrt[3]{32}$ and the result 2. The expression is entered in a single line, with the xth root symbol $^x\sqrt{}$ appearing above the line. The result 2 is shown in the bottom right corner.

Example 6: $^3\sqrt{5} + ^3\sqrt{-27} = -1.290024053$

1. CTLG
2. “ $^3\sqrt{}$ ” (\blacktriangle \blacktriangledown), then EXE .
3. 5 $)$ $+$ CTLG
4. “ $^3\sqrt{}$ ” (\blacktriangle \blacktriangledown), then EXE .
5. $(-)$ 2 7 $)$ EXE

A calculator display showing the expression $^3\sqrt{5} + ^3\sqrt{-27}$ and the result -1.290024053. The expression is entered in a single line, with the cube root symbols $^3\sqrt{}$ appearing above the line. The result -1.290024053 is shown in the bottom right corner.

■ Rectangular-Polar Coordinate Conversion

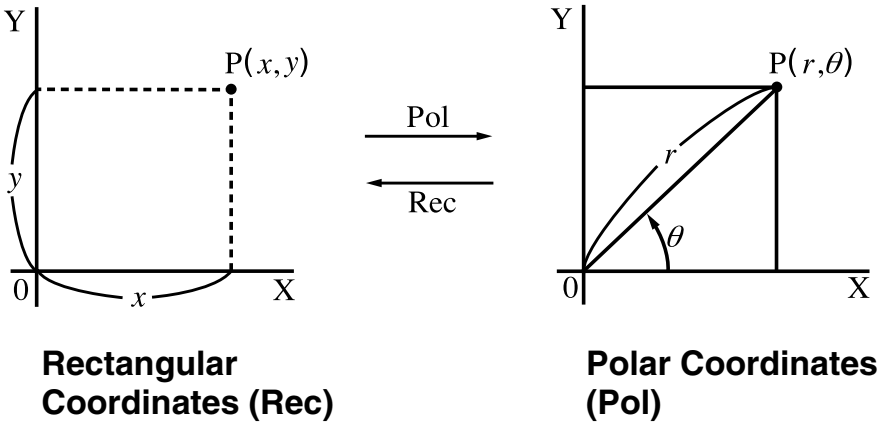

Converting to Polar Coordinates (Pol)

Pol(X, Y) X: Specifies the rectangular coordinate X value
 Y: Specifies the rectangular coordinate Y value

- Calculation result θ is displayed in the range of $-180^\circ < \theta \leq 180^\circ$.
- Calculation result θ is displayed using the calculator's default angle unit.
- Calculation result r is assigned to variable X, while θ is assigned to Y.

Converting to Rectangular Coordinates (Rec)

Rec(r, θ) r : Specifies r value of polar coordinate
 θ : Specifies θ value of polar coordinate

- Input value θ is treated as an angle value, in accordance with the calculator's default angle unit setting.
- Calculation result x is assigned to variable X, while y is assigned to Y.
- If you perform coordinate conversion inside of an expression instead of a stand-alone operation, the calculation is performed using only the first value (either the r -value or the X-value) produced by the conversion.
Example: Pol ($\sqrt{2}, \sqrt{2}$) + 5 = 2 + 5 = 7

Example 1: $(X, Y) = (\sqrt{2}, \sqrt{2}) \rightarrow (r, \theta)$

Deg

1. **CTLG**
2. “Pol” (\blacktriangle \blacktriangledown), then **EXE**.
3. **SHIFT** **5** ($\sqrt{\quad}$) **2** **)**
SHIFT **)** (,) **SHIFT** **5** ($\sqrt{\quad}$)
2 **)** **)** **EXE**

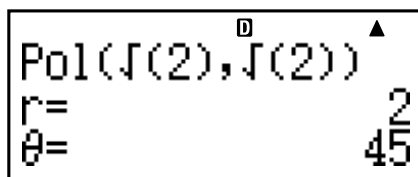

Pol(√(2),√(2))
r= 2
θ= 45

Example 2: $(r, \theta) = (2, 30) \rightarrow (X, Y)$

Deg

1. **CTLG**
2. “Rec” (\blacktriangle \blacktriangledown), then **EXE**.
3. **2** **SHIFT** **)** (,) **3** **0** **)** **EXE**

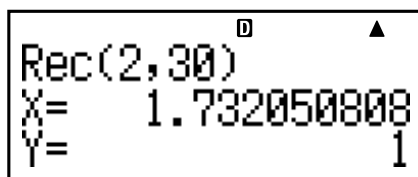

Rec(2,30)
X= 1.732050808
Y= 1

■ Other Functions

This section explains how to use the functions shown below.

!, Abs(, Ran#, nPr, nCr, Rnd(

◆ Factorial (!)

This function obtains the factorials of a value that is zero or a positive integer.

Example: $(5 + 3)! = 40320$

1. **(** **5** **+** **3** **)** **CTLG**
2. “!” (\blacktriangle \blacktriangledown), then **EXE**.
3. **EXE**

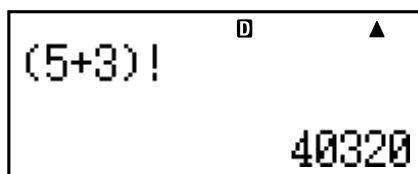

(5+3)!
40320

◆ Absolute Value Calculation (Abs)

When you are performing a real number calculation, this function simply obtains the absolute value.

Example: $\text{Abs}(2 - 7) = 5$

1. **CTLG**
2. “Abs(” (\blacktriangle \blacktriangledown), then **EXE**.
3. **2** **-** **7** **)** **EXE**

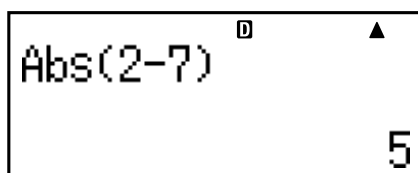

A calculator display showing the text "Abs(2-7)" on the left and the number "5" on the right. There are small "D" and "▲" symbols in the top right corner of the display area.

◆ Random Number (Ran#)

This function generates a 3-digit pseudo random number that is less than 1.

Example: To generate three 3-digit random numbers.

The random 3 digit decimal values are converted to 3-digit integer values by multiplying by 1000.

Note that the values shown here are examples only. Values actually generated by your calculator will be different.

1. **1** **0** **0** **0** **CTLG**
2. “Ran#” (\blacktriangle \blacktriangledown), then **EXE**.
3. **EXE**

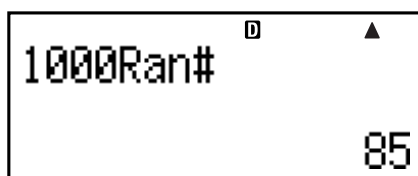

A calculator display showing the text "1000Ran#" on the left and the number "85" on the right. There are small "D" and "▲" symbols in the top right corner of the display area.

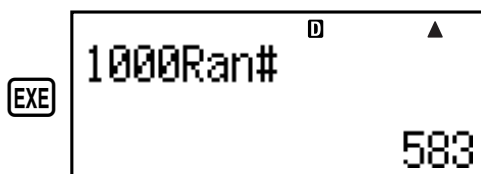

A calculator display showing the text "1000Ran#" on the left and the number "583" on the right. There are small "D" and "▲" symbols in the top right corner of the display area. To the left of the display is a small "EXE" button icon.



A calculator display showing the text "1000Ran#" on the left and the number "182" on the right. There are small "D" and "▲" symbols in the top right corner of the display area. To the left of the display is a small "EXE" button icon.

◆ Permutation (nPr) and Combination (nCr)

These functions make it possible to perform permutation and combination calculations.

n and r must be integers in the range of $0 \leq r \leq n < 1 \times 10^{10}$.

Example: How many four-person permutations and combinations are possible for a group of 10 people?

1. **1** **0** **CTLG**

2. “P” (**▲** **▼**), then **EXE**.

3. **4** **EXE**

10P4
5040

1. **1** **0** **CTLG**

2. “C” (**▲** **▼**), then **EXE**.

3. **4** **EXE**

10C4
210

◆ Rounding Function (Rnd)

This function rounds the value or the result of the expression in the function’s argument to the number of significant digits specified by the number of display digits setting.

Display Digits Setting: Norm1 or Norm2

The mantissa is rounded to 10 digits.

Display Digits Setting: Fix or Sci

The value is rounded to the specified number of digits.

Example: $200 \div 7 \times 14 = 400$

2 **0** **0** **÷** **7** **×** **1** **4** **EXE**

200÷7×14
400

(Specifies three decimal places.)

1. **SETUP**

2. “Fix” (**▲** **▼**), then **EXE**.

3. **3**

4. **ESC**

5. **EXE**

200÷7×14
400.000

(Calculation is performed internally using 15 digits.)

2 **0** **0** **÷** **7** **EXE**

200÷7
FIX ▲
28.571

× **1** **4** **EXE**

Ans×14
FIX ▲
400.000

The following performs the same calculation with rounding.

2 **0** **0** **÷** **7** **EXE**

200÷7
FIX ▲
28.571

(Round the value to the specified number of digits.)

SHIFT **0** (Rnd) **EXE**

Rnd(Ans
FIX ▲
28.571

(Check rounded result.)

× **1** **4** **EXE**

Ans×14
FIX ▲
399.994

Statistical Calculation

All calculations in this section are performed in the STAT Mode ($\boxed{\text{STAT}}$).

◆ Selecting a Statistical Calculation Type

In the STAT Mode, display the statistical calculation type selection screen.

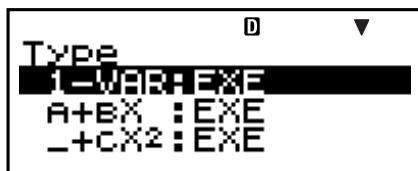

■ Statistical Calculation Types

Use $\boxed{\blacktriangle}$ $\boxed{\blacktriangledown}$ to select Item, and then press $\boxed{\text{EXE}}$.

Menu Item	Statistical Calculation
1-VAR	Single-variable
A+BX	Linear regression
_+CX ²	Quadratic regression
In X	Logarithmic regression
e ^X	<i>e</i> exponential regression
A•B ^X	<i>ab</i> exponential regression
A•X ^B	Power regression
1/X	Inverse regression

■ Inputting Sample Data

◆ Displaying the STAT Editor Screen

The STAT editor screen appears after you enter the STAT Mode from another mode. Use the STAT menu to select a statistical calculation type. To display the STAT editor screen from another STAT Mode screen, press $\boxed{\text{SHIFT}} \boxed{\text{STAT}}$ (S-MENU) $\boxed{2}$ (Data).

Note

- The STAT editor and the D.Editor *x* of the CASH Mode use the same memory area to store data.

◆ STAT Editor Screen

There are two STAT editor screen formats, depending on the type of statistical calculation you selected.

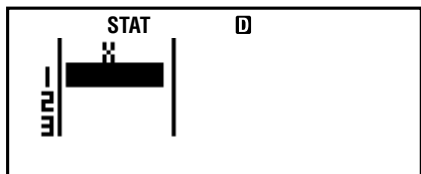

Single-variable Statistics

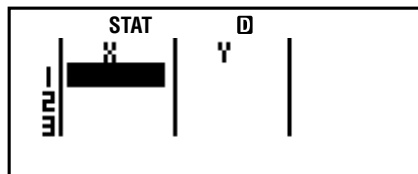

Paired-variable Statistics

- The first line of the STAT editor screen shows the value for the first sample or for the values for their first pair of samples.

◆ FREQ (Frequency) Column

If you turn on the Statistical Display item on the calculator's setup screen, a column labeled "FREQ" will also be included on the STAT editor screen.

You can use the FREQ column to specify the frequency (the number of times the same sample appears in the group of data) of each sample value.

◆ Rules for Inputting Sample Data on the STAT Editor Screen

- Data you input is inserted into the cell where the cursor is located. Use to move the cursor between cells.

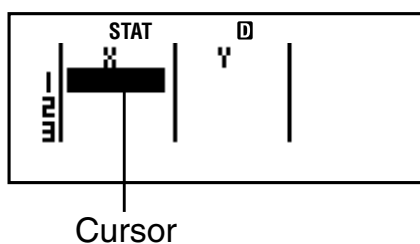

- The values and expressions you can input on the STAT editor screen are the same as those you can input in the COMP Mode. Note, however, that the following functions are not available on the STAT editor screen: multiple operations in calculation history memory, multi-statement input, and assignment to financial calculation variables.
- Pressing while inputting data clears your current input.
- After inputting a value, press . This registers the value and displays up to six of its digits in the currently selected cell.

Example: To input the value 123.45 in cell X1

(Move the cursor to cell X1.)

1 2 3 . 4 5

The value you input appears in the formula area.

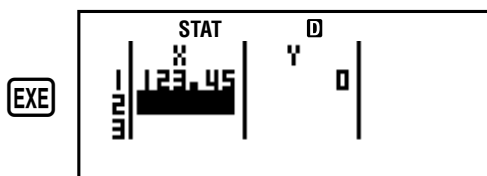
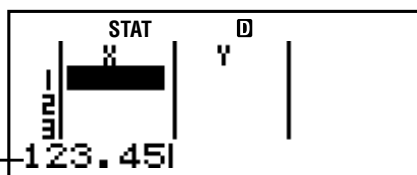

Registering a value causes the cursor to move down one cell.

◆ STAT Editor Screen Input Precautions

- The number of lines in STAT editor screen (the number of sample data values you can input) depends on the type of statistical data you selected, and on the Statistical Display setting of the calculator's setup screen (page E-21).

Statistical Display Statistic Type	OFF (No FREQ column)	ON (FREQ column)
	Single-variable	80 lines
Paired-variable	40 lines	26 lines

- The following types of input are not allowed on the STAT editor screen.
 - $\boxed{M+}$, $\boxed{\text{SHIFT}} \boxed{M+}$ ($M-$) operations
 - Assignment to variables (STO)
 - Financial Calculation Variables (VARs)

◆ Precautions Concerning Sample Data Storage

- The STAT Editor and the CASH Mode DataEditor store data in the same area.
- Sample data you input is deleted automatically whenever you change the Statistical Display setting (which causes the FREQ column to be shown or hidden) on the calculator's setup screen.

◆ Editing Sample Data

Replacing the Data in a Cell

1. On the STAT editor screen, move the cursor to the cell you want to edit.
2. Input the new data value or expression, and then press **EXE**.

Important!

- Note that you must totally replace the existing data of the cell with new input. You cannot edit parts of the existing data.

Deleting a Line

1. On the STAT editor screen, move the cursor to the line you want to delete.
2. **DEL**

Inserting a Line

1. On the STAT editor screen, move the cursor to the line that will be under the line you will insert.
2. **SHIFT** **STAT** (S-MENU) **3** (Edit)
3. **1** (Ins)

Important!

- Note that the insert operation will not work if the maximum number of lines allowed for the STAT editor screen are already used.

Deleting All STAT Editor Contents

1. **SHIFT** **STAT** (S-MENU) **3** (Edit)
2. **2** (Del-A)
 - This clears all of the sample data on the STAT editor screen.

Note

- Note that you can perform the procedures under “Inserting a Line” and “Deleting All STAT Editor Contents” only when the STAT editor screen is on the display.

■ STAT Calculation Screen

The STAT calculation screen is for performing statistical calculations with the data you input with the STAT editor screen. Pressing the **AC** key while the STAT editor screen is displayed switches to the STAT calculation screen.

■ Using the STAT Menu

While the STAT editor screen or STAT calculation screen is on the display, press **[SHIFT]** **[STAT]** (S-MENU) to display the STAT menu.

The content to the STAT menu depends on whether the currently selected statistical operation type uses a single variable or paired variables.

STAT		□
1:Type	2:Data	
3:Edit	4:Sum	
5:Var	6:MinMax	

Single-variable Statistics

STAT		□
1:Type	2:Data	
3:Edit	4:Sum	
5:Var	6:MinMax	
7:Reg		

Paired-variable Statistics

◆ STAT Menu Items

Common Items

Select this menu item:	When you want to do this:
[1] Type	Display the statistical calculation type selection screen
[2] Data	Display the STAT editor screen
[3] Edit	Display the Edit sub-menu for editing STAT editor screen contents
[4] Sum	Display the Sum sub-menu of commands for calculating sums
[5] Var	Display the Var sub-menu of commands for calculating the mean, standard deviation, etc.
[6] MinMax	Display the MinMax sub-menu of commands for obtaining maximum and minimum values

Paired-variable Menu Item

Select this menu item:	When you want to do this:
[7] Reg	Display the Reg sub-menu of commands for regression calculations <ul style="list-style-type: none"> • For details see “Commands when Linear Regression Calculation (A+BX) Is Selected” on page E-117 and “Commands when Quadratic Regression Calculation ($_+CX^2$) Is Selected” on page E-121.

◆ Single-variable (1-VAR) Statistical Calculation Commands

The following are the commands that appear on the sub-menus that appear when you select **[4]** (Sum), **[5]** (Var) or **[6]** (MinMax) on the STAT menu while a single-variable statistical calculation type is selected.

Calculation formula used for each command

$$\bar{x} = \frac{\sum x}{n}$$

$$x\sigma_n = \sqrt{\frac{\sum (x - \bar{x})^2}{n}}$$

$$x\sigma_{n-1} = \sqrt{\frac{\sum (x - \bar{x})^2}{n-1}}$$

Sum Sub-menu (**[SHIFT]** **[STAT]** (S-MENU) **[4]** (Sum))

Select this menu item:	When you want to obtain this:
[1] $\sum x^2$	Sum of squares of the sample data
[2] $\sum x$	Sum of the sample data

Var Sub-menu (**[SHIFT]** **[STAT]** (S-MENU) **[5]** (Var))

Select this menu item:	When you want to obtain this:
[1] n	Number of samples
[2] \bar{x}	Mean of the sample data
[3] $x\sigma_n$	Population standard deviation
[4] $x\sigma_{n-1}$	Sample standard deviation

MinMax Sub-menu (**SHIFT** **STAT** (S-MENU) **6** (MinMax))

Select this menu item:	When you want to obtain this:
1 minX	Minimum value
2 maxX	Maximum value

Single-variable Statistical Calculation

Example 1: To select single-variable (1-VAR) and input the following data: {1, 2, 3, 4, 5, 6, 7, 8, 9, 10} (FREQ: ON)

Preparation

- 1** **SETUP**
- “STAT” (**▲** **▼**), then **EXE**.
- 1** (On)

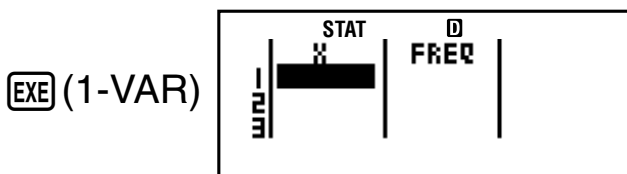
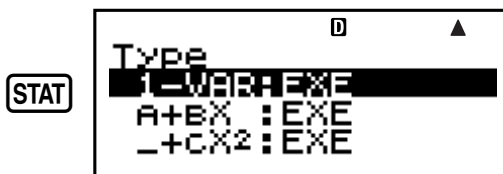

1 **EXE** **2** **EXE** **3** **EXE** **4** **EXE**
5 **EXE** **6** **EXE** **7** **EXE** **8** **EXE**
9 **EXE** **1** **0** **EXE**

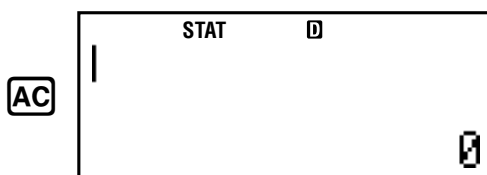
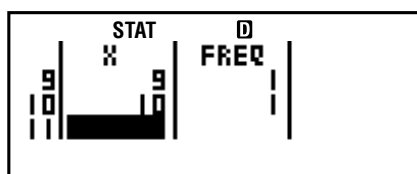

Example 2: To edit the data to the following, using insert and delete: {0, 1, 2, 3, 4, 5, 6, 7, 9, 10} (FREQ: ON)

SHIFT **STAT** (S-MENU) **2** (Data)

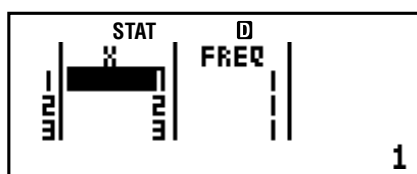

SHIFT **STAT** (S-MENU)
3 (Edit) **1** (Ins)

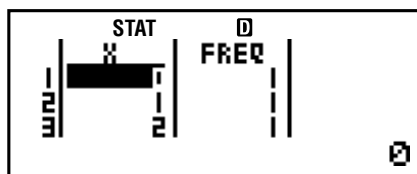

▼ ▼ ▼ ▼ ▼ ▼ ▼ ▼ **DEL**

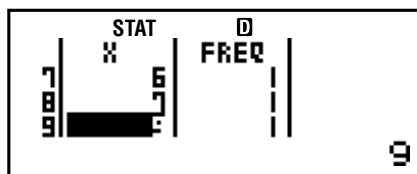

AC

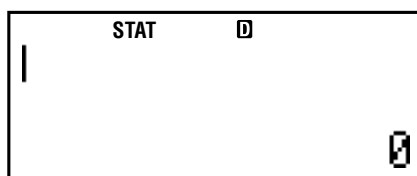

Example 3: To edit the FREQ data to the following:
 {1, 2, 1, 2, 2, 2, 3, 4, 2, 1} (FREQ: ON)

SHIFT **STAT** (S-MENU) **2** (Data) **▶**

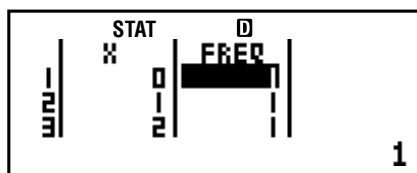

▼ **2** **EXE** ▼ **2** **EXE** **2** **EXE**
2 **EXE** **3** **EXE** **4** **EXE** **2** **EXE**

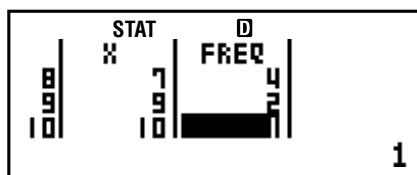

AC

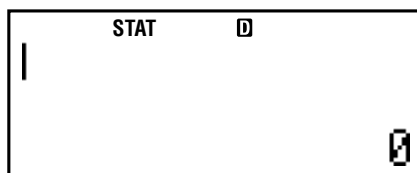

• Examples 4 through 7 all use the same data as Example 3.

Example 4: To calculate sum of squares of the sample data and sum of the sample data.

SHIFT **STAT** (S-MENU) **4** (Sum)

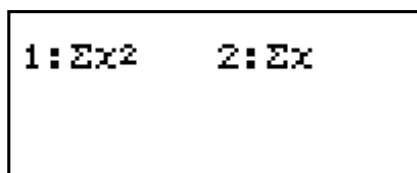

1 (Σx^2) **EXE**

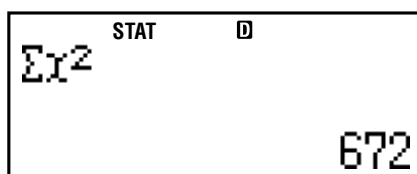

SHIFT **STAT** (S-MENU) **4** (Sum)
2 (Σx) **EXE**

STAT \square
 Σx
 102

Example 5: To calculate number of samples, mean, and population standard deviation.

SHIFT **STAT** (S-MENU) **5** (Var)

1:n 2: \bar{x}
 3: $x\sigma n$ 4: $x\sigma n-1$

1 (n) **EXE**

STAT \square
 n
 20

SHIFT **STAT** (S-MENU) **5** (Var)
2 (\bar{x}) **EXE**

STAT \square
 \bar{x}
 5.1

SHIFT **STAT** (S-MENU) **5** (Var)
3 ($x\sigma n$) **EXE**

STAT \square
 $x\sigma n$
 2.754995463

Example 6: To calculate minimum value and maximum value.

SHIFT **STAT** (S-MENU) **6** (MinMax)

1:minX 2:maxX

1 (minX) **EXE**

STAT \square
 minX
 0

SHIFT **STAT** (S-MENU) **6** (MinMax)
2 (maxX) **EXE**

STAT \square
 maxX
 10

◆ Commands when Linear Regression Calculation (A+BX) Is Selected

With linear regression, regression is performed in accordance with the following model equation.

$$y = A + BX$$

The following are the commands that appear on the sub-menus that appear when you select **[4]** (Sum), **[5]** (Var), **[6]** (MinMax), or **[7]** (Reg) on the STAT menu while linear regression is selected as the statistical calculation type.

Calculation formula used for each command

$$\bar{x} = \frac{\sum x}{n}$$

$$x\sigma_n = \sqrt{\frac{\sum (x - \bar{x})^2}{n}}$$

$$x\sigma_{n-1} = \sqrt{\frac{\sum (x - \bar{x})^2}{n-1}}$$

$$\bar{y} = \frac{\sum y}{n}$$

$$y\sigma_n = \sqrt{\frac{\sum (y - \bar{y})^2}{n}}$$

$$y\sigma_{n-1} = \sqrt{\frac{\sum (y - \bar{y})^2}{n-1}}$$

$$A = \frac{\sum y - B \cdot \sum x}{n}$$

$$B = \frac{n \cdot \sum xy - \sum x \cdot \sum y}{n \cdot \sum x^2 - (\sum x)^2}$$

$$r = \frac{n \cdot \sum xy - \sum x \cdot \sum y}{\sqrt{\{n \cdot \sum x^2 - (\sum x)^2\} \{n \cdot \sum y^2 - (\sum y)^2\}}}$$

$$\hat{x} = \frac{y - A}{B}$$

$$\hat{y} = A + Bx$$

Sum Sub-menu (**SHIFT** **STAT** (S-MENU) **4** (Sum))

Select this menu item:	When you want to obtain this:
1 Σx^2	Sum of squares of the X-data
2 Σx	Sum of the X-data
3 Σy^2	Sum of squares of the Y-data
4 Σy	Sum of the Y-data
5 Σxy	Sum of products of the X-data and Y-data
6 Σx^3	Sum of cubes of the X-data
7 Σx^2y	Sum of (X-data squares \times Y-data)
8 Σx^4	Sum of biquadrate of the X-data

Var Sub-menu (**SHIFT** **STAT** (S-MENU) **5** (Var))

Select this menu item:	When you want to obtain this:
1 n	Number of samples
2 \bar{x}	Mean of the X-data
3 $x\sigma n$	Population standard deviation of the X-data
4 $x\sigma n-1$	Sample standard deviation of the X-data
5 \bar{y}	Mean of the Y-data
6 $y\sigma n$	Population standard deviation of the Y-data
7 $y\sigma n-1$	Sample standard deviation of the Y-data

MinMax Sub-menu (**SHIFT** **STAT** (S-MENU) **6** (MinMax))

Select this menu item:	When you want to obtain this:
1 minX	Minimum value of the X-data
2 maxX	Maximum value of the X-data
3 minY	Minimum value of the Y-data
4 maxY	Maximum value of the Y-data

Reg Sub-menu (**SHIFT** **STAT** (S-MENU) **7** (Reg))

Select this menu item:	When you want to obtain this:
1 A	Regression coefficient constant term A
2 B	Regression coefficient B
3 r	Correlation coefficient r
4 \hat{x}	Estimated value of x
5 \hat{y}	Estimated value of y

Linear Regression Calculation

- Examples 8 through 10 all use the data input in Example 7.

Example 7:

x	y	x	y
1.0	1.0	2.1	1.5
1.2	1.1	2.4	1.6
1.5	1.2	2.5	1.7
1.6	1.3	2.7	1.8
1.9	1.4	3.0	2.0

1. **SETUP**
2. "STAT" (**▲** **▼**), then **EXE**.
3. **2** (Off)

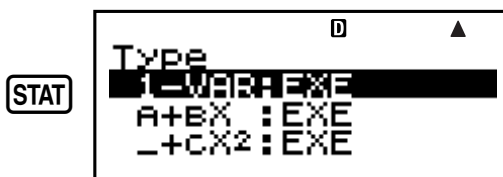

▼ **EXE** (A+BX)

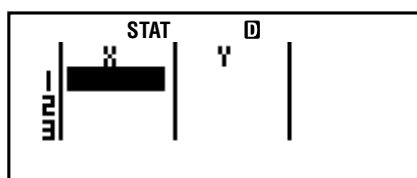

1 **EXE** **1** **.** **2** **EXE**
1 **.** **5** **EXE** **1** **.** **6** **EXE**
1 **.** **9** **EXE** **2** **.** **1** **EXE**
2 **.** **4** **EXE** **2** **.** **5** **EXE**
2 **.** **7** **EXE** **3** **EXE**

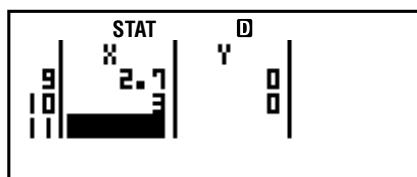

▼ ► 1 EXE

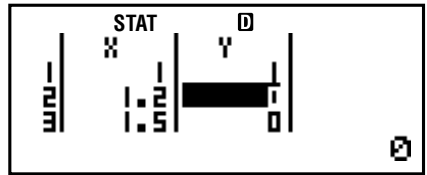

1 . 1 EXE 1 . 2 EXE
 1 . 3 EXE 1 . 4 EXE
 1 . 5 EXE 1 . 6 EXE
 1 . 7 EXE 1 . 8 EXE
 2 EXE

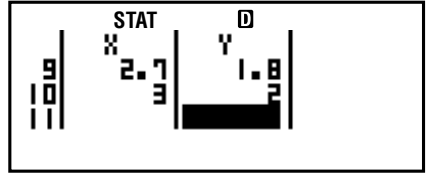

AC

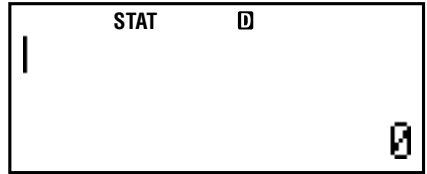

Example 8:

SHIFT STAT (S-MENU) 4 (Sum)

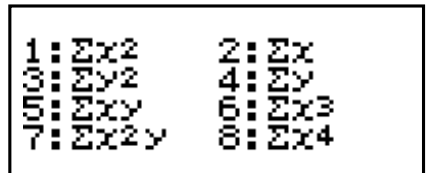

5 (Σxy) EXE

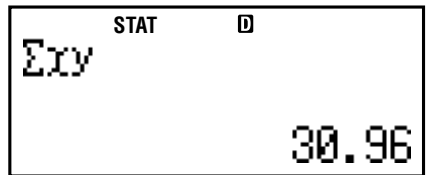

SHIFT STAT (S-MENU) 5 (Var)

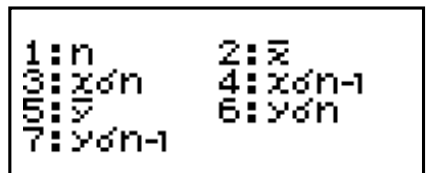

3 ($x\sigma n$) EXE

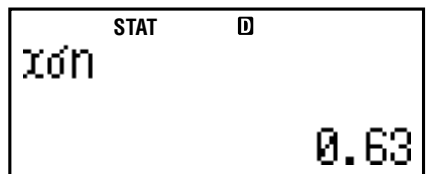

SHIFT STAT (S-MENU)
 6 (MinMax)

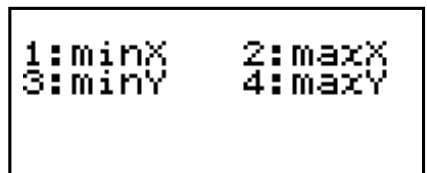

4 (maxY) EXE

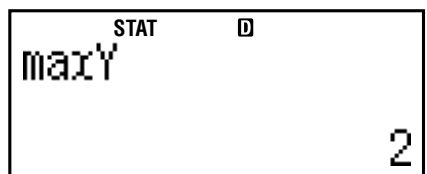

Example 9:

SHIFT **STAT** (S-MENU) **7** (Reg)

```
1:A      2:B
3:r      4:Σ
5:σ
```

1 (A) **EXE**

```
STAT  D
A
0.5043587805
```

SHIFT **STAT** (S-MENU)
7 (Reg) **2** (B) **EXE**

```
STAT  D
B
0.4802217183
```

SHIFT **STAT** (S-MENU)
7 (Reg) **3** (r) **EXE**

```
STAT  D
r
0.9952824846
```

Example 10:

Estimated Value ($y = -3 \rightarrow \hat{x} = ?$)

(-) **3** **SHIFT** **STAT** (S-MENU)
7 (Reg) **4** (\hat{x}) **EXE**

```
STAT  D
-3Σ
-7.297376705
```

Estimated Value ($x = 2 \rightarrow \hat{y} = ?$)

2 **SHIFT** **STAT** (S-MENU)
7 (Reg) **5** (\hat{y}) **EXE**

```
STAT  D
2σ
1.464802217
```

◆ Commands when Quadratic Regression Calculation ($_+CX^2$) Is Selected

With quadratic regression, regression is performed in accordance with the following model equation.

$$y = A + BX + CX^2$$

Calculation formula used for each command

$$A = \frac{\sum y}{n} - B\left(\frac{\sum x}{n}\right) - C\left(\frac{\sum x^2}{n}\right)$$

$$B = \frac{Sxy \cdot Sx^2x^2 - Sx^2y \cdot Sxx^2}{Sxx \cdot Sx^2x^2 - (Sxx^2)^2}$$

$$C = \frac{Sx^2y \cdot Sxx - Sxy \cdot Sxx^2}{Sxx \cdot Sx^2x^2 - (Sxx^2)^2}$$

$$Sxx = \sum x^2 - \frac{(\sum x)^2}{n}$$

$$Sxy = \sum xy - \frac{(\sum x \cdot \sum y)}{n}$$

$$Sxx^2 = \sum x^3 - \frac{(\sum x \cdot \sum x^2)}{n}$$

$$Sx^2x^2 = \sum x^4 - \frac{(\sum x^2)^2}{n}$$

$$Sx^2y = \sum x^2y - \frac{(\sum x^2 \cdot \sum y)}{n}$$

$$\hat{x}_1 = \frac{-B + \sqrt{B^2 - 4C(A - y)}}{2C}$$

$$\hat{x}_2 = \frac{-B - \sqrt{B^2 - 4C(A - y)}}{2C}$$

$$\hat{y} = A + Bx + Cx^2$$

Reg Sub-menu (**SHIFT** **STAT** **(S-MENU)** **7** **(Reg)**)

Select this menu item:	When you want to obtain this:
1 A	Regression coefficient constant term A
2 B	Linear coefficient B of the regression coefficients
3 C	Quadratic coefficient C of the regression coefficients
4 \hat{x}_1	Estimated value of x_1
5 \hat{x}_2	Estimated value of x_2
6 \hat{y}	Estimated value of y

- Sum sub-menu (sums), Var sub-menu (number of samples, mean, standard deviation), and MinMax sub-menu (maximum value, minimum value) operations are the same those for linear regression calculations.

Quadratic Regression Calculation

- Examples 11 through 13 all use the data input in Example 7 (page E-119).

Example 11:

SHIFT **STAT** (S-MENU) **1** (Type)

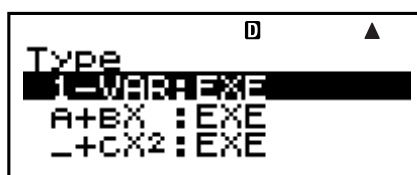

▼ **▼** **EXE** ($_+CX^2$)

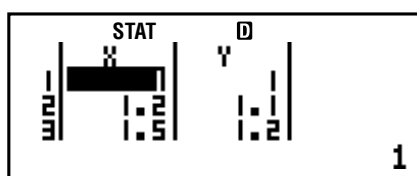

AC

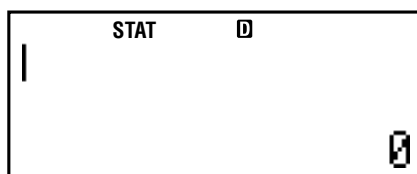

Example 12:

SHIFT **STAT** (S-MENU) **7** (Reg)

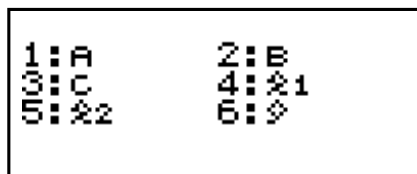

1 (A) **EXE**

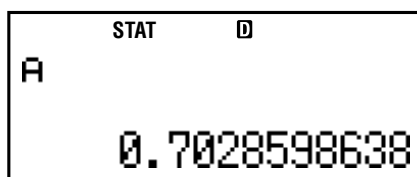

SHIFT **STAT** (S-MENU) **7** (Reg)

2 (B) **EXE**

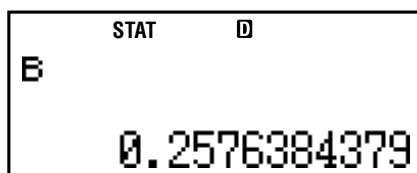

SHIFT **STAT** (S-MENU) **7** (Reg)

3 (C) **EXE**

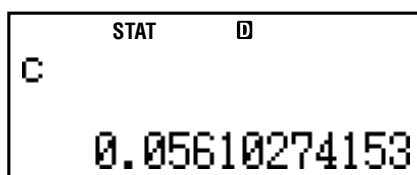

Example 13:

$$y = 3 \rightarrow \hat{x}_1 = ?$$

3 **SHIFT** **STAT** (S-MENU) **7** (Reg)
4 (\hat{x}_1) **EXE**

STAT \square
3 \hat{x}_1
4.502211457

$$y = 3 \rightarrow \hat{x}_2 = ?$$

3 **SHIFT** **STAT** (S-MENU) **7** (Reg)
5 (\hat{x}_2) **EXE**

STAT \square
3 \hat{x}_2
-9.094472563

$$x = 2 \rightarrow \hat{y} = ?$$

2 **SHIFT** **STAT** (S-MENU) **7** (Reg)
6 (\hat{y}) **EXE**

STAT \square
2 \hat{y}
1.442547706

◆ Comments for Other Types of Regression

For details about the calculation formula of the command included in each regression type, refer to the indicated calculation formulas.

Statistical Calculation Type	Model Equation
Logarithmic Regression (ln X)	$y = A + B \ln X$
<i>e</i> Exponential Regression (e^X)	$y = Ae^{BX}$
<i>ab</i> Exponential Regression ($A \cdot B^X$)	$y = AB^X$
Power Regression ($A \cdot X^B$)	$y = AX^B$
Inverse Regression ($1/X$)	$y = A + \frac{B}{X}$

Logarithmic Regression (ln X)

$$A = \frac{\Sigma y - B \cdot \Sigma \ln x}{n}$$

$$B = \frac{n \cdot \Sigma (\ln x)y - \Sigma \ln x \cdot \Sigma y}{n \cdot \Sigma (\ln x)^2 - (\Sigma \ln x)^2}$$

$$r = \frac{n \cdot \Sigma (\ln x)y - \Sigma \ln x \cdot \Sigma y}{\sqrt{\{n \cdot \Sigma (\ln x)^2 - (\Sigma \ln x)^2\} \{n \cdot \Sigma y^2 - (\Sigma y)^2\}}}$$

$$\hat{x} = e^{\frac{y-A}{B}}$$

$$\hat{y} = A + B \ln x$$

e Exponential Regression (e^X)

$$A = \exp\left(\frac{\Sigma \ln y - B \cdot \Sigma x}{n}\right)$$

$$B = \frac{n \cdot \Sigma x \ln y - \Sigma x \cdot \Sigma \ln y}{n \cdot \Sigma x^2 - (\Sigma x)^2}$$

$$r = \frac{n \cdot \Sigma x \ln y - \Sigma x \cdot \Sigma \ln y}{\sqrt{\{n \cdot \Sigma x^2 - (\Sigma x)^2\} \{n \cdot \Sigma (\ln y)^2 - (\Sigma \ln y)^2\}}}$$

$$\hat{x} = \frac{\ln y - \ln A}{B}$$

$$\hat{y} = A e^{Bx}$$

ab Exponential Regression (A•B^X)

$$A = \exp\left(\frac{\Sigma \ln y - B \cdot \Sigma x}{n}\right)$$

$$B = \exp\left(\frac{n \cdot \Sigma x \ln y - \Sigma x \cdot \Sigma \ln y}{n \cdot \Sigma x^2 - (\Sigma x)^2}\right)$$

$$r = \frac{n \cdot \Sigma x \ln y - \Sigma x \cdot \Sigma \ln y}{\sqrt{\{n \cdot \Sigma x^2 - (\Sigma x)^2\} \{n \cdot \Sigma (\ln y)^2 - (\Sigma \ln y)^2\}}}$$

$$\hat{x} = \frac{\ln y - \ln A}{\ln B}$$

$$\hat{y} = AB^x$$

Power Regression ($A \cdot X^B$)

$$A = \exp\left(\frac{\sum \ln y - B \cdot \sum \ln x}{n}\right)$$

$$B = \frac{n \cdot \sum \ln x \ln y - \sum \ln x \cdot \sum \ln y}{n \cdot \sum (\ln x)^2 - (\sum \ln x)^2}$$

$$r = \frac{n \cdot \sum \ln x \ln y - \sum \ln x \cdot \sum \ln y}{\sqrt{\{n \cdot \sum (\ln x)^2 - (\sum \ln x)^2\} \{n \cdot \sum (\ln y)^2 - (\sum \ln y)^2\}}}$$

$$\hat{x} = e^{\frac{\ln y - \ln A}{B}}$$

$$\hat{y} = Ax^B$$

Inverse Regression (1/X)

$$A = \frac{\sum y - B \cdot \sum x^{-1}}{n}$$

$$B = \frac{S_{xy}}{S_{xx}}$$

$$r = \frac{S_{xy}}{\sqrt{S_{xx} \cdot S_{yy}}}$$

$$S_{xx} = \sum (x^{-1})^2 - \frac{(\sum x^{-1})^2}{n}$$

$$S_{yy} = \sum y^2 - \frac{(\sum y)^2}{n}$$

$$S_{xy} = \sum (x^{-1})y - \frac{\sum x^{-1} \cdot \sum y}{n}$$

$$\hat{x} = \frac{B}{y - A}$$

$$\hat{y} = A + \frac{B}{x}$$

Comparison of Regression Curves

- The following example uses the data input in Example 7 (page E-119).

Example 14: To compare the correlation coefficient for logarithmic, e exponential, ab exponential, power, and inverse regression.

(FREQ: OFF)

SHIFT **STAT** (S-MENU) **1** (Type)

```

Type
1-WEBA:EXE
A+BX :EXE
-CX2:EXE
    
```

▼ **▼** **▼** **EXE** (ln X) **AC**
SHIFT **STAT** (S-MENU) **7** (Reg)
3 (r) **EXE**

```

STAT
r
0.9753724902
    
```

SHIFT **STAT** (S-MENU) **1** (Type)
▼ **▼** **▼** **▼** **EXE** (e^X) **AC**
SHIFT **STAT** (S-MENU) **7** (Reg)
3 (r) **EXE**

```

STAT
r
0.9967116738
    
```

SHIFT **STAT** (S-MENU) **1** (Type)
▼ **▼** **▼** **▼** **▼** **EXE** ($A \cdot B^X$)
AC **SHIFT** **STAT** (S-MENU) **7** (Reg)
3 (r) **EXE**

```

STAT
r
0.9967116738
    
```

SHIFT **STAT** (S-MENU) **1** (Type)
▼ **▼** **▼** **▼** **▼** **▼** **EXE** ($A \cdot X^B$)
AC **SHIFT** **STAT** (S-MENU) **7** (Reg)
3 (r) **EXE**

```

STAT
r
0.9917108781
    
```

SHIFT **STAT** (S-MENU) **1** (Type)
▼ **▼** **▼** **▼** **▼** **▼** **▼** **EXE** (1/X)
AC **SHIFT** **STAT** (S-MENU) **7** (Reg)
3 (r) **EXE**

```

STAT
r
-0.9341328778
    
```

Other Types of Regression Calculation

Example 15: $y = A + B \ln x$

x	y
29	1.6
50	23.5
74	38.0
103	46.4
118	48.9

1. **SETUP**
2. "STAT" (**▲ ▼**), then **EXE**.
3. **2** (Off)

STAT **▼ ▼ ▼** **EXE** (ln X)

2 **9** **EXE** **5** **0** **EXE** **7** **4** **EXE**
1 **0** **3** **EXE** **1** **1** **8** **EXE**

STAT		D
X	103	Y
	118	0

▼ **▶** **1** **.** **6** **EXE**
2 **3** **.** **5** **EXE**
3 **8** **EXE** **4** **6** **.** **4** **EXE**
4 **8** **.** **9** **EXE**

STAT		D
X	103	Y
	118	46.4
		48.9

AC **SHIFT** **STAT** (S-MENU)
7 (Reg) **1** (A) **EXE**

STAT		D
A		
		-111.1283976

SHIFT **STAT** (S-MENU)
7 (Reg) **2** (B) **EXE**

STAT		D
B		
		34.0201475

SHIFT **STAT** (S-MENU)
7 (Reg) **3** (r) **EXE**

STAT		D
r		
		0.9940139466

$x = 80 \rightarrow \hat{y} = ?$

8 **0** **SHIFT** **STAT** (S-MENU)
7 (Reg) **5** (\hat{y}) **EXE**

STAT		D
80		
		37.94879482

$y = 73 \rightarrow \hat{x} = ?$

7 **3** **SHIFT** **STAT** (S-MENU)
7 (Reg) **4** (\hat{x}) **EXE**

STAT		D
73		
		224.1541313

Example 16: $y = Ae^{Bx}$

x	y
6.9	21.4
12.9	15.7
19.8	12.1
26.7	8.5
35.1	5.2

1. **SETUP**
2. "STAT" (**▲** **▼**), then **EXE**.
3. **2** (Off)

STAT **▼** **▼** **▼** **▼** **EXE** (e^X)

6 **.** **9** **EXE** **1** **2** **.** **9** **EXE**
1 **9** **.** **8** **EXE**
2 **6** **.** **7** **EXE**
3 **5** **.** **1** **EXE**

```

STAT      D
|-----|-----|
| X      | Y      |
| 26.7   | 0      |
| 35.1   | 0      |
|-----|-----|

```

▼ **▶** **2** **1** **.** **4** **EXE**
1 **5** **.** **7** **EXE**
1 **2** **.** **1** **EXE** **8** **.** **5** **EXE**
5 **.** **2** **EXE**

```

STAT      D
|-----|-----|
| X      | Y      |
| 26.7   | 8.5    |
| 35.1   | 5.2    |
|-----|-----|

```

AC **SHIFT** **STAT** (S-MENU)
7 (Reg) **1** (A) **EXE**

```

STAT      D
A
|-----|
| 30.49758743 |
|-----|

```

SHIFT **STAT** (S-MENU)
7 (Reg) **2** (B) **EXE**

```

STAT      D
B
|-----|
| -0.04920370831 |
|-----|

```

SHIFT **STAT** (S-MENU)
7 (Reg) **3** (r) **EXE**

```

STAT      D
r
|-----|
| -0.997247352 |
|-----|

```

$x = 16 \rightarrow \hat{y} = ?$

1 **6** **SHIFT** **STAT** (S-MENU)
7 (Reg) **5** (\hat{y}) **EXE**

```

STAT      D
16
|-----|
| 13.87915739 |
|-----|

```

$y = 20 \rightarrow \hat{x} = ?$

2 **0** **SHIFT** **STAT** (S-MENU)
7 (Reg) **4** (\hat{x}) **EXE**

```

STAT      D
20
|-----|
| 8.574868047 |
|-----|

```

Example 17: $y = AB^x$

x	y
-1	0.24
3	4
5	16.2
10	513

1. **SETUP**
2. "STAT" (\blacktriangle \blacktriangledown), then **EXE**.
3. **2** (Off)

STAT \blacktriangledown \blacktriangledown \blacktriangledown \blacktriangledown \blacktriangledown **EXE** ($A \cdot B^X$)

(←) **1** **EXE** **3** **EXE** **5** **EXE**
1 **0** **EXE**

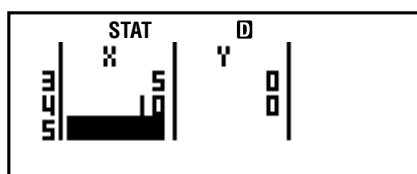

\blacktriangledown \blacktriangleright **0** **.** **2** **4** **EXE** **4** **EXE**
1 **6** **.** **2** **EXE** **5** **1** **3** **EXE**

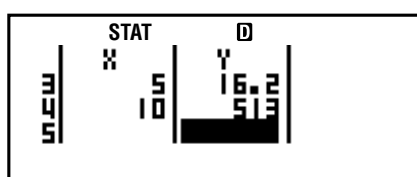

AC **SHIFT** **STAT** (S-MENU)
7 (Reg) **1** (A) **EXE**

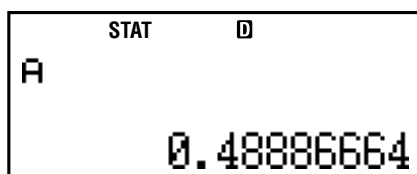

SHIFT **STAT** (S-MENU)
7 (Reg) **2** (B) **EXE**

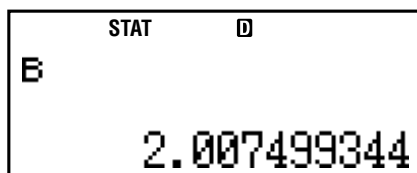

SHIFT **STAT** (S-MENU)
7 (Reg) **3** (r) **EXE**

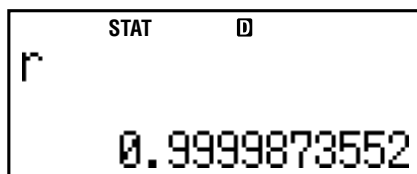

$x = 15 \rightarrow \hat{y} = ?$

1 **5** **SHIFT** **STAT** (S-MENU)
7 (Reg) **5** (\hat{y}) **EXE**

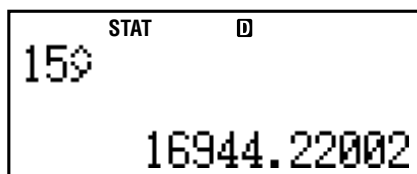

$y = 1.02 \rightarrow \hat{x} = ?$

1 **.** **0** **2**
SHIFT **STAT** (S-MENU)
7 (Reg) **4** (\hat{x}) **EXE**

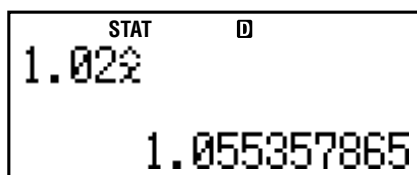

Example 18: $y = Ax^B$

x	y
28	2410
30	3033
33	3895
35	4491
38	5717

1. **SETUP**
2. "STAT" (\blacktriangle \blacktriangledown), then **EXE**.
3. **2** (Off)

STAT \blacktriangledown \blacktriangledown \blacktriangledown \blacktriangledown \blacktriangledown \blacktriangledown \blacktriangledown **EXE** ($A \cdot X^B$)

2 **8** **EXE** **3** **0** **EXE** **3** **3** **EXE**
3 **5** **EXE** **3** **8** **EXE**

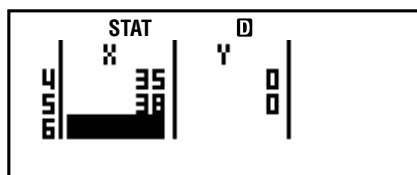

\blacktriangledown \blacktriangle **2** **4** **1** **0** **EXE**
3 **0** **3** **3** **EXE**
3 **8** **9** **5** **EXE**
4 **4** **9** **1** **EXE**
5 **7** **1** **7** **EXE**

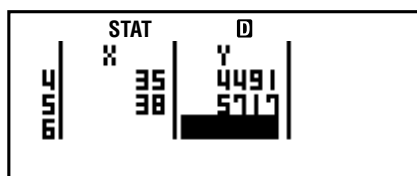

AC **SHIFT** **STAT** (S-MENU)
7 (Reg) **1** (A) **EXE**

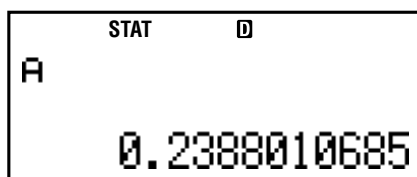

SHIFT **STAT** (S-MENU)
7 (Reg) **2** (B) **EXE**

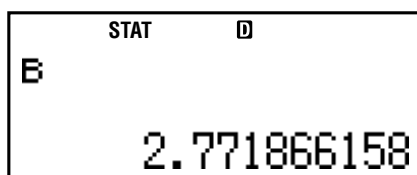

SHIFT **STAT** (S-MENU)
7 (Reg) **3** (r) **EXE**

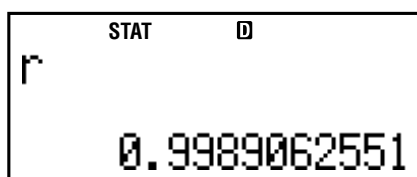

$x = 40 \rightarrow \hat{y} = ?$

4 **0** **SHIFT** **STAT** (S-MENU)
7 (Reg) **5** (\hat{y}) **EXE**

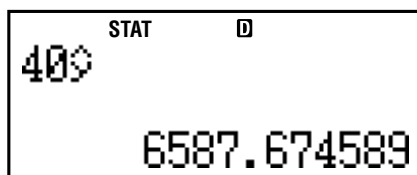

$y = 1000 \rightarrow \hat{x} = ?$

1 **0** **0** **0**
SHIFT **STAT** (S-MENU)
7 (Reg) **4** (\hat{x}) **EXE**

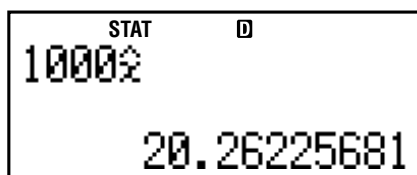

Example 19: $y = A + \frac{B}{x}$

x	y
1.1	18.3
2.1	9.7
2.9	6.8
4.0	4.9
4.9	4.1

1. **SETUP**
2. "STAT" (**▲** **▼**), then **EXE**.
3. **2** (Off)

STAT **▼** **▼** **▼** **▼** **▼** **▼** **▼** **▼** **EXE** (1/X)

1 **.** **1** **EXE** **2** **.** **1** **EXE**
2 **.** **9** **EXE** **4** **EXE**
4 **.** **9** **EXE**

```

STAT      D
X         Y
4.9      0
5.9      0
6.9      0

```

▼ **▶** **1** **8** **.** **3** **EXE**
9 **.** **7** **EXE** **6** **.** **8** **EXE**
4 **.** **9** **EXE** **4** **.** **1** **EXE**

```

STAT      D
X         Y
4.9      4.9
5.9      4.1
6.9      0

```

AC **SHIFT** **STAT** (S-MENU)
7 (Reg) **1** (A) **EXE**

```

STAT      D
A
-0.09344061817

```

SHIFT **STAT** (S-MENU)
7 (Reg) **2** (B) **EXE**

```

STAT      D
B
20.26709711

```

SHIFT **STAT** (S-MENU)
7 (Reg) **3** (r) **EXE**

```

STAT      D
r
0.9998526953

```

$x = 3.5 \rightarrow \hat{y} = ?$

3 **.** **5** **SHIFT** **STAT** (S-MENU)
7 (Reg) **5** (\hat{y}) **EXE**

```

STAT      D
3.5
5.697158557

```

$y = 15 \rightarrow \hat{x} = ?$

1 **5** **SHIFT** **STAT** (S-MENU)
7 (Reg) **4** (\hat{x}) **EXE**

```

STAT      D
15
1.342775158

```

◆ Command Usage Tips

- The commands included in the Reg sub-menu can take a long time to execute in logarithmic, e exponential, ab exponential, or power regression calculation when there are a large number of data samples.

Technical Information

■ Calculation Priority Sequence

The calculator performs calculations according to a calculation priority sequence.

- Basically, calculations are performed from left to right.
- Expressions within parentheses have the highest priority.
- The following shows the priority sequence for each individual command.

1. Function with parentheses:

Pol(, Rec(

sin(, cos(, tan(, \sin^{-1} (, \cos^{-1} (, \tan^{-1} (, sinh(, cosh(, tanh(, \sinh^{-1} (, \cosh^{-1} (, \tanh^{-1} (

log(, ln(, e^{\wedge} (, 10^{\wedge} (, $\sqrt{\quad}$ (, $\sqrt[3]{\quad}$ (

Abs(

Rnd(

2. Functions preceded by values, powers, power roots:

x^2 , x^3 , x^{-1} , $x!$, $^{\circ}$, r , g , \wedge (, $x\sqrt{\quad}$ (

Percent: %

3. Prefix symbol: (-) (negative sign)

4. Statistical estimated value calculation: \hat{x} , \hat{y} , \hat{x}_1 , \hat{x}_2

5. Permutations, combinations: nPr , nCr

6. Multiplication and division: \times , \div

Multiplication where sign is omitted: Multiplication sign omitted immediately before π , e , variables (2π , $5A$, πA , etc.), functions with parentheses ($2\sqrt{\quad}(3)$, $\text{Asin}(30)$, etc.)

7. Addition and subtraction: +, -

If a calculation contains a negative value, you may need to enclose the negative value in parentheses. If you want to square the value -2 , for example, you need to input: $(-2)^2$. This is because x^2 is a function preceded by a value (Priority 2, above), whose priority is greater than the negative sign, which is a prefix symbol (Priority 3).

Example:

$$-2^2 = -4$$

1. $\boxed{(-)}$ $\boxed{2}$
2. \boxed{CTLG}
3. “2” ($\boxed{\blacktriangle}$ $\boxed{\blacktriangledown}$), then \boxed{EXE} .
4. \boxed{EXE}

$$(-2)^2 = 4$$

1. $\boxed{(}$ $\boxed{(-)}$ $\boxed{2}$ $\boxed{)}$
2. \boxed{CTLG}
3. “2” ($\boxed{\blacktriangle}$ $\boxed{\blacktriangledown}$), then \boxed{EXE} .
4. \boxed{EXE}

Multiplication and division, and multiplication where the sign is omitted are the same priority (Priority 6), so these operations are performed from left to right when both types are mixed in the same calculation. Enclosing an operation within parentheses causes it to be performed first, so the use of parentheses can result in different calculation results.

Example:

$$1 \div 2\pi = 1.570796327$$

$\boxed{1}$ $\boxed{\div}$ $\boxed{2}$ \boxed{SHIFT} $\boxed{\times 10^x}$ $\boxed{(\pi)}$ \boxed{EXE}

$$1 \div (2\pi) = 0.1591549431$$

$\boxed{1}$ $\boxed{\div}$ $\boxed{(}$ $\boxed{2}$ \boxed{SHIFT} $\boxed{\times 10^x}$ $\boxed{(\pi)}$ $\boxed{)}$
 \boxed{EXE}

■ Stack Limitations

This calculator uses memory areas called *stacks* to temporarily store lower calculation priority sequence values, commands, and functions. The *numeric stack* has 10 levels and the *command stack* has 24 levels, as shown in the illustration below.

$$2 \times ((3 + 4 \times (5 + 4) \div 3) \div 5) + 8 =$$

Numeric Stack

①	2
②	3
③	4
④	5
⑤	4
⋮	

Command Stack

1	×
2	(
3	(
4	+
5	×
6	(
7	+
⋮	

A Stack ERROR occurs when the calculation you are performing causes the capacity of either stack to be exceeded.

■ Calculation Ranges, Number of Digits, and Precision

The calculation range, number of digits used for internal calculation, and calculation precision depends on the type of calculation you are performing.

Calculation Range and Precision

Calculation Range	$\pm 1 \times 10^{-99}$ to $\pm 9.999999999 \times 10^{99}$ or 0
Number of Digits for Internal Calculation	15 digits
Precision	In general, ± 1 at the 10th digit for a single calculation. Precision for exponential display is ± 1 at the least significant digit. Errors are cumulative in the case of consecutive calculations.

Function Calculation Input Ranges and Precision

Functions	Input Range	
$\sin x$	DEG	$0 \leq x < 9 \times 10^9$
	RAD	$0 \leq x < 157079632.7$
	GRA	$0 \leq x < 1 \times 10^{10}$
$\cos x$	DEG	$0 \leq x < 9 \times 10^9$
	RAD	$0 \leq x < 157079632.7$
	GRA	$0 \leq x < 1 \times 10^{10}$
$\tan x$	DEG	Same as $\sin x$, except when $ x = (2n-1) \times 90$.
	RAD	Same as $\sin x$, except when $ x = (2n-1) \times \pi/2$.
	GRA	Same as $\sin x$, except when $ x = (2n-1) \times 100$.
$\sin^{-1} x$ $\cos^{-1} x$	$0 \leq x \leq 1$	
$\tan^{-1} x$	$0 \leq x \leq 9.999999999 \times 10^{99}$	
$\sinh x$ $\cosh x$	$0 \leq x \leq 230.2585092$	
$\sinh^{-1} x$	$0 \leq x \leq 4.999999999 \times 10^{99}$	
$\cosh^{-1} x$	$1 \leq x \leq 4.999999999 \times 10^{99}$	
$\tanh x$	$0 \leq x \leq 9.999999999 \times 10^{99}$	

Functions	Input Range
$\tanh^{-1}x$	$0 \leq x \leq 9.999999999 \times 10^{-1}$
$\log x / \ln x$	$0 < x \leq 9.999999999 \times 10^{99}$
10^x	$-9.999999999 \times 10^{99} \leq x \leq 99.99999999$
e^x	$-9.999999999 \times 10^{99} \leq x \leq 230.2585092$
\sqrt{x}	$0 \leq x < 1 \times 10^{100}$
x^2	$ x < 1 \times 10^{50}$
$1/x$	$ x < 1 \times 10^{100}; x \neq 0$
$\sqrt[3]{x}$	$ x < 1 \times 10^{100}$
$x!$	$0 \leq x \leq 69$ (x is an integer)
nPr	$0 \leq n < 1 \times 10^{10}, 0 \leq r \leq n$ (n, r are integers) $1 \leq \{n!/(n-r)!\} < 1 \times 10^{100}$
nCr	$0 \leq n < 1 \times 10^{10}, 0 \leq r \leq n$ (n, r are integers) $1 \leq n!/r! < 1 \times 10^{100}$ or $1 \leq n!/(n-r)! < 1 \times 10^{100}$
$\text{Pol}(x, y)$	$ x , y \leq 9.999999999 \times 10^{99}$ $\sqrt{x^2+y^2} \leq 9.999999999 \times 10^{99}$
$\text{Rec}(r, \theta)$	$0 \leq r \leq 9.999999999 \times 10^{99}$ θ : Same as $\sin x$
$\wedge(x^y)$	$x > 0: -1 \times 10^{100} < y \log x < 100$ $x = 0: y > 0$ $x < 0: y = n, \frac{m}{2n+1}$ (m, n are integers) However: $-1 \times 10^{100} < y \log x < 100$
$x\sqrt{y}$	$y > 0: x \neq 0, -1 \times 10^{100} < 1/x \log y < 100$ $y = 0: x > 0$ $y < 0: x = 2n+1, \frac{2n+1}{m}$ ($m \neq 0; m, n$ are integers) However: $-1 \times 10^{100} < 1/x \log y < 100$

- Precision is basically the same as that described under “Calculation Range and Precision” on page E-137.
- $\wedge(xy)$, $x\sqrt{y}$, $\sqrt[3]{}$, $x!$, nPr , nCr type functions require consecutive internal calculation, which can cause accumulation of errors that occur with each calculation.
- Error is cumulative and tends to be large in the vicinity of a function’s singular point and inflection point.

Financial Calculation Ranges

P/Y C/Y	Natural number from 1 to 9999
PM1 PM2	Integer from 1 to 9999 PM1 < PM2
d1	January 1, 1901 through December 31, 2099 January 1, 1902 through December 30, 2097 (BOND Mode only)
d2	January 1, 1901 through December 31, 2099 January 2, 1902 through December 31, 2097 (BOND Mode only)
<i>j</i>	Positive natural number
YR1	Natural number from 1 to 12

■ Special Financial Calculation Error Messages

Compound Interest Mode

When calculating “*n*”

$I\% \leq -100$ Math ERROR

When calculating “ $I\%$ ”

“PV”, “PMT”, “FV” are the same sign
..... Math ERROR

$n \leq 0$ Math ERROR

When calculating “PV”, “PMT”, “FV”

$I\% \leq -100$ Math ERROR

Cash Flow Mode

When calculating “NPV”

$I\% \leq -100$ Math ERROR

When calculating “IRR”

Calculated “IRR” is $IRR \leq -50$ Math ERROR

All Receipt/Payment values are the same sign
..... Math ERROR

Depreciation Mode

When calculating “Depreciation”

One or more of “PV”, “FV”, “i%” is negative value	Math ERROR
$n > 255$	Math ERROR
$j > n + 1$ (YR1 \neq 12)	Math ERROR
YR1 > 12	Argument ERROR

Bond Mode

When calculating “PRC”

RDV ≥ 0 , CPN ≥ 0 not satisfied Math ERROR

When calculating “YLD”

CPN is greater than 0: RDV ≥ 0 , PRC < 0 not satisfied
..... Math ERROR



CPN is 0: RDV > 0 , PRC < 0 not satisfied
..... Math ERROR

■ Error Messages

The calculator will display an error message when a result exceeds the calculation range, when you attempt an illegal input, or whenever any other similar problem occurs.

◆ When an error message appears...

The following are general operations you can use when any error message appears.

- Pressing  or  displays to the calculation expression editing screen you were using before the error message appeared, with the cursor located at the position of the error. For more information, see “Displaying the Location of an Error” on page E-27.
- Pressing  clears the calculation expression you input before the error message appeared. You can then re-input and re-execute the calculation, if you want. Note that in this case, the original calculation will not be retained in calculation history memory.
- See “Special Financial Calculation Error Messages” (E-139) for information about error messages that may occur during financial calculations.

Math ERROR

Cause

- The intermediate or final result of the calculation you are performing exceeds the allowable calculation range.
- Your input exceeds the allowable input range.
- The calculation you are performing contains an illegal mathematical operation (such as division by zero).

Action

- Check the input values to ensure they are within the applicable calculation range. See “Calculation Ranges, Numbers of Digits, and Precision” on page E-137.
- When using independent memory or a variable as the argument of a function, make sure that the memory or variable value is within the allowable range for the function.

Stack ERROR

Cause

- The calculation you are performing has caused the capacity of the numeric stack or the command stack to be exceeded.

Action

- Simplify the calculation expression so it does not exceed the capacity of the stack.
- Try splitting the calculation into two or more parts.

Syntax ERROR

Cause

- There is a problem with the format of the calculation you are performing.

Action

- Make necessary corrections.

Insufficient MEM Error

Cause

- The number of bytes required to store the calculation you are inputting exceeds the maximum capacity (89 bytes) for Shortcut key assignment.

Action

- Divide the calculation into smaller parts.
- Normally the input cursor appears as a straight vertical (|) or horizontal (—) flashing line on the display screen. When there are 10 or fewer bytes of input remaining in

the current expression, the cursor changes shape to **█** to let you know. If the **█** cursor appears, terminate the expression at a convenient point and calculate the result.

Argument ERROR

Cause

- Financial conditions insufficient for financial calculations (such as $YR1 > 12$).

Action

- Check the input values to ensure they are within the applicable calculation range. See “Calculation Ranges, Numbers of Digits, and Precision” on page E-137.

█ Before assuming malfunction of the calculator...

Perform the following steps whenever an error occurs during a calculation or when calculation results are not what you expected. If one step does not correct the problem, move on to the next step.

Note that you should make separate copies of important data before performing these steps.

1. Check the calculation expression to make sure that it does not contain any errors.
2. Make sure that you are using the correct mode for the type of calculation you are trying to perform.
3. If the above steps do not correct your problem, press the **ON** key. This will cause the calculator to perform a routine that checks whether calculation functions are operating correctly. If the calculator discovers any abnormality, it automatically initializes the calculation mode and clears memory contents. For details about initialized settings, see “Initializing the Calculator” on page E-3.
4. Initialize all modes and settings by performing the following operation:
 - (1) **ON** **SHIFT** **9** (CLR)
 - (2) “All:EXE” (**▲** **▼**), then **EXE**.
 - (3) **EXE** (Yes)
 - (4) **AC**

Reference

■ Power Requirements and Battery Replacement

FC-200V

Your calculator uses a TWO WAY POWER system that combines a solar cell with G13 type button battery (LR44). Normally, calculators equipped with a solar cell alone can operate only when relatively bright light is present. The TWO WAY POWER system, however, lets you continue to use the calculator as long as there is enough light to read the display.

◆ Replacing the Battery

Dim display figures when available lighting is dim or failure of anything to appear on the display immediately when you turn on the calculator indicates that button battery power is low. Note that you will not be able to use the calculator if its button battery is dead. When any of these symptoms occur, replace the button battery.

Even if the calculator is operating normally, replace the battery at least once every three years.

Important!

- Removing the button battery from the calculator causes independent memory contents and values assigned to variables to be cleared.

1. Press **SHIFT** **AC** (OFF) to turn off the calculator.
 - To ensure that you do not accidentally turn on power while replacing the battery, slide the hard case onto the front of the calculator.
2. On the back of the calculator, remove the screw and the battery cover.
3. Remove the old battery.

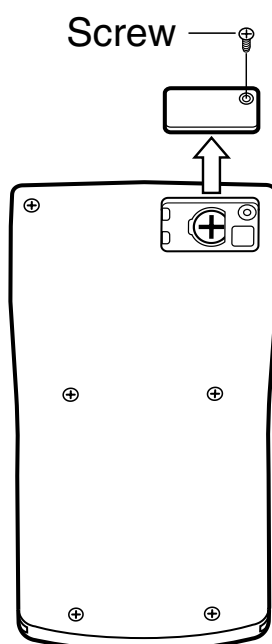

4. Wipe a new battery with a dry cloth, and then load it into the calculator with its positive ⊕ side facing upwards (so you can see it).
5. Replace the battery cover and secure it in place with its screw.
6. Perform the following key operation:
 - (1) **ON** **SHIFT** **9** (CLR)
 - (2) “All:EXE” (▲ ▼), then **EXE**
 - (3) **EXE** (Yes)
 - (4) **AC**
 - Make sure you perform the above key operation. Do not skip it.
 - Replacing the battery initializes the calculator, including the custom shortcut keys and function shortcut keys. See “Initializing the Calculator” (page E-3) for more information.

FC-100V

This calculator is powered by a single AAA-size battery (R03 (UM-4)).

◆ Replacing the Battery

Dim figures on the display of the calculator indicate that battery power is low. Continued use of the calculator when the battery is low can result in improper operation. Replace the battery as soon as possible when display figures becomes dim.

Even if the calculator is operating normally, replace the battery at least once every two years.

Important!

- Removing the battery from the calculator causes independent memory contents and values assigned to variables to be cleared.

1. Press **SHIFT** **AC** (OFF) to turn off the calculator.
2. On the back of the calculator, remove the screws and the back cover.
3. Remove the old battery.
4. Load a new battery into the calculator with its positive \oplus and negative \ominus ends facing correctly.
5. Replace the back cover and secure it in place with its screws.

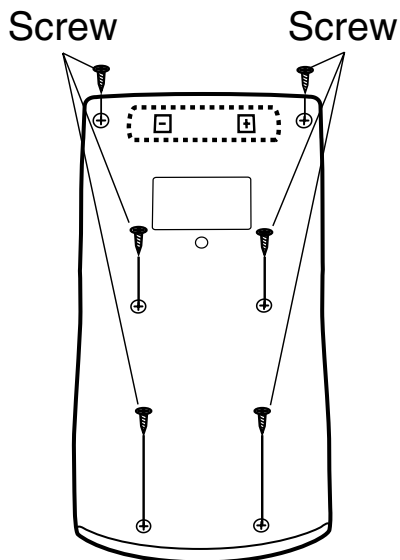

6. Perform the following key operation:

(1) **ON** **SHIFT** **9** (CLR)

(2) “All:EXE” (**▲** **▼**), then **EXE**

(3) **EXE** (Yes)

(4) **AC**

- Make sure you perform the above key operation. Do not skip it.

Auto Power Off

Your calculator will turn off automatically if you do not perform any operation for about six minutes. If this happens, press the **ON** key to turn the calculator back on.

Specifications

FC-200V

Power Requirements:

Solar Cell: Built into the front of the calculator

Button Battery: G13 Type (LR44) × 1

Battery Life: Approximately 3 years (Based on one hour of operation per day.)

Operating Temperature: 0°C to 40°C

Dimensions: 12.2 (H) × 80 (W) × 161 (D) mm

$1/2''$ (H) × $3 1/8''$ (W) × $6 5/16''$ (D)

Approximate Weight: 105g (3.7 oz) including the battery

Bundled Items: Hard Case

FC-100V

Power Requirements:

AAA-size battery: R03 (UM-4) × 1

Battery Life: Approximately 17,000 hours (continuous display of flashing cursor)

Power Consumption: 0.0002 W

Operating Temperature: 0°C to 40°C

Dimensions: 13.7 (H) × 80 (W) × 161 (D) mm

$9/16''$ (H) × $3 1/8''$ (W) × $6 5/16''$ (D)

Approximate Weight: 110 g (3.9 oz) including the battery

Bundled Items: Hard Case

CASIO®

CASIO COMPUTER CO., LTD.

6-2, Hon-machi 1-chome
Shibuya-ku, Tokyo 151-8543, Japan

SA0904-E