

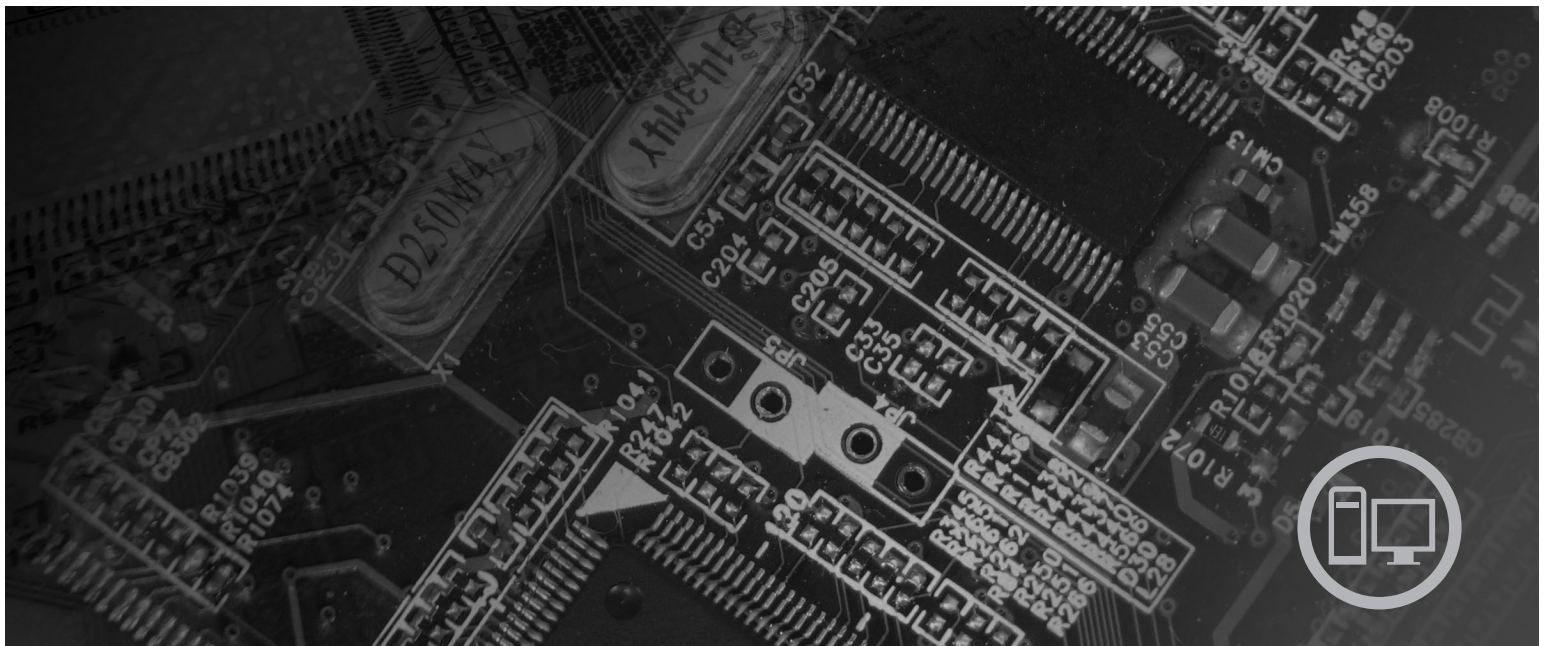

# ThinkCentre User Guide



**Machine Types** 6008, 6010, 6019, 6062, 6064, 6065, 6066, 6067, 6068, 6069, 6071, 6072, 6073, 6074, 6075, 6076, 6077, 6078, 6079, 6081, 6082, 6086, 6087, 6088, 6089, 7103, 9011, 9012, 9013, 9014, 9018, 9019, 9071, 9087, 9088, 9089, 9096, 9160, 9162, 9163, 9164, 9172, 9174, 9181, 9182, 9193, 9194, 9196, 9303, 9304, 9323, 9325, 9326, 9330, 9967, 9970, 9978, 9979



***lenovo***

ThinkCentre  
User Guide

**Note**

Before using this information and the product it supports, be sure to read the *Safety and Warranty Guide* that came with this product and Appendix B, "Notices," on page 67.

**Second Edition (January 2009)**

**© Copyright Lenovo 2007, 2009. All rights reserved.**

LENOVO products, data, computer software, and services have been developed exclusively at private expense and are sold to governmental entities as commercial items as defined by 48 C.F.R. 2.101 with limited and restricted rights to use, reproduction and disclosure.

LIMITED AND RESTRICTED RIGHTS NOTICE: If products, data, computer software, or services are delivered pursuant a General Services Administration "GSA" contract, use, reproduction, or disclosure is subject to restrictions set forth in Contract No. GS-35F-05925.

# Contents

|  |           |   |           |
|--|-----------|---|-----------|
| <b>Introduction</b> . . . . .                                  | <b>v</b>  | Setting, changing, and deleting a password. . . . .       | 32        |
| <b>Chapter 1. Important safety information</b> . . . . .       | <b>1</b>  | Using Security Profile by Device . . . . .                | 32        |
| <b>Chapter 2. Arranging your workspace</b> . . . . .           | <b>3</b>  | Selecting a startup device. . . . .                       | 33        |
| Comfort . . . . .  | 3         | Selecting a temporary startup device . . . . .            | 33        |
| Glare and lighting . . . . .                                   | 3         | Selecting or changing the startup device sequence         | 33        |
| Air circulation . . . . .                                      | 4         | Advanced settings . . . . .                               | 34        |
| Electrical outlets and cable lengths . . . . .                 | 4         | Exiting from the Setup Utility program . . . . .          | 34        |
| <b>Chapter 3. Setting up your computer</b> . . . . .           | <b>5</b>  | <b>Chapter 6. Updating system programs</b> . . . . .      | <b>35</b> |
| Connecting your computer . . . . .                             | 5         | Using system programs . . . . .                           | 35        |
| Turning on computer power. . . . .                             | 10        | Updating (flashing) BIOS from a diskette or               |           |
| Finishing the software installation . . . . .                  | 10        | CD-ROM . . . . .  | 35        |
| Completing important tasks . . . . .                           | 10        | Updating (flashing) BIOS from your operating              |           |
| Updating your operating system . . . . .                       | 11        | system . . . . .  | 36        |
| Installing other operating systems . . . . .                   | 11        | Recovering from a POST/BIOS update failure. . . . .       | 36        |
| Updating your antivirus software . . . . .                     | 11        | <b>Chapter 7. Troubleshooting and</b>                     |           |
| Shutting down the computer . . . . .                           | 11        | <b>diagnostics</b> . . . . .                              | <b>39</b> |
| Installing external options . . . . .                          | 11        | Basic troubleshooting . . . . .                           | 39        |
| Features for machine types: 6008, 6068, 6074, 6079,            |           | Diagnostic programs . . . . .                             | 40        |
| 6082, 9012, 9018, 9087, 9096, 9163, 9172, 9193 . . . . .       | 12        | PC-Doctor for Windows . . . . .                           | 41        |
| Features for machine types: 6010, 6069, 6075, 6081,            |           | PC-Doctor for DOS . . . . .                               | 41        |
| 6086, 9013, 9019, 9088, 9160, 9164, 9174, 9194, 9304,          |           | PC-Doctor for Windows PE . . . . .                        | 43        |
| 9323, 9326, 9978, 9979 . . . . .                               | 15        | Cleaning the mouse . . . . .                              | 43        |
| Features for machine types: 6019, 6064, 6066, 6067,            |           | Optical mouse . . . . .                                   | 43        |
| 6072, 6073, 6077, 6078, 6087, 6088, 9181, 9196, 9325,          |           | Non-optical mouse . . . . .                               | 44        |
| 9330, 9967, 9970 . . . . .                                     | 18        | <b>Chapter 8. Recovering software</b> . . . . .           | <b>47</b> |
| Features for machine types: 6062, 6065, 6071, 6076,            |           | Creating and using the Product Recovery disc. . . . .     | 47        |
| 6089, 7103, 9011, 9014, 9071, 9089, 9162, 9182, 9303 . . . . . | 21        | Performing backup and recovery operations . . . . .       | 48        |
| Specifications for machine types: 6008, 6068, 6074,            |           | Using the Rescue and Recovery workspace. . . . .          | 49        |
| 6079, 6082, 9012, 9018, 9087, 9096, 9163, 9172, 9193 . . . . . | 24        | Creating and using rescue media . . . . .                 | 50        |
| Specifications for machine types: 6010, 6069, 6075,            |           | Creating and using a Recovery Repair diskette . . . . .   | 51        |
| 6081, 6086, 9013, 9019, 9088, 9160, 9164, 9174, 9194,          |           | Recovering or installing device drivers . . . . .         | 52        |
| 9304, 9323, 9326, 9978, 9979 . . . . .                         | 25        | Setting a rescue device in the startup sequence . . . . . | 53        |
| Specifications for machine types: 6019, 6064, 6066,            |           | Solving recovery problems . . . . .                       | 53        |
| 6067, 6072, 6073, 6077, 6078, 6087, 6088, 9181, 9196,          |           | <b>Chapter 9. Getting information, help,</b>              |           |
| 9325, 9330, 9967, 9970 . . . . .                               | 26        | <b>and service</b> . . . . .                              | <b>55</b> |
| Specifications for machine types: 6062, 6065, 6071,            |           | Information resources . . . . .                           | 55        |
| 6076, 6089, 7103, 9011, 9014, 9071, 9089, 9162, 9182,          |           | Online Books folder . . . . .                             | 55        |
| 9303 . . . . .   | 27        | ThinkVantage Productivity Center. . . . .                 | 55        |
| <b>Chapter 4. Software overview</b> . . . . .                  | <b>29</b> | Access Help . . . . .                                     | 56        |
| Software provided with your Windows operating                  |           | Safety and Warranty . . . . .                             | 56        |
| system . . . . .   | 29        | www.lenovo.com . . . . .                                  | 56        |
| Software provided by Lenovo . . . . .                          | 29        | Help and service . . . . .                                | 57        |
| <b>Chapter 5. Using the Setup Utility</b> . . . . .            | <b>31</b> | Using the documentation and diagnostic                    |           |
| Starting the Setup Utility program. . . . .                    | 31        | programs . . . . .  | 57        |
| Viewing and changing settings . . . . .                        | 31        | Calling for service . . . . .                             | 57        |
| Using passwords . . . . .                                      | 31        | Using other services . . . . .                            | 58        |
| Password considerations . . . . .                              | 31        | Purchasing additional services . . . . .                  | 58        |
| User Password . . . . .  | 32        | <b>Appendix A. Manual modem</b>                           |           |
| Administrator Password . . . . .                               | 32        | <b>commands</b> . . . . .                                 | <b>59</b> |

Basic AT commands . . . . . 59  
Extended AT commands . . . . . 61  
MNP/V.42/V.42bis/V.44 commands . . . . . 62  
Fax Class 1 commands . . . . . 63  
Fax Class 2 commands . . . . . 63  
Voice commands. . . . . 64

**Appendix B. Notices . . . . . 67**  
Television output notice . . . . . 68  
Trademarks . . . . . 68  
**Index . . . . . 69**

---

## Introduction

This *User Guide* contains the following information:

- Chapter 1, “Important safety information,” on page 1 provides information about where to find safety information for this product.
- Chapter 2, “Arranging your workspace,” on page 3 provides information about setting up your computer for comfort and the impact of light sources, air circulation, and electrical outlets.
- Chapter 3, “Setting up your computer,” on page 5 provides information about setting up your computer and software and operating system installation.
- Chapter 4, “Software overview,” on page 29 contains an overview of the factory installed software installed on your computer.
- Chapter 5, “Using the Setup Utility,” on page 31 provides instructions on how to view and change the configuration settings of your computer.
- Chapter 6, “Updating system programs,” on page 35 provides information about updating POST/BIOS and how to recover from a POST/BIOS update failure.
- Chapter 7, “Troubleshooting and diagnostics,” on page 39 provides information about basic troubleshooting and diagnostic tools for your computer.
- Chapter 8, “Recovering software,” on page 47 provides instructions on how to use the ThinkVantage® Rescue and Recovery™ program to create product recovery disks, back up data, recover software, and restore the entire contents of your hard disk drive to a previously saved state.
- Chapter 9, “Getting information, help, and service,” on page 55 provides information about the wide variety of helpful resources available from Lenovo®.
- Appendix A, “Manual modem commands,” on page 59 provides commands for manually programming your modem.
- Appendix B, “Notices,” on page 67 provides notices and trademark information.





---

## Chapter 1. Important safety information

**CAUTION:**

Before using this manual, it is important that you read and understand all the related safety information for this product. Refer to the *Safety and Warranty Guide* that you received with this product for the latest safety information. Reading and understanding this safety information reduces the risk of personal injury and or damage to your product.



---

## Chapter 2. Arranging your workspace

To get the most from your computer, arrange both the equipment you use and your work area to suit your needs and the kind of work you do. Your comfort is of foremost importance, but light sources, air circulation, and the location of electrical outlets can also affect the way you arrange your workspace.

---

### Comfort

Although no single working position is ideal for everyone, here are a few guidelines to help you find a position that suits you best.

Sitting in the same position for a long time can cause fatigue. The backrest and seat of your chair should adjust independently and provide good support. The seat should have a curved front to relieve pressure on the thighs. Adjust the seat so that your thighs are parallel to the floor and your feet are either flat on the floor or on a footrest.

When using the keyboard, keep your forearms parallel to the floor and your wrists in a comfortable position. Use a light touch on the keyboard and your hands and fingers relaxed. Change the angle of the keyboard for maximum comfort by adjusting the position of the keyboard feet.

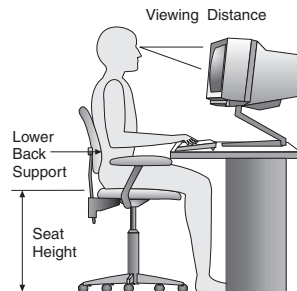

Adjust the monitor so the top of the screen is at, or slightly below, eye level. Place the monitor at a comfortable viewing distance, usually 51 to 61 cm (20 to 24 in.), and position it so you can view it without having to twist your body. Also, position other equipment you use regularly, such as the telephone or a mouse, within easy reach.

---

### Glare and lighting

Position the monitor to minimize glare and reflections from overhead lights, windows, and other light sources. Reflected light from shiny surfaces can cause annoying reflections on your monitor screen. Place the monitor at right angles to windows and other light sources, when possible. Reduce overhead lighting, if necessary, by turning off lights or using lower wattage bulbs. If you install the monitor near a window, use curtains or blinds to block the sunlight. You can adjust the brightness and contrast controls on the monitor as the room lighting changes throughout the day.

Where it is impossible to avoid reflections or to adjust the lighting, an antiglare filter placed over the screen might be helpful. However, these filters might affect the clarity of the image on the screen; try them only after you have exhausted other methods of reducing glare.

Dust buildup compounds problems associated with glare. Remember to clean your monitor screen periodically using a soft cloth moistened with a nonabrasive liquid glass cleaner.

---

## Air circulation

Your computer and monitor produce heat. The computer has a fan that pulls in fresh air and forces out hot air. The monitor lets hot air escape through vents. Blocking the air vents can cause overheating, which might result in a malfunction or damage. Place the computer and monitor so that nothing blocks the air vents; usually, 51 mm (2 in.) of air space is sufficient. Also, make sure the vented air is not blowing on someone else.

---

## Electrical outlets and cable lengths

The location of electrical outlets, the length of power cords and cables that connect to the monitor, printer, and other devices might determine the final placement of your computer.

When arranging your workspace:

- Avoid the use of extension cords. When possible, plug the computer power cord directly into an electrical outlet.
- Keep power cords and cables neatly routed away from walkways and other areas where they might get kicked accidentally.

For more information about power cords, refer to the *Safety and Warranty Guide* that was provided with your computer.

---

## Chapter 3. Setting up your computer

Read and understand the *Safety and Warranty Guide* before you set up your computer. Reading and understanding the safety information reduces the risk of personal injury and or damage to your product.

Set up your computer in the best possible work area that suits your needs and habits. For more information, see Chapter 2, "Arranging your workspace," on page 3.

---

### Connecting your computer

Use the following information when connecting your computer.

- Look for the small connector icons on the back of your computer. Match the connectors to the icons.
- If your computer cables and connector panel have color-coded connectors, match the color of the cable end with the color of the connector. For example, match a blue cable end with a blue connector or a red cable end with a red connector.

**Note:** Depending on your model type, your computer might not have all of the connectors that are described in this section.

1. Check the position of the voltage-selection switch on the rear of the computer. Use a ballpoint pen to slide the switch, if necessary.

**Note:** Some computers do not have a voltage switch. These computers automatically control the voltage.

- If the voltage supply range is 100–127 V ac, set the switch to 115 V.
- If the voltage supply range is 200–240 V ac, set the switch to 230 V.

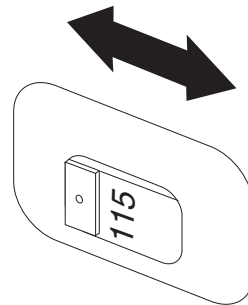

2. Connect the keyboard cable to the appropriate keyboard connector, either the standard keyboard connector **1** or the Universal Serial Bus (USB) connector **2**.

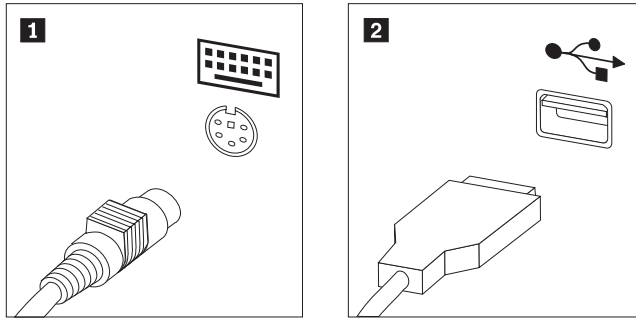

**Note:** Some models will have keyboards with a fingerprint reader. After you setup and turn on your computer, refer to the Access Help online help system for information about your fingerprint reader. See “Access Help” on page 56 for instructions on how to open the online help system.

3. Connect the USB mouse cable to the USB connector.

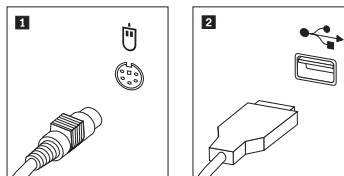

4. Connect the monitor cable to the monitor connector on the computer.
  - If you have a Video Graphics Array (VGA) Standard monitor, connect the cable to the connector as shown.

**Note:** If your model has two monitor connectors, be sure to use the connector on the graphics adapter.

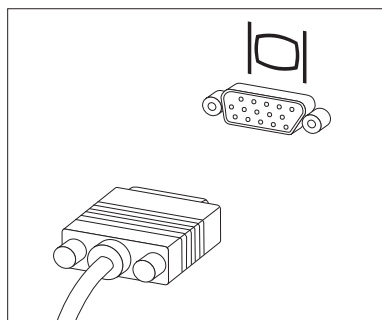

- If you have a digital video interface (DVI) monitor, your computer must have an adapter installed that supports the DVI monitor. Connect the cable to the connector as shown.

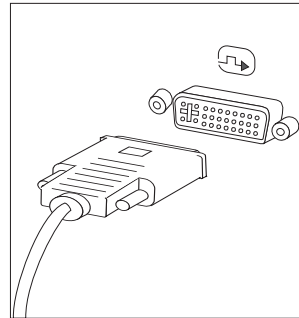

5. If you have a modem, connect the modem using the following information.

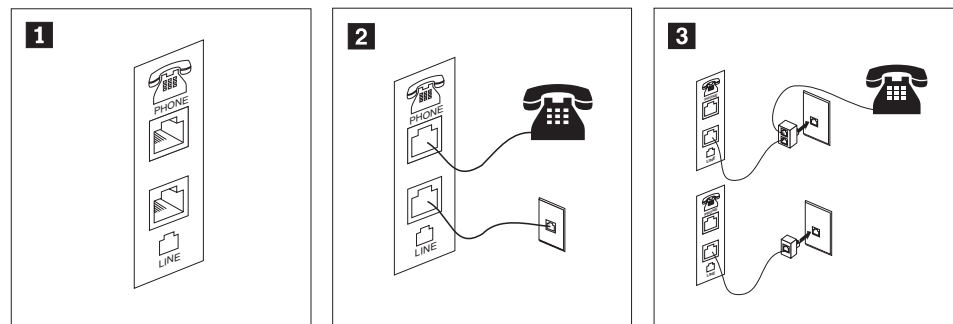

- 1** This illustration shows the two connections on the back of the computer that are needed to set up your modem.
- 2** In the United States and other countries or regions that use the RJ-11 telephone outlet, attach one end of the telephone cable to the telephone and the other end to the telephone connector on the back of the computer. Attach one end of the modem cable to the modem connector on the back of the computer and the other end to the telephone outlet.
- 3** In countries or regions that do not use RJ-11 telephone outlets, a splitter or converter is required to attach the cables to the telephone outlet, as shown at the top of the illustration. You also can use the splitter or converter without the telephone, as shown at the bottom of the illustration.

6. If you have audio devices, attach them using the following instructions. For more information about speakers, see steps 7 and 8 on page 8.

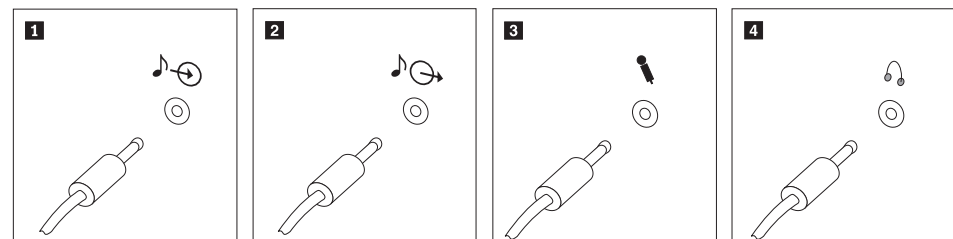

- 1** Audio line-in This connector receives audio signals from an external audio device, such as a stereo system.
- 2** Audio line-out This connector sends audio signals from the computer to external devices, such as powered stereo speakers.
- 3** Microphone Use this connector to attach a microphone to your computer when you want to record sound or if you use speech-recognition software.
- 4** Headphone Use this connector to attach headphones to your computer when you want to listen to music or other sounds without disturbing anyone. This connector might be located on the front of the computer.

7. If you have *powered* speakers with an ac power adapter:

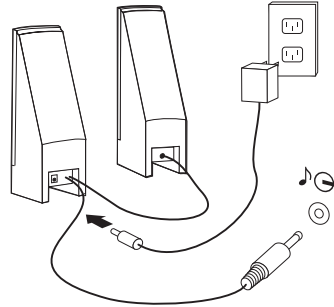

- a. Connect the cable that runs between the speakers, if necessary. On some speakers, this cable is permanently attached.
  - b. Connect the ac power adapter cable to the speaker.
  - c. Connect the speakers to the computer.
  - d. Connect the ac power adapter to the ac power source.
8. If you have *unpowered* speakers with no ac power adapter:

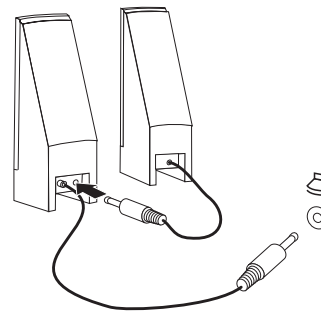

- a. Connect the cable that runs between the speakers, if necessary. On some speakers, this cable is permanently attached.
- b. Connect the speakers to the computer.



9. Connect any additional devices that you have. Your computer might not have all connectors that are shown.

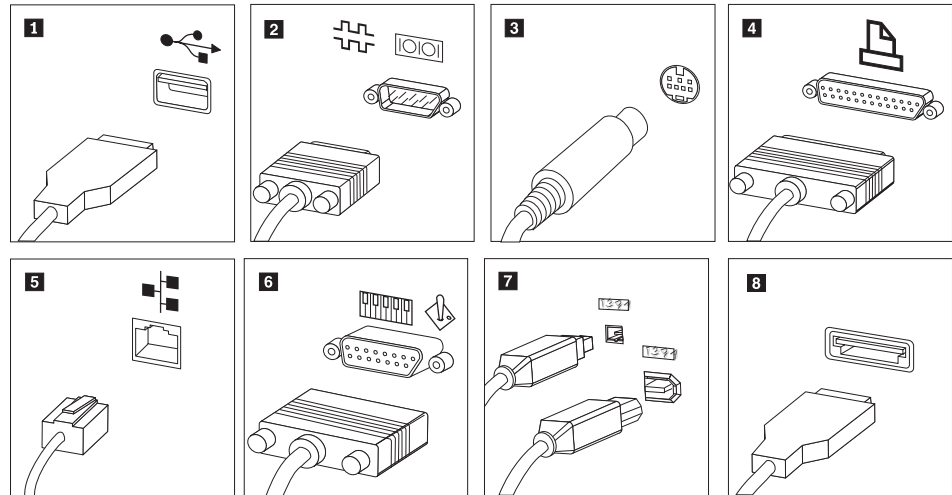

- |   |               |  |
|---|---------------|--|
| <b>1</b>  | USB           | Use this connector to attach a device that requires a USB connection, such as a keyboard, mouse, scanner, printer, or personal digital assistant (PDA).  |
| <b>2</b>  | Serial        | Use this connector to attach an external modem, serial printer, or other device that uses a 9-pin serial connector.  |
| <b>3</b>  | S-video       | Use this connector to attach a television set that has an S-Video connector. This connector is present on some high-performance video adapters.  |
| <b>4</b>  | Parallel      | Use this connector to attach a parallel printer or any other device that requires a 25-pin parallel connection.  |
| <b>5</b>  | Ethernet      | Use this connector to attach the computer to an Ethernet-type local area network or to a cable modem.  |
| <b>Important:</b> To operate the computer within FCC limits when it is connected to an Ethernet network, use a Category 5 Ethernet cable. |               |  |
| <b>6</b>  | MIDI/joystick | Use this connector to attach a joystick, gamepad, or a musical instrument digital interface (MIDI) device such as a MIDI keyboard.   |
| <b>7</b>  | IEEE 1394     | This connector is sometimes called Firewire because it transmits data rapidly. There are two types of IEEE 1394 connectors: the 4-pin and the 6-pin. IEEE 1394 offers connection to several types of consumer electronics, including digital audio devices and scanners. |
| <b>8</b>  | eSATA         | Use this connector to attach an external hard disk drive   |

10. Connect the power cords to properly grounded electrical outlets.

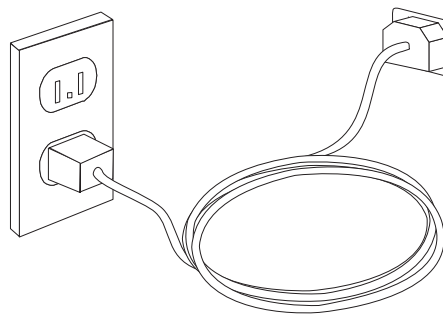

**Note:** For more information about connectors, refer to the Access Help online help system. See “Access Help” on page 56 for instructions on how to open the online help system.

---

## Turning on computer power

Turn on the monitor and other external devices first, and then turn on the computer. When the power-on self-test (POST) is finished, the logo window closes. If your computer has preinstalled software, the software installation program starts.

If you experience any problems during startup, see Chapter 7, “Troubleshooting and diagnostics,” on page 39. For additional help, refer to Chapter 9, “Getting information, help, and service,” on page 55. You can get help and information by telephone through the Customer Support Center. Refer to the safety and warranty information that is provided with your computer for the Service and Support worldwide telephone list.

---

## Finishing the software installation

### Important

Read the license agreements carefully before using the programs on this computer. These agreements detail your rights, obligations, and warranties for the software on this computer. By using these programs, you accept the terms of the agreements. If you do not accept the agreements, do not use the programs. Instead, promptly return the entire computer for a full refund.

The first time you start your computer, follow the instructions on the screen to complete the software installation. If you do not complete the software installation the first time the computer is turned on, unpredictable results might occur. When the installation is complete, refer to the Access Help online help system to learn more about your computer. See “Access Help” on page 56 for instructions on how to open the online help system.

**Note:** Some models might have a multilingual version of Microsoft® Windows® operating system preinstalled. If your computer has the multilingual version, you will be prompted to choose a language during the installation process. After installation, the language version can be changed through the Windows Control Panel.

---

## Completing important tasks

After you have set up your computer, perform the following tasks, which will save you time and trouble later:

- Create a diagnostic CD image, diagnostic diskettes, or rescue media. Diagnostic programs are used to test hardware components of your computer and report operating-system-controlled settings that can cause hardware failures. Making a diagnostic CD image, diagnostic diskettes, or rescue media ahead of time assures that you will be able to run diagnostics if the Rescue and Recovery workspace becomes inaccessible. For more information, see “PC-Doctor for DOS” on page 41 or “PC-Doctor for Windows PE” on page 43.

- Record your computer machine type, model, and serial number. If you need service or technical support, you will probably be asked for this information. For further information, refer to the safety and warranty information that is provided with your computer.

---

## Updating your operating system

Microsoft makes updates available for various operating systems through the Microsoft Windows Update Web site. The Web site automatically determines what Windows updates are available for your specific computer and lists those updates only. Updates could include security fixes, new versions of Windows components (such as media player), fixes to other portions of the Windows operating system, or enhancements.

For more information about updating your operating system, refer to the Access Help online help system . See “Access Help” on page 56 for instructions on how to open the online help system.

---

## Installing other operating systems

If you install your own operating system, follow the instructions that come with your operating system CDs or diskettes. Remember to install all device drivers after you install your operating system. Installation instructions are usually provided with the device drivers.

---

## Updating your antivirus software

Your computer comes with antivirus software you can use to detect and eliminate viruses. Lenovo provides a full version of antivirus software on your hard disk drive with a free 90-day subscription. After 90 days, you must get a new virus definition.

For more information about updating your antivirus software, refer to the Access Help online help system . See “Access Help” on page 56 for instructions on how to open the online help system.

---

## Shutting down the computer

When you turn off your computer, always follow the shutdown procedure for your operating system. This prevents the loss of unsaved data or damage to your software programs. To shut down the Microsoft Windows operating system, open the **Start** menu from the Windows desktop, click **Shut Down**. Select **Shut Down** from the drop down menu and click **OK**.

---

## Installing external options

For information about installing external options for your computer, refer to “Installing external options” in the *Hardware Installation and Replacement Guide*.

---

## Features for machine types: 6008, 6068, 6074, 6079, 6082, 9012, 9018, 9087, 9096, 9163, 9172, 9193

This section provides an overview of the computer features and preinstalled software.

### System information

The following information covers a variety of models. For information for your specific model, use the Setup Utility. See Chapter 5, "Using the Setup Utility," on page 31.

### Microprocessor

- Intel® Pentium® dual-core processor
- Intel Celeron® processor
- Intel Core™ 2 Duo processor
- Intel Core 2 Quad processor
- Internal cache (size varies by model type)

### Memory

- Support for four double data rate 2 dual inline memory modules (DDR2 DIMMs)
- Flash memory for system programs (varies by model type)

### Internal drives

- Diskette drive (some models)
- Serial Advanced Technology Attachment (SATA II) internal hard disk drive
- Optical drive (some models)

### Video subsystem

- An integrated graphics controller for a Video Graphics Array (VGA) monitor
- Intel Graphics Media Accelerator with dual display support (ADD2 card is needed for dual display)
- PCI Express (x16) graphics adapter connector on the system board

### Audio subsystem

- HD with ADI 1882 Audio Codec
- Microphone and headphone connectors on the front panel
- Line in, line out, and microphone connectors on the rear panel
- Mono internal speaker

### Connectivity

- 10/100/1000 Mbps integrated Ethernet controller
- Peripheral Component Interconnect (PCI) V.90 Data/Fax modem (some models)

### System management features

- Preboot Execution Environment (PXE) and Dynamic Host Configuration Protocol (DHCP)
- Wake on LAN®

- Wake on Ring (in the Setup Utility program, this feature is called Serial Port Ring Detect for an external modem)
- Remote Administration
- Automatic power-on startup
- System Management (SM) BIOS and SM software
- Ability to store power-on self-test (POST) hardware test results

**Input/output features**

- 25-pin Extended Capabilities Port (ECP)/Extended Parallel Port (EPP)
- 9-pin serial connector
- Eight USB connectors (two on front panel and six on rear panel)
- Standard mouse connector
- Standard keyboard connector
- Ethernet connector
- VGA monitor connector
- Three audio connectors (line in, line out, and microphone) on rear panel
- Two audio connectors (microphone and headphone) on front panel
- One eSATA connector through PCI bracket (some models)

### **Expansion**

- Three drive bays
- Two 32-bit PCI adapter connector
- One PCI Express x1 adapter connector

### **Power**

- 280 Watt power supply with autosensing voltage switching
- Automatic 50/60 Hz input frequency switching
- Advanced Configuration and Power Interface (ACPI) support

### **Security features**

- User and administrator passwords for BIOS access
- Support for the addition of an integrated cable lock (Kensington lock)
- Keyboard with fingerprint reader (some models, see the ThinkVantage Productivity Center program for more information)
- Cover presence switch (some models)
- Startup sequence control
- Startup without diskette drive, keyboard, or mouse
- Unattended start mode
- Diskette and hard disk drive I/O control
- Serial and parallel port I/O control
- Security profile by device

### **Preinstalled software**

Your computer might come with preinstalled software. If it does, an operating system, device drivers to support built-in features, and other support programs are included.

### **Operating systems, preinstalled** (varies by model)

**Note:** Not all countries or regions have these operating systems.

- Microsoft Windows XP Home
- Microsoft Windows XP Professional
- Microsoft Windows Vista®

### **Operating systems, certified or tested for compatibility**<sup>1</sup> (varies by model)

Linux®

---

1. The operating systems listed here are being certified or tested for compatibility at the time this publication goes to press. Additional operating systems might be identified by Lenovo as compatible with your computer following the publication of this booklet. Corrections and additions to this list are subject to change. To determine if an operating system has been certified or tested for compatibility, check the Web site of the operating system vendor.

---

## Features for machine types: 6010, 6069, 6075, 6081, 6086, 9013, 9019, 9088, 9160, 9164, 9174, 9194, 9304, 9323, 9326, 9978, 9979

This section provides an overview of the computer features and preinstalled software.

### System information

The following information covers a variety of models. For information for your specific model, use the Setup Utility. See Chapter 5, "Using the Setup Utility," on page 31.

#### Microprocessor

- Intel Pentium dual core processor
- Intel Celeron processor
- Intel Core 2 Duo processor
- Intel Core 2 Quad processor
- Internal cache (size varies by model type)

#### Memory

- Support for four double data rate 2 dual inline memory modules (DDR2 DIMMs)
- Flash memory for system programs (varies by model type)

#### Internal drives

- Diskette drive (some models)
- Serial Advanced Technology Attachment (SATAII) internal hard disk drive
- Optical drive (some models)

#### Video subsystem

- An integrated graphics controller for a Video Graphics Array (VGA) monitor
- Intel Graphics Media Accelerator with dual display support (ADD2 card is needed for dual display)
- PCI Express (x16) graphics adapter connector on the system board

#### Audio subsystem

- HD with ADI 1882 Audio Codec
- Microphone and headphone connectors on the front panel
- Line in, line out, and microphone connectors on the rear panel
- Mono internal speaker

#### Connectivity

- 10/100/1000 Mbps integrated Ethernet controller
- Peripheral Component Interconnect (PCI) V.90 Data/Fax modem (some models)

#### System management features

- Preboot Execution Environment (PXE) and Dynamic Host Configuration Protocol (DHCP)
- Wake on LAN

- Wake on Ring (in the Setup Utility program, this feature is called Serial Port Ring Detect for an external modem)
- Remote Administration
- Automatic power-on startup
- System Management (SM) BIOS and SM software
- Ability to store power-on self-test (POST) hardware test results

**Input/output features**

- 25-pin Extended Capabilities Port (ECP)/Extended Parallel Port (EPP)
- 9-pin serial connector
- Eight USB connectors (two on front panel and six on rear panel)
- Standard mouse connector
- Standard keyboard connector
- Ethernet connector
- VGA monitor connector
- Three audio connectors (line in, line out, and microphone) on rear panel
- Two audio connectors (microphone and headphone) on front panel
- One eSATA connector through PCI bracket (some models)



### **Expansion**

- Five drive bays
- Two 32-bit PCI adapter connector
- One PCI Express x1 adapter connector

### **Power**

- 280 Watt power supply with manual voltage selection switch
- Automatic 50/60 Hz input frequency switching
- Advanced Configuration and Power Interface (ACPI) support

### **Security features**

- User and administrator passwords for BIOS access
- Support for the addition of an integrated cable lock (Kensington lock)
- Keyboard with fingerprint reader (some models, see the ThinkVantage Productivity Center program for more information)
- Cover presence switch (some models)
- Startup sequence control
- Startup without diskette drive, keyboard, or mouse
- Unattended start mode
- Diskette and hard disk drive I/O control
- Serial and parallel port I/O control
- Security profile by device

### **Preinstalled software**

Your computer might come with preinstalled software. If it does, an operating system, device drivers to support built-in features, and other support programs are included.

### **Operating systems, preinstalled** (varies by model)

**Note:** Not all countries or regions have these operating systems.

- Microsoft Windows XP Home
- Microsoft Windows XP Professional
- Microsoft Windows Vista

### **Operating systems, certified or tested for compatibility<sup>2</sup>** (varies by model)

Linux

---

2. The operating systems listed here are being certified or tested for compatibility at the time this publication goes to press. Additional operating systems might be identified by Lenovo as compatible with your computer following the publication of this booklet. Corrections and additions to this list are subject to change. To determine if an operating system has been certified or tested for compatibility, check the Web site of the operating system vendor.

---

## Features for machine types: 6019, 6064, 6066, 6067, 6072, 6073, 6077, 6078, 6087, 6088, 9181, 9196, 9325, 9330, 9967, 9970

This section provides an overview of the computer features and preinstalled software.

### System information

The following information covers a variety of models. For information for your specific model, use the Setup Utility. See Chapter 5, "Using the Setup Utility," on page 31.

#### Microprocessor

- Intel Pentium dual core processor
- Intel Celeron processor
- Intel Core 2 Duo processor
- Intel Core 2 Quad processor
- Internal cache (size varies by model type)

#### Memory

- Support for four double data rate 2 dual inline memory modules (DDR2 DIMMs)
- Flash memory for system programs (varies by model type)

#### Internal drives

- 3.5-inch, half-inch (slim) diskette drive (some models)
- Serial Advanced Technology Attachment (SATAII) internal hard disk drive
- Optical drive (some models)

#### Video subsystem

- An integrated graphics controller for a Video Graphics Array (VGA) monitor
- Intel Graphics Media Accelerator with dual display support (ADD2 card is needed for dual display)
- PCI Express (x16) graphics adapter connector on the system board

#### Audio subsystem

- HD with ADI 1882 Audio Codec
- Microphone and headphone connectors on the front panel
- Line in, line out, and microphone connectors on the rear panel
- Mono internal speaker

#### Connectivity

- 10/100/1000 Mbps integrated Ethernet controller
- Peripheral Component Interconnect (PCI) V.90 Data/Fax modem (some models)

#### System management features

- Preboot Execution Environment (PXE) and Dynamic Host Configuration Protocol (DHCP)
- Wake on LAN

- Wake on Ring (in the Setup Utility program, this feature is called Serial Port Ring Detect for an external modem)
- Remote Administration
- Automatic power-on startup
- System Management (SM) BIOS and SM software
- Ability to store power-on self-test (POST) hardware test results

**Input/output features**

- 25-pin Extended Capabilities Port (ECP)/Extended Parallel Port (EPP)
- 9-pin serial connector
- Eight USB connectors (two on front panel and six on rear panel)
- Ethernet connector
- VGA monitor connector
- Three audio connectors (line in, line out, and microphone) on rear panel
- Two audio connectors (microphone and headphone) on front panel
- One eSATA connector on the rear panel

### **Expansion**

- Three drive bays
- One 32-bit PCI adapter connector

### **Power**

- 280 Watt power supply with autosensing voltage switching
- Automatic 50/60 Hz input frequency switching
- Advanced Configuration and Power Interface (ACPI) support

### **Security features**

- User and administrator passwords for BIOS access
- Support for the addition of an integrated cable lock (Kensington lock)
- Keyboard with fingerprint reader (some models, see the ThinkVantage Productivity Center program for more information)
- Cover presence switch (some models)
- Startup sequence control
- Startup without diskette drive, keyboard, or mouse
- Unattended start mode
- Diskette and hard disk drive I/O control
- Serial and parallel port I/O control
- Security profile by device

### **Preinstalled software**

Your computer might come with preinstalled software. If it does, an operating system, device drivers to support built-in features, and other support programs are included.

### **Operating systems, preinstalled** (varies by model)

**Note:** Not all countries or regions have these operating systems.

- Microsoft Windows XP Home
- Microsoft Windows XP Professional
- Microsoft Windows Vista

### **Operating systems, certified or tested for compatibility**<sup>3</sup> (varies by model)

Linux

---

3. The operating systems listed here are being certified or tested for compatibility at the time this publication goes to press. Additional operating systems might be identified by Lenovo as compatible with your computer following the publication of this booklet. Corrections and additions to this list are subject to change. To determine if an operating system has been certified or tested for compatibility, check the Web site of the operating system vendor.

---

## Features for machine types: 6062, 6065, 6071, 6076, 6089, 7103, 9011, 9014, 9071, 9089, 9162, 9182, 9303

This section provides an overview of the computer features and preinstalled software.

### System information

The following information covers a variety of models. For information for your specific model, use the Setup Utility. See Chapter 5, "Using the Setup Utility," on page 31.

#### Microprocessor

- Intel Pentium dual core processor
- Intel Celeron processor
- Intel Core 2 Duo processor
- Intel Core 2 Quad processor
- Internal cache (size varies by model type)

#### Memory

- Support for two double data rate 2 dual inline memory modules (DDR2 DIMMs)
- Flash memory for system programs (varies by model type)

#### Internal drives

- Serial Advanced Technology Attachment (SATAII) internal hard disk drive
- Optical drive (some models)

#### Video subsystem

- An integrated graphics controller for a Video Graphics Array (VGA) monitor
- Intel Graphics Media Accelerator with dual display support (ADD2 card is needed for dual display)

#### Audio subsystem

- HD with ADI 1882 Audio Codec
- Microphone and headphone connectors on the front panel
- Line in and line out connectors on the rear panel
- Mono internal speaker

#### Connectivity

- 10/100/1000 Mbps integrated Ethernet controller
- Peripheral Component Interconnect (PCI) V.90 Data/Fax modem (some models)

#### System management features

- Preboot Execution Environment (PXE) and Dynamic Host Configuration Protocol (DHCP)
- Wake on LAN
- Wake on Ring (in the Setup Utility program, this feature is called Serial Port Ring Detect for an external modem)
- Remote Administration

- Automatic power-on startup
- System Management (SM) BIOS and SM software
- Ability to store power-on self-test (POST) hardware test results

**Input/output features**

- 25-pin Extended Capabilities Port (ECP)/Extended Parallel Port (EPP)
- 9-pin serial connector
- Eight USB connectors (two on front panel and six on rear panel)
- Ethernet connector
- VGA monitor connector
- Two audio connectors (line-in and line-out) on rear panel
- Two audio connectors (microphone and headphone) on front panel
- One eSATA connector on the rear panel

### **Expansion**

- Two drive bays
- One 32-bit PCI adapter connector

### **Power**

- 225 Watt power supply with autosensing voltage switching
- Automatic 50/60 Hz input frequency switching
- Advanced Configuration and Power Interface (ACPI) support

### **Security features**

- User and administrator passwords for BIOS access
- Support for the addition of an integrated cable lock (Kensington lock)
- Keyboard with fingerprint reader (some models, see the ThinkVantage Productivity Center program for more information)
- Cover presence switch (some models)
- Startup sequence control
- Startup without diskette drive, keyboard, or mouse
- Unattended start mode
- Diskette and hard disk drive I/O control
- Serial and parallel port I/O control
- Security profile by device

### **Preinstalled software**

Your computer might come with preinstalled software. If it does, an operating system, device drivers to support built-in features, and other support programs are included.

### **Operating systems, preinstalled** (varies by model)

**Note:** Not all countries or regions have these operating systems.

- Microsoft Windows XP Home
- Microsoft Windows XP Professional
- Microsoft Windows Vista

### **Operating systems, certified or tested for compatibility<sup>4</sup>** (varies by model)

Linux

---

4. The operating systems listed here are being certified or tested for compatibility at the time this publication goes to press. Additional operating systems might be identified by Lenovo as compatible with your computer following the publication of this booklet. Corrections and additions to this list are subject to change. To determine if an operating system has been certified or tested for compatibility, check the Web site of the operating system vendor.

---

## Specifications for machine types: 6008, 6068, 6074, 6079, 6082, 9012, 9018, 9087, 9096, 9163, 9172, 9193

This section lists the physical specifications for your computer.

### Dimensions

Width: 325 mm (12.8 in.)

Height: 107 mm (4.21in.)

Depth: 410 mm (16.14 in.)

### Weight

Minimum configuration as shipped: 8.2 kg (18 lbs)

Maximum configuration: 10.4 kg (23 lbs)

### Environment

Air temperature:

Operating at 0 - 3000 ft (914.4 m): 10° to 35°C (50° to 95°F)

Non-operating: -40° to 60°C (-40° to 140°F)

Humidity:

Operating: 10% to 80% (10% per hour, non condensing)

Non-operating: 10% to 90% (10% per hour)

Maximum altitude:

Operating: -50 to 10,000 ft (-15.2 to 3048 m)

Non-operating: -50 to 35,000 ft (-15.2 to 10.668)

### Electrical input

Input voltage:

Low range:

Minimum: 100 V ac

Maximum: 127 V ac

Input frequency range: 50/60 Hz

Voltage switch setting: 115 V ac

High range:

Minimum: 200 V ac

Maximum: 240 V ac

Input frequency range: 50/60 Hz

Voltage switch setting: 230 V ac



---

## Specifications for machine types: 6010, 6069, 6075, 6081, 6086, 9013, 9019, 9088, 9160, 9164, 9174, 9194, 9304, 9323, 9326, 9978, 9979

This section lists the physical specifications for your computer.

### Dimensions

Width: 400 mm (15.7 in.)

Height: 175 mm (6.9 in.)

Depth: 432 mm (17.0in.)

### Weight

Minimum configuration as shipped: 8.17 kg (18 lbs)

Maximum configuration: 10.21 kg (22.5lbs)

### Environment

Air temperature:

Operating at 0 - 3000 ft (914.4 m): 10° to 35°C (50° to 95°F)

Non-operating: -40° to 60°C (-40° to 140F)

Humidity:

Operating: 10% to 80% (10% per hour non-condensing)

Non-operating: 10% to 90% (10% per hour)

Maximum altitude:

Operating: -50 to 10,000 ft (-15.2 to 3048 m)

Non-operating: -50 to 35,000 ft (-15.2 to 10,668 m)

### Electrical input

Input voltage:

Low range:

Minimum: 100 V ac

Maximum: 127 V ac

Input frequency range: 50/60 Hz

Voltage switch setting: 115 V ac

High range:

Minimum: 200 V ac

Maximum: 240 V ac

Input frequency range: 50/60 Hz

Voltage switch setting: 230 V ac

---

## Specifications for machine types: 6019, 6064, 6066, 6067, 6072, 6073, 6077, 6078, 6087, 6088, 9181, 9196, 9325, 9330, 9967, 9970

This section lists the physical specifications for your computer.

### Dimensions

Width: 317 mm (12.48 in.)

Height: 99 mm (3.9 in.)

Depth: 341 mm (13.4in.)

### Weight

Minimum configuration as shipped: 6.32 kg (13.9 lbs)

Maximum configuration: 7.42 kg (16.4 lbs)

### Environment

Air temperature:

Operating at 0 - 3000 ft (914.4 m): 10° to 35°C (50° to 95°F)

Non-operating: -40° to 60°C (-40° to 140°F)

Humidity:

Operating: 10% to 80% (10% per hour, non-condensing)

Non-operating: 10% to 90%(10% per hour)

Maximum altitude:

Operating: -50 to 10,000 ft (-15.2 to 3048 m)

Non-operating: -50 to 35,000 ft (-15.2 to 10,668 m)

### Electrical input

Input voltage:

Low range:

Minimum: 100 V ac

Maximum: 127 V ac

Input frequency range: 50/60 Hz

Voltage switch setting: 115 V ac

High range:

Minimum: 200 V ac

Maximum: 240 V ac

Input frequency range: 50/60 Hz

Voltage switch setting: 230 V ac

---

## Specifications for machine types: 6062, 6065, 6071, 6076, 6089, 7103, 9011, 9014, 9071, 9089, 9162, 9182, 9303

This section lists the physical specifications for your computer.

### Dimensions

Width: 89 mm (3.5in.)

Height: 276 mm (10.9 in.)

Depth: 273 mm (10.7 in.)

### Weight

Minimum configuration as shipped: 6.3 kg (13.4 lbs)

Maximum configuration: 6.4 kg (14.1 lbs)

### Environment

Air temperature:

Operating at 0 - 3000 ft (914.4 m): 10° to 35°C (50° to 95°F)

Non-operating: -40° to 60°C (-40° to 140°F)

Humidity:

Operating: 10% to 80% (10% per hour, non-condensing)

Non-operating: 10% to 90% (10% per hour)

Maximum altitude:

Operating: -50 to 10,000 ft (-15.2 to 3048)

Non-operating: -50 to 35,000 ft (-15.2 to 10,668 m)

### Electrical input

Input voltage:

Low range:

Minimum: 100 V ac

Maximum: 127 V ac

Input frequency range: 50/60 Hz

Voltage switch setting: 115 V ac

High range:

Minimum: 200 V ac

Maximum: 240 V ac

Input frequency range: 50/60 Hz

Voltage switch setting: 230 V ac



---

## Chapter 4. Software overview

The computer is manufactured with a preloaded operating system and several preloaded applications.

The operating systems available are:

- Windows Vista
- Windows XP

---

### Software provided with your Windows operating system

This section describes the Windows applications included with this product.

#### Software provided by Lenovo

The following software applications are provided by Lenovo to help you improve productivity and reduce the cost associated with maintaining your computer. Software provided with your computer may vary depending on your model.

##### ThinkVantage Productivity Center

The ThinkVantage Productivity Center program guides you to a host of information and tools to help you set up, understand, maintain and enhance your computer.

##### ThinkVantage Rescue and Recovery

The ThinkVantage Rescue and Recovery program is a one button recovery and restore solution that includes a set of self recovery tools to help users diagnose, get help, and recover from system crashes quickly, even if the primary operating system will not start.

##### ThinkVantage Client Security Solution

This unique hardware-software combination is available on select Lenovo computers. It helps protect your information, including vital security information like passwords, encryption keys and electronic credentials, while guarding against unauthorized user access to data.

##### ThinkVantage System Update

ThinkVantage System Update is a software program that helps you keep the software on your system current, by downloading and installing software packages (applications, device drivers, BIOS flashes and other updates). Some examples of software that you would like to keep updated are programs provided by Lenovo, such as the Rescue and Recovery program and the Productivity Center program.

##### System Migration Assistant

System Migration Assistant (SMA) is a software tool that enables system administrators and individual users to migrate a work environment from one computer to another.

##### Fingerprint Software

With a fingerprint reader, you can enroll your fingerprint and associate it with a power-on password, hard disk drive password, and administrator (supervisor) password. As a result, your fingerprint can replace passwords enabling simple and

secure access to your computer system. A fingerprint reader keyboard is only available with select computers or can be purchased for computers that support this option.

### **PC Doctor for WINPE, PC Doctor for Windows**

This diagnostic program is preinstalled from the factory on your hard disk drive. PC-Doctor for Windows works through the Windows operating system to diagnose hardware problems and report operating-system-controlled settings that can cause hardware failures.

### **Adobe Acrobat Reader**

Adobe Acrobat Reader is a tool used to view, print, and search PDF documents.

See “Online Books folder” on page 55 for more information about accessing the online books and the Lenovo Web site.

---

## Chapter 5. Using the Setup Utility

The Setup Utility program is used to view and change the configuration settings of your computer, regardless of which operating system you are using. However, the operating-system settings might override any similar settings in the Setup Utility program.

---

### Starting the Setup Utility program

To start the Setup Utility program, do the following:

1. If your computer is already on when you start this procedure, shut down the operating system and turn off the computer.
2. Press and hold the F1 key then turn on the computer. When you hear multiple beeps, release the F1 key.

**Notes:**

- a. If you are using a USB keyboard and the Setup Utility program does not display using this method, repeatedly press and release the F1 key rather than leaving it pressed when turning on the computer.
- b. If a user password or an administrator password has been set, the Setup Utility program menu is not displayed until you type your password. For more information, see "Using passwords."

The Setup Utility might start automatically when POST detects that hardware has been removed or new hardware has been installed in your computer.

---

### Viewing and changing settings

The Setup Utility program menu lists items that identify system configuration topics. To view or change settings, see "Starting the Setup Utility program."

When working with the Setup Utility program menu, you must use the keyboard. The keys used to perform various tasks are displayed at the bottom of each screen.

---

### Using passwords

By using the Setup Utility program, you can set passwords to prevent unauthorized persons from gaining access to your computer and data. See "Starting the Setup Utility program." The following types of passwords are available:

- User Password
- Administrator Password

You do not have to set any passwords to use your computer. However, if you decide to set any passwords, read the following sections.

#### Password considerations

A password can be any combination of up to twelve characters (a-z and 0-9) and symbols. For security reasons, it is a good idea to use a strong password that cannot be easily compromised. Passwords should adhere to the following rules:

- Have at least eight characters in length

- Contain at least one alphabetic character, one numeric character, and one symbol
- Contain at least one of the following symbols: , . / ` ' [ ]
- You can also use the space bar
- Setup Utility program and hard disk drive passwords are not case sensitive
- Not be your name or your user name
- Not be a common word or a common name
- Be significantly different from your previous password

## User Password

When a User Password is set, the computer cannot be used until a valid password is typed from the keyboard.

## Administrator Password

When an Administrator Password is set, it deters unauthorized persons from changing configuration settings. If you are responsible for maintaining the settings of several computers, you might want to set an Administrator Password.

After you set an Administrator Password, a password prompt is displayed each time you try to access the Setup Utility program.

If both the user and administrator passwords are set, you can type either password. However, to change any configuration settings, you must use your administrator password.

## Setting, changing, and deleting a password

To set, change, or delete a password, do the following:

**Note:** A password can be any combination of up to twelve characters (A- Z, a-z, and 0-9). For more information, see “Password considerations” on page 31.

1. Start the Setup Utility program. See Chapter 5, “Using the Setup Utility,” on page 31.
2. From the **Setup Utility program** menu, select **Security**.
3. Select **Set Passwords**. Read the information displayed on the right side of the screen.

---

## Using Security Profile by Device

Security Profile by Device is used to enable or disable user access to the following devices:

|                              |   |
|------------------------------|---|
| <b>IDE controller</b>        | When this feature is set to <b>Disable</b> , all devices connected to the IDE controller (such as hard disk drives or the CD-ROM drive) are disabled and will not be displayed in the system configuration. |
| <b>Diskette Drive Access</b> | When this feature is set to <b>Disable</b> , the diskette drive cannot be accessed.   |

To set Security Profile by Device, do the following:

1. Start the Setup Utility program (see “Starting the Setup Utility program” on page 31).
2. From the **Setup Utility program** menu, select **Security**.



3. Select **Security Profile by Device**.
4. Select the desired devices and settings and press Enter.
5. Return to the Setup Utility program menu and select **Exit** and then **Save Settings** or **Save and exit the Setup Utility**.

**Note:** If you do not want to save the settings, select **Exit the Setup Utility without saving**.

---

## Selecting a startup device

If your computer does not start up from a device such as the CD-ROM, diskette, or hard disk drive as expected, use one of the following procedures to select a startup device.

### Selecting a temporary startup device

Use this procedure to startup from any boot device.

**Note:** Not all CDs, hard disk drives, and diskettes are bootable.

1. Turn off your computer.
2. Press and hold the F12 key then turn on the computer. When the **Startup Device** Menu appears, release the F12 key.

**Note:** If you are using a USB keyboard and the **Startup Device** Menu does not display using this method, repeatedly press and release the F12 key rather than leaving it pressed when turning on the computer.

3. Select the desired startup device from the **Startup Device** Menu and press Enter to begin.

**Note:** Selecting a startup device from the **Startup Device** menu does not permanently change the startup sequence.

### Selecting or changing the startup device sequence

To view or permanently change the configured startup device sequence, do the following:

1. Start the Setup Utility program (see “Starting the Setup Utility program” on page 31).
2. Select **Startup**.
3. Select **Startup Sequence**. See the information displayed on the right side of the screen.
4. Select the devices for the Primary Startup Sequence, the Automatic Startup Sequence, and the Error Startup Sequence.
5. Select **Exit** from the Setup Utility menu and then **Save Settings** or **Save and exit the Setup Utility**.

If you have changed these settings and want to return to the default settings, select **Load Default Settings** on the Exit menu.

---

## Advanced settings

On some computer models, the Advanced settings menu includes a setting to Enable/Disable HyperThreading. This feature works only with HyperThreading-aware operating systems, such as Microsoft Windows XP. The default setting for HyperThreading is Enabled. However, if you select **Set Defaults** and are using an operating system other than Windows XP, your computer performance might be degraded. Therefore, you should always set HyperThreading to Disabled unless you are sure your operating system supports HyperThreading.

---

## Exiting from the Setup Utility program

After you finish viewing or changing settings, press Esc to return to the Setup Utility program menu (you might have to press Esc several times). If you want to save the new settings, select **Save Settings** or **Save and exit the Setup Utility**. Otherwise, your changes will not be saved.

---

## Chapter 6. Updating system programs

This chapter contains information about updating POST/BIOS and how to recover from a POST/BIOS update failure.

---

### Using system programs

System programs are the basic layer of software built into your computer. They include the power-on self-test (POST), the basic input/output system (BIOS) code, and the Setup Utility program. POST is a set of tests and procedures that are performed each time you turn on your computer. BIOS is a layer of software that translates instructions from other layers of software into electrical signals that the computer hardware can execute. You can use the Setup Utility program to view and change the configuration and setup of your computer.

Your computer system board has a module called electrically erasable programmable read-only memory (EEPROM, also referred to as flash memory). You can easily update POST, BIOS, and the Setup Utility program by starting your computer using a flash update diskette or by running a special update program from your operating system.

Lenovo might make changes and enhancements to the POST/BIOS. When updates are released, they are available as downloadable files on the Lenovo Web site at <http://www.lenovo.com>. Instructions for using the POST/BIOS updates are available in a .txt file that is included with the update files. For most models, you can download either an update program to create a system-program-update (flash) diskette or an update program that can be run from the operating system.

**Note:** You can download a self starting bootable CD image (known as an .iso image) of the diagnostics program from <http://www.lenovo.com> to support systems without a diskette drive.

---

### Updating (flashing) BIOS from a diskette or CD-ROM

This section describes how to update (flash) the BIOS using a diskette or CD-ROM. System program updates are available at <http://www.lenovo.com/support> on the World Wide Web.

1. To update (flash) the BIOS:
  - From a diskette, make sure the computer is turned off and insert a system program update (flash diskette). Then turn the computer on. The update begins.
  - From a CD-ROM, make sure the computer is turned on. Insert the CD-ROM into the optical drive.
2. Turn on the computer. If it is on already, you must turn it off and back on again. The update begins.
3. When you are prompted to select a language, press the number on your keyboard that corresponds to the language and then press Enter.
4. When prompted to change the serial number, press Y.
5. Type in the seven character serial number of your computer and then press Enter.
6. When prompted to change the machine type/model, press Y.

7. Type in the seven character machine type/model of your computer and then press Enter.
8. Follow the instructions on the screen to complete the update.

---

## Updating (flashing) BIOS from your operating system

**Note:** Due to the constant improvements made to the Web site, Web page content (including the links referenced in the following procedure) is subject to change.

1. From your browser, type <http://www.lenovo.com/support> in the address field and press Enter.
2. Locate the Downloadable files for your machine type as follows:
  - a. In the **Enter a product** field, type your machine type and click **Go**.
  - b. Click **Continue**.
  - c. Click **Downloads and drivers**.
  - d. Under the BIOS category, click the Flash BIOS update.
  - e. Click the .txt file that contains the installation instructions for the flash BIOS update (flash from the operating system version).
3. Print these instructions. This is very important since they are not on the screen after the download begins.
4. From your browser, click **Back** to return to the list of files. Carefully follow the printed instructions to download, extract, and install the update.

---

## Recovering from a POST/BIOS update failure

**Attention:** If an interruption occurs during a POST/BIOS update (flash update), the computer might not restart correctly. If this occurs, perform the following procedure (also known as a Boot-block recovery).

**Note:** If your computer has no internal diskette drive, an optional USB diskette drive must be connected to use the BIOS flash diskette.

1. Turn off the computer and any attached devices, such as printers, monitors, and external drives.
2. Unplug all power cords from electrical outlets, and open the computer cover.
3. Access the system board.
4. Locate the Clear CMOS/Recovery jumper on the system board.
5. Remove any cables that impede access to the Clear CMOS/Recovery jumper.
6. Move the jumper from the standard position (pin 1 and pin 2) to pin 2 and pin 3.
7. Insert the BIOS flash diskette in the diskette drive.
8. Close the computer cover and reconnect the power cords for the computer and monitor to electrical outlets.
9. Turn on the computer and the monitor.
10. The recovery session takes two to three minutes and starts with two short beeps. Video will be displayed after a short period, indicating that the recovery process has started.
11. When the flash recovery completes and the computer turns off, unplug all power cords from electrical outlets, and open the computer cover.

12. Replace the Clear CMOS/Recovery jumper to the standard position (pin 1 and pin 2).
13. Remove the BIOS flash diskette from the diskette drive.
14. Close the computer cover and reconnect the power cords for the computer and monitor to electrical outlets.
15. Turn on the computer to restart the operating system.



---

## Chapter 7. Troubleshooting and diagnostics

This chapter describes some basic troubleshooting and diagnostic programs. If your computer problem is not described here, see Chapter 9, "Getting information, help, and service," on page 55 for additional troubleshooting resources.

---

### Basic troubleshooting

The following table provides information to help you troubleshoot your computer problem.

| Symptom  | Action   |
|--|--|
| The computer does not start when you press the power button.               | <p>Verify that:</p> <ul style="list-style-type: none"><li>• The power cord is plugged into the rear of the computer and into a working electrical outlet.</li><li>• If your computer has a secondary power switch on the back of the computer, make sure that it is switched on.</li><li>• The power indicator on the front of the computer is on.</li><li>• The voltage is set to the correct setting for your country.</li></ul> <p>If you cannot correct the problem, have the computer serviced. Refer to the safety and warranty information that is provided with your computer for a list of service and support telephone numbers.</p>   |
| The monitor screen is blank.   | <p>Verify that:</p> <ul style="list-style-type: none"><li>• The monitor cable is securely attached to the rear of the monitor and to the rear of the computer.</li><li>• The monitor power cord is plugged into the monitor and into a working electrical outlet.</li><li>• The monitor is turned on and the brightness and contrast controls are set correctly.</li><li>• The voltage is set to the correct setting for your country.</li><li>• The monitor signal cable is securely connected to the monitor and to the monitor connector on the computer.</li></ul> <p><b>Note:</b> If your computer has two monitor connectors, verify that your monitor is connected to the option connector rather than the one in the rear of the system board. For more information, see "Connecting your computer" on page 5.</p> <p>If you cannot correct the problem, have the computer serviced. Refer to the safety and warranty information that is provided with your computer for a list of service and support telephone numbers.</p> |
| The keyboard does not work. The computer does not respond to the keyboard. | <p>Verify that:</p> <ul style="list-style-type: none"><li>• The computer is turned on.</li><li>• The monitor is turned on and the brightness and contrast controls are set correctly.</li><li>• The keyboard is securely connected to the keyboard connector on the computer.</li><li>• No keys are stuck.</li></ul> <p>If you cannot correct the problem, have the computer serviced. Refer to the safety and warranty information that is provided with your computer for a list of service and support telephone numbers.</p>   |

| Symptom   | Action  |
|---|---|
| The USB Keyboard does not work.                                       | <p>Verify that:</p> <ul style="list-style-type: none"> <li>• The computer is turned on.</li> <li>• The keyboard is securely connected to a USB connector on the front or rear of the computer.</li> <li>• No keys are stuck.</li> </ul> <p>If you cannot correct the problem, have the computer serviced. Refer to the safety and warranty information that is provided with your computer for a list of service and support telephone numbers.</p>   |
| The mouse does not work. The computer does not respond to the mouse.  | <p>Verify that:</p> <ul style="list-style-type: none"> <li>• The computer is turned on.</li> <li>• The mouse is securely connected to the mouse connector on the computer.</li> <li>• The mouse is clean. Refer to “Cleaning the mouse” on page 43 for further information.</li> </ul> <p>If you cannot correct the problem, have the computer serviced. Refer to the safety and warranty information that is provided with your computer for a list of service and support telephone numbers.</p>  |
| The operating system will not start.                                  | <p>Verify that:</p> <ul style="list-style-type: none"> <li>• There is no diskette in the diskette drive.</li> <li>• The startup sequence includes the device where the operating system resides. Usually, the operating system is on the hard disk drive. For more information, see “Selecting a startup device” on page 33.</li> </ul> <p>If you cannot correct the problem, have the computer serviced. Refer to the safety and warranty information that is provided with your computer for a list of service and support telephone numbers.</p> |
| The computer beeps multiple times before the operating system starts. | <p>Verify that no keys are stuck down.</p> <p>If you cannot correct the problem, have the computer serviced. Refer to the safety and warranty information that is provided with your computer for a list of service and support telephone numbers.</p>  |

## Diagnostic programs

Diagnostic programs are used to test hardware components of your computer and report operating-system-controlled settings that can cause hardware failures. There are two diagnostic programs preinstalled on your computer to help you diagnose problems:

- PC-Doctor for Windows (used when diagnosing problems while running the Windows operating system)
- PC-Doctor for DOS or PC-Doctor for Windows PE, depending upon your machine type and model (used when your Windows operating system will not start)

### Notes:

1. You can download the latest version of the PC-Doctor for Windows or PC-Doctor for DOS diagnostic programs from <http://www.lenovo.com/support/>. Type your machine type into the **Use Quick Path** field and click **Go** to find the downloadable files that are specific to your computer.
2. If you are unable to isolate and repair the problem yourself after you run PC-Doctor for Windows and depending upon your machine type and model, PC-Doctor for DOS or PC-Doctor for Windows PE, save and print the log files



created by both diagnostic programs. You will need the log files when you speak to a Lenovo technical support representative. (The log file created by PC-Doctor for Windows is automatically saved in C:\PCDR\DETAILED.TXT.)

## PC-Doctor for Windows

PC-Doctor for Windows is a diagnostic program that works through the Windows operating system. This diagnostic program enables you to view symptoms and solutions for computer problems, access the Lenovo troubleshooting center, update system drivers, and review system information.

To run PC-Doctor for Windows, open the **Start** menu from the Windows desktop, select **All Programs**, select **PC-Doctor for Windows**, and click **PC-Doctor for Windows**. Follow the instructions on the screen. For additional information about running the diagnostic program, refer to the PC-Doctor for Windows help system.

If you still suspect a problem after PC-Doctor for Windows runs successfully, run PC-Doctor for DOS or PC-Doctor for Windows PE to help you diagnose your computer problem.

## PC-Doctor for DOS

Depending upon your machine type and model, you have either PC-Doctor for DOS or PC-Doctor for Windows PE on your Lenovo computer. The PC-Doctor for DOS diagnostic program is part of the Rescue and Recovery workspace and runs independently of the Windows operating system. Use PC-Doctor for DOS, if you are unable to start the Windows operating system or if PC-Doctor for Windows has not been successful in isolating a possible problem. You can run PC-Doctor for DOS from a diagnostic CD image or diagnostic diskettes that you create. You can also run PC-Doctor for DOS from the Rescue and Recovery workspace.

**Note:** Be sure to create a diagnostic CD image or diagnostic diskettes in case you are unable to run PC-Doctor for DOS from the Rescue and Recovery workspace.

### Creating a diagnostic CD image

To create a diagnostic CD image, download a self-starting bootable CD image (known as an .iso image) of the diagnostic program from <http://www.lenovo.com/support/>. After you download the image, you can create the CD using any CD burning software.

If your computer does not have a CD burner or you do not have Internet access, see "Creating diagnostic diskettes."

### Creating diagnostic diskettes

To create diagnostic diskettes, download the PC-Doctor for DOS diagnostic program from <http://www.lenovo.com/support/> onto two blank, formatted diskettes.

If you do not have Internet access, create the diagnostic diskettes using the following procedure:

**Note:** You will need a diskette drive on your computer or a USB diskette drive to complete this procedure.

1. Shut down the operating system and turn off the computer.
2. If you are using a USB diskette drive, plug it into the computer.

3. Repeatedly press and release the F11 key as you turn on the computer.
4. When you hear beeps or see a logo screen, stop pressing the F11 key. The Rescue and Recovery workspace opens.

**Note:** For some models, press the Esc key to enter Rescue and Recovery.

5. From the Rescue and Recovery workspace, select **Create diagnostic disks**.
6. Follow the instructions on the screen.
7. When prompted, insert a blank, formatted diskette into the diskette drive and continue to follow the instructions on the screen.
8. When the operation is complete, remove the diskette and click **Quit**.
9. Insert another blank, formatted diskette into the diskette drive and continue to follow the instructions on the screen.
10. When the operation is complete, remove the diskette and click **Quit**.

### **Running diagnostics from the CD or diskettes**

To run diagnostics from the diagnostic CD image or diagnostic diskettes that you created, use the following procedure:

1. Make sure your computer is turned off.
2. If you are running diagnostics from diskettes using a USB diskette drive, plug in the USB device.
3. Insert the CD into the optical drive or the first diagnostic diskette into the diskette drive.
4. Restart the computer.

**Note:** If the diagnostic program does not start, the optical drive or diskette drive has not been set as a bootable device. See “Selecting a startup device” on page 33 for instructions on how to select or change the startup device.

5. When the diagnostics program opens, follow the instructions on the screen.

**Note:** If you are running diagnostics from a diskette, when prompted, remove the first diskette and insert the second diskette.

6. When the program finishes, remove the CD or diskette from the drive.
7. Select the diagnostic test you want to run. Press the F1 key for additional help.

### **Running diagnostics from the Rescue and Recovery workspace**

To run diagnostics from the Rescue and Recovery workspace, use the following procedure:

**Note:** If you did not create a diagnostic CD image or diagnostic diskettes, you can run the PC-Doctor for DOS diagnostic program from the Rescue and Recovery workspace.

1. Shut down the operating system and turn off the computer.
2. Repeatedly press and release the F11 key as you turn on the computer.
3. When you hear beeps or see a logo screen, stop pressing the F11 key. The Rescue and Recovery workspace opens.

**Note:** For some models, press the Esc key to enter Rescue and Recovery.

4. From the Rescue and Recovery workspace, select **Diagnose hardware**.
5. Follow the prompts on the screen. The computer will restart.

6. When the computer restarts, the diagnostic program opens automatically. Select the diagnostic test you want to run. Press the F1 key for additional help.

## PC-Doctor for Windows PE

Depending upon your machine type and model, you either have PC-Doctor for DOS or PC-Doctor for Windows PE on your Lenovo computer. The PC-Doctor for Windows PE diagnostic program is part of the Rescue and Recovery workspace. Use PC-Doctor for Windows PE, if you are unable to start the Windows operating system or if PC-Doctor for Windows has not been successful in isolating a possible problem.

### Running diagnostics from the Rescue and Recovery workspace

You can run the PC-Doctor for Windows PE diagnostic program from the Rescue and Recovery workspace. To run diagnostics from the Rescue and Recovery workspace, use the following procedure:

1. Shut down the operating system and turn off the computer.
2. Repeatedly press and release the F11 key as you turn on the computer.
3. When you hear beeps or see a logo screen, stop pressing the F11 key. The Rescue and Recovery workspace opens.
4. From the Rescue and Recovery workspace, select **Diagnose hardware**.
5. The diagnostic program opens automatically. Select the diagnostic test you want to run. Press the F1 key for additional help.
6. Follow the instructions on the screen.

**Note:** Rescue media includes PC-Doctor for Windows PE. For more information about rescue media, see “Creating and using rescue media” on page 50.

---

## Cleaning the mouse

This section provides instructions on how to clean an optical or non-optical mouse.

### Optical mouse

An optical mouse uses a light-emitting diode (LED) and an optical sensor to navigate the pointer. If the pointer on the screen does not move smoothly with the optical mouse, you might need to clean the mouse. To clean the optical mouse:

1. Turn off your computer.
2. Disconnect the mouse cable from the computer.
3. Turn the mouse upside down to look at the lens.
  - a. If there is a smudge on the lens, gently clean the area with a plain cotton-tipped swab.
  - b. If there is debris in the lens, gently blow the debris away from the area.
4. Check the surface on which you are using the mouse. If you have a very intricate picture or pattern beneath the mouse it may be difficult for the digital signal processor (DSP) to determine changes in the mouse position.
5. Reconnect the mouse cable to the computer.
6. Turn your computer back on.

## Non-optical mouse

The non-optical mouse uses a ball to navigate the pointer. If the pointer on the screen does not move smoothly with the mouse, you might need to clean the mouse. To clean the non-optical mouse:

**Note:** The following illustration might be slightly different from your mouse.

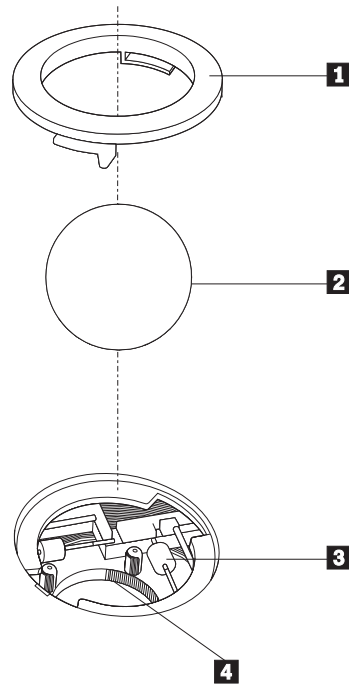

- 1** Retainer ring
- 2** Ball
- 3** Plastic rollers
- 4** Ball cage

To clean a mouse with a ball, follow the instructions below:

1. Turn off your computer.
2. Disconnect the mouse cable from the computer.
3. Turn the mouse upside down. Twist the retainer ring **1** to the unlocked position to remove the ball.
4. Place your hand over the retainer ring and ball **2**, and then turn the mouse right-side up, so that the retainer ring and ball fall out into your hand.
5. Wash the ball in warm, soapy water then dry it with a clean cloth.
6. Blow air carefully into the ball cage **4** to dislodge dust and lint.
7. Look for a build up of dirt on the plastic rollers **3** inside the ball cage. This build up usually appears as a stripe running across the middle of the rollers.
8. If the rollers are dirty, clean them by using a cotton swab soaked in isopropyl (rubbing) alcohol. Turn the rollers with your finger and continue swabbing them until all the dirt is removed. Be sure the rollers are still centered in their channels after you clean them.
9. Remove any fibers from the swab that might be remaining on the rollers.
10. Replace the ball and the retainer ring. Twist the retainer ring to the locked position.

11. Reconnect the mouse cable to the computer.
12. Turn your computer back on.



---

## Chapter 8. Recovering software

This chapter will help you become familiar with recovery solutions provided by Lenovo. This chapter explains how and when to use the following recovery methods:

- Creating and using Product Recovery discs
- Performing backup and recovery operations
- Using the Rescue and Recovery workspace
- Creating and using rescue media
- Creating and using a Recovery Repair diskette
- Recovering or installing device drivers
- Setting a rescue device in the startup sequence
- Solving recovery problems

Refer to the Access Help online help system for additional information about the Rescue and Recovery program provided by Lenovo. For information on how to access the online help system, see “Access Help” on page 56.

**Note:** There are a variety of methods to choose from when considering how to recover software in the event of a software or hardware-related problem. Some methods vary depending on the type of operating system you have.

---

### Creating and using the Product Recovery disc

If your computer is equipped with a recordable CD or DVD drive, you can create a set of Product Recovery discs that enable you to restore the contents of the hard disk drive to the same state as when the computer was originally shipped from the factory. Product Recovery discs are useful if you transfer the computer to another area, sell the computer, recycle the computer, or as a last resort put the computer in an operational state after all other methods of recovery have failed. As a precautionary measure, it is important to create a set of Product Recovery discs as soon as possible.

**Note:** The recovery operations you can perform using Product Recovery discs vary depending on the operating system from which they were created. Your Microsoft Windows license permits you to create only one set of Product Recovery discs, so it is important that you store the discs in a safe place after you make them.

**To create Product Recovery discs, do the following:**

1. From the Windows desktop, open the **Start** menu, select **All Programs**, select **ThinkVantage**, click **Create Recovery Media**.
2. Follow the instructions on the screen.

The following list explains how Product Recovery discs are used on different operating systems:

- Windows XP: Use Product Recovery discs to restore your computer to the original factory contents, perform a custom factory recovery, or to perform other rescue and recovery operations such as rescuing individual files.

- Windows Vista: Use Product Recovery discs to restore your computer to the original factory contents only.

When using Product Recovery discs on Windows XP, you are given the option to enter the Rescue and Recovery workspace and choose from a variety of recovery operations. When using Product Recovery discs on Windows Vista, you are prompted to insert your Product Recovery discs and are guided through the process of restoring from original factory contents only.

**To use Product Recovery discs on Windows XP, do the following:**

**Attention:** When you restore the factory contents from the Product Recovery discs, all files currently on the hard disk drive will be deleted and replaced by the original factory contents. During the restore process, you will be given the opportunity to save one or more files currently on your hard disk drive to other media before any data is removed.

1. Insert Product Recovery disc 1 into your CD or DVD drive.
2. Restart your computer.
3. After a short delay, the Rescue and Recovery workspace opens.

**Note:** If the Rescue and Recovery workspace fails to open, you might not have your startup device (CD drive or DVD drive) set correctly in your BIOS startup sequence. For more information, see “Setting a rescue device in the startup sequence” on page 53.

4. In the Rescue and Recovery menu, click **Restore your system**.
5. Follow the instructions on the screen. Insert the appropriate Product Recovery disc when prompted.

**Note:** After restoring your hard disk drive to the original factory content, you might have to reinstall some software or drivers. See “Using the Rescue and Recovery workspace” on page 49 for details.

**To use Product Recovery discs on Windows Vista, do the following:**

**Attention:** When you restore the factory contents from the Product Recovery discs, all files currently on the hard disk drive will be deleted and replaced by the original factory contents.

1. Insert Product Recovery disc 1 into your CD or DVD drive.
2. Restart your computer.
3. Follow the instructions on the screen. Insert the appropriate Product Recovery disc when prompted.

**Note:** After restoring your hard disk drive to the original factory content, you might have to reinstall some software or drivers. See “Using the Rescue and Recovery workspace” on page 49 for details.

---

## Performing backup and recovery operations

The Rescue and Recovery program enables you to back up your complete hard disk drive contents including the operating system, data files, application programs, and personal settings. You can designate where the Rescue and Recovery program stores the backup:

- On a protected area of your hard disk drive



- On a second hard disk drive installed in your computer
- On an externally attached USB hard disk drive
- On a network drive
- On recordable CDs or DVDs (a recordable CD or DVD drive is required for this option)

After you have backed up your hard disk drive, you can restore the complete contents of the hard disk drive, restore selected files only, or restore only the Windows operating system and applications.

**To perform a backup operation using the Rescue and Recovery program, do the following:**

1. From the Windows desktop, open the **Start** menu, select **All Programs**, click **ThinkVantage**, then click **Rescue and Recovery**. The Rescue and Recovery program opens.
2. From the Rescue and Recovery main window, click **Back up your hard disk drive** select backup operation options.
3. Follow the instructions on the screen.

**To perform a restore operation using the Rescue and Recovery program, do the following:**

1. From the Windows desktop, open the **Start** menu, select **All Programs**, click **ThinkVantage**, then click **Rescue and Recovery**. The Rescue and Recovery program opens.
2. From the Rescue and Recovery main window, click **Restore your system from a backup** icon.
3. Follow the instructions on the screen.

For information about performing a restore operation from the Rescue and Recovery workspace, see “Using the Rescue and Recovery workspace.”

---

## Using the Rescue and Recovery workspace

The Rescue and Recovery workspace resides in a protected, hidden area of your hard disk drive that operates independently from the Windows operating system. This enables you to perform recovery operations even if the Windows operating system cannot be started. You can perform the following recovery operations from the Rescue and Recovery workspace:

- **Rescue files from your hard disk drive or from a backup:** The Rescue and Recovery workspace enables you to locate files on your hard disk drive and transfer them to a network drive or other recordable media, such as a USB hard disk drive or a diskette. This solution is available, even if you did not back up your files or if changes were made to the files since your last backup operation. You also can rescue individual files from a Rescue and Recovery backup located on your local hard disk drive, a USB device, or a network drive.
- **Restore your hard disk drive from a Rescue and Recovery backup:** When you perform a backup operation using the Rescue and Recovery program, you can perform restore operations from the Rescue and Recovery workspace, even if you cannot start the Windows operating system.
- **Restore your hard disk drive to the factory contents:** The Rescue and Recovery workspace enables you to restore the complete contents of your hard disk drive to the same state as it was when originally shipped from the factory. If you have multiple partitions on your hard disk drive, you have the option to restore the

factory contents to the C: partition and leave the other partitions intact. Because the Rescue and Recovery workspace operates independently from the Windows operating system, you can restore the factory contents even if you cannot start the Windows operating system.

**Attention:** If you restore the hard disk drive from a Rescue and Recovery backup or restore the hard disk drive to the factory contents, all files on the primary hard disk drive partition (usually drive C) will be deleted in the recovery process. If possible, make copies of important files. If you are unable to start the Windows operating system, you can use the Rescue files feature in the Rescue and Recovery workspace to copy files from your hard disk drive to other media.

**To start the Rescue and Recovery workspace, do the following:**

1. Turn off your computer.
2. Restart your computer.
3. Repeatedly press and release the F11 key.
4. When you hear beeps or see a logo screen, release the F11 key.
5. If you set a Rescue and Recovery password, type your password when prompted. The Rescue and Recovery workspace opens after a short delay.

**Note:** If the Rescue and Recovery workspace fails to open, see “Solving recovery problems” on page 53.

6. Do one of the of the following:
  - To rescue files from your hard disk drive or from a backup, click **Rescue files**; then, follow the instructions on the screen.
  - To restore your hard disk drive from a Rescue and Recovery backup or to restore your hard disk drive to the factory contents, click **Restore your system**; then, follow the instructions on the screen.
  - For information about other features of the Rescue and Recovery workspace, click **Help**.

**Notes:**

1. After restoring a hard disk drive to the original factory contents you might have to reinstall device drivers for some devices. See “Recovering or installing device drivers” on page 52.
2. Some computers come with Microsoft Office or Microsoft Works preinstalled. If you need to recover or reinstall your Microsoft Office or Microsoft Works applications, you must use the *Microsoft Office CD* or *Microsoft Works CD*. These CDs are provided only with computers that come with Microsoft Office or Microsoft Works preinstalled.

---

## Creating and using rescue media

Rescue media such as a CD or USB hard disk drive enables you to recover from failures that prevent you from gaining access to the Rescue and Recovery workspace on your hard disk drive.

**Note:** The recovery operations you can perform using rescue media vary depending on the operating system. The rescue disc can be started in any type of CD or DVD. Rescue media also contains a PC-Doctor diagnostics program, which enables you to run diagnostics from the rescue media.

**To create rescue media, do the following:**

1. Open the **Start** menu from the Windows desktop, select **All Programs**, click **ThinkVantage**, then click **Create Recovery Media**.
2. In the **Rescue Media** area, select the type of rescue media you want to create. You can create rescue media using a CD, USB hard disk drive, or a second internal hard disk drive.
3. Click **OK**.
4. Follow the instructions on the screen.

The following list explains how Product Recovery discs are used on different operating systems:

- Windows XP: Use Product Recovery discs to restore your computer to the original factory contents, perform a custom factory recovery, or to perform other rescue and recovery operations such as rescuing individual files.
- Windows Vista: Use rescue media to perform all recovery operations except the ability to restore to the original factory contents and custom factory recovery.

**To use rescue media, do one of the following:**

- If your rescue media is on CDs or DVDs, insert the rescue disc and restart your computer.
- If your rescue media is on a USB hard disk drive, attach your USB hard disk drive to one of the USB connectors on your computer, then restart on your computer.
- If you are using a second internal hard disk drive, set the startup sequence to start from that drive.

When the rescue media starts, the Rescue and Recovery workspace opens. Help for each feature is available from the Rescue and Recovery workspace. If your rescue media fails to start, you might not have your rescue device (CD drive, DVD drive, or USB device) set correctly in your BIOS startup sequence. For more information, see "Setting a rescue device in the startup sequence" on page 53.

---

## Creating and using a Recovery Repair diskette

If you are unable to access the Rescue and Recovery workspace or the Windows environment, use a Recovery Repair diskette to repair the Rescue and Recovery workspace or repair a file needed to enter the Windows environment. It is important to create a Recovery Repair diskette as soon as possible and store it in a safe place as a precautionary measure.

**To create a Recovery Repair diskette, do the following:**

1. Start your computer and operating system.
2. Using an Internet browser, go to the following Web address:  
<http://www.lenovo.com/think/support/site.wss/document.do?lnocid=MIGR-54483>
3. Insert a diskette into diskette drive A. Information on the diskette will be erased and the diskette will be formatted appropriately.
4. Double-click on the appropriate file name. The diskette is created.
5. Take out the diskette and label it Recovery Repair diskette.

**To use the Recovery Repair diskette, do the following:**

1. Shut down the operating system and turn off the computer.

2. Insert the Recovery Repair diskette into diskette drive A.
3. Turn on the computer and follow the instructions on the screen.

**Note:** If the repair operation finishes without error, you will be able to access the Rescue and Recovery workspace by repeatedly pressing the F11 key while you restart your computer. When you hear beeps or see a logo screen, release the F11 key. You will also be able to access the Windows environment after the repair operation finishes.

If an error message appears during the repair operation and the repair operation cannot be completed, you might have a problem with the partition that contains the Rescue and Recovery workspace. Use your rescue media to access the Rescue and Recovery workspace. For information about creating and using rescue media, see “Creating and using rescue media” on page 50.

---

## Recovering or installing device drivers

Before you can recover or install device drivers, your operating system must be installed on your computer. Make sure that you have the documentation and software media for the device.

Device drivers for factory-installed devices are located on the computer hard disk drive (usually drive C) in the SWTOOLS\drivers folder. Other device drivers are on the software media that come with individual devices.

The latest device drivers for factory-installed devices also are available on the World Wide Web at <http://www.lenovo.com/think/support/>.

### To reinstall a device driver for a factory-installed device, do the following:

1. Start your computer and operating system.
2. Use Windows Explorer or My Computer to display the directory structure of your hard disk drive.
3. Open the C:\SWTOOLS folder.
4. Open the DRIVERS folder. Within the DRIVERS folder are several subfolders that are named for various devices that are installed in your computer (for example, AUDIO or VIDEO).
5. Open the appropriate device subfolder.
6. Use one of the following methods to reinstall the device driver:
  - In the device subfolder, look for a README.TXT or other file with the .TXT extension. This file might be named after the operating system, such as WIN98.TXT. The text file has information on how to reinstall that device driver.
  - If the device subfolder contains a file with an .INF extension, you can use the Add New Hardware program (located in the Windows Control Panel) to reinstall the device driver. Not all device drivers can be reinstalled using this program. In the Add New Hardware program, when prompted for the device driver that you want to install, click **Have Disk** and **Browse**. Then select the appropriate device driver file from the device subfolder.
  - In the device subfolder, look for a SETUP.EXE file. Double-click **SETUP.EXE** and follow the instructions on the screen.

---

## Setting a rescue device in the startup sequence

Before you start the Rescue and Recovery program from a CD, DVD, USB hard disk drive, or any external device, you must first change the startup sequence in the Setup Utility.

To view or change the startup sequence, do the following:

1. With the computer turned off, repeatedly press and release the F1 key while you turn on the computer.
2. When the logo screen appears, or you hear a series of beeps, release the F1 key.
3. If you are prompted for a password, type your current password.
4. From the Setup Utility main menu, use the right-arrow key to select **Startup**.
5. Arrange the startup sequence to meet your needs.
6. Press the Esc key twice to go to the Setup Utility exit menu.
7. Use the down-arrow key to select Save and exit the Setup Utility, then press Enter.
8. When the Setup Confirmation window appears, press Enter.
9. The computer restarts.

**Note:** If you are using an external device, you first must turn off your computer before connecting the external device.

For more information on Setup Utility, see Chapter 5, “Using the Setup Utility,” on page 31.

---

## Solving recovery problems

If you are unable to access the Rescue and Recovery workspace or the Windows environment, you can:

- Use your rescue media (CD, DVD, or USB hard disk drive) to start the Rescue and Recovery workspace. See “Creating and using rescue media” on page 50 for details.
- Use a Recovery Repair diskette to repair the Rescue and Recovery workspace or repair a file needed to enter the Windows environment. See “Creating and using a Recovery Repair diskette” on page 51 for details.
- Use a set of Product Recovery discs if your intent is to restore the hard disk drive to its original factory contents. See “Creating and using the Product Recovery disc” on page 47.

It is important to create a Recovery Repair diskette, rescue media, and a set of Product Recovery discs as soon as possible and store them in a safe place.

If you are unable to access the Rescue and Recovery workspace or the Windows environment from rescue media, a Recovery Repair diskette, or a set of Product Recovery CDs, you might not have the rescue device, CD drive, DVD drive, or USB hard disk drive defined as a startup device in the BIOS startup sequence. For more information, see “Setting a rescue device in the startup sequence.”



---

## Chapter 9. Getting information, help, and service

This chapter contains information about help, service, and technical assistance for products manufactured by Lenovo.

---

### Information resources

This section describes how to access useful resources relating to your computing needs.

#### Online Books folder

The Online Books folder provides publications to help you set up and use your computer. The Online Books folder is preinstalled on your computer and requires no Internet access to view the publications. In addition to this *User Guide*, the *Hardware Installation and Replacement Guide* is also available in the Online Books folder.

The *Hardware Installation and Replacement Guide* provides step-by-step instructions for replacing Customer Replacement Units (CRUs) in your computer. CRUs are computer parts that can be upgraded or replaced by the customer.

To view a publication, open the **Start** menu from the Windows desktop, select **All Programs**, select **Online Books**, and click **Online Books**. Double-click on the appropriate publication for your computer. The publications also are available on the Lenovo Web site at <http://www.lenovo.com>.

#### Notes:

1. These publications are in Portable Document Format (PDF) format, which requires Adobe Acrobat Reader to be installed. If Adobe Acrobat Reader has not yet been installed on your computer, a message will appear when you attempt to view the PDF file and you will be guided through the Adobe Acrobat Reader installation.
2. The publications that are preinstalled on your computer are available in other languages on the Lenovo Support Web site at <http://www.lenovo.com/support/>.
3. If you want to install a different language version of Adobe Acrobat Reader than the version provided on your computer, go to the Adobe Web site at <http://www.adobe.com> and download the version you want to use.

#### ThinkVantage Productivity Center

The ThinkVantage Productivity Center program contains information sources and tools designed to make computing easier and secure.

The ThinkVantage Productivity Center program provides information about your computer and easy access to various technologies, such as:

- The Rescue and Recovery program
- Productivity Center
- Client Security Solutions
- Factory Recovery
- System Updates

- Service and support

**Note:** ThinkVantage Technologies are only available on select Lenovo computers.

To access the ThinkVantage Productivity Center program, open the **Start** menu from the Windows desktop, select **All Programs**, select **ThinkVantage**, and click **Productivity Center**.

## Access Help

The Access Help online help system provides information about getting started, doing basic tasks, customizing settings for your personal preference, protecting data, expanding and upgrading, and troubleshooting.

To open Access Help, open the **Start** menu from the Windows desktop, select **All Programs**, select **ThinkVantage**, and click **Access Help**. After you have opened Access Help, use the left panel to make a selection from the Contents or Index tab, or use the Search tab to find a particular word or phrase.

## Safety and Warranty

The safety and warranty information that is provided with your computer contains information on safety, and warranty, notices. Read and understand all safety information before using this product.

## www.lenovo.com

The Lenovo Web site ([www.lenovo.com](http://www.lenovo.com)) provides information and services to help you buy, upgrade, and maintain your computer. You can access up-to-date information for your computer on the Lenovo Web site. From the [www.lenovo.com](http://www.lenovo.com) Web site, you can also:

- Shop for:
  - Desktop and notebook computers,
  - Monitors
  - Projectors
  - Upgrades and accessories
  - Special offers.
- Purchase additional services, such as support for hardware, operating systems, application programs, network setup and configuration, and custom installations.
- Purchase upgrades and extended hardware repair services.
- Download the latest device drivers and software updates for your computer model.
- Access the online manuals.
- Access the Lenovo Statement of Limited Warranty.
- Access troubleshooting and support information for your computer model and other supported products.
- Find the service and support phone number for your country or region.
- Find a service provider located near you.



---

## Help and service

This section contains information about obtaining help and service.

### Using the documentation and diagnostic programs

If you experience a problem with your computer, see Chapter 7, “Troubleshooting and diagnostics,” on page 39. For information on additional resources to help you troubleshoot your computer problem, see “Information resources” on page 55.

If you suspect a software problem, see the documentation, including README files and online help, that comes with the operating system or application program.

Most computers come with a set of diagnostic programs that you can use to help you identify hardware problems. For instructions on using the diagnostic programs, see “Diagnostic programs” on page 40.

Lenovo maintains pages on the World Wide Web where you can get the latest technical information and download device drivers and updates. To access these pages, go to <http://www.lenovo.com/support/> and follow the instructions.

### Calling for service

During the warranty period you can get help and information by telephone through the Customer Support Center.

These services are available during the warranty period:

- **Problem determination** - Trained personnel are available to assist you with determining a hardware problem and deciding what action is necessary to fix the problem.
- **Hardware repair** - If the problem is caused by hardware under warranty, trained service personnel are available to provide the applicable level of service.
- **Engineering Change management** - There might be changes that are required after a product has been sold. Lenovo or your reseller will make selected Engineering Changes (ECs) available that apply to your hardware.

These items are not covered by the warranty.

- Replacement or use of parts not manufactured for or by Lenovo or non-warranted Lenovo parts
- Identification of software problem sources
- Configuration of BIOS as part of an installation or upgrade
- Changes, modifications, or upgrades to device drivers
- Installation and maintenance of network operating systems (NOS)
- Installation and maintenance of application programs

Refer to the safety and warranty information that is provided with your computer for a complete explanation of warranty terms. You must retain your proof of purchase to obtain warranty service.

For a list of service and support phone numbers for your country or region, go to <http://www.lenovo.com/support/> and click **Support phone list** or refer to the safety and warranty information provided with your computer.

**Note:** Phone numbers are subject to change without notice. If the number for your country or region is not provided, contact your Lenovo reseller or Lenovo marketing representative.

If possible, be at your computer when you call. Have the following information available:

- Machine type and model
- Serial numbers of your hardware products
- Description of the problem
- Exact wording of any error messages
- Hardware and software configuration information

## Using other services

If you travel with your computer or relocate it to a country where your desktop or notebook computer machine type is sold, your computer might be eligible for International Warranty Service, which automatically entitles you to obtain warranty service throughout the warranty period. Service will be performed by service providers authorized to perform warranty service.

Service methods and procedures vary by country, and some services might not be available in all countries. International Warranty Service is delivered through the method of service (such as depot, carry-in, or on-site service) that is provided in the servicing country. Service centers in certain countries might not be able to service all models of a particular machine type. In some countries, fees and restrictions might apply at the time of service.

To determine whether your computer is eligible for International Warranty Service and to view a list of the countries where service is available, go to <http://www.lenovo.com/support/>, click **Warranty**, and follow the instructions on the screen.

For technical assistance with the installation of or questions related to Service Packs for your preinstalled Microsoft Windows product, refer to the Microsoft Product Support Services Web site at <http://support.microsoft.com/directory/>, or you can contact the Customer Support Center. Some fees might apply.

## Purchasing additional services

During and after the warranty period, you can purchase additional services, such as support for hardware, operating systems, and application programs; network setup and configuration; upgraded or extended hardware repair services; and custom installations. Service availability and service name might vary by country or region. For more information about these services, go to the Lenovo Web site at <http://www.lenovo.com>.

---

## Appendix A. Manual modem commands

The following section lists commands for manually programming your modem.

Commands are accepted by the modem while it is in Command Mode. Your modem is automatically in Command Mode until you dial a number and establish a connection. Commands can be sent to your modem from a PC running communication software or any other terminal devices.

All commands sent to the modem must begin with **AT** and end with **ENTER**. All commands can be typed in either upper or lower case, but not mixed. To make the command line more readable, spaces can be inserted between commands. If you omit a parameter from a command that requires one, it is just like specifying a parameter of **0**.

Example:

**ATH [ENTER]**

---

### Basic AT commands

In the following listings, all default settings are printed in **bold text**.

| Command |    | Function  |
|---------|----|---|
| A       |    | Manually answer incoming call.  |
| A/      |    | Repeat last command executed. <b>Do not</b> precede <b>A/</b> with AT or follow with ENTER.       |
| D_      |    | <b>0 - 9, A-D, # and *</b>  |
|         | L  | last number redial  |
|         | P  | pulse dialing   |
|         |    | <b>Note: Pulse dialing is not supported for Australia, New Zealand, Norway, and South Africa.</b> |
|         | T  | <b>touch-tone dialing</b>   |
|         | W  | wait for second dial tone   |
|         | ,  | pause   |
|         | @  | wait for five seconds of silence  |
|         | !  | flash   |
|         | ;  | return to Command Mode after dialing  |
| DS=n    |    | Dial one of the four telephone numbers (n=0-3) stored in the modem non-volatile memory.           |
| E_      | E0 | Commands are not echoed   |
|         | E1 | <b>Commands are echoed</b>  |
| +++     |    | Escape Characters - Switch from Data Mode to Command Mode (T.I.E.S. Command)                      |
| H_      | H0 | Force modem on-hook (hang up)   |

| Command |    | Function   |
|---------|----|--|
|         | H1 | Force modem off-hook (make busy)<br><b>Note: H1 command is not supported for Italy</b> |
| I_      | I0 | Display product-identification code  |
|         | I1 | Factory ROM checksum test  |
|         | I2 | Internal memory test   |
|         | I3 | Firmware ID  |
|         | I4 | Reserved ID  |
| L_      | L0 | Low speaker volume   |
|         | L1 | <b>Low speaker volume</b>  |
|         | L2 | Medium speaker volume  |
|         | L3 | High speaker volume  |
| M_      | M0 | Internal speaker off   |
|         | M1 | <b>Internal speaker on until carrier detected</b>                                      |
|         | M2 | Internal speaker always on   |
|         | M3 | Internal speaker on until carrier detected and off while dialing                       |
| N_      |    | Included for compatibility only, provides no effect                                    |
| O_      | O0 | Return to Data Mode  |
|         | O1 | Return to Data Mode and initiate an equalizer retrain                                  |
| P       |    | <b>Set Pulse dial as default</b>   |
| Q_      | Q0 | Modem sends responses  |
| Sr?     |    | Read and display value in register r.  |
| Sr=n    |    | Set register r to value n (n = 0-255).   |
| T       |    | <b>Set Tone Dial as default</b>  |
| V_      | V0 | <b>Numeric responses</b>   |
|         | V1 | <b>Word responses</b>  |
| W_      | W0 | <b>Report DTE speed only</b>   |
|         | W1 | Report line speed, error correction protocol, and DTE speed.                           |
|         | W2 | Report DCE speed only  |
| X_      | X0 | Hayes Smartmodem 300 compatible responses/blind dialing.                               |
|         | X1 | Same as X0 plus all CONNECT responses/blind dialing                                    |
|         | X2 | Same as X1 plus dial tone detection  |
|         | X3 | Same as X1 plus busy detection/blind dialing   |
|         | X4 | All responses and dial tone and busy <b>signal detection</b>                           |
| Z_      | Z0 | Reset and retrieve active profile 0  |
|         | Z1 | Reset and retrieve active profile 1  |

## Extended AT commands

| Command |     | Function  |
|---------|-----|---|
| &C_     | &C0 | Force Carrier Detect Signal High (ON)                               |
|         | &C1 | <b>Turn on CD when remote carrier is present</b>                    |
| &D_     | &D0 | <b>Modem ignores the DTR signal</b>                                 |
|         | &D1 | Modem returns to Command Mode after DTR toggle                      |
|         | &D2 | <b>Modem hangs up, returns to the Command Mode after DTR toggle</b> |
|         | &D3 | Resets modem after DTR toggle                                       |
| &F_     | &F  | Recall factory default configuration                                |
| &G_     | &G0 | <b>Guard tone disabled</b>  |
|         | &G1 | Guard tone disabled   |
|         | &G2 | 1800 Hz guard tone  |
| &K_     | &K0 | Disable flow control  |
|         | &K3 | <b>Enable RTS/CTS hardware flow control</b>                         |
|         | &K4 | Enable XON/XOFF software flow control                               |
|         | &K5 | Enable transparent XON/XOFF flow control                            |
|         | &K6 | Enable both RTS/CTS and XON/XOFF flow control                       |
| &M_     | &M0 | Asynchronous operation  |
| &P_     | &P0 | <b>US setting for off-hook-to-on-hook ratio</b>                     |
|         | &P1 | UK and Hong Kong off-hook-to-on-hook ratio                          |
|         | &P2 | Same as &P0 setting but at 20 pulses per minute                     |
|         | &P3 | Same as &P1 setting but at 20 pulses per minute                     |
| &R_     | &R0 | Reserved  |
|         | &R1 | <b>CTS operates per flow control requirements</b>                   |
| &S_     | &S0 | <b>Force DSR Signal High (ON)</b>                                   |
|         | &S1 | DSR off in command mode, on in on-line mode                         |
| &T_     | &T0 | Ends test in progress   |
|         | &T1 | Perform Local Analog Loopback Test                                  |
|         | &T3 | Perform Local Digital Loopback Test                                 |
|         | &T4 | <b>Grant Remote Digital Loopback Test request by remote modem</b>   |
|         | &T5 | Deny Remote Digital Loopback Test request                           |
|         | &T6 | Perform a Remote Digital Loopback Test                              |
|         | &T7 | Perform a Remote Digital Loopback Test and Self-Test                |
|         | &T8 | Perform Local Analog Loopback Test and Self-Test                    |
| &V      | &V0 | Displays Active and Stored Profiles                                 |

| Command       |     | Function  |
|---------------|-----|---|
|               | &V1 | Display Last Connection Statistics  |
| &W_           | &W0 | Stores the active profile as Profile 0  |
|               | &W1 | Stores the active profile as Profile 1  |
| %E_           | %E0 | <b>Disable auto-retrain</b>   |
|               | %E1 | Enable auto-retrain   |
| +MS?          |     | Displays the current Select Modulation settings   |
| +MS=?         |     | Displays a list of supported Select Modulation options  |
| +MS=a,b,c,e,f |     | Select modulation where: <b>a</b> =0, 1, 2, 3, 9, 10, 11, 12, 56, 64, 69; <b>b</b> =0-1; <b>c</b> =300-56000; <b>d</b> =300-56000; <b>e</b> =0-1; and <b>f</b> =0-1. <b>A, b, c, d, e, f</b> default= <b>12, 1, 300, 56000, 0, 0</b> . Parameter " <b>a</b> " specifies the modulation protocol desired where: 0=V.21, 1=V.22, 2=V.22bis, 3=V.23, 9=V.32, 10=V.32bis, 11=V.34, 12=V.90,K56Flex,V.34.....,56=K 56Flex, V.90,V.34....., 64=Bell 103, and 69=Bell 212. Parameter " <b>b</b> " specifies automode operations where: 0=automode disabled, 1= automode enabled with V.8/V.32 Annex A. Parameter " <b>c</b> " specifies the minimum connection data rate (300- 56000). Parameter " <b>d</b> " specifies the maximum connection rate (300-56000); Parameter " <b>e</b> " specifies the codec type (0= Law, and 1=A-Law). Parameter " <b>f</b> " specifies "robbed bit" signaling detection (0=detection disabled 1=detection enabled) |

## MNP/V.42/V.42bis/V.44 commands

| Command    |     | Function   |
|------------|-----|--|
| %C_        | %C0 | Disable MNP Class 5 and V.42bis data compression       |
|            | %C1 | Enable MNP Class 5 data compression only               |
|            | %C2 | Enable V.42bis data compression only                   |
|            | %C3 | <b>Enable MNP Class 5 and V.42bis data compression</b> |
| &Q_        | &Q0 | Direct data link only (same as \N1)                    |
|            | &Q5 | <b>V.42 data link with fallback options</b>            |
|            | &Q6 | Normal data link only (same as \N0)                    |
| +DS44=0, 0 |     | Disable V.44   |
| +DS44=3, 0 |     | Enable V.44  |
| +DS44?     |     | Current values   |
| +DS44=?    |     | List of support values                                 |

---

## Fax Class 1 commands

|           |                                 |
|-----------|---------------------------------|
| +FAE=n    | Data/Fax Auto Answer            |
| +FCLASS=n | Service Class                   |
| +FRH=n    | Receive data with HDLC framing  |
| +FRM=n    | Receive data                    |
| +FRS=n    | Receive silence                 |
| +FTH=n    | Transmit data with HDLC framing |
| +FTM=n    | Transmit data                   |
| +FTS=n    | Stop transmission and wait      |

---

## Fax Class 2 commands

|           |   |
|-----------|---|
| +FCLASS=n | Services class.                           |
| +FAA=n    | Adaptive answer.                          |
| +FAXERR   | Fax error value.                          |
| +FBOR     | Phase C data bit order.                   |
| +FBUF?    | Buffer size (read only).                  |
| +FCFR     | Indicate confirmation to receive.         |
| +FCLASS=  | Service class.                            |
| +FCON     | Facsimile connection response.            |
| +FCIG     | Set the polled station identification.    |
| +FCIG:    | Report the polled station identification. |
| +FCR      | Capability to receive.                    |
| +FCR=     | Capability to receive.                    |
| +FCSI:    | Report the called station ID.             |
| +FDCC=    | DCE capabilities parameters.              |
| +FDCS:    | Report current session.                   |
| +FDCS=    | Current session results.                  |
| +FDIS:    | Report remote capabilities.               |
| +FDIS=    | Current sessions parameters.              |
| +FDR      | Begin or continue phase C receive data.   |
| +FDT=     | Data transmission.                        |
| +FDTC:    | Report the polled station capabilities.   |
| +FET:     | Post page message response.               |
| +FET=N    | Transmit page punctuation.                |
| +FHNG     | Call termination with status.             |
| +FK       | Session termination.                      |
| +FLID=    | Local ID string.                          |
| +FLPL     | Document for polling.                     |
| +FMDL?    | Identify model.                           |
| +FMFR?    | Identify manufacturer.                    |

|         |                                 |
|---------|---------------------------------|
| +FPHCTO | Phase C time out.               |
| +FPOLL  | Indicates polling request.      |
| +FPTS:  | Page transfer status.           |
| +FPTS=  | Page transfer status.           |
| +FRECV? | Identify revision.              |
| +FSPT   | Enable polling.                 |
| +FTSI:  | Report the transmit station ID. |

---

## Voice commands

|       |   |
|-------|---|
| #BDR  | Select Baud Rate                                |
| #CID  | Enable Caller ID detection and reporting format |
| #CLS  | Select Data, Fax or Voice/Audio                 |
| #MDL? | Identify Model                                  |
| #MFR? | Identify Manufacturer                           |
| #REV? | Identify Revision Level                         |
| #TL   | Audio output transmit level                     |
| #VBQ? | Query Buffer Size                               |
| #VBS  | Bits per sample (ADPCM or PCM)                  |
| #VBT  | Beep Tone Timer                                 |
| #VCI? | Identify Compression Method                     |
| #VLS  | Voice line select                               |
| #VRA  | Ringback goes away timer                        |
| #VRN  | Ringback never came timer                       |
| #VRX  | Voice Receive Mode                              |
| #VSDB | Silence deletion tuner                          |
| #VSK  | Buffer skid setting                             |
| #VSP  | Silence detection period                        |
| #VSR  | Sampling rate selection                         |
| #VSS  | Silence deletion tuner                          |
| #VTD  | DTMF tone reporting capability                  |
| #VTM  | Enable timing mark placement                    |
| #VTS  | Generate tone signals                           |
| #VTX  | Voice transmit mode                             |



**Attention Switzerland User:**

If your Swisscom phone line does not have Taxsignal switched OFF, modem function may be impaired. The impairment may be resolved by a filter with the following specifications:

Telekom PTT SCR-BE  
Taximpulssperrfilter-12kHz  
PTT Art. 444.112.7  
Bakom 93.0291.Z.N



---

## Appendix B. Notices

Lenovo may not offer the products, services, or features discussed in this document in all countries. Consult your local Lenovo representative for information on the products and services currently available in your area. Any reference to a Lenovo product, program, or service is not intended to state or imply that only that Lenovo product, program, or service may be used. Any functionally equivalent product, program, or service that does not infringe any Lenovo intellectual property right may be used instead. However, it is the user's responsibility to evaluate and verify the operation of any other product, program, or service.

Lenovo may have patents or pending patent applications covering subject matter described in this document. The furnishing of this document does not give you any license to these patents. You can send license inquiries, in writing, to:

*Lenovo (United States), Inc.  
1009 Think Place - Building One  
Morrisville, NC 27560  
U.S.A.  
Attention: Lenovo Director of Licensing*

LENOVO PROVIDES THIS PUBLICATION "AS IS" WITHOUT WARRANTY OF ANY KIND, EITHER EXPRESS OR IMPLIED, INCLUDING, BUT NOT LIMITED TO, THE IMPLIED WARRANTIES OF NON-INFRINGEMENT, MERCHANTABILITY OR FITNESS FOR A PARTICULAR PURPOSE. Some jurisdictions do not allow disclaimer of express or implied warranties in certain transactions, therefore, this statement may not apply to you.

This information could include technical inaccuracies or typographical errors. Changes are periodically made to the information herein; these changes will be incorporated in new editions of the publication. Lenovo may make improvements and/or changes in the product(s) and/or the program(s) described in this publication at any time without notice.

The products described in this document are not intended for use in implantation or other life support applications where malfunction may result in injury or death to persons. The information contained in this document does not affect or change Lenovo product specifications or warranties. Nothing in this document shall operate as an express or implied license or indemnity under the intellectual property rights of Lenovo or third parties. All information contained in this document was obtained in specific environments and is presented as an illustration. The result obtained in other operating environments may vary.

Lenovo may use or distribute any of the information you supply in any way it believes appropriate without incurring any obligation to you.

Any references in this publication to non-Lenovo Web sites are provided for convenience only and do not in any manner serve as an endorsement of those Web sites. The materials at those Web sites are not part of the materials for this Lenovo product, and use of those Web sites is at your own risk.

Any performance data contained herein was determined in a controlled environment. Therefore, the result obtained in other operating environments may

vary significantly. Some measurements may have been made on development-level systems and there is no guarantee that these measurements will be the same on generally available systems. Furthermore, some measurements may have been estimated through extrapolation. Actual results may vary. Users of this document should verify the applicable data for their specific environment.

---

## Television output notice

The following notice applies to models that have the factory-installed television-output feature.

This product incorporates copyright protection technology that is protected by method claims of certain U.S. patents and other intellectual property rights owned by Macrovision Corporation and other rights owners. Use of this copyright protection technology must be authorized by Macrovision Corporation, and is intended for home and other limited viewing uses only unless otherwise authorized by Macrovision Corporation. Reverse engineering or disassembly is prohibited.

---

## Trademarks

The following terms are trademarks of Lenovo in the United States, other countries, or both:

- Lenovo
- The Lenovo logo
- Rescue and Recovery
- ThinkCentre
- ThinkVantage

The following terms are trademarks of International Business Machines Corporation in the United States, other countries, or both:

- IBM
- Wake on LAN

Microsoft, Windows, and Windows Vista are trademarks of Microsoft Corporation in the United States, other countries, or both.

Intel, Celeron, Intel Core, and Pentium are trademarks of Intel Corporation in the United States, other countries, or both.

Linux is a trademark of Linus Torvalds in the United States, other countries, or both.

Other company, product, or service names may be trademarks or service marks of others.

---

# Index

## A

- access help 56
- administration, password 32
- advanced settings 34
- antivirus software, updating 11
- arranging workspace 3
- AT commands
  - basic 59
  - extended 61
- audio subsystem 12, 15, 18, 21

## B

- backup and recovery operations 48
- basic trouble shooting 39
- BIOS, updating (flashing) 35, 36
- books folder, online 55
- boot-block recovery 36

## C

- cable lengths 4
- changing
  - password 32
  - startup device sequence 33
- cleaning the mouse 43
- comfort 3
- commands
  - basic AT 59
  - fax class 1 63
  - fax class 2 63
  - manual modem 59
  - MNP/V.42/V.42bis/V.44 62
  - voice 64
- computer
  - connecting your 5
  - setting up your 5
  - shutting down 11
- connecting your computer 5
- considerations, passwords 31
- creating
  - and using recovery repair diskette 51
  - and using rescue media 50
  - diagnostic CD image 41
  - product recovery disc 47
- customer support center 57

## D

- deleting password 32
- device drivers
  - installing 52
  - recovering 52
- diagnostic
  - CD image 10, 42
    - creating 41
  - diskettes 10, 41, 42
    - creating 41
  - PC-Doctor for DOS 40, 41

- diagnostic (*continued*)

- PC-Doctor for Windows 40, 41
- PC-Doctor for Windows PE 40, 43
- programs 40
- Rescue and Recovery workspace 42, 43
- running diskettes 42
- running, CD image 42

- diagnostics 39
- diagnostics programs, using 57
- disc, creating product recovery 47
- diskette, creating and using a recovery repair 51
- documentation, using 57

## E

- electrical outlets 4
- environment, operating 24, 25, 26, 27
- Ethernet 12, 15, 18, 21
- exiting, setup utility 34
- expansion adapters 14, 17, 20, 23

## F

- failure, recovering from POST/BIOS 36
- fax class 1
  - commands 63
- fax class 2
  - commands 63
- features 12, 15, 18, 21
- flashing BIOS 35
- folder, books online 55

## G

- getting
  - help 55
  - information 55
  - service 55
- glare, lighting 3

## H

- help
  - access 56
  - and service 57
  - getting 55

## I

- important safety information 1
- information
  - getting 55
  - important safety 1
  - resources 55
  - safety 56
  - warranty 56
- input/output (I/O) features 13, 16, 19, 22
- installing
  - device drivers 52

- installing (*continued*)
  - operating system 11
  - software 10
- internal drives 12, 15, 18, 21
- introduction v

## L

- Lenovo web site 56
- lighting, glare 3

## M

- manual modem commands 59
- media, creating and using rescue 50
- MNP/V.42/V.42bis/V.44, commands 62
- modem commands
  - basic AT 59
  - Extended AT 61
  - fax class 1 63
  - fax class 2 63
  - manual 59
  - MNP/V.42/V.42bis/V.44 62
  - Voice 64
- mouse
  - cleaning 43
  - non-optical 44
  - optical mouse 43

## N

- non-optical mouse 44
- notice, television output 68
- notices 67

## O

- online books folder 55
- operating system
  - installing 11
  - updating 11
- operations, backup and recovery 48
- optical mouse 43
- outlets, electrical 4
- overview, software 29

## P

- password
  - administrator 32
  - considerations 31
  - setting, changing, deleting 32
  - user 32
- passwords, using 31
- physical specifications 24, 25, 26, 27
- power
  - Advanced Configuration and Power Interface (ACPI)
    - support 14, 17, 20, 23
    - features 14, 17, 20, 23
    - turning off computer 11
    - turning on computer 10
  - power-on self-test (POST) 35
  - product recovery disc, creating 47
  - productivity center, ThinkVantage 55
  - programs, updating system 35

- purchasing additional services 58

## R

- recovering
  - device drivers 52
  - from a POST/BIOS update failure 36
  - software 47
- recovery
  - boot-block 36
  - operations, backup and 48
  - problems, solving 53
  - repair diskette, creating and using 51
  - workspace, rescue and 49
- Rescue and Recovery 47
- rescue and recovery workspace 49
- rescue device, starting 53
- rescue media, creating and using 50
- resources, information 55

## S

- safety 1
- safety information 56
- security
  - features 14, 17, 20, 23
  - profile by device, using 32
- selecting
  - start up device 33
  - temporary startup device 33
- service
  - and help 57
  - customer support center 57
  - getting 55
- services
  - other 58
  - purchasing additional 58
- setting
  - password 32
  - rescue device 53
  - up your computer 5
- settings
  - advanced 34
  - changing 31
  - viewing 31
- Setup Utility 31
- setup utility, exiting 34
- software
  - installing 10
  - overview 29
  - recovering 47
- solving recover problems 53
- starting the setup utility program 31
- startup device 33
  - sequence, changing 33
  - temporary, selecting 33
- system
  - management 12, 15, 18, 21
  - programs 35

## T

- television output notice 68
- temporary startup device 33
- ThinkVantage productivity center 55
- trademarks 68

troubleshooting 39  
troubleshooting, basic 39  
turning on power 10

## U

updating  
    (flashing) BIOS 35  
    antivirus software 11  
    operating system 11  
    system programs 35  
updating (flashing) BIOS 36  
user, password 32  
using  
    diagnostic programs 57  
    documentation 57  
    other services 58  
    passwords 31  
    recovery repair diskette, creating and using 51  
    rescue media, creating and 50  
    Setup Utility 31  
utility program, starting 31

## V

video subsystem 12, 15, 18, 21  
viewing and changing settings 31  
voice, commands 64

## W

warranty information 56  
web site, Lenovo 56  
workspace, arranging 3  
workspace, backup and recovery 49







**lenovo**®

Part Number: 43C6566

Printed in USA

(1P) P/N: 43C6566

