

Getting Started

The only warranties for Hewlett-Packard products and services are set forth in the express statements accompanying such products and services. Nothing herein should be construed as constituting an additional warranty. HP shall not be liable for technical or editorial errors or omissions contained herein.

HP assumes no responsibility for the use or reliability of its software on equipment that is not furnished by HP.

This document contains proprietary information that is protected by copyright. No part of this document may be photocopied, reproduced, or translated to another language without the prior written consent of HP.

Hewlett-Packard Company
P.O. Box 4010
Cupertino, CA 95015-4010
USA

© Copyright 2000–2009 Hewlett-Packard Development Company, L.P.

This product incorporates copyright protection technology that is protected by U.S. patents and other intellectual property rights. Use of this copyright protection technology must be authorized by Macrovision, and is intended for home and other limited viewing uses only unless otherwise authorized by Macrovision. Reverse engineering or disassembly is prohibited.

Microsoft and Windows 7 are U.S. registered trademarks of Microsoft Corporation.

The Windows logo and Windows 7 are trademarks or registered trademarks of Microsoft Corporation in the United States and/or other countries/regions.

Wi-Fi CERTIFIED 802.11n based on Draft 2.0

Draft 2.0 refers to the version of the not-yet-ratified IEEE 802.11n standard used in Wi-Fi Alliance testing as of June 2007.

The specifications of the 802.11n WLAN (wireless local area network) are draft specifications and not final. If the final specifications differ from the draft specifications, it may affect the ability of this device to communicate with other 802.11n WLAN devices.

HP supports lawful use of technology and does not endorse or encourage the use of our products for purposes other than those permitted by copyright law.

The information in this document is subject to change without notice.

Table of Contents

Setting Up Your Computer	1
Checking the Computer Installation	1
Connecting Speakers or Microphones	4
Connecting to a Network	6
Connecting a Modem	7
Connecting the Television Signal and Video Cables	7
Preparing to Use Your Computer	13
Turning Off the Computer	14
Restarting the Computer	14
Connecting to the Internet	14
Adjusting the Speaker Volume	16
Selecting the Microphone	16
Protecting Your Computer	17
Configuring the Computer for Automatic Microsoft Software Updates	18
Setting Up User Accounts	19
Guidelines for Installing Software and Hardware Devices	19
Transferring Files and Settings from an Old Computer to Your New Computer	20
Special Features of Your Computer	21
Using the Memory Card Reader	21
Using a Vertical CD/DVD Drive	23
Using LightScribe Technology	23
Using the Remote Control	24
Getting More Information	25
Using the Help and Support Center	25
Accessing Support on the Web	25
Finding Guides on the Web	25
Finding Onscreen Guides	26
Using the PC Help & Tools Folder	26
Using HP Advisor Software	26
Using the Computer with Safety and Comfort	27
Troubleshooting and Maintenance	29
Troubleshooting Computer Problems	29
Software Troubleshooting	45
Maintenance	48
Keeping the Computer Free of Dust, Dirt, and Heat	49
System Recovery	50
Performing the Post-Recovery Procedure	54
Additional Troubleshooting	54
Index	55

Setting Up Your Computer



WARNING: The power supply is preset for the country/region in which you purchased your computer. If you move, please check the voltage requirements for your new location before plugging the computer into an AC power outlet.



WARNING: Please read “Safety Notices” in the *Regulatory and Safety Information* document before installing and connecting the computer to the electrical power system.



WARNING: To reduce the risk of serious injury, read the *Safety & Comfort Guide*. It describes proper workstation setup, posture, and health and work habits for computer users. It also provides important electrical and mechanical safety information.

Follow the steps on the setup poster to set up the computer:

- 1 Connect a keyboard and a mouse to the computer.
 - 2 Connect a display (monitor) to the computer.
 - 3 Connect power to the computer.
 - 4 Turn on the computer. See “Preparing to Use Your Computer” on page 13.
-

NOTE: Do not connect or add other devices to the computer until after you turn on the computer for the first time and complete the initial setup. See “Preparing to Use Your Computer” on page 13.

Checking the Computer Installation

- Place the computer in an appropriate location so that:
 - All ventilation openings are unobstructed.
 - All cabling is out of the way. Do not place any cable in a walkway or where it can be stepped on or damaged from placing furniture on it.
-



WARNING: Place the computer in a location away from water, dust, moisture, and soot. These can increase the inside temperature, causing fire, trouble, and electrification.

- Protect the monitor, computer, and connected accessories by connecting all power cords to a power surge protection device. Use a power strip specifically labeled as having surge protection, an uninterruptible power supply (UPS), or a similar device.







If the computer has a television tuner, or a modem or telephone connection, protect the computer by using surge protection with these signal inputs as well. Connect the television cable or the telephone line cord to the inputs and outputs of the surge protection device and then to the computer.



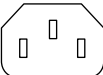





- Look in the computer box for additional printed details or updates regarding your computer.

Connecting other devices to the computer

Some peripheral devices can plug into connectors on the back of the computer or on the front of the computer.

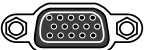
NOTE: The location, availability, and number of connectors on the computer may vary.

Power cord and devices	Icon/label	Description and function
		Power connector.
		Mouse (PS/2 connector).
		Keyboard (PS/2 connector).
		Universal Serial Bus (USB) 2.0 for mouse, keyboard, digital cameras, or other devices with USB connectors.

Network	Icon/label	Description and function
	ETHERNET	Ethernet LAN connector to connect to an Ethernet (RJ-45) local area network (LAN) hub or any broadband connection. This wired LAN connector is a network interface adapter (also called a network interface card, or NIC). The green LED indicates a valid connection.
Modem	Icon/label	Description and function
	 LINE	Modem (Line In RJ-11) (select models only) to connect the computer modem to a telephone wall jack for dial-up connections to the Internet.
Display video output	Icon/label	Description and function
	DVI	Recommended for connecting to a monitor. Digital video output connector (select models only), to connect to a TV or monitor. You may need to use a VGA-to-DVI or an HDMI-to-DVI adapter to connect the display to the computer.
	VGA/Monitor 	VGA/Monitor (blue) display output connector, to connect to a VGA monitor. You may need to use a VGA-to-DVI adapter to connect a display with only a DVI connector to the computer.
	HDMI	Recommended for connecting to a TV. HDMI display output connector, to connect to an HDMI monitor or TV display. You may need to use an HDMI-to-DVI adapter to connect a display with only a DVI connector to the computer.
	VGA-DVI	VGA-to-DVI adapter, to adapt a TV or a monitor video cable so it can connect to the computer.
	HDMI-DVI	HDMI-to-DVI adapter, to adapt a TV or a monitor video cable so it can connect to the computer.

Connecting Speakers or Microphones

Speakers are available separately, or may be included with the monitor (select models only). Headphones and microphones are available separately.

Your computer model may include audio connectors on the back of the computer. Some computers also have connectors on the front of the computer. Audio connectors are stereo mini-jacks that connect from the computer to active (powered) speakers or speaker systems, to headphones, or to an input device such as a microphone, webcam, or audio player.

Some, but not all, audio connectors that may be on the computer appear in the following table.







NOTE: The location, availability, and number of connectors on the computer may vary.

Connecting speakers

Speakers are available separately, or included with the monitor.

Your computer supports only active (powered) speaker systems; the speaker system must have its own power source, such as batteries or a separate power cord.

For detailed instructions about how to connect and configure other multichannel speakers, go to the Web support page for your model; see "Accessing Support on the Web" on page 25.

Audio connectors	Icon/label	Description and function
	 OUT	Audio Line Out (lime green) to connect front left and front right analog speakers.
	 IN	Audio Line In (blue) connector to connect input to the computer from an analog audio device, such as a CD player. May function as rear Line Out in a multichannel audio configuration.
	Center	Line C/Sub (gold) connector to connect Center/Subwoofer speakers in a multichannel audio configuration.
	Rear	Line Rear (black) connector to connect rear speakers in a multichannel audio configuration.
	Side	Line Side (gray) connector to connect side speakers in an eight-speaker system (7.1).

Connecting a stereo speaker system

To connect active speakers, such as left/right stereo speakers or a 2.1 system of two speakers and a subwoofer, to the computer:

- 1 Ensure that the computer is turned off, and that the speaker system is turned off and unplugged.
- 2 Connect the speaker system cable to the lime green Audio Line Out connector that matches the back of your computer.

Or

For 2.1 speakers or other multichannel speakers that were shipped with your computer (select models only), connect the subwoofer to the Audio Line Out connector on the computer, and connect the left and right speakers to the subwoofer.

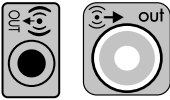

NOTE: Always turn on the computer before you turn on the speaker system.

Connecting headphones

Headphones are available separately.

Your computer comes with a headphones connector (lime green) on the front of the computer. The headphones connector is labeled with a headphones icon.

You can also connect headphones to the Audio Line Out connector (lime green) on the back of your computer.

When headphones are plugged in, the sound to the speakers (and the subwoofer) is usually muted.



Connecting a microphone

Microphones are available separately.

Your computer comes with a microphone connector (pink) on the back of the computer. Some models have a second microphone connector on the front of the computer (select models only).

Connect the microphone to the microphone connector on the computer.



To adjust the recording volume or select the microphone, see “Selecting the Microphone” on page 16.

Connecting to a Network

This section describes connecting to a network through a wired or wireless connection.

Setting up a wired Ethernet network connection

The Ethernet (RJ-45) connector on the back of the computer provides a high-speed or broadband connection to a network. After you connect this interface to a network, such as a Local Area Network (LAN), you can connect to the Internet through the network.

- 1 Connect an Ethernet cable to the Ethernet (RJ-45) connector (**A**) on the back of the computer, and to the network router or LAN device.

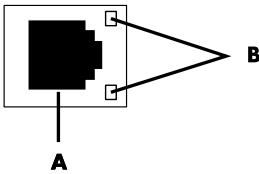

- 2 With the computer turned on, check the indicator lights (**B**) next to the Ethernet connector for the status:
 - **ACTIVITY** — Lit yellow during network data transfer activity
 - **LINK** — Lit green when there is a valid network connection

NOTE: Your Ethernet connector may have only one indicator light.

Setting up a wireless network connection

(Select models only)

You can connect the computer to a wireless network supporting IEEE 802.11b, 802.11g, or 802.11n by using the antenna that is included with the computer. If provided, connect the external antenna to the wireless antenna connector on the network card to increase the range and sensitivity of the wireless radio signal.

NOTE: For the best wireless performance, place the antenna on the top of the computer or in an elevated and open area.

You need an existing wireless LAN with an Internet connection. Consult your Internet Service Provider (ISP) for further information.

To verify that the integrated WLAN device is installed on the computer correctly, see “Internet access” on page 37.

For more information about setting up a wireless network: Click the Windows **Start** button , click **Help and Support**, and then type *setting up a wireless network* into the Search Help box and press Enter.

Connecting a Modem

(Select models only)

The modem connects the computer to the telephone line. Use it to connect to an ISP that provides a telephone dial-up connection to the Internet. If you use a network connection, you may not need a modem connection.

NOTE: Your computer may not come with a modem. The modem may be a connector on the back of the computer or it may be an external device that plugs into a computer USB connector.

Before you can use telephone dial-up to connect to the Internet and send or receive e-mail and faxes, you must connect your telephone service line to the modem connector (**A**).

- 1 Plug a modem/telephone cable into the computer modem connector (**A**). Note that the modem connector on the computer may be green.
- 2 Plug the other end of the modem/telephone cable into the telephone service line wall jack connector.

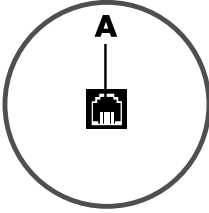

Connecting the Television Signal and Video Cables

(Select models only)

This section describes how to connect the computer to a television and which cables to use.

Use cables to connect:

- TV signal source coaxial cable for video/audio into the computer.









Or



- TV signal source S-video or composite video into the computer.
- TV signal source audio into the computer.



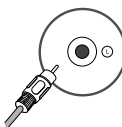

Or

- Video out from the computer.

You may need to purchase cables, a coaxial cable signal splitter, or other accessories separately. Your computer may not include all the cables you need for the television/video setup.

Video and audio input	Icon/label	Description and function
	S-Video	S-video In connector to connect video input from a TV set-top box output connector.
	Composite Video	Composite Video In connector (yellow) to connect video input from a TV set-top box.
	S-Video 2	Secondary S-video In connector to connect video input from a VCR, video camera, or other analog video source.
	Composite Video 2	Secondary Composite Video In connector (yellow) to connect video input from a VCR, video camera, or other analog source.
	A/V In Audio 1 L	Primary left Audio In connector to connect audio input from a TV set-top box connector (white). NOTE: You can record audio by using this Audio In connector, which is connected to the motherboard. Some computers include this primary left audio input connector on the front of the computer.
	A/V In Audio 1 R	Primary right Audio In connector to connect audio input from a TV set-top box connector (red). NOTE: You can record audio by using this Audio In connector, which is connected to the motherboard. Some computers include this primary right audio input connector on the front of the computer.
	A/V In Audio 2 L	Secondary left Audio In input connector (white). NOTE: This Audio In connector is connected to the TV tuner. To record or listen to audio only, you must use the primary Audio In connector, which is connected to the motherboard and located on the back of the computer.
	A/V In Audio 2 R	Secondary right Audio In input connector (red). NOTE: This Audio In connector is connected to the TV tuner. To record or listen to audio only, you must use the primary Audio In connector, which is connected to the motherboard and located on the back of the computer.

Television output	Icon/label	Description and function
	Analog Video	Analog Video Out connector to connect S-video or composite video connector to a TV.
		

Television input	Icon/label	Description and function
	TV/Cable Ant	TV In connector to connect TV antenna or cable input from wall outlet with no set-top box.
	ATSC	TV In connector for TV cable or antenna, to receive ATSC (Advanced Television System Committee) channels, which are over-the-air digital transmission channels.
	CATV	TV In connector for TV cable or antenna, to receive CATV (Community Antenna Television) channels or cable TV channels.
	NTSC	TV In connector for TV cable or antenna, to receive NTSC (National Television System Committee) channels, which are over-the-air analog transmission channels.

Connecting the TV signal source without a set-top box

To connect the computer into an existing setup for the TV signal source without a set-top box, insert (add) a splitter (**B**) to route the coaxial TV signal cable from the wall outlet (**A**) to the computer connector (**C**).

Callouts

- A** TV signal cable (coaxial) wall outlet (from antenna or cable)
- B** Splitter
- C** Computer coaxial TV In connector
- D** Video recorder
- E** TV

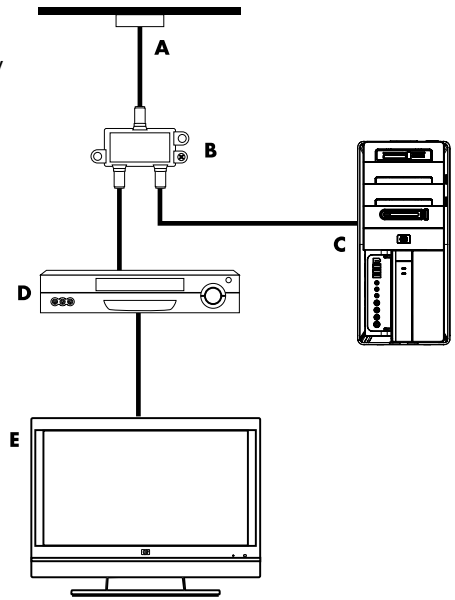

Connecting the TV signal source with a set-top box

To connect the computer into an existing setup for the TV signal source with a set-top box (cable or satellite), insert (add) a splitter (**B**) to route the coaxial TV signal cable from the set-top box (**F**) to the computer connector (**C**).

Connect the remote control cable/IR blaster (select models only) (**G**) to the IR OUT connector on the computer, and then position the blaster on the set-top box. This enables the computer to change the channel on the set-top box. See "Using an infrared receiver (IR) blaster" on page 12 for IR blaster placement details.

Callouts

- A** TV signal cable (coaxial) wall outlet (from antenna or cable)
- B** Splitter
- C** Computer coaxial TV In connector
- D** Video recorder
- E** TV
- F** Set-top box/satellite box
- G** Remote control IR blaster cable (select models only)

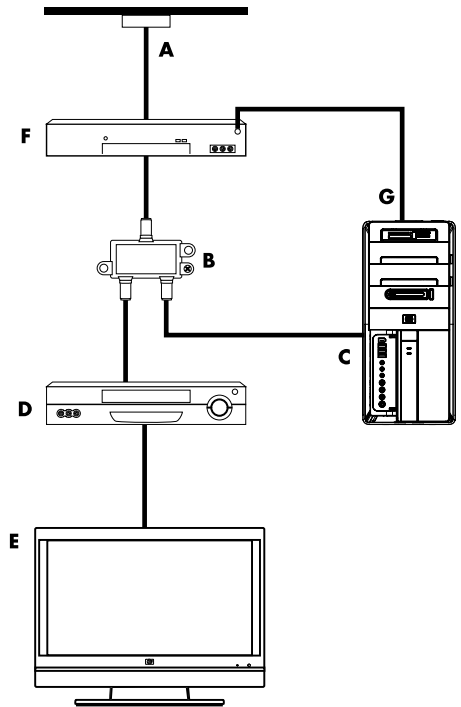

Connecting the TV signal source with a set-top box and using S-video or composite video cable

To use video output from the set-top box (F), add the cables to route video and audio to the computer:

- Do not detach any cables from the existing setup.
- Connect an S-video cable (or you can use an S-video-to-composite cable adapter) to the S-Video In connector (H) on the computer.
- Connect audio cables to the Audio In right (red) and left (white) connectors (J) on the computer.
- Connect the remote control cable/IR blaster (select models only) (G) to the IR OUT connector on the computer, and then position the blaster on the set-top box. This enables the computer to change the channel on the box. See "Using an infrared receiver (IR) blaster" on page 12 for blaster placement details.

Callouts

- A** TV signal cable (coaxial) wall outlet (from antenna or cable)
- B** Splitter
- C** Computer coaxial TV In connector
- D** Video recorder
- E** TV
- F** Set-top box/satellite box
- G** Remote control IR blaster cable (select models only)
- H** Computer S-video In connector
- J** Computer right and left Audio In (analog) connectors

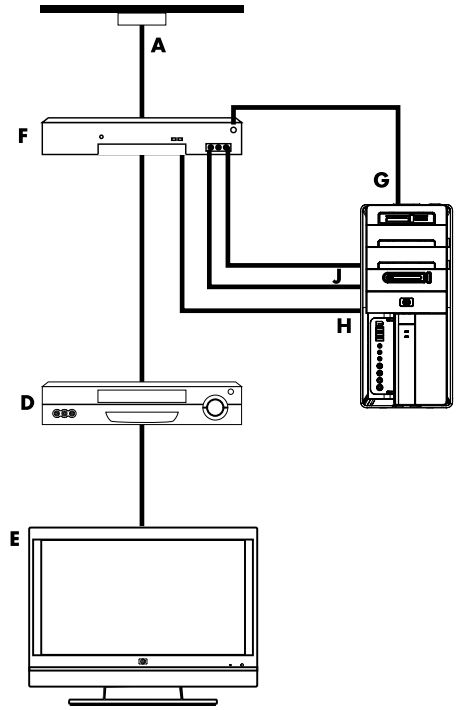

Using an infrared receiver (IR) blaster

(Select models only)

If you have a cable TV or satellite TV set-top box, you can control the set-top box from the computer by using the remote control sensor cable/IR blaster (select models only) and the connector on the computer (not available on all models). Remove the tape (1) on the end of the blaster, adhere it to the IR receiver on the set-top box (2), and connect it to the IR OUT connector (3) on the back of the computer. Point the remote control at the remote control sensor on the front top of the computer.

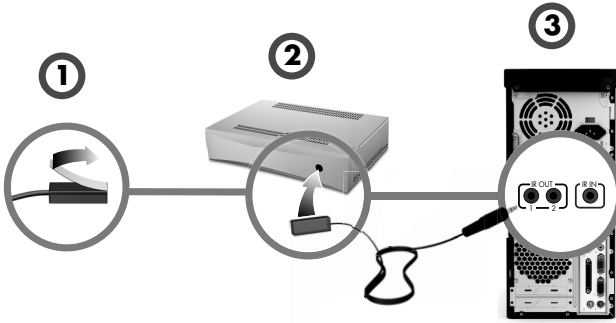

Using an external IR receiver

(Select models only)

If you do not have a direct line of sight to the remote sensor on the front of the computer, you can use an external IR receiver and place the IR receiver in a location that can receive a signal from the remote control.

Connect the external receiver to the red IR IN connector on the back of the computer (1). Place the IR receiver (2) in a location with a direct line of sight to the remote control. Point the remote control (3) at the external IR receiver.

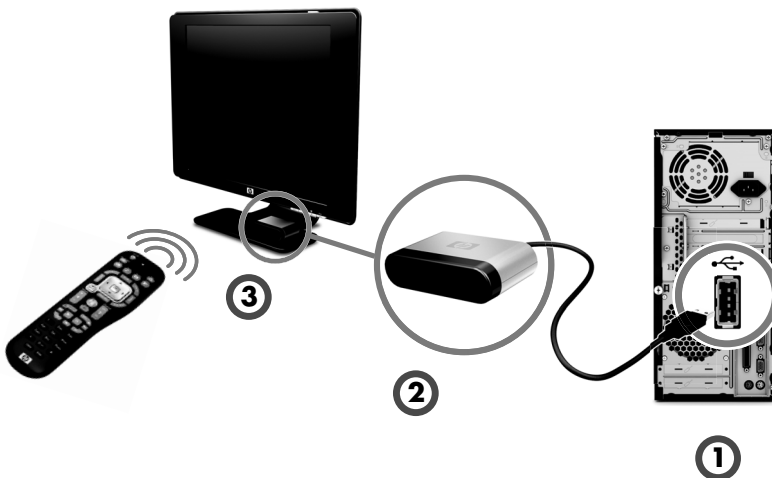

Preparing to Use Your Computer

After you have completed the steps on the setup poster, you are ready to turn on the computer.

NOTE: Do not connect or add other devices to the computer until after you turn on the computer for the first time and complete the initial setup.

To turn on the computer:

- 1 Turn on the monitor.
- 2 Turn on the computer.
- 3 Turn on the external speakers, if they are present.
- 4 Set up the computer and Microsoft® Windows® 7 by following the onscreen instructions:
 - If prompted, select the country/region in which you are physically located, and wait while the computer makes preparations. (When you select an alternate language, it may take up to 30 minutes for this one-time language setup on the computer.)
 - Follow the onscreen instructions to register, sign up for updates, and get online.
- 5 When you see the Windows 7 desktop, the initial setup is complete.

For help with getting started using your computer, see the remaining topics in this section.

NOTE: If you skip some steps during the initial setup procedure or decline some options, you will be reminded to complete the setup at a later time.

Turning Off the Computer

For best results when using Windows 7, do not shut down the computer except when you must turn off the power for safety reasons: to make repairs, to install new hardware or cards in the computer, or to change a battery.

As an alternative to shutting down the computer, you can lock it or put it into either Sleep or Hibernate mode, if it is available. You can set the power management timers to put the computer automatically into Sleep or Hibernate mode.

The computer has these reduced power states:

- **Sleep** mode saves your work to memory, so you can resume quickly. It saves memory to the hard disk drive, and then goes into a reduced-power state. During Sleep mode, the computer hardware light remains on, and the computer is ready to wake quickly and resume your work where you left off. If it is present, simply press the Sleep button on the keyboard to enter sleep mode.
- **Hibernate** mode (available as an advanced power setting) saves the system memory to a temporary file on the hard disk and then turns off the hardware. When you turn on the computer again, the programs, folders, and documents that you had open are restored to the screen.



Restarting the Computer

When you restart the computer, the computer clears some settings and starts over using the operating system and software in its memory. Restarting is the easiest and most effective way to solve many software issues for the computer.

Also, you may want to install additional software programs or hardware devices onto the computer, and doing so may require that you restart the computer after installation.

To restart the computer:

- 1 Click the **Start** button.
- 2 Click the **Arrow** button next to Shut Down.
- 3 Click **Restart**.

Or

Quickly press the On button on the front of the computer.

Connecting to the Internet

Connecting to the Internet requires that you:

- 1 Purchase high-speed Internet service from an Internet service provider (ISP).
- 2 Purchase a broadband modem (DSL or cable). This may be provided by the ISP.
- 3 Purchase and install a wireless router (sold separately), if one is required.

The computer can connect to the Internet through a local area network (LAN) or digital subscriber line (DSL). Check with your Internet Service Provider (ISP) for specific information on the connection.

- 1 Refer to “Setting Up Your Computer” on page 1 to make the hardware connections. You need:
 - For a network connection, see “Connecting to a Network” on page 6. To check a wireless LAN device installation, see “Internet access” on page 37.
 - For a modem, see “Connecting a Modem” on page 7.
- 2 To connect to the Internet:
 - Sign up with an ISP. If you already have an account with an ISP, skip this step and follow the instructions provided by the ISP.
 - If you did not set up the computer for Internet service during the initial setup, do so now by using Online Services:
 - a Click the **Start** button.
 - b Click **All Programs**.
 - c Click **Online Services**, and then click **Get Online**.
 - d Follow the onscreen instructions to select an ISP and set up Internet service.

NOTE: Online Services provides a list of ISPs; however, you may choose another ISP or transfer an existing account to this computer. To transfer existing accounts, follow the instructions provided by the ISP.

- 3 Connect to the Internet. You must connect through your ISP.
 - For dial-up only, double-click the ISP-provided icon on the desktop, and then log in.
- 4 Open your Web browser and browse the Internet.

You can use any Web browser; most computers have Microsoft Internet Explorer®. To open Internet Explorer:

 - a Click the **Start** button.
 - b Click **All Programs**, and then click **Internet Explorer**.

NOTE: If you have issues connecting to the Internet, see “Internet access” on page 37.

Using wireless security features

When you set up a home WLAN or access an existing public WLAN, always enable security features to protect the network from unauthorized access. The most common security levels are Wi-Fi Protected Access Personal (WPA-Personal) and Wired Equivalent Privacy (WEP).

When setting up a network, use one or more of the following security measures:

- Enable WPA-Personal or WEP security encryption on the router.
- Change the default network name (SSID) and password.
- Set up a firewall.
- Set security on your Web browser.

Adjusting the Speaker Volume

There are several ways to adjust volume. Use the Volume icon on the Windows 7 taskbar to set speaker volume. Then, you can adjust the volume by using:

- The Volume knob or buttons on the keyboard (select models only).
- The Volume knob on the speakers (select models only).

To set speaker volume, use the Volume icon on the taskbar:

- 1 Right-click the **Volume** icon on the taskbar, and then click **Open Volume Mixer**.

The Volume Mixer settings window opens.

- 2 Adjust the volume by clicking the slider bar and moving it.
- 3 When you are satisfied with the sound level, close the window by clicking the **X** in the upper-right corner.

For help with audio, check the troubleshooting items in “Audio and speakers” on page 36. For more information, open the Help and Support Center or refer to the Support Web site; see “Getting More Information” on page 25.



Selecting the Microphone

The microphone connector on your computer is ready to use. If you have more than one microphone connected, select the microphone that you would like to use in Windows 7.

NOTE: When you have a webcam or an audio player connected to the computer, because of the audio input from the device, Windows 7 may recognize each as a microphone input.

To select the microphone that you would like to use in Windows 7:

- 1 Right-click the **Volume** icon on the taskbar, and then click **Recording Devices**. The Sound window opens.
- 2 Select the Microphone that you want to use, click **Set Default**, and then click **Apply**.
- 3 Click **OK**.



Adjusting microphone recording level in Windows 7

To adjust the recording level of the microphone:

- 1 Right-click the **Volume** icon on the taskbar, and then click **Recording Devices**. The Sound window opens.
- 2 Double-click the microphone connector that you want to use.
- 3 Click the **Levels** tab.
- 4 Adjust the recording level for the microphone by clicking the slider bar and moving it.
- 5 Click **OK**, and then click **OK** again.



Protecting Your Computer

Protect your computer, personal settings, and data from a variety of risks by using:

- Passwords.
- Antivirus software.
- Firewall software.
- Critical security updates.

NOTE: Security solutions are designed to act as deterrents, but they may not be able to prevent software attacks or to prevent the computer from being mishandled or stolen.

Computer risk	Computer feature
Unauthorized use of the computer or user account	User password
Computer viruses	Antivirus program
Unauthorized access to data	Firewall program Windows 7 updates
Unauthorized access to Setup Utility, BIOS settings, and other system identification information	Administrator password
Ongoing or future threats to the computer	Windows 7 critical security updates from Microsoft

Using passwords

A *password* is a group of characters that you choose to secure the computer information. Several types of passwords can be set, depending on how you want to control access to your information. Passwords can be set in the Windows 7 operating system on the computer.



CAUTION: To avoid being locked out of the computer, record each password you set. Because passwords are not displayed as they are set, changed, or deleted, it is essential to record each password immediately and store it in a secure place. Do not store passwords in a file on the computer.

You can use the same password for more than one Windows 7 security feature. A password set in Windows 7 must be entered at a Windows 7 prompt.

For information on Windows 7 passwords: Click the **Start** button, click **Help and Support**, and then type *passwords* into the Search Help box and press Enter. See “Using the Help and Support Center” on page 25.

Using antivirus software

When you use the computer for e-mail, network, or Internet access, you expose it to computer viruses. Computer viruses can disable or damage the operating system, software programs, or computer utilities.

Antivirus software can detect most viruses, remove them, and, in most cases, repair any damage that they have caused. To provide ongoing protection against newly discovered viruses, you must keep the antivirus software up to date.

The antivirus program, which is preinstalled on the computer, includes antivirus and firewall components. The software includes a free trial subscription of protection updates. To protect the computer against new viruses beyond the trial period, purchase an extended update service. Instructions for using and updating the antivirus software, and for purchasing extended update service, are provided within the program.

For more information about computer viruses: Click the **Start** button, click **Help and Support**, and then type *viruses* into the Search Help box and press Enter. See “Using the Help and Support Center” on page 25.

Using firewall software

When you use the computer for e-mail, network, or Internet access, unauthorized persons may be able to gain access to information about you, your computer, and your data. To protect your privacy, use firewall software:

- Windows 7 includes firewall software preinstalled on the computer.
- The antivirus program, which is preinstalled on the computer, includes a firewall program.

Firewall features include logging, reporting, and automatic alarms to monitor all incoming and outgoing communications.

Under some circumstances, a firewall can block access to Internet games, interfere with printer or file sharing on a network, or block authorized e-mail attachments. To solve the problem temporarily, disable the firewall, perform the task that you want to perform, and then enable the firewall again. To resolve the problem permanently, reconfigure the firewall.

Configuring the Computer for Automatic Microsoft Software Updates

Microsoft continually updates the Windows 7 operating system. Run Windows 7 Update monthly to install these updates, or keep the operating system up to date by using the Automatic Updates feature.

When you are connected to the Internet, Windows 7 Update automatically notifies you (through a pop-up message or icon in the notification area) when critical updates are available. When you see the Windows 7 Update message, allow the updates to download to your system. If you update the system weekly, or even monthly, the time required for download is minimal.

Installing critical security updates



CAUTION: To reduce the risk of information damage or loss from security breaches and computer viruses, install all critical updates from Microsoft as soon as you receive an alert.

Additional updates to the operating system and other software may have become available after the computer was shipped. Download all available updates and install them onto the computer.

Setting Up User Accounts

When you share a computer with several people, you can set up a user account for each computer user. Windows 7 uses the information in the user account to determine what files and folders the computer user can access, when they can make changes to the computer, and their personal preferences. Each person can access only their own files and settings.

For more information, click the **Start** button, click **Help and Support**, and then type *User Accounts* into the Search Help box and press Enter. See “Using the Help and Support Center” on page 25.

Guidelines for Installing Software and Hardware Devices

After you set up the computer and complete the initial setup, you may want to install additional software programs or hardware devices. Keep in mind the following important guidelines:

- Before installation, make a restore point by using the Microsoft System Restore program. The *restore point* is a snapshot of the computer settings. By using System Restore, you ensure that you have a stable set of settings to use.
- Choose software that is compatible with the computer; check the operating system, memory, and other requirements listed for the new software.
- Install the new software according to the directions provided by the software manufacturer. If you need help, check the manufacturer documentation or customer service information.
- For antivirus software, uninstall the existing software program before reinstalling it or installing a new antivirus program.

NOTE: Use only licensed original software. Installing copied software may be illegal, or may result in an unstable installation, or it may infect the computer with a virus.

Transferring Files and Settings from an Old Computer to Your New Computer

You can copy files from the old computer to your new computer by using CDs or DVDs, memory sticks, or personal media drives, or by using the Windows Easy Transfer cable. To transfer files and copy certain settings, such as Web browser Favorites and address books, use Windows Easy Transfer software, which is included with Windows 7.

Windows Easy Transfer software guides you to copy files and settings to a storage device or, using an Easy Transfer Cable, to the new computer. The Easy Transfer Cable is a USB cable designed specifically to connect two computers and to work with the Windows Easy Transfer software. (The cable is sold separately.) A standard USB cable does not work.

To transfer your files and settings:

- 1 Click the **Start** button.
- 2 Type *Windows Easy Transfer* into the Start Search box, and then click **Windows Easy Transfer**.
- 3 Follow the onscreen instructions in the Windows Easy Transfer Wizard to transfer your files from an old computer to your new one.

For more information, click the **Start** button, click **Help and Support**, and then type *moving files* into the Search Help box and press Enter. See “Using the Help and Support Center” on page 25.

Special Features of Your Computer

Using the Memory Card Reader

(Select models only)

Your computer may come with a multi-format memory card reader (optional, select models only). Digital cameras and other digital imaging devices use memory cards, or *media*, to store digital picture files. The memory card reader can read from and write to a variety of types of memory cards and the IBM Microdrive disk drive.

- The card reader is accessible directly on the front of the computer. It has two or four horizontal card slots which accept the media.
- You can place media in one or more of the card slots and use each media independently. Place only one piece of media in a slot at one time.
- Each card slot has its own drive letter and icon. When you insert media, the display label may change to the title of the media, if a title is available.
- When you insert media, the Safely Remove Hardware window may appear. If it opens, or if you open the Safely Remove Hardware window by mistake, click **Close**.



CAUTION: Do not click *Stop* in the Safely Remove Hardware window with the USB Mass Storage Device selected. Doing so removes the operating system recognition of the memory card reader from your computer, and you must restart the computer to see the memory card reader again.

Memory card reader

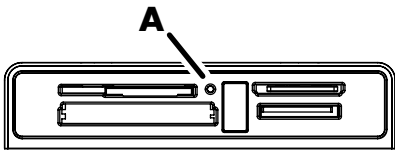

The activity light (**A**) blinks to indicate that the computer is accessing the memory card to read or write.

To use the memory card reader:

- 1 Insert the media into the card slot until it stops.

The activity light (**A**) on the memory card reader lights, and the computer automatically detects the media.

NOTE: You must insert media correctly. Note the direction of the notched corner on the media. For more information, open the Help and Support Center or refer to the Support Web site; see “Getting More Information” on page 25.

Also:

- CompactFlash and Microdrive media are keyed and cannot be inserted incorrectly. Insert the receptacle edge (holes) of this media into the slot.
 - Some memory cards, such as CF Ultra/III, are not compatible with the memory card reader that came with your computer.
 - Do not use SM and xD media in the memory card reader at the same time. The reader recognizes only the first one that is inserted.
-

- 2 Select a program to access your files. You can copy files from or to the media.

Or

If the AutoPlay window does not open, click the **Start** button, click **Computer**, and then double-click the **Memory Card** icon to display the files on the media. You can copy files from or to the media.

- 3 When you are finished, right-click the drive icon, click **Eject**, check that the memory card reader activity light is on or off, but not blinking, and then remove the media.
-



CAUTION: Do not try to remove media when the activity light is blinking. Doing so may cause loss of data.

Using a Vertical CD/DVD Drive

(Select models only)

Your computer may have an optical disc drive that is installed in a vertical position. Press the Eject button on or near the drive door (**A**) to eject the CD/DVD tray. Place a standard-sized disc in the tray with the label facing out, and then press the front of the tray to close it.

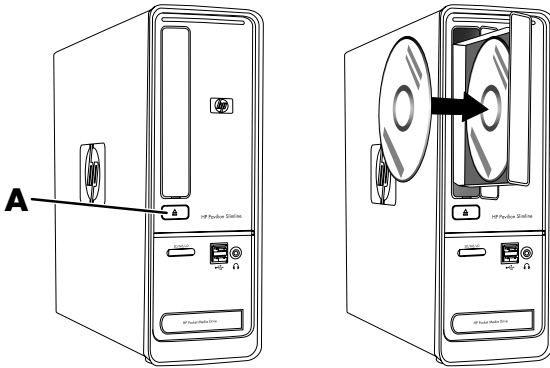

Using LightScribe Technology

(Select models only)

What is LightScribe?

LightScribe is an innovative technology that uses a special disc drive, special media (LightScribe-writable CDs or DVDs), and label-making software to burn labels directly onto the disc. A LightScribe-enabled CD or DVD drive uses the optical laser in the drive to burn a label onto a thin dye coating on the label side of the disc. There is no ink to smear or paper to curl, and there are no adhesives to loosen.

LightScribe requirements

Burning a label with LightScribe requires three things:

- A LightScribe-enabled optical disc drive (select models only), identified by the LightScribe logo
- Labeling software that supports LightScribe
- A writable LightScribe disc (sold separately)



Making a LightScribe label by using CyberLink LabelPrint

You may burn data, music, and videos to the disc before or after labeling it.

For more information about making a LightScribe label:

- 1 Click the **Start** button, and then click **Help and Support**.
- 2 Type *Lightscribe* in the Search Help box, and then press Enter.

Using the Remote Control

(Select models only)

NOTE: Only use alkaline batteries in the remote control.

With your remote control, you can open Windows Media Center to view television broadcasts, to record and play TV programs, and to play music, movies, or video.

To open Windows Media Center, point the remote control at the remote control sensor on the top front of the computer, and press the Windows Media Center Start button on the remote control.



Or



To use the remote control, point it in a direct line of sight at the remote sensor. The remote control and the sensor can be no farther than 8 meters apart. The remote control can be no more than 22.5 degrees (45 degrees total) from the center of the remote sensor.

NOTE: Bright, direct light aimed toward the sensor might interfere with the remote control operation.

Getting More Information

Using the Help and Support Center

(Select models only)

Information about your computer is in the Help and Support Center. Here, you can find links to driver updates, access to technical support options, and information about commonly asked questions.

To open the Help and Support Center:

- Press the Help button (select models only) on your keyboard.

Or

- Click the **Start** button, and then click **Help and Support**.

Accessing Support on the Web

You can find information for your computer by using the Internet to access the Support Web site address listed in the *Limited Warranty and Support Guide*, or use the following steps:

- 1 Go to **<http://www.hp.com/support>** in your Web browser.
- 2 Select your country/region and language.
- 3 Click **Support and Drivers**.
- 4 Enter the model number of your computer, and then click **Search** . Click an item to view it.

Finding Guides on the Web

You can find guides for your computer by using the Internet to access the Support Web site:

- 1 Go to the Support Web site and search for your model number using the previous procedure.
- 2 Click **Manuals**.
- 3 Locate the manual you want, and then do one of the following:
 - Click the title to display the file in Adobe® Acrobat® Reader (which you can download from the Manuals page if it is not currently installed on your computer).

Or

- Right-click the title, click **Save Target As**, specify a location on the computer where you want to save the file, rename the file (retaining the .pdf extension), and then click **Save**.

Finding Onscreen Guides

(Select models only)

You can find onscreen guides for your computer in the User Guides folder.

- 1 Click the **Start** button.
- 2 Click **All Programs**.
- 3 Click **User Guides**.
Click an item to view or use it.

NOTE: If there are no guide titles listed in the folder, your computer has no onscreen guides.

Using the PC Help & Tools Folder

The PC Help & Tools folder contains special utilities for computer owners, such as support information and programs.

To see the items in the PC Help & Tools folder:

- 1 Click the **Start** button.
- 2 Click **All Programs**.
- 3 Click **PC Help & Tools**.

Using HP Advisor Software

(Select models only)

HP Advisor is a desktop tool you use to monitor and access system health information about key areas of your computer. HP Advisor has four major areas:

- **PC Dock** — Access HP and Partner software directly on your desktop and customize your dock by dragging and dropping items.
- **PC Dashboard** — Check your computer status at a glance with the PC Dashboard. Access all the items you need to run your computer from HP and Partners.
- **PC Discovery** — Explore HP and Partner software and online services that are installed on your computer, and find offers for exciting new software and services.

To open the HP Advisor Dock, click the **HP** logo on the taskbar.

Using the Computer with Safety and Comfort



WARNING: To reduce the risk of serious injury, read the *Safety & Comfort Guide*. It describes proper workstation setup, posture, and health and work habits for computer users. It also provides important electrical and mechanical safety information.

Before you begin using the computer, arrange the computer and your work area to maintain your comfort and productivity. Refer to the *Safety & Comfort Guide* for important ergonomic information:

- Click the **Start** button, click **All Programs**, click **User Guides**, and then click **Safety & Comfort Guide**.

Or

- Type
<http://www.hp.com/ergo>
into the Web browser address box, and then press Enter on the keyboard.

Troubleshooting and Maintenance

This section contains:

- Troubleshooting tables in “Troubleshooting Computer Problems” below.
- Software repair information in “Software Troubleshooting” on page 45.
- Maintenance information and guidelines in “Maintenance” on page 48.

For more information, refer to the Help and Support Center or access the Support Web site; see “Getting More Information” on page 25.

Refer to the documentation provided by the product manufacturer for information about peripheral-specific problems, such as issues with a monitor or a printer.

Troubleshooting Computer Problems

The following tables present some symptoms of issues you may encounter while installing, starting up, or using your computer. The tables also provide possible solutions you can try.

The troubleshooting tables appear in the following order:

- “Computer does not start” on page 30
- “Power” on page 31
- “Display (monitor)” on page 31
- “Keyboard and mouse (with cable)” on page 32
- “Wireless keyboard and mouse” on page 33
- “Audio and speakers” on page 36
- “Internet access” on page 37
- “CD and DVD drives” on page 38
- “Video” on page 40
- “Hardware installation” on page 41
- “Performance” on page 42
- “Wireless devices” on page 43
- “Remote control” on page 44
- “Memory card reader” on page 44

Computer does not start

Symptom	Possible solution
Computer will not turn on or start.	<p>Ensure that the cables connecting the computer to the external power source are plugged in properly.</p> <p>When the cables connecting the computer to the external power source are plugged in properly, and the wall outlet is functioning, the green power supply light on the back of the computer should be on; if it is not, refer to the <i>Limited Warranty and Support Guide</i> to contact Support.</p> <hr/> <p>If the display (monitor) is blank, the monitor may not be properly connected. Connect the monitor to the computer, plug it in, and turn it on. See "Display (monitor)" on page 31.</p> <hr/> <p>Set the line voltage selection switch to the correct setting for your country/region, or refer to the <i>Limited Warranty and Support Guide</i> to contact Support.</p> <hr/> <p>Test the wall outlet by connecting a different electrical device to it.</p> <hr/>
Computer seems to be locked up and is not responding.	<p>Use the Windows Task Manager to close any programs not responding, or restart the computer:</p> <ol style="list-style-type: none">1 Press the Ctrl, Alt, and Delete keys on the keyboard simultaneously.2 Click Start Task Manager.3 Select the program that is not responding, and then click End Task. <p>If closing programs does not work, restart the computer:</p> <ol style="list-style-type: none">1 Press the Ctrl, Alt, and Delete keys on the keyboard simultaneously.2 Click the Arrow button next to the red Shut Down button, and then click Restart. <p>Or</p> <ol style="list-style-type: none">1 Press and hold the On button for 5 or more seconds to turn off the computer.2 Press the On button to start the computer. <hr/>
Error message: <i>Hard disk drive error</i> .	Refer to the <i>Limited Warranty and Support Guide</i> to contact Support.

Power

Symptom	Possible solution
Error message: <i>Invalid system disk</i> or <i>Non-System disk</i> or <i>Disk error</i> .	When drive activity stops, remove the disk and press the spacebar on the keyboard. The computer should start up.
Computer does not turn off when the On button is pressed.	Press and hold the On button until the computer turns off. Check Power Settings.
Computer shuts down automatically.	The computer may be in an exceedingly hot environment. Let it cool down. Ensure computer air vents are not blocked and internal fan is running. Note that your computer may not have an internal fan. See "Cleaning the computer vents" on page 50.

Display (monitor)

Symptom	Possible solution (In addition to the information listed here, also refer to the documentation that came with your monitor.)
Screen is blank, and monitor power light is not lit.	Reconnect the power plug to the back of the monitor and to the wall outlet. Press the On button on the front of the monitor.
Screen is blank.	Press the space bar on the keyboard or move the mouse to make the screen display visible again. Press the Sleep button (select models only), or the Esc key on the keyboard, to resume from Sleep mode. Press the On button to turn on the computer. Inspect the monitor video connector for bent pins: <ul style="list-style-type: none">■ If any of the pins are bent, replace the monitor connector cable.■ If no pins are bent, reconnect the monitor connector cable to the computer.
Images on the screen are too large or too small, or the images are fuzzy.	Adjust the monitor resolution setting in Windows 7: <ol style="list-style-type: none">1 Click the Start button, and then click Control Panel.2 Under Appearance and Personalization, click Adjust Screen Resolution.3 Adjust resolution as necessary, and then click Apply.

Keyboard and mouse (with cable)

Symptom	Possible solution
Keyboard commands and typing are not recognized by the computer.	Turn off the computer by using the mouse, unplug and reconnect the keyboard to the back of your computer, and then turn on your computer.
Mouse (with cable) does not work or is not detected.	Unplug and reconnect the mouse cable to your computer. If the mouse is still not detected, turn off the computer, unplug and reconnect the mouse cable, and then restart the computer.
Cursor does not respond to mouse movement.	Restart your computer by using the keyboard: <ol style="list-style-type: none">1 Press the Alt and Tab keys on the keyboard simultaneously to navigate to an open program.2 Press the Ctrl and S keys on the keyboard simultaneously to save your changes in the selected program (Ctrl+S is the keyboard shortcut for Save on most—<i>not all</i>—programs).3 Repeat step 1 and step 2 to save changes in all open programs.4 After saving changes in all open programs, press the Ctrl and Esc keys on the keyboard simultaneously to display the Windows Start Menu.5 Use the arrow keys to select the Arrow button next to Shut Down. Select Shut Down, and then press the Enter key on the keyboard.6 After the shutdown is complete, unplug and reconnect the mouse connector to the back of your computer, and then turn on your computer.

Keyboard and mouse (with cable) (continued)

Symptom	Possible solution
Cursor responds slowly, moves only vertically or horizontally, or does not track smoothly.	<p>For a mouse with a roller ball:</p> <ul style="list-style-type: none">■ Clean the roller ball: Remove the roller ball cover from bottom of mouse (rotate it counterclockwise), remove the ball, and clean it with a damp, lint-free cloth (not paper). Also clean the rollers on which the ball moves.■ Use a mouse pad or other rough surface under the mouse. <p>For an optical mouse:</p> <ul style="list-style-type: none">■ Clean the optical mouse: Gently wipe the light sensor lens on the bottom of the mouse with a lint-free cloth (not paper).■ Use a mouse pad, white sheet of paper, or other less reflective surface under the mouse. <p>For detailed cleaning instructions, go to: http://www.hp.com/support</p> <p>Select your country/region and language, search on your computer model number, and then search on the keyword <i>cleaning</i>.</p>

I cannot move the cursor using the arrow keys on the number key pad.

Press the Num Lock key on the keyboard to turn off the Num Lock light. The Num Lock light should not be on if you want to use the arrow keys on the number key pad.

Wireless keyboard and mouse

Symptom	Possible solution
Wireless keyboard or mouse does not work or is not detected.	<p>Check for these problems:</p> <ul style="list-style-type: none">■ Ensure you are using the wireless keyboard or wireless mouse within range of the receiver, approximately 10 meters for normal use, and within 30 cm during initial setup or for resynchronization.■ Replace the batteries in the keyboard and mouse: Turn the devices over, turn the mouse off, take off the battery cover, remove the old batteries, insert new alkaline batteries, replace the battery cover, and then turn on the mouse. <p>NOTE: Do not use rechargeable batteries.</p> <ul style="list-style-type: none">■ Ensure the mouse is not in Suspend mode, which occurs after 20 minutes of inactivity. Click the left mouse button to reactivate it.

Wireless keyboard and mouse (continued)

Symptom

Wireless keyboard or mouse does not work or is not detected.
(continued)

Possible solution

Resynchronize the keyboard and mouse to the receiver:

The receiver, wireless keyboard, and wireless mouse shown in the illustrations are examples; your models may vary.

IMPORTANT: During these steps, place the wireless keyboard and wireless mouse on the same level as the receiver, within 30 cm of the receiver, and away from interference from other devices.

- 1 Unplug the receiver from a USB connector on the computer, and then reconnect it. Your computer model may have a connector dedicated to the receiver. If you have a choice, use a USB connector on the front of the computer.
- 2 The receiver may have an LED light or a Connect button, which is also an LED light. Skip this step if your receiver has no Connect button **(A)**.

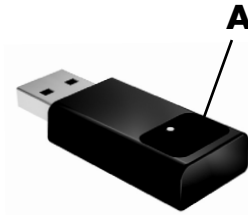

Push the Connect button **(A)** on the receiver (which is also the LED light), and hold it for 5 to 10 seconds until the light starts to flash.

Wireless keyboard and mouse (continued)

Symptom

Wireless keyboard or mouse does not work or is not detected.
(continued)

Possible solution

- 3 Check that the mouse is on **(B)**, and push and hold the Connect button **(C)** on the underside of the mouse for 5 to 10 seconds until the LED **(A)** on the receiver lights or stops flashing.



NOTE: The receiver connection session times out after 60 seconds. To ensure the connection was established, and that the receiver did not time out instead, move the mouse and check for response on the screen.

- 4 After the mouse connection is established, continue with the steps that follow to repeat the procedure for the keyboard.
- 5 Skip this step if your receiver model has no Connect button **(A)**.
Push the Connect button on the receiver **(A)**, and hold it for 5 to 10 seconds until the light starts to flash.
- 6 Push and hold the Connect button **(D)** on the underside of the keyboard for 5 to 10 seconds until the LED **(A)** on the receiver lights or stops flashing.



Audio and speakers

Symptom

Possible solution

No sound is produced.

If you use an HDMI connector on the graphics card (select models only) to connect your display (monitor) to the computer, you should also connect analog speakers to the computer Audio Line Out connector if you want to hear sound during the initial setup of the computer.

Refer to the setup poster to connect analog speakers.

Press the Mute button on the keyboard to see whether the Mute feature is enabled.

Or

- 1 Right-click the **Volume** icon on the taskbar, and then click **Open Volume Mixer**.



The Volume Mixer settings window opens.

- 2 If programs are muted, click the **Mute** button to unmute.

If you are using built-in monitor speakers, use the monitor front panel Volume button to adjust volume. Use the front panel buttons to enter the onscreen display (OSD) and ensure audio is enabled and volume is set appropriately.

To increase the volume, click the **Volume** icon on the task bar, or use the keyboard controls. Check the volume setting in your software program.

Ensure that you connected powered (active) speakers and that they are turned on.

Turn off your computer, and then unplug and reconnect the speakers. Ensure the speakers are connected to an audio connector, not a Line In or headphone connector.

To resume from Sleep mode, press the Sleep button (select models only), or press the Esc key on the keyboard.

Unplug headphones if they are connected to your computer (or speaker system).

Volume is very low or unsatisfactory.

Ensure that you connected the speakers to the Audio Out (lime green) connector on the back of the computer. (Additional audio connectors are used for multiple-channel speakers.)

Detached non-powered speakers (speakers without a separate power source, such as batteries or a power cord) do not produce satisfactory sound. Replace the non-powered speakers with powered speakers.

Internet access

Symptom

I cannot connect to the Internet.

Possible solution

Contact your ISP for assistance.

Verify that you are using the proper cables for your Internet connection type. Your computer may have a dial-up modem and an Ethernet network adapter (also called a network interface card, or NIC). A modem uses a standard telephone cable while the network adapter uses a network cable to connect to a local area network (LAN). Do not connect a telephone cable to the network adapter, and do not plug a network cable into a telephone service line; doing so may damage the network adapter.

For more information about connecting to the Internet, open the Help and Support Center; see "Using the Help and Support Center" on page 25.

Run the wireless setup wizard:

- 1 Click the **Start** button, and then click **Control Panel**.
- 2 Click **Network and Internet**, and then click **Network and Sharing Center**.
- 3 In the Network and Sharing Center window, click **Set up a connection or network** to open the wizard.
- 4 Follow the onscreen instructions.

Use Device Manager to verify that the integrated WLAN device is installed on the computer correctly:

- 1 Click the **Start** button.
- 2 Type *Device Manager* into the Start Search box, and then click **Device Manager**.
- 3 Click **Network adapters**. Your WLAN device should be listed here. The WLAN device may include the term *wireless*, *wireless LAN*, or *802.11*.
- 4 Click the **Start** button.
- 5 Type *Network and Sharing Center* into the Start Search box, and then click **Network and Sharing Center** to open the Network and Sharing Center window.
- 6 Click **Connect to a network**, and then follow the onscreen instructions.

If your system has an external antenna, try to move the antenna to a better position. If the antenna is internal, try to move the computer.

Try to connect again later, or contact your ISP for assistance.

Internet access (continued)

Symptom

Internet programs do not start automatically.

Possible solution

Log in to your ISP, and start the desired program.

CD and DVD drives

Symptom

The CD or DVD drive cannot read a disc, or it takes too long to start.

Possible solution

Ensure the disc is inserted with the label facing out and centered in the tray.

Wait at least 30 seconds for the drive to determine the type of media.

Clean the disc with a disc cleaning kit, available from most computer stores.

The driver may be corrupted or outdated. For detailed information about restoring and updating drivers, see "Updating drivers" on page 45.

I cannot remove a CD or DVD.

Turn on your computer, and press the Eject button nearest the drive to open the tray.

If you suspect a problem with the Eject button itself:

- 1 Click the **Start** button, and then click **Computer**.
 - 2 Right-click the CD or DVD drive you want to open.
 - 3 Select **Eject** from the menu.
-

My minidisc CD is falling down inside the computer.

Vertical and slot-loading disc players cannot play non-standard discs.

For a CD/DVD drive with a tray that is installed in a vertical position, standard-sized discs fit into the drive tray vertically, with the label facing out. To use a minidisc with a vertical drive tray, you must first place the computer on its right side (select models only) before you insert the minidisc:

- 1 Face the front of the computer and lay the computer down on its right side.
 - 2 Press the Eject button to open the CD/DVD tray.
 - 3 Place the minidisc into the recess inside the tray, and then press the front of the tray to close it.
-

CD and DVD drives (continued)

Symptom

Possible solution

I cannot create (record) a disc.

Ensure the disc is inserted with the label facing out and centered in the tray.

Verify that you are using the correct disc type (media) for the drive. Try a different brand of disc.

Ensure the disc is clean and undamaged. If recording stopped during a recording session, the disc may be damaged; use a different disc.

Use the correct type of disc for the type of files you are recording.

When using a CD-R disc, ensure it is blank if recording music, and that it is blank or appendable (with space to add more data files) if recording data.

Verify that you are using the correct disc type when you make a copy of a disc. Some recording programs can record only to the same disc type as the source. For example, you can record a DVD only to a DVD+R/-R or a DVD+RW/-RW disc, and you can record a CD only to a CD-R or a CD-RW disc.

Ensure that the disc is in the correct drive, and that you specify the same drive in the CD or DVD recording software.

Select a slower write speed for the recording drive, if a slower speed is available.

The recording software may not let you add a track if it exceeds the available space on your disc. You can make space available by removing one or more tracks from the list before recording the files to the disc.

Close all software programs and windows before recording.

Ensure you have enough available space on your hard disk drive to store a temporary copy of the content.

Click the **Start** button, and then click **Computer**. Right-click the hard disk drive, and then click **Properties** to view the available space.

CD and DVD drives (continued)

Symptom	Possible solution
I cannot create (record) a disc. (continued)	If you are on a network, copy the files from a network drive to your hard disk drive first, and then record them to disc. <hr/> Close all programs and windows, and then restart your computer.
I cannot play a DVD movie on a DVD player.	Your DVD player cannot play video files that were recorded onto the DVD as data files. To play a movie properly, use a video recording program. Some video files may be viewed on a computer, but not on a home DVD video player.

Video

Symptom	Possible solution
Some video files do not play.	Your file may be corrupt or in an unsupported format. Open the video file in a video editor, and then resave the file in a supported format.
Codec error messages appear when I try to play certain video files.	Open the file in Windows Media Player. Ensure Windows Media Player is configured to automatically download codecs. <ul style="list-style-type: none">■ If the correct codec is available, the file will play. Note that you must be connected to the Internet to download the codec file.■ If the correct codec is not available, check to see whether there is an update available for Windows Media Player. For more information, open Windows Media Player Help and search for <i>codec</i> .
Error message: <i>Files Needed To Display Video Are Missing or Corrupt.</i>	<ol style="list-style-type: none">1 Click the Start button.2 Type Device Manager into the Start Search box, and then click Device Manager to open the Device Manager window.3 Click the plus sign (+) next to Sound, video and game controllers.4 Right-click TV tuner (select models only), and then click Update Driver Software.5 Select Search automatically for updated driver software.6 Follow the instructions to update the driver.7 If you are prompted, restart the computer.

Hardware installation

Symptom

Possible solution

A new device is not recognized as part of the system.

Install the device driver from the CD provided with the device, or download and install the driver from the device manufacturer Web site.

You may need an updated driver for Windows 7. Contact the device vendor directly for an update.

For Hewlett-Packard peripheral devices, visit the HP Web site at [**http://www.hp.com/support**](http://www.hp.com/support)

Ensure that all cables are properly and securely connected and that the pins in the cable or connector are not bent.

Turn off the computer, turn on the external device, and then turn on the computer to integrate the device with the computer.

Restart the computer, and follow the instructions for accepting the changes.

Disable the automatic settings in the operating system for the new device, and choose a basic configuration that does not cause a resource conflict.

You can also reconfigure or disable devices to resolve the resource conflict.

A new device does not work.

To install or uninstall a device driver, you must be logged in with administrative privileges. If you need to switch users, click the **Start** button, click the **Arrow** button next to Shut Down, and then click **Switch User**. Choose a user with administrative privileges.

Hardware installation (continued)

Symptom	Possible solution
A device does not work after installing a new device.	<p>To resolve a device conflict, you may need to disable one of the devices or uninstall an old device driver:</p> <ol style="list-style-type: none">1 Click the Start button.2 Type <i>Device Manager</i> into the Start Search box, and then click Device Manager to open the Device Manager window.3 Click the plus sign (+) next to the problem device and check for an exclamation point in a yellow circle near the device icon. The exclamation point means there is a device conflict or problem with the device. Exclamation points do not always appear when a device is not working properly.4 If you have removed a hardware device, but the device driver is still listed in the Device Manager, this may be causing the device conflict. To uninstall the old driver so that the new device driver works properly, right-click the device, click Uninstall, and then click OK.5 Right-click the name of the device, and then select Properties.6 Click the General tab to see whether your device is enabled and working properly. If it is available, click the Troubleshoot button, and follow the onscreen instructions in the device troubleshooter wizard.7 Restart the computer. Click the Start button, click the Arrow button next to Shut Down, and then click Restart.

Performance

Symptom	Possible solution
Computer displays a processor speed that is lower than expected.	This happens when the processor is automatically running in a lower power state, because the applications running do not require the maximum processing power.
Software programs and files take longer than expected to open or respond.	If you created multiple user accounts on your computer, ensure other users are not logged in. If there are multiple users logged in simultaneously, system resources must be shared among them.

Wireless devices

Symptom

Possible solution

Bluetooth device is not working.

Ensure the device and your computer are the correct distance apart—not too far and not too near. For the correct distance, refer to the device instructions.

Remove and then reinstall the device:

- 1 Click the **Start** button, and then click **Control Panel**.
- 2 Click **Hardware and Sound**, and then click **Bluetooth Devices**.
- 3 Select the device that is not working, and then click **Remove**.
- 4 Click **Add**, press the Reset button on the device, place a check mark in the **My device is set up and ready to be found** check box, and then click **Next**.
- 5 Follow the onscreen wizard instructions.

The device may have too many connections. Either wait until the device is less busy, or set the other devices so they are not discoverable. For information on how to turn off discoverability, refer to the device instructions.

Ensure other devices that use radio frequencies (for example, microwave ovens, cordless phones, and 802.11 wireless networks) are not creating interference. Try moving the device that is not working farther away from other devices.

Remote control

Symptom	Possible solution
Remote sensor is not receiving a signal from the remote control.	<ul style="list-style-type: none">■ Be sure to point the remote control at the sensor.■ Be sure the remote control has fresh batteries.■ For an external sensor with a USB connector, try enabling the IR connection by following these steps:<ol style="list-style-type: none">1 Click the Start button.2 Type <i>Device Manager</i> into the Start Search box, and then click Device Manager to open the Device Manager window.3 Click the plus sign (+) next to Universal Serial Bus controllers.4 If eHome Infrared Receiver is listed under Universal Serial Bus Controllers, Windows 7 is properly detecting the IR receiver. If it is not listed, go to the next step.5 Unplug the end of the USB cable on the remote sensor from the computer, and then plug it back into the same USB connector.6 Disconnect all other USB devices, leaving the remote sensor connected, and then restart the computer. Connect other USB devices after the remote sensor appears in the Device Manager window.

Memory card reader

Symptom	Possible solution
Memory card reader cannot read the memory card.	<p>Do not insert or remove memory cards when the in-use (activity) light is flashing. Doing so may cause data loss or permanent damage to the card reader.</p> <hr/> <p>Some memory cards have a Read/Write or a Security switch. Ensure the switch is set to Write Enabled before you attempt to write data to the card.</p> <hr/> <p>Ensure the amount of stored data does not exceed the storage limit of the memory card.</p>

Memory card reader (continued)

Symptom	Possible solution
Memory card reader cannot read the memory card. (continued)	Ensure the memory card is one of the supported types: CompactFlash (I, II, and Microdrive), Memory Stick, Memory Stick Pro, MultiMedia, Secure Digital, SmartMedia, or xD. Some models may support additional types, such as SDHC (Secure Digital High-Capacity) memory cards. <hr/> Ensure the memory card is fully inserted into the correct slot. <hr/> Inspect the ends of the memory cards for dirt or material that closes a hole or spoils a metal contact. Clean the contacts with a lint-free cloth and a small amount of isopropyl alcohol. Replace the memory card if necessary.

Software Troubleshooting

Your computer uses the operating system and installed software programs during normal operation. If your computer works improperly or stops because of the software, you may be able to repair it.

Some software repairs are as simple as restarting your computer, and others require performing a system recovery from files on your hard disk drive.

Software repair overview

The most efficient way to repair software problems is simply to restart the computer or turn the computer off completely and then power it back up again. If this does not work, then explore the following methods for fixing your computer if you are experiencing software problems:

- Updating drivers (see the following section, “Updating drivers”).
- Microsoft System Restore (see “Microsoft System Restore” on page 46) — Restores your computer configuration to a configuration that was in use before the current software problem existed.
- Software program and hardware driver reinstallation (See “Software program and hardware driver reinstallation” on page 47) — Allows reinstallation of the factory-installed software or hardware driver by using the Recovery Manager program.
- System recovery (see “System Recovery” on page 50) — Erases and reformats the hard disk drive, deleting all data files you have created, and then reinstalls the operating system, programs, and drivers.

Updating drivers

A *driver* is a software program that enables your computer to communicate with an attached device, such as a printer, hard disk drive, mouse, or keyboard.

Complete the following procedure to update a driver, or to revert to an earlier version of the driver if the new one does not solve your problem:

- 1 Click the **Start** button.
- 2 Type *Device Manager* into the Start Search box, and then click **Device Manager** to open the Device Manager window.
- 3 Click the plus sign (+) to expand the type of device you want to update or rollback. (For example, DVD/CD-ROM drives).
- 4 Double-click the specific item (for example, **HP DVD Writer 640b**).
- 5 Click the **Driver** tab.
- 6 To update a driver, click **Update Driver**, and then follow the onscreen instructions.
Or
To revert to an earlier version of a driver, click **Rollback Driver**, and then follow the onscreen instructions.

Microsoft System Restore

Microsoft Windows 7 includes a feature that enables you to restore your computer configuration to a configuration that was in use before the current software problem existed. The feature does this by creating a restore point where it records the computer settings at that time and date.

When a new program is installed, the operating system automatically creates a restore point before it adds the new software. You can also set restore points manually.

If you experience a problem that you think may be due to software on your computer, use System Restore to return the computer to a previous restore point.

NOTE: Always use this System Restore procedure before you use the system recovery program.

To start a System Restore:

- 1 Close all open programs.
- 2 Click the **Start** button, right-click **Computer**, and then click **Properties**.
- 3 Choose **System protection**, **System Restore**, and then click **Next**.
- 4 Follow the onscreen instructions.

To manually add restore points:

- 1 Close all open programs.
- 2 Click the **Start** button, right-click **Computer**, and then click **Properties**.
- 3 Click **System protection**.
- 4 Under Protection Settings, select the disk for which you want to create a restore point.
- 5 Click **Create**.
- 6 Follow the onscreen instructions.

For more information about software restore points:

- 1 Click the **Start** button, and then click **Help and Support**.
- 2 Type *system restore* in the Search Help box, and then press Enter.

Software program and hardware driver reinstallation

If an individual factory-installed software program or hardware driver is damaged, you can reinstall it by using the Recovery Manager program (select models only).

NOTE: Do not use the Recovery Manager program to reinstall software programs that came on CDs or DVDs included in the computer box. Reinstall these programs directly from the CDs or DVDs.

Before you uninstall a program, be sure you have a way to reinstall it. Check that it is still available from where you initially installed it (for example, discs or the Internet). Or check that the program is in the list of programs you can reinstall from the Recovery Manager.

To check the list of installable programs in the Recovery Manager:

- 1 Click the **Start** button, **All Programs, Recovery Manager**, and then click **Recovery Manager**. If prompted, click **Yes** to allow the program to continue.
- 2 Under I need help immediately, click **Software Program Reinstallation**.
- 3 Click **Next** at the Welcome screen.

A list of programs opens. Check whether your program is there.

To uninstall a program:

- 1 Close all software programs and folders.
- 2 Uninstall the damaged program:
 - a Click the **Start** button, and then click **Control Panel**.
 - b Under Programs, click **Uninstall a program**.
 - c Select the program you want to remove, and then click **Uninstall**.
 - d Click **Yes** if you want to continue with the uninstall process.

To reinstall a program using the Recovery Manager:

- 1 Click the **Start** button, click **All Programs**, click **Recovery Manager**, and then click **Recovery Manager**.
- 2 Click **Software Program Reinstallation**.
- 3 Click **Next** at the Welcome screen.
- 4 Choose the program you want to install, click **Next**, and follow the onscreen instructions.
- 5 When you have finished reinstalling, restart the computer.

NOTE: Do not skip this last step. You must restart the computer after recovering software programs or hardware drivers.

Maintenance

This section includes information about tasks you can perform to help ensure trouble-free operation of your computer, and to ease the recovery of important information on your computer if problems arise in the future.

Maintenance tasks

It is important that you perform simple maintenance of your computer to ensure that it works at peak performance.

Weekly

Software Cleanup	Using Disk Cleanup or safe third-party cleaning tools removes junk files and temporary files that accumulate and slow down your system. Also, check for programs you no longer need and uninstall them.
------------------	---

Defragmentation	Running Disk Defragmenter keeps your hard disk in good condition, as well as improves system performance. Frequently performing this task does not harm your system.
-----------------	--

Virus Scan	Performing a full virus scan every week can catch anything that may have slipped through unnoticed. Most antivirus products have a scheduling feature to keep track of this automatically.
------------	--

Monthly

Hardware Cleanup	Thoroughly clean the inside and outside of your computer.
------------------	---

Software Updates	Using Windows Updates can fix operating system bugs and improve performance. Also, be sure to check for driver updates for your hardware and new versions of your favorite programs.
------------------	--

Hard Disk Diagnostic	Sometimes a failing hard disk can be caught beforehand, saving you a lot of surprises in the future.
----------------------	--

Yearly

System Recovery	In time, your system may still get bogged down, depending on the usage of the computer. Use System Recovery to wipe your Windows operating system installation clean, restoring it to the original configuration when you first powered up your system. Remember to make a backup first! Before proceeding with a recovery, see "System Recovery" on page 50 for further details.
-----------------	---

Creating data backup discs

Use CD or DVD recording (or *burning*) software that is installed on your computer to create backup discs of important information, including personal files, e-mail messages, and Web site bookmarks. You can also move data to an external hard disk drive.

When writing data to a backup disc, use software that includes *write verification* functionality. This feature compares the data on your hard disk drive with the data copied to the disc to ensure it is an exact copy. Depending on your disc recording software, you may need to manually enable this feature (refer to the software documentation).

If you encounter recording issues, try alternate media (different types or brands). Also, use the Windows Explorer tool to view your files and verify content was copied over. To open Windows Explorer, right-click the **Start** button, and then click **Explore**.

Creating system recovery discs

This is a one-time procedure that you should perform while your computer is working properly. If you encounter problems with your computer later, you can restore it to its original factory settings by using the system recovery discs that you created. Refer to “Creating recovery discs” on page 51 for details.

Keeping the Computer Free of Dust, Dirt, and Heat

Keeping your computer system free of dust, dirt, and heat will prolong its life. Dust, pet hair, and other particles can build up, creating a blanket effect; as a result, components can overheat, or, in the case of the keyboard and mouse, not work smoothly and effectively. Check your system once a month for visible signs of dust and debris, and clean it about once every three months.

Cleaning the computer and monitor

- 1 Unplug the computer from its power source.
- 2 Unplug the monitor from its power source.
- 3 Use a clean, dry cloth to dust the computer case and the monitor.
- 4 Use a clean cloth dampened with warm water to wipe the computer case and the monitor case clean.

Do not use water on the monitor screen.

NOTE: If there is sticker residue or a spill on the computer or monitor case, use isopropyl or rubbing alcohol and a lint-free cloth to remove it.

- 5 Use a clean cloth to dry the computer and monitor case.
- 6 Use a clean, dry cloth to clean the monitor screen, or, for more thorough cleaning use an antistatic screen cleaner and a clean cloth.

Cleaning the computer vents

Air vents keep the computer and monitor cool. To maintain efficient air flow, keep these vents clean by using a small battery-powered vacuum cleaner. (A battery-powered vacuum cleaner eliminates the risk of electric shock.)

- 1 Run the vacuum over the vents in the computer case and the monitor case.
- 2 Remove any debris that has accumulated in and around the computer connectors (for example, the Ethernet and USB connectors).

Cleaning the keyboard and mouse

When cleaning the keyboard keys, use a low setting on the battery-powered vacuum cleaner, to avoid removing key caps and springs.

- 1 Vacuum between the keys of the keyboard and along the grooves.
- 2 Use a clean, dry cloth and isopropyl alcohol to clean buildup on the keyboard keys and along its edges.
- 3 Wipe the body of the mouse and the mouse cord with cleaning wipes or a cloth and cleanser.

If you have a roller ball mouse, clean the ball and rollers inside:

- 1 Turn the mouse upside down.
- 2 Rotate the ball-cover ring counterclockwise to remove the ring and release the roller ball.
- 3 Rinse the roller ball with soap and warm water.
- 4 Clean the rollers inside the mouse with a cotton swab dampened with isopropyl alcohol.
- 5 After the roller ball and rollers are completely dry, replace the ball and ball-cover ring.

System Recovery

System recovery completely erases and reformats the hard disk drive, deleting all data files you have created. System recovery reinstalls the operating system, programs, and drivers. However, you must reinstall any software that was not installed on the computer at the factory. This includes software that came on CDs included in the computer accessory box, and software programs you installed after purchase.

You must choose one of the following methods to perform a system recovery:

- Recovery Image — Run the system recovery from a recovery image stored on your hard disk drive. The recovery image is a file that contains a copy of the original factory-shipped software. To perform a system recovery from a recovery image, see “System recovery from the Windows 7 Start Menu” on page 52.

NOTE: The recovery image uses a portion of the hard disk drive that cannot be used for data storage.

- Recovery Discs — Run the system recovery from a set of recovery discs that you create from files stored on your hard disk drive. To create recovery discs, see the next section.

Creating recovery discs

Complete the procedure described in this section to create a set of recovery discs from the recovery image stored on your hard disk drive. This image contains the operating system and software program files that were originally installed on your computer at the factory.

You can create only one set of recovery discs for your computer. Furthermore, the recovery discs you create can be used only with your computer.

Choosing recovery discs

To create recovery discs, your computer must have a DVD writer.

- Use DVD+R or DVD-R blank media to create your system recovery discs.
- You cannot use CDs or DVD+RW, DVD-RW, DVD+RW DL, DVD-RW DL, DVD+R DL, or DVD-R DL discs to create recovery discs.

Use high-quality discs to create your set of recovery discs. The verification standard for the recovery disc creation process is very high. You may see error messages such as *Recording failure when writing disc* or *Error detected during disc verification*.

Your discs may be rejected if they are not defect-free. You will be prompted to insert a new blank disc to try again. It is normal that some of your discs may be rejected.

The number of discs in the recovery disc set depends on your computer model (typically 1–3 DVD discs). The Recovery Disc Creator program tells you the specific number of blank discs needed to make the set.

The process takes some time to verify that the information written on the disc is correct. You can quit the process at any time. The next time you run the program, it resumes where it left off.

To create recovery discs:

- 1 Close all open programs.
- 2 Click the **Start** button, click **All Programs**, click **Recovery Manager**, and then click **Recovery Disc Creation**. If prompted, click **Yes** to allow the program to continue.
- 3 Follow the onscreen instructions. Label each disc as you make it (for example, Recovery 1, Recovery 2).
- 4 Store the recovery discs in a safe place.

System recovery options

You should attempt a system recovery in the following order:

- 1 Through the hard disk drive, from the Windows 7 Start menu.
- 2 Through the hard disk drive, by pressing the F11 key on the keyboard during system startup.
- 3 Through recovery discs that you create.
- 4 Through recovery discs purchased from HP Support. To purchase recovery discs, go to <http://www.hp.com/support> and visit the Software & Driver downloads page for your computer model.

System recovery from the Windows 7 Start Menu

If the computer is working, and Windows 7 is responding, use these steps to perform a system recovery.

NOTE: System recovery deletes all data and programs you created or installed after purchase. Therefore, ensure you have backed up, to a removable disc, any data you want to keep.

- 1 Turn off the computer.
- 2 Disconnect all peripheral devices from the computer, except the monitor, keyboard, and mouse.
- 3 Turn on the computer.
- 4 Click the **Start** button, click **All Programs**, click **Recovery Manager**, and then click **Recovery Manager**. If prompted, click **Yes** to allow the program to continue.
- 5 Under I need help immediately, click **System Recovery**.
- 6 Select **Yes**, and then click **Next**.
Your computer restarts.

NOTE: If your system does not detect a recovery partition, it will prompt you to insert a recovery disc. Insert the disc and proceed to Step 7 in the section “Starting system recovery from user-created recovery discs” on page 53.

- 7 Under I need help immediately, click **System Recovery**.
- 8 If you are prompted to back up your files, and you have not done so, select **Back up your files first (recommended)**, and then click **Next**. Otherwise, select **Recover without backing up your files**, and then click **Next**.
System recovery begins. After system recovery is complete, click **Finish** to restart the computer.
- 9 Complete the registration process, and wait until you see the desktop.
- 10 Turn off the computer, reconnect all peripheral devices, and turn the computer back on.
- 11 Perform the procedure “Performing the Post-Recovery Procedure” on page 54.

System recovery at system startup

If Windows 7 is not responding, but the computer is working, use these steps to perform a system recovery:

NOTE: System recovery deletes all data and programs you created or installed after purchase. Therefore, ensure you back up, to a removable disc, any data you want to keep.

- 1 Turn off the computer. If necessary, press and hold the On button until the computer turns off.
- 2 Disconnect all peripheral devices from the computer, except the monitor, keyboard, and mouse.
- 3 Press the On button to turn on the computer.

- 4 As soon as you see the initial company logo screen appear, repeatedly press the F11 key on your keyboard until the *Windows is Loading Files...* message appears on the screen.
- 5 Under I need help immediately, click **System Recovery**.
- 6 If you are prompted to back up your files, and you have not done so, select **Back up your files first (recommended)**, and then click **Next**. Otherwise, select **Recover without backing up your files**, and then click **Next**.
System recovery begins. After system recovery is complete, click **Finish** to restart the computer.
- 7 Complete the registration process, and wait until you see the desktop.
- 8 Turn off the computer, reconnect all peripheral devices, and turn the computer back on.
- 9 Perform the procedure "Performing the Post-Recovery Procedure" on page 54.

Starting system recovery from user-created recovery discs

This section contains the procedure for performing a system recovery from the recovery discs you created as described in "Creating recovery discs" on page 51.

NOTE: System recovery deletes all data and programs you created or installed after purchase. Therefore, ensure you back up, onto a removable disc, any data you want to keep.

To perform a system recovery using recovery discs:

- 1 If the computer is working, create a backup DVD containing all the data files you want to save. When you are done, remove the backup disc from the drive tray.



CAUTION: All data on the hard disk drive will be deleted. You will lose data if it is not backed up.

- 2 Insert recovery disc #1 into the DVD drive tray, and close the tray.
- 3 If the computer works, click the **Start** button, click the **Arrow** button next to Shut Down, and then click **Shut Down**.
Or
If the computer is not responding, press and hold the On button for approximately 5 seconds, or until the computer turns off.
- 4 Disconnect all peripheral devices from the computer, except the monitor, keyboard, and mouse.
- 5 Press the On button to turn on the computer.
If you are prompted to choose between running System Recovery from disc or from hard drive, select **Run program from disc**, and then click **Next**.
- 6 Under I need help immediately, click **Factory Reset**.
- 7 If you are prompted to back up your files, and you have not done so, select **Back up your files first (recommended)**, and then click **Next**. Otherwise, select **Recover without backing up your files**, and then click **Next**.
- 8 If you are prompted to insert the next recovery disc, do so.

- 9 When the Recovery Manager is finished, remove all recovery discs from the system.
- 10 Click **Finish** to restart the computer.
- 11 After restarting the computer, see “Preparing to Use Your Computer” on page 13.

Performing the Post-Recovery Procedure

- 1 At the Welcome to Microsoft Windows screen, follow the onscreen setup instructions.
- 2 Follow the instructions in “Preparing to Use Your Computer” on page 13.

Additional Troubleshooting

For additional troubleshooting solutions, refer to the following:

■ HP Support Assistant

HP Support Assistant helps you maintain your PC performance and resolve problems faster with automated updates, onboard diagnostics, and guided assistance.

To open HP Support Assistant, click the **Start** button, **All Programs**, **HP**, and then click **HP Support Assistant**.

■ Windows 7 Troubleshooting Tools

Windows 7 provides troubleshooting tools that can automatically troubleshoot and fix common computer problems. To access the Windows 7 Troubleshooting Tools:

- 1 Click the **Start** button, and then click **Control Panel**.
- 2 Click **System and Security**.
- 3 Under Action Center, click **Find and fix problems (troubleshooting)**.

Index

A

- adapters
 - HDMI-to-DVI 3
 - VGA-to-DVI 3
- antivirus software 18
- audio
 - A/V In 8
 - connecting
 - Audio Line In 4
 - Audio Line Out 4
 - speakers 5
 - left and right connectors 8
 - troubleshooting 36

B

- backup 49
- buttons
 - eject
 - CD/DVD drive 23
 - Off, *See turning off computer* 14

C

- card reader, memory 21
- CD/DVD drive
 - troubleshooting 38–40
 - using vertical 23
- cleaning 49
- Composite video connector 8
- computer
 - cleaning 49
 - Help & Tools 26
 - setting up 1
 - transferring files 20
 - turning on the computer 13

- connecting
 - Ethernet 6
 - modem 7
 - monitor 3
 - peripherals 2
 - speakers 4–5
 - TV 7–11
 - wired network 6
 - wireless LAN 6
- connectors
 - Analog Video Out 9
 - Audio Line In 4
 - Audio Line Out 4
 - Composite Video In 8
 - DVI 3
 - Ethernet 6
 - Ethernet LAN 3
 - HDMI 3
 - IR IN 12
 - IR OUT 12
 - keyboard (wired) 2
 - modem 3
 - monitor 3
 - mouse (wired) 2
 - network 3, 6
 - S-video In 8
 - TV/Cable Ant 9
 - VGA 3
- creating a LightScribe disc label 23
- CyberLink LabelPrint
 - using to create a LightScribe label 23

D

- digital picture 21
- display
 - see monitor*
- documentation, onscreen 26
- drivers, update 46

- E**
- Ethernet LAN connector 3
- F**
- firewall 18
- H**
- hardware
 - troubleshooting installation 41–42
- HDMI-to-DVI 3
- headphones
 - connecting 5
- Help and Support 25
- Hibernate mode 14
- HP Advisor 26
- I**
- Internet
 - connection 6–7
 - security 18
 - troubleshooting 37–38
- IR
 - blaster 12
 - connection, enable 44
 - receiver 12
- K**
- keyboard
 - wired
 - connecting 2
 - troubleshooting 32
 - wireless
 - troubleshooting 33–35
- L**
- LAN (local area network)
 - antenna 6
 - connecting 3
 - connecting wireless LAN device 6
 - setting up 6
- LightScribe 23
- locking the computer 14
- M**
- maintenance tasks 48
- memory card reader
 - troubleshooting 44
- memory card reader, using 21
- microphone
 - adjusting recording levels 16
 - connecting 5
 - selecting in Windows 16
- modem
 - connection 3, 7
- monitor
 - connector 3
 - troubleshooting 31
- mouse
 - wired
 - connecting 2
 - troubleshooting 32
 - wireless
 - troubleshooting 33–35
- N**
- network interface adapter 3
- P**
- passwords 17
- performance
 - troubleshooting 42
- power
 - troubleshooting 31
- power connector 2
- R**
- recording level, adjusting 16
- Recovery Manager 47
- reinstall a software program 47
- remote control 24
 - troubleshooting 44
- repairing software 45
- repetitive strain injury (RSI), see *Safety & Comfort Guide*
- restarting the computer 14
- restoring your computer configuration 46
- S**
- Safety & Comfort Guide* 27
- safety warnings 1, 27
- setting up computer 1
- shutting down the computer 14
- Sleep mode 14
- software
 - repairing 45
 - software programs
 - reinstalling 47
- sound
 - see *audio*
- speakers
 - adjust volume 16
 - connecting 5
 - troubleshooting 36

- startup
 - troubleshooting 30
- Support Web site 25
- surge protector 2
- S-video In connector 8
- System 46
- System performance
 - troubleshooting 42
- System recovery 50
 - System Restore, Microsoft 46
- system recovery discs, making 49, 50

T

- television
 - see TV
- transferring information to your new computer 20
- troubleshooting
 - audio 36
 - CD/DVD drive 38–40
 - hardware installation 41–42
 - Internet connection 37–38
 - keyboard (wired) 32
 - keyboard (wireless) 33–35
 - memory card reader 44
 - monitor 31
 - mouse (wired) 32
 - mouse (wireless) 33–35
 - power 31
 - remote control 44
 - speakers 36
 - startup 30
 - system performance 42
 - video 40
 - wireless devices 43
- turning off computer 14
- TV
 - connecting to computer 7–11

U

- updating
 - drivers 46
 - system 18
 - Windows 7 18

V

- VGA-to-DVI 3
- video
 - troubleshooting 40
- volume, adjusting audio 16

W

- Windows Update 18
- wired network 6
- wireless devices
 - troubleshooting 43
- wireless LAN
 - checking installation 37
 - connection 6
 - network device 37
 - security 15
- working in comfort 27

The power to make a change

Thank you for your purchase. HP is dedicated to producing the highest quality, best performing, and easiest to use PCs in the world. HP also designed this product with the environment in mind. But to reduce its impact even further, we need your help.

Let's work together to make a change.

How you can help

- **Recycle your old computer**
- **Don't use a screen saver**
- **Please don't disable the power settings**

Disposing of electronic waste responsibly has been an HP priority for more than 20 years. If this computer is a replacement for an older PC you no longer need, go to www.hp.com/go/recycle to find out if HP can help you dispose of your old computer with minimum impact on the planet.

Did you know that screen savers can prevent your HP PC from going to sleep and thereby waste power? Screen savers can also actually reduce the life of your monitor by increasing the number of hours the LCD backlight is on.

The power management tools on this computer are set to minimize energy use without impacting performance. Please do not disable them.

What we've done

- **Designed with the environment in mind**
- **More energy efficient**
- **Better and less materials for a healthy planet**

While we want you to enjoy this computer for many years to come, we recognize that the time will come when you'll want to dispose of it. That's why we've designed it so it can be easily dismantled and recycled as much as possible. The packaging that came with your PC is also designed to maximize recyclability.

This PC has HP Power Management Technology which can reduce PC energy use up to 45% compared to PCs without power management. HP PCs keep energy needs to a minimum, saving you money and reducing your carbon footprint.

Ensuring the health of you, your family and our planet is a key priority at HP. That's why we are committed to using the safest materials in the production of this and all our other products.

Printed in Xxxxx



5 1 7 2 1 5 - 0 3 2