

MBB100 Black Box Vessel Monitoring and Control

User's Manual

Revision 1.0

Copyright © 2011 Maretron, LLP All Rights Reserved

Maretron, LLP
9014 N. 23rd Ave #10
Phoenix, AZ 85021-7850
<http://www.maretron.com>

Maretron Manual Part #: M003003

Revision History

Rev.	Description
1.0	Original document.

Table of Contents

1	General	1
1.1	Introduction	1
1.2	Firmware Revision	2
1.3	MBB100 Features	2
1.4	Quick Install.....	2
2	Installation.....	3
2.1	Unpacking the Box	3
2.2	Choosing a Mounting Location	3
2.3	Mounting the MBB100.....	3
2.4	Connecting the MBB100	4
2.4.1	RS-232 Connection.....	5
2.4.2	VGA Connection	6
2.4.3	LAN Connection.....	6
2.4.4	USB Device Connection	7
2.4.5	Power Connection.....	7
2.4.6	Power Sequencing.....	8
2.5	Configuring the MBB100	8
2.5.1	Manually Entering LAN Connection Information	9
2.5.2	Entering N2KServer® or IPG100 Connection Information	11
3	Operating the MBB100	14
3.1	Turning the MBB100 On.....	14
3.2	Turning the MBB100 Off.....	14
3.3	Using the MBB100	14
4	Maintenance	15
5	Troubleshooting	16
6	Technical Specifications	17
7	Technical Support.....	18
8	Maretron (2 Year) Limited Warranty	19

Table of Figures

Figure 1 – MBB100 Network Diagram	1
Figure 2 - Mounting Bracket Screw Hole Locations	4
Figure 3 - Mounting Brackets Attached to MBB100	4
Figure 4 - MBB100 Rear Panel Connections	5
Figure 5 – MBB100 Front Panel.....	5
Figure 6 – LAN Connection.....	6
Figure 7 – USB Device Connection	7
Figure 8 - MBB100 Power Terminal Block	7
Figure 9 – MBB100 Startup Screen	8
Figure 10 – N2KView [®] Window with Tabs Displayed.....	9
Figure 11 – Configuration Dialog	10
Figure 12 – N2KView [®] Window with Tabs Displayed.....	11
Figure 13 – Connections Settings Dialog.....	12

1 General

1.1 Introduction

Congratulations on your purchase of the Maretron MBB100 Black Box for Vessel Monitoring and Control. Maretron has designed and built your black box to the highest standards for years of dependable and accurate service.

The Maretron Black Box (MBB100) is a dedicated processing unit that comes preloaded with Maretron's N2KView® vessel monitoring and control software (N2KView® hardware license key sold separately). Unlike a PC that allows any software to be loaded, the MBB100 runs only N2KView® software making it extremely stable and dedicated to monitoring and controlling your vessel.

The MBB100 is ruggedized for marine use and includes a solid state disk drive to withstand the pounding associated with waves. And since the MBB100 dissipates less than 20 watts, there is no need for internal cooling fans that are noisy and wear out causing electronics to overheat and fail.

The MBB100 connects to a monitor through a VGA connector and associated touch screen through a USB or serial port connection. Alternatives to controlling the N2KView® software through a touch screen include keyboards, mice, or track balls connected through USB. The MBB100 has an Ethernet port for communicating with an NMEA 2000® network (see Figure 1) through Maretron's Internet Protocol Gateway (IPG100). Alternatively, the MBB100 can network through Ethernet to a PC running N2KServer®. Although the MBB100 comes pre-installed with the N2KView® software, a separately purchased N2KView hardware license key plugged into the IPG100 (or PC) is required (see IPG100 User's Manual for more details). The Ethernet port is also used for connecting Internet Protocol (IP) cameras for viewing within the N2KView® software.

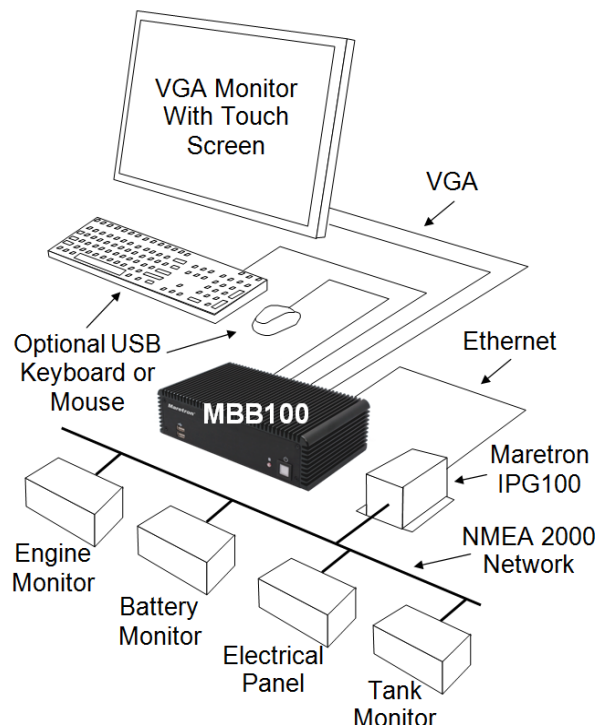

Figure 1 – MBB100 Network Diagram

Of course you get the same flexibility using Maretron's N2KView[®] software from the MBB100 as you would running the software on a PC, which includes the ability to configure as many screens as you want with exactly the information you want to see. Plus you get free upgrades to the software as improvements and new features are added.

The Maretron MBB100 is designed to operate within the harsh demands of the marine environment. However, no piece of marine electronic equipment can function properly unless installed, configured, and maintained in the correct manner. Please read carefully and follow these instructions for installation, configuration, and usage of the Maretron MBB100 in order to ensure optimal performance.

1.2 Firmware Revision

This manual corresponds to the MBB100 running N2KView[®] Version 3.2.

1.3 MBB100 Features

The Maretron MBB100 has the following features.

- Full version of N2KView[®] software preinstalled (requires N2KView[®] licenses, purchased separately)
- Wired Ethernet interface
- Supports user-supplied VGA monitor
- Supports user-supplied touchscreen (ELO, 3M Microtouch, Hampshire TSharc, Penmount)
- Supports user-supplied mouse and keyboard
- Supports Bluetooth mice and keyboards with built-in Bluetooth adapter
- Operates on 9-36VDC
- 20W power consumption
- Solid State Disk Drive
- Fanless cooling system

1.4 Quick Install

Installing the Maretron MBB100 display involves the following four steps. Please refer to the individual sections for additional details.

- Unpacking the Box (Section 2.1)
- Choosing a Mounting Location (Section 2.2)
- Mounting the MBB100 (Section 2.3)
- Connecting the MBB100 (Section 2.4)
- Configuring the MBB100 (Section 2.5)

2 Installation

2.1 Unpacking the Box

When unpacking the box containing the Maretron MBB100, you should find the following items:

- 1 – MBB100 Maretron Black Box Vessel Monitoring and Control
- 2 – Mounting Brackets
- 1 – Short Screw Set (Used for Mounting Bracket)
- 1 – AC Power Cord
- 1 – AC Power Supply
- 1 – Rubber Feet/Long Screw Set
- 1 – MBB100 User's Manual
- 1 – N2KView® Documentation CD-ROM
- 1 – Warranty Registration Card

If any of these items are missing or damaged, please contact Maretron.

2.2 Choosing a Mounting Location

The MBB100 must be mounted in an indoor location.

2.3 Mounting the MBB100

The MBB100 can be mounted to a wall or other flat surface with the included mounting brackets.

2.6.1 Mounting the System with Mounting Brackets

To mount the MBB100 onto a wall or some other surface using the two mounting brackets, please follow the steps below.

Step 1: Turn the MBB100 over.

Step 2: Align the two retention screws holes in each bracket with the corresponding retention screw holes on the sides of the MBB100 bottom surface (marked in yellow in Figure 2).

Step 3: Secure the brackets to the MBB100 by inserting two retention screws into each bracket (see Figure 2).

Step 4: Drill holes in the intended installation surface.

Step 5: Align the mounting holes in the sides of the mounting brackets with the predrilled holes in the mounting surface.

Step 6: Insert four retention screws, two in each bracket, to secure the MBB100 to the wall.

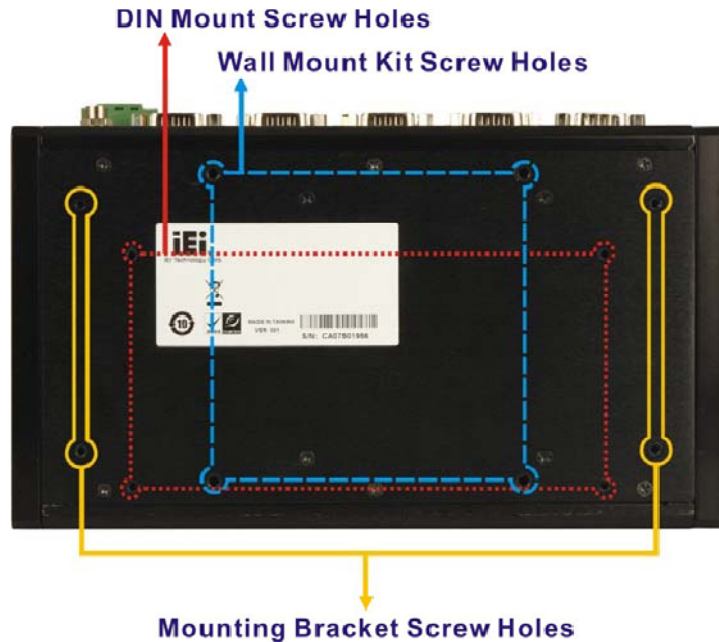

Figure 2 - Mounting Bracket Screw Hole Locations



Figure 3 - Mounting Brackets Attached to MBB100

2.4 Connecting the MBB100

Most I/O interface connections of the MBB100 are found on rear panel (see

Figure 4). The I/O interface panel located on the rear of the MBB100 has the following I/O interface connectors:

- 2 x 9-36VDC power connectors
- 1 x Audio line-out jack
- 1 x Reset button
- 1 x RS-232 serial interface connector
- 1 x RJ-45 Gigabit Ethernet LAN ports
- 2 x USB 2.0 connectors

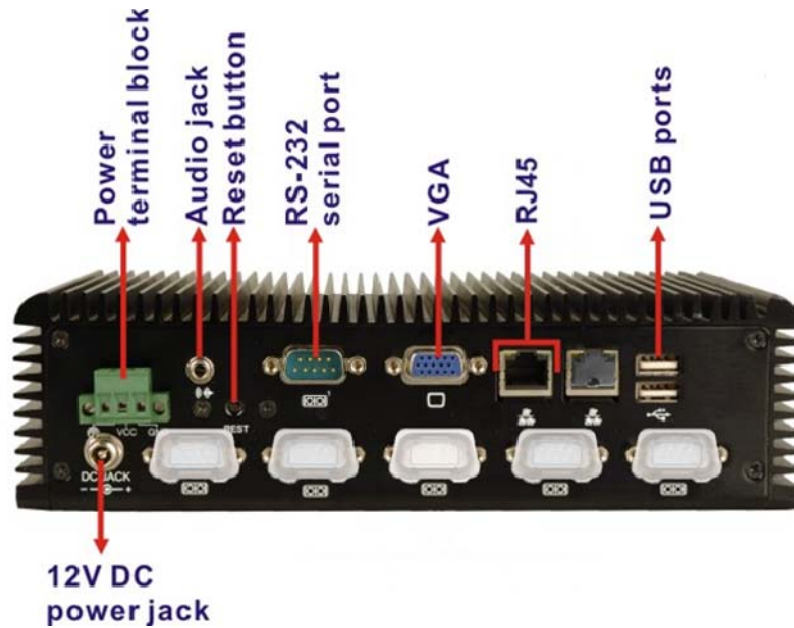

Figure 4 - MBB100 Rear Panel Connections

The I/O interface panel located on the front of the MBB100 (see Figure 5) has two USB 2.0 interface connectors.



Figure 5 – MBB100 Front Panel

2.4.1 RS-232 Connection

There is one external RS-232 connector. The RS-232 connector enables connection to an external touch screen. To connect a serial cable with the RS-232 connector, please follow the instructions below.

Step 1: Locate the RS-232 connector on the rear panel of the MBB100.

Step 2: Align the RS-232 connector on the serial cable with the RS-232 connector on the rear panel of the MBB100.

Step 3: Once aligned, gently insert the serial cable RS-232 connector into the MBB100 RS-232 connector.

2.4.2 VGA Connection

There is one external VGA connector. The VGA connector enables connection to an monitor. To connect a VGA cable with the VGA connector, please follow the instructions below.

Step 1: Locate the VGA connector on the rear panel of the MBB100.

Step 2: Align the VGA connector on the cable with the VGA connector on the rear panel of the MBB100.

Step 3: Once aligned, gently insert the cable VGA connector into the MBB100 VGA connector.

2.4.3 LAN Connection

There is one external RJ-45 LAN connector. The RJ-45 connector enables connection to an external network. To connect a LAN cable with the RJ-45 connector, please follow the instructions below.

Step 1: Locate the RJ-45 connector on the rear panel of the MBB100.

Step 2: Align the RJ-45 connector on the LAN cable with the RJ-45 connector on the rear panel of the MBB100 (see Figure 6).

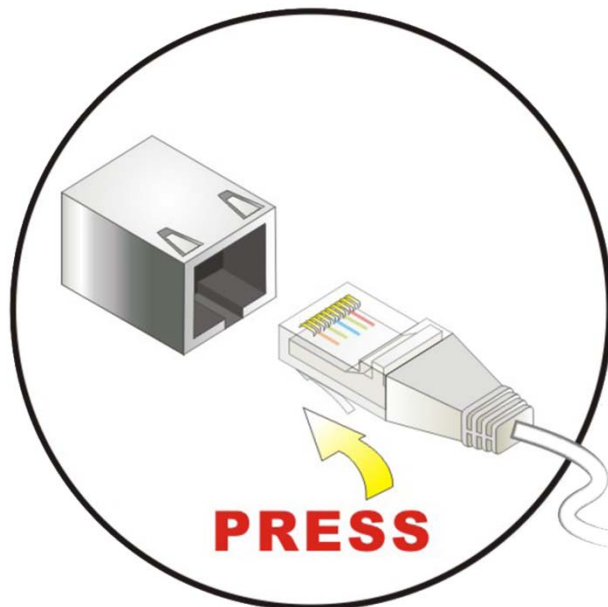

Figure 6 – LAN Connection

Step 3: Once aligned, gently insert the LAN cable RJ-45 connector into the onboard RJ-45 connector.

2.4.4 USB Device Connection

There are four external USB 2.0 connectors. To connect a USB 2.0 or USB 1.1 device, please follow the instructions below.

Step 1: The locations of the USB connectors are shown in and Figure 5.

Step 2: Align the USB device connector with one of the connectors (see Figure 7).

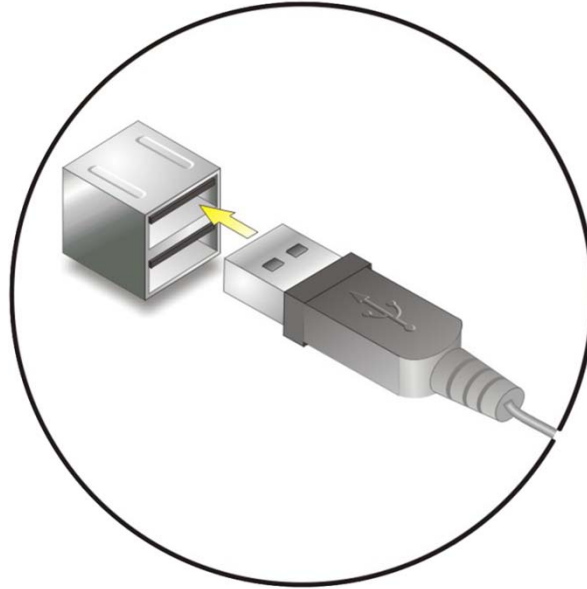

Figure 7 – USB Device Connection

Step 3: Once aligned, gently insert the USB device connector into the MBB100 connector.

2.4.5 Power Connection

The MBB100 can be connected to a power source in one of two ways (over current protection should be provided and should be sized in accordance with ABYC E-11, AC and DC ELECTRICAL SYSTEMS ON BOATS);

- 1) Directly with 9-32VDC power source using the green power terminal block found on the rear panel of the MBB100 (see Figure 8).
 - a) Connect the power source negative terminal to the right hand terminal,
 - b) Connect the power source positive terminal to the center terminal.

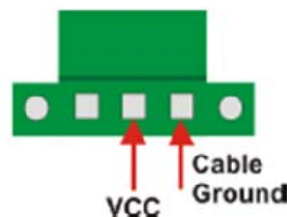

Figure 8 - MBB100 Power Terminal Block

- 2) Indirectly with 100-240VAC 47-63Hz power source using the AC power adapter and the AC power cord supplied in the box.
 - a) Connect the AC power cord to the AC power adapter,
 - b) Connect the AC power cord to the AC power outlet,

- c) Connect the 12VDC connector from the AC power adapter to the MBB100's 12VDC power input connector.

2.4.6 Power Sequencing

When the MBB100 is connected to an appropriate power source, you can use the power switch located on the front panel (see Figure 5) to turn the MBB100 on or off. If the MBB100 is turned on, then the LED found behind the power button will be illuminated blue. If the power switch is pushed to power down the DSM800, the LED is turned off.

The MBB100 can also be switched on and off by applying or removing power through an external switch or breaker. Anytime the power is reapplied to the MBB00, it will turn on.

2.5 Configuring the MBB100

In order to use the MBB100, you must already have N2KServer® installed and running on either a Windows PC or on a Maretron IPG100 Internet Protocol Gateway.

You must also have some information as to the configuration of your local area network.

The MBB100 will start up with the following warning screen:

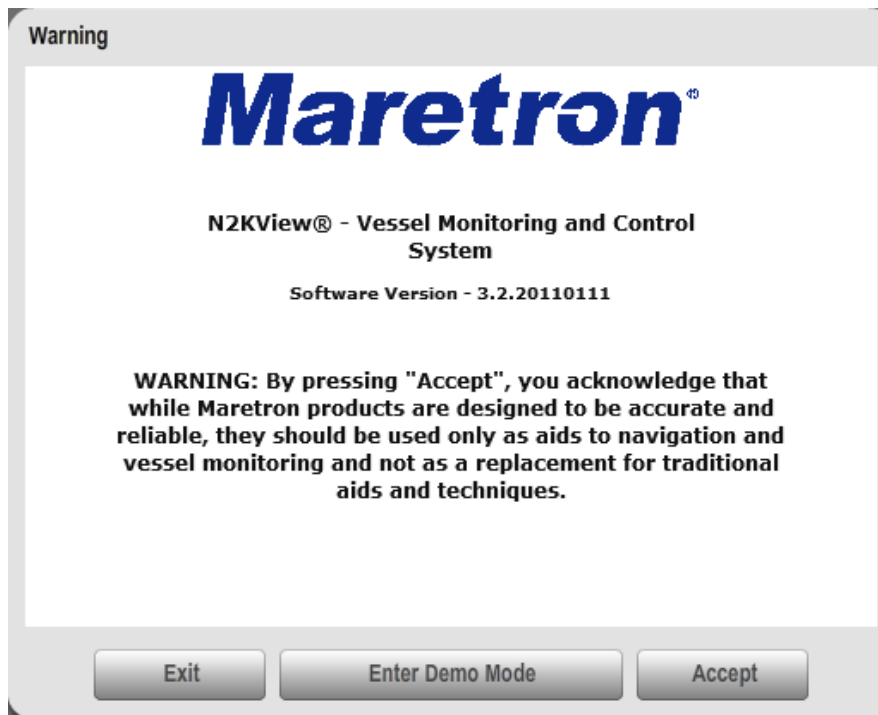

Figure 9 – MBB100 Startup Screen

You are required to press **Accept** and thereby acknowledge this warning message before N2KView® will run in Live Mode.

Alternatively, you may **Enter Demo Mode**. In Demo Mode, you will not be able to connect to a Server and view live data; instead simulated data will be provided to stimulate the controls.

The first time you start the MBB100, you must ensure that the device can connect to your LAN (local area network). The MBB100 comes from the factory preconfigured to obtain its LAN connection information from a DHCP (Dynamic Host Control Protocol) server. If your local area network uses a DHCP server, no configuration is necessary, and the MBB100 should be able to successfully connect to the local area network.

2.5.1 Manually Entering LAN Connection Information

If your local area network does not use DHCP, you must manually enter the LAN connection information into the MBB100. This is done through the following steps:

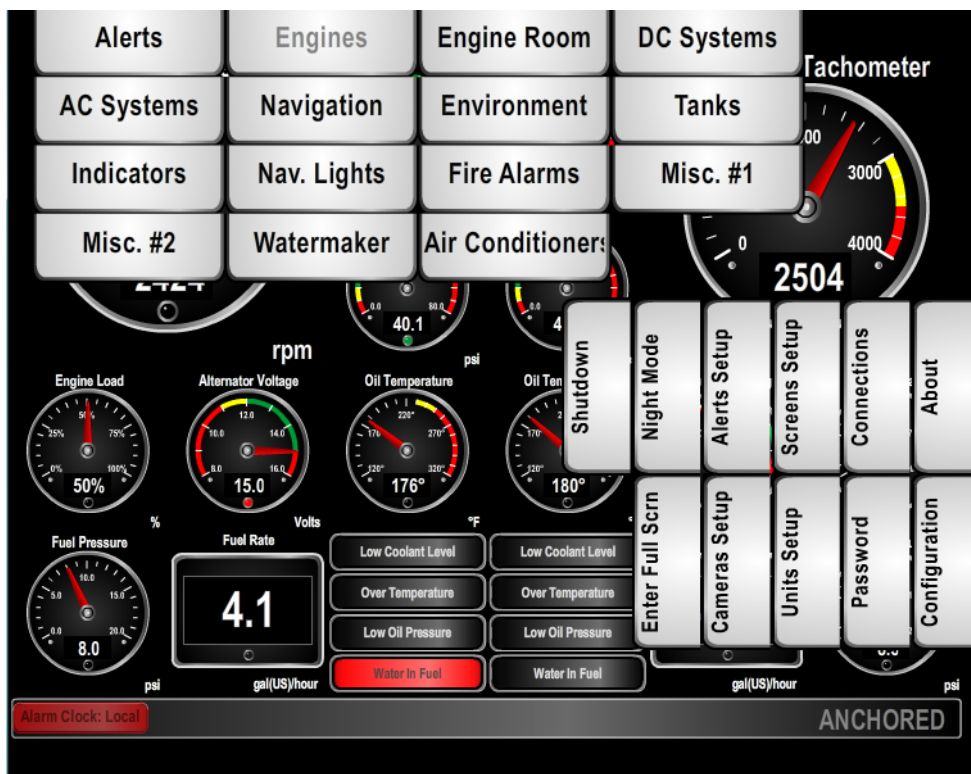

Figure 10 – N2KView® Window with Tabs Displayed

- Click anywhere inside the N2KView® screen to display the screen tabs as shown in Figure 10 above.
- Click on the **“Configuration”** tab on the right side of the N2KView® screen to display the Configuration dialog.



Figure 11 – Configuration Dialog

- c. Uncheck the “**Use DHCP**” box to indicate that your LAN does not use DHCP.
- d. In the “**IP Address**” field, enter the IP address you wish to assign to the MBB100.
- e. In the “**Netmask**” field, enter the netmask value used on your LAN (in most cases, this value will be “255.255.255.0”).
- f. In the “**Gateway**” field, enter the IP address of the default gateway of your LAN.
- g. In the “**Name Server**” field, enter the IP address of a DNS (Dynamic Name Service) Server used on your LAN.
- h. Click the “**Update**” button to make these changes permanent. The screen will go blank for a few seconds while this is being done.

2.5.2 Entering N2KServer® or IPG100 Connection Information

Once the MBB100 has been properly configured to connect to your LAN, you must configure the connection to enable the MBB100 to receive information from an instance of N2KServer® or an IPG100 Server. This is done through the following steps:

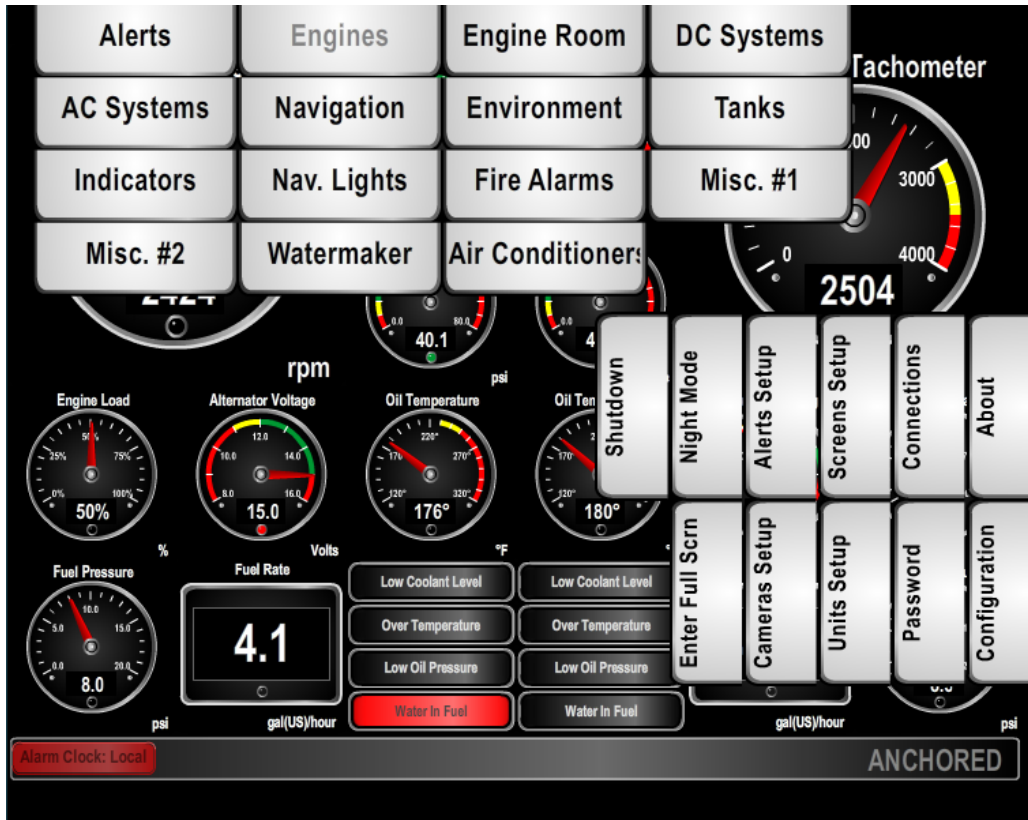

Figure 12 – N2KView® Window with Tabs Displayed

- a. Click anywhere inside the N2KView® screen to display the screen tabs as shown in Figure 12 above.
- b. Click on the “**Connections**” tab on the right side of the N2KView® screen to display the Connections Settings dialog.

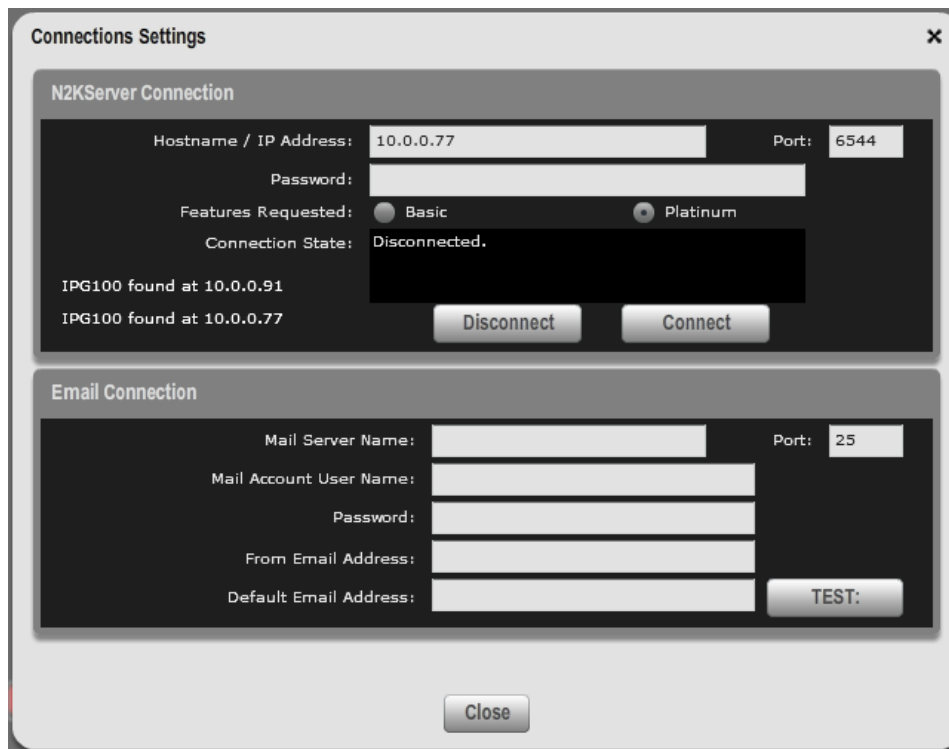

Figure 13 – Connections Settings Dialog

- c. Ensure that N2KView[®] is not connected to a N2KServer[®] by pressing the “**Disconnect**” button. While N2KView[®] is connected you are not able to edit fields.
- d. In the “**Hostname / IP Address:**” text box, enter the IP address of the computer or IPG100 running N2KServer[®]. If your MBB100 configuration has been programmed to match your LAN, the left side of the N2KServer[®] Connection window will display the address of any N2KServer[®] running on a PC or IPG100’s found on the LAN.
- e. Leave the “**Port:**” setting at the initial value of “6544” unless the router between N2KView[®] and N2KServer[®] has been set up to do port translation.
- f. In the “**Password:**” text box, enter the same server password that you entered into the N2KServer[®] Service Manager (for N2KServer[®] running on a PC), or programmed into the IPG100.
- g. If you have purchased the Platinum Edition of N2KView[®] and wish to use all of the Platinum Edition features, select “Platinum” from “Features Requested:”. If you have purchased the Basic Edition of N2KView[®] or you wish to use only the BasicEdition subset of features of N2KView[®] (leaving the Platinum Edition features available for another copy of N2KView[®]), select “Basic” from “**Features Requested:**”.
- h. Click “**Connect**”. The “**Connection State:**” part of the window will blink “Connecting...” for a few seconds. It will then either display “Connected” if the connection was successfully made, or display a message indicating that the connection was not made and suggesting further action to take.

If no data is displayed, please check the following:

1. Make sure the “**Server Password**” entered in N2KView® matches the “**Server Password**” entered into the N2KServer® Service Manager on the computer running N2KServer®, or the IPG100, as appropriate. If the server is running on an IPG100, the password in the IPG100 is set from a DSM250 or N2KAnalyzer®.
2. Make sure the “**Server Address**” matches the IP address of the computer or IPG100 running N2KServer®.
3. Make sure you have appropriate instruments on the NMEA 2000® network to provide the data you are trying to view on the N2KView® screen. (To test the network connection between N2KView® and the N2KServer®, you may wish to run N2KServer® in “**Simulated Data**” mode).
4. Make sure that the instances that are being monitored correspond to the instances being transmitted. You can set the instance number of the component to “Any” to make sure that there is any data of that type on the bus.

3 Operating the MBB100

3.1 Turning the MBB100 On

To turn on the MBB100, press the power switch, located on the right hand side of the front panel of the MBB100.

3.2 Turning the MBB100 Off

To turn the MBB100 off, use the “Shutdown” administrative tab of the N2KView[®] software. Alternatively, you can power down the unit by pressing the MBB100's power switch. Lastly, you can power down the unit by turning of the power source with an external breaker or external switch.

3.3 Using the MBB100

The MBB100 runs a fully functional version of the Maretron N2KView[®] software. Please refer to the *N2KView[®] User's Manual*, packaged with the MBB100, for detailed operating instructions.

4 Maintenance

Regular maintenance is important to ensure continued proper operation of the Maretron MBB100. Perform the following tasks periodically:

- Clean the unit with a soft cloth. Do not use chemical cleaners as they may remove paint or markings or may corrode the MBB100 enclosure or seals. Do not use any cleaners containing acetone, as they will deteriorate the plastic enclosure. Do not spray cleaning liquids directly onto the MBB100.
- Ensure that the unit is mounted securely and cannot be moved relative to the mounting surface. If the unit is loose, tighten the mounting screws.
- Check the security of the power and network cables connected to the MBB100 and tighten if necessary.

5 Troubleshooting

If you notice unexpected operation of the Maretron MBB100, follow the troubleshooting procedures in this section to remedy simple problems.

Symptom	Troubleshooting Procedure
No activity on the display	Check the connection to the power and network connectors and tighten if necessary Ensure that power is supplied to the connected power cable. Check the connection to the power jack located on the rear of the device. Press the power switch located on the front of the device on the right-hand side.
Other Issues	Please refer to the Troubleshooting section of the <i>N2KView® User's Manual</i> .

If these steps do not solve your problem, please contact Maretron Technical Support (refer to Section 0 for contact information).

Warning: There are no user-serviceable components inside the Maretron MBB100. Opening the MBB100 will expose the sensitive electronic components to adverse environmental conditions that may render the unit inoperative. Please do not open the MBB100, as this will automatically void the warranty. If service is required, please return the unit to an authorized Maretron service location.

6 Technical Specifications

Specifications

Parameter	Value	Comment
Video Connector	One VGA Port (RGB or D-sub 15)	For Monitor Connection
USB Connector	Four USB 2.0 connections	For connecting Peripherals (Mouse, keyboard, etc.) and or touch screen connectivity
Serial Connector	One RS232 9-Pin D Connector	For touch screen alternative connection
Ethernet Connector	One RJ-45 GbE	For connection to Maretron IPG100 Gateway and/or router
Audio Connection	One Speaker Output	

Certifications

Parameter	Comment
FCC class A and CE Mark	Electromagnetic Compatibility

Electrical

Parameter	Value	Comment
Operating Voltage	9 to 36 Volts	DC Voltage
Power Consumption (Maximum)	19 Watts	

Mechanical

Parameter	Value	Comment
Overall Dimensions (DxWxH)	5.19" x 9.02" x 2.52" (132mm x 229mm x 64mm)	Including Flanges for Mounting
Weight	4.6 lbs (2.1kg)	
Chassis Material	Aluminum	
Mounting	VESA 100 or DIN	Any Orientation

Environmental

Parameter	Value
Operating Temperature	-10°C to 60°C
Operating Shock	Half-sine wave shock 3G; 11 ms; 3 shocks per axis
Vibration	MIL-STD-810F 514.5C-2

7 Technical Support

If you require technical support for Maretron products, you can reach us in any of the following ways:

Telephone: 1-866-550-9100

Fax: 1-602-861-1777

E-mail: support@maretron.com

World Wide Web: <http://www.maretron.com>

Mail: Maretron, LLP

Attn: Technical Support

9014 N. 23rd Ave Suite 10

Phoenix, AZ 85021 USA

8 Maretron (2 Year) Limited Warranty

Maretron warrants the MBB100 to be free from defects in materials and workmanship for two (2) years from the date of original purchase. If within the applicable period any such products shall be proved to Maretron's satisfaction to fail to meet the above limited warranty, such products shall be repaired or replaced at Maretron's option. Purchaser's exclusive remedy and Maretron's sole obligation hereunder, provided product is returned pursuant to the return requirements below, shall be limited to the repair or replacement, at Maretron's option, of any product not meeting the above limited warranty and which is returned to Maretron; or if Maretron is unable to deliver a replacement that is free from defects in materials or workmanship, Purchaser's payment for such product will be refunded. Maretron assumes no liability whatsoever for expenses of removing any defective product or part or for installing the repaired product or part or a replacement therefore or for any loss or damage to equipment in connection with which Maretron's products or parts shall be used. With respect to products not manufactured by Maretron, Maretron's warranty obligation shall in all respects conform to and be limited to the warranty actually extended to Maretron by its supplier. The foregoing warranties shall not apply with respect to products subjected to negligence, misuse, misapplication, accident, damages by circumstances beyond Maretron's control, to improper installation, operation, maintenance, or storage, or to other than normal use or service.

THE FOREGOING WARRANTIES ARE EXPRESSLY IN LIEU OF AND EXCLUDES ALL OTHER EXPRESS OR IMPLIED WARRANTIES, INCLUDING BUT NOT LIMITED TO THE IMPLIED WARRANTIES OF MERCHANTABILITY AND OF FITNESS FOR A PARTICULAR PURPOSE.

Statements made by any person, including representatives of Maretron, which are inconsistent or in conflict with the terms of this Limited Warranty, shall not be binding upon Maretron unless reduced to writing and approved by an officer of Maretron.

IN NO CASE WILL MARETRON BE LIABLE FOR INCIDENTAL OR CONSEQUENTIAL DAMAGES, DAMAGES FOR LOSS OF USE, LOSS OF ANTICIPATED PROFITS OR SAVINGS, OR ANY OTHER LOSS INCURRED BECAUSE OF INTERRUPTION OF SERVICE. IN NO EVENT SHALL MARETRON'S AGGREGATE LIABILITY EXCEED THE PURCHASE PRICE OF THE PRODUCT(S) INVOLVED. MARETRON SHALL NOT BE SUBJECT TO ANY OTHER OBLIGATIONS OR LIABILITIES, WHETHER ARISING OUT OF BREACH OF CONTRACT OR WARRANTY, TORT (INCLUDING NEGLIGENCE), OR OTHER THEORIES OF LAW WITH RESPECT TO PRODUCTS SOLD OR SERVICES RENDERED BY MARETRON, OR ANY UNDERTAKINGS, ACTS OR OMISSIONS RELATING THERETO.

Maretron does not warrant that the functions contained in any software programs or products will meet purchaser's requirements or that the operation of the software programs or products will be uninterrupted or error free. Purchaser assumes responsibility for the selection of the software programs or products to achieve the intended results, and for the installation, use and results obtained from said programs or products. No specifications, samples, descriptions, or illustrations provided Maretron to Purchaser, whether directly, in trade literature, brochures or other documentation shall be construed as warranties of any kind, and any failure to conform with such specifications, samples, descriptions, or illustrations shall not constitute any breach of Maretron's limited warranty.

Warranty Return Procedure:

To apply for warranty claims, contact Maretron or one of its dealers to describe the problem and determine the appropriate course of action. If a return is necessary, place the product in its original packaging together with proof of purchase and send to an Authorized Maretron Service Location. You are responsible for all shipping and insurance charges. Maretron will return the replaced or repaired product with all shipping and handling prepaid except for requests requiring expedited shipping (i.e. overnight shipments). Failure to follow this warranty return procedure could result in the product's warranty becoming null and void.

Maretron reserves the right to modify or replace, at its sole discretion, without prior notification, the warranty listed above. To obtain a copy of the then current warranty policy, please go to the following web page:

<http://www.maretron.com/company/warranty.php>