

Dell PowerEdge
RAID Controller (PERC) S100,
PERC S300
User's Guide



Notes, Cautions, and Warnings



NOTE: A NOTE indicates important information that helps you make better use of your computer.



CAUTION: A CAUTION indicates potential damage to hardware or loss of data if instructions are not followed.



WARNING: A WARNING indicates a potential for property damage, personal injury, or death.

Information in this publication is subject to change without notice.

© 2008—2011 Dell Inc. All rights reserved.

Reproduction of these materials in any manner whatsoever without the written permission of Dell Inc. is strictly forbidden.

Trademarks used in this text: Dell™, the DELL logo, PowerEdge™, and OpenManage™ are trademarks of Dell Inc. Intel™ is a registered trademark of Intel Corporation in the U.S. and other countries. AMD® is a registered trademark and AMD Opteron™, AMD Phenom™, and AMD Sempron™ are trademarks of Advanced Micro Devices, Inc. Microsoft®, Windows®, and Windows Server® are either trademarks or registered trademarks of Microsoft Corporation in the United States and/or other countries.

Other trademarks and trade names may be used in this publication to refer to either the entities claiming the marks and names or their products. Dell Inc. disclaims any proprietary interest in trademarks and trade names other than its own.

Models: UCS61, UCS60

February 2011

Rev. A01

Contents







1	WARNING: Safety Instructions	7
	SAFETY: General	8
	SAFETY: When Working Inside Your System	8
	Protecting Against Electrostatic Discharge	9
2	Overview	11
	Introduction	11
	General Information, Intended Audience, and Prerequisites for Use	11
	Related Documentation	12
	PERC S100 Adapter or PERC S300 Adapter Descriptions	12
	About RAID	17
	RAID Terminology	18
3	Features	21
	General Features	21
	Specifications	29
4	Hardware Installation	31
	Before You Begin	31

	General Considerations	31
	Installing the PERC S300 Adapter	32
	Connect Physical Disks to the PERC S300 Adapter	35
	Complete the Hardware Installation	35
5	Installing the Drivers	37
	Installing the Microsoft Windows Drivers	37
6	RAID Configuration and Management	47
	Configuring the Controller: Using the PERC Virtual Disk Management Utility	47
7	Troubleshooting	61
	System Startup Problems	61
	Warning Messages: Dell Inc. PERC S100 Adapter or Dell Inc. PERC S300 Adapter BIOS Screen	64
	Virtual Disk-Related Errors	70
	Physical Disk-Related Errors	75
8	Appendix A	77
	Controller Specifications	77
	Controller Tasks	78
	Physical Disk Tasks	78
	Virtual Disk Tasks	79

	Supported RAID Levels	79
	Virtual Disk Specifications	80
9	Appendix B	81
	RAID Technology - Understanding Disk Arrays and Virtual Disks.	81
10	Appendix C	89
	Regulatory Notices	89
	FCC Notice (U.S. Only)	90
	Industry Canada Notice (Canada Only)	92
	CE Notice (European Union)	92
	CE Mark Notice	94
11	Appendix D	95
	Contacting Dell	95
	Index	97
	Glossary	103

WARNING: Safety Instructions

Use the following safety guidelines to help ensure your own personal safety and to help protect your system and working environment from potential damage.

-  **WARNING:** Do not expose the Dell PowerEdge Expandable RAID Controller (PERC) S300 adapter to liquids. To reduce risk of fire hazard, do not cover or obstruct the ventilation openings of the system in which it is installed. Do not install the controller in a zero-clearance compartment. This could result in overheating.
-  **WARNING:** Do not operate the controller if it has been dropped or damaged in any way.
-  **WARNING:** The controller, like every other electronic part of a system, can be damaged by static electricity. Be sure that you are properly grounded. It is recommended that you wear a grounded antistatic strap and that the system is unplugged before you install the controller.
-  **CAUTION:** Cable connectors must be mated carefully with the connectors on the PERC S300 adapter. The connectors are keyed to prevent them from being inserted incorrectly.
-  **CAUTION:** Ensure that the current RAID controller (if any) is not currently working on any pending tasks (such as a rebuild) before it is turned off to conduct a system upgrade.
-  **CAUTION:** During a firmware update, do not reboot the system that contains the PERC S300 adapter. An update might take up to five minutes per controller.

SAFETY: General

Observe and follow service markings:

- Do not service any product except as explained in the user documentation. Opening or removing covers that are marked with a triangular symbol with a lightning bolt might expose you to electrical shock. Components inside these compartments must be serviced only by a trained service technician.
- Use the product only with Dell-approved equipment.
- Operate the product only from the type of external power source indicated on the electrical ratings label. If you are not sure of the type of power source required, consult your service provider or local power company.

SAFETY: When Working Inside Your System

Before you remove the system covers, perform the following steps in the sequence indicated.

 **WARNING: Only trained service technicians are authorized by Dell to remove covers from the system, and access any of the internal components, unless the Dell documentation expressly states otherwise.**

 **CAUTION: To help avoid possible damage to the system board, wait five seconds after turning off the system before disconnecting the controller.**

- 1 Turn off the system and any devices.
- 2 Wear grounding straps that are properly grounded before touching anything inside the system.
- 3 While you work, periodically touch an unpainted metal surface on the chassis to dissipate any static electricity that might harm internal components.
- 4 Disconnect your system and devices from their power sources. To reduce the potential of personal injury or shock, disconnect any telecommunication lines from the system.

In addition, take note of these safety guidelines when appropriate:

- When you disconnect any cable, pull on its connector or on its strain-relief loop, not on the cable itself. Some cables have a connector with locking tabs. If you are disconnecting this type of cable, press in on the locking tabs before disconnecting the cable. As you pull connectors apart, keep them evenly aligned to avoid bending any connector pins. Also, before you connect a cable, make sure that both connectors are correctly oriented and aligned.
- Handle the controller with care. Do not touch the components or contacts on the controller.

Protecting Against Electrostatic Discharge

Electrostatic discharge (ESD) events can harm electronic components inside your system. ESD, or electrostatic discharge, is the process by which static electricity can build up within a person or an object, and then discharge into another object. ESD events can harm your PERC S300 adapter, your system, and other electrical components. To prevent ESD damage, you must discharge static electricity from your body before you interact with any of the system's internal electronic components. You can protect against ESD by touching a metal grounded object (such as an unpainted metal surface on your system's I/O panel) before you interact with anything electronic. In addition, as you work inside the system, periodically touch an I/O connector to remove any static charge your body might have accumulated.

You can also take the following steps to prevent damage from electrostatic discharge:

- When unpacking the controller from its shipping carton, do not remove the controller from the antistatic packing material until you are ready to install it. Just before unwrapping the antistatic package, be sure to discharge static electricity from your body.
- Handle all electrostatic sensitive components in a static-safe area. If possible, use anti-static floor pads and work bench pads.

Overview

Introduction

The Dell PowerEdge RAID Controller (PERC) S300 provides an integrated software RAID solution for Dell PowerEdge Value Servers. The PERC S300 controllers support SAS and SATA interfaces. Containing two internal connectors with four ports each, the PERC S300 adapter features eight ports for connecting drives with a maximum burst speed of up to 3 Gbps per port.

The PERC S100 adapter is targeted as a low-cost RAID solution for Dell PowerEdge Value Servers. The PERC S100 adapter solution supports SATA Hard Disk Drives (HDD) and Solid State Disk (SSD) drives. The PERC S100 adapter requires no additional hardware; it runs from the I/O Controller HUB (ICH) or Platform Controller Hub (PCH) chipset on the platform motherboard.

The PERC S100 adapter and PERC S300 adapter offer the same RAID level support and functionality, including the support of up to eight physical drives.

General Information, Intended Audience, and Prerequisites for Use

This document provides information about:

- The PERC S100 adapter and PERC S300 adapter, including server, operating system, and software support
- Controller configuration and startup procedures
- Controller operating modes

This document is intended for use by system administrators and technicians who are familiar with the storage system installation and configuration.

Prerequisites for configuring and using the controller include familiarity with:

- Servers and computer networks
- RAID technology
- Storage-interface technology, such as SAS and SATA

Related Documentation

For more information about the PERC S100 adapter or PERC S300 adapter and its relationship to the Dell OpenManage Server Administrator Storage Management documentation, see the Storage Management documentation available on the Dell Support website at support.dell.com/manuals.

PERC S100 Adapter or PERC S300 Adapter Descriptions

The following list describes each type of controller:

- The PERC S300 Adapter has two internal connectors with x4 SAS ports.
- The PERC S300 Modular has two internal connectors with x4 SAS ports.
- The PERC S100 adapter runs on the ICH or PCH chipset on the platform motherboard.

Supported Platforms

Table 2-1. Dell Systems and Support Matrix for the PERC S100 Adapter and PERC S300 Adapter

PowerEdge Server	PERC Controller, with Chipset and Adapter Support per Platform
PowerEdge R210	PERC S100 adapter – Intel Ibex Peak chipsets PERC S300 adapter – Dell 3Gb/s SAS Adapter
PowerEdge R210 II	PERC S100 adapter – Intel Cougar Point chipsets PERC S300 adapter – Dell 3Gb/s SAS Adapter
PowerEdge R310	PERC S100 adapter – Intel Ibex Peak chipsets PERC S300 adapter – Dell 3Gb/s SAS Modular
PowerEdge R410	PERC S100 adapter – Intel ICH10R chipsets PERC S300 adapter – Dell 3Gb/s SAS Modular
PowerEdge R415	PERC S300 adapter – Dell 3Gb/s SAS Modular, AMD SP5100 South Bridge chipsets
PowerEdge R510	PERC S100 adapter – Intel ICH10R chipsets, PERC S300 adapter – Dell 3Gb/s SAS Adapter
PowerEdge R515	PERC S300 adapter – Dell 3Gb/s SAS Adapter, AMD SP5100 South Bridge chipsets
PowerEdge T110	PERC S100 adapter – Intel Ibex Peak chipsets PERC S300 adapter – Dell 3Gb/s SAS Adapter
PowerEdge T110 II	PERC S100 adapter – Intel Cougar Point chipsets PERC S300 adapter – Dell 3Gb/s SAS Adapter
PowerEdge T310	PERC S100 adapter – Intel Ibex Peak chipsets PERC S300 adapter – Dell 3Gb/s SAS Adapter
PowerEdge T410	PERC S100 adapter – Intel ICH10R chipsets PERC S300 adapter – Dell 3Gb/s SAS Adapter

Platform Requirements for the PERC S100 Controller and PERC S300 Controller

Table 2-2. Platform Requirements — PERC S100 Controller or PERC S300 Controller

Component	Requirements
Processor	x86, 32-bit compatible processor greater than 500 MHz.
Memory	512 MB or greater.
Physical disk	<p>At least one Hard Disk Drives (HDD) or Solid State Disk (SSD) Drives.</p> <p>NOTE: The PERC S100 controller supports cabled configurations of up to 4 SATA HDD or 4 SATA SSD physical disks. The PERC S300 controller supports cabled or hot-swap configurations of up to 8 SATA or SAS HDD physical disks.</p> <ul style="list-style-type: none">• SATA-II HDD physical disks can be used with a PERC S100 adapter or a PERC S300 adapter.• SATA-II SSD physical disks can be used only with a PERC S100 adapter.• SAS HDD physical disks can be used only with a PERC S300 adapter.
Ports	<ul style="list-style-type: none">• The S300 Adapter has two 8470-type internal SAS connectors on the adapter card. Each mini-SAS connector supports 4 SAS/SATA ports.• The S300 Modular typically plugs into a backplane that has a single 8470-type SAS connector (except for PERC S300 adapters on an R210 or T110, whose cables plug directly into the physical disks).
Available slots	The PERC S300 Adapter and PERC S300 Modular cards plug into 8-lane Peripheral Component Interconnect Express (PCI-E) slots.

Table 2-2. Platform Requirements — PERC S100 Controller or PERC S300 Controller

Component	Requirements
Operating systems	<ul style="list-style-type: none">• Microsoft Windows Essential Business Server (x64)• Microsoft Windows Server 2008 Datacenter Edition (x64)• Microsoft Windows Server 2008 Enterprise Edition (x64)• Microsoft Windows Server 2008 Enterprise Edition (x86)• Microsoft Windows Server 2008 Foundation• Microsoft Windows Server 2008 HPC Edition• Microsoft Windows Server 2008 R2 Datacenter• Microsoft Windows Server 2008 R2 Datacenter SP1• Microsoft Windows Server 2008 R2 Enterprise• Microsoft Windows Server 2008 R2 Enterprise SP1• Microsoft Windows Server 2008 R2 Foundation• Microsoft Windows Server 2008 R2 Foundation SP1• Microsoft Windows Server 2008 R2 HPC Edition• Microsoft Windows Server 2008 R2 Standard• Microsoft Windows Server 2008 R2 Standard SP1• Microsoft Windows Server 2008 SP2 Datacenter Edition (x64)• Microsoft Windows Server 2008 SP2 Enterprise Edition (x64)• Microsoft Windows Server 2008 SP2 Enterprise Edition (x86)• Microsoft Windows Server 2008 SP2 Standard Edition (x64)• Microsoft Windows Server 2008 SP2 Standard Edition (x86)• Microsoft Windows Server 2008 SP2 Web Edition (x64)• Microsoft Windows Server 2008 SP2 Web Edition (x86)• Microsoft Windows Server 2008 Standard Edition (x64)• Microsoft Windows Server 2008 Standard Edition (x86)• Microsoft Windows Server 2008 R2, 64-bit, Standard and Enterprise Edition• Microsoft Windows Server 2008 64-bit Web Edition

Table 2-2. Platform Requirements — PERC S100 Controller or PERC S300 Controller

Component	Requirements
	<ul style="list-style-type: none">• Microsoft Windows Server 2008 Web Edition (x64)• Microsoft Windows Server 2008 Web Edition (x86)• Microsoft Windows Small Business Server 2008• Microsoft Windows Small Business Server 2008 SP2• Microsoft Windows Small Business Server 2003 R2 SP2 (x86 or x64)• Microsoft Windows Small Business Server 2011• Microsoft Windows Web Server 2008 R2• Microsoft Windows Web Server 2008 R2 SP1• Microsoft Windows Server 2003 SP2 (x86 or x64)• Microsoft Windows Server 2003 R2 SP2, 32-bit or 64-bit, Standard and Enterprise Edition• Microsoft Windows Server 2003 R2 SP2 32-bit Web Edition• Microsoft Windows Server 2008 SP2, 32-bit or 64-bit, Standard and Enterprise Edition
	<p>NOTE: Microsoft Windows Server 2003 SP1 is not supported.</p>
	<p>NOTE: Microsoft Windows Server 2003 R2 is not supported.</p>
	<p>NOTE: PERC S100 controllers and PERC S300 controller are not supported with Windows Hyper-V.</p>
Supported devices	<ul style="list-style-type: none">• PERC S100 adapter: supports Dell-supported SATA-based tape devices and SATA optical disk devices.
	<p>NOTE: The PERC S100 controller supports system boot to a tape using a Dell RD1000 tape device. Select Continue while in CTRL-R for RD1000 to remain first in the boot order. The RD1000 option goes to end of the boot order listing if <Ctrl><Alt> is selected and you would not be able to boot to it.</p>
	<ul style="list-style-type: none">• PERC S300 adapter: does not support tape devices or SATA optical disk devices.

About RAID

A RAID disk array is a group of independent physical disks that provides high performance by increasing the number of drives used for saving and accessing data. A RAID disk subsystem improves I/O performance and data availability. The physical disks appear to the host system either as a single storage unit or multiple logical units. Data throughput improves because several disks are accessed simultaneously. RAID systems also improve data storage availability and fault tolerance. Data loss caused by a physical disk failure can be recovered by rebuilding missing data from the remaining physical disks containing data or parity.



NOTE: When a physical disk in a RAID 0 virtual disk fails, data is lost because there is no redundancy for this RAID level. However, when a physical disk in a RAID 1, RAID 5, or RAID 10 fails, data is preserved because there is redundancy with these RAID levels.

Summary of RAID Levels

- Volume uses available space on a single physical disk and forms a single logical volume on which data is stored.
- RAID 0 uses disk striping to provide high data throughput, especially for large files in an environment that requires no data redundancy.
- RAID 1 uses disk mirroring so that data written to one physical disk is simultaneously written to another physical disk. RAID 1 is good for small databases or other applications that require small capacity but also complete data redundancy.
- RAID 5 uses disk striping and parity data across all physical disks (distributed parity) to provide high data throughput and data redundancy.
- RAID 10 uses disk striping across two mirrored sets. It provides high data throughput and complete data redundancy.

RAID Terminology

Disk Striping

Disk striping allows you to write data across multiple physical disks instead of just one physical disk. Disk striping involves partitioning each physical disk storage space into stripes of the various sizes. These stripes are interleaved in a repeated sequential manner. The part of the stripe on a single physical disk is called a stripe element.

For example, in a four-disk system using only disk striping (used in RAID level 0), segment 1 is written to disk 1, segment 2 is written to disk 2, and so on. Disk striping enhances performance because multiple physical disks are accessed simultaneously, but disk striping does not provide data redundancy.

Figure 2-1 shows an example of disk striping.

Figure 2-1. Example of Disk Striping (RAID 0)

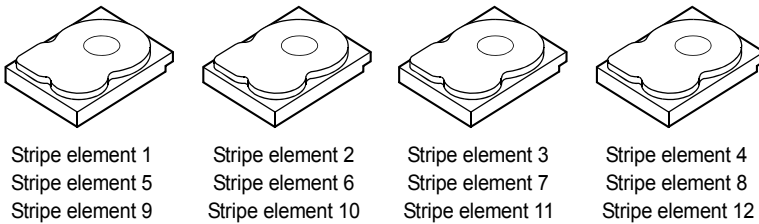

Disk Mirroring

With mirroring (used in RAID 1), data written to one disk is simultaneously written to another disk. If one disk fails, the contents of the other disk can be used to run the system and rebuild the failed physical disk. The primary advantage of disk mirroring is that it provides 100 percent data redundancy. Because the contents of the disk are completely written to a second disk, it does not matter if one of the disks fails. Both disks contain a copy of the same data at all times. Either of the physical disks can act as the operational physical disk. Disk mirroring provides 100 percent redundancy, but is expensive because each physical disk in the system must be duplicated.

Figure 2-2 shows an example of disk mirroring.

 **NOTE:** Mirrored physical disks improve read performance by read load balancing.

 **NOTE:** The PERC S300 controller only supports physical disks (SAS and SATA). SSD devices cannot be migrated to a PERC S300 controller.

Figure 2-2. Example of Disk Mirroring (RAID 1)



Spanned RAID Levels

Spanning is a term used to describe the way in which RAID level 10 is constructed from multiple sets of simpler RAID levels. For example, a RAID 10 has multiple sets of RAID 1 disk arrays in which each RAID 1 set is considered a span. Data is then striped (as it is in RAID 0) across the RAID 1 spans to create a RAID 10 virtual disk.

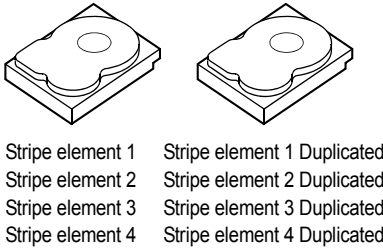
Parity Data

Parity data is redundant data that has been generated to provide fault tolerance within certain RAID levels. In the event of a drive failure, the parity data can be used by the controller to regenerate user data. Parity data is present only for RAID 5 disk arrays.

The parity data is distributed across all the physical disks in the system. If a single physical disk fails, it can be rebuilt from the parity and the data on the remaining physical disks. RAID 5 combines distributed parity with disk striping, as shown in Figure 2-3. Parity provides redundancy for one physical disk failure without duplicating the contents of entire physical disks.

Figure 2-3. Example of Distributed Parity (RAID 5)

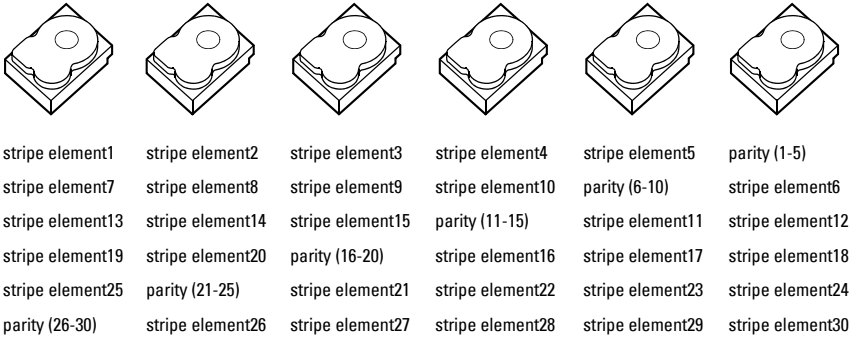

Features

General Features

The features of the Dell PowerEdge RAID Controller (PERC) S100 and PERC S300 adapter are described in Table 3-1.



NOTE: BAS, BGI, CC and OCE run only on the operating system.

Table 3-1. Features of the PERC S100 controller and PERC S300 controller

RAID Controller Feature	Description
Automatic virtual disk rebuild	Rebuilds a redundant virtual disk automatically when a failure is detected, if a hot spare is assigned for this capability.
Background Array Scan (BAS)	Verifies and corrects correctable media errors on mirror, volume, or parity data for virtual disks. BAS starts automatically after a Virtual Disk is created while in the OS.
Background virtual disk initialization (BGI)	<p>The background initialization of a redundant virtual disk creates the parity data that allows the virtual disk to maintain its redundant data and survive a physical disk failure.</p> <p>Because background initialization helps the controller to identify and correct problems that might occur with the redundant data at a later time, background initialization is similar to a consistency check.</p> <p>Background initialization allows a redundant virtual disk to be used immediately. Data is lost if a physical disk fails before the completion of a BGI.</p> <p>NOTE: Although a BGI is software-initiated at the PERC Virtual Disk Management utility, the PERC S100 adapter/PERC S300 adapter drivers must be loaded before the BGI runs.</p> <p>NOTE: Unless mentioned otherwise, the term PERC Virtual Disk Management utility refers to both the PERC S100 Virtual Disk Management utility and the PERC S300 Virtual Disk Management utility.</p>

Table 3-1. Features of the PERC S100 controller and PERC S300 controller (continued)

RAID Controller Feature	Description
Boot support for RAID levels	Allows boot support for Volume, RAID 0, RAID 1, RAID 5, and RAID 10.
Boot support for degraded virtual disks	Enables the system to boot from degraded redundant virtual disks (RAID 1, RAID 5, or RAID 10).
Cache support for virtual disks	Supports these cache options: None , Read Only , Read/Write . The PERC S100 adapter or PERC S300 adapter uses part of system memory for cache.
Checkpointing	<p>Allows different types of checkpointing (background initialization, consistency check, and rebuild) to resume at the last point following a restart.</p> <p>After the system restarts, background checkpointing resumes at its most-recent checkpoint.</p>
Command queuing	<p>Command queuing is a command protocol used by SATA and SAS physical disks that is supported by the PERC S100 adapter and PERC S300 adapter.</p> <p>Command queuing allows the host to issue multiple input/output requests to a disk simultaneously. The disk can then decide in which order to process the commands to achieve maximum performance.</p> <p>The SATA and SAS versions of command queuing have slightly different protocols and means of handling multiple traffic requests at the same time, but the end-purposes are comparable.</p>

Table 3-1. Features of the PERC S100 controller and PERC S300 controller (continued)

RAID Controller Feature	Description
Consistency check (CC)	<p>A consistency check is a background operation that verifies and corrects the mirror or parity data for fault-tolerant physical disks. It is recommended that you periodically run a consistency check on the physical disks.</p> <p>By default, a consistency check corrects mirror or parity inconsistencies. After the data is corrected, the data on the primary physical disk in a mirror set is assumed to be the correct data and is written to the secondary physical disk in the mirror set.</p> <p>A consistency check cannot be user-initiated in the PERC Virtual Disk Management utility. However, a consistency check can user-initiated when using Dell OpenManage Server Administrator Storage Management.</p>
Disk initialization	<p>For physical disks, initialization writes metadata to the physical disk, so that the controller can use the physical disk.</p>
Fault tolerance	<p>The following fault tolerance features are available with the PERC S100 adapter and PERC S300 adapter, in order to prevent data loss in case of a failed physical disk:</p> <ul style="list-style-type: none">• Physical disk failure detection (automatic).• Virtual disk rebuild using hot spares (automatic, if the hot spare is configured for this functionality).• Parity generation and checking (RAID 5 only).• Hot-swap manual replacement of a physical disk without rebooting the system (only for systems with a backplane that allows hot-swapping). <p>If one side of a RAID 1 (mirror) fails, data can be rebuilt by using the physical disk on the other side of the mirror.</p> <p>If a physical disk in RAID 5 fails, parity data exists on the remaining physical disks, which can be used to restore the data to a new, replacement physical disk configured as a hot spare.</p> <p>If a physical disk fails in RAID 10, the virtual disk remains functional and data is read from the surviving mirrored physical disk(s). A single disk failure in each mirrored set can be sustained, depending on how the mirrored set fails.</p>

Table 3-1. Features of the PERC S100 controller and PERC S300 controller (continued)

RAID Controller Feature	Description
Mirror rebuilding	A broken mirror can be rebuilt after a new physical disk is inserted and the physical disk is designated as a hot spare. The system does not have to be rebooted.
Online Capacity Expansion (OCE)	<p>OCE is a process that allows you to add storage capacity to an existing virtual disk. In most cases additional storage capacity can be added without taking the system offline. However, if an additional physical disk needs to be added and the system does not support hot-swapping, the system must be turned off.</p> <p>OCE enables you to increase the total storage capacity of a virtual disk by integrating unused storage with the virtual disk.</p> <p>Data can be accessed while the physical disks are added (if a system has hot-swap capability) and while data on the virtual disk is being redistributed.</p> <p>For Volume and RAID 1, OCE expands the virtual disk by using the available space of the physical disks that are already members of the virtual disk. For RAID 0, RAID 5 and RAID 10, additional capacity can be attained by adding physical disks to the virtual disk.</p>
Physical disks (general)	<p>The PERC S100 adapter supports up to four SATA HDD or SSD physical disks. The PERC S300 adapter supports up to eight SAS or SATA HDD physical disks.</p> <p>NOTE: The physical disks in a virtual disk must be the same interface and drive type (HDD or SSD). For example, you cannot mix a SATA and SAS interface (HDD or SSD), or HDD and SSD physical disks, in the same virtual disk.</p> <p>A maximum of eight physical disks can be used for RAID 0 and RAID 5. A maximum of two physical disks can be used for RAID 1. A maximum of four physical disks can be used for RAID 10.</p> <p>If a physical disk fails during system startup, the controller identifies the failed physical disk as follows:</p> <ul style="list-style-type: none">• At the PERC Virtual Disk Management utility by highlighting the failed physical disk in a virtual disk in red.

Table 3-1. Features of the PERC S100 controller and PERC S300 controller (continued)

RAID Controller Feature	Description
	<ul style="list-style-type: none"> • In a brief warning at the Dell Inc. PERC S100 Controller BIOS or Dell Inc. PERC S300 Controller BIOS screen, that a virtual disk(s) were found that are Degraded and/or Failed. This alerts the user to the failed physical disk(s). • At Dell OpenManage Server Administrator Storage Management. • With a bi-color Status LED on each physical disk. The green element of the Status LED is off, while the amber element flashes on and off. <p>NOTE: The Status LED applies only to systems with a PERC S300 adapter and a backplane that has removable physical disks.</p> <p>NOTE: PERC S100 adapters support HDD physical disks of capacity 2 TB and greater. Current and upcoming releases of PERC S300 adapters will only support upto 2 TB HDD physical disks .</p>
Physical disk hot-swapping (hot-swap capability)	<p>Hot-swap (hot-plug) capability is the manual substitution of a physical disk for another one while the host system is powered on.</p> <p>If a system supports hot-swapping, physical disks can be plugged into a system’s backplane while the controller is operating, without causing the controller to reset.</p> <p>CAUTION: A physical disk can be hot-swapped from a system only if the system has a PERC S300 adapter and a backplane that supports hot-swapping.</p> <p>NOTE: If a system’s physical disks are accessible only when the system’s cover is removed, the physical disks cannot be hot-swapped. The physical disks must be located on the backplane (behind the removable front panel) and accessible externally.</p> <p>NOTE: When replacing physical disks in a virtual disk that has already been created, make sure that SAS HDD physical disks are replaced with SAS HDD physical disks, that SATA HDD physical disks are replaced with SATA HDD physical disks, and that SATA SSD physical disks are replaced with SATA SSD physical disks.</p> <p>NOTE: When hot-swapping a physical disk, make sure that the new disk is of equal or greater capacity to the physical disk that is being replaced.</p>

Table 3-1. Features of the PERC S100 controller and PERC S300 controller (continued)

RAID Controller Feature	Description
Physical disk roaming	<p>The controller supports moving a physical disk from one backplane slot or cable connection to another (on the same controller). The controller automatically recognizes the repositioned physical disk and logically places it in the proper order.</p> <p> WARNING: A virtual disk is lost if you perform disk roaming while an OCE is running at Storage Management.</p> <p>NOTE: For more information on how to open the system and add parts, see the <i>Hardware Owner's Manual</i>, available on the Dell Support website at support.dell.com/manuals.</p> <p>Perform the following steps for physical disk roaming:</p> <p>NOTE: These steps do not apply to systems that have a backplane with hot-swap capability.</p> <ol style="list-style-type: none">1 Turn off the power to the system, physical disks, and system components.2 Disconnect the power cables from the system.3 Move the physical disks to different slots on the backplane or to different cable connections.4 Perform a safety check. Make sure the physical disks are inserted properly.5 Connect the power cables and power up the system. <p>NOTE: The controller detects the RAID configuration from the configuration data on the physical disks.</p>
Storage port (Storport) driver support	<p>For use with Microsoft Windows Server 2003 and later, the Storport driver improves throughput and miniport driver interfaces.</p>
Stripe size	<p>Stripe size is determined by a PERC S100 adapter/PERC S300 adapter algorithm. Stripe size cannot be configured by the user.</p>

Table 3-1. Features of the PERC S100 controller and PERC S300 controller (continued)

RAID Controller Feature	Description
Virtual disks (general)	<p>Up to eight virtual disks are supported.</p> <p>The PERC S100 adapter and PERC S300 adapter allows:</p> <ul style="list-style-type: none">• Creating virtual disks of different RAID levels on a single controller.• Creating different RAID level virtual disks on the same physical disk, to adapt each virtual disk to the I/O that it processes.• Building different virtual disks with different characteristics for different applications. <p>The PERC S100 adapter and PERC S300 adapter does not allow:</p> <ul style="list-style-type: none">• Creating a virtual disk from a mix of different type physical disks. For example, a RAID 10 virtual disk cannot be created from two SATA-II HDD physical disks, a SAS HDD physical disk, and a SSD physical disk. All of the physical disks must be the same interface (SAS or SATA) and drive type (HDD or SSD).• Selecting a physical disk as a dedicated hot spare if the physical disk is a different type from the physical disk or disks. <p>A virtual disk refers to data storage created by the controller from one or more physical disks. Although a virtual disk can be created from several physical disks, it is seen by the operating system as a single disk.</p> <p>The capacity of a virtual disk can be expanded online for any RAID level, without the operating system being rebooted.</p>

Table 3-1. Features of the PERC S100 controller and PERC S300 controller (continued)

RAID Controller Feature	Description
Virtual disk migration	<p>The controller supports automatic virtual disk migration from a PERC S100 adapter to a PERC S300 adapter (or vice versa). Manual intervention for migration is not required or used by the PERC S100 adapter or PERC S300 adapter.</p> <p>CAUTION: Before starting a virtual disk migration, power-down both systems before removing or inserting the physical disks. After the migration occurs, make sure that all of the physical disks have been migrated and are present in the virtual disk.</p> <p>CAUTION: The virtual disk is lost if you perform a virtual disk migration during an OCE.</p> <p>NOTE: The PERC S100 adapter only supports SATA HDD and SATA SSD disks. SAS disks cannot be migrated with a PERC S100 adapter.</p> <p>NOTE: A bootable virtual disk cannot be migrated between dissimilar controllers or dissimilar system models when the system uses Microsoft Windows Server 2003 as its operating system.</p>
Virtual disk RAID levels	Virtual disks at different RAID levels can be created.
Virtual disk transformation	<p>Virtual disk transformation can consist of:</p> <ul style="list-style-type: none">• Capacity expansion, using OCE (to allocate additional virtual disk space on the original physical disks or after additional physical disks are added).• Rebuilding (rebuilding data on a virtual disk consists of using an available hot spare or backup physical disk).

Specifications

Table 3-2 compares the specifications of the PERC S100 adapter and PERC S300 adapter.

Table 3-2. Specifications for the PERC S100 adapter and PERC S300 adapter

Specification	PERC S100 adapter	PERC S300 adapter
SAS technology	No	Yes
SATA technology	Yes	Yes
eSATA technology	Yes	No
SSD technology	Yes	No
Support for x8 PCI-E Host Interface	No	Yes
I/O Controller	Intel ICH10R or Intel Ibex Peak chipsets or Intel Cougar Point chipsets	Dell 3Gb/s SAS Adapter
Communication to the system	Integrated	PCI-E lanes
Communication to end devices	SATA links	SAS/SATA links
SAS connectors	No	Two 4-port connectors on all systems
SATA connectors	Discrete on the motherboard	Two 4-port connectors on all systems
Lead-free	Yes	Yes
Supported operating systems	Microsoft Windows Server 2003 Family, Microsoft Windows Server 2008 Family, Microsoft Windows Server 2008 R2	
Dell-compliant SATA compatibility	Yes	Yes
Dell-compliant SAS compatibility	No	Yes
Dell-supported direct-connected end devices	Dell-compliant physical disks	Dell-compliant physical disks
*SMART error support through management applications	Yes	Yes
Backplane supported systems	No	Yes

Table 3-2. Specifications for the PERC S100 adapter and PERC S300 adapter

Specification	PERC S100 adapter	PERC S300 adapter
Software-based RAID	Volume, RAID 1, RAID 0, RAID 5, RAID 10	Volume, RAID 1, RAID 0, RAID 5, RAID 10
Maximum number of virtual disks	8	8
Support for internal tape drive	Yes	No
Support for global hot spare	Yes	Yes
Maximum number of hot spares	Varies (by the number of free disks in the system)	Varies (by the number of free disks in the system)

*SMART is supported under the Windows Driver but is not supported with Unified Extensible Firmware Interface (UEFI) and CTRL-R. The SWRAID SMART drive status shows as "Degraded" in OpenManage Storage Services (OMSS).

Hardware Installation

Before You Begin

This chapter describes how to install the Dell PowerEdge RAID Controller (PERC) S300 adapter.



NOTE: The PERC S100 controller is an integral component of the motherboard. Hardware installation instructions are not required for a system with a PERC S100 controller.

General Considerations



WARNING: Before you begin any of the procedures in this chapter, follow the safety instructions that were shipped with your system. For additional safety information, see the Regulatory Compliance Homepage on dell.com at the following location: dell.com/regulatory_compliance.



WARNING: Electrostatic discharge can damage sensitive components. Always use proper antistatic protection when handling components. Touching components without using a proper ground can damage the equipment.



WARNING: Plug the PERC S300 controller only into a PCI-E slot. Plugging the controller into an incorrect type of slot can potentially destroy the controller, as well as the motherboard.



CAUTION: Before installing a controller in an existing system, back up all critical data. Failure to follow this accepted system management practice could result in a loss of data.

Installing the PERC S300 Adapter

 **NOTE:** The procedure to open a system and add parts might vary from system to system. For more information, see the *Hardware Owner's Manual* of the system on the Dell Support website at support.dell.com/manuals.

- 1 Unpack the PERC S300 Adapter and check it for damage.

 **NOTE:** If the PERC S300 Adapter is damaged, contact Dell Support at support.dell.com.

- 2 Turn off the system and attached peripherals. Disconnect the system power cable from the electrical outlet. See the system's *Hardware Owner's Manual* or *User's Guide* on support.dell.com/manuals for more information about power supplies.
- 3 Disconnect the system from the network and remove the cover of the system. See your system's *Hardware Owner's Manual* or *User's Guide* for more information on opening the system.
- 4 Select an appropriate PCI-E slot. Remove the blank filler bracket on the back of the system aligned with the PCI-E slot you have selected.

 **NOTE:** Insert the controller into a slot that has at least eight PCI-E lanes for optimum performance.

 **NOTE:** Insert the controller into a slot with a PCI-E x8 or larger physical connector.

 **NOTE:** For more information about your system's PCI-E slots, see your system's *Hardware Owner's Manual* or *User's Guide* on the Dell Support website at support.dell.com/manuals.

- 5 Align the PERC S300 Adapter to the PCI-E slot you have selected.
- 6 Insert the controller gently, but firmly, until the controller is firmly seated in the PCI-E slot. See Figure 4-1.
- 7 Tighten the bracket screw, if any, or use the system's retention clips to secure the controller to the system's chassis.

 **NOTE:** If you are attempting to install a Modular PERC S300 refer to the platform documentation for help with the installation.

Figure 4-1. Installing a PERC S300 Adapter



- | | | | |
|---|---------------|---|-------------------|
| 1 | bracket screw | 2 | PERC S300 Adapter |
| 3 | PCI-E slot | 4 | filler bracket |
| 5 | PCI bracket | | |

Figure 4-2. Connecting the Cables

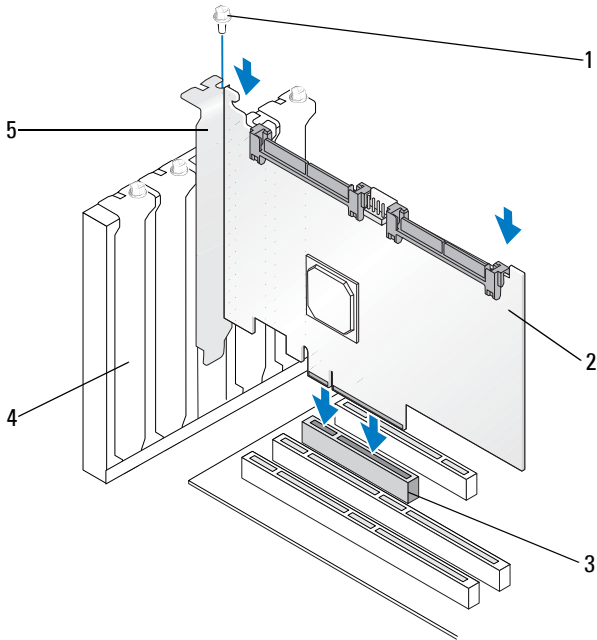
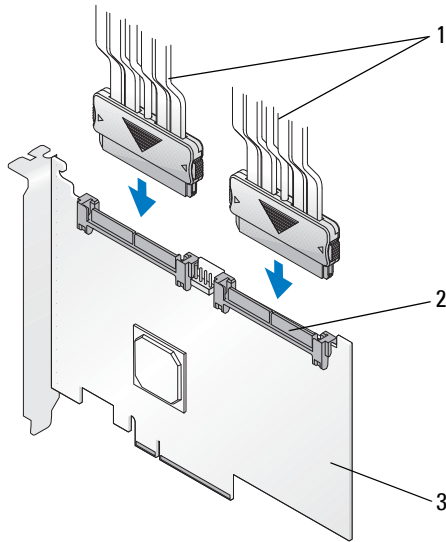



- 1 cables to the physical disks (applies to systems with a PERC S300 adapter) or to backplanes (applies only to systems with a PERC S300 modular)
- 2 SAS/SATA x4 internal connectors (2)
- 3 PERC S300 Adapter

Connect Physical Disks to the PERC S300 Adapter

 **WARNING:** Critical system components might be damaged if the installer is not properly grounded to prevent electrostatic discharge (ESD).

 **NOTE:** Use either the standard power connector or, if available on the power supply, a SATA/SATA II power connector. Do not use both.

 **NOTE:** You can view the physical disk LEDs on a system that uses a PERC S300 controller by removing the front panel from the system.

 **NOTE:** The controller supports a feature that staggers the spinup of each physical disk sequentially. This allows enough time between physical disk starts to prevent the power supply from overloading.

- 1 Install the physical disks into the system.
- 2 Connect a multiple-connector cable from the physical disks (or from the backplane) to the controller.

 **NOTE:** If the system contains a PERC S300 controller and has a backplane with hot-swap capability, the cables cannot be inserted directly into the physical disks. The physical disks (within their carriers) are inserted and seated in the backplane. A cable from the backplane is then connected to the PERC S300 controller.

Complete the Hardware Installation

After the controller and cables are installed, perform the following steps:

- 1 Make sure that the wire bundles and cables inside the system are not twisted. Make sure they do not interfere with fans, power supplies, heat sinks, or electrical devices.
- 2 Replace the cover of the system. See your system's *Hardware Owner's Manual* or *User's Guide* for more information on closing the system.
- 3 Reconnect the power cable(s) and network cables, and then turn on the system.

Installing the Drivers

The Dell PowerEdge RAID Controller (PERC) S100 or PERC S100 adapter require controller drivers to operate with the supported operating systems.

This chapter contains the procedures for installing the controller drivers for the following operating systems:

- Microsoft Windows Server 2008
- Microsoft Windows Server 2008 R2
- Microsoft Windows Server 2003 SP2



NOTE: Microsoft Windows Server 2003 R2 is not supported.

Installing the Microsoft Windows Drivers

Downloading the Controller Driver Media

- 1 Go to support.dell.com/support/downloads.
- 2 Select **Choose by Service Tag**→**Enter a Tag**.
- 3 Enter the **Service Tag** of the system on which you want to install the PERC S100 adapter/PERC S300 adapter drivers and select **Go**.



NOTE: Alternatively, you can select **Choose a Model**→**Select Model**. Navigate to **Servers**, **Storage**, **Networking**→**PowerEdge Server**. Select the model of your system and select **Confirm**.

- 4 Choose the applicable operating system.
- 5 Expand the **SAS RAID Controller** category.
- 6 Select **Download Now** for the appropriate controller driver.



NOTE: Load a blank optical medium (CD-ROM or DVD) in your system.

- 7 Use the blank optical medium to burn the ISO image.
- 8 Download the files for the PERC S100 adapter or PERC S300 adapter to the driver media, as indicated in Figure 5-1.

Table 5-1. Operating System And Device Driver Media

Operating System	Driver Media (CD-ROM, DVD, USB flash drive, or floppy disk) to Use
Windows Server 2008, Windows Server 2008 R2	32-bit or 64-bit: Copy all of the files to a CD-ROM, DVD, USB flash drive, or floppy disk.
Windows Server 2003	32-bit or 64-bit: Copy all of the files to a floppy disk.

NOTE: Windows Server 2003 versions SP1 and older support driver load for operating system installation using a USB key

Pre-Installation Requirements for the Controller Drivers

- Make sure that your system has the latest BIOS and firmware updates from the Dell Support website at support.dell.com/manuals.
- Perform the pre-installation procedures in Table 5-2 before you install the controller drivers and the operating system.
- When you are ready to install the controller drivers and operating system see "Installing the Controller Drivers During the Operating System Installation: For Systems with a PERC S100 Adapter" on page 42 or "Installing the Controller Drivers During the Operating System Installation: For Systems with a PERC S300 Adapter" on page 44.

Table 5-2. Pre-Installation Procedures For The Controller Drivers

Procedure	Steps
1 Confirm or change configuration settings at the <i>Dell PowerEdge System</i> window	<p data-bbox="452 320 1001 376">a Boot the system. When the Dell Power-On Self-Test (POST) screen appears, press <F2>.</p> <p data-bbox="452 384 1001 464">b Wait until the Dell PowerEdge System window appears. Perform the following, depending on the controller:</p> <ul data-bbox="452 480 1001 592" style="list-style-type: none">• For a PERC S100 adapter: Scroll to SATA Settings. Press <Enter>. At the sub-screen, confirm that the SATA Controller is set to a RAID mode. <p data-bbox="423 608 1001 663">NOTE: If necessary, use the space bar to change the setting.</p> <ul data-bbox="452 679 1001 759" style="list-style-type: none">• For a PERC S300 adapter: Scroll to SATA Settings. Press <Enter>. At the sub-screen, set SATA Controller to either ATA Mode or AHCI. <p data-bbox="423 775 1001 831">NOTE: If necessary, use the space bar to change the setting.</p> <p data-bbox="452 847 1001 871">c Press <Esc> to exit.</p> <p data-bbox="452 879 1001 903">d Press <Esc> again. The following occurs:</p> <ul data-bbox="452 919 1001 1070" style="list-style-type: none">• If no change was made at step b, the boot sequence continues.• If a change was made at step b, a dialog box appears. Select Save Changes and Exit. Press <Enter>. The boot sequence continues. <p data-bbox="423 1086 1001 1198">NOTE: If you decide to change from a PERC S100 adapter to a PERC S300 adapter, make sure that you also change the setting at SATA Settings→SATA Controller from a RAID mode to ATA Mode. See step b.</p>
2 Install the PERC S300 adapter (as required)	See "Install the PERC S300" in the <i>Hardware Installation Guide</i> , located on the Dell Support website at support.dell.com/manuals .
3 Initialize physical disks (as required)	See "Initializing Physical Disks" on page 50.

Table 5-2. Pre-Installation Procedures For The Controller Drivers (continued)

Procedure	Steps
4 Create a bootable virtual disk	See "Creating Virtual Disks" on page 51.
5 Check controller options and the boot list priority	<p data-bbox="413 352 960 496">a At the PERC S100 Virtual Disk Management utility or PERC S300 Virtual Disk Management utility, use the arrow keys to select Controller Options. Press <Enter>. Make sure that Toggle INT13 Boot Support is ON. Press <Esc> to exit.</p> <p data-bbox="413 504 960 587">b At the Virtual Disks field, make sure the bootable virtual disk created in Procedure 4, is the first virtual disk listed.</p>

If the bootable virtual disk is not the first virtual disk listed, see "Swapping Two Virtual Disks" on page 55.

NOTE: If Non-Raid virtual disks are used (and appear in the **Virtual Disks** list), the **Swap Two Virtual Disks** option is enabled only if the system contains an initialized physical disk.

c Select **Continue to Boot** and press <Enter>.

NOTE: If the next Procedure (6) is not applicable, continue with one of the following procedures:

- "Installing the Controller Drivers During the Operating System Installation: For Systems with a PERC S100 Adapter" on page 42
- "Installing the Controller Drivers During the Operating System Installation: For Systems with a PERC S300 Adapter" on page 44

Table 5-2. Pre-Installation Procedures For The Controller Drivers (continued)

Procedure	Steps
6 Change the Boot Priority List for Devices (if applicable)	<p>To change the order of the devices (CD-ROM, optical DVD, and so on), perform the following:</p> <p>NOTE: Unless mentioned otherwise, the term PERC Virtual Disk Management utility refers to both the PERC S100 Virtual Disk Management utility and the PERC S300 Virtual Disk Management utility.</p> <p>NOTE: If the PERC Virtual Disk Management utility is open, select Continue to Boot, then press <Enter>. Press <Ctrl><Alt><Delete> to reboot the system.</p> <ul style="list-style-type: none">a Boot the system. When the POST screen appears, press <F2>.b At the Dell PowerEdge System screen, use the arrow keys to scroll to Boot Sequence. Press <Enter>.c Make sure that Hard drive C: is the first device listed.d To change the sequence of other devices:<ul style="list-style-type: none">• Use the <+> key to move devices up, or the <-> key to move devices down.• Use the space bar to enable or disable a device.e Press <Esc> to exit.f Press <Esc> again. Select Save Changes and Exit and press <Enter>. <p>NOTE: Continue with one of the following procedures:</p> <ul style="list-style-type: none">• "Installing the Controller Drivers During the Operating System Installation: For Systems with a PERC S100 Adapter" on page 42• "Installing the Controller Drivers During the Operating System Installation: For Systems with a PERC S300 Adapter" on page 44

Installing the Controller Drivers During the Operating System Installation: For Systems with a PERC S100 Adapter



CAUTION: The latest firmware, drivers and applications must be installed whenever the controller software is upgraded. A previous version of the driver might not work with the latest controller software and vice versa.



NOTE: When using an external USB floppy disk drive, make sure to connect it to the system when the system is turned-off and before starting step 1. Failure to do so might result in the external USB floppy disk drive not being recognized by the system.

- 1 Reboot the system. When the POST screen appears press <F11>.
- 2 Insert the Windows operating system media into the optical drive of the system.
- 3 When the BIOS boot manager or boot device menu appears, select the text that begins with **Embedded SATA** . . . and press <Enter>.
- 4 Install the applicable Microsoft Windows operating system, using the on-screen instructions.
- 5 At the **Select the driver to be installed** window a **Load Driver** sub-screen appears. Perform the following:

For Microsoft Windows Server 2008 and Windows Server 2008 R2:

- a Insert the CD-ROM, DVD, USB flash drive, or floppy disk that contains the files copied at "Downloading the Controller Driver Media" on page 37. Click **Browse**.
- b At the **Browse to folder** window, access the directory that contains the controller driver files. Locate and select the files. Click **OK**.

For Microsoft Windows Server 2003:

- a Insert the floppy disk that contains the files copied at "Downloading the Controller Driver Media" on page 37. (An external USB floppy disk drive can be used, if your system does not have a built-in floppy disk drive).
 - b Press <F6> on the keyboard, when prompted at the beginning of the Windows setup.
 - c Wait until the **Windows Setup** window with **S = Specify Additional Device** appears. Press <S> on the keyboard.
 - d Insert the requested media disk (as applicable) and press <Enter>.
- 6** At the next **Select the driver to be installed** window, select **Dell PERC S100 S300 Controller . . .** Click **Next** to load the driver files.

For Microsoft Windows Server 2003:

When you are asked to load additional drivers, press <Enter> to start the Microsoft Windows installation process.

- 7** From the list at the **Select the operating system you want to install** window, select the applicable operating system. Click **Next**.
- 8** Perform the remaining operating system installation instructions. Some of the windows require user-specific password and system information. As required, contact your IT administrator for assistance.

For Microsoft Windows Server 2003 only: Two warning dialog boxes appear during the Installing Windows segment of the installation:

- At the **Software Installation** dialog box, click **Yes**.
- At the **Hardware Installation** dialog box, click **Yes**.



NOTE: When the operating system installation process is finished, remove the installation media inserted in step 5.

Installing the Controller Drivers During the Operating System Installation: For Systems with a PERC S300 Adapter



CAUTION: The latest firmware, drivers and applications must be installed whenever the controller software is upgraded. A previous version of the driver might not work with the latest controller software and vice versa.



NOTE: When using an external USB floppy disk drive, make sure to connect it to the system when the system is powered-off and before starting step 1.

- 1 Reboot the system. When the POST screen appears press <F11>.
- 2 Insert the Windows operating system media into the optical drive of the system.
- 3 When the BIOS Boot Manager window appears, select the text that begins with **SATA Optical Drive...** and press <Enter>.
- 4 Install the applicable Microsoft Windows operating system, using the on-screen instructions.
- 5 From the list at the **Select the operating system you want to install** window, select the applicable operating system. Click **Next**.
- 6 Perform the on-screen instructions at the next several windows.
- 7 At **Install Windows - Where do you want to install Windows?**, perform the following:

For Microsoft Windows Server 2008 and Windows Server 2008 R2:

- a Insert the CD-ROM, DVD, USB flash drive, or floppy disk that contains the files copied at "Downloading the Controller Driver Media" on page 37. Click **Load Driver**.
- b At the **Load Driver** sub-screen, click **Browse**.
- c Select the directory that has the controller driver files. Click **OK**.

For Microsoft Windows Server 2003:

- a Insert the floppy disk that contains the files copied at "Downloading the Controller Driver Media" on page 37. (An external USB floppy disk drive can be used, if your system does not have a built-in floppy disk drive).
- b Press <F6> on the keyboard, when prompted at the beginning of the Windows setup.

- c Wait until the **Windows Setup** screen appears with **S = Specify Additional Device**. Press <S> on the keyboard.
 - d Insert the requested media disk (as applicable) and press <Enter>.
 - 8 At the **Select the driver to be installed** window, select **Dell PERC S100, S300 Controller...** Click **Next** to load the driver files.
For Microsoft Windows Server 2003: When you are asked to load additional drivers, press <Enter> to start the Microsoft Windows installation process.
 - 9 Perform the remaining operating system installation instructions. Some of the windows require user-specific password and system information. As required, contact your IT administrator for assistance
For Microsoft Windows Server 2003 only: Two warning dialog boxes appear during the Installing Windows segment of the installation:
 - At the **Software Installation** dialog box, click **Yes**.
 - At the **Hardware Installation** dialog box, click **Yes**.
-  **NOTE:** When the operating system installation process is finished, remove the installation media inserted in step 7.

Performing the PERC S100 Controller or PERC S300 Controller Management Setup Procedure

The PERC S100 adapter or PERC S300 adapter management setup procedure is described in Dell OpenManage Server Administrator Storage Management. To set up a PERC S100 adapter or PERC S300 adapter on your system, see the Storage Management procedures located at the Dell Support website at support.dell.com/manuals.

RAID Configuration and Management

The Dell PowerEdge RAID Controller (PERC) S100 and PERC S100 adapter are configured by using the PERC S100 Virtual Disk Management utility or PERC S300 Virtual Disk Management utility. The utility is accessed at system startup, when you are prompted to press <Ctrl><R>.

 **NOTE:** Unless mentioned otherwise, the term PERC Virtual Disk Management utility refers to both the PERC S100 Virtual Disk Management utility and the PERC S300 Virtual Disk Management utility.

 **NOTE:** To configure the PERC S100 adapter or PERC S300 adapter with Dell OpenManage Server Administrator Storage Management, see the Dell Support Website at support.dell.com/manuals.

 **NOTE:** The PERC Virtual Disk Management utility can be accessed and configured without the operating system and controller drivers being installed.

Configuring the Controller: Using the PERC Virtual Disk Management Utility

Table 6-1. PERC Virtual Disk Management Utility Operations

Operation	Description
Accessing the PERC Virtual Disk Management Utility	Describes how to log onto the PERC Virtual Disk Management utility.
Understanding the Text Colors in the PERC Virtual Disk Management Utility	Describes the status of the physical disks and virtual disks, based on the color-highlighted text.
Initializing Physical Disks	Describes how to initialize a physical disk for data storage.
Creating Virtual Disks	Describes how to create a virtual disk from the connected physical disks.

Table 6-1. PERC Virtual Disk Management Utility Operations (continued)

Operation	Description
Deleting Virtual Disks	Deletes one or more virtual disks that are configured for the controller.
Swapping Two Virtual Disks	Swaps virtual disks to enable them to load in any order.
Managing Global Hot Spares	Enables you to create or delete a global hot spare(s).
Viewing Physical Disk Details	Enables you to view detailed information about any connected physical disk.
Viewing Virtual Disk Details	Enables you to view detailed information about any virtual disk.
Rescanning Disks	Rescans the disks to detect new or removed physical disks or virtual disks.
Controller Options	Changes the selected controller options, such as booting and virtual disk warnings.
Continuing to Boot	Enables the system to continue booting after you use the PERC Virtual Disk Management utility.

Accessing the PERC Virtual Disk Management Utility

- 1 Boot the system and wait until the message **Press <Ctrl><R> to Configure** appears.
- 2 Press <Ctrl><R>.

You have a maximum of three seconds to press <Ctrl><R>, or the system's boot process continues.



CAUTION: If SATA Controller is not set to RAID Mode, data might be destroyed. Make sure to backup all data before changing modes.



NOTE: If the PERC Virtual Disk Management utility does not appear and your system uses a PERC S100, press F2 to access the Dell system BIOS. At the **SATA Settings** field, make sure that **SATA Controller** is set to **RAID Mode**. If the settings are correct and the PERC Virtual Disk Management utility still does not appear contact Dell support at support.dell.com.

The utility contains these fields:

- An information field (yellow or red text): Located below the window name and the current build number.
- **Virtual Disks:** Displays the virtual disks that have been created and information about them: virtual disk number, RAID level, virtual disk size, virtual disk status, and caching mode status.
- **Main Menu:** Indicates the main PERC Virtual Disk Management utility operations.
- **Physical Disks:** Displays information about the physical disks or ATAPI devices.
- **Available Keys:** Indicates the keyboard keys to use to select a line of text or perform an operation.



NOTE: For a description of virtual disk and physical disk states, see Table B-2 and Table B-3, located on the Dell Support website at support.dell.com/manuals.



NOTE: The first virtual disk listed in **Virtual Disks** must be the bootable virtual disk. The system can boot only when the bootable virtual disk is at the first position in the list.

Understanding the Text Colors in the PERC Virtual Disk Management Utility

Text within the PERC Virtual Disk Management utility is color-coded, as follows:

Table 6-2. PERC Virtual Disk Management Text Colors

Text Color	Description
White text	Indicates an available option or informational text.
Black text, yellow highlighting	Indicates an option or device for which you might take action.
Yellow text	Indicates information about the yellow-highlighted option.
Green text	Indicates an item that has been selected.
Light blue text	Indicates that the item cannot be selected.
Magenta text	Indicates items that are related to hot spares or boot options.
Red text	Indicates a failed virtual or physical disk or a warning. For example, informational text might be red if an option is not available.

Initializing Physical Disks

New physical disks must be initialized before they can be used. Initialization writes controller configuration information to the physical disk.

Physical disks with the following statuses can be initialized:

- **Non-RAID** — A physical disk that was configured by a non-PERC S100 adapter or PERC S300 adapter.
- **Ready** — Contains no stored data but has PERC S100 adapter or PERC S300 adapter configuration information.

Physical disks that are **Online** cannot be initialized.

- 1 Power-up the system to start booting.
- 2 When prompted, press the <Ctrl> <R> keys to access the PERC Virtual Disk Management utility.
- 3 At the **Main Menu** field use the arrow keys to select the **Initialize Physical Disk(s)** option.
- 4 Press <Enter>.
- 5 Use the arrow keys to select **Initialize for PERC S100 (PERC S300)** or **Initialize to Non-Raid**.
- 6 Press <Enter>.
- 7 Use the arrow keys to select a physical disk. Press <Insert> to select the physical disk, or press the <A> key to choose all selectable physical disks.



NOTE: You can select and initialize multiple physical disks. There is no need to initialize one physical disk at a time.

- 8 Press <Enter> to initialize the selected physical disk or disks.





NOTE: After a physical disk is initialized as Non-Raid, it appears as **Non-Raid** in the **Physical Disks** field of the PERC Virtual Disk Management utility. A **Non-Raid** virtual disk is also created and appears in the **Virtual Disks** field.

- 9 A dialog box appears, warning that any data on the physical disk will be permanently lost if it is initialized. Press the <C> key to continue with initialization or press <Esc> to cancel.

Initialization takes 10–15 seconds per physical disk. A status indicator shows which physical disk is being initialized. When initialization is complete, the status indicator turns off, and all channels are re-scanned automatically.

 **CAUTION:** If a physical disk has a virtual disk on it, the physical disk cannot be selected for initialization. To initialize the physical disk anyway, make sure to delete the virtual disk. Be sure you want to initialize the physical disk, because all data on it (including PERC S100 adapter or PERC S300 adapter configuration information) is deleted.

 **NOTE:** When Non-Raid physical disks are installed in the system, their associated Non-Raid virtual disks must be deleted in order to use the physical disks with the PERC S100 adapter or PERC S300 adapter. Deleting the Non-Raid virtual disks initializes the Non-Raid physical disks and changes their state to **Ready**.

 **NOTE:** Typically, continue with the next procedure, Creating Virtual Disks.

Creating Virtual Disks

You can create virtual disks after the physical disks are initialized, especially if the virtual disk is a bootable virtual disk for your system. If you have not decided what RAID level to use, see the *Raid Technology Guide*, located on the Dell Support website at support.dell.com/manuals.

Before You Begin

- At any point in this procedure, return to a prior state by pressing <Esc>.
- A maximum of eight virtual disks can be created with the PERC Virtual Disk Management utility.
- Avoid mixing of redundant and non-redundant raid levels on the same set of physical disks.

 **NOTE:** The Create Virtual Disk operation is not selectable when there is no available capacity on the physical disks.

- 1 Power-up the system to start booting.
- 2 When prompted, press the <Ctrl><R> keys to access the PERC Virtual Disk Management utility.
- 3 At the **Main Menu** field, use the arrow keys to select **Create Virtual Disk**. Press <Enter>.

- 4 At the **Physical Disks** field, select the physical disk(s) on which to create a virtual disk:
 - a For each physical disk, press the <Insert> key to select the physical disk. (The physical disks can be inserted in any order.)
 - b After selecting the physical disk(s) to be included in the virtual disk, press <Enter>.
- 5 At the **User Input** field, use the arrow keys to select a virtual disk type (RAID level). Press <Enter>. (Only the virtual disk types that can be created with the selected physical disk(s) are indicated; they are highlighted in white text).
- 6 If hot spares are applicable:



NOTE: A global hot spare can be assigned after a virtual disk is created, by selecting the Manage Global Hot Spare(s) option.

- a At the **User Input** field, use the arrow keys to select a dedicated hot spare. Press <Enter>.
 - b At the **Physical Disks** field, select the physical disk to use as a hot spare (if applicable). Press <Insert> to select it.
 - c Press <Enter> to add the hot spare. Press the <C> key to confirm the change.
- 7 Select a size for the virtual disk, depending on the available free space of the physical disks. Review the choices indicated in Table 6-3. (Virtual disk size changes are displayed at the **Create Virtual Disk** and **User Input** fields.)



NOTE: The maximum size of the virtual disk is affected by the available free space of the physical disks and by the RAID level that you select.

- 8 After you choose the virtual disk size, press <Enter>.
- 9 At the **User Input** field, select a **Caching Mode**. Press <Enter>.
- 10 Press the <C> key to confirm that you want to create the virtual disk.
- 11 At the **Main Menu** field, perform other operations or select **Continue to Boot** and press <Enter>.



NOTE: The boot virtual disk must be the first virtual disk listed in the **Virtual Disks** field. If necessary, use the **Swap Two Virtual Disks** option to place the bootable virtual disk in the first position.

Table 6-3. Selection of Virtual Disk Sizes

To Create This Virtual Disk Size	Perform This Task
< 2.199 TB	Use the <Page Up> or <Page Down> keys to select a size in large increments or Use the up arrow or down arrow keys to select a size in small increments. Continue with "Creating Virtual Disks" on page 51.
> 2.199 TB	<ol style="list-style-type: none">1 Press the <Page Up> or the up arrow key to increase the virtual disk size.2 At the maximum size, a dialog box appears in the User Input field. It inquires if you want to limit the size of the virtual disk or exceed the normal maximum size.3 Press <Esc> to create a larger virtual disk.4 Press the <Page Up> or the up arrow key, until the desired or maximum available size has been attained.5 Continue with "Creating Virtual Disks" on page 51. <p>NOTE: When physical disks of different capacities are used, the maximum size of the virtual disk is limited by the size of the physical disk with the smallest capacity.</p>



NOTE: If you want to have a bootable virtual disk, make sure that INT 13 support is enabled on the controller, as described in "Controller Options" on page 58.

Deleting Virtual Disks



CAUTION: Although any virtual disk in the **Virtual Disks** field can be deleted, including the first-listed virtual disk in the field, do not delete the first-listed virtual disk. It may be the system's bootable virtual disk. Deleting the bootable virtual disk erases the operating system and the controller drivers.



CAUTION: When a physical disk is removed from a system, the current PERC S100 adapter or PERC S300 adapter configuration information (metadata) remains on the disk. If the removed physical disk causes a virtual disk to fail, and the virtual disk is then deleted and a Rescan is performed, re-inserting the physical disk causes the PERC Virtual Disk Management utility to merge the re-inserted physical disk's

configuration information with the existing configuration information. The previously deleted virtual disk re-appears in the PERC Virtual Disk Management utility.

△ CAUTION: Make sure that all physical disks that are part of a virtual disk are in the system before you delete the virtual disk.

- 1 Power-up the system to start booting.
- 2 When prompted, press the <Ctrl><R> keys to access the PERC Virtual Disk Management utility.
- 3 At the **Main Menu** field, select **Delete Virtual Disk(s)**. Press <Enter>.
- 4 Perform one of the following:
 - Select each virtual disk in the **Virtual Disks** field that you want to delete. Press <Insert> to confirm each selection.

OR

 - Press <A> to select all virtual disks for deletion.



NOTE: The text color of the selected virtual disk(s) changes to green.

- 5 Press <Enter>.

△ CAUTION: A dialog box appears, describing the consequences of deleting the selected virtual disk(s). Deleting a virtual disk permanently destroys all data that is on the virtual disk, as well as the virtual disk itself. This action cannot be undone.

- 6 Press the <C> key to confirm the deletion.

Swapping Two Virtual Disks

Use the **Swap Two Virtual Disks** option of the PERC Virtual Disk Management utility to arrange virtual disks in a different order.



CAUTION: Do not swap the first-listed virtual disk at **Virtual Disks if it is the system's bootable virtual disk. The bootable virtual disk must always be the first-listed virtual disk at **Virtual Disks**.**

Before You Begin

- The **Swap Two Virtual Disks** option is enabled only if there is at least one initialized physical disk in the system. For example, if all the physical disks in the system are Non-Raid, the **Swap Two Virtual Disks** option is disabled.
- It is recommended that the bootable virtual disk be a redundant virtual disk-type, such as RAID 1, RAID 5, or RAID 10, to preserve data in case a physical disk in the virtual disk fails. As required, swap that virtual disk into the first position at **Virtual Disks**, if it is not already virtual disk 1. See the **Swap Two Virtual Disks** option below.
- The boot device and the boot order are user-selectable.
- The swap feature is available only with the PERC Virtual Disk Management utility.



NOTE: Only two virtual disks can be swapped at a time.

- 1 Power-up the system to start booting.
- 2 When prompted, press the <Ctrl><R> keys to access the PERC Virtual Disk Management utility.
- 3 At the **Main Menu** field, select **Swap Two Virtual Disks**. Press <Enter>.
- 4 Use the arrow keys to highlight a virtual disk at the **Virtual Disk** field. Press <Insert>.
- 5 Use the arrow keys to highlight another virtual disk. Press <Insert>.
- 6 Press <Enter> to swap the virtual disks.

Managing Global Hot Spares

This option enables you to create a global hot spare from a selected physical disk, or to delete a global hot spare.



NOTE: A global hot spare can be created only if a physical disk is in **Ready** or **Normal** status at the **Physical Disks** field. If the physical disk is in **Online** status, it is being used by a virtual disk and cannot be selected as a hot spare.

Create a Global Hot Spare

- 1 Power-up the system to start booting.
- 2 When prompted, press the <Ctrl><R> keys to access the PERC Virtual Disk Management utility.
- 3 At the **Main Menu** field, select **Manage Global Spare(s)**. Press <Enter>.
- 4 Select **Assign Global Hot Spare(s)**. Press <Enter>.
- 5 Use the up or down arrow key to select a physical disk(s) for use as a global hot spare(s). Press <Insert>.
- 6 Press <Enter> to add the global hot spare.
- 7 Press the <C> key to confirm the action.

Delete a Global Hot Spare

- 1 Power-up the system to start booting.
- 2 When prompted, press the <Ctrl><R> keys to access the PERC Virtual Disk Management utility.
- 3 At the **Main Menu** field, select **Manage Global Spare(s)**. Press <Enter>.
- 4 Select **Unassign Global Hot Spare(s)**. Press <Enter>.
- 5 Use the up or down arrow key to select the physical disk(s) to delete as a global hot spare(s). Press <Insert>.
- 6 Press <Enter> to delete the global hot spare.
- 7 Press the <C> key to confirm the action.

Viewing Physical Disk Details

- 1 Power-up the system to start booting.
- 2 When prompted, press the <Ctrl><R> keys to access the PERC Virtual Disk Management utility.
- 3 At the **Main Menu** field, select **View Physical Disk Details**. Press <Enter>.
- 4 Use the arrow keys to choose a physical disk.
- 5 Physical disk information is displayed at the top of the window:
 - Physical disk number
 - Channel number
 - Physical disk size
 - Physical disk status: **New/Non-Raid/Ready/Online**
 - Amount of free space
 - Manufacturer and model number
- 6 When finished, press <Esc> to return to the main window.

Viewing Virtual Disk Details

- 1 Power-up the system to start booting.
- 2 When prompted, press the <Ctrl><R> keys to access the PERC Virtual Disk Management utility.
- 3 At the **Main Menu** field, select **View Virtual Disk Details**. Press <Enter>.
- 4 Use the arrow keys to choose a virtual disk.
- 5 Virtual disk information is displayed at the top of the window and in the **Virtual Disks** field:
 - Virtual disk number
 - RAID level
 - Size
 - Status (**R/W R, NA**)
- 6 When finished, press <Esc> to return to the main window.



NOTE: The **Physical Disks** field indicates the physical disks that are in the virtual disk, highlighted by green text.

Rescanning Disks

This option enables you to rescan all channels and detect new or removed physical disks or virtual disks.

- To perform a rescan, select **Rescan Disks** from the **Main Menu** field and press <Enter>. (The activity indicator, in the information field at the top of the window, spins while the physical disks are being polled).
- The **Rescan Disks** option rescans all the channels, searches for new or removed physical disks, and re-reads the configuration information from each physical disk.



NOTE: Sometimes when a physical disk has failed, it can be brought online through a rescan.

Controller Options

The **Controller Options** feature enables you to select INT 13 boot support and select whether the boot process pauses when an error occurs. The boot process pauses when **Pause if...** is enabled and a virtual disk becomes **Degraded** or has **Failed**. Press <Enter> to continue booting.

View the error message on the window. If **Pause...** is **OFF**, the error message is displayed briefly, but the system continues to boot.

- 1 At the **Main Menu** field, use the arrow key to select **Controller Options**. Press <Enter>.
- 2 At the **Controller Options** field, use the up or down arrow keys to scroll to the desired controller option. See Table 6-4.
- 3 When finished, press <Esc> to return to the main window.

Table 6-4. Controller Options

Controller Option	Description	How to Operate
INT13 Boot Support	Determines whether the BIOS installs INT 13 support (physical disk seek, read, and write operations for a PERC S100 adapter or PERC S300 adapter).	Press <Enter> to toggle between ON and OFF .

Table 6-4. Controller Options

Controller Option	Description	How to Operate
Pause if Degraded	When ON , the BIOS stops booting when a degraded virtual disk is found.	Press <Enter> to toggle between ON and OFF .
Pause if Failed	When ON , the BIOS stops booting when a failed virtual disk is found.	Press <Enter> to toggle between ON and OFF .

Continuing to Boot

After using the PERC Virtual Disk Management utility, return the system to its normal booting process by selecting **Continue to Boot** in the **Main Menu** field and pressing <Enter>.

Troubleshooting

To get help with your Dell PowerEdge RAID Controller (PERC) PERC S100 adapter and PERC S300 adapter, contact your Dell Technical Service representative or access the Dell Support Web site at support.dell.com.

The chapter discusses four major categories of troubleshooting:

- Normal tasks that cannot be performed during system startup.
- Warning messages that might appear at the Dell Inc. PERC S100 Controller BIOS or Dell Inc. PERC S300 Controller BIOS screen.
- Functions that cannot be performed with virtual disks.
- Functions that cannot be performed with physical disks.



NOTE: Unless mentioned otherwise, the term PERC Virtual Disk Management utility refers to both the PERC S100 Virtual Disk Management utility and the PERC S300 Virtual Disk Management utility.

System Startup Problems

The following table indicates potential PERC S100 adapter or PERC S300 adapter-related causes for system startup problems.

Table 7-1. System Does Not Boot

Likely Causes to Check	Corrective Actions
Controller mode is set incorrectly at System Setup	<ol style="list-style-type: none"> 1 At system startup, when the Dell Power-On Self-Test (POST) screen appears, press <F2> to enter the Dell Inc. PowerEdge BIOS screen. 2 Scroll to SATA Settings. Press <Enter> and make sure that the following is true: <ul style="list-style-type: none"> • For a PERC S100 adapter: SATA Controller is set to a RAID mode. • For a PERC S300 adapter: SATA Controller is set to ATA Mode or AHCI. <p>NOTE: Data might be lost when switching from RAID Mode to ATA Mode.</p>

Table 7-1. System Does Not Boot

Likely Causes to Check	Corrective Actions
<p>Boot Mode, Boot Sequence, and/or Boot Sequence Retry are set incorrectly</p>	<ol style="list-style-type: none"> 1 At system startup, when the Dell POST screen appears, press <F2> to enter the Dell Inc. PowerEdge BIOS screen. 2 Scroll to Boot Settings. Press <Enter> and make sure that Boot Mode is set to BIOS. 3 Scroll to Boot Sequence. Press <Enter> and make sure that Hard drive C: (* PERC S100 adapter or PERC S300 adapter) is the first device listed. * The variable text displayed here might be: Embedded SATA 1, Slot 1, or Integrated SAS. 4 Scroll to Boot Sequence Retry. Make sure that the setting is Enabled. 5 Press <Esc> to exit and continue booting. <p>NOTE: If changes are made at the Dell Inc. PowerEdge BIOS screen, a dialog box appears and asks you to save your changes and then exit.</p>
<p>Bootable virtual disk is in a failed state</p>	<ol style="list-style-type: none"> 1 Press <Ctrl><Alt> to restart. 2 After the system restarts, press <Ctrl><R>. Check the status of the bootable virtual disk at the Virtual Disk field, or by highlighting View Virtual Disks Details and pressing <Enter>. 3 Check for missing or offline physical disks.
<p>The boot order is incorrect for a bootable virtual disk</p>	<ol style="list-style-type: none"> 1 When prompted at system startup, press <Ctrl><R> to access the PERC Virtual Disk Management utility. 2 Check Virtual Disks and make sure that the bootable virtual disk is the first virtual disk listed. 3 As required, use the Swap Two Virtual Disks option to reposition the virtual disks.

Table 7-1. System Does Not Boot

Likely Causes to Check	Corrective Actions
<p>A Non-Raid virtual disk is no longer in the first position in the PERC Virtual Disk Management utility list after the system is rebooted</p> <p>NOTE: When booting from a Non-Raid virtual disk, creating a virtual disk in Dell OpenManage Server Administrator Storage Management changes the virtual disk order and displaces the bootable Non-Raid virtual disk from the first position. PERC S100 adapter or PERC S300 adapter then attempts to boot from the first virtual disk.</p> <p>NOTE: A Non-Raid virtual disk can be created from Non-Raid physical disks (which are physical disks initialized at a non-PERC S100 adapter or a non-PERC S300 adapter).</p>	<ol style="list-style-type: none"> 1 When prompted at system startup, press <Ctrl><R> to access the PERC Virtual Disk Management utility. 2 Check <code>Virtual Disks</code> and determine if the bootable Non-Raid virtual disk is no longer in the first position. 3 Use the Swap Two Virtual Disks option to swap the virtual disks and place the bootable Non-Raid virtual disk in the first position of the Virtual Disks field.

Table 7-2. The PERC Virtual Disk Management Option Does Not Display

Likely Causes to Check	Corrective Actions
<p>The PERC S100 adapter mode is set incorrectly in the system BIOS</p>	<p>See Table 7-1 for the correct SATA Setting.</p>
<p>The PERC S300 adapter is not seated correctly</p>	<p>Make sure that the PERC S300 adapter is installed in the correct slot and is properly seated.</p>

Warning Messages: Dell Inc. PERC S100 Adapter or Dell Inc. PERC S300 Adapter BIOS Screen

The Dell Inc. PERC S100 Controller BIOS screen or Dell Inc. PERC S300 Controller BIOS screen is one of the first screens to appear during your system's boot sequence. If the system's virtual disks were in **Normal** or **Ready** status before a system boot, the boot sequence continues normally to the Microsoft Windows Server 2008 or Microsoft Windows Server 2003 operating system.

But, if a virtual disk is in **Degraded** or **Failed** status, or if specific options in the **Controller Options** field were changed previously at the PERC Virtual Disk Management utility, the warning messages described in Table 7-3 through Table 7-6 appear during the boot sequence. For other issues, see Table 7-7.

Table 7-3. Warning Messages: Dell Inc. PERC S100 or PERC S300 Adapter BIOS

Warning Message	Corrective Action
WARNING: Found virtual disks that are Degraded	<p>This warning message appears when at least one virtual disk is in a Degraded state and Pause if Degraded is set to ON at the PERC Virtual Disk Management utility.</p> <p>The following message appears after the warning is displayed:</p> <pre>--- Press <Enter> to continue, or <CTRL><R> to enter setup ---</pre> <p>Press <Enter> to allow the operating system to continue with the boot sequence, or press <Ctrl><R> to enter into the PERC Virtual Disk Management utility to investigate the cause of the Degraded virtual disk.</p> <p>To investigate the cause, check for the following:</p> <ul style="list-style-type: none">• Whether a physical disk in the virtual disk has failed or has gone offline. Check the status at the Physical Disks field. A Degraded status depends on the RAID level of the virtual disk and the number of physical disks that have failed:<ul style="list-style-type: none">– For a virtual disk at RAID 1 or RAID 5, a single physical disk failure causes a Degraded status.– For a virtual disk at RAID 10, the failure of a physical disk in each of the mirror sets creates a Degraded status for the RAID 10. The failure of two physical disks in the same mirror set creates a Failed status for the RAID 10.• Whether the controller has failed, due to a firmware failure or a component failure. A failed controller causes a virtual disk not to boot. <p>For the virtual disk to recover from Degraded status, the failed physical disk must be replaced and the virtual disk must be rebuilt, using Dell OpenManage Server Administrator Storage Management. When the rebuild operation is completed, the virtual disk status changes from Degraded to Ready. For a description of the rebuild function, see Storage Management, located on the Dell Support website at support.dell.com/manuals.</p>

Table 7-4. Warning Messages: Dell Inc. PERC S100 or S300 Adapter BIOS (continued)

Warning Message	Corrective Action
WARNING: Found virtual disks that are Failed	<p>This warning message appears when at least one virtual disk is in a Failed state and Pause if Failed is set to ON at the PERC Virtual Disk Management utility.</p> <p>The following message appears after the warning is displayed:</p> <pre>--- Press <Enter> to continue, or <Ctrl><R> to enter setup ---</pre> <p>Press <Enter> to allow the operating system to continue its boot, or press <Ctrl><R> to enter into the PERC Virtual Disk Management utility to investigate the cause of the Failed virtual disk.</p> <p>NOTE: A boot virtual disk that is in a Failed state prevents the operating system from booting.</p> <p>To investigate the cause, check for the following:</p> <ul style="list-style-type: none">• Determine if a single or multiple physical disks in a non-redundant virtual disk have failed. If "yes," data is lost. Recover the lost data from a backup storage source.• Determine if two or more physical disks in a redundant virtual disk have failed. If "yes," data is lost. Recover the lost data from a backup storage source. <p>NOTE: For a RAID 10, if a single physical disk fails in each mirrored set, the redundant virtual disk goes to a Degraded status but data is not lost. If two physical disks fail in one of the mirrored sets, the redundant virtual disk goes to a Failed status and data is lost.</p>

Table 7-5. Warning Messages: Dell Inc. PERC S100 or S300 Adapter BIOS (continued)

Warning Message	Corrective Action
WARNING: Found virtual disks that are Degraded and Failed	<p>This warning message appears when multiple virtual disks are in Degraded and Failed state and Pause if Degraded or Pause if Failed are set to ON at the PERC Virtual Disk Management utility.</p> <p>The following message appears after the warning is displayed:</p> <pre>--- Press <Enter> to continue, or <Ctrl><R> to enter setup ---</pre> <p>Press <Enter> to allow the operating system to continue its boot, or press <Ctrl><R> to enter into the PERC Virtual Disk Management utility to investigate the cause of the Degraded and Failed virtual disks.</p> <p>NOTE: A boot virtual disk that is in a Failed state prevents the operating system from booting.</p> <p>To investigate the cause, check for the following:</p> <ul style="list-style-type: none">• Whether the virtual disk is in Degraded status because one of the physical disks of a RAID 1 or RAID 5 virtual disk has failed, or one of the physical disks of a RAID 10 virtual disk has failed. Press <Ctrl><R> and verify if the physical disks are offline or missing. Remove and replace a failed physical disk. A second physical disk failure could cause a Degraded virtual disk to change to Failed status.• Whether the virtual disk is in a Failed status because one or more of the physical disks have failed. Press <Ctrl><R> and verify if the physical disks are offline or missing. Remove and replace the failed physical disk or disks.

Table 7-6. Warning Messages: Dell Inc. PERC S100 or S300 Adapter BIOS (continued)

Warning Message	Corrective Action
BIOS NOT INSTALLED - User Disabled INT13 BIOS Load	<p>This warning message appears when:</p> <ul style="list-style-type: none"> • The INT13 Boot Support option has been set to OFF at the PERC Virtual Disk Management utility. <p>Bootable devices do not function with the controller when INT 13 Boot Support is set to OFF (ON is the default setting, which allows bootable devices to function with the controller).</p> <p>NOTE: You can set INT 13 Boot Support to OFF when you want to boot the system from another boot device (for example, another hard-drive). It is recommended that you use only your system's current boot device.</p> <p>If INT 13 Boot Support is set to OFF and another boot device is not selected, the following occurs:</p> <ul style="list-style-type: none"> • The boot sequence stops after BIOS Not Installed - User Disabled INT 13 BIOS Load appears. • A second warning message appears: No boot device available - strike F1 to retry boot, F2 for setup utility, F11 for BIOS boot manager. <p>When the system's boot sequence stops, perform the following:</p> <ol style="list-style-type: none"> 1 Press <Ctrl><Alt> to exit from the boot sequence. 2 Turn off your system, then restart it. 3 When instructed during the start-up sequence, press <Ctrl><R> to access the PERC Virtual Disk Management utility. 4 At the Main Menu field, use the arrow key to scroll to Controller Options. Press <Enter>. 5 At INT13 Boot Support press <Enter> and change OFF to ON. 6 Press <Esc>. 7 At the Main Menu field, use the arrow key to scroll to Continue to Boot. Press <Enter>. <p>NOTE: The system boot sequence continues to the operating system.</p>

Table 7-7. Other Errors Appearing on the BIOS

Issue	Likely Causes to Check	Corrective Actions
The RAID 0 goes offline and the RAID 1 becomes degraded in a PowerEdge R210 system with two drives.	Faulty physical disk	<ol style="list-style-type: none">1 Boot system into CTRL-R and replace faulty drive.2 Delete the failed RAID 0 and then create a new RAID 0. Now RAID 0 is optimal and RAID 1 is still degraded.3 Install OS on the RAID 0 and backup RAID 1.4 Delete and Recreate RAID 1 and restore backup data.
When attempting to update system backplane firmware and or Hard drive firmware using DUPs the updates fail.	DUPs are not supported.	Use the DOS utilities
eSata devices appear in Ready state in CTRL-R	Issue with the physical connection	Remove the devices from eSata port and plug them into the chassis. NOTE: eSATA devices are blocked from virtual disk creation.
During CTRL-R, S100/S300 do not display greater than eight Virtual Disks.	The function is not supported.	Remove all physical disks except for the last one(s) added. Then proceed with deleting the virtual disks that are not needed. Remember to take account of the virtual disks that are currently being used.
Unable to delete Virtual Disks when there are more than eight Virtual Disks present in the system.	The function is not supported.	Remove all physical disks except for the last one(s) added. Then proceed with deleting the virtual disks that are not needed. Remember to take account of the virtual disks that are currently being used.
Virtual disk rebuild status while during CTRL-R	Rebuild is not supported in Ctrl-R.	Boot to a supported OS. Rebuild starts. To view rebuild status, install a supported storage application.

Table 7-7. Other Errors Appearing on the BIOS

Issue	Likely Causes to Check	Corrective Actions
S100 rom option not visible during S300 controller use in the system.	S100 and S300 co-existence in the same system is not supported. S100 option rom becomes disabled when S100 and S300 are available.	Remove S300 adapter and reboot system to select F1 and select RAID for boot BIOS. The S100 rom option appears during POST boot. NOTE: If both controllers are used in the system, the windows driver manager displays the additional driver.

Virtual Disk-Related Errors

Use the information on the following tables as guidelines for troubleshooting the controller.

Table 7-8. Cannot Create a Virtual Disk

Likely Causes to Check	Corrective Actions
The physical disk is not displayed	This error might be because: <ul style="list-style-type: none">– The controller cannot communicate with the physical disks.– A cable might be loose or defective. Re-seat the physical disks in the backplane and check their cables.
Insufficient free space available on the selected physical disks	There must be sufficient available free space on the physical disk(s) used by the virtual disk.
Incorrect number of physical disks selected for the desired RAID level	See "Understanding RAID Levels" in the <i>RAID Technology Guide</i> , located on the Dell Support website at support.dell.com/manuals , for a description of RAID levels and the allowable number of physical disks used with each RAID level.

Table 7-8. Cannot Create a Virtual Disk (continued)

Likely Causes to Check	Corrective Actions
The desired physical disk is unavailable	Determine whether the physical disk: <ul style="list-style-type: none">• Is a dedicated hot spare and unavailable for use in another virtual disk.• Is full or has insufficient available capacity.
The system already has a maximum of eight virtual disks	Delete unused virtual disks. CAUTION: Deleting a virtual disk destroys all data on the virtual disk.

Table 7-9. A Virtual Disk is in a Failed State

Likely Causes to Check	Corrective Actions
The virtual disk has lost one or more physical disks	Replace the failed physical disk(s) and restore the data from a backup storage source.
A physical disk in the virtual disk has failed or has been removed	<ul style="list-style-type: none">• Re-install the original physical disk if it was inadvertently removed. Perform a rescan.• Check the status of the physical disks in the virtual disk. Replace any failed disk(s), if necessary. Restore the data from a backup storage source. After any change, perform a rescan to verify if the disk is still in a Failed state.
The virtual disk has lost the maximum allowable physical disks per RAID level	One or more physical disks have failed. <ul style="list-style-type: none">– If the virtual disk is non-redundant, the failure of a single physical disk can cause the virtual disk to fail.– If the virtual disk is redundant, two or more physical disks have failed and the virtual disk cannot be rebuilt. Create a new virtual disk. Restore the data from a backup storage source.

Table 7-10. A Virtual Disk is in a Degraded State

Likely Causes to Check	Corrective Actions
A physical disk was removed	<ul style="list-style-type: none">• Install the original physical disk, if it was inadvertently removed, or replace it with a new or used physical disk.• Initialize a new physical disk. Perform a Rescan for all physical disks that are replaced.• If the physical disk was not removed, check that its cables are correctly installed.
Physical or mechanical problems with the physical disk	<ul style="list-style-type: none">• Check if the physical disk in the virtual disk has failed.• If a physical disk was recently removed and replaced, check that it is correctly positioned in the backplane. Check the cable connections at the physical disk and at the motherboard. Perform a rescan.
The virtual disk has lost redundancy	<ul style="list-style-type: none">• One or more physical disks in the virtual disk have failed. Due to the failed physical disk or disks, the virtual disk is no longer maintaining redundant (mirrored or parity) data. The failure of an additional physical disk results in lost data.• Replace the physical disk or disks. Rebuild the physical disk using Storage Management. See the applicable Storage Management screen, located on the Dell Support website at support.dell.com/manuals.
Corrupted metadata in the virtual disk	<ol style="list-style-type: none">1 Delete the virtual disk that has the failed metadata.2 Assign the physical disk as a hot spare to rebuild a redundant virtual disk.3 To create a non-redundant virtual disk, delete and rebuilt the data on a virtual disk, and restore the data from a backup storage source.

Table 7-11. Cannot Assign a Dedicated Hot Spare to a Virtual Disk

Likely Causes to Check	Corrective Actions
The RAID level does not allow a dedicated hot spare to be created	Hot spares cannot be created for Volume or RAID 0 virtual disks.
The designated physical disk does not have sufficient capacity to be a dedicated hot spare	The capacity of the physical disk selected to be a dedicated hot spare must be equal to or larger than the capacity of the smallest physical disk in the virtual disk. For example, if the physical disk selected for a dedicated hot spare is 160 GB, and the physical disks in the virtual disk are 80 GB, 160 GB, and 500 GB, a dedicated hot spare can be assigned. That is because the physical disk selected for the dedicated hot spare is larger than the smallest (80 GB) physical disk in the virtual disk.
The physical disk is already part of a virtual disk	A dedicated hot spare cannot be assigned to another virtual disk.
The physical disks are of different types	The physical disk used as a dedicated spare must be the same type as the physical disks that are already part of the virtual disk. For example, if a virtual disk consists of SATA-II physical disks, the dedicated hot spare must be a SATA-II physical disk.

Table 7-12. Cannot Create a Global Hot Spare

Likely Causes to Check	Corrective Actions
There are no empty physical disks available or the physical disks have not been initialized	Install additional physical disks and initialize them. If existing physical disks have a status of New they need to be initialized. WARNING: When a physical disk is initialized, all data on the physical disk is lost. NOTE: A physical disk with a Non-Raid status can be initialized, if desired, but it is no longer Non-Raid (initialization adds PERC S100 adapter/PERC S300 adapter configuration information to the physical disk).

Table 7-12. Cannot Create a Global Hot Spare (continued)

The physical disk is already part of a virtual disk	A global hot spare cannot be selected if it is already part of an existing virtual disk.
The physical disk assigned as the global hot spare has failed	<p>When prompted at system startup, press <Ctrl><R> to access the PERC Virtual Disk Management utility.</p> <p>At the PERC Virtual Disk Management utility, select View Virtual Disk Details and press <Enter>. Determine whether the physical disk that is designated as the global hot spare has a status of Failed.</p> <ul style="list-style-type: none">• Check to see if the physical disk is malfunctioning or is physically disconnected.• Select another physical disk as the global hot spare.
The physical disk assigned as the global hot spare is missing	<ul style="list-style-type: none">• Check to see if the physical disk was removed from the backplane or cable connection, or whether the cables from the controller to the physical disk are disconnected or faulty.• Perform a rescan to verify that the physical disk is still missing.

Physical Disk-Related Errors

Table 7-13. The Physical Disk Fails

Likely Causes to Check	Corrective Actions
A physical disk is not visible in the PERC Virtual Disk Management utility or is offline	<ul style="list-style-type: none"> • Check that the cables are properly connected. • For PERC S300 adapters only: check that the physical disk is installed properly in the system's backplane. • For PERC S300 adapters only: check the system's backplane for damage. • For PERC S300 adapters only: reinstall the physical disk and make sure that it is seated correctly in the system's backplane. • Perform a Rescan, to (a) update the status of storage devices attached to the controller, or (b) fix an error caused by deleting or initializing a virtual disk.
A physical disk is highlighted red at the PERC Virtual Disk Management utility	<ul style="list-style-type: none"> • Replace the physical disk. Depending on the RAID level of the virtual disk, data might be lost. • Perform a rescan to confirm that the new disk was discovered.

Table 7-14. A Dedicated Hot Spare Fails

Likely Causes to Check	Corrective Actions
The controller cannot communicate with the hot spare	<ul style="list-style-type: none"> • Check that the cable from the controller to the physical disk is connected properly. • Make sure that the physical disk is still assigned as a global or dedicated hot spare. • Check if the physical disk assigned as the hot spare has failed.
The dedicated spare is not visible in the PERC Virtual Disk Management utility or is offline	<p>The controller cannot communicate with the hot spare.</p> <ul style="list-style-type: none"> • Check if the physical disk has been removed or has failed. • Check for a loose or bad cable.

Table 7-15. The Wrong Physical Disk was Removed

Likely Causes to Check	Corrective Actions
A physical disk has been removed from a virtual disk	<p>The removal of one physical disk from a virtual disk causes:</p> <ul style="list-style-type: none">• A Volume or RAID 0 virtual disk to change to Failed status.• A RAID 1 and RAID 5 virtual disk to change to Degraded status.• A RAID 10 virtual disk to change to Degraded status (when a physical disk is removed from one of the mirrored sets). <p>Re-insert the removed physical disk and perform a Rescan of the virtual disk.</p>

Table 7-16. Cannot Initialize a Physical Disk

Likely Causes to Check	Corrective Actions
The physical disk cannot be initialized	<p>Check whether or not the physical disk is:</p> <ul style="list-style-type: none">• Already a member of a virtual disk.• Currently a global or dedicated spare.• Reporting an Offline state. <p>Only physical disks that are Ready can be initialized.</p>

Appendix A

Controller Specifications

This section contains information about the Dell PowerEdge RAID Controller (PERC) S100 and S300 adapter specifications:

- Read, write, and cache policy
- Physical and virtual disk tasks
- Virtual disk specifications
- Supported RAID levels

Read, Write, and Cache Policy

Table A-1 indicates the read, write, and cache policies that are supported/not supported by the PERC S100 Adapter and PERC S300 adapter.

Table A-1. Read, Write, and Cache Policy for the PERC S100 adapter and PERC S300 adapter

Category	Supported by PERC S100 Adapter, PERC S300 adapter
Cache Settings	Yes
Read/Write	Yes
Read Only	Yes
None (Read/Write)	Yes



CAUTION: The current default for Write-Cache mode enablement is Write Through, Non Read Ahead (WT, NRA). To enable Write Back (WB), a UPS is recommended.

Controller Tasks

Table A-2 indicates the tasks that are supported or not supported by the PERC S100 Adapter and PERC S300 adapter.

Table A-2. PERC S100 Adapter and PERC S300 Adapter Tasks

PERC S100 adapter or PERC S300 adapter Task Name	Supported by PERC S100 adapter, PERC S300 adapter
Enable alarm	No
Disable alarm	No
Quiet alarm	No
Test alarm	No
Set check consistency rate	No
Rescan controller	No
Create virtual disk	Yes

Physical Disk Tasks

Table A-3 indicates the physical disk tasks that are supported/not supported by the controllers at the PERC Virtual Disk Management utility.



NOTE: Unless mentioned otherwise, the term PERC Virtual Disk Management utility refers to both the PERC S100 Virtual Disk Management utility and the PERC S300 Virtual Disk Management utility.

Table A-3. Physical Disk Tasks

Physical Disk Task Name	Supported by PERC S100 adapter, PERC S300 adapter
Blink/Unblink	Only with a system that has a PERC S300 adapter and a backplane
Assign and unassign global hot spare	Yes

Virtual Disk Tasks

Table A-4 indicates the virtual disk tasks that are supported/not supported by the controllers.

Table A-4. Virtual Disk Tasks

Virtual Disk Task Name	Supported by PERC S100 adapter, PERC S300 adapter
Assign and unassign dedicated hot spare	Yes
Create virtual disk	Yes
Reconfigure	Yes
Delete (any) virtual disk	Yes
Start a check consistency	Yes
Cancel check consistency	Yes
Initialize virtual disk	No (if using the PERC Virtual Disk Management utility) Yes (if doing a BGI in Storage Management)

Supported RAID Levels

Table A-5 indicates the RAID levels that are supported by the PERC S100 Adapter and PERC S300 adapter.

Table A-5. Supported RAID Levels for the PERC S100 adapter and PERC S300 adapter

RAID Level	Supported by PERC S100 adapter, PERC S300 adapter
Volume	Yes (only when using the PERC Virtual Disk Management utility)
RAID 0	Yes
RAID 1	Yes
RAID 5	Yes
RAID 10	Yes

Virtual Disk Specifications

Table A-6 indicates the virtual disk specifications that apply to the PERC S100 Adapter and PERC S300 adapter.

Table A-6. Virtual Disk Specifications for the PERC S100 adapter and PERC S300 adapter

Virtual Disk Specification	Value
Maximum number of virtual disks per controller	8
Minimum virtual disk size	102 MB
Maximum virtual disk size	No maximum size; there may operating system size limitations
Maximum number of physical disks per virtual disk	8
Maximum number of virtual disks per physical disk	8
Maximum number of physical disks that can be concatenated	N/A
Maximum number of physical disks in a Volume	1
Maximum number of physical disks in a RAID 0	8
Maximum number of physical disks in a RAID 1	2
Maximum number of physical disks in a RAID 5	8
Maximum number of physical disks in a RAID 10	8
Minimum number of physical disks that can be concatenated	N/A
Minimum number of physical disks in a Volume	1
Minimum number of physical disks in a RAID 0	2
Minimum number of physical disks in a RAID 1	2
Minimum number of physical disks in a RAID 5	3
Minimum number of physical disks in a RAID 10	4

Appendix B

RAID Technology - Understanding Disk Arrays and Virtual Disks

A *disk array* consists of the physical disks that are connected to a controller.

A *virtual disk* is data storage created by a controller from one or more physical disks. The virtual disk is viewed by the operating system as a single disk.

The Dell PowerEdge RAID Controller (PERC) S100 controller and PERC S300 controller allows:

- SAS HDD (PERC S300 controller only), SATA HDD, and/or SATA SSD (PERC S100 controller only) physical disks to co-exist on a single controller.
- Physical disks of the same type (SAS HDD, SATA HDD, SATA SSD) but of different capacities.
- Virtual disks to be at different RAID levels on the same controller, but not supported on the same group of physical disks.

Because some RAID levels enhance performance while others improve reliability, it is important to consider your needs when planning a virtual disk configuration.

The ability of the controller to provide online expansion to virtual disks across multiple physical disks and controllers becomes extremely valuable when storage expansion is a requirement.

Understanding RAID Levels

A PERC S100 controller or PERC S300 controller supports the following RAID levels:

Table B-1. RAID Levels and Characteristics

RAID Level	Main Characteristics	Advantages
Volume (can be created only using the PERC S100 Virtual Disk Management utility or PERC S300 Virtual Disk Management utility. Dell OpenManage Server Administrator Storage Management can manage a Volume but cannot create it.) NOTE: Unless mentioned otherwise, the term PERC Virtual Disk Management utility refers to both the PERC S100 Virtual Disk Management utility and the PERC S300 Virtual Disk Management utility	A virtual disk type that links available space on a single physical disk and forms a single logical volume on which data is stored.	<ul style="list-style-type: none"> • Concatenation allows access to a single physical disk. • Concatenation does not provide performance benefits or data redundancy. • When a physical disk in a concatenated virtual disk fails, data is lost from that virtual disk. Because there is no redundancy, data can be restored only from a backup.
RAID 0 (striping)	Provides the highest performance, but no data redundancy. Data in the virtual disk is striped (distributed) across two or more physical disks.	RAID 0 virtual disks are useful for holding information, such as the operating system paging file, where performance is extremely important but redundancy is not.

Table B-1. RAID Levels and Characteristics (continued)

RAID Level	Main Characteristics	Advantages
RAID 1 (mirroring)	<p>Mirrors data on one physical disk to another, to provide basic redundancy.</p> <p>In the event of a single physical disk failure a second copy of the data exists, which can be used to restore the data to a new, replacement physical disk.</p>	<p>Useful when only two physical disks are available, and when data integrity is more important than storage capacity.</p>
RAID 10 (striped mirror sets)	<p>Combines mirrored and striped sets; data are striped across mirrored sets of physical disks.</p> <p>RAID 10 allows multiple physical disk failures, up to one failed physical disk in each mirror that has been striped.</p> <p>In the event of a single physical disk failure (per mirror set) a second copy of the data exists, which can be used to restore the data to a new, replacement physical disk.</p>	<ul style="list-style-type: none">• Offers better performance than a simple mirror because of the additional physical disks.• Requires twice the disk space of RAID 0 to offer redundancy.• When a physical disk in a RAID 10 virtual disk fails, the virtual disk is still functional. Data is read from the surviving mirrored disk.

Table B-1. RAID Levels and Characteristics (continued)

RAID Level	Main Characteristics	Advantages
RAID 5 (striping with parity)	<p>Stripes data, as well as parity, across all physical disks in the virtual disk. Parity information is interspersed across the virtual disk.</p> <p>In the event of a single physical disk failure, parity data exists on the remaining physical disks, which can be used to restore the data to a new, replacement physical disk.</p>	<ul style="list-style-type: none">• Offers exceptional read performance, as well as redundancy.• Requires only one extra physical disk to offer redundancy.• For most systems with three or more physical disks this is the best choice as a RAID level.

Disk States - Virtual and Physical Disks

The following tables indicate the statuses that can appear at the PERC Virtual Disk Management utility.

Table B-2. Physical Disk States

State	Definition
ATAPI	Indicates a peripheral device (CD-ROM, DVD, or tape drive) instead of a physical disk. An ATAPI device cannot be initialized or added to a virtual disk.
Non-Raid	A physical disk has been moved from another, non-PERC S100 controller or non-PERC S300 controller.
Online	The physical disk has been initialized and is part of a virtual disk.
Ready	The physical disk has been initialized but is not currently used in a virtual disk.
Failed	A failed physical disk appears as Failed only when (a) View Virtual Disk Details is selected, and (b) the virtual disk to which the physical disk belongs is selected. The Failed status is reported only when the physical disk is part of a virtual disk.
Spare	A physical disk that is assigned as a dedicated or global hot spare.

Table B-3. Virtual Disk States

State	Definition
Degraded	A physical disk in a redundant virtual disk has failed. Additional failures might result in lost data.
Failed	One or more physical disks have failed. The virtual disk has gone offline. The virtual disk cannot restore the data.
Non-Raid	A Non-Raid physical disk is automatically linked to a Non-Raid virtual disk for use with a PERC S100 controller or PERC S300 controller.
Normal	A virtual disk has been created and its preparation process has been completed.
Ready	A redundant virtual disk has been created, and is ready for additional preparation.

Failure States

Whether a virtual disk is marked as **Failed** or **Degraded** depends upon what RAID level virtual disk it is, and how many physical disks of the virtual disk have failed. In Table B-4 note the changes in state.

If a rescan of all channels is performed after disconnecting a physical disk, the state of every virtual disk using the disconnected physical disk changes from the **Ready** state to either the **Failed** or **Degraded** state, depending on the virtual disk's RAID level.

For additional information about rescanning to update storage configuration changes, see the OpenManage documentation available on the Dell Support website at support.dell.com/manuals.

Table B-4. Failure Status by Virtual Disk RAID Level

Virtual Disk RAID Level	Failure Status	Description
RAID 1, RAID 5	Degraded	A single physical disk fails.
RAID 10	Degraded	A single physical disk fails in one or more of the mirrored sets.
Volume, RAID 0	Failed	A single physical disk fails.
RAID 1 or RAID 5	Failed	Two or more physical disks fail.
RAID 10	Failed	Two physical disks in a mirrored set fail.

Creating Virtual Disks: Future Expansion

When creating virtual disks, consider whether or not the virtual disk capacity needs to be expanded in the future.

For a Microsoft Windows operating system, format the virtual disks with New Technology File System (NTFS). Microsoft Corporation provides a utility (diskpart.exe) that can dynamically extend an NTFS file system onto any unused adjacent space.

Note also that using a single partition per virtual disk makes expansion much easier.



NOTE: The diskpart.exe utility version depends on which version of the Windows operating system is running.



NOTE: The diskpart.exe utility can be found on the CD for some versions of Windows operating systems, or on the Microsoft Corporation website (microsoft.com) for other versions. Use the correct version for your operating system.

Understanding Physical Disks

Physical Disk States

Within the management applications, physical disks can be part of one or more virtual disks and can exist in the states indicated:

Table B-5. Minimum and Maximum Physical Disk Configurations

RAID Level	Minimum Number of Physical Disks	Maximum Number of Physical Disks
RAID 0	2	8
RAID 1	2	2
RAID 10	8	8
RAID 5	3	8

Rescanning Physical Disks for Changes in State

The physical disk information displayed at the PERC Virtual Disk Management utility is the state of the physical disks when they were last scanned. If a rescan has not been performed, the information displayed is the state of the physical disks at boot time.

Every time a physical disk is connected or disconnected while online, a rescan is performed. A rescan is automatically performed when Dell OpenManage Server Administrator Storage Management detects that a physical disk has been added or removed.

Dedicated Hot Spares

A dedicated hot spare is a backup physical disk for the redundant virtual disk to which it is assigned. The physical disk that is used as a dedicated hot spare cannot be a member of an existing virtual disk. When the hot spare is activated, it becomes the receptacle for the data from the failed physical disk member of the volume, without interrupting the system or requiring your intervention.

A dedicated hot spare can be assigned to any redundant virtual disk, and up to four hot spares can be assigned to a virtual disk. However, a dedicated hot spare cannot be assigned while a task is running on the virtual disk.

A global hot spare can be assigned when a virtual disk is created in the PERC Virtual Disk Management utility. A global hot spare can be added at any time when Storage Management is used.

If there is enough space available on the dedicated hot spare, and a disk failure occurs, the rebuild process for the virtual disk starts automatically.

Dedicated hot spare assignments do not apply to a non-redundant virtual disk.



NOTE: A virtual disk is marked **Failed** or **Degraded** if a physical disk reports a **Failed** state, or if the SAS/SATA cable to the physical disk or power cable is disconnected.

A dedicated hot spare is often preferred to a global hot spare, especially for critical data. This is because a dedicated hot spare guarantees that the virtual disk has a backup physical disk assigned exclusively to it in case of a failure.

For additional information, see "Managing Global Hot Spares" on page 56.

Global Hot Spares

A global hot spare is a backup physical disk that can be used by any redundant virtual disk. It is not assigned (dedicated) to any specific virtual disk.

Virtual disks can typically be rebuilt by using a global spare disk, as long as the global hot spare is not already part of the virtual disk and has enough available capacity. Unlike a dedicated hot spare, a global hot spare can be assigned at anytime, even while tasks are running on virtual disks.

If there is enough space available on the global hot spare, and a disk failure occurs, the rebuild process for the virtual disk starts automatically.

Appendix C

Regulatory Notices

Electromagnetic Interference (EMI) is any signal or emission, radiated in free space or conducted along power or signal leads, that endangers the functioning of a radio navigation or other safety service or seriously degrades, obstructs, or repeatedly interrupts a licensed radio communications service. Radio communications services include, but are not limited to, AM/FM commercial broadcast, television, cellular services, radar, air-traffic control, pager, and Personal Communication Services (PCS). These licensed services, along with unintentional radiators such as digital devices, including computers, contribute to the electromagnetic environment.

Electromagnetic Compatibility is the ability of items of electronic equipment to function properly together in the electronic environment. While this system has been designed and determined to be compliant with regulatory agency limits for EMI, there is no guarantee that interference may not occur in a particular installation. If this equipment does cause interference with radio communications services, which can be determined by turning the equipment off and on, you are encouraged to try to correct the interference by one or more of the following measures:

- Reorient the receiving antenna.
- Relocate the system with respect to the receiver.
- Move the system away from the receiver.
- Plug the system into a different outlet so that the system and the receiver are on different branch circuits.

If necessary, consult a Dell Technical Support representative or an experienced radio/television technician for additional suggestions.

For additional regulatory information, see the owner's manual or user's guide for your system.

Dell computers are designed, tested, and classified for their intended electromagnetic environment. These electromagnetic environment classifications generally refer to the following harmonized definitions:

- Class A is typically for business or industrial environments.
- Class B is typically for residential environments.

Information Technology Equipment (ITE), including devices, expansion cards, printers, input/output (I/O) devices, monitors, and so on, that are integrated into or connected to the system must match the electromagnetic environment classification of the system.

A Notice About Shielded Signal Cables: Use only shielded cables for connecting devices to any Dell device to reduce the possibility of interference with radio communications services. Using shielded cables ensures that you maintain the appropriate Electromagnetic Compatibility classification for the intended environment. Cables are available from Dell at dell.com.

Most Dell computers are classified for Class B environments. However, the inclusion of certain options can change the rating of some configurations to Class A. To determine the electromagnetic classification for your system or device, see the following sections specific for each regulatory agency. Each section provides country-specific Electromagnetic Compatibility/EMI or product safety information.

FCC Notice (U.S. Only)

FCC, Class A

This product has been tested and found to comply with the limits for a Class A digital device pursuant to Part 15 of the FCC Rules. These limits are designed to provide reasonable protection against harmful interference when the equipment is operated in a commercial environment. This product generates, uses, and can radiate radio frequency energy and, if not installed and used in accordance with the manufacturer's instruction manual, may cause harmful interference with radio communications. Operation of this product in a residential area is likely to cause harmful interference, in which case you will be required to correct the interference at your own expense.

FCC, Class B

This product generates, uses, and can radiate radio frequency energy and, if not installed and used in accordance with the manufacturer's instruction manual, may cause interference with radio and television reception. This product has been tested and found to comply with the limits for a Class B digital device pursuant to Part 15 of the FCC Rules.

This device complies with Part 15 of the FCC Rules. Operation is subject to the following two conditions:

- This device may not cause harmful interference.
- This device must accept any interference received, including interference that may cause undesired operation.



CAUTION: The FCC regulations provide that changes or modifications not expressly approved by Dell Inc. could void your authority to operate this equipment.

These limits are designed to provide reasonable protection against harmful interference in a residential installation. However, there is no guarantee that interference may not occur in a particular installation.

If this equipment does cause harmful interference with radio or television reception, which can be determined by turning the equipment off and on, you are encouraged to try to correct the interference by one or more of the following measures:

- Reorient the receiving antenna.
- Relocate the system with respect to the receiver.
- Move the system away from the receiver.
- Plug the system into a different outlet so that the system and the receiver are on different branch circuits.

If necessary, consult a representative of Dell Inc. or an experienced radio/television technician for additional suggestions.

The following information is provided on the device or devices covered in this document in compliance with FCC regulations:

Product Name	PERC S100, PERC S300
---------------------	-----------------------------

Company Name:	Dell Inc. Worldwide Regulatory Compliance & Environmental Affairs One Dell Way Round Rock, Texas 78682 USA 512-338-4400
---------------	---

Industry Canada Notice (Canada Only)

Industry Canada, Class A

This Class A digital apparatus complies with Canadian ICES-003.

Cet appareil numérique de la classe A est conforme à la norme NMB-003 du Canada.

Industry Canada, Class B

This Class B digital apparatus complies with Canadian ICES-003

Cet appareil numérique de la classe B est conforme à la norme NMB-003 du Canada.

 **CAUTION: The Industry Canada regulations provide that changes or modifications not expressly approved by Dell Inc. could void your authority to operate this equipment.**

CE Notice (European Union)

Marking by the symbol indicates compliance of this Dell system to the Electromagnetic Compatibility Directive 89/336/EEC and the Low Voltage Directive 73/23/EEC of the European Union. Such marking is indicative that this Dell system meets the following technical standards:

- EN 55022 — "Information Technology Equipment — Radio Disturbance Characteristics — Limits and Methods of Measurement."
- EN 55024 — "Information Technology Equipment - Immunity Characteristics - Limits and Methods of Measurement."

- EN 61000-3-2 — "Electromagnetic Compatibility - Part 3: Limits - Section 2: Limits for Harmonic Current Emissions (Equipment Input Current Up to and Including 16 A Per Phase)."
- EN 61000-3-3 — "Electromagnetic Compatibility - Part 3: Limits - Section 3: Limitation of Voltage Fluctuations and Flicker in Low-Voltage Supply Systems for Equipment With Rated Current Up to and Including 16 A."
- EN 60950 — "Safety of Information Technology Equipment."

EN 55022 emissions requirements provide for two classifications:

- Class A is for typical commercial areas.
- Class B is for typical domestic areas.

To determine which classification applies to your system, examine the FCC or ICES information on the regulatory label located on the back, side, or bottom panel of the system.

If the FCC or ICES information on the label indicates a Class B rating, the following Class B statement applies to your system:

This Dell device is classified for use in a typical Class B domestic environment.

A "Declaration of Conformity" in accordance with the preceding directives and standards has been made and is on file at Dell Inc. Products Europe BV, Limerick, Ireland.

CE Mark Notice

This equipment complies with the essential requirements of the European Union Directive 1999/5/EC.

Toto zařízení splňuje základní požadavky směrnice 1999/5/EC.

Dette udstyr opfylder de Væsentlige krav i EU's direktiv 1999/5/EC om Radio- og teleterminaludstyr.

Deze apparatuur voldoet aan de noodzakelijke vereisten van EU-richtlijn betreffende radioapparatuur en telecommunicatie-eindapparatuur 1999/5/EC.

Käesolev seade vastab olulistele Euroopa Liidu Direktiivi 1999/5/EC nõudmistele.

Tämä laite vastaa EU:n radio- ja telepäätelaitedirektiivin (EU R&TTE Directive 1999/5/EC) vaatimuksia.

Cet équipement est conforme aux principales caractéristiques définies dans la Directive européenne RTTE 1999/5/CE.

Die Geräte erfüllen die grundlegenden Anforderungen der RTTE-Richtlinie (1999/5/EG).

Ο εξοπλισμός αυτός πληροί τις βασικές απαιτήσεις της κοινοτικής οδηγίας EU R&TTE 1999/5/EK.

A készülék megfelel az Európai Unió 1999/5/EC direktívája alapvető követelményeinek.

Questa apparecchiatura é conforme ai requisiti essenziali della Direttiva Europea R&TTE 1999/5/CE.

Št ierīce atbilst nepieciešamajām Eiropas Savienības Direktīva prasībām 1999/5/EC.

Šis prietaisas atitinka būtiskus Eiropas Sąjungos direktyvos 1999/5/EC reikalavimus.

Dan it-tagħmir jikkonforma mar-reqwiziti essenzjali tad-Direttiva ta' l-Unjoni Ewropea 1999/5/KE.

Dette utstyret er i overensstemmelse med hovedkravene i R&TTE-direktivet (1999/5/EC) fra EU.

To urządzenie spełnia podstawowe wymagania dyrektywy Unii Europejskiej 1999/5/EC.

Este equipamento cumpre os requisitos essenciais da Directiva 1999/5/CE do Parlamento Europeu e do Conselho (Directiva RTT).

Toto zariadenie spĺňa základné požiadavky Direktívy Európskej únie č. 1999/5/EC.

Ta oprema je skladna z bistvenimi zahtevami direktive EU 1999/5/EC.

Este equipo cumple los requisitos principales de la Directiva 1999/5/CE de la UE, "Equipos de Terminales de Radio y Telecomunicaciones".

Utrustningen uppfyller kraven för EU-direktivet 1999/5/EC om ansluten teleutrustning och ömsesidigt erkännande av utrustningens överensstämmelse (R&TTE).

Appendix D

Contacting Dell

For customers in the United States, call 800-WWW-DELL (800-999-3355).



NOTE: If you do not have an active Internet connection, you can find contact information on your purchase invoice, packing slip, bill, or Dell product catalog.

Dell provides several online and telephone-based support and service options. Availability varies by country and product, and some services may not be available in your area. To contact Dell for sales, technical support, or customer service issues:

- 1 Visit support.dell.com.
- 2 Click your country/region at the bottom of the page. For a full listing of country/region click **All**.
- 3 Click **All Support** from the Support menu.
- 4 Select the appropriate service or support link based on your need.
- 5 Choose the method of contacting Dell that is convenient for you.

Index

B

- background initialization, 21
- BIOS, major functions, 47
- boot device, warning message, 68
- boot priority list
 - changing it, 41
 - checking controller options, 40
- boot support, RAID levels, 22
- booting the system after using the BIOS configuration utility, 59

C

- cache policy, 77
- CE Mark Notice, 94
- CE Notice (European Union), 92
- checkpointing, 22
- chipsets, configuration at the Dell system BIOS, 39
- Command Queuing, 22
- consistency check, 23
- continuing to boot the system, 59
- controller driver, download procedure, 37

- controller drivers,
 - pre-installation requirements, 38
- controller options, changing, 58
- controller options, changing them, 58
- controller tasks, supported by PERC S100 adapter, PERC S300 adapter, 78

D

- dedicated hot spares, 87
- degraded virtual disks, warning message, 65
- Dell system BIOS
 - configuring the chipset, 39
- device driver installation procedure, 37
- disk arrays, understanding them, 81
- disk roaming, 26
- drivers
 - installation, 42, 44

E

- electrostatic discharge, protecting against, 9
- errors, physical disks
 - dedicated hot spare has failed or is in error, 75
 - Failed status is displayed, 75
- errors, virtual disks
 - Failed status, 71
 - virtual disk has been deleted, 73
- ESD protection, 9

F

- fault tolerance, 23
- FCC Notice (U.S. only), 90
- features of the PERC S100 adapter, PERC S300 adapter, 21

G

- global hot spares, 88
- global hot spares, manage, 56

H

- hardware installation
 - completion, 35
 - general considerations, 31
 - PERC S100 adapter, PERC S300 adapter, 31

- hot spares
 - dedicated, 87
 - global, 88
- hot spares, global, managing them, 56
- hot swapping, 25

I

- Industry Canada Notice (Canada only), 92
- initialization, physical disks, 23
- installation
 - PERC S300 Adapter, 32
 - PERC S300 adapter, 32
- installing the controller drivers, PERC S100 adapter, 42
- installing the controller drivers, PERC S300 adapter, 44
- installing the operating system and drivers, PERC S100 adapter, 42
- installing the operating system and drivers, PERC S300 adapter, 44
- INT13 disabled, warning message, 68

M

- Management Setup, 45
- mirror rebuilding, 24

O

- OCE, 24
- offline virtual disks, warning message, 66
- Online Capacity Expansion, 24
- options
 - changing controller options, 58
- options, controller, 58

P

- PERC S100 controller, Management Setup, 45
- PERC S100 Virtual Disk Management utility, PERC S300 Virtual Disk Management utility
 - access to it, 48
- PERC S300 Adapter
 - installation, 32
- PERC S300 adapter
 - installation, 32
- PERC S300 controller, Management Setup, 45
- PERC Virtual Disk Management utility
 - major functions, 47
- physical disk details, viewing, 57
- physical disk hot swapping, 25
- physical disk initialization, 23
- physical disk roaming, 26

- physical disk tasks, supported by PERC S100 adapter, PERC S300 adapter, 78

physical disks

- automatic rebuild, 21
- connecting them to the PERC S300 controller, 35
- errors, 75
- troubleshooting, 75
- view disk details, 57

physical disks, general

- description, 24

- platform requirements for the PERC S100 controller, PERC S300 controller, 14

R

- RAID configuration and management, 47
- RAID levels, supported by PERC S100 adapter, PERC S300 adapter, 79
- RAID technology, 81
- read policy, 77
- regulatory notices, 89
 - CE Mark Notice, 94
 - CE Notice (European Union), 92
 - FCC Notice (U.S. only), 90
 - Industry Canada (Canada only), 92
- related documentation, 12
- rescan disks, 58

rescanning
for changes in state, 87

S

configuring the controller
using the PERC S100, 47

safety
general, 8
safety instructions, 7
working inside your system, 8

specifications, PERC S100
adapter, PERC S300
adapter, 77

specificationsÖ virtual disks, 80

Storport, driver support, 26

stripe size, 26

support for RAID level, 22

T

text colors, PERC S100 Virtual
Disk Management utility,
PERC S300 Virtual Disk
Management utility, 49

transformation, virtual disks, 28

troubleshooting, PERC S100
adapter, PERC S300
adapter, 61

V

Virtual Disk Management
utility, 47

virtual disk specifications, for
PERC S100 adapter, PERC
S300 adapter, 80

virtual disk tasks, supported by
PERC S100 adapter, PERC
S300 adapter, 79

virtual disks
background initialization, 21
boot support for degraded virtual
disks, 22
cache support, 22
creating, future expansion, 86
errors, 70
general description, 27
migration, 28
PERC S100 Virtual Disk
Management utility, PERC
S300 Virtual Disk
Management utility, 48
swapping the order of two
disks, 55
transformation, 28
troubleshooting, 70
view details, 57

virtual disks, understanding
them, 81

W

warning message

- BIOS not installed, user disabled
 - INT13 BIOS load, 68
- found virtual disks that are
 - Degraded, 65
- found virtual disks that are
 - Offline, 66
- no boot device available, 68
- warning messages
 - PERC S100 Controller BIOS
 - screen, PERC S300 Controller BIOS screen
 - warning messages, 64
- write policy, 77

Glossary

ADAPTER — An adapter enables the system to access peripheral devices by converting the protocol of one bus or interface to another. An adapter may also provide specialized function. For example, a RAID controller is a type of adapter that provides RAID functions. Adapters may reside on the system board or be an add-in card. Other examples of adapters include network and SCSI adapters.

AHCI — A programming specification which defines the operation of Serial ATA host controllers (also known as host bus adapters) in a non-implementation-specific manner. The specification describes a system memory structure for computer hardware vendors to exchange data between host system memory and attached storage-devices.

ATA (ADVANCED TECHNOLOGY ATTACHMENT) — A standard interface for connecting a system's storage devices, such as CD-ROMs and hard-drives.

ATAPI (ATA PACKET INTERFACE) — An interface standard that defines the packet protocol between a system and its internal storage peripherals, such as CD-ROM, DVD, or tape drives. ATAPI provides the command set for controlling the devices via an IDE interface.

BACKGROUND INITIALIZATION — Background initialization is the automatic check for media errors on physical disks. It ensures that striped data segments are the same on all physical disks in a virtual disk. The difference between a background initialization and a consistency check is that a background initialization is automatic for new virtual disks. The operation starts automatically after you create the disk.

BAS (BACKGROUND ARRAY SCAN) — Background Array Scan is a background operation which gets executed every 100msec. that verifies and corrects the mirror, volume or parity data for virtual disks. BAS starts automatically after a Virtual Disk is created.

BIOS (BASIC INPUT/OUTPUT SYSTEM) CONFIGURATION UTILITY — An alternate name for the PERC Virtual Disk Management utility. The utility appears during system startup when <Ctrl><R> are pressed.

CACHE — Fast memory that holds recently accessed data. Using cache speeds subsequent access to the same data. It is most often applied to processor-memory access but also can be used to store a copy of data accessible over a network. When data is read from or written to main memory, a copy is also saved in cache memory with the associated main memory address. The cache memory software monitors the addresses of subsequent reads to see if the required data is already stored in cache memory. If it is already in cache memory (a cache hit), it is read from cache memory

immediately and the main memory read is aborted (or not started). If the data is not cached (a cache miss), it is fetched from main memory and saved in cache memory.

CACHING — The process of utilizing a high speed memory buffer, referred to as a “cache,” in order to speed up the overall read or write performance. This cache can be accessed at a higher speed than a disk subsystem. To improve read performance, the cache usually contains the most recently accessed data, as well as data from adjacent disk sectors. To improve write performance, the cache may temporarily store data in accordance with its Write-Cache Enable policies. See the definition of Write-Cache Enable for more information.

CHANNEL — A link that transports data point-to-point.

CONSISTENCY CHECK — An operation to verify that all stripes in a virtual disk with a redundant RAID level are consistent and to automatically fix any errors. For RAID 5 arrays, a consistency check verifies correct parity data for each stripe. For RAID 1 and RAID 10 arrays, this operation verifies correct mirror data for each stripe.

CONTROLLER — A chip that controls the transfer of data between the microprocessor and memory or between the microprocessor and a peripheral device such as a physical disk or the keyboard. In Storage Management, the hardware or logic that interacts with storage devices to write and retrieve data and perform storage management. RAID controllers perform RAID functions such as striping and mirroring to provide data protection.

DISK — A non-volatile, randomly addressable, rewriteable mass storage device, including both rotating magnetic and optical storage devices and solid-state storage devices, or non-volatile electronic storage elements.

DISK ARRAY — A grouping of physical disks that are connected to the RAID controller. The RAID controller can group physical disks on one or more channels into an array.

DISK MIGRATION — Disk migration refers to moving a virtual disk or a hot spare from one controller to another by detaching the physical disks and re-attaching them to the new controller.

DISK ROAMING — Moving disks from one slot to another on a controller.

DISTRIBUTED PARITY — Parity involves an extra bit added to a byte or word to reveal errors in storage (in RAM or disk) or transmission. Parity is used to generate a set of redundancy data from two or more parent data sets. The redundancy data can be used to rebuild one of the parent data sets. In distributed parity, the parity data are distributed among all the physical disks in the system. If a single physical disk fails, it can be rebuilt from the parity of the applicable data on the remaining physical disks.

FAILED PHYSICAL DISK — A physical disk that has ceased to function, that consistently functions improperly, or that is inaccessible.

FAULT TOLERANCE — Fault tolerance is the capability of the disk subsystem to undergo a single drive failure for the physical disks in a virtual disk without compromising data integrity and processing capability. The PERC S100 controller and PERC S300 controller provide this support through redundant virtual disks in RAID levels 1, 5 and 10. Fault tolerance is often associated with system availability because it allows the system to be available during drive failures. In case a disk fails, the PERC S100 controller and PERC S300 controller support hot spare disks and the auto-rebuild feature.

FIRMWARE — Software stored in read-only memory (ROM) or Programmable ROM (PROM). Firmware is often responsible for the behavior of a system when it is first turned on. A typical example would be a monitor program in a system that loads the full operating system from disk or from a network and then passes control to the operating system.

FORMAT — The process of writing a specific value to all data fields on a physical disk, to map out unreadable or bad sectors. Because most physical disks are formatted when manufactured, formatting is usually done only if a physical disk generates many media errors.

GB — Acronym for gigabyte(s). A gigabyte equals 1,024 megabytes or 1,073,741,824 bytes (2^{30} bytes).

GPT (GUID PARTITION TABLE) — A standard for the layout of the partition table on a physical hard disk.

GLOBALLY UNIQUE IDENTIFIER (GUID) — A unique reference-number identifier used in software applications.

HBA (HOST BUS ADAPTOR) — An adaptor card that includes the I/O logic, software and processing to manage the transfer of information between the host system and devices connected to it.

HOST SYSTEM — Any system on which the RAID controller is installed. Mainframes, workstations, and personal systems can all be considered host systems.

HOT SPARE — An idle, powered on, stand-by physical disk ready for immediate use in case of disk failure. It does not contain any user data. A hot spare can be dedicated to a single redundant virtual disk or it can be part of the global hot-spare pool for all virtual disks controlled by the controller. When a disk fails, the PERC S100 controller or PERC S300 controller automatically replaces and rebuilds the data from the failed physical disk to the hot spare. Data can be rebuilt only from virtual disks with redundancy (RAID levels 1, 5, or 10; not RAID 0), and the hot spare must have sufficient capacity. If the hot spare is designated as having enclosure affinity, it attempts to rebuild any failed disks on the backplane within which it resides before rebuilding any other on other backplanes.

HOT SWAP — Replacement of a failed component while the system is running and operating normally.

INITIALIZATION — The process of writing zeros to the data fields of a virtual disk and, in fault tolerant RAID levels, generating the corresponding parity to put the virtual disk in a Ready state. Initialization generates parity information, so that the virtual disk is redundant. Virtual disks can work without initialization, but they are not truly redundant until initialization is performed.

INT 13H — A DOS interrupt used to activate seek, read, write and format disk functions. The Int 13h interface supports physical disks that contain up to an approximate maximum disk space of 8.45 GB.

JBOD (JUST A BUNCH OF DISKS [DRIVES]) — A storage subsystem that uses a single or multiple, independent disk drives.

LED (LIGHT EMITTING DIODE) — An electronic device that illuminates when powered.

LOAD BALANCING — Load balancing is a method of spreading work between two or more computers, network links, CPUs, physical disk drives, or other resources. Load balancing is used to maximize resource use, throughput, or response time. In the controllers, the balancing service is performed by the firmware. You can choose between a single path for load balancing, and a “round-robin” load balancing scheme. In single path, the firmware can detect multiple paths to a device, and use only a single path for I/O activity to that device. The secondary path is used if a failure is detected on the primary path. If load balancing is enabled for the controller, the firmware implements a round-robin scheme to issue I/Os to the redundant path device. The round-robin scheme issues one I/O down one path, and the other I/O down the second path, and so on. There is no restriction on firmware regarding which path to choose first. If load balancing is disabled, the firmware can use any one of the available paths to issue I/Os, and it should continue to use the same path for all further I/O activity. On reboot or path failure, the firmware again chooses any available path.

MB — Acronym for megabyte(s). The term megabyte means 1,048,576 bytes (2^{20} bytes); however, when referring to hard drive storage, the term is often rounded to mean 1,000,000 bytes.

MIRRORING — The process of providing complete redundancy using two physical disks, by maintaining an exact copy of one physical disk’s data on the second physical disk. If one physical disk fails, the contents of the other physical disk can be used to maintain the integrity of the system and to rebuild the failed physical disk.

NAS (NETWORK ATTACHED STORAGE) — A server that runs an operating system for handling files, and which is accessible directly on a LAN by using protocols like TCP/IP.

NCQ (NATIVE COMMAND QUEUING) — A command protocol for Serial ATA, that allows multiple, outstanding commands to be active on a drive at the same time.

NON-RAID CONFIGURATION — Non-Raid data is data that already exists on a replacement physical disk. The Non-Raid physical disk must be initialized before it can be used with the PERC S100 controller or PERC S300 controller.

NON-REDUNDANT VIRTUAL DISK — A non-redundant virtual disk is one which does not have redundant data on physical disks that can be used to rebuild a failed physical disk. A RAID 0 virtual disk consists of data striped across the physical disks, without disk mirroring or parity to provide redundancy. This provides for high data throughput but offers no protection in case of a physical disk failure.

Ns — Acronym for nanosecond(s), one billionth of a second.

NTFS (NEW TECHNOLOGY FILE SYSTEM) — The file system used by Microsoft Windows operating systems.

OCE (ONLINE CAPACITY EXPANSION) — Operation to add capacity to an existing virtual disk by adding an additional physical disk while the host system is active, and without affecting data availability.

OFFLINE — A physical disk is offline when it is part of a virtual disk but its data is not accessible to the virtual disk.

ONLINE — An online device is a device that is accessible.

PARITY — An extra bit added to a byte or word to reveal errors in storage (in RAM or disk) or transmission. Parity is used to generate a set of redundancy data from two or more parent data sets. The redundancy data can be used to rebuild one of the parent data sets. However, parity data does not fully duplicate the parent data sets. In RAID, this method is applied to entire physical disks or stripe elements across all physical disks in a virtual disk. Parity consists of dedicated parity, in which the parity of the data on two or more physical disks is stored on an additional physical disk, and distributed parity, in which the parity data are distributed among all the physical disks in the system. If a single physical disk fails, it can be rebuilt from the parity of the applicable data on the remaining physical disks.

PARTITION — A logical structure on a contiguous segment of storage on a physical disk or virtual disk that is recognizable by an operating system.

PCIe (PERIPHERAL COMPONENT INTERCONNECT EXPRESS) — A high-speed peripheral interconnect that can accommodate gigabit and chip-to-chip transfers.

PERC S100 VIRTUAL DISK MANAGEMENT, PERC S300 VIRTUAL DISK MANAGEMENT UTILITY — The PERC S100 Virtual Disk Management or PERC S300 Virtual Disk Management utility (aka PERC Virtual Disk Management utility) configures and maintains RAID virtual disks, and manages the RAID system. Because the utility resides in the controller BIOS, its operation is independent of the operating

system. The PERC Virtual Disk Management utility, accessed by pressing <Ctrl><R> at system startup, is built on elements called controls. Each control performs a function. The functions include procedures you can use to configure physical disks and virtual disks. The PERC Virtual Disk Management utility differs from the Dell Inc. system BIOS, which contains the BIOS settings for each Dell platform and is accessed by pressing <F2> during system startup.

PHYSICAL DISK — A non-volatile, randomly-addressable device for storing data. Physical disks are rewriteable and commonly referred to as disk drives.

PNP (PLUG AND PLAY) — A technology that allows automatic recognition of interface cards and devices when plugged into a PC.

PORT — A connection point to a RAID controller, disk drive, enclosure, or another device.

RAID (REDUNDANT ARRAY OF INDEPENDENT DISKS) — An array of multiple independent physical disks managed together to yield higher reliability and/or performance exceeding that of a single physical disk. The virtual disk appears to the operating system as a single storage unit. I/O is expedited because several disks can be accessed simultaneously. Redundant RAID levels (RAID levels 1, 5, and 10) provide data protection.

RAID LEVELS — A set of techniques applied to the physical disks in a virtual disk to deliver higher data availability, and/or performance characteristics to host environments. Each virtual disk must have a RAID level assigned to it.

RAID MANAGEMENT UTILITY — A RAID management utility (PERC Virtual Disk Management utility) is used to configure physical disks and virtual disks. Use the PERC Virtual Disk Management utility if the operating system has not yet been installed on the controller.

REBUILD — The regeneration of all data to a replacement disk in a redundant virtual disk (RAID levels 1, 5, and 10) after a physical disk failure. A disk rebuild normally occurs without interrupting normal operations on the affected virtual disk, though some degradation of performance of the disk subsystem can occur.

REDUNDANCY — The provision of multiple interchangeable components to perform a single function to cope with failures and errors. Common forms of hardware redundancy are disk mirroring, implementations of parity disks, or distributed parity.

REDUNDANT VIRTUAL DISK — A redundant virtual disk is one which has redundant data on physical disks that can be used to rebuild a failed physical disk. A virtual disk can use disk striping across the physical disks, disk mirroring or parity to provide redundancy. This offers protection in case of a physical disk failure.

REPLACEMENT DISK — A physical disk that replaces a failed physical disk in a virtual disk.

SAN (STORAGE AREA NETWORK) — A high-performance, typically enterprise-level network that attaches disk storage subsystems to servers. The storage devices are accessible to multiple hosts at the same time.

SAS (SERIAL ATTACHED SCSI) — SAS is a serial, point-to-point, enterprise-level device interface that leverages the proven Small Computer System Interface (SCSI) protocol set. The SAS interface provides improved performance, simplified cabling, smaller connectors, lower pin count, and lower power requirements when compared to parallel SCSI. SAS physical disks are supported only by the PERC S300 controller.

SATA (SERIAL ADVANCED TECHNOLOGY ATTACHMENT) — A physical storage interface standard, is a serial link that provides point-to-point connections between devices. The thinner serial cables allow for better airflow within the system and permit smaller chassis designs. The PERC S100 controller and PERC S300 controller leverage a common electrical and physical connection interface that is compatible with Serial ATA technology.

SCSI (SMALL COMPUTER SYSTEM INTERFACE) — A standard that allows multiple devices to be connected in a daisy-chain format. The fastest hard-drives are SCSI-based, rather than IDE-based.

SPANNING — The method by which nested RAID levels (such as RAID 10) are constructed from multiple sets of basic, or single RAID types. For example, a RAID 10 is made up of multiple sets of RAID 1 arrays where each RAID 1 set is considered a span. Data is then striped (RAID 0) across the RAID 1 spans to create a RAID 10 virtual disk. Spanning is generally used when referencing these nested RAID levels.

SPARE — A physical disk available to replace another physical disk in case that physical disk fails.

SSD (SOLID STATE DISK) — A high-performance storage media that contains no moving parts. It contains a memory board, a memory board bus, a CPU, and a battery card.

STORPORT — The Storport driver has been designed to replace SCSIport and work with Windows 2003 and beyond. In addition, it offers better performance for newer RAID controller protocols (like SAS), provides higher I/O throughput rates, improves manageability, and has an upgraded miniport interface. For example, while SCSIport allows a maximum of 254 commands per controller, Storport allows 254 commands per logical unit number (LUN).

STORAGE ARRAYS — A storage entity that is managed entirely by storage management software. A storage array consists of a collection of physical components (drives, controllers, fans, and power supplies) and logical components (such as virtual disks). A storage array can span multiple physical enclosures.

STRIPING — Disk striping writes data across all physical disks in a virtual disk. Each stripe consists of consecutive virtual disk data addresses that are mapped in fixed-size units to each physical disk in the virtual disk using a sequential pattern. For example, if the virtual disk includes five physical disks, the stripe writes data to physical disks one through five without repeating any of the physical disks. The amount of space consumed by a stripe is the same on each physical disk. The portion of a stripe that resides on a physical disk is a stripe element. Striping by itself does not provide data redundancy. Striping in combination with parity does provide data redundancy.

TB (TERABYTE) — One thousand gigabytes (approximately one trillion bytes).

TRANSFORMATION — A transformation can mean: (1) Capacity expansion, using OCE (adding more physical disks to a virtual disk and increasing the storage capacity of the virtual disk or virtual disks), or (2) Rebuilding (rebuilding data on the virtual disk from a redundant virtual disk or from a hot spare or backup physical disk).

VIRTUAL DISK — A virtual disk refers to storage created by a RAID controller from one or more physical disks. Although a virtual disk may be created from several physical disks, it is seen by the operating system as a single disk. Depending on the RAID level used, the virtual disk may retain redundant data in case of a disk failure.

WRITE-CACHE ENABLE — In Write-cache enable mode, the controller sends a data transfer completion signal to the host when the controller cache has received all the data in a disk write transaction. The VD cache is disabled by default, but can be enabled by the user through the user interface. The risk of using Write-cache enable is that the cached data can be lost if there is a power failure before it is written to the storage device. This risk can be mitigated by using a Uninterrupted Power Supply (UPS) on PERC S100 or S300 system. A UPS is recommended for use if the cache is enabled.

WRITE-CACHE DISABLE — In Write-Through caching mode, the controller sends a data transfer completion signal to the host when the disk subsystem has received all the data and has completed the write transaction to the disk.

WHQL (WINDOWS HARDWARE QUALITY LABS) — A Microsoft Corporation facility that provides testing services for non-Microsoft hardware and device drivers, to ensure compliance and compatibility with Microsoft operating systems.