

INSPIRON™

SETUP GUIDE



YOURS IS HERE

INSPIRON™

SETUP GUIDE

Regulatory Model: W01B

Regulatory Type: W01B001

Notes, Cautions, and Warnings



NOTE: A NOTE indicates important information that helps you make better use of your computer.



CAUTION: A CAUTION indicates either potential damage to hardware or loss of data and tells you how to avoid the problem.



WARNING: A WARNING indicates a potential for property damage, personal injury, or death.

If you purchased a Dell™ n Series computer, any references in this document to Microsoft® Windows® operating system are not applicable.

Information in this document is subject to change without notice.

© 2009 Dell Inc. All rights reserved.

Reproduction of these materials in any manner whatsoever without the written permission of Dell Inc. is strictly forbidden.

Trademarks used in this text: *Dell*, the *DELL* logo, *Inspiron*, *YOURS IS HERE*, and *DellConnect* are trademarks of Dell Inc.; *Intel*, *Pentium*, and *Celeron* are registered trademarks and *Core* is a trademark of Intel Corporation in the U.S. and other countries; *Microsoft* and *Windows* are registered trademarks of Microsoft Corporation in the United States and/or other countries; *Bluetooth* is a registered trademark owned by Bluetooth SIG, Inc. and is used by Dell under license.

Other trademarks and trade names may be used in this document to refer to either the entities claiming the marks and names or their products. Dell Inc. disclaims any proprietary interest in trademarks and trade names other than its own.

September 2009

P/N 1HNXJ

Rev. A00

Contents

Setting Up Your Inspiron One	5	Display Features	28
Before Setting Up Your Computer	5	Using the Touch Screen (Optional)	30
Connect the Keyboard and Mouse	6	Software Features	33
Connect the Power Cable	7	Solving Problems	36
Connect the Network Cable (Optional)	8	Touch Screen Problems	36
Adjust the Computer Stand	10	Beep Codes	37
Press the Power Button	11	Network Problems	38
Set Up Microsoft Windows 7	12	Power Problems	39
Connect to the Internet (Optional)	13	Memory Problems	40
Using Your Inspiron One	16	Lockups and Software Problems	41
Right View Features	16	Using Support Tools	43
Right Panel Buttons and Connectors	18	Dell Support Center	43
Left View Features	20	System Messages	44
Using the Optical Drive	22	Hardware Troubleshooter	45
Back View Features	24	Dell Diagnostics	46
Back Panel Connectors	26		

Contents

Restoring Your Operating System	50	Finding More Information and Resources	64
System Restore	50	Basic Specifications	66
Dell Factory Image Restore	52	Appendix	70
Operating System Reinstallation	54	Macrovision Product Notice	70
Getting Help	56	Information for NOM, or Official Mexican Standard (Only for Mexico)	71
Technical Support and Customer Service	57	Index	72
DellConnect	57		
Online Services	58		
Automated Order-Status Service	59		
Product Information	59		
Returning Items for Repair Under Warranty or for Credit	60		
Before You Call	61		
Contacting Dell	63		

Setting Up Your Inspiron One

This section provides information about setting up your Inspiron™ One 19T.



WARNING: Before you begin any of the procedures in this section, read the safety information that shipped with your computer. For additional safety best practices information, see the Regulatory Compliance Homepage at www.dell.com/regulatory_compliance.



NOTE: Your computer's Service Tag is located at the back of your computer. Use this code to identify your computer when you access the Dell Support website or contact technical support.

Before Setting Up Your Computer

When positioning your computer, ensure that you allow easy access to a power source, controls and connections on the right side, adequate ventilation, and a stable level surface to place your computer.

Restricting airflow around your Inspiron One may cause it to overheat. To prevent overheating ensure that you leave at least 10.2 cm (4 inches) at the back of the computer and a minimum of 5.1 cm (2 inches) on all the other sides. You should never place your computer in an enclosed space, such as a cabinet or drawer when it is powered on.

Connect the Keyboard and Mouse

Connect the USB keyboard and mouse to the USB connectors on the computer.

-  **NOTE:** If you purchased a wireless keyboard and mouse along with your computer, connect the USB receiver to the USB connector. For more information, see the documentation that shipped with your keyboard and mouse.

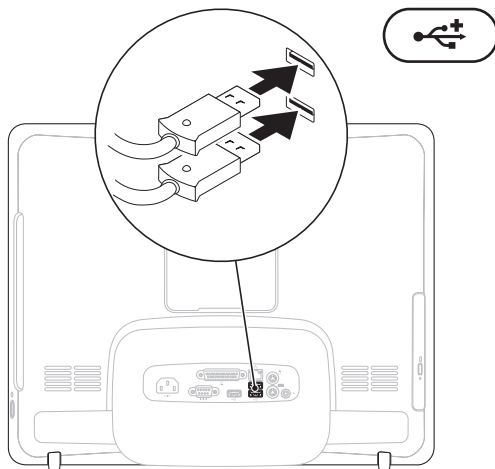

Connect the Power Cable

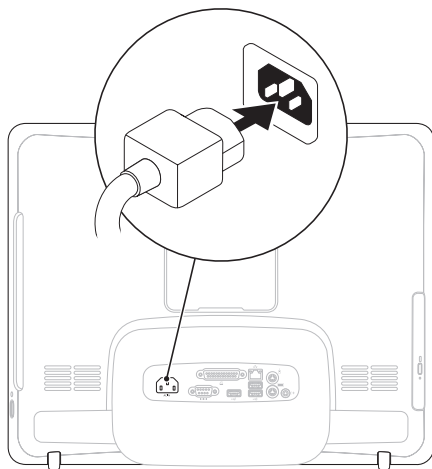

Connect the Network Cable (Optional)

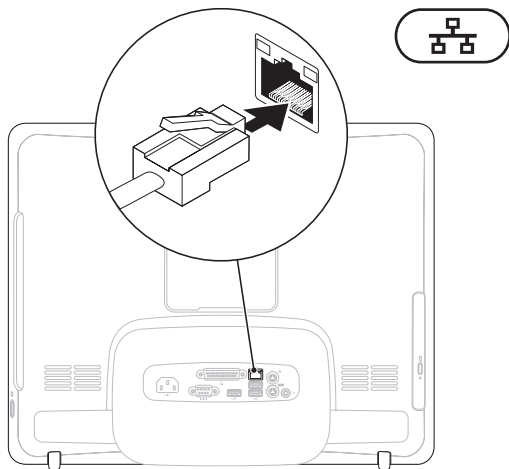

A network connection is not required to complete this computer setup, but if you have an existing network or Internet connection that uses a cable connection (such as a home cable modem or Ethernet jack), you can connect it now.

 **NOTE:** Use only an Ethernet cable (RJ45 connector) to connect to the network connector. Do not plug a telephone cable (RJ11 connector) into the network connector.

To connect your computer to a network or broadband device, connect one end of a network cable to either a network port or a broadband device. Connect the other end of the network cable to the network connector (RJ45 connector) on the back panel of your computer. A click indicates that the network cable has been securely attached.

Adjust the Computer Stand

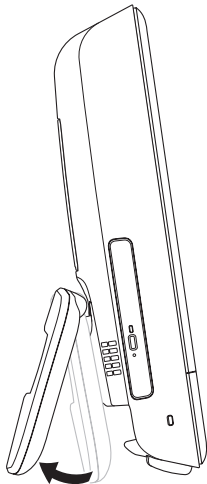

⚠ WARNING: Do not use the stand to carry the computer.

✎ NOTE: The stand must be closed before using the computer with a VESA wall mount.

Pull the stand to adjust the display to a comfortable viewing angle. A distinct click is heard when the stand is opened or closed. Your computer supports UL-certified VESA wall mounts. For proper mounting, use four (ea.) 4 mm dia, 0.7 pitch x 10.0 mm long screws.

Press the Power Button

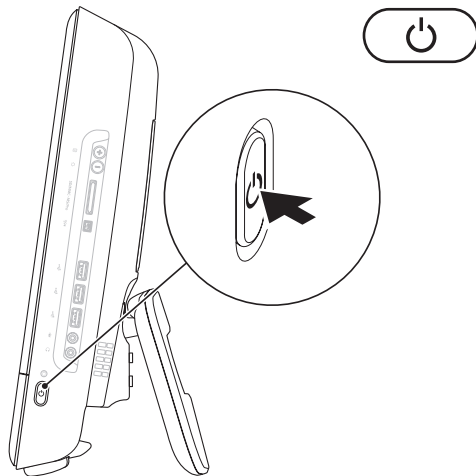

Set Up Microsoft Windows 7

Your Dell computer is preconfigured with the Microsoft® Windows® 7 operating system. To set up Windows for the first time, follow the instructions on the screen. These steps are mandatory and may take some time to complete. The Windows setup screens will take you through several procedures including accepting license agreements, setting preferences, and setting up an Internet connection.

 **CAUTION:** Do not interrupt the operating system's setup process. Doing so may render your computer unusable and you will need to reinstall the operating system.

 **NOTE:** For optimal performance of your computer, it is recommended that you download and install the latest BIOS and drivers for your computer available at support.dell.com.

Connect to the Internet (Optional)

To connect to the Internet, you need an external modem or network connection and an Internet Service Provider (ISP).

If an external USB modem or Wireless LAN adapter is not a part of your original order, you can purchase one at www.dell.com.

Setting Up a Wired Connection

- If you are using a dial-up connection, connect the telephone line to the optional external USB modem and to the telephone wall connector before you set up your Internet connection.
- If you are using a DSL or cable/satellite modem connection, contact your ISP or cellular telephone service for setup instructions.

To complete setting up your wired Internet connection, follow the instructions in “Setting Up Your Internet Connection” on page 14.

Setting Up a Wireless Connection

 **NOTE:** To set up your wireless router, see the documentation that shipped with your router.

Before you can use your wireless Internet connection, you need to connect to your wireless router.

To setup your connection to a wireless router:

1. Save and close any open files, and exit any open programs.
2. Click **Start**  → **Control Panel** → **Network and Sharing Center** → **Connect to a network**.
3. Follow the instructions on the screen to complete the setup.

Setting Up Your Internet Connection

ISPs and ISP offerings vary by country. Contact your ISP for offerings available in your country.

If you cannot connect to the Internet but have successfully connected in the past, the Internet Service Provider (ISP) might have a service outage. Contact your ISP to check the service status, or try connecting again later.

Have your ISP information ready. If you do not have an ISP, the **Connect to the Internet** wizard can help you get one.

To set up your Internet connection:

1. Save and close any open files, and exit any open programs.
2. Click **Start**  → **Control Panel**.
3. Click **Network and Sharing Center** → **Set up a new connection or network** → **Connect to the Internet**.

The **Connect to the Internet** window appears.

 **NOTE:** If you do not know which type of connection to select, click **Help me choose** or contact your ISP.

4. Follow the instructions on the screen and use the setup information provided by your ISP to complete the setup.

Using Your Inspiron One

This section provides information about the features available on your Inspiron One.

Right View Features

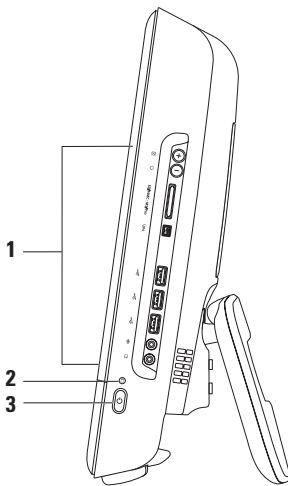

1 Right panel buttons and connectors — Adjusts brightness and connects USB, audio, and other devices to the appropriate connectors.

2  Hard drive activity light — Turns on when the computer reads or writes data. A blinking light indicates hard drive activity.





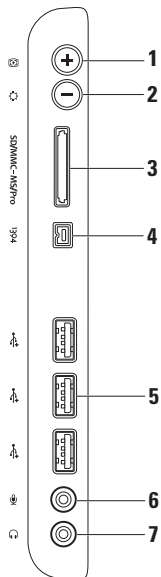

 **CAUTION: To avoid loss of data, never turn off the computer, move the computer, or adjust the stand while the hard drive activity light is blinking.**

3  Power button and light — Turns the computer on or off when pressed. The light in the center of this button indicates the following power states:

- Solid amber — The system board cannot start initialization. There may be an issue with either the system board or the power supply. Contact Dell (see “Contacting Dell” on page 63).
 - Blinking amber — The computer has detected an error during the Power-on self-test (POST). Contact Dell (see “Contacting Dell” on page 63).
 - Blinking white — The computer is in sleep state.
 - Solid white — The computer is on.
 - Off — The computer is off or in hibernate state.
-

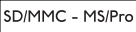
Right Panel Buttons and Connectors



-
- 1  **Auto adjust button** — Automatically adjusts the display with the incoming video signal.
-
- 2  **Brightness adjust button** — Press this button to access the “Brightness” control menu and then use the + (auto adjust button) or the - (brightness adjust button) to increase or decrease the brightness.
-
- 3  **8-in-1 Media Card Reader** — Provides a fast and convenient way to view and share digital photos, music, videos, and documents on the following digital memory cards:
- Secure Digital (SD) memory card
 - Secure Digital Input Output (SDIO) card
 - Multi Media Card (MMC)
 - Memory Stick
 - Memory Stick PRO
 - xD-Picture Card
 - Hi Speed-SD
 - Hi Density-SD
-
- 4  **IEEE 1394a connector** — Connects to high-speed serial multimedia devices, such as digital video cameras.
-
- 5  **USB 2.0 connectors (3)** — Connects to USB devices, such as a mouse, keyboard, printer, external drive, or MP3 player.
-
- 6  **Microphone or line-in connector** — Connects to a microphone or inputs signal for use with audio programs.
-
- 7  **Headphone or line-out connector** — Connects to a pair of headphones or to a powered speaker or sound system.
- NOTE:** To connect to a powered speaker or sound system, use the line out connector on the back of your computer.
-

Left View Features

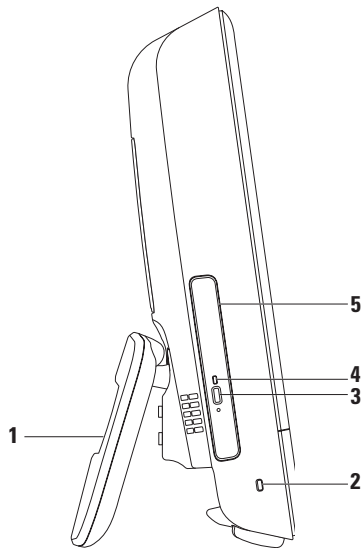

-
- 1 Computer stand** — Provides stability to the computer and also allows you to adjust the display to a comfortable viewing angle.

 - 2 Security cable slot** — Attaches a commercially available security cable to the computer.

 - 3 Optical drive eject button** — Opens the optical drive when pressed.

 - 4 Optical drive light** — Blinks when you press the optical drive eject button or when the disc is being read.

 - 5 Optical drive** — Plays or records CDs and DVDs. Ensure that you place the disc with the printed side facing towards you.
-

Using the Optical Drive

 **CAUTION:** Do not press on the disc tray when you open or close it. Keep the tray closed when you are not using the drive.

 **CAUTION:** Do not move the computer while playing or recording a disc.

1. Press the eject button on the optical drive.
2. Place the disc with the printed side facing towards you and snap the disc onto the spindle.
3. Gently push the optical drive tray back into the drive.

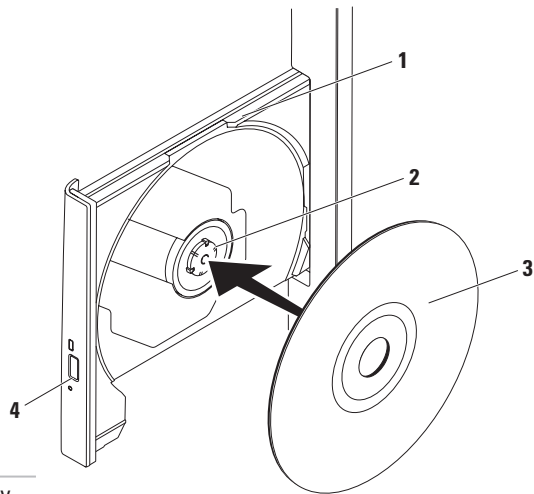

1 optical drive tray

2 spindle

3 disc

4 eject button

Back View Features

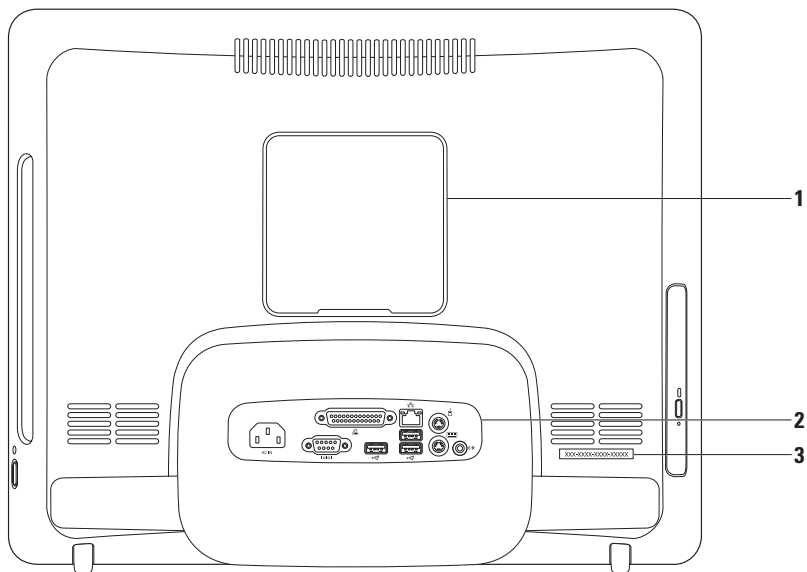



-
- 1 VESA mount cover** — Covers the VESA mount screw holes. Remove this cover to mount your computer on a VESA mount. You can purchase one of many different VESA mounts at www.dell.com.

 - 2 Back panel connectors** — Connects USB, audio, and other devices to the appropriate connectors.

 - 3 Service Tag/Express Service Code** — Use this information to identify your computer on support.dell.com or when you contact technical support.
-

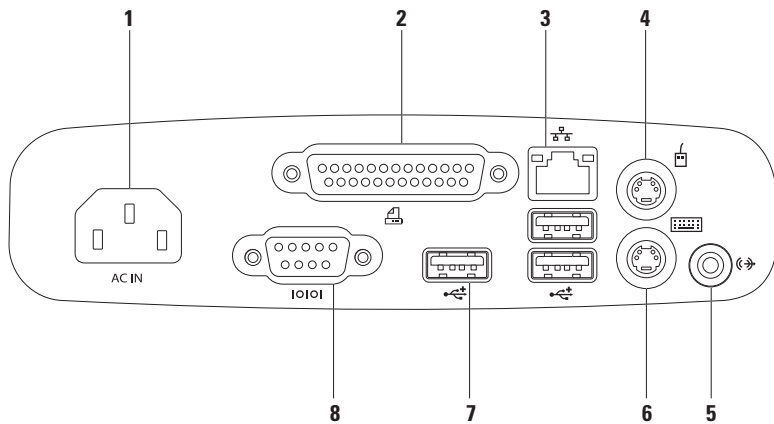
Back Panel Connectors





-
- 1  **Power connector** — Connects to the power cable. The appearance of this connector may vary.

 - 2  **Parallel connector** — Connects to older printers and scanners.

 - 3  **Network connector** — Connects to a network or a broadband device if you are using a wired network. The two lights next to the connector indicate status and activity for wired network connection.

 - 4  **PS/2 mouse connector** — Connects to a standard PS/2 mouse.

 - 5  **Line-out connector** — Connects to a powered speaker or sound system.

 - 6  **PS/2 keyboard connector** — Connects to a standard PS/2 keyboard.

 - 7  **USB 2.0 connectors (3)** — Connects to USB devices, such as a mouse, keyboard, printer, external drive, or MP3 player.

 - 8  **Serial connector** — Connects to older printers and external modems.
-

Display Features

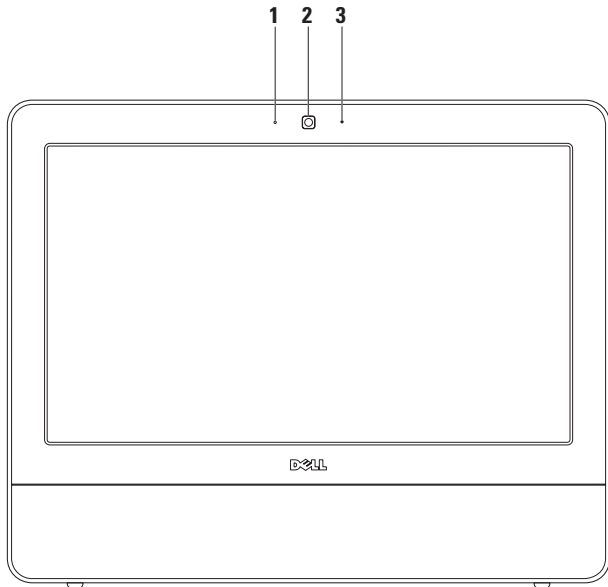

1 Camera activity indicator — Indicates if the camera is on or off.

2 Camera — Built-in camera for video capture, conferencing, and chat.

3 Microphone — Provides high quality sound for video chatting and voice recording.

Using the Touch Screen (Optional)

The touch screen feature on your Inspiron One converts your computer into an interactive display.

Dell Touch Zone

To launch the Dell Touch Zone software click **Start**  → **Dell Touch Zone**.

You can access the following features in the Dell Touch Zone:

- **Picture Viewer** — View, organize, and edit pictures.
- **Dell Touch Cam** — Capture home videos with the built-in camera. You can upload videos to **YouTube** when connected to the Internet.
- **Notes Creator** — Create typed or handwritten reminders. These notes will appear on the bulletin board the next time you access the Dell Touch Zone.

- **Drum Zone** — Play a game to the music on your computer or play synthesized percussion instruments.
- **You Paint** — Draw, paint images, and edit photographs using this software.
- **Games** — Play select Windows games using touch.
- **Music** — Play music, create play lists, and browse through your music files by album, artist, or song title.
- **Internet Explorer** — Browse the Internet using multi-touch technology. Touch a link you want to follow.
- **Help** — Use the Help feature for more information on how to use the touch screen.

Touch Screen Gestures

 **NOTE:** Some of these gestures may not work outside the Dell Touch Zone.

Zoom

Allows you to increase or decrease the magnification of the screen content.

Pinch — Allows you to zoom in or zoom out by moving two fingers apart or bringing them closer together on the screen.



To zoom in: Move two fingers apart to zoom in on the active window.



To zoom out: Move two fingers close together to zoom out on the active window.

Dwell

Allows you to access additional information by simulating a right-click.

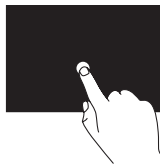

Press and hold a finger on the touch screen to open context-sensitive menus.

Flick

Allows you to flip content forward or backward based on the direction of the flick.

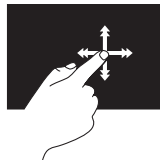

Move a finger quickly in the desired direction to flip through content in the active window, like pages in a book. Flick also works vertically when navigating content such as images or songs in a playlist.

Using Your Inspiron One

Scroll

Allows you to scroll through content.

Pan — Allows you to move the focus on the selected object when the entire object is not visible.

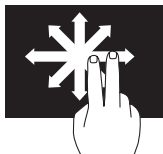

Move two fingers in the desired direction to pan scroll the selected object.

Scroll Vertical — Allows you to scroll up or down on the active window.

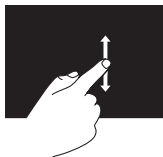

Move a finger up or down to activate vertical scrolling.

Scroll Horizontal — Allows you to scroll left or right on the active window.

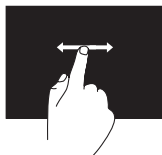

Move a finger to the left or right to activate horizontal scrolling.

Rotate

Allows you to rotate the active content on the screen.

Twist — Allows you to rotate the active content in 90° increments using two fingers.



Keeping a finger or thumb in place, move the other finger in an arced direction to the right or left. You can also rotate the active content by moving both the fingers in a circular motion.

Software Features

 **NOTE:** For more information about the features described in this section, see the *Dell Technology Guide* available on your hard drive or at support.dell.com/manuals.

Productivity and Communication

You can use your computer to create presentations, brochures, greeting cards, fliers, and spreadsheets. You can also edit and view digital photographs and images. Check your purchase order for software installed on your computer.

After connecting to the Internet, you can access websites, set up an e-mail account, upload and download files, and perform other related tasks.

Entertainment and Multimedia

You can use your computer to watch videos, play games, create your own CDs, and listen to music and radio stations. Your optical disc drive may support multiple disc media formats including CDs and DVDs.

You can download or copy pictures and video files from portable devices, such as digital cameras and cell phones. Optional software applications enable you to organize and create music and video files that can be recorded to disc and saved on portable products such as MP3 players and handheld entertainment devices.

Customizing the Desktop

You can use the customizing options available in your operating system to change the appearance, resolution, wallpaper, screensaver, and so on.

1. Right-click an open area of the desktop.
2. Click **Personalize**, to open the **Change the visuals and sounds on your computer** window and learn more about your customization options.

Customizing Your Energy Settings

You can use the power options in your operating system to configure the power settings on your computer. The Microsoft® Windows® operating system installed on your Dell computer provides the following options:

- **Dell** — Recommended default power plan with Dell enhancements. Offers full performance when you need it and saves power during periods of inactivity.

- **Power saver** — Saves power on your computer by reducing system performance to maximize the life of the computer and by reducing the amount of energy consumed by your computer over its lifetime.
- **Balanced** — Automatically balances the performance of your computer by consuming energy on capable hardware.
- **High performance** — Provides the highest level of system performance on your computer by adapting processor speed to your activity and by maximizing system performance.

Transferring Information to a New Computer

To transfer information to a new computer:

1. Click **Start**  → **Control Panel** → **Getting Started** → **Transfer files from another computer**.
2. Follow the instructions on the **Windows Easy Transfer** wizard.

Backing Up Your Data

It is recommended that you periodically back up files and folders on your computer.

To back up files:

1. Click **Start**  → **Control Panel** → **Back Up and Restore**.
2. Click **Set up backup...**
3. Follow the instructions on the **Configure Backup** wizard.

Solving Problems

This section provides troubleshooting information for your computer. If you cannot solve your problem using the following guidelines, see “Using Support Tools” on page 43 or “Contacting Dell” on page 63.

Touch Screen Problems

Some or all multi-touch features are not working —

- Certain touch and multi-touch features may be disabled. To enable them, double-click the **Flicks** icon in the system tray. In the **Pen and Touch** window, select the **Touch** tab and ensure that **Use your finger as an input device** and **Enable multi-touch gestures and inking** options are selected.
- The touch screen is calibrated at the factory, and does not require re-calibration. If you choose to calibrate the touch screen, click **Start**  → **Control panel** → **Tablet PC Settings** → **Calibrate....**



NOTE: Improper calibration may lead to inaccurate touch sensitivity.

If the touch screen starts losing its sensitivity — The touch screen may have foreign particles (such as sticky notes) that are blocking the touch sensors. To remove these particles:

1. Turn off the computer.
2. Disconnect the power cord from the wall outlet.

 **CAUTION: Do not spray water or a cleaning liquid directly on the touch screen.**

3. Use a clean, lint-free cloth (can spray mild, non-abrasive cleaner or water on a cloth if needed, but not on the screen) and wipe the surface and sides of the touch screen to remove any dirt or fingerprints.

Beep Codes

Your computer might emit a series of beeps during start-up if there are errors or problems. This series of beeps, called a beep code, identifies a problem. Write down the beep code and contact Dell (see “Contacting Dell” on page 63).

Series of beeps (Beep code)	Possible Problem
One	Possible motherboard failure - BIOS ROM checksum failure
Two	No RAM detected
Three	Possible motherboard failure - Chipset error
Four	RAM read/write failure
Five	Real Time Clock failure
Six	Video card or chip failure
Seven	Processor failure
Eight	Display failure

Network Problems

Wireless Connections

If the wireless network connection is lost —

The wireless router is offline or wireless has been disabled on the computer.

- Check your wireless router to ensure it is powered on and connected to your data source (cable modem or network hub).
- Interference may be blocking or interrupting your wireless connection. Try moving the computer closer to your wireless router.
- Re-establish your connection to the wireless router (see “Setting Up a Wireless Connection” on page 14).

Wired Connections

If the wired network connection is lost — The cable is loose or damaged.

- Check the cable to ensure it is plugged in and not damaged.

The link integrity light on the integrated network connector lets you verify that your connection is working and provides information on the status:

Link integrity light

- Green — A good connection exists between a 10/100-Mbps network and the computer.
- Orange — A good connection exists between a 1000-Mbps network and the computer.
- Off — The computer is not detecting a physical connection to the network.



NOTE: The link integrity light on the network connector is only for the wired network connection. The link integrity light does not provide status for wireless connections.

Power Problems

If the power light is off — The computer is turned off or not receiving power. There may also be a problem with the system board.

- Press the power button to resume normal operation.
- If the power cable is plugged into a power strip, ensure that the power strip is plugged into an electrical outlet and that the power strip is turned on. Also bypass power protection devices, power strips, and power extension cables to verify that the computer turns on properly.
- Ensure that the electrical outlet is working by testing it with another device, such as a lamp.
- If the problem persists, contact Dell (see “Contacting Dell” on page 63).

If the power light is solid white and the computer is not responding —

Contact Dell (see “Contacting Dell” on page 63).

If the power light is blinking white —

The computer is in sleep state. Press a key on the keyboard, move the mouse, or press the power button to resume normal operation.

If the power light is solid amber —

The system board cannot start initialization. There may be an issue with either the system board or power supply. For assistance, contact Dell (see “Contacting Dell” on page 63).

If the power light is blinking amber —

The computer has detected an error during POST. The light will blink along with the three BIOS beep codes to indicate the error. For assistance, contact Dell (see “Contacting Dell” on page 63).

Solving Problems

If you encounter interference that hinders reception on your computer — An unwanted signal is creating interference by interrupting or blocking other signals. Some possible causes of interference are:

- Power, keyboard, and mouse extension cables.
- Too many devices connected to a power strip.
- Multiple power strips connected to the same electrical outlet.

Memory Problems

If you receive an insufficient memory message —

- Save and close any open files and exit any open programs you are not using to see if that resolves the problem.
- See the software documentation for minimum memory requirements. For assistance, contact Dell (see “Contacting Dell” on page 63).
- Run Dell Diagnostics (see “Dell Diagnostics” on page 46).

If you experience other memory problems —

- Run Dell Diagnostics (see “Dell Diagnostics” on page 46).
- Contact Dell (see “Contacting Dell” on page 63).

Lockups and Software Problems

If the computer does not start up — Ensure that the power cable is firmly connected to the computer and to the electrical outlet.

If a program stops responding —

End the program:

1. Press <Ctrl><Shift><Esc> simultaneously.
2. Click **Applications**.
3. Select the program that is no longer responding
4. Click **End Task**.

If a program crashes repeatedly — Check the software documentation. If necessary, uninstall and then reinstall the program.

 **NOTE:** Software usually includes installation instructions in its documentation or on the CD.

If the computer stops responding or a solid blue screen appears —

 **WARNING:** You might lose data if you are unable to perform an operating system shutdown.

If you are unable to get a response by pressing a key on your keyboard or moving your mouse, press the power button for at least 8 to 10 seconds until the computer turns off and then restart your computer.

If a program is designed for an earlier Microsoft® Windows® operating system —

Run the **Program Compatibility Wizard**. The **Program Compatibility Wizard** configures a program so that it runs in an environment similar to an earlier version of Microsoft Windows operating system environments.

Solving Problems

1. Click **Start** .
2. In the search box, type Use an older program with this version of Windows and press <Enter>.
3. Follow the instructions on the **Program Compatibility** wizard.

If you have other software problems —

- Write down the error code and problem description and contact Dell (see “Contacting Dell” on page 63).
 - Back up your files immediately.
 - Use a virus-scanning program to check the hard drive or CDs.
 - Save and close any open files or programs and shut down your computer through the **Start**  menu.
- Check the software documentation or contact the software manufacturer for troubleshooting information:
 - Ensure that the program is compatible with the operating system installed on your computer.
 - Ensure that your computer meets the minimum hardware requirements needed to run the software. See the software documentation for information.
 - Ensure that the program is installed and configured properly.
 - Verify that the device drivers do not conflict with the program.
 - If necessary, uninstall and then reinstall the program.

Using Support Tools

Dell Support Center

The **Dell Support Center** helps you find the service, support, and system-specific information you need.

To launch the application, click the  icon in the taskbar.

The **Dell Support Center** home page displays your computer's model number, service tag, express service code, and service contact information.

The home page also provides links to access:

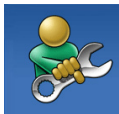

Self Help (Troubleshooting, Security, System Performance, Network/Internet, Backup/Recovery, and Windows operating system)



Alerts (technical support alerts relevant to your computer)



Assistance from Dell (Technical Support with DellConnect™, Customer Service, Training and Tutorials, How-To Help with Dell on Call, and Online Scan with PC CheckUp)



About Your System (System Documentation, Warranty Information, System Information, Upgrades & Accessories)

For more information about **Dell Support Center** and available support tools, click the **Services** tab at support.dell.com.

System Messages

If your computer has an issue or error, it may display a System Message that will help you identify the cause and action needed to resolve the issue.

 **NOTE:** If the message you received is not listed in the following examples, see the documentation for either the operating system or the program that was running when the message appeared. Alternatively you could see the *Dell Technology Guide* available on your hard drive or at support.dell.com/manuals or see “Contacting Dell” on page 63 for assistance.

Alert! Previous attempts at booting this system have failed at checkpoint [nnnn]. For help in resolving this problem, please note this checkpoint and contact Dell Technical Support — The computer failed to complete the boot routine three consecutive times for the same error. Contact Dell for assistance (see “Contacting Dell” on page 63).

CMOS checksum error — Possible motherboard failure or RTC battery low. Contact Dell for assistance (see “Contacting Dell” on page 63).

CPU fan failure — CPU fan has failed. Contact Dell for assistance (see “Contacting Dell” on page 63).

Hard-disk drive failure — Possible hard drive failure during POST. Contact Dell for assistance (see “Contacting Dell” on page 63).

Hard-disk drive read failure — Possible hard drive failure during HDD boot test. Contact Dell for assistance (see “Contacting Dell” on page 63).

Keyboard failure — Keyboard failure or loose cable. If reseating the cable does not solve the problem, replace the keyboard.

No boot device available — No bootable partition on hard drive, the hard drive cable is loose, or no bootable device exists.

- If the hard drive is your boot device, ensure that the cables are connected and that the drive is installed properly and partitioned as a boot device.

- Enter system setup and ensure that the boot sequence information is correct (see the *Dell Technology Guide* available on your hard drive or at support.dell.com/manuals).

No timer tick interrupt — A chip on the system board might be malfunctioning or motherboard failure. Contact Dell for assistance (see “Contacting Dell” on page 63).

USB over current error — Disconnect the USB device. Your USB device needs more power for it to function properly. Use an external power source to connect the USB device, or if your device has two USB cables, connect both of them.

CAUTION - Hard Drive SELF MONITORING SYSTEM has reported that a parameter has exceeded its normal operating range. Dell recommends that you back up your data regularly. A parameter out of range may or may not indicate a potential hard drive problem — S.M.A.R.T error, possible hard drive failure. Contact Dell for assistance (see “Contacting Dell” on page 63).

Hardware Troubleshooter

If a device is either not detected during the operating system setup or is detected but incorrectly configured, you can use the **Hardware Troubleshooter** to resolve the incompatibility.

To start the Hardware Troubleshooter:

1. Click **Start**  → **Help and Support**.
2. Type `hardware troubleshooter` in the search field and press <Enter> to start the search.
3. In the search results, select the option that best describes the problem and follow the remaining troubleshooting steps.

Dell Diagnostics

If you experience a problem with your computer, perform the checks in “Lockups and Software Problems” on page 41 and run the Dell Diagnostics before you contact Dell for technical assistance.

It is recommended that you print these procedures before you begin.

 **NOTE:** Dell Diagnostics works only on Dell computers.

 **NOTE:** The *Drivers and Utilities* disc is optional and may not ship with your computer.

See the *Comprehensive Specifications* to review your computer’s configuration information, and ensure that the device that you want to test appears in the system setup program and is active.

Start the Dell Diagnostics from your hard drive or from the *Drivers and Utilities* disc.

Starting Dell Diagnostics From Your Hard Drive

The Dell Diagnostics is located on a hidden diagnostic utility partition on your hard drive.

 **NOTE:** If your computer cannot display a screen image, contact Dell (see “Contacting Dell” on page 63).

1. Ensure that the computer is connected to an electrical outlet that is known to be working properly.
2. Turn on (or restart) your computer.
3. When the DELL™ logo appears, press <F12> immediately. Select **Diagnostics** from the boot menu and press <Enter>. This may invoke the Pre-Boot System Assessment (PSA) in your computer.

- ✎ **NOTE:** If you wait too long and the operating system logo appears, continue to wait until you see the Microsoft® Windows® desktop; then, shut down your computer and try again.
- ✎ **NOTE:** If you see a message stating that no diagnostics utility partition has been found, run the Dell Diagnostics from the *Drivers and Utilities* disc.

If PSA is invoked:

- a. The PSA starts running tests.
- b. If the PSA completes successfully, the following message is displayed: "No problems have been found with this system so far. Do you want to run the remaining memory tests? This will take about 30 minutes or more. Do you want to continue? (Recommended)."

- c. If you are experiencing memory issues, press <y>, otherwise press <n>.

The following message is displayed:
"Booting Dell Diagnostic Utility Partition. Press any key to continue."

- d. Press any key to go to the **Choose An Option** window.

If PSA is not invoked:

Press any key to start the Dell Diagnostics from the diagnostics utility partition on your hard drive and to go to the **Choose An Option** window.

4. Select the test you want to run.

Using Support Tools

5. If you encounter a problem during a test, a message appears with the error code and a description of the problem will appear on your screen. Write down the error code and problem description and contact Dell (see “Contacting Dell” on page 63).

 **NOTE:** The Service Tag for your computer is displayed at the top of each test screen. The Service Tag helps you identify your computer when you contact Dell.

6. When the tests complete, close the test screen to return to the **Choose An Option** window. To exit the Dell Diagnostics and to restart the computer, click **Exit**.

Starting Dell Diagnostics From the Drivers and Utilities Disc

1. Insert the *Drivers and Utilities* disc.
2. Shut down and restart the computer. When the DELL logo appears, press <F12> immediately.

 **NOTE:** If you wait too long and the operating system logo appears, continue to wait until you see the Microsoft® Windows® desktop; then, shut down your computer and try again.

 **NOTE:** The next steps change the boot sequence for one time only. On the next start-up, the computer boots according to the devices specified in the system setup program.

3. When the boot device list appears, highlight **CD/DVD/CD-RW** and press <Enter>.

4. Select **Run the 32 Bit Dell Diagnostics** from the numbered list. If multiple versions are listed, select the version appropriate for your computer.
 5. Select the test you want to run.
 6. If you encounter a problem during a test, a message with the error code and a description of the problem will appear on your screen. Write down the error code and problem description and contact Dell (see “Contacting Dell” on page 63).
-  **NOTE:** The Service Tag for your computer is displayed at the top of each test screen. The Service Tag helps you identify your computer when you contact Dell.
7. When the tests are complete, close the test screen to return to the **Choose An Option** window.
 8. To exit the Dell Diagnostics and restart the computer, click **Exit**.
 9. Remove the *Drivers and Utilities* disc.

Restoring Your Operating System

You can restore your operating system in the following ways:

- System Restore returns your computer to an earlier operating state without affecting data files. Use System Restore as the first solution for restoring your operating system and preserving data files.
- Dell Factory Image Restore returns your hard drive to the operating state it was in when you purchased the computer. This procedure permanently deletes all data on the hard drive and remove any programs installed after you received the computer. Use Dell Factory Image Restore only if System Restore did not resolve your operating system problem.

- If you received an *Operating System* disc with your computer, you can use it to restore your operating system. However, using the *Operating System* disc also deletes all data on the hard drive. Use the *Operating System* disc only if neither System Restore nor Dell Factory Image Restore did not resolve your operating system problem.



System Restore

The Windows operating systems provide a System Restore option which allows you to return your computer to an earlier operating state (without affecting data files) if changes to the hardware, software, or other system settings have left the computer in an undesirable operating state. Any changes that System Restore makes to your computer are completely reversible.

 **CAUTION: Make regular backups of your data files. System Restore does not monitor your data files or recover them.**

 **NOTE:** The following instructions are applicable to the Windows default view, so they may not apply if you set your Dell™ computer to the Windows Classic view.

Starting System Restore

1. Click **Start** .
2. In the **Start Search** box, type `System Restore` and press <Enter>.
-  **NOTE:** The **User Account Control** window may appear. If you are an administrator on the computer, click **Continue**; otherwise, contact your administrator to continue the desired action.
3. Click **Next** and follow the remaining prompts on the screen.

In the event that System Restore did not resolve the issue, you may undo the last system restore.

Undoing the Last System Restore

 **NOTE:** Before you undo the last system restore, save and close all open files and exit any open programs. Do not alter, open, or delete any files or programs until the system restoration is complete.

1. Click **Start** .
2. In the **Start Search** box, type `System Restore` and press <Enter>.
3. Click **Undo my last restoration** and click **Next**.

Dell Factory Image Restore

 **CAUTION:** Using Dell Factory Image Restore permanently deletes all data on the hard drive and removes any programs or drivers installed after you received your computer. If possible, back up all the data before using this option. Use Dell Factory Image Restore only if System Restore did not resolve your operating system problem.

 **NOTE:** Dell Factory Image Restore is not available if the hard drive is formatted or partitioned using the Operating System disc.

 **NOTE:** Dell Factory Image Restore may not be available in certain countries or on certain computers.

Use Dell Factory Image Restore only as the last method to restore your operating system. This option restores your hard drive to the operating state it was in when you purchased the computer. Any programs or files added since you received your computer—including data files—are permanently deleted from the hard drive. Data files include documents, spreadsheets, e-mail messages, digital photos, music files, and so on. If possible, back up all data before using Factory Image Restore.

Performing Dell Factory Image Restore

1. Turn on the computer. When the Dell logo appears, press <F8> several times to access the **Advanced Boot Options** Window.
 **NOTE:** If you wait too long and the operating system logo appears, wait until you see the Microsoft® Windows® desktop; then, shut down your computer and try again.
2. Select **Repair Your Computer**.
3. The **System Recovery Options** window appears.
4. Select a keyboard layout and click **Next**.
5. To access the recovery options, log on as a local user. To access the command prompt, type `administrator` in the **User name** field, then click **OK**.

6. Click **Dell Factory Image Restore**. The **Dell Factory Image Restore** welcome screen appears.

 **NOTE:** Depending upon your configuration, you may need to select **Dell Factory Tools**, then **Dell Factory Image Restore**.

7. Click **Next**. The **Confirm Data Deletion** screen appears.

 **NOTE:** If you do not want to proceed with Factory Image Restore, click **Cancel**.

8. Select the check box to confirm that you want to continue reformatting the hard drive and restoring the system software to the factory condition, then click **Next**.

The restore process begins and may take five or more minutes to complete. A message appears when the operating system and factory-installed applications have been restored to factory condition.

9. Click **Finish** to reboot the computer.

Operating System Reinstallation

Before You Begin

If you are considering reinstalling the Windows operating system to correct a problem with a newly installed driver, first try using Windows Device Driver Rollback.

To roll back a device driver:

1. Click **Start** .
2. Right-click **Computer**.
3. Click **Properties** → **Device Manager**.
4. Right-click the device for which the new driver was installed, and click **Properties**.
5. Click the **Drivers** tab → **Roll Back Driver**.

If Device Driver Rollback does not resolve the problem, then use System Restore to return your operating system to the operating state it was in before you installed the new device driver. See “System Restore” on page 50.

 **CAUTION:** Before performing the installation, back up all data files on your primary hard drive. For conventional hard drive configurations, the primary hard drive is the first drive detected by the computer.

To reinstall Windows, you need the following:

- Dell *Operating System* disc
- Dell *Drivers and Utilities* disc

 **NOTE:** The *Drivers and Utilities* disc contains drivers that were installed during the assembly of the computer. Use the Dell *Drivers and Utilities* disc to load any required drivers. Depending on the region from which you ordered your computer, or whether you requested the disc, the Dell *Drivers and Utilities* disc and *Operating System* disc may not ship with your computer.

Reinstalling Microsoft Windows

The reinstallation process can take 1 to 2 hours to complete. After you reinstall the operating system, you must also reinstall the device drivers, virus protection program, and other software.

1. Save and close any open files and exit any open programs.
2. Insert the *Operating System* disc.
3. Click **Exit** if the **Install Windows** message appears.
4. Restart the computer.
5. When the DELL logo appears, press <F12> immediately.

 **NOTE:** If you wait too long and the operating system logo appears, continue to wait until you see the Microsoft® Windows® desktop; then, shut down your computer and try again.

 **NOTE:** The next steps change the boot sequence for one time only. On the next start-up, the computer boots according to the devices specified in the system setup program.

6. When the boot device list appears, highlight **CD/DVD/CD-RW Drive** and press <Enter>.
7. Press any key to **Boot from CD-ROM**. Follow the instructions on the screen to complete the installation.

Getting Help

If you experience a problem with your computer, you can complete the following steps to diagnose and troubleshoot the problem:

1. See “Solving Problems” on page 36 for information and procedures that pertain to the problem your computer is experiencing.
2. See the *Dell Technology Guide* for more troubleshooting information.
3. See “Dell Diagnostics” on page 46 for procedures on how to run Dell Diagnostics.
4. Fill out the “Diagnostic Checklist” on page 62.
5. Use Dell’s extensive suite of online services available at Dell Support (support.dell.com) for help with installation and troubleshooting procedures. See “Online Services” on page 58 for a more extensive list of Dell Support online.
6. If the preceding steps have not resolved the problem, see “Before You Call” on page 61.



NOTE: Call Dell Support from a telephone near or at the computer so that the support staff can assist you with any necessary procedures.



NOTE: Dell’s Express Service Code system may not be available in all countries.

When prompted by Dell’s automated telephone system, enter your Express Service Code to route the call directly to the proper support personnel. If you do not have an Express Service Code, open the **Dell Accessories** folder, double-click the **Express Service Code** icon, and follow the directions.



NOTE: Some of the services are not always available in all locations outside the continental U.S. Call your local Dell representative for information on availability.

Technical Support and Customer Service

Dell's support service is available to answer your questions about Dell hardware. Our support staff use computer-based diagnostics to provide fast, accurate answers.

To contact Dell's support service, see "Before You Call" on page 61 and then see the contact information for your region or go to **support.dell.com**.

DellConnect

DellConnect™ is a simple online access tool that allows a Dell service and support associate to access your computer through a broadband connection, diagnose your problem and repair it all under your supervision. For more information, go to **www.dell.com/dellconnect**.

Online Services

You can learn about Dell products and services on the following websites:

- **www.dell.com**
- **www.dell.com/ap** (Asian/Pacific countries only)
- **www.dell.com/jp** (Japan only)
- **www.euro.dell.com** (Europe only)
- **www.dell.com/la** (Latin American and Caribbean countries)
- **www.dell.ca** (Canada only)

You can access Dell Support through the following websites and e-mail addresses:

Dell Support websites

- **support.dell.com**
- **support.jp.dell.com** (Japan only)
- **support.euro.dell.com** (Europe only)
- **supportapj.dell.com** (Asia Pacific only)

Dell Support e-mail addresses

- **mobile_support@us.dell.com**
- **support@us.dell.com**
- **la-techsupport@dell.com** (Latin America and Caribbean countries only)
- **apsupport@dell.com** (Asian/Pacific countries only)

Dell Marketing and Sales e-mail addresses

- **apmarketing@dell.com** (Asian/Pacific countries only)
- **sales_canada@dell.com** (Canada only)

Anonymous file transfer protocol (FTP)

- **ftp.dell.com**
Log in as user: `anonymous`, and use your e-mail address as your password.

Automated Order-Status Service

To check on the status of any Dell products that you have ordered, you can go to **support.dell.com**, or you can call the automated order-status service. A recording prompts you for the information needed to locate and report on your order. For the telephone number to call your region, see “Contacting Dell” on page 63.

If you have a problem with your order, such as missing parts, wrong parts, or incorrect billing, contact Dell for customer assistance. Have your invoice or packing slip handy when you call. For the telephone number to call for your region, see “Contacting Dell” on page 63.

Product Information

If you need information about additional products available from Dell, or if you would like to place an order, visit **www.dell.com**. For the telephone number to call for your region or to speak to a sales specialist, see “Contacting Dell” on page 63.

Returning Items for Repair Under Warranty or for Credit

Prepare all items being returned, whether for repair or credit, as follows:

 **NOTE:** Before you return the product to Dell, make sure to back up any data on the hard drive and on any other storage device in the product. Remove any and all confidential, proprietary and personal information, as well as removable media, such as CDs and PC Cards. Dell is not responsible for any of your confidential, proprietary or personal information; lost or corrupted data; or damaged or lost removable media that may be included with your return.

1. Call Dell to obtain a Return Material Authorization Number, and write it clearly and prominently on the outside of the box.
 **NOTE:** For the telephone number to call for your region, see “Contacting Dell” on page 63.
2. Include a copy of the invoice and a letter describing the reason for the return.
3. Include a copy of the Diagnostics Checklist (see “Diagnostic Checklist” on page 62), indicating the tests that you have run and any error messages reported by the Dell Diagnostics (see “Dell Diagnostics” on page 46).
4. Include any accessories that belong with the item(s) being returned (power cables, software, guides, and so on) if the return is for credit.

5. Pack the equipment to be returned in the original (or equivalent) packing materials.

 **NOTE:** You are responsible for paying shipping expenses. You are also responsible for insuring any product returned, and you assume the risk of loss during shipment to Dell. Collect On Delivery (C.O.D.) packages are not accepted.

 **NOTE:** Returns that are missing any of the preceding requirements will be refused at Dell's receiving dock and returned to you.

Before You Call

 **NOTE:** Have your Express Service Code ready when you call. The code helps Dell's automated-support telephone system direct your call more efficiently. You may also be asked for your Service Tag (located on the back of your computer).

Remember to fill out the following Diagnostic Checklist. If possible, turn on your computer before you call Dell for assistance and call from a telephone at or near the computer. You may be asked to type some commands at the keyboard, relay detailed information during operations, or try other troubleshooting steps possible only at the computer itself. Ensure that the computer documentation is available.

Diagnostic Checklist

- Name:
- Date:
- Address:
- Phone number:
- Service Tag (bar code on the back of the computer):
- Express Service Code:
- Return Material Authorization Number (if provided by Dell support technician):
- Operating system and version:
- Devices:
- Expansion cards:
- Are you connected to a network? Yes/No
- Network, version, and network adapter:
- Programs and versions:

See your operating system documentation to determine the contents of the computer's start-up files. If the computer is connected to a printer, print each file. Otherwise, record the contents of each file before calling Dell.

- Error message, beep code, or diagnostic code:
- Description of problem and troubleshooting procedures you performed:

Contacting Dell

For customers in the United States, call 800-WWW-DELL (800-999-3355).

 **NOTE:** If you do not have an active Internet connection, you can find contact information on your purchase invoice, packing slip, bill, or Dell product catalog.

Dell provides several online and telephone-based support and service options. Availability varies by country and product, and some services may not be available in your area.

To contact Dell for sales, technical support, or customer service issues:

1. Visit **www.dell.com/contactdell**.
2. Select your country or region.
3. Select the appropriate service or support link based on your requirement.
4. Choose the method of contacting Dell that is convenient for you.

Finding More Information and Resources

If you need to:

reinstall your operating system

run a diagnostic program for your computer, reinstall desktop system software, or update drivers for your computer, and readme files

learn more about your operating system, maintaining peripherals, RAID, Internet, Bluetooth®, networking, and e-mail

find safety best practices information for your computer

review Warranty information, Terms and Conditions (U.S. only), Safety instructions, Regulatory information, Ergonomics information, and End User License Agreement

See:

the *Operating System* disc

the *Drivers and Utilities* disc



NOTE: Drivers and documentation updates can be found at **support.dell.com**.

the *Dell Technology Guide* available on your hard drive or at **support.dell.com/manuals**

the safety and regulatory documents that shipped with your computer and also see the Regulatory Compliance Homepage at **www.dell.com/regulatory_compliance**

If you need to:

find your Service tag/Express Service Code —
You must use the service tag to identify your
computer on **support.dell.com** or to contact
technical support

find drivers and downloads

access technical support and product help

check on your order status for new purchases

find solutions and answers to common
questions

locate information for last-minute updates
about technical changes to your computer or
advanced technical-reference material for
technicians or experienced users

See:



the back of your computer

the **Dell Support Center**. To launch the **Dell
Support Center**, click the  icon in the
taskbar.

support.dell.com

Basic Specifications

This section provides information that you may need when setting up, updating drivers for, and upgrading your computer. For more detailed specifications, see the *Comprehensive Specifications* at support.dell.com/manuals.

 **NOTE:** Offerings may vary by region. For more information regarding the configuration of your computer, click **Start**  → **Help and Support** and select the option to view information about your computer.

Computer Model

Inspiron One 19T

Computer Information

Processor types	Intel® Celeron® Dual-Core Intel Pentium® Dual-Core Intel Core™2 Duo Intel Core2 Quad
System chipset	Intel G41+ICH7

Drives and Devices

Drives	One 3.5-inch internal hard-drive and one tray-load optical drive
Wireless (optional)	LAN 802.11 b/g
Camera	1.3 megapixel

Drives and Devices

Available devices	Serial ATA hard drive, DVD-ROM (optional), DVD+/- RW (optional), microphone array, and 8-in-1 Media Card Reader
-------------------	---

Memory

Type	Dual channel 800 MHz DDR2
Minimum	1 GB
Maximum	4 GB

External Connectors

Network adapter	RJ45 connector
USB 2.0	Three side-panel and three back-panel connectors
Audio	Two side-panel connectors for microphone/line-in and headphone/line-out; one back-panel connector for line-out
IEEE 1394a	one side-panel 4-pin serial connector

Basic Specifications

Video

Type Intel X4500

Audio

Type Integrated speakers

Display

Type 18.5 inches, 16:9,
(active-matrix TFT) WXGA

Maximum resolution 1366 x 768

Power

Wattage 130 W

Voltage 100-240 VAC

Backup battery 3-V CR2032 lithium
coin cell

Physical

Height 385.9 mm
(15.2 inches)

Width 476.9 mm
(18.8 inches)

Depth 107.3 mm
(4.2 inches)

Weight (approximate) 8.3 kg
(18.3 lb)

Computer Environment

Temperature ranges:

Operating 10°C to 35°C
(50°F to 95°F)

Storage -40°C to 65°C
(-40°F to 149°F)

Relative humidity 10% to 90%
(non-condensing)

Computer Environment

Maximum vibration (using a random-vibration spectrum that simulates user environment):

Operating	0.26 GRMS random for 2 min in all operational orientations
Storage	2.2 GRMS random for 15 mins

Maximum shock:

Operating	Half-Sine Pulse: 40G for 2ms with a change in velocity of 20 in/s (51 cm/s)
Storage	Half-Sine Pulse: 40G for 22 ms with a change in velocity of 240 in/s (609 cm/s)

Computer Environment

Altitude:

Operating	-15.2 to 3048 m (-50 to 10,000 ft)
Storage	-15.2 to 10,668 m (-50 to 35,000 ft)
Airborne containment level	G2 or lower as defined by ISA-S71.04-1985

Appendix

Macrovision Product Notice

This product incorporates copyright protection technology that is protected by method claims of certain U.S. patents and other intellectual property rights owned by Macrovision Corporation and other rights owners. Use of this copyright protection technology must be authorized by Macrovision Corporation, and is intended for home and other limited viewing uses only unless otherwise authorized by Macrovision Corporation. Reverse engineering or disassembly is prohibited.

Information for NOM, or Official Mexican Standard (Only for Mexico)

The following information is provided in the device(s) described in this document in accordance with the requirements of the Official Mexican Standard (NOM):

Importer:

Dell México S.A. de C.V.

Paseo de la Reforma 2620 - 11°

Col. Lomas Altas

11950 México, D.F.

Regulatory model number	Voltage	Frequency	Electricity consumption
W01B	100–240 V CA	50–60 Hz	1–2 A

For details, read the safety information that shipped with your computer.

For additional safety best practices information, see the Regulatory Compliance Homepage at www.dell.com/regulatory_compliance.

Index

A

- airflow, allowing **5**
- audio **68**

B

- backups
 - creating **35**

C

- calling Dell **61**
- CDs, playing and creating **33**
- chipset **66**
- computer
 - weights and dimensions **68**
- computer capabilities **33**
- computer environment **68**

- computer, setting up **5**
- connect(ing)
 - optional network cable **8**
- conserving energy **34**
- Contacting Dell online **63**
- customer service **57**
- customizing
 - your desktop **33**
 - your energy settings **34**

D

- DellConnect **57**
- Dell Diagnostics **46**
- Dell Factory Image Restore **50**
- Dell Support Center **43**

Dell Technology Guide
 for further information **64**

Dell Touch Zone **30**

Diagnostic Checklist **61**

disc drive
 supported disc sizes **22**

discs
 using **22**

drivers and downloads **65**

drives and devices **66**

DVDs, playing and creating **33**

E

email addresses
 for technical support **58**

energy
 conserving **34**

expansion bus **68**

F

finding more information **64**

flick **31**

front-side connectors **16**

FTP login, anonymous **58**

G

gestures **31**

H

hard drive activity light **17**

hardware problems
 diagnosing **45**

Hardware Troubleshooter **45**

headphone
 front connector **19**

help
 getting assistance and support **56**

I

Internet connection **13**

ISP

Internet Service Provider **13**

L

line-in connector **19**

M

media card reader **19**

memory

minimum and maximum **67**

memory problems

solving **40**

Memory Stick reader **19**

memory support **67**

microphone connector **19**

MMC **19**

Multi Media Card reader **19**

N

network connection

fixing **38**

network speed

testing **38**

P

physical specifications **68**

ports and connectors **67**

power button and light **17**

power problems, solving **39**

power specifications **68**

problems, solving **36**

products

information and purchasing **59**

R

- reinstalling Windows **50**
- resources, finding more **64**
- restoring factory image **52**

S

- setup, before you begin **5**
- shipping products
 - for return or repair **60**
- software features **33**
- software problems **41**
- solving problems **36**
- specifications **66**
- support email addresses **58**
- support sites
 - worldwide **57**

System Messages **44**

System Restore **50**

T

- touch screen **30**
 - gestures **31**

U

- USB 2.0
 - back connectors **27**

V

- ventilation, ensuring **5**

Index

W

warranty returns **60**

Windows **50**

 Program Compatibility Wizard **41**

 reinstalling **55**

wireless network connection **38**

X

xD-Picture Card reader **19**



Printed in the U.S.A.

www.dell.com | support.dell.com



01HNXJA00