



Dell™ OptiPlex™ GX1 Low-Profile Managed PC Systems Reference and Installation Guide

[Introduction](#)

[Using The System Setup Program](#)

[Using the ISA Configuration Utility](#)

[Working Inside Your Computer](#)

[Installing System Board Options](#)

[Installing Drives](#)

[Technical Specifications](#)

[ISA Configuration Utility Messages](#)



NOTE: You can obtain the latest version of this document from the Dell Web support site at <http://support.dell.com>.

Model DCS

Information in this document is subject to change without notice.

© 1994-2000 Dell Computer Corporation. All rights reserved.

Reproduction in any manner whatsoever without the written permission of Dell Computer Corporation is strictly forbidden.

Trademarks used in this text: *Dell*, *OptiPlex*, *DellWare*, *Dell OpenManage*, and the *DELL* logo are trademarks of Dell Computer Corporation; *Intel* and *Pentium* are registered trademarks, and *MMX* is a trademark of Intel Corporation; *Microsoft*, *MS-DOS*, *Windows*, and *Windows NT* are registered trademarks, and *Windows for Workgroups* is a trademark of Microsoft Corporation; *IBM* and *OS/2* are registered trademarks of International Business Machines Corporation; *3Com* and *EtherLink* are registered trademarks, and *Fast EtherLink* is a trademark of 3Com Corporation; *VESA* is a registered trademark of Video Electronics Standards Association; *UNIX* is a registered trademark of The Open Group in the United States and other countries. As an Energy Star Partner, Dell Computer Corporation has determined that this product meets the Energy Star guidelines for energy efficiency.

Other trademarks and trade names may be used in this document to refer to either the entities claiming the marks and names or their products. Dell Computer Corporation disclaims any proprietary interest in trademarks and trade names other than its own.

Initial release: 7 Dec 1998

Last revised: 31 Jan 2000

[Back to Contents Page](#)

Introduction: Dell™ OptiPlex™ GX1 Low-Profile Managed PC Systems

- [Overview](#)
- [System Features](#)
- [Hardware Features](#)
- [Software Features](#)
- [Manageability Features](#)
- [Connecting Peripheral Devices](#)
- [Using the Power Switch](#)
- [Using the Optional Stand for Vertical Orientation](#)
- [ENERGY STAR® Compliance](#)
- [Accessing Online Documentation](#)
- [Getting Help](#)

Overview

Dell OptiPlex GX1 low-profile Managed PC systems are high-speed, expandable personal computers designed around the Intel® Pentium® II and Pentium III microprocessors. Each computer system uses a high-performance Peripheral Component Interconnect (PCI) design that allows you to configure the computer system to your initial requirements and then add Dell-supported upgrades as necessary. These systems also support the Industry-Standard Architecture (ISA) bus for older expansion devices.

System Features

Your system offers the following features:

- An Intel Pentium II or Pentium III microprocessor.

The Intel Pentium II and Pentium III microprocessors include MMX™ technology designed to handle complex multimedia and communications software. This microprocessor incorporates new instructions and data types as well as a technique called single instruction, multiple data (SIMD) that allows the microprocessor to process multiple data elements in parallel, thereby improving overall system performance.

- A keyboard command (<Ctrl><Alt><|>) that lets you switch between the microprocessor's rated speed and a slower compatibility speed.



NOTE: This keyboard command is not available under the Microsoft® Windows NT® and IBM® OS/2® operating systems.

- A secondary cache of 512 kilobytes (KB) of static random-access memory (SRAM) included within the single-edge contact (SEC) cartridge, which also contains the microprocessor.
- System memory that can be increased up to 768 megabytes (MB) by installing 32-, 64-, 128-, or 256-MB synchronous dynamic random-access memory (SDRAM) dual in-line memory modules (DIMMs) in

the three DIMM sockets on the system board. The system also supports both error checking and correction (ECC) and nonparity DIMMs. See "[Adding Memory](#)" for details.

- Self-Monitoring and Analysis Reporting Technology II (SMART II) support, which warns you at system start-up if your hard-disk drive has become unreliable. To take advantage of this technology, you must have a SMART II-compliant hard-disk drive in your computer. All hard-disk drives shipped with OptiPlex GX1 systems are SMART II-compliant.
- A basic input/output system (BIOS), which resides in flash memory and can be upgraded by diskette, or remotely over a network, if required.
- Full compliance with PCI specification 2.2.
- Full Plug and Play version 1.0a capability, which greatly simplifies the installation of expansion cards. Plug and Play support included in the system BIOS allows you to install Plug and Play expansion cards without setting jumpers or switches or performing other configuration tasks. The ISA Configuration Utility (ICU) allows you to configure existing non-Plug and Play ISA expansion cards for conflict-free operation. Also, because the system BIOS is stored in flash memory, it can be updated to support future enhancements to the Plug and Play standard.
- Wakeup On LAN capability, which, when enabled in the System Setup program, allows the system to be powered up from a server management console. Wakeup On LAN capability also allows remote computer setup, software downloading and installation, file updates, and asset tracking after hours and on weekends when network traffic is at a minimum. For more information, refer to "[Using the System Setup Program](#)."
- Universal Serial Bus (USB) capability, which can simplify connecting peripheral devices such as mice, printers, and computer speakers. The USB connectors on your computer's back panel, which are enabled by default, provide a single connection point for multiple USB-compliant devices. USB-compliant devices can also be connected and disconnected while the system is running.
- A modular computer chassis with a minimum number of screws for easy disassembly and improved serviceability.

Hardware Features

The system board includes the following integrated features:

- Three expansion slots on a riser board with one 32-bit PCI slot, one 16-bit ISA slot, and one shared PCI/ISA slot.
- A 64-bit accelerated graphics port (AGP) video subsystem, which includes the ATI 3D Rage Pro super video graphics array (SVGA) video controller. This video subsystem contains 4 MB (upgradable to 8 MB) of synchronous graphics random-access memory (SGRAM) video memory. Maximum resolutions are 1600 × 1200 with 65,536 colors noninterlaced and 1280 × 1024 and 1024 × 768 with true-colors noninterlaced. In 800 × 600 and 640 × 480 resolutions, 16.7 million colors are available for true-color graphics using a 32-bits per pixel (bpp) format. True-color provides higher performance, but uses more graphics memory. Table 1 lists the video memory requirements for the Microsoft Windows® 95, Windows 98, and Windows NT 4.0 operating systems.

Table 1. Video Memory Requirements

Video Resolution	Maximum Color Depth	Maximum Refresh Rate	Minimum SGRAM Required
640 × 480	True-color (32 bpp)	85 Hz	4 MB
800 × 600	True-color (32 bpp)	85 Hz	4 MB

1024 x 768	True-color (32 bpp)	85 Hz	4 MB
1280 x 1024	True-color (32 bpp)	75 Hz	8 MB
1600 x 1200	65,536 colors (16 bpp)	75 Hz	8 MB

2X AGP provides a dedicated bus from the video subsystem to the system chip set. AGP-based video subsystems have two significant performance advantages over PCI-based video subsystems:

- The AGP bus reduces bandwidth requirements of the PCI bus, improving overall system performance.
- The AGP bus allows a 3D video subsystem to execute directly from main memory.
- A diskette/tape drive interface, which supports a 3.5-inch diskette drive and, optionally, a second diskette drive or tape drive.
- Enhanced integrated drive electronics (EIDE) support. The primary and secondary interface are both located on the PCI bus to provide faster data throughput. Each interface supports high-capacity EIDE drives, as well as devices such as ATA 33 hard-disk drives, EIDE CD-ROM drives, and EIDE tape drives.
- Two high-performance serial ports and one bidirectional parallel port for connecting external devices. The parallel port is fully Enhanced Capabilities Port (ECP)-compliant.
- A Personal System/2 (PS/2)-style keyboard port and a PS/2-compatible mouse port.
- An optional integrated, 10/100-megabit-per-second (Mbps) 3Com® PCI 3C905B-TX Ethernet network interface controller (NIC). The NIC is configured using software on the *Dell ResourceCD*.
- A 16-bit, integrated Plug and Play Crystal CS4236B audio controller that provides all the sound functions of the Sound Blaster Pro expansion card. For information, see your online *System User's Guide*.

Software Features

The following software is included with your Dell computer system:

- System utilities that safeguard your system and enhance the operation of its features. More information is available on the *Dell ResourceCD*.
- Video drivers for displaying many popular application programs in high-resolution modes. More information is available on the *Dell ResourceCD*.
- Audio drivers for enabling the sound functions on the expansion sound card. More information is available on the *Dell ResourceCD*.
- Bus-mastering EIDE drivers to improve performance by off-loading certain functions from the microprocessor during multithreaded operation (when several applications are running simultaneously). More information is available on the *Dell ResourceCD*.
- The System Setup program for quickly viewing and changing the system configuration information for your system. For more information on this program, see "[Using the System Setup Program](#)."
- Enhanced security features (a setup password, a system password, a system-password lock option, a write-protect option for diskette drives, and automatic display of the system's service tag number) available through the System Setup program. In addition, a customer-definable asset tag number can be assigned via a software support utility and viewed on the System Setup screens. For more information, see your online *System User's Guide* and "[Using the System Setup Program](#)."
- Advanced power management options that can reduce the energy consumption of your system. For more information, see "[Using the System Setup Program](#)."

- The ICU, which tells you how to configure ISA expansion cards manually. After resources have been assigned to these cards, the system BIOS can assign resources to PCI and Plug and Play expansion cards for a conflict-free configuration. For more information, see "[Using the ISA Configuration Utility.](#)"
 - Dell Diagnostics for evaluating the computer's components and devices. For information on using the diagnostics, see the chapter titled "Running the Dell Diagnostics" in the *Diagnostics and Troubleshooting Guide*.
 - Network device drivers for several network operating systems. More information is available on the *Dell ResourceCD*.
 - Desktop Management Interface (DMI) support, which enables the management of your computer system's software and hardware. DMI defines the software, interfaces, and data files that enable your system to determine and report information about system components.
-

Manageability Features

Your Dell OptiPlex GX1 Managed PC system incorporates many hardware and software features to improve the manageability of the system. Installed features include the following:

- [Dell OpenManage program](#)
- [Preboot eXecution Environment \(PXE\)](#)
- [Wakeup On LAN](#)
- [Auto Power On](#)
- [Temperature monitoring](#)
- [Security features](#)

Dell OpenManage Program

The Dell OpenManage program is the Dell software-management application interface for DMI. It allows you to manage system-level information, such as system configuration information and Management Information Format (MIF) database values (see Figure 1).

Figure 1. Dell OpenManage Program



On systems running Windows 95, Windows 98, and Windows NT 4.0, the Dell OpenManage program is available in client and administrator versions. The Dell OpenManage administrator version enables system administrators to view, manage, and inventory remote systems in a Dell DMI client network and incorporates the following manageability features, which are based on the DMI 2.0 specification.

Fault Management

Fault management features of the Dell OpenManage include the following:

- Alerts to warn you about events generated by SMART drives on a local or remote system and about thermal errors
- An event log that stores events in a text file and reports information about the event under the following options: System Name, Component Name, Date and Time, Event Type, Event Severity, Event Class, Event System

Configuration Management

Configuration management features of the Dell OpenManage include the following:

- Wakeup On LAN support, which allows network administrators to remotely turn on Managed PC systems with Wakeup On LAN capability in a Dell DMI network.
- A System Properties window that enables network administrators to view, set, or disable certain hardware configuration settings for the local and remote systems in a Dell DMI network.
- Support for the Microsoft System Management Server (SMS), which allows the exporting of one or more groups to an SMS directory that the SMS administrator can access.
- A Monitor component for systems running Windows 95 and having a display data channel (DDC)-compliant video subsystem and monitor.
- Automated inventory control of one or more groups for the remote systems in a Dell DMI network. Network administrators can automate inventory to occur every day, week, or month at a certain hour,

on the hour; or you can enable inventory as needed. The Dell OpenManage creates a text file for the group(s) and saves it to a user-defined directory.

- Support for the application program used to create user-definable attributes (UDAs).

Asset Management

Asset management features of the Dell OpenManage include the following:

- Support that enables network administrators to remotely view, enter, and modify an asset tag for a remote system in a Dell DMI network
- Automated and manual mapping of one or more groups to a user-defined directory

Security Management

Security management features of the Dell OpenManage include the following:

- Password security that enables network administrators to maintain standard attribute values for the local and remote systems in a Dell DMI network

For more information about the Dell OpenManage, refer to the online Dell OpenManage Help that accompanied the software.

PXE

The Preboot eXecution Environment (PXE) allows a personal computer to be managed by one or more configuration management servers running the LANdesk Configuration Manager (LCM) software, which provides management services for the many Managed PC systems on the network. The LCM allows network administrators to do the following:

- Provide preboot support for a new Managed PC system that depends on the server for its initial operating system installation
- Service the network boot requests from the Managed PC systems
- Download diagnostics and BIOS update utilities
- Format the hard-disk drive, if required
- Download and install the operating system, based on previously established profiles
- Download and install applications software
- Update the operating system and applications as required

For additional information about the Intel LCM, refer to the documentation that accompanied the software.

Wakeup On LAN

The Wakeup On LAN feature allows you to remotely turn on a Managed PC system that is in a sleep state. The ability to turn on the Managed PC systems remotely allows you to perform remote computer setup, software downloading and installation, file updates, and asset tracking after hours and on weekends when users are not using the systems and network traffic is at a minimum.

To use the Wakeup On LAN feature, each Managed PC system must contain a NIC that supports Wakeup On LAN. You must also enable the Wakeup On LAN option in the System Setup program.

Auto Power On

Auto Power On enables you to turn on the computer system automatically on certain days of the week at a preset time. You can set Auto Power On to turn on the system either every day or every Monday through Friday.

 *NOTE: This feature does not work if the system is shut off using a power strip or surge protector.*

Temperature Monitoring

Your system includes temperature probes to sense when the processor becomes overheated. In such a case, a message appears on the screen when Dell OpenManage is running or at the next system start-up notifying you of the problem.

Security Features

Your Dell OptiPlex GX1 system has the following integrated security features.

Chassis Intrusion

A built-in chassis intrusion alarm displays the status of the system chassis intrusion monitor. If the computer cover is removed, the setting changes to Detected and the following message appears during the boot sequence at the next system start-up:

Alert! Cover was previously removed.

The field can be cleared using the System Setup program to enable future intrusions to be detected. For more information, see "[Using the System Setup Program](#)."

Security Cable Slot and Padlock Ring

On the back of the computer are a security cable slot and padlock ring (see [Figure 2](#)) for attaching commercially available antitheft devices. Security cables for personal computers usually include a segment of galvanized cable with an attached locking device and key. To prevent unauthorized removal of your computer, loop the cable around an immovable object, insert the locking device into the security cable slot on the back of your computer, and lock the device with the key provided. Complete instructions for installing this kind of antitheft device are usually included with the device.

 *NOTE: Antitheft devices are of differing designs. Before purchasing such a device, make sure it will work with the cable slot on your computer.*

The padlock ring allows you to secure the computer cover to the chassis to prevent unauthorized access to the inside of the computer. To use the padlock ring, insert a commercially available padlock through the ring and then lock the padlock.

Figure 2. Security Cable Slot and Padlock Ring

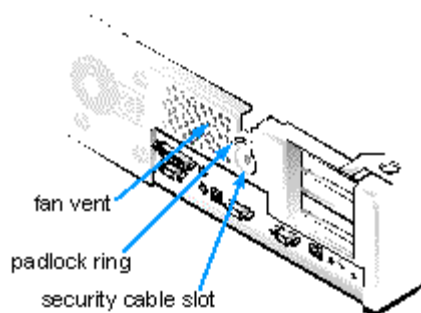

Passwords

The password feature enables you to set a user-defined password to restrict access to the system. Additional protection is available through the System Setup program. When the Setup Password option is set to Enabled, Password Status allows you to prevent the system password from being changed or disabled at boot time. For more information, see "[Using the System Setup Program.](#)"

Connecting Peripheral Devices

Figure 3 shows the connectors on the back of your computer for attaching external devices.

Figure 3. I/O Ports, Connectors, and Indicators

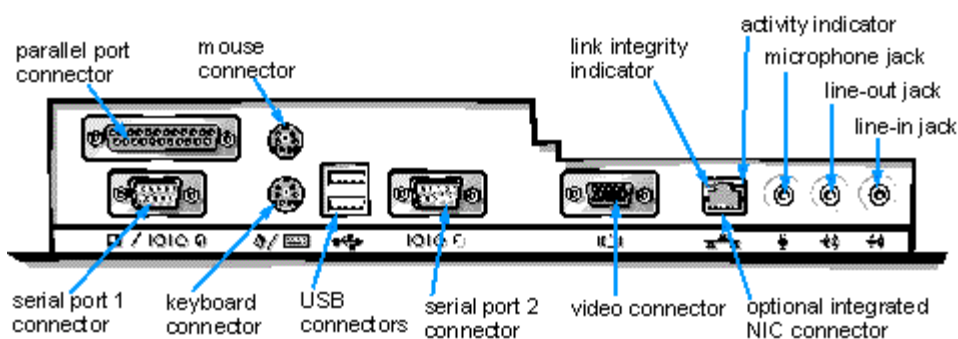

When you connect external devices to your computer's back panel, follow these guidelines:

- Check the documentation that accompanied the device for specific installation and configuration instructions.

For example, you must connect most devices to a particular input/output (I/O) port or connector to operate properly. Also, external devices like a mouse or printer usually require you to load device drivers into system memory before they will work.

- Always attach external devices while your computer is turned off. Then turn on the computer *before* turning on any external devices, unless the documentation for the device specifies otherwise. (If the computer does not seem to recognize the device, try turning on the device before turning on the computer.)

NOTICE: When you disconnect external devices from the back of the computer, wait 5 seconds after turning off the computer before you disconnect any devices to avoid possible damage to the system board.

Parallel Port Connector

The integrated parallel port uses a 25-pin D-subminiature connector on the computer's back panel.

This I/O port sends data in parallel format (where 8 data bits, or 1 byte, are sent simultaneously over eight separate lines in a single cable). The parallel port is used primarily for printers.

The default designation of your computer's integrated parallel port is LPT1. Port designations are used, for example, in software installation procedures to identify the port to which your printer is attached, thus telling your software where to send its output. (An incorrect designation prevents the printer from printing or causes scrambled print.)



NOTE: The integrated parallel port is automatically disabled if the system detects an installed expansion card containing a parallel port configured to the same address as specified in the [Parallel Port](#) option in the [System Setup Program](#).

Mouse Connector

Your system uses a PS/2-compatible mouse. The mouse cable attaches to a 6-pin miniature Deutsche Inductive Norm (DIN) connector on the back panel of your computer. Turn off the computer and any attached peripherals before connecting a mouse to the computer.

A PS/2-compatible mouse works as does an industry-standard serial mouse or bus mouse except that it has its own dedicated connector, which frees up the serial ports and does not require an expansion card. Mouse driver software gives the mouse priority with the microprocessor by issuing interrupt request (IRQ) 12 whenever a new mouse movement is made. The drivers also pass along the mouse data to the application that is in control.

USB Connectors

Your system contains two USB connectors for attaching USB-compliant devices. USB-compliant devices are typically peripherals such as keyboards, mice, printers, and computer speakers.

If you reconfigure your hardware, you may need pin number and signal information for the USB connectors.

Integrated NIC Connector

Your system has an integrated 10/100-Mbps 3Com PCI 3C905B-TX Ethernet NIC. The NIC provides all the functions of a separate network expansion card and supports both the 10BASE-T and 100BASE-TX Ethernet standards.

The NIC includes a Wakeup On LAN feature that enables the computer to be started by a special local area network (LAN) signal from a server management console. Wakeup On LAN provides remote computer setup, software downloading and installation, file updates, and asset tracking after hours and on weekends when LAN traffic is typically at a minimum.

The NIC connector on the computer's back panel has the following indicators:

- A yellow activity indicator flashes when the system is transmitting or receiving network data. (A high volume of network traffic may make this indicator appear to be in a steady "on" state.)

- A dual-colored link integrity indicator, which lights up green when there is a good connection between a 10-Mbps network and the NIC, or it lights up orange when there is a good connection between a 100-Mbps network and the NIC. When the green indicator is off, the computer is not detecting a physical connection to the network.

Audio Connectors

You can use the microphone jack to attach a standard personal computer microphone. Connect the audio cable from the microphone to the microphone jack. The microphone input is a monaural source with maximum signal levels of 89 millivolts root-mean-squared (mVrms).

You can use the line-out jack to attach most computer speakers. The line-out jack is amplified, so speakers with integrated amplifiers are not required. Connect the audio cable from the speakers to this jack.

You can use the line-in jack to attach record/playback devices such as cassette players, CD players, and VCRs. Connect the line-out cable from any of these devices to the line-in jack on the back of your computer.

Video Connector

The system uses a 15-pin high-density D-subminiature connector on the back panel for attaching a VGA-compatible monitor to your system.

Serial Port Connectors

The serial ports use 9-pin D-subminiature connectors on the back panel. These ports support devices such as external modems or plotters that require serial transmission (sending one bit of data at a time over one line).

The default designations for these integrated serial ports are COM1 for serial port 1 and COM2 for serial port 2. Port designations are used in software installation procedures to identify the port used by a device—for example, specifying the port used by a modem when installing communications software.

The system contains a reconfiguration feature to reassign the serial port's designation if you add an expansion card containing a serial port using this designation.

If you set the system's integrated serial ports to **Auto** in the [System Setup Program](#) and add an expansion card containing a serial port configured to a specific designation, the computer automatically maps (assigns) the integrated ports to the appropriate COM setting as necessary.

Before you add a card with a serial port, check the documentation that accompanied your software to make sure that the software can be mapped to the new COM port designation.

Keyboard Connector

Your system uses a PS/2-style keyboard. The keyboard cable attaches to a 6-pin miniature DIN connector on the back panel of your computer.

Network Cable Requirements

Your computer's NIC connector (an RJ45 connector located on the back panel) is designed for attaching an unshielded twisted pair (UTP) Ethernet cable. Press one end of the UTP cable into the NIC connector until

the cable snaps securely into place.

Connect the other end of the cable to an RJ45 jack wall plate or to an RJ45 port on a UTP concentrator or hub, depending on your network configuration.

Using the Power Switch

The power button controls the system's AC input power.

The Microsoft Windows 98 and Windows 98 Second Edition (SE) operating systems let you configure the function of the power button through the Advanced Configuration and Power Interface (ACPI) feature (see Table 2).

NOTICE: When you turn off your computer system, perform an orderly system shutdown using the operating system menu when possible.

Table 2. Power Button Behavior Under Microsoft Windows 98 and Windows 98 SE Operating Systems With ACPI

Action	Results		
	System Turned On and ACPI Enabled	System in Standby Mode	System Turned Off
Press power button	System goes into standby mode or turns off (depending on the operating system setup)	System turns on	Boots and system turns on
Hold power button for 6 seconds*	System turns off immediately	System turns off immediately	Boots and system turns on

* Pressing or holding the power button to shut down the system may result in data loss. Use the power button to shut down the system only if the operating system is not responding.

Microsoft Windows 95 does not support ACPI. Table 3 shows power button functions for Windows 95 and Windows 98 operating systems that have the ACPI feature disabled.

Table 3. Power Button Behavior Under Microsoft Windows 95 and Windows 98 (With Dell AutoShutdown Loaded)

Action	Results		
	System Turned On	System in Suspend Mode	System Turned Off
Press power button	System turns off	System turns off	Boots and system turns on
Hold power button for 6 seconds*	System turns off immediately	System turns off immediately	Boots and system turns on

** Pressing or holding the power button to shut down the system may result in data loss. Use the power button to shut down the system only if the operating system is not responding.*

Table 4 shows power button functions for Microsoft Windows NT operating systems.

Table 4. Power Button Behavior Under Microsoft Windows NT (With Dell AutoShutdown Loaded)

Action	Results	
	System Turned On	System Turned Off
Press power button	System shuts down	Boots and system turns on
Hold power button for 6 seconds*	System turns off immediately	Boots and system turns on

** Pressing or holding the power button to shut down the system may result in data loss. Use the power button to shut down the system only if the operating system is not responding.*

If the system does not turn off when you press the power button, the system may be hung. Press and hold the power button until the system turns off completely (this process may take several seconds). Alternatively, press the reset button to reset the system and reboot. If the system is hung and both buttons fail to function properly, unplug the AC power cable from the computer, wait for it to completely stop running, plug in the AC power cable, and if the system does not restart, press the power button to restart the system.

Using the Optional Stand for Vertical Orientation

Dell offers an optional stand that you can attach to the computer for a mini tower (vertical) orientation. Although you can attach (and remove) the stand at any time with a minimum of system disruption, it is easiest to attach before you set up your computer and connect the back-panel cables.

Attach the stand as follows:

1. Turn the computer onto its right side, so that the drive bays are at the bottom.
2. Fit the stand onto what was the left side of the computer.

Position the stand as shown in Figure 4. Align the large round hole in the stand with the securing button on the side of the cover, and align the captive thumbscrew in the stand with the screw hole in the cover.

Figure 4. Attaching the Optional Stand for Vertical Orientation

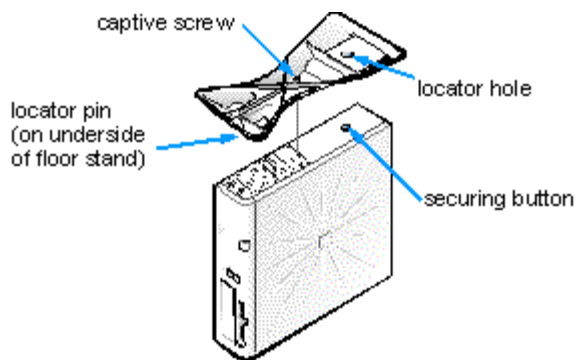

As you lower the stand into place, make sure that the locator pin (see Figure 4) fits into the corner hole of the hole pattern as shown. When the stand is in place, tighten the thumbscrew.

3. Rotate the computer so that the stand is at the bottom and the drives are at the top.

To remove the stand, turn the computer over so the stand is at the top, loosen the screw, lift the stand away, and place the computer in a horizontal position.

ENERGY STAR® Compliance

Certain configurations of Dell computer systems comply with the requirements set forth by the Environmental Protection Agency (EPA) for energy-efficient computers. If the front panel of your computer bears the ENERGY STAR® Emblem (see [Figure 5](#)), your original configuration complied with these requirements and all ENERGY STAR® power management features of the computer are enabled. To disable or change the operation of these features, you must change the setting for the Power Management option in the System Setup program. For instructions, see "[Using the System Setup Program](#)."



NOTES: As an ENERGY STAR® Partner, Dell Computer Corporation has determined that this product meets the ENERGY STAR® guidelines for energy efficiency.

*Any Dell computer bearing the ENERGY STAR® Emblem is certified to comply with EPA ENERGY STAR® requirements **as configured when shipped by Dell**. Any changes you make to this configuration (such as installing additional expansion cards or drives) may increase the system's power consumption beyond the limits set by the EPA's ENERGY STAR® Computers program.*

Figure 5. ENERGY STAR® Emblem



The EPA's ENERGY STAR® Computers program is a joint effort between the EPA and computer manufacturers to reduce air pollution by promoting energy-efficient computer products. The EPA estimates that use of ENERGY STAR® computer products can save computer users up to two billion dollars annually in electricity costs. In turn, this reduction in electricity usage can reduce emissions of carbon dioxide, the gas

primarily responsible for the greenhouse effect, and sulfur dioxide and nitrogen oxides, which are the two primary causes of acid rain.

Computer users can also help to reduce electricity usage and its side effects by turning off their computer systems when they are not in use for extended periods of time—particularly at night and on weekends.

Accessing Online Documentation

The online *System User's Guide* installed on your hard-disk drive contains information on the following topics:

- How to use the online *System User's Guide*
- System features
- Using drivers and utilities
- Using the integrated audio controller
- Using the System Setup program
- Configuring expansion cards
- Securing your computer
- Connecting external devices
- Maintaining the system
- Contacting Dell

The guide also contains a glossary of commonly used terms and abbreviations.

The *System User's Guide* is located in the Dell Accessories program group or folder.

To print any of the topics from this guide, display the topic you want on your screen and select Print Topic from the File menu.

Getting Help

Dell provides a number of tools to help you if you don't understand a procedure described in this guide or if your system does not perform as expected. For information on these help tools, see the chapter titled "Getting Help" in your *Diagnostics and Troubleshooting Guide* or the "Contacting Dell" section in the online *System User's Guide*.

[Back to Contents Page](#)

[Back to Contents Page](#)

Using the System Setup Program: Dell™ OptiPlex™ GX1 Low-Profile Managed PC Systems

- [Overview](#)
- [Entering the System Setup Program](#)
- [System Setup Screens](#)
- [Using the System Setup Program](#)
- [System Setup Options](#)
- [Using the System Password Feature](#)
- [Using the Setup Password Feature](#)
- [Disabling a Forgotten Password](#)
- [Responding to Error Messages](#)

Overview

Each time you turn on your computer system or press the reset button, the system compares the hardware installed in the system to the hardware listed in the system configuration information stored in nonvolatile random-access memory (NVRAM) on the system board. If the system detects a discrepancy, it generates error messages that identify the incorrect configuration settings. The system then prompts you to enter the System Setup program to correct the setting.

You can use the System Setup program as follows:

- To change the system configuration information after you add, change, or remove any hardware in your system
- To set or change user-selectable options—for example, the time or date on your system

You can view the current settings at any time. When you change a setting, in many cases you must reboot the system before the change takes effect.

After you set up your system, run the System Setup program to familiarize yourself with your system configuration information and optional settings. Dell recommends that you print the System Setup screens (by pressing the <Print Screen> key) or write down the information for future reference.

Before you use the System Setup program, you need to know the kind of diskette drive(s) and hard-disk drive(s) installed in your computer. If you are unsure of any of this information, see the Manufacturing Test Report that was shipped with your system and is located in the Dell Accessories folder.



NOTE: Dell recommends that you upgrade your basic input/output system (BIOS) to the latest version. Refer to the Dell support Web site at <http://support.dell.com> for instructions.

Entering the System Setup Program

Enter the System Setup program as follows:

1. Turn on your system.

If your system is already on, shut it down and then turn it on again.

2. Press <F2> immediately when the F2 = Setup prompt appears in the upper-right corner of the Dell logo screen.

If you wait too long and your operating system begins to load into memory, let the system complete the load operation; then shut down the system and try again.



NOTE: To ensure an orderly system shutdown, consult the documentation that accompanied your operating system.

You can also enter the System Setup program by responding to certain error messages. See "[Responding to Error Messages](#)."

System Setup Screens

The two System Setup screens, Page 1 and Page 2, display the current setup and configuration information and optional settings for your system. (Typical examples are illustrated in Figure 1.)

Figure 1. System Setup Screens

configuration option

title box

help

Page 1 of 2		Dell Computer Corporation (www.dell.com)		System OptiPlex GX1 500 Setup		BIOS Version: XXX	
Time: 03:54:24		Date: Mon Jan 3, 2000		This category sets the time in 24-hour format (hours:minutes:seconds) for the internal clock calendar.			
Diskette Drive A: 3.5 inch, 1.44 MB		Diskette Drive B: Not Installed		To change the value in a field, enter a number or use the left- or right-arrow key.			
Use Zip as A or B: Off		Drives:		Changes take effect immediately.			
Primary		Type	Cyls	Hds	Pre	LZ	Sec Size
Drive 0: Auto				EIDE			10239
Drive 1: None		Secondary					
Drive 0: Auto		CD-ROM Device					
Drive 1: None							
Reserved memory: None		CPU Speed: 500 MHz		Pentium® III Processor - 500 MHz			
NumLock: On		Chassis Intrusion: Enabled		LEVEL 2 Cache: 512 KB Integrated			
DAC Snoop: Off		ACPI: Off		System Memory: 128 MB ECC SDRAM			
				Video Memory: 8 MB SGRAM			
				Service Tag: XXXXXX			
				Asset Tag: XXXXXX			
Tab, Shift-Tab change fields		←, → change values		Alt-P next		Esc exit	
						Alt-B reboot	

key functions

system data

Dell Computer Corporation (www.dell.com)		BIOS Version: XXX
Page 2 of 2	System OptiPlex GX1 500 Setup	
Keyboard Errors:	Report	This category sets whether keyboard-related error messages are reported at system startup.
System Password:	Not Enabled	
Password Status:	Unlocked	
Boot Sequence	Diskette First	
Setup Password:	Not Enabled	
Auto Power On:	Disabled 00:00	
Power Management:	Disabled	
Wakeup on LAN:	On	
Integrated Devices		
Sound:	On	
NIC:	On	Pentium® III Processor - 500 MHz LEVEL 2 Cache: 512 KB Integrated System Memory: 128 MB ECC SDRAM Video Memory: 8 MB SGRAM Service Tag: XXXXXX Asset Tag: XXXXXX
Mouse:	On	
Serial Port 1:	Auto	
Serial Port 2:	Auto	
Parallel Port:	378h	
Parallel Mode:	PS/2	
IDE Hard Disk:	Auto	
Diskette:	Auto	
Speaker:	On	
Tab, Shift-Tab change fields ←, → change values Alt-P next Esc exit Alt-B reboot		

Information on the two System Setup screens is organized in five boxed areas:

- Title box

The box at the top of both screens lists the system name, page number (Page 1 or Page 2), and the revision number of the BIOS.

- Configuration options

The box on the left half of both screens lists the options that define the installed hardware in your computer.

Fields beside the options contain options or values; those that appear bright on the screen can be changed. Options or values that you cannot change because they are determined by the system appear less bright.

Some options have multiple fields, which may show options or values as bright or less bright depending upon what options or values you entered in other fields.

- Help

The box on the upper-right half of both screens displays help information for the option with a currently highlighted field.

- System data

The box in the lower-right corner of both screens displays information about your system.

- Key functions



















The line of boxes across the bottom of both screens lists keys and their functions within the System

Setup program.

Using the System Setup Program

Table 1 lists the keys you use to view or change information on the System Setup screens and to exit the program.

Table 1. System-Setup Navigation Keys

Keys	Action
 or 	Moves to the next field.
  or 	Moves to the previous field.
 or 	Cycles through the options in a field. In many fields, you can also type the appropriate value.
 or 	Scrolls through help information.
 	Switches between Page 1 and Page 2.
	Exits the System Setup program without rebooting the system and returns the system to its previous state—the boot routine. For most of the options, any changes you make are recorded but do not take effect until the next time you boot the system. For a few options (as noted in the help area), the changes take effect immediately.
 	Exits the System Setup program and reboots the system, implementing any changes you have made.
 	Resets the selected option to its default setting.
 	Enters the Device List screen when the Boot Devices menu option is set to Device List. See Table 2 for more information on the keys you use in the Device List screen.

System Setup Options

The following subsections explain in detail each of the options on the System Setup screens.

Time

Time resets the time on the computer's internal clock.

Time is kept in a 24-hour format (*hours:minutes:seconds*). To change the time, press the right-arrow key to increase the number in the highlighted field or press the left-arrow key to decrease the number. If you prefer, you can type numbers in each of the appropriate fields.

Date

Date resets the date on the computer's internal calendar.

Your system automatically displays the day of the week corresponding to the settings in the three fields that follow (*month, day-of-month, and year*).

To change the date, press the right-arrow key to increase the number in the highlighted field or press the left-arrow key to decrease the number. If you prefer, you can type numbers in the *month* and *day-of-month* fields.

Diskette Drive A, Diskette Drive B, and Use ZIP as A or B

Diskette Drive A and Diskette Drive B identify the type of diskette drives installed in your computer. With the standard cabling configuration, Diskette Drive A (the boot diskette drive) is the 3.5-inch diskette drive installed in the top externally accessible drive bay; Diskette Drive B is any drive installed in the bottom externally accessible drive bay that is connected to the system's diskette/tape drive interface.

The option settings always match the physical locations of the drives in your computer—the first drive listed on Page 1 of the System Setup screens is the top drive in your computer.

The options are:

- 5.25 Inch, 360 KB
- 5.25 Inch, 1.2 MB
- 3.5 Inch, 720 KB
- 3.5 Inch, 1.44 MB
- Not Installed

The diskette option labeled "Use ZIP as A or B" is used to control the operation of an internally installed ATAPI Zip drive. The options are On and Off. When set On, the Zip drive operates as a diskette drive and can be booted. When set to Off, the Zip drive operates as a normal ATAPI device.

You can have a total of two diskette devices, either diskette drives or Zip drives.



NOTE: Tape drives are not reflected in the Diskette Drive A and Diskette Drive B options. For example, if you have a single diskette drive and a tape drive attached to the diskette/tape drive interface cable, set the Diskette Drive A option to match the characteristics of the diskette drive and set the Diskette Drive B option to Not Installed.

Drives: Primary and Secondary

Primary identifies drives attached to the primary enhanced integrated drive electronics (EIDE) interface connector (labeled "IDE1") on the system board; Secondary identifies drives connected to the secondary EIDE interface connector (labeled "IDE2"). Dell recommends that you use the secondary EIDE interface

connector for EIDE CD-ROM and EIDE tape drives.



NOTES: For all devices from Dell that use the built-in EIDE controller, set the appropriate Drive option to Auto. For small computer system interface (SCSI) devices, set the appropriate Drive option to None.

You must have an EIDE device connected to the primary EIDE interface if you have an EIDE device connected to the secondary EIDE interface.

For older EIDE hard-disk drives not shipped with the system from Dell and less than 528 megabytes (MB) in capacity, you can use one of the following options if the Autodetect feature does not work:

- A specific drive-type number
- Usr1 or Usr2

For each drive, seven parameters can be chosen as a group by drive-type number or entered individually from the keyboard. A drive-type number specifies the parameters of a hard-disk drive, based on a table recorded in the system's BIOS.



NOTE: Operating systems that bypass the system BIOS may not obtain optimum hard-disk drive performance.

If you choose the Usr1 or Usr2 option, you must supply the following parameters for the drive:

- Type is the drive-type number for the selected hard-disk drive (in this case, Usr1 or Usr2).
- Cyls is the number of logical cylinders.
- Hds indicates the number of logical heads in the drive.
- Pre (precompensation cylinder) is the cylinder number at which the electrical current for the drive head changes to compensate for differences in data density across the disk surface (this parameter has no effect for EIDE drives).
- Lz is the cylinder number that is used as the drive's landing zone for the heads when the drive is not in use.
- Sec is the number of logical sectors per track.
- Size (automatically calculated by the system) indicates the number of millions of bytes of storage provided by the drive.

Reserved Memory

Reserved Memory allows you to designate a region of system board memory that can be supplied by an expansion card. You should not enable the reserved memory feature unless you are using an expansion card that requires special addressing.

For example, you may have a memory expansion card that needs to be addressed starting at 15 MB. Selecting the 15M - 16M option in the Reserved Memory option specifies that the base memory from 15 to 16 MB comes from the memory expansion card (the base memory below the 15-MB address comes from the dual in-line memory modules [DIMMs] on the system board).

The Reserved Memory option has the following options:

- None (the default option)
- 512K - 640K

15M - 16M

CPU Speed

CPU Speed indicates the processor speed at which your system boots.

Press the left- or right-arrow key to toggle the CPU Speed option between the resident microprocessor's rated speed (the default) and a lower compatibility speed, which lets you accommodate speed-sensitive application programs. A change to this option takes effect immediately (rebooting the system is not required).

You can also toggle between the rated processor speed and the compatibility speed while the system is running in real mode by pressing <Ctrl><Alt><\>. (For keyboards that do not use American English, press <Ctrl><Alt><#>.)

Num Lock

Num Lock determines whether your system boots with the Num Lock mode activated on 101- or 102-key keyboards (it does not apply to 84-key keyboards).

When Num Lock mode is activated, the rightmost bank of keys on your keyboard provides the mathematical and numeric functions shown at the tops of the keys. When Num Lock mode is turned off, these keys provide cursor-control functions according to the label on the bottom of each key.

Chassis Intrusion

Chassis Intrusion displays the status of the system chassis intrusion monitor. The settings for this option are Enabled, Enabled-Silent, or Disabled. The default is Enabled.

If the computer cover is removed while the intrusion monitor is set to Enabled, the setting changes to Detected, and the following message appears during the boot sequence at the next system start-up:

```
Alert! Cover was previously removed.
```

If the computer cover is removed while the intrusion monitor is set to Enabled-Silent, the setting changes to Detected, but the alert message is not displayed during the boot sequence at the next system start-up.

If the intrusion monitor is set to Disabled, no intrusion monitoring occurs and no messages are displayed.

To reset the Detected setting, enter the System Setup program during the system's power-on self-test (POST). Highlight the Chassis Intrusion option and press the left- or right-arrow key to choose Enabled, Enabled-Silent, or Disabled.



NOTE: When the setup password is enabled, you must enter the setup password before you can reset the Chassis Intrusion option.

DAC Snoop

DAC Snoop lets you correct video problems that may occur when certain video add-in cards are used. The default is Off. If you are using a video add-in card and problems such as incorrect colors or blank windows occur, set DAC Snoop to On.

ACPI

This option controls the operation of the system's Advanced Configuration and Power Interface (ACPI) feature.

When ACPI is set to On, momentarily pressing the power button places the system in a power-saving mode. To turn the system off completely, press the power button for more than 4 seconds. When ACPI is set to On, interrupt request (IRQ) line 9 is not available for use by an expansion card.

When ACPI is set to Off, momentarily pressing the power button turns off the system completely. With this setting, IRQ9 is available for use by an expansion card.

Keyboard Errors

Keyboard Errors enables or disables reporting of keyboard errors during the POST, which is a series of tests that the system performs on the hardware each time you turn on the system or press the reset button.

This option is useful when applied to self-starting servers or host systems that have no permanently attached keyboard. In these situations, selecting Do Not Report suppresses all error messages relating to the keyboard or to the keyboard controller during POST. This option does not affect the operation of the keyboard itself if a keyboard is attached to the computer.

System Password

System Password displays the current status of your system's password security feature and allows you to assign and verify a new password. No one can assign a new password unless the current status is Not Enabled, which is displayed in bright characters.

The settings for the System Password option are the following:

- Not Enabled (the default option)
- Enabled
- Disabled by Jumper



NOTE: Read "[Using the System Password Feature](#)" for instructions on assigning a system password and using or changing an existing system password. See "[Disabling a Forgotten Password](#)" for instructions on disabling a forgotten system password.

Password Status

When Setup Password is set to Enabled, Password Status allows you to prevent the system password from being changed or disabled at system start-up.

To lock the system password, you must first assign a setup password in the Setup Password option and then change the Password Status option to Locked. In this state, the system password cannot be changed through the System Password option and cannot be disabled at system start-up by pressing <Ctrl><Enter>.

To unlock the system password, you must enter the setup password in the Setup Password option and then change the Password Status option to Unlocked. In this state, the system password can be disabled at system start-up by pressing <Ctrl><Enter> and then changed through the System Password option.

Boot Sequence

Boot Sequence can be set to Diskette First (the default), Hard Disk Only, CD-ROM First, or Device List.

The term *boot* refers to the system's start-up procedure. When turned on, the system "bootstraps" itself into an operational state by loading into memory a small program, which in turn loads the necessary operating system. Boot Sequence tells the system where to look for the files that it needs to load.

Diskette First

Selecting Diskette First causes the system to boot from drive A first. If the system finds a diskette that is not bootable in the drive or finds a problem with the drive itself, it displays an error message. If it does not find a diskette in the drive, the system boots from the hard-disk drive (drive 0), then from the CD-ROM drive, and finally from the Plug and Play network adapters in the order found.

Hard Disk Only

Selecting Hard Disk Only causes the system to boot first from the hard-disk drive and then from the Plug and Play network adapters in the order found.









CD-ROM First

Selecting CD-ROM First causes the system to boot from the CD-ROM drive first. If the system finds a CD that is not bootable in the drive or finds a problem with the drive itself, it displays an error message. If it does not find a CD in the drive, the system boots from drive A, then from drive C, and finally from the Plug and Play network adapters in the order found.

Device List

Device List provides access to the Device List screen, where you can choose from a list of available boot devices to boot from and specify the order in which your computer attempts to boot from these devices. To view the Device List screen, press <Ctrl> and the right-arrow key. Table 2 lists other navigation keys used on the Device List screen.

Table 2. Device-List Screen Navigation Keys

Keys	Action
 	Returns the boot device lists to the default settings
  or  	Moves the selected item up or down in the boot sequence
 	Exits to Page 2 of the System Setup screens
	Moves the selected item from one Boot Device Priority list to the other



NOTICE: Only a technically knowledgeable person should change the settings in the Device List screen.

The Device List screen (see Figure 2) provides three options for listing and prioritizing the available boot devices in your system.

Figure 2. Sample Device List Screen

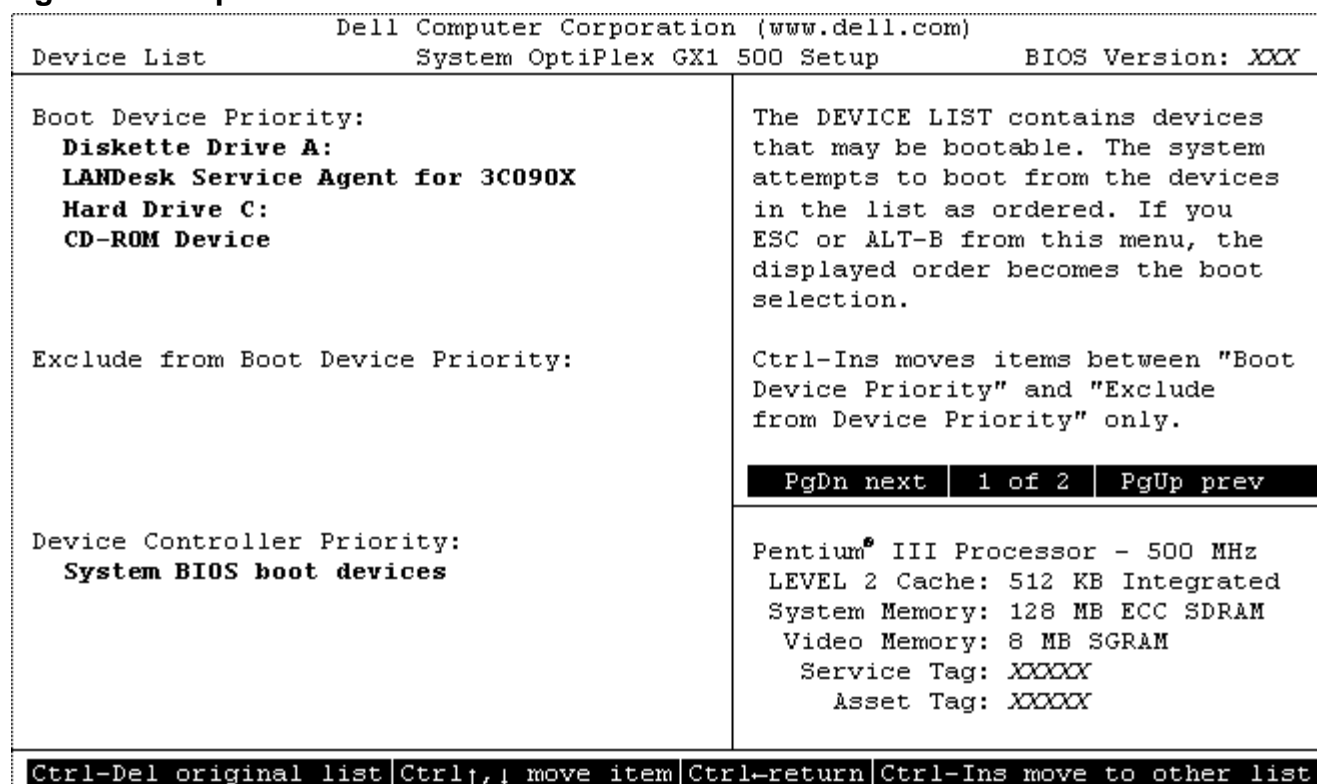

- **Boot Device Priority**

The Boot Device Priority option lists all bootable devices (hard-disk drives, CD-ROM drives, and so on) that are controlled by the system BIOS and any Plug and Play network adapters installed in the computer.

- **Exclude From Boot Device Priority**

The Exclude From Boot Device Priority option allows you to remove from the Boot Device Priority option any boot devices that you want the system to ignore during system start-up.

- **Device Controller Priority**

The Device Controller Priority option lists the system BIOS controller; any non-Plug and Play devices, such as network adapter cards; and any secondary controller cards, such as a SCSI adapter, installed in the computer.

 **NOTE:** *Non-Plug and Play devices appear in this list as Adapters without ID support.*

When determining the order of devices to boot from, the system first considers the order of the devices listed under the Device Controller Priority option, then the order of devices under Boot Device Priority.

To specify your priority preferences, order the devices under these options so that the highest-priority controller is at the top of the Device Controller Priority option and the highest-priority device is at the top of the Boot Device Priority option. Order the remainder of the devices in the Boot Device Priority option according to your preferences. Move any devices that you want the system to ignore during system start-up into the Exclude From Boot Device Priority option.

 **NOTE:** *The system defines drive C in the Boot Device Priority option as the first hard-disk drive attached to the highest-priority device controller. Therefore, if you have a SCSI adapter installed in your computer and you want SCSI drive 0 to be drive C, you must move the SCSI adapter item to the top of the Device Controller Priority option.*

To change the order of the devices, press <Ctrl> and the up- or down-arrow key. If you want to revert to the original Boot Device Priority option settings, press <Ctrl>.

 **NOTE:** *If you exit the Device List option by pressing <Esc> or <Alt> without making any changes, the Boot Sequence option is set to the Device List option.*

Setup Password

Setup Password indicates whether a password is required before you can change option settings on the System Setup screen. The settings for this option are normally Enabled or Not Enabled. A third setting, Disabled By Jumper, displays if the Setup Password option is deactivated. (You can set a jumper on the system board to deactivate the Setup option.)

If Setup Password is set to Enabled, you must enter the correct setup password before you can change the settings for the majority of the System Setup options. If you do not enter the correct password in three tries, the system lets you view, but not change, the settings on the System Setup screen, with one exception: if Password Status is Unlocked, you may change the system password.

 **NOTE:** *Read "[Using the Setup Password Feature](#)" for instructions on assigning a setup password and using or changing an existing setup password. See "[Disabling a Forgotten Password](#)" for instructions on disabling a forgotten setup password.*

Auto Power On

Auto Power On allows you to set the time and days of the week to turn on the computer system automatically. You can set Auto Power On to turn on the system either every day or every Monday through Friday.

 **NOTE:** *This feature does not work if you turn off your system using a power strip or surge protector.*

Time is kept in a 24-hour format (*hours:minutes*). To change the start-up time, press the right-arrow key to increase the number in the highlighted field or press the left-arrow key to decrease the number. If you prefer,

you can type numbers in both fields.

The default for Auto Power On is Disabled.

Power Management

For certain types of monitors and most EIDE hard-disk drives, you can reduce system power consumption by enabling the power management feature. With Power Management enabled, these monitors and drives automatically switch into low-power mode during periods of system inactivity.

Power Management can be implemented at three levels—Maximum, Regular, and Minimum. (The different levels apply to the monitor only; hard-disk drive operation is the same for all three.) The default for this option is Disabled.

Saving Monitor Power

If you have a Video Electronics Standards Association (VESA®) Display Power Management Signaling (DPMS)-compliant monitor, enabling the Power Management option reduces monitor power consumption during periods of keyboard and mouse inactivity.

NOTICE: Check your monitor documentation to make sure you have a DPMS-compliant monitor before you enable this feature. Otherwise, you risk damaging the monitor.



NOTE: The power management feature monitors activity of a mouse connected to the Personal System/2 (PS/2)-compatible mouse port.

By setting Power Management to Maximum, Regular, or Minimum, you can set predefined time-out periods (see [Table 3](#)) for the two successive monitor shutdown stages, *standby* and *off*.



NOTE: Each monitor manufacturer defines the details of the shutdown stages for its own monitors. But in all cases, power consumption decreases with each stage from "on" (full power) to "standby" (reduced power; the display image usually disappears) to "off" (where power consumption is minimal). To define these stages for your monitor, see the documentation that came with the monitor.

From either shutdown stage, you can return full power to the monitor in one of the following ways:

- For most DPMS-compliant monitors, any subsequent activity—including moving the mouse—should return full power to the monitor.
- A few DPMS-compliant monitors require that you turn monitor power off and then on again to return to full power.

Check your monitor documentation for information on how your monitor is designed to operate.

Saving EIDE Hard-Disk Drive Power

For most systems, enabling Power Management at any level causes EIDE hard-disk drives to switch to low-power mode after about 20 minutes of system inactivity (see [Table 3](#)).

NOTES: All EIDE drives shipped with your system support this feature. (For more information on



ENERGY STAR® systems, see "[ENERGY STAR® Compliance](#)".)

However, not all EIDE hard-disk drives support this feature. Enabling this feature for drives that do not support it may cause the EIDE drive to become inoperable until the computer is restarted and the Power Management option is disabled.

In low-power mode, the disks inside the drive stop spinning. They remain idle until the next drive access, which causes them to start spinning again. (Because the disks take a few seconds to regain full speed, you may notice a slight delay when you next access the hard-disk drive.)

When Power Management is set to Disabled (the default), the disks spin constantly as long as the system is turned on.

Table 3. Power Time-Out Periods

Power Management Setting	EIDE Drive Spindown Time-Outs	Monitor Standby Time-Outs	Monitor Off Time-Outs
Disabled	Never	Never	Never
Maximum	20 minutes	10 minutes	1 hour
Regular	20 minutes	20 minutes	1 hour
Minimum	20 minutes	1 hour	Never

Wakeup On LAN

Wakeup On LAN determines whether the Wakeup On LAN feature is set to On or Off. You must reboot your system before a change takes effect.

Sound

Sound determines whether the integrated audio controller is On or Off. You must reboot your system before a change takes effect.

NIC

NIC determines whether an integrated network interface controller (NIC) is On or Off. You must reboot your system before a change takes effect.

Mouse

Mouse enables or disables the system's built-in PS/2-compatible mouse port. Disabling the mouse allows an expansion card to use IRQ 12.

For more information about built-in ports, port designations, IRQs, and the remapping of ports, see "Connecting External Devices" in your online *System User's Guide*.

Serial Port 1 and Serial Port 2

Serial Port 1 and Serial Port 2 configure the system's built-in serial ports. These options can be set to Auto (the default) to automatically configure a port, to a particular designation (COM1 or COM3 for Serial Port 1; COM2 or COM4 for Serial Port 2), or to Off to disable the port.

If you set a serial port to Auto and add an expansion card containing a port configured to the same designation, the system automatically remaps the built-in port to the next available port designation that shares the same IRQ setting as follows:

- COM1 (input/output [I/O] address 3F8h), which shares IRQ4 with COM3, is remapped to COM3 (I/O address 3E8h).
- COM2 (I/O address 2F8h), which shares IRQ3 with COM4, is remapped to COM4 (I/O address 2E8h).



NOTES: When two COM ports share an IRQ setting, you can use either port as necessary, but you may not be able to use them both at the same time. If the second port (COM3 or COM4) is also in use, the built-in port is turned off.

If you are using the Microsoft® Windows® 95 or IBM® OS/2® operating system, you cannot use both serial ports at the same time.

For more information about built-in ports, port designations, IRQs, and the remapping of ports, see "Connecting External Devices" in your online *System User's Guide*.

Parallel Port

Parallel Port configures the system's built-in parallel port. This option can be set to 378h (the default), to alternate addresses 278h or 3BCh, or to Off to disable the port.



NOTE: Do not set Parallel Port to 278h if you have an Enhanced Capabilities Port (ECP) device connected to the port.

Parallel Mode

Parallel Mode controls whether the system's built-in parallel port acts as an AT-compatible (unidirectional) or PS/2-compatible (bidirectional) port.

Your system also supports ECP mode, which can be used by Windows 95 and Windows 98. Windows 95 and Windows 98 use ECP protocol automatically if the operating system detects an ECP-capable device, eliminating the need for an ECP setting in this option.

Set this option according to the type of peripheral device connected to the parallel port. To determine the correct mode to use, see the documentation that came with the device.

IDE Hard Disk

IDE Hard Disk enables or disables the system's built-in EIDE hard-disk drive interface.

With Auto (the default) selected, the system turns off the built-in EIDE interface when necessary to accommodate a controller card installed in an expansion slot.

As part of the boot routine, the system first checks for a primary hard-disk drive controller card installed in an expansion slot. If no card is found, the system enables the built-in EIDE interface to use IRQ14 and IRQ15.

If a primary controller is detected on the expansion bus, the built-in EIDE interface is disabled.

Selecting Off disables the built-in EIDE interface.

Diskette

Diskette controls the operation of the system's built-in diskette drive controller.

With Auto (the default) selected, the system turns off the built-in diskette drive controller when necessary to accommodate a controller card installed in an expansion slot.

With Write Protect selected, nothing can be written to diskette drives and tape drives using the system's built-in diskette drive controller. (The system can still read from the drives.) When this option is selected, the Auto option (whereby the system turns off the built-in diskette drive controller as necessary) is also in effect.

Selecting Off turns off the built-in diskette/tape drive controller; this option is used primarily for troubleshooting purposes.

Speaker

Speaker determines whether the on-board speaker is On (the default) or Off. A change to this option takes effect immediately (rebooting the system is not required).

System Data Options

The following options, which are not selectable, display information about the system. The microprocessor type is also listed in the System Data box.

- Level 2 Cache displays the size of the integrated cache.
- System Memory indicates the entire amount of installed memory detected in your system, except for memory on Expanded Memory Specification (EMS) expansion cards. After adding memory, check this option to confirm that the new memory is installed correctly and is recognized by the system.
- Video Memory displays the amount of video memory detected in your system.
- Service Tag displays the system's five-character service tag number, which was programmed into NVRAM by Dell during the manufacturing process. Refer to this number during technical assistance or service calls. The service tag number is also accessed by certain Dell support software, including the diagnostics software.
- Asset Tag displays the customer-programmable asset tag number for the system if an asset tag number has been assigned. You can use the Asset Tag utility, which is included with your system utilities, to enter an asset tag number up to ten characters long into NVRAM. More information is available on the *Dell ResourceCD*.

Using the System Password Feature

NOTICE: The password features provide a basic level of security for the data on your system. However, they are not foolproof. If your data requires more security, it is your responsibility to obtain and use additional forms of protection, such as data encryption programs.

Your Dell system is shipped to you without the system password feature enabled. If system security is a concern, you should operate your system only with system password protection.

You can assign a system password, as described in "[Assigning a System Password](#)," whenever you use the System Setup program. After a system password is assigned, only those who know the password have full use of the system.

When the System Password option is set to Enabled, the computer system prompts you for the system password just after the system boots.

To change an existing system password, you must know the password (see "[Deleting or Changing an Existing System Password](#)"). If you assign and later forget a system password, you need to be able to remove the computer cover to change a jumper setting that disables the system password feature (see "[Disabling a Forgotten Password](#)"). Note that you erase the setup password at the same time.

Assigning a System Password

NOTICE: If you leave your system running and unattended without having a system password assigned, or if you leave your computer unlocked so that someone can disable the password by changing a jumper setting, anyone can access the data stored on your hard-disk drive.

Before you can assign a system password, you must enter the System Setup program and check the System Password option.

When a system password is assigned, the setting shown in the System Password option is Enabled. When the system password feature is disabled by a jumper setting on the system board, the option shown is Disabled by Jumper. You cannot change or enter a new system password if either of these options is displayed.

When no system password is assigned and the password jumper on the system board is in the enabled position (its default), the option shown for the System Password option is Not Enabled. Only when this option is set to Not Enabled can you assign a system password, using the following procedure:

1. Verify that the Password Status option is set to Unlocked.

For instructions on changing the setting for Password Status, see "[Password Status](#)."

2. Highlight the System Password option, and then press the left- or right-arrow key.

The option heading changes to Enter Password, followed by an empty seven-character field in square brackets.

3. Type your new system password.

You can use up to seven characters in your password.

As you press each character key (or the spacebar for a blank space), a placeholder appears in the field.

The password assignment operation recognizes keys by their location on the keyboard, without distinguishing between lowercase and uppercase characters. For example, if you have an *M* in your password, the system recognizes either *M* or *m* as correct.

Certain key combinations are not valid. If you enter one of these combinations, the speaker emits a beep.

To erase a character when entering your password, press the <Backspace> key or the left-arrow key.



NOTE: To escape from the field without assigning a system password, press the <Tab> key or the <Shift><Tab> key combination to move to another field, or press the <Esc> key at any time prior to completing step 5.

4. Press <Enter>.

If the new system password is less than seven characters, the whole field fills with placeholders. Then the option heading changes to Verify Password, followed by another empty seven-character field in square brackets.

5. To confirm your password, type it a second time and press <Enter>.

The password setting changes to Enabled. Your system password is now set; you can exit the System Setup program and begin using your system. Note, however, that password protection does not take effect until you reboot the system by pressing the reset button or by turning the system off and then on again.

Using Your System Password to Secure Your System

Whenever you turn on your system, press the reset button, or reboot the system by pressing the <Ctrl><Alt> key combination, the following prompt appears on the screen when the Password Status option is set to Unlocked:

Type in the password and...

- press <ENTER> to leave password security enabled.
- press <CTRL><ENTER> to disable password security.

Enter password:

If the Password Status option is set to Locked, the following prompt appears:

Type the password and press <Enter>.

After you type the correct system password and press <Enter>, your system boots and you can use the keyboard and/or mouse to operate your system as usual.



NOTE: If you have assigned a setup password (see "[Using the Setup Password Feature](#)"), the system accepts your setup password as an alternate system password.

If a wrong or incomplete system password is entered, the following message appears on the screen:

** Incorrect password. **

Enter password:

If an incorrect or incomplete system password is entered again, the same message appears on the screen.

The third and subsequent times an incorrect or incomplete system password is entered, the system displays the following message:

```
** Incorrect password. **  
Number of unsuccessful password attempts: 3  
System halted! Must power down.
```

The number of unsuccessful attempts made to enter the correct system password can alert you to an unauthorized person attempting to use your system.

Even after your system is turned off and on, the previous message is displayed each time an incorrect or incomplete system password is entered.



NOTE: You can use the Password Status option in conjunction with System Password and Setup Password to further protect your system from unauthorized changes. For more information, see "[Password Status](#)."

Deleting or Changing an Existing System Password

To delete or change an existing system password, perform the following steps:

1. Enter the System Setup program, and verify that the Password Status option is set to Unlocked.
Refer to "[Entering the System Setup Program](#)." For instructions on changing the setting for Password Status, see "[Password Status](#)."
2. Reboot your system to force it to prompt you for a system password.
3. When prompted, type the system password.
4. Press the <Ctrl><Enter> key combination to disable the existing system password, instead of pressing <Enter> to continue with the normal operation of your system.
5. Confirm that Not Enabled is displayed for the System Password option of the System Setup program.

If Not Enabled appears in the System Password option, the system password has been deleted. If you want to assign a new password, continue to step 6. If Not Enabled is not displayed for the System Password option, press the <Alt><p> key combination to reboot the system, and then repeat steps 3 through 5.

6. To assign a new password, follow the procedure in "[Assigning a System Password](#)."

Using the Setup Password Feature

Your Dell system is shipped to you without the setup password feature enabled. If system security is a concern, you should operate your system with setup password protection.

You can assign a setup password, as described in "[Assigning a Setup Password](#)," whenever you use the

System Setup program. After a setup password is assigned, only those who know the password have full use of the System Setup program.

To change an existing setup password, you must know the setup password (see "[Deleting or Changing an Existing Setup Password](#)"). If you assign and later forget a setup password, you need to remove the computer cover to change a jumper setting that disables the setup password feature (see "[Disabling a Forgotten Password](#)"). Note that you erase the system password at the same time.

Assigning a Setup Password

A setup password can be assigned (or changed) only when the Setup Password option is set to Not Enabled. To assign a setup password, perform the following steps:

1. Enter the System Setup program and go to Page 2 of the System Setup screens.

Refer to "[Entering the System Setup Program](#)." Press the <Alt><p> key combination to move to Page 2 of the System Setup screens.

2. Highlight the Setup Password option and press the left- or right-arrow key.

The system prompts you to enter and verify the password. If a character is illegal for password use, the system emits a beep.



NOTE: The setup password can be the same as the system password.

3. Enter and verify the password, and click OK.

A change to the Setup Password option becomes effective immediately (rebooting the system is not required).

Highlight the Setup Password option and press the left- or right-arrow key. The system prompts you to enter and verify the password. If a character is illegal for password use, the system emits a beep.



NOTES: The setup password can be the same as the system password.

If the two passwords are different, the setup password can be used as an alternate system password. However, the system password cannot be used in place of the setup password.

After you verify the password, the Setup Password setting changes to Enabled. The next time you enter the System Setup program, the system prompts you for the setup password.

Operating With a Setup Password Enabled

If Setup Password is set to Enabled, you must enter the correct setup password before you can modify the majority of the System Setup options.

When you start the System Setup program, Page 2 of the System Setup screens appears with the Setup Password option highlighted, prompting you to type the password.

If you do not enter the correct password in three tries, the system lets you view, but not modify, the System Setup screens—with the following exceptions:

If System Password is not enabled and is not locked via the Password Status option, you can assign a system password (however, you cannot disable or change an existing system password).



NOTE: You can use the Password Status option in conjunction with Setup Password to protect the system password from unauthorized changes. For more information, see "[Password Status](#)."

Deleting or Changing an Existing Setup Password

To delete or change an existing setup password, perform the following steps:

1. Enter the System Setup program and go to Page 2 of the System Setup screens.

Refer to "[Entering the System Setup Program](#)." Press the <Alt><p> key combination to move to Page 2 of the System Setup screens.

2. Highlight the Setup Password option, type in the setup password, and press the left- or right-arrow key to delete the existing setup password.

The setting changes to Not Enabled.

3. If you want to assign a new setup password, follow the procedure in "[Assigning a Setup Password](#)."

Disabling a Forgotten Password

If you forget your system or setup password, you cannot operate your system or change settings in the System Setup program until you remove the computer cover, change the password jumper setting to disable the passwords, and erase the existing passwords.

To disable a forgotten password, perform the following steps.



CAUTION: Before you begin, see "[Safety First — For You and Your Computer](#)."

1. Remove the computer cover according to the instructions in "[Removing the Computer Cover](#)."
2. Remove the jumper plug from the PSWD jumper to disable the password feature.

Refer to "[Jumpers](#)" for jumper information and for the location of the password jumper (labeled "PSWD") on the system board.

3. Replace the computer cover.
4. Reconnect your computer and peripherals to their power sources, and then turn them on.

Booting your system with the PSWD jumper plug removed erases the existing password(s).

5. Enter the System Setup program and verify that the password is disabled. Proceed to step 6 if you want to assign a new password.



NOTE: Before you assign a new system and/or setup password, you must replace the PSWD jumper plug.

6. Remove the computer cover according to the instructions in "[Removing the Computer Cover](#)."
7. Replace the PSWD jumper plug.
8. Replace the computer cover, and then reconnect the computer and peripherals to their power sources and turn them on.

Booting with the PSWD jumper installed reenables the password feature. When you enter the System Setup program, both password options appear as Not Enabled, meaning that the password feature is enabled but that no password has been assigned.

9. Assign a new system and/or setup password.

To assign a new system password, see "[Assigning a System Password](#)." To assign a new setup password, see "[Assigning a Setup Password](#)."

Responding to Error Messages

If an error message appears on your monitor screen while the system is booting, make note of the message. Then, before entering the System Setup program, refer to your *Diagnostics and Troubleshooting Guide* for an explanation of the message and suggestions for correcting any errors. However, it is normal to receive an error message the first time you boot the system after a memory upgrade. In that case, you do not need to refer to the *Diagnostics and Troubleshooting Guide*; instead, refer to the instructions in "[Adding Memory](#)."

If you are given an option of pressing either <F1> to continue or <F2> to run the System Setup program, press the <F2> key.

[Back to Contents Page](#)

[Back to Contents Page](#)

Using the ISA Configuration Utility: Dell™ OptiPlex™ GX1 Low-Profile Managed PC Systems

- [Overview](#)
- [Quick Start](#)
- [About the ICU](#)
- [When to Run the ICU](#)
- [Preparing to Use the ICU](#)
- [Starting the ICU](#)
- [Adding a Listed Card](#)
- [Adding an Unlisted Card](#)
- [Modifying a Card](#)
- [Removing a Card](#)
- [Viewing Resources](#)
- [Saving the System Configuration](#)
- [Exiting From the ICU](#)
- [Locking and Unlocking Cards](#)

Overview

The ISA Configuration Utility (ICU) is used by the system to track what expansion cards are installed and what resources are used. With this information, the system automatically configures Plug and Play expansion cards and Peripheral Component Interconnect (PCI) expansion cards and can tell you how to configure non-Plug and Play Industry-Standard Architecture (ISA) expansion cards manually by setting jumpers or switches. Plug and Play and PCI expansion cards do not contain jumpers and switches; they are configured only through software.

NOTICE: The ICU is intended only for configuring non-Plug and Play ISA expansion cards. It should not be used for assigning resources to Plug and Play expansion cards and PCI expansion cards. These cards should be configured automatically by the basic input/output system (BIOS).



NOTES: The Microsoft® Windows NT® operating system does not provide full Plug and Play support. Therefore, some Plug and Play cards (such as modem, sound, and network cards) may not work with Windows NT. If your system is running a Dell-installed Windows NT operating system and you want to use Plug and Play expansion cards, Dell recommends that you use the card manufacturer's configuration utility to set the card to legacy mode, enter the card's resources through the manufacturer's utility, and then use the ICU to add the Plug and Play expansion card to your system configuration. On systems with a Dell-installed Windows NT operating system, the ICU is installed on the hard-disk drive as a diskette image. Use the Dell Program Diskette Maker (in the Dell Accessories folder) to make an ICU diskette from this diskette image.

If you are using the Microsoft Windows® 95 or Windows 98 operating system, the functions provided by the ICU are handled by the Device Manager, which can be accessed by double-clicking the System icon in the Control Panel. See your Windows 95 or Windows 98 documentation for

instructions on using the Device Manager to manage resources and resolve conflicts.

The remainder of this chapter describes the various features of, and the various ways to use, the ICU.

Quick Start

To quickly get started using this utility, follow these steps:

1. Determine whether you need to run the ICU.

See "[When to Run the ICU](#)" for detailed instructions.

2. Perform any required preparatory steps before starting the utility.

Preparatory steps include making a program diskette, copying your mouse driver to this diskette, and making a backup copy of this diskette. See "[Preparing to Use the ICU](#)" for detailed instructions.

3. Start the system using your ICU diskette.

Verify that the Boot Sequence option in the System Setup program is set to Diskette First. Then insert the backup copy of the ICU diskette into drive A and turn on your computer or press the reset button.



NOTE: The ICU takes a few minutes to load. During this time, the cursor may appear as an hourglass rather than as a pointer.

When the utility has finished loading, the ICU window (see [Figure 1](#)) is displayed.

4. Add, modify, or remove a card, or view resources for a card or other device.

Depending on what you need to accomplish with the ICU, you may need to perform one or more of these tasks:

- If you are adding a non-Plug and Play ISA expansion card, see your online *System User's Guide* or "[Adding a Listed Card](#)" for detailed instructions. If the card you are adding does not have a configuration file, see your online *System User's Guide* or "[Adding an Unlisted Card](#)" for detailed instructions.
 - If you are modifying a card that is already installed, see your online *System User's Guide* or "[Modifying a Card](#)" for detailed instructions.
 - If you are removing a card, see your online *System User's Guide* or "[Removing a Card](#)" for detailed instructions.
 - If you want to examine the resources already assigned in the system, see your online *System User's Guide* or "[Viewing Resources](#)" for detailed instructions.
5. Save your configuration and exit the utility.

See your online *System User's Guide* or "[Saving the System Configuration](#)" and "[Exiting From the ICU](#)" for detailed instructions.

About the ICU

Before your system was shipped from Dell, a technician used the ICU to enter the correct information for the expansion cards initially installed in your computer.

If your system was shipped with Dell-installed software, the ICU diskette image (from which you can make an ICU diskette) is installed on your hard-disk drive. (Your system may also be accompanied by an *ISA Configuration Utility Diskette*.)

The ICU is also available through online services such as Dell's TechConnect bulletin board service (BBS). See your online *System User's Guide* or the chapter titled "Getting Help" in your *Diagnostics and Troubleshooting Guide* for information on accessing the BBS.

Whenever you add or remove a non-Plug and Play ISA expansion card, use the ICU to reconfigure your system. The utility reads the card's corresponding configuration file (**.cfg** file), which describes the card's characteristics and required system resources. After the resources identified in these configuration files are assigned to all non-Plug and Play ISA expansion cards, the system assigns resources to all Plug and Play expansion cards, as well as PCI expansion cards, thereby creating a conflict-free configuration.

ICU Database

The ICU provides a database of configuration files for a large variety of non-Plug and Play ISA expansion cards. The database is located in the **vdb** subdirectory. Listed cards are non-Plug and Play ISA expansion cards that have configuration files stored in this database.

Unlisted cards are non-Plug and Play ISA expansion cards that do not have configuration files stored in the ICU database. Unlisted cards are not displayed in the list of cards provided for the various card categories. The unlisted cards may be cards for which no configuration file exists or new cards that include a manufacturer-supplied configuration file on diskette.

When you supply a configuration file and the ICU is running from the hard-disk drive, the configuration file is copied to the directory that contains the rest of the ICU database.

When to Run the ICU

Whenever you add or remove non-Plug and Play ISA expansion cards, you must run the ICU to ensure that no two cards attempt to use the same resources (such as interrupt request [IRQ] lines).

Run the program before adding or removing any non-Plug and Play ISA expansion cards. The ICU can identify and resolve any resource conflicts and indicate the proper jumper and switch settings for each expansion card to avoid such conflicts. Running the program first helps you determine how to configure a non-Plug and Play ISA expansion card before you install it in your computer.

After you have run the ICU for your non-Plug and Play ISA expansion cards and it has configured all your Plug and Play and PCI expansion cards, you can use the utility to lock the configuration of your Plug and Play and PCI expansion cards so that they are always assigned the same resources. See your online *System User's Guide* or "[Locking and Unlocking Cards](#)" for details.

Preparing to Use the ICU

Before using the ICU for the first time, you must complete the following steps:

1. Make an ICU program diskette of the utility from the *Dell ResourceCD*.



NOTE: If you received an ISA Configuration Utility Diskette with your system, skip to step 2.

Follow the instructions displayed on the screen to create an ICU program diskette.

2. If you want to use your mouse with the ICU, copy your mouse driver file (**mouse.exe**) to your ICU diskette.
3. Make a backup copy of your ICU diskette, as described in the next subsection, "Backing Up the ICU Diskette."

Use the backup copy whenever you run the utility; store the original diskette in a safe place.

Backing Up the ICU Diskette

Before using the ICU, make a backup copy of the ICU diskette by performing the following steps.



NOTE: If you received an ISA Configuration Utility Diskette with your system, use this procedure to create a backup of that diskette.

1. Make sure you have a blank, high-density, 3.5-inch diskette.
2. Turn on your computer system if it is not already on.
3. Make a copy of the ICU program diskette.

See your operating system documentation for instructions on making a copy of a diskette.

4. Store your original ICU diskette in a safe place.

Use only the backup diskette when running the ICU.

Starting the ICU

After you have completed the procedures in "[Preparing to Use the ICU](#)," insert the backup copy of the ICU diskette into drive A. Then either turn on your system or reboot it by pressing the reset button.

Accessing Help

You can access online help in the ICU in four ways:

- Select Contents from the Help menu to display a list of topics. Select a topic and click Help. Help text on that topic appears in a dialog box.
- For most dialog boxes, you can click Help to display information on the action you are performing.
- From the ICU window, press the <F1> key to display a list of available help topics.
- To redisplay the last message you received from the ICU, select Previous Message from the Help menu.

Making Selections in the ICU

The ICU window is the main window of the utility and the starting point for making expansion-card changes. This window lists all non-Plug and Play ISA, Plug and Play, and PCI expansion cards currently installed in the computer. The ICU window contains menus and a tool bar, as shown in Figure 1. When you choose a course of action, the ICU displays dialog boxes to guide you through the various steps.

Figure 1. ICU Window

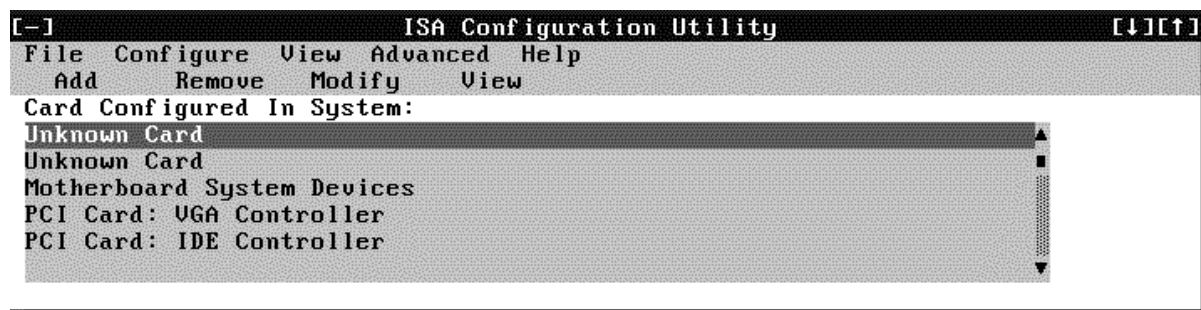

You can maneuver through each menu and dialog box using a mouse. If a mouse is not available, you can use the keys shown in Table 1.

Each menu and menu option has an underlined character in its name; when you press the <Alt> key in conjunction with the key for the underlined character, that menu or menu option is selected.

Table 1. ICU Keys

Key(s)	Action
<Alt><x><y>	Displays the menu containing the underlined letter x and performs the operation indicated by the menu item containing the underlined letter y. For example, to save a file (that is, to display the File menu and select the Save menu option), press <Alt><f> and <s>.
<Tab>	Moves from one control button or list to another.
Up- and down-arrow keys	Moves up and down through items in a list.
Spacebar	Highlights an item in a list.
<Enter>	Selects the highlighted button or item in a list.

Adding a Listed Card



NOTE: If you want to add a configuration file that you received on diskette with a new expansion card, you must copy the configuration file to the **\db** subdirectory on the backup copy of the ICU diskette. You should then reboot your system and perform the following procedure to add the expansion card.

Use the following procedure to add a listed card with the ICU:

1. Start the ICU as described in "[Starting the ICU.](#)"
2. From the ICU window, click Add or select Add Card from the Configure menu.
3. Click the name of the category of card that you want to add. If you clicked Add in step 2, click OK.

A dialog box like the one in Figure 2 appears, listing the names of all available cards of that type.

Figure 2. Add Network Card Dialog Box

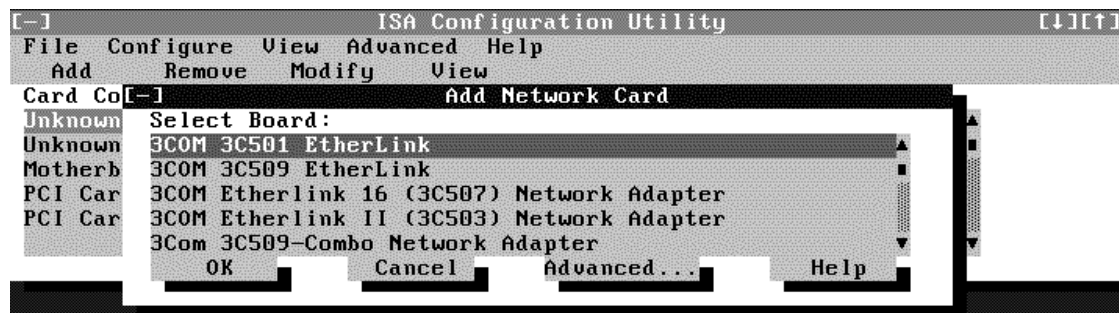

4. Select the name of the card you want to add.

If the card is not listed, see "[Adding an Unlisted Card.](#)"

5. If you want the ICU to select the resources for the card, click OK. Otherwise, skip to step 6.

The ICU uses the default resources set by the card manufacturer whenever possible. If the ICU cannot find a resource that is valid for the card and available in the system, the utility generates an error message. See "[ISA Configuration Utility Messages](#)" for an explanation of the message and a possible solution to the conflict.

If you are satisfied with the default resources assigned to the card, you can skip the remainder of this procedure.

6. To select the resources yourself, click Advanced.

The Card Configuration dialog box (see Figure 3) displays all resources used by the card. Some cards have multiple functions, each having one or more resources associated with it. For example, a communications card can have fax, modem, and scanner functions, each of which may have one or more associated resources.

Figure 3. CardConfiguration Dialog Box

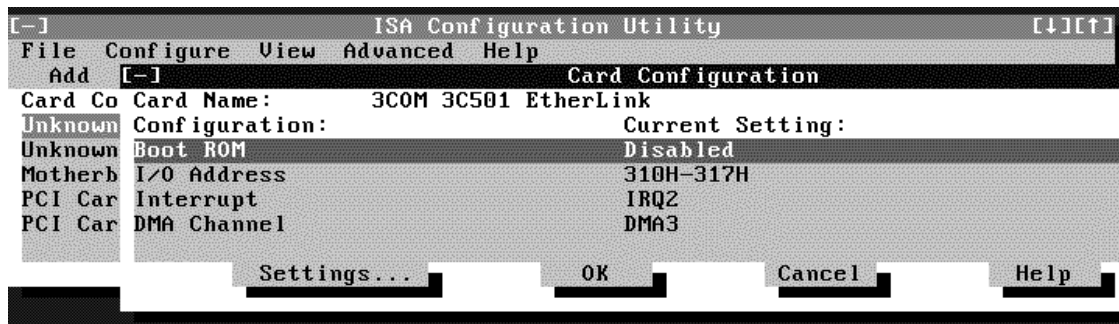

- To change any of the resource settings for the card, select the resource setting and then click Settings.

The Configuration Settings dialog box (see Figure 4) displays the name of the resource that you selected in the upper-left corner of the box. The resource values currently associated with the selected function are displayed in the Resources for Choice box. The resource values displayed are IRQ, DMA, Memory (Hex), and I/O Port (Hex).

Figure 4. Configuration Settings Dialog Box for Assigning an IRQ Line

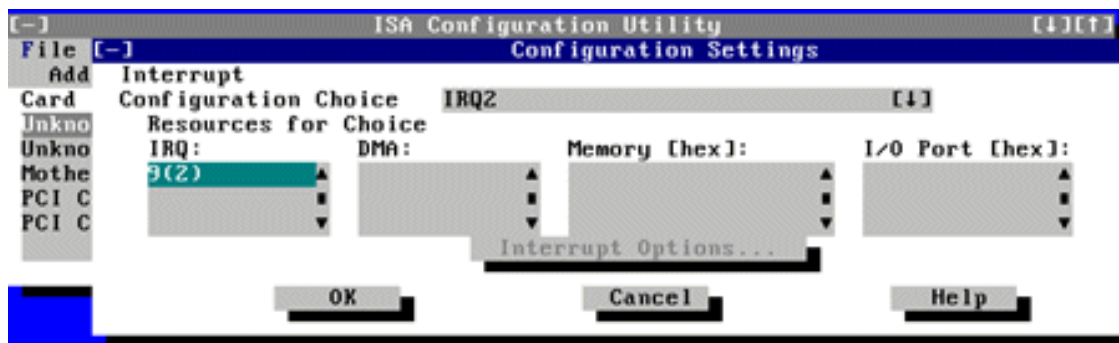

- To change the resource settings, click the down arrow next to the Configuration Choice box. Then click the new resource setting from the list of available settings (see [Figure 5](#)).

You cannot manually enter a value; you must choose a setting from the list. If there is only one setting listed, no other settings are available.

The setting that you select may affect the resources available. For example, if you are offered the Disabled option and select it, all resource values are blank, indicating that a disabled setting uses no resources.

Figure 5. Available Settings List Box

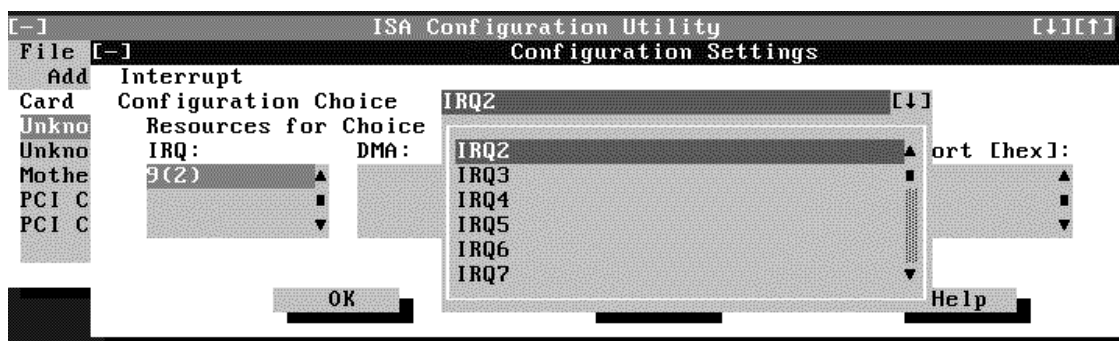

- To change individual resource values for the current configuration setting, select the resource value that you want to change and click the Options button located below the resource values (see [Figure 6](#)).

For example, when you click the value under DMA, the Options button changes to the DMA Options button. When you click this button, a smaller dialog box appears. By clicking the down arrow next to the current resource value, you can display a list of the available values for the resource.

Figure 6. Configuration Settings Dialog Box for Assigning a DMA Channel

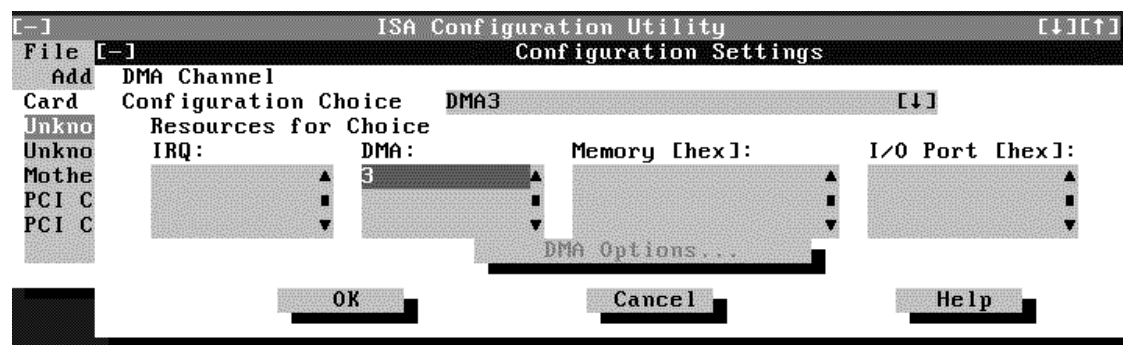

Choose the desired value and click OK. The value you selected is displayed under the resource heading in the Configuration Settings dialog box.

The Options button is disabled if no alternative values are available for the selected resource.

 **NOTE:** If you change one or more resource values using the Options button and later change the setting in the Configuration Choice box, the changes that you made to the resource values are overwritten by the default values for the new configuration choice.

- Click OK in the Configuration Settings dialog box when you have finished selecting resources for the function.

 **NOTE:** After modifying the system configuration, you must turn off the system to install, remove, or change jumper settings on the non-Plug and Play ISA expansion cards to match the settings you selected in the ICU.

Adding an Unlisted Card

Unlisted cards are non-Plug and Play ISA expansion cards that do not have configuration files stored in the ICU database.

 **NOTE:** If you want to add a configuration file that you received on diskette with a new expansion card, see "[Adding a Listed Card](#)."

To add an unlisted card with the ICU, perform the following steps:

- Start the ICU as described in "[Starting the ICU](#)."

2. From the ICU window, click Add or select Add Card from the Configure menu.
3. Click the name of the category of card that you want to add. If you clicked Add in step 2, click OK.

A dialog box appears listing the names of all available cards of that type.

4. Select Unlisted Card from the bottom of the list of cards displayed in the dialog box that appears. Then click OK.
5. Click No when the ICU asks if you have a configuration file for the card.

The Configure Unlisted Card dialog box appears with blank fields.

6. Enter the name of the card that you want to add in the Card Name field.
7. For each resource you want to assign to the card, click the box beneath the name of the resource to be assigned and then click Add.

For example, if you click the box beneath IRQ, the button changes to Add Interrupt. When you click this button, a Specify dialog box (in this case, Specify Interrupt) appears. Figure 7 shows the Configure Unlisted Card dialog box with the Specify Interrupt dialog box opened.

Figure 7. Specify Interrupt Dialog Box

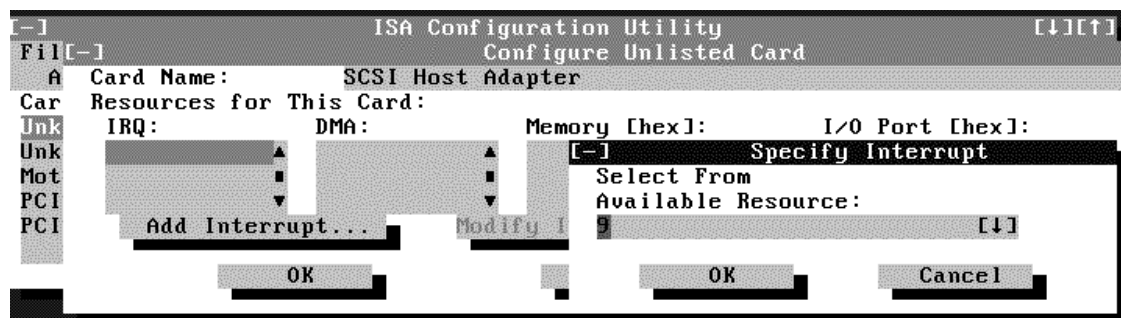

If you are providing a value for the IRQ or DMA resource, click the down arrow beneath Available Resources. A smaller Specify list box appears (see Figure 8). Click the value you want to assign to the resource. Then click OK.

Figure 8. Specify Interrupt List Box

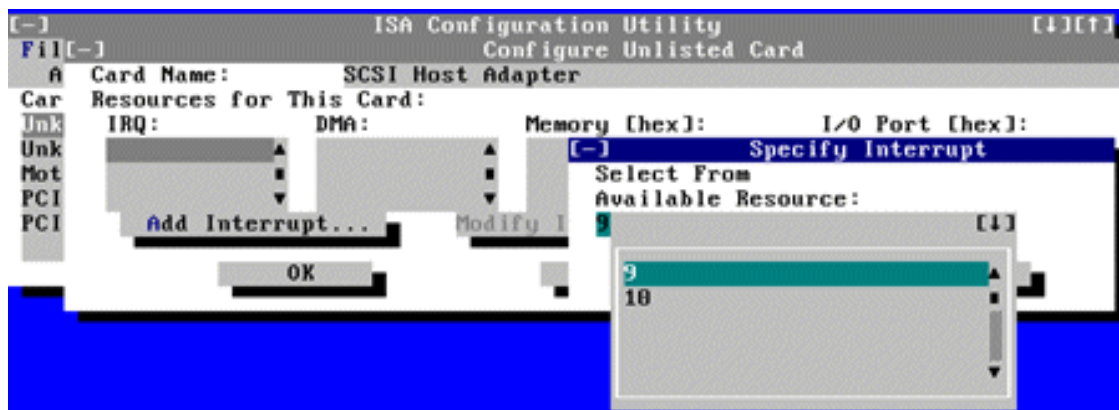

If none of the values for the DMA or IRQ resources match the allowable values for your unlisted card (as indicated in the card's documentation), select one of the available values offered by the utility and click OK.

If you are providing values for the input/output (I/O) port or memory resources, you must enter the starting and ending addresses in hexadecimal format using the two fields provided by the Specify Memory or Specify I/O Port dialog box (see Figure 9). Click each box in succession to enter the beginning and ending addresses, and then click OK to complete the selection.

Figure 9. Specify I/O Port Dialog Box

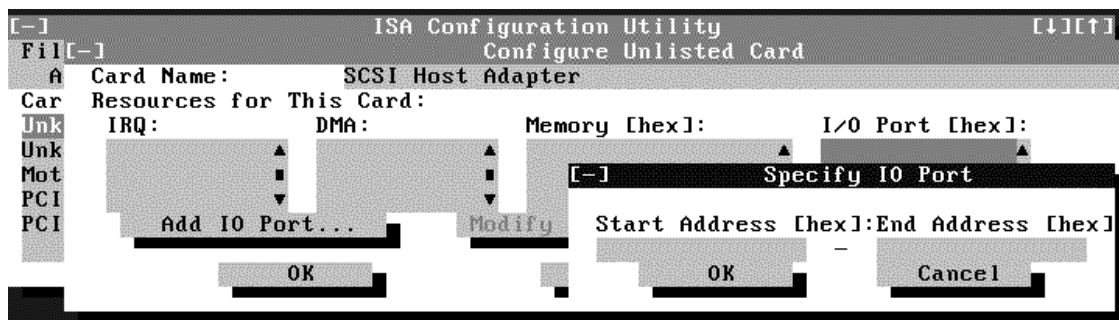

8. When you have finished selecting resources for the unlisted card, click OK in the Configure Unlisted Card dialog box.

A message box appears, notifying you either that the card is using its default settings or that it cannot use its default settings and must be reconfigured.

9. Click OK. If the card must be reconfigured, record the resource settings recommended by the ICU. Click Close to accept the resource settings currently displayed.
10. If you had to assign a disallowed resource value to the card in steps 7, 8, and 9, click each of the other cards, and then click View until you find another card using a resource value that is allowed for the unlisted card. Reassign the resource setting for this other card using the procedure in "[Modifying a Card](#)." Then modify the resource settings for the unlisted card so that it uses an allowable value.



NOTE: After modifying the system configuration, you must turn the system off to install, remove, or change jumper settings on the non-Plug and Play ISA expansion cards to match the settings you selected in the ICU.

Modifying a Card

Modifying a card allows you to change the system resources used by a card. This feature is helpful when you want to add a card that requires resources already in use by other cards or devices in your computer. You can allocate different resources to the cards currently in your computer to free the resources necessary for the card you want to install.

You can also use this feature to force Plug and Play or PCI expansion cards to use specific resource values. This procedure is called locking a card. You should lock a card only if it uses static device drivers. See "[Locking and Unlocking Cards](#)" for more information.



NOTE: You cannot modify the resources of a Plug and Play or PCI expansion card. You can only view the resources currently assigned and lock or unlock them.

To modify the resource settings for a listed or unlisted card, complete the following steps:

1. Start the ICU as described in "[Starting the ICU](#)."
2. Select the card from the list of installed cards in the ICU window, and choose Modify Card from the Configure menu or click Modify.

If the Card Configuration dialog box appears, the selected card is listed (it has a configuration file in the ICU database). Continue with step 3.

If the Configure Unlisted Card dialog box appears, the card is unlisted (it does not have a configuration file). Proceed to step 5.



NOTE: When you modify an unlisted card, the ICU cannot show you the valid resources for the card. Therefore, you must have documentation from the card manufacturer that describes the resources and resource settings that the card can use.

3. Follow steps 7 through 9 in "[Adding a Listed Card](#)." Then continue with step 4 of this procedure.
4. Click OK to complete the card modifications and return to the ICU window.

You have completed this procedure; do not proceed to step 5.

5. To add, modify, or remove a resource value, select the box beneath the resource to be assigned, and then click Add, Modify, or Remove, respectively.

For example, if you click the box beneath IRQ, the Add, Modify, and Remove buttons change to Add Interrupt, Modify Interrupt, and Remove Interrupt. When you click one of these buttons, a smaller Specify list box (in this case, Specify Interrupt) appears.

If you are providing a value for the IRQ or DMA resource, click the down arrow beneath Available Resources. Click the value you want to assign to the resource. If the resource can be shared with another card or device, click Sharable. Then click OK.

If none of the values for the DMA or IRQ resource match the allowable values for your unlisted card (as

indicated in the card's documentation), select one of the available values offered by the utility and click OK.

If you are providing values for the I/O port or memory resource, you must enter the starting and ending addresses in hexadecimal format using the two fields provided by the Specify Memory or Specify I/O Port dialog box.

6. When you have finished selecting resources for the unlisted card, click OK in the Configure Unlisted Card dialog box.

A message box appears, notifying you either that the card is using its default settings or that it cannot use its default settings and must be reconfigured.

7. Click OK. If the card must be reconfigured, record the resource settings recommended by the ICU. Click Close to accept the resource settings currently displayed.
8. If you had to assign a disallowed resource value to the card in steps 5, 6, and 7, click each of the other cards, and then click View until you find another card using a resource value that is allowed for the unlisted card. Reassign the resource setting for this other card. Then modify the resource settings for the unlisted card so that it uses an allowable value.



NOTE: After modifying the system configuration, you must turn off the system to install, remove, or change jumper settings on the non-Plug and Play ISA expansion cards to match the settings you selected in the ICU.

Removing a Card

Before you remove a non-Plug and Play ISA expansion card from your computer, you must use the ICU to remove the card from the system configuration.



NOTE: When you remove a Plug and Play or PCI expansion card from your computer, you do not need to run the ICU. To remove a Plug and Play or PCI expansion card, complete steps 2 through 9 in "[Removing an Expansion Card](#)."

Use the following procedure to remove a non-Plug and Play ISA expansion card from your computer:

1. Start the ICU as described in "[Starting the ICU](#)."
2. Select the card from the current system configuration list in the ICU window.
3. Select Remove Card from the Configuration menu, or click Remove.

The ICU requests verification that you want to remove the card.

4. Click Yes to free the resources allocated to the card and remove the card name from the list of active cards, or click No to cancel the operation.

The ICU returns to the ICU window.

NOTICE: After removing a card from the system configuration using the ICU, you must turn off

the system and physically remove the card. Failure to do so can damage your system.

- Remove the non-Plug and Play ISA expansion card from the computer.

See "[Removing an Expansion Card](#)" for instructions.

Viewing Resources

The ICU displays all resources currently used by your system.

To view all system resources, select System Resources from the View menu or click View. The System Resource Usage dialog box (see Figure 10) displays all resources currently used by the system.

Figure 10. System Resource Usage Dialog Box

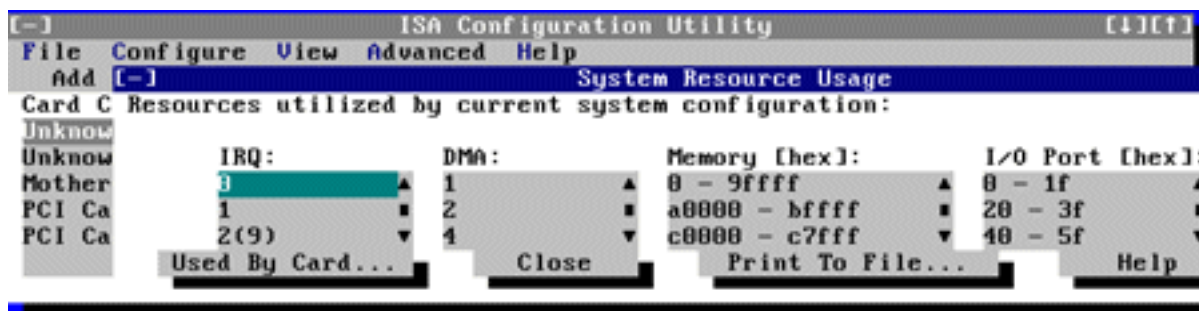

To determine which card uses a particular resource shown in the System Resource Usage dialog box, select the resource in question and then click Used By Card. The Card Resource Usage dialog box appears with the information.

To view the resources that a particular card is using, select the card from the list displayed in the ICU window, and then select Card Resources from the View menu or click View. The Card Resource Usage dialog box displays the resources assigned to that card. Figure 11 shows resources that might be assigned to a network adapter card.

Figure 11. Card Resource Usage Dialog Box

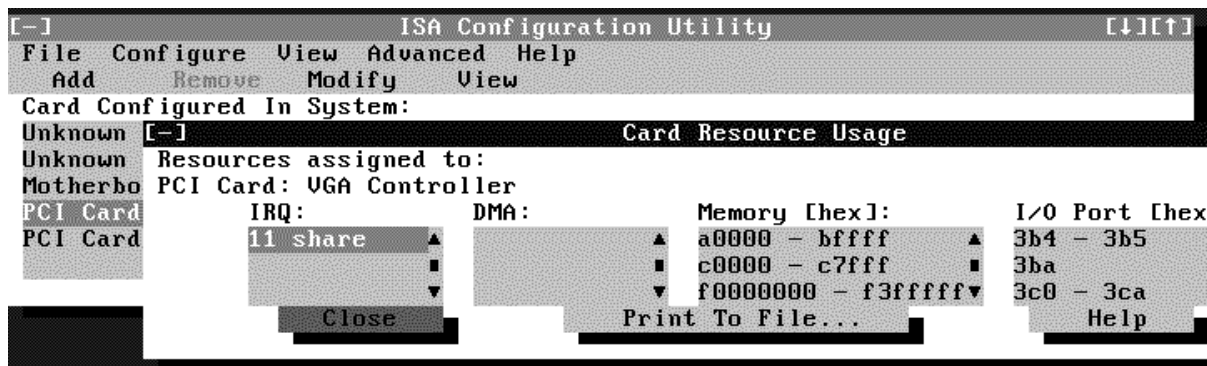

You can save the information displayed in the Card Resource Usage dialog box by clicking Print To File. The ICU then prompts you for a filename.

Saving the System Configuration

You can save the system configuration to nonvolatile random-access memory (NVRAM) as you configure each card's resources. To do so, select Save from the File menu and continue with your operation.

Exiting From the ICU

At the ICU window, select Exit from the File menu to exit the utility. If you have made any changes to the system configuration, you are asked whether you want to save the changes.

If you click Yes, the ICU saves the updated system configuration information into NVRAM. If you click No, you exit the ICU without saving any of your configuration changes. If you click Cancel, nothing is saved and the utility continues to operate.

Locking and Unlocking Cards

The ICU includes a locking mechanism that enables you to allocate the system resources for all or for some functions of Plug and Play and PCI expansion cards. These expansion cards are dynamic, which means that they are allocated resources at system start-up. Device drivers that do not support this dynamic card configuration are referred to as static device drivers.

To determine whether your expansion card has static device drivers, check the documentation that came with the drivers. If you are using a static device driver, you need to permanently associate resources with a Plug and Play expansion card, instead of relying on the default Plug and Play behavior. Otherwise, the device driver might not be able to find the card the next time the system boots. This procedure is referred to as locking a card.



NOTE: The locking feature of the ICU is valid only for Plug and Play and PCI expansion cards.

Locking and Unlocking All Resources

To lock or unlock all the resources and configurations for a Plug and Play or PCI expansion card, perform the following steps:

1. If it is not already installed, install the Plug and Play or PCI expansion card. Then turn on the system.

Complete steps 2 through 10 in "[Installing an Expansion Card](#)."

2. Start the ICU.

See "[Starting the ICU](#)."

3. Select Locking Enabled from the Advanced menu in the ICU window.

A check mark next to Locking Enabled signifies that the feature is active; a Lock button appears on the tool bar.

4. Select the Plug and Play or PCI expansion card that you want to lock or unlock from the Cards Configured in System list.
5. Click Lock or select Lock/Unlock Card from the Advanced menu.

Both options toggle the lock state of the selected card.

Locking and Unlocking Configuration Resources

You can also lock and unlock individual resources for a Plug and Play or PCI expansion card. To do so, perform the following steps:

1. If it is not already installed, install the Plug and Play or PCI expansion card. Then turn on the system.

Complete steps 2 through 10 in "[Installing an Expansion Card](#)."

2. Start the ICU.

See "[Starting the ICU](#)."

3. Select Locking Enabled from the Advanced menu in the ICU window.

A check mark next to Locking Enabled signifies that the feature is active; a Lock button appears on the tool bar.

4. Select the Plug and Play or PCI expansion card that you want to lock or unlock from the Cards Configured in System list.

5. Click Modify or select Modify Card from the Configure menu.

6. From the Card Configuration dialog box, select the function you want to lock or unlock.

7. Click Settings.

8. Modify the resource setting and/or resources offered on the Configuration Settings dialog box, if necessary.

See "[Modifying a Card](#)" for more information.

9. Select Lock Resources.

The Lock Resources box toggles the lock state of the selected configuration setting.

10. Repeat steps 6 through 9 for any other configuration settings that you want to lock or unlock.

11. Click OK in the Card Configuration dialog box when you have finished making your selections.

[Back to Contents Page](#)

[Back to Contents Page](#)

Working Inside Your Computer: Dell™ OptiPlex™ GX1 Low-Profile Managed PC Systems

- [Overview](#)
- [Before You Begin](#)
- [Removing the Computer Cover](#)
- [Replacing the Computer Cover](#)
- [Inside Your Computer](#)
- [Removing and Replacing the Expansion-Card Cage](#)

Overview

Your Dell computer system supports a variety of internal options that expand system capabilities. This section prepares you to install options inside the computer. It describes how to remove and replace the computer cover and expansion-card cage. It also familiarizes you with the internal components you may handle if you install Dell hardware options.

Before You Begin

To make working inside your computer easier, make sure you have adequate lighting and a clean work space. If you temporarily disconnect cables or remove expansion cards, note the position of the connectors and slots so that you can reassemble the system correctly.

You will use the information in this section every time you install a hardware option inside your computer. Read this section carefully, because the information is not repeated in detail elsewhere.

Safety First — For You and Your Computer

Working inside your computer is safe—if you observe the following precautions.

CAUTION FOR YOUR PERSONAL SAFETY AND PROTECTION OF YOUR EQUIPMENT

Before starting to work on your computer, perform the following steps in the sequence indicated:

1. Touch an unpainted metal surface on the computer chassis, such as the power supply, before touching anything inside your computer.

While you work, periodically touch an unpainted metal surface on the computer chassis to dissipate any static electricity that might harm internal components. Also avoid touching components or contacts on a card and avoid touching pins on a chip.

2. Turn off your computer and all peripherals.
3. Disconnect your computer and peripherals from their AC power sources. Also, disconnect any telephone or telecommunication lines from the computer. Doing so reduces the potential for personal

injury or shock.

4. If you are disconnecting a peripheral from the computer or are removing a component from the system board, wait 5 seconds after turning off the computer before disconnecting the peripheral or removing the component to avoid possible damage to the system board.

In addition, Dell recommends that you periodically review the safety instructions in your *System Information Guide*.

Unpacking Your Hardware Option

When you remove an option from its shipping carton, you may find it wrapped in antistatic packing material designed to protect it from electrostatic damage. Do not remove the packing material until you are ready to install the option.

Removing the Computer Cover

 **NOTE:** If your chassis has an optional stand for vertical orientation attached to it, [remove the optional stand](#) before you remove the computer cover.

Use the following procedure to remove the computer cover:

1. Turn off your computer and peripherals, and observe the Caution for Your Personal Safety and Protection of Your Equipment described in "[Safety First — For You and Your Computer](#)."
2. If you have installed a padlock through the padlock ring on the back panel (see Figure 1), remove the padlock.

Figure 1. Padlock Installed

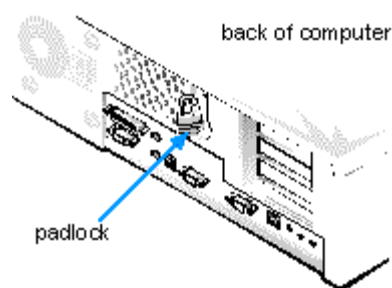

3. Remove the cover.

Face the front of the computer and press in the two securing cover-release buttons that are located on the sides of the cover toward the back (see [Figure 2](#)).

With the buttons depressed, lift the cover at the back, allowing it to pivot up toward you.

Disengage the plastic hooks that secure the cover to the front of the chassis, and lift the cover away.

Figure 2. Removing the Computer Cover

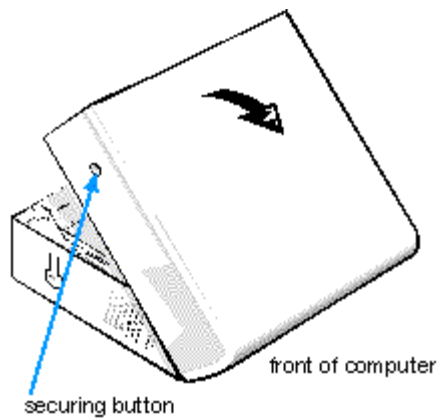

Replacing the Computer Cover

Use the following procedure to replace the computer cover:

1. Check all cable connections, especially those that might have come loose during your work. Fold cables out of the way so that they do not catch on the computer cover. Make sure cables are not routed over the drive cage—they will prevent the cover from closing properly.
2. Check to see that no tools or extra parts (including screws) are left inside the computer's chassis.
3. Replace the cover.

Face the front of the computer and hold the cover at a slight angle as shown in [Figure 3](#). While aligning the back of the cover with the chassis, insert the cover hooks into the rectangular slots on the chassis. (It may be helpful to look down into the chassis to verify that the hooks are in place.)

Pivot the cover down toward the back and into position. With both hands, press against the top edge of the cover to make sure that the securing buttons click into place.

Figure 3. Replacing the Computer Cover

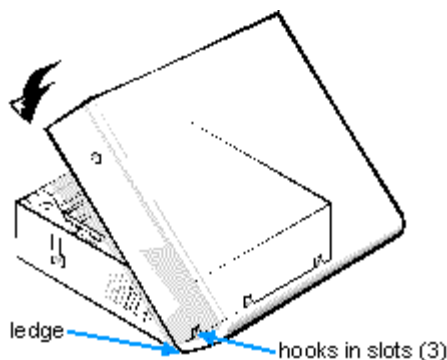

4. If you are using the optional floor stand, reattach it.

See "[Using the Optional Stand for Vertical Orientation](#)" for instructions.

5. If you are using a padlock to secure your system, reinstall the padlock.

Inside Your Computer

Figure 4 shows an overhead view of your computer to help orient you when installing hardware options. Unless otherwise specified, locations or directions relative to the computer are as shown.

Figure 4. Computer Orientation View

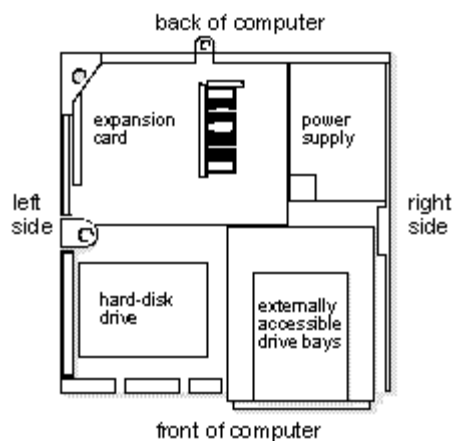

[Figure 5](#) shows your computer with its cover removed. Refer to this illustration to locate interior features and components discussed in this guide.

When you look inside your computer, note the *DC* power cables coming from the power supply. These cables supply power to the system board; to internal diskette drives, hard-disk drives, and tape drives; and to certain expansion cards that connect to external peripherals.

The flat ribbon cable in [Figure 5](#) is typical of the interface cables for internal drives. An interface cable connects a drive to a connector on the system board or on an expansion card.

The system board—the large printed circuit board at the bottom of the chassis—holds the computer's control circuitry and other electronic components. Some hardware options are installed directly onto the system board.

During an installation procedure, you may be required to change a jumper setting on the system board and/or a jumper setting on an expansion card or on a drive. Jumpers provide a convenient and reversible way of reconfiguring the circuitry on a printed circuit board. For more information, see "[Jumpers](#)."

Figure 5. Inside the Chassis

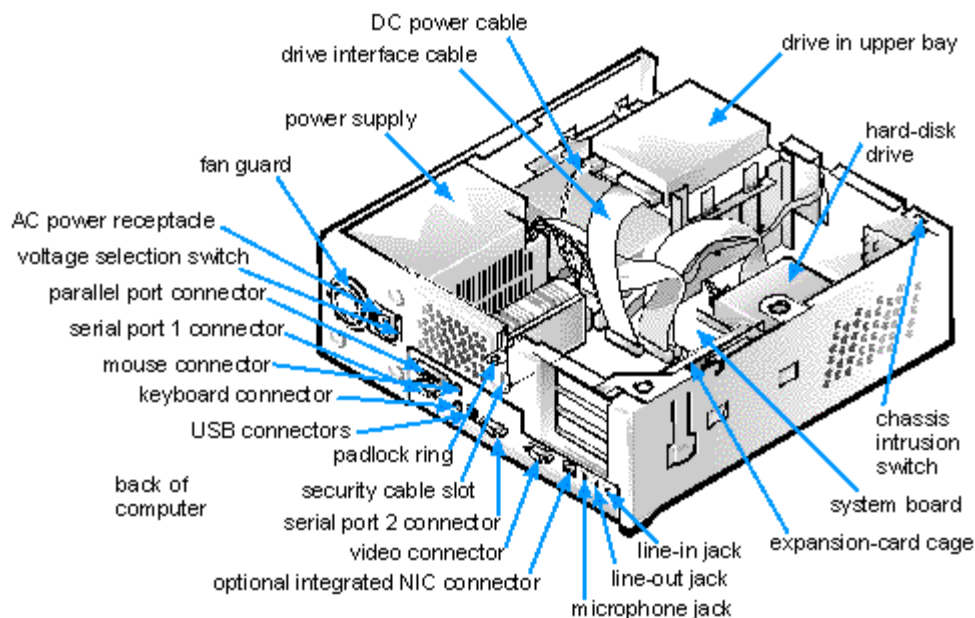

Jumpers

Jumpers are small blocks on a circuit board with two or more pins emerging from them. Plastic plugs containing a wire fit down over the pins. The wire connects the pins and creates a circuit.

To change a jumper setting, pull the plug off its pin(s) and carefully fit it down onto the pin(s) indicated.

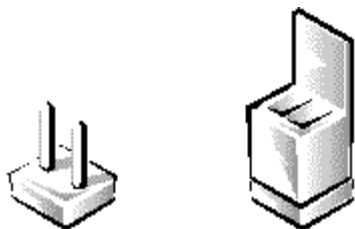

NOTICE: Make sure your system is turned off before you change a jumper setting. Otherwise, damage to your system or unpredictable results may occur.

A jumper is referred to as open or unjumped when the plug is pushed down over only one pin or if there is no plug at all. When the plug is pushed down over two pins, the jumper is referred to as jumped. In some documents, the jumper setting may be shown in text as two numbers, such as 1-2. The number 1 is printed on the circuit board so that you can identify each pin number based on the location of pin 1.

[Figure 6](#) shows the location and default settings of the jumper blocks on your system board. See [Table 1](#) for the designations, default settings, and functions of your system's jumpers.

Figure 6. System Board Jumpers

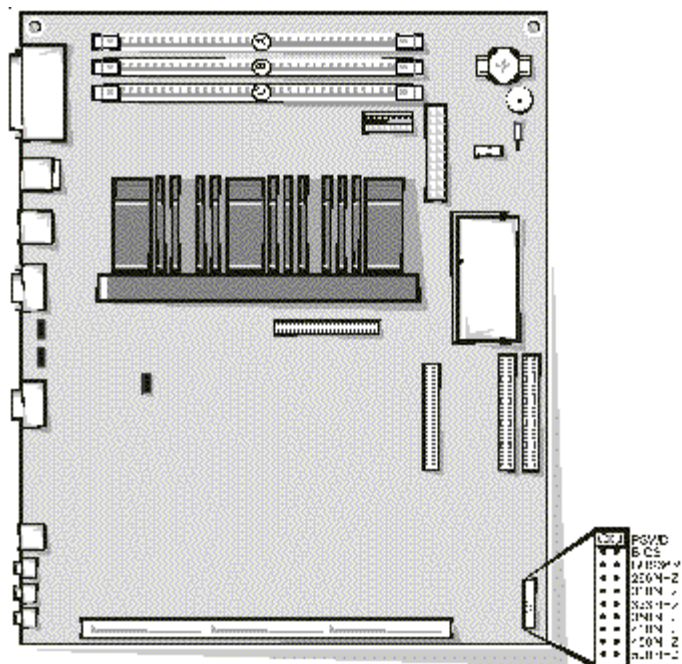













 jumpered  unjumpered

Table 1. System-Board Jumper Settings

Jumper	Setting	Description
PSWD	 (default)	Password features are enabled.
		Password features are disabled.
BIOS	 (default)	Reserved (do not change).
BUS66M	 (default)	Reserved (do not change).
266MHZ*	 (default)	Reserved (do not change).
300MHZ*	 (default)	Reserved (do not change).
333MHZ*	 (default)	Reserved (do not change).
350MHZ*	 (default)	Reserved (do not change).
400MHZ*	 (default)	Reserved (do not change).
450MHZ*	 (default)	Reserved (do not change).
500MHZ*	 (default)	Reserved (do not change).

* The correct microprocessor speed is automatically detected and set by the system. Do not change the settings of these jumpers.

The system can operate with a microprocessor speed up to 600 megahertz (MHz).

NOTE: For the full name of an abbreviation or acronym used in this table, see the Glossary in your online System User's Guide.

 jumpered  unjumpered

System Board and Riser Board Labels

[Table 2](#) lists the labels for connectors and sockets on your system board and riser board, and it gives a brief description of their functions.

Table 2. System Board and Riser Board Connectors and Sockets

Connector or Socket	Description
AMC	ATI multimedia channel
BATTERY	Battery socket
CD_IN	CD-ROM audio interface connector
DIMM_x	DIMM socket
DSKT	Diskette/tape drive interface connector
ENET	NIC connector (optional)
FAN	Microprocessor fan connector
HDLED	Hard-disk drive LED connector (on riser board)
IDE _n	EIDE interface connector
INTRUSION	Chassis intrusion switch connector
ISAn*	ISA expansion-card connector (on riser board)
KYBD	Keyboard connector
LINE-IN	Audio line-in jack
LINE-OUT	Audio line-out jack (amplified source)
MIC	Microphone jack
MONITOR	Video connector
MOUSE	Mouse connector
P1	Wakeup On LAN power connector (on riser board)
PANEL	Control panel connector
PARALLEL	Parallel port connector; sometimes referred to as <i>LPT1</i>
PCIn*	PCI expansion-card connector (on riser board)
POWER_1	Main power input connector
POWER_2	3.3-V power input connector
RISER	Riser board connector

SERIAL n	Serial port connectors
SLOT1	Pentium® II processor SEC cartridge connector
TAPI	Telephony connector
USB	USB connectors
VIDEO_UPGRADE	Video-memory upgrade socket

* For information on ISA and PCI connectors, see "[Expansion Cards](#)."

NOTE: For the full name of an abbreviation or acronym used in this table, see the Glossary in your online System User's Guide.

Removing and Replacing the Expansion-Card Cage

Your Dell computer has a removable expansion-card cage, which greatly simplifies many installation procedures by allowing you to remove the riser board and all installed expansion cards in a single step.

Removing the Expansion-Card Cage

Use the following procedure to remove the expansion-card cage.

! **CAUTION:** Before you remove the computer cover, see "[Safety First — For You and Your Computer](#)."

1. Remove the computer cover as instructed in "[Removing the Computer Cover](#)."
2. Check any cables connected to expansion cards through the back-panel openings. Disconnect any cables that will not reach to where the cage must be placed upon removal from the chassis.
3. Locate the securing lever (see Figure 7). Rotate the lever upward until it stops in an upright position.

Figure 7. Removing the Expansion-Card Cage

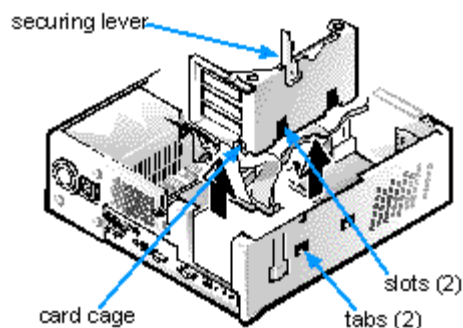

4. Slide the expansion-card cage out of the chassis.
5. Lift the expansion-card cage up and away from the chassis.

Replacing the Expansion-Card Cage

Use the following procedure to replace the expansion-card cage:

1. With the securing lever in the upright position, align the slots in the left side of the expansion-card cage with the tabs on the left side of the chassis (see [Figure 7](#)).
2. Rotate the securing lever downward until it is flush with the top of the chassis. Make sure that the riser board is fully seated in the RISER connector on the system board.
3. Reconnect any cables you removed in step 2 of "[Removing the Expansion-Card Cage](#)."
4. [Replace the computer cover](#), and reconnect your computer and peripherals to their electrical outlets and turn them on.



NOTE: If Enabled, the [Chassis Intrusion](#) option will cause the following message to be displayed at the next system start-up:

ALERT! Cover was previously removed.

[Back to Contents Page](#)

[Back to Contents Page](#)

Installing System Board Options: Dell™ OptiPlex™ GX1 Low-Profile Managed PC Systems

[Overview](#)[Expansion Cards](#)[Adding Memory](#)[Adding Video Memory](#)[Upgrading the Microprocessor](#)[Replacing the System Battery](#)

Overview

This section describes how to install the following options:

- [Industry-Standard Architecture \(ISA\) and Peripheral Component Interconnect \(PCI\) expansion cards](#)
- [System memory](#)
- [Video memory](#)
- [Microprocessor](#)

This section also includes instructions for replacing the [system battery](#), if necessary.

Use Figure 1 to locate the system board features.

Figure 1. System Board Features

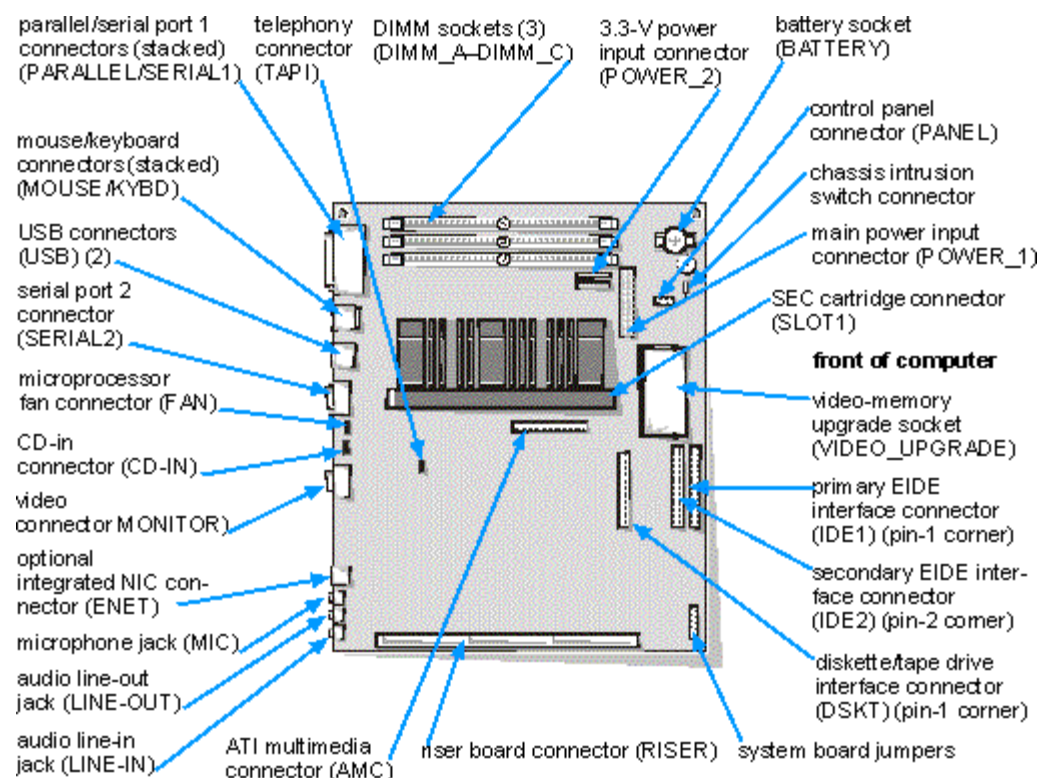

Expansion Cards

Expansion cards are installed on the computer's riser board (see [Figure 3](#)). The riser board plugs into the RISER connector on the system board (see [Figure 1](#)) and is considered an extension of the system board.

The system accommodates up to three expansion cards, which can be a mix of 32-bit PCI expansion cards, and 8- and 16-bit ISA expansion cards. (See [Figure 2](#) for examples of ISA and PCI expansion cards.)

Figure 2. Expansion Cards

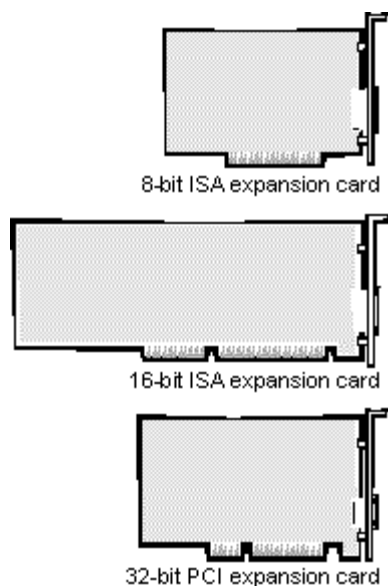

Expansion Slots

Four expansion-card connectors reside on the riser board (see [Figure 3](#)). Because two expansion slots are shared, a maximum of three expansion cards can be installed on the riser board.

- Expansion-card connectors ISA1–ISA2 support 8- or 16-bit ISA expansion cards.
- Expansion-card connectors PCI1–PCI2 support 32-bit PCI expansion cards.

 **NOTES:** On shared expansion slots, only one card of either type can be installed in the common slot.

An expansion-card installed in connector PCI1 cannot exceed 8.75 inches in length.

Figure 3. Riser-Board Expansion-Card Connectors

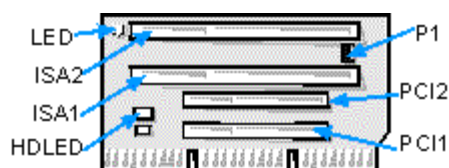

Installing an Expansion Card



CAUTION: To avoid the possibility of electric shock, turn off the computer and any peripherals,

disconnect them from their electrical outlets, and then wait at least 5 seconds before you remove the computer cover. Also, before you install an expansion card, see "[Safety First — For You and Your Computer.](#)"

Follow this procedure to install an expansion card:

1. If you are installing a non-Plug and Play ISA expansion card, enter the ISA Configuration Utility (ICU) and add the new expansion card to your configuration.

See "[Using the ISA Configuration Utility](#)" for instructions.



NOTE: *If you install a PCI or Plug and Play expansion card, your system automatically performs any required configuration tasks during the boot routine.*

2. Prepare the expansion card for installation, and remove the computer cover according to the instructions in "[Removing the Computer Cover.](#)"

See the documentation that came with the expansion card for information on configuring the card, making internal connections, or otherwise customizing the card for your system.



CAUTION: **Some network cards automatically start up the system when they are connected. To guard against electrical shock, be sure to unplug your computer from its electrical outlet before you install any expansion cards.**

3. Remove the expansion-card cage as instructed in "[Removing the Expansion-Card Cage.](#)"
4. Unscrew and remove the metal filler bracket that covers the card-slot opening for the expansion slot you intend to use (see Figure 4).

Save the screw to use when installing the expansion card later in this procedure.

Figure 4. Removing the Filler Bracket

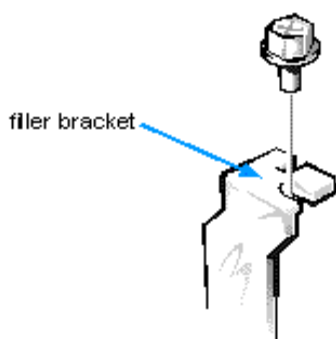

5. Install the expansion card.

Insert the card-edge connector firmly into the expansion-card connector on the riser board. Gently rock the card into the connector until the card is fully seated (see Figure 5).

Figure 5. Installing an Expansion Card

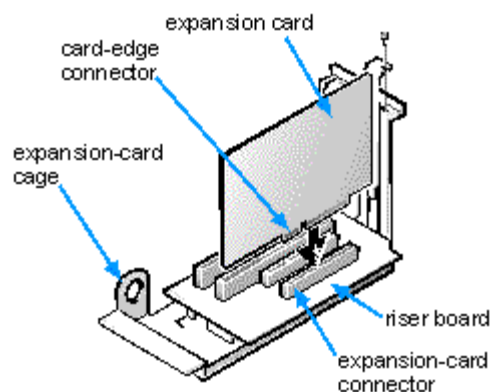

6. When the card is firmly seated in the connector and the card-mounting bracket is flush with the brackets on either side of it, secure the bracket with the screw you removed in step 4.
7. If you are installing an optional Wakeup On LAN network card, attach the three-wire power cable that came with the card to the P1 connector on the riser board (see [Figure 3](#)) and to the network interface controller (NIC) card.
8. Replace the expansion-card cage in the chassis as instructed in "[Replacing the Expansion-Card Cage](#)."
9. Connect any cables that should be attached to the card.

See the documentation that came with the card for information about its cable connections.
10. [Replace the computer cover](#), and reconnect your computer and peripherals to their electrical outlets and turn them on.



NOTE: If Enabled, the [Chassis Intrusion](#) option will cause the following message to be displayed at the next system start-up:

```
ALERT! Cover was previously removed.
```

Removing an Expansion Card



CAUTION: To avoid the possibility of electric shock, turn off the computer and any peripherals, disconnect them from their electrical outlets, and then wait at least 5 seconds before you remove the computer cover. Also, before you install an expansion card, see "[Safety First — For You and Your Computer](#)."

Follow this procedure to remove an expansion card:

1. If you are removing a non-Plug and Play ISA expansion card, enter the ICU and remove the expansion card from your configuration.

See "[Using the ISA Configuration Utility](#)" for instructions.

2. Remove the computer cover according to the instructions in "[Removing the Computer Cover](#)."
3. If necessary, disconnect any cables connected to the card.
4. Remove the expansion-card cage as instructed in "[Removing the Expansion-Card Cage](#)."

5. Unscrew the mounting bracket of the card you want to remove.
6. Grasp the card by its outside corners, and ease it out of its connector.
7. If you are removing the card permanently, install a metal filler bracket over the empty card-slot opening.



NOTE: Installing filler brackets over empty card-slot openings is necessary to maintain Federal Communications Commission (FCC) certification of the system. The brackets also keep dust and dirt out of your computer.

8. Replace the expansion-card cage in the chassis as instructed in "[Replacing the Expansion-Card Cage](#)."
9. [Replace the computer cover](#), and reconnect your computer and peripherals to their electrical outlets and turn them on.



NOTE: If Enabled, the [Chassis Intrusion](#) option will cause the following message to be displayed at the next system start-up:

```
ALERT! Cover was previously removed.
```

Adding Memory

Memory can be increased to a maximum of 768 megabytes (MB) by installing combinations of 32-, 64-, 128-, or 256-MB dual in-line memory modules (DIMMs) in the three DIMM sockets on the system board. [Figure 6](#) shows the DIMMs and DIMM sockets.

Your system can support both error checking and correction (ECC) and nonparity synchronous dynamic random-access memory (SDRAM) DIMMs. However, ECC support is available only if all DIMMs are ECC DIMMs. ECC DIMMs enable your system to correct all single-bit memory errors and detect multibit memory errors.

When you add system memory, you may install DIMMs in any socket. For optimum operation, Dell recommends that you install a DIMM in socket A first (closest to the processor) before installing a DIMM in another socket.

Figure 6. DIMMs and DIMM Sockets

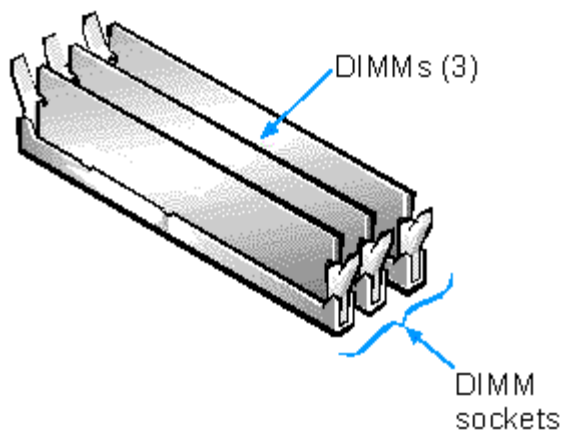

[Table 1](#) lists sample memory configurations and shows valid DIMM combinations and socket placements for each configuration.

Table 1. Sample DIMM Configuration Options

Total Desired Memory	DIMM Socket		
	A	B	C
32 MB	32 MB		
64 MB	64 MB		
64 MB	32 MB	32 MB	
96 MB	32 MB	32 MB	32 MB
128 MB	64 MB	64 MB	
128 MB	128 MB		
160 MB	128 MB	32 MB	
192 MB	128 MB	64 MB	
192 MB	128 MB	32 MB	32 MB
256 MB	128 MB	128 MB	
320 MB	128 MB	128 MB	64 MB
384 MB	128 MB	128 MB	128 MB
512 MB	256 MB	256 MB	
768 MB	256 MB	256 MB	256 MB

Performing a Memory Upgrade



CAUTION: To avoid the possibility of electric shock, turn off the computer and any peripherals, disconnect them from their electrical outlets, and then wait at least 5 seconds before you remove the computer cover. Also, before you install an expansion card, see "[Safety First — For You and Your Computer.](#)"

Follow this procedure to perform a memory upgrade:

1. Remove the computer cover according to the instructions in "[Removing the Computer Cover](#)."
2. Determine the DIMM sockets into which you will install DIMMs or replace existing DIMMs.

See [Figure 1](#) and [Table 1](#).

3. Install or replace DIMMs as necessary to reach the desired memory total.

Follow the instructions in "[Installing a DIMM](#)" or "[Removing a DIMM](#)," as appropriate.

4. [Replace the computer cover](#), and reconnect your computer and peripherals to their electrical outlets and turn them on.



NOTE: If Enabled, the [Chassis Intrusion](#) option will cause the following message to be displayed at the next system start-up:

```
ALERT! Cover was previously removed.
```

The system detects that the new memory does not match the existing system configuration information and generates the following message:

```
The amount of system memory has changed.
Strike the F1 key to continue, F2 to run the setup utility
```

5. Press <F2> to enter the [System Setup program](#) and check the System Memory under [System Data Options](#).

The system should have already changed the value of System Memory to reflect the newly installed memory modules. Verify the new total. If it is correct, skip to step 7.

6. If the memory total is incorrect, turn off and disconnect your computer and peripherals from their electrical outlets. Remove the computer cover, and check the installed DIMMs to make sure that they are seated properly in their sockets. Then repeat steps 4 and 5.
7. When the System Memory total is correct, press the <Esc> key to exit the System Setup program.
8. Run the Dell Diagnostics to verify that the DIMMs are operating properly.

See your *Diagnostics and Troubleshooting Guide* for information on running the Dell Diagnostics and troubleshooting any problems that may occur.

Installing a DIMM

Use the following procedure to install a DIMM:

1. Locate the first empty socket in which you plan to install a DIMM.

For optimum performance, DIMMs should be installed in consecutive sockets beginning with socket A.

2. Locate the plastic securing clips at each end of the socket. Press the clips outward until they snap open.
3. Orient the DIMM to the socket by aligning the notches in the DIMM's edge connector with the crossbars in the socket.
4. Press the DIMM straight into the slot running down the center of the socket (see Figure 7) until the securing clips snap into place around the ends of the DIMM.

Figure 7. Installing a DIMM

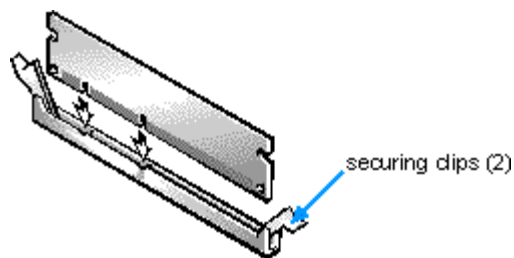

Removing a DIMM

To remove a DIMM, press the securing clips outward (see Figure 8) simultaneously until the DIMM disengages from the socket (it should pop up slightly).

Figure 8. Removing a DIMM

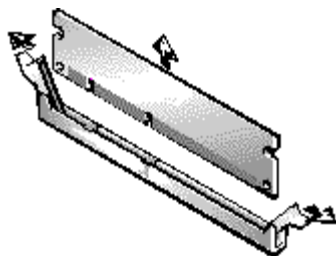

Adding Video Memory

You can upgrade video memory from 4 to 8 MB by installing a video-memory upgrade module. Upgrading the video memory increases video performance and allows you to use video modes for application programs that require high resolutions and many colors.



CAUTION: To avoid the possibility of electric shock, turn off the computer and any peripherals, disconnect them from their electrical outlets, and then wait at least 5 seconds before you remove the computer cover. Also, before you install an expansion card, see "[Safety First — For You and Your Computer.](#)"

To upgrade the video memory, perform the following steps:

1. Remove the computer cover according to the instructions in "[Removing the Computer Cover.](#)"
2. Remove the expansion-card cage as described in "[Removing the Expansion-Card Cage.](#)"

3. Locate the video-memory upgrade socket (labeled "VIDEO_UPGRADE") on the system board.

See [Figure 1](#).

4. Orient the module as shown in [Figure 9](#). Then install it in the socket.

Video memory modules are keyed, or designed to fit in the socket in only one direction.

The socket on the system board is notched so that the video memory module can be firmly seated only one way:

- a. Align the video memory module's edge connector with the slot in the center of the socket.
- b. Press the video memory module's edge connector firmly into the socket.
- c. Pivot the module down until it clicks into place.
- d. If you do not hear a sharp click, you should remove the module and reinstall it.

Figure 9. Installing a Video-Memory Upgrade Module

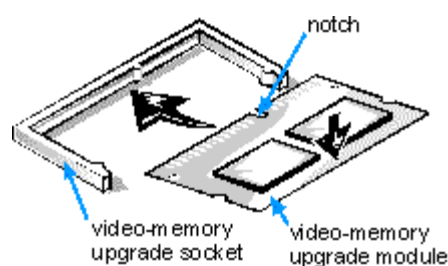

5. Replace the expansion-card cage as described in "[Replacing the Expansion-Card Cage](#)."
6. [Replace the computer cover](#), and reconnect your computer and peripherals to their electrical outlets and turn them on.



NOTE: If Enabled, the [Chassis Intrusion](#) option will cause the following message to be displayed at the next system start-up:

`ALERT! Cover was previously removed.`

7. Enter the [System Setup program](#) and check the Video Memory under [System Data Options](#).
8. If the video memory total is incorrect, turn off and disconnect your computer and peripherals from their electrical outlets. Remove the computer cover, and check the video memory upgrade to make sure that it is seated properly in its socket. Then repeat steps 6 and 7.
9. Run the Video Test Group in the Dell Diagnostics to test the new video memory.

See your *Diagnostics and Troubleshooting Guide* for information on running the Dell Diagnostics and troubleshooting any problems that may occur.

Upgrading the Microprocessor

To take advantage of future options in speed and functionality, you can replace the microprocessor on your system board with any Dell-supported microprocessor upgrade. Call your Dell sales representative for information on available microprocessor upgrades.

The microprocessor upgrade kit includes a new single-edge contact (SEC) cartridge with heat sink assembly.

 **CAUTION:** Before you remove the computer cover, see "[Safety First — For You and Your Computer.](#)"

The following procedure describes how to replace the microprocessor.

 *NOTE:* Dell recommends that only a technically knowledgeable person perform this procedure.

1. Remove the computer cover according to the instructions in "[Removing the Computer Cover.](#)"

 **CAUTION:** The SEC cartridge and heat sink can get extremely hot during system operation. Be sure the assembly has had sufficient time to cool before you touch it.

2. Locate the SEC cartridge connector (labeled "SLOT1") and the microprocessor fan connector (labeled "FAN") on the system board.

See [Figure 1](#).

3. Disconnect the microprocessor fan cable from the connector on the system board.
4. Remove the SEC cartridge/heat sink assembly from the system board connector (see [Figure 10](#)).

Press outward and hold the guide-bracket assembly latches, grasp the SEC cartridge/heat sink assembly firmly, and pull away from the connector on the system board. Lift the SEC cartridge/heat sink assembly from the guide bracket assembly.



 *NOTE:* You must use up to 15 pounds of force to disengage the SEC cartridge from the connector.

Figure 10. Removing the Microprocessor

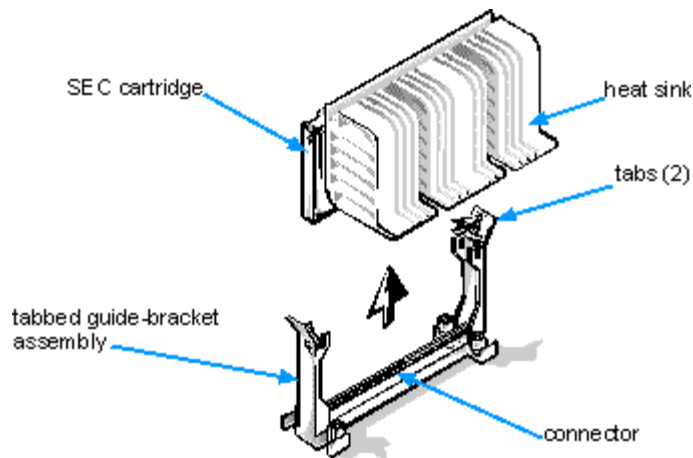

5. Insert the new SEC cartridge/heat sink assembly into the system board connector.

Orient the SEC cartridge/heat sink assembly with the heat sink facing the right (as you face the front of the chassis). Align the sides of the heat sink with the guide brackets and press the SEC firmly into its connector until it is fully seated. The guide brackets will snap into place, securing the SEC cartridge in the connector on the system board.

 **NOTE:** You must use up to 25 pounds of force to fully engage the SEC cartridge in the connector.

6. Connect the microprocessor fan cable to the connector on the system board.
7. [Replace the computer cover](#), and reconnect your computer and peripherals to their electrical outlets and turn them on.

 **NOTE:** If Enabled, the [Chassis Intrusion](#) option will cause the following message to be displayed at the next system start-up:

ALERT! Cover was previously removed.

8. Enter the [System Setup program](#) and confirm that the installed microprocessor is correctly identified.

As the system boots, it detects the new microprocessor and automatically changes the system configuration information in the System Setup program.

9. Run the Dell Diagnostics to verify that the new microprocessor is operating correctly.

See your *Diagnostics and Troubleshooting Guide* for information on running the Dell Diagnostics and troubleshooting any problems that may occur.

Replacing the System Battery

A 3.0-volt (V) CR2032 coin-cell battery installed on the system board maintains system configuration, date, and time information in a special section of memory.

The operating life of the battery can extend up to ten years. The battery may need replacing if an incorrect time or date is displayed during the boot routine along with a message such as:

Time-of-day not set - please run SETUP program

or

Invalid configuration information - please run SETUP program

or

Strike the F1 key to continue, F2 to run the setup utility

To determine whether the battery needs replacing, reenter the time and date through the System Setup program (not through the MS-DOS® time and date commands) and exit the program properly to save the information (see "[Using the System Setup Program](#)" for instructions). Turn off your system and disconnect it from AC power for a few hours; then reconnect and turn on your system. Enter the System Setup program. If the date and time are not correct in the System Setup program, replace your battery.

You can operate your system without a battery; however, without a battery, the system configuration information is erased if the system is turned off or unplugged from AC power. In this case, you must enter the System Setup program and reset the configuration options.

 **CAUTION:** There is a danger of the new battery exploding if it is incorrectly installed. Replace the battery only with the same or equivalent type recommended by the manufacturer. Discard used batteries according to the manufacturer's instructions.

 **CAUTION:** Before you remove the computer cover, see "[Safety First — For You and Your Computer](#)."

Use the following procedure to replace the system battery with another CR2032 coin-cell battery:

1. If you have not already done so, make a copy of your system configuration information in the System Setup program.

If the settings are lost while you are replacing the battery, refer to your written or printed copy of the system configuration information to restore the correct settings. See "[Using the System Setup Program](#)" for instructions.

2. Remove the computer cover according to the instructions in "[Removing the Computer Cover](#)."
3. To access the battery on the system board, remove the expansion-card cage as described in "[Removing the Expansion-Card Cage](#)."

NOTICE: If you pry the battery out of its socket with a blunt object, be careful not to touch the system board with the object. Make certain that the object is inserted between the battery and the socket before attempting to pry out the battery. Otherwise, you may damage the system board by prying off the socket or by breaking circuit traces on the system board.

4. Locate the battery and remove it.

The battery (see [Figure 1](#)) is mounted in a socket labeled "BATTERY," in the front-right corner of the system board (as you face the front of the system).

Pry the battery out of its socket with your fingers or with a blunt, nonconductive object, such as a plastic

screwdriver.

5. Install the new battery.

Orient the battery with the side labeled "+" facing up (see Figure 11). Then insert the battery into the socket, and snap it into place.

Figure 11. System Battery and Battery Socket

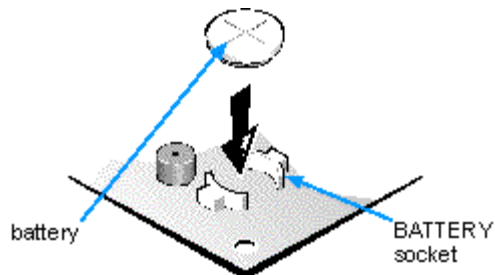

6. Replace the expansion-card cage as described in "[Replacing the Expansion-Card Cage.](#)"
7. [Replace the computer cover](#), and reconnect your computer and peripherals to their electrical outlets and turn them on.



NOTE: If Enabled, the [Chassis Intrusion](#) option will cause the following message to be displayed at the next system start-up:

ALERT! Cover was previously removed.

8. Enter the [System Setup program](#) and confirm that the battery is operating properly.
9. Enter the correct time and date through the System Setup program's Time and Date categories. Also, use the copy you made in step 1 to restore the correct settings for other system configuration information. Then exit the System Setup program.
10. Turn off your computer, and unplug it for at least 10 minutes.
11. After 10 minutes, plug in the computer, turn it on, and enter the System Setup program. If the time and date are still incorrect, see the chapter titled "Getting Help" in your *Diagnostics and Troubleshooting Guide* for instructions on obtaining technical assistance.

[Back to Contents Page](#)

[Back to Contents Page](#)

Installing Drives: Dell™ OptiPlex™ GX1 Low-Profile Managed PC Systems

- [Overview](#)
 - [Installing a Drive in the 5.25-Inch Drive Bay](#)
 - [Removing and Replacing Front-Panel Inserts](#)
 - [Installing an EIDE Hard-Disk Drive](#)
 - [Connecting Drives](#)
 - [Installing SCSI Devices](#)
-

Overview

Your Dell computer has three drive bays for installing the following types of drives (see [Figure 1](#))

- The externally accessible drive bays at the front of the computer consist of one 3.5-inch drive bay (dedicated to a 3.5-inch diskette drive) and one 5.25-inch bay that can hold one half-height, 5.25-inch device—typically a tape drive or CD-ROM drive. Alternately, a 3.5-inch device can be installed in the 5.25-inch bay using adapters available from Dell.
- The hard-disk drive bay (located to the left of the externally accessible drive bays) can hold a 3.5-inch enhanced integrated drive electronics (EIDE) or small computer system interface (SCSI) hard-disk drive.

The next two subsections contain information that you will need in several of the installation procedures described later in this section. The remaining subsections cover each type of drive installation.

 **NOTE:** In all of the following procedures, **left** and **right** refer to your left and right as you face the **front** of the computer.

Figure 1. Drive Locations



Removing and Replacing Front-Panel Inserts

Empty drive bays contain a front-panel insert to protect the inside of the computer from dust particles and ensure proper airflow within the computer. Before you install a drive in an empty drive bay, you must first remove the front-panel insert.

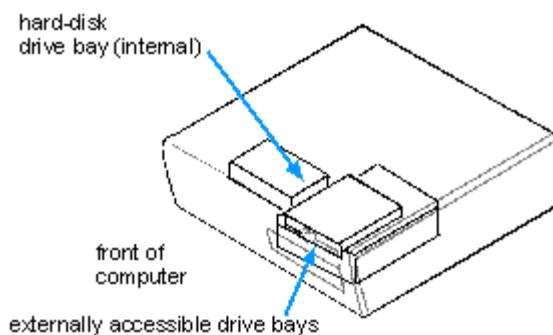
To remove the insert covering a 5.25-inch bay, follow these steps:

⚠ CAUTION: Before you remove the computer cover, see "[Safety First — For You and Your Computer.](#)"

1. Turn off the system, including any attached peripherals, and disconnect all the AC power cables from their power sources.
2. Remove the computer cover as instructed in "[Removing the Computer Cover.](#)"
3. Lay the computer cover upside down on a flat work surface, with the front of the cover facing toward you.
4. With your thumbs, press in each end of the insert until it snaps free of the cover (see Figure 2).

Figure 2. Removing the Front-Panel Insert for a 5.25-Inch Bay

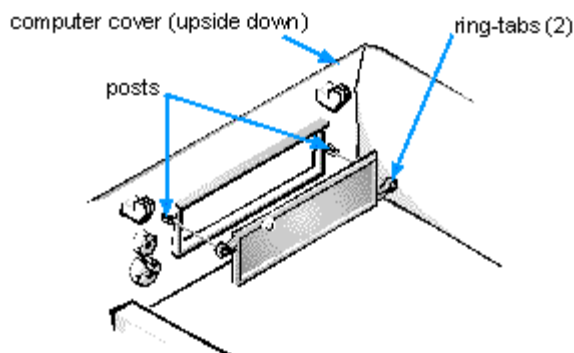

To replace a front-panel insert for a 5.25-inch bay, work from inside the cover. Position the insert behind the bay opening, insert the two ring-tabs (one on each end of the insert) over the posts on the inside of the opening, and firmly press both ends of the insert into place (see Figure 2).

To remove the insert covering the 3.5-inch bay, follow these steps:

1. Complete steps 1 and 2 of the procedure for removing a 5.25-inch insert.
2. Inside the cover, locate the eject button mechanism for the 3.5-inch bay (see Figure 3). Press the mechanism toward the front panel to snap the plastic insert out of its opening.

Figure 3. Removing the Front-Panel Insert for the 3.5-Inch Bay

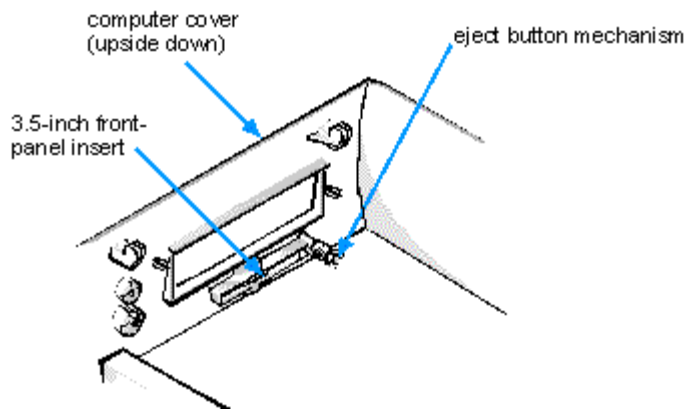

To replace the front-panel insert for the 3.5-inch bay, work from outside the cover. Place the insert in position, and press it into the opening.

Connecting Drives

When installing a drive, you connect two cables—a DC power cable and an interface cable—to the back of the drive. Your drive's power input connector (to which you connect the DC power cable) resembles the connector shown in Figure 4.

Figure 4. DC Power Cable Connector

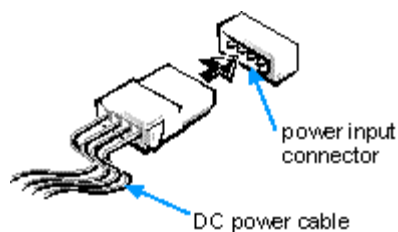

The drive's interface connector is a card-edge connector or a header connector, as shown in Figure 5.

Figure 5. Drive Interface Connectors

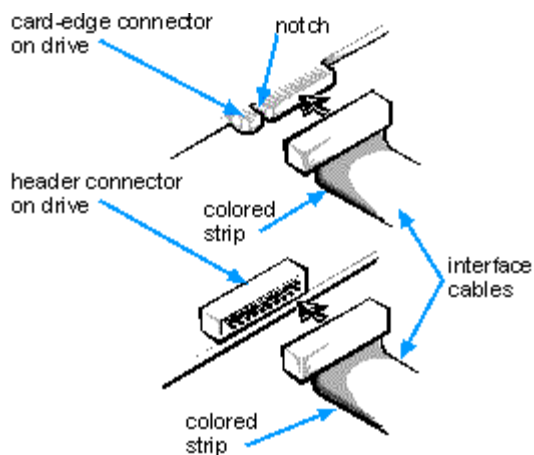

When attaching the interface cable to a drive, be sure to match the colored strip on the cable to pin 1 of the drive's interface connector. For the location of pin 1 on the drive's interface connector, see the documentation that came with the drive.

When disconnecting an interface cable from the system board, be sure to press in on the locking tabs on the cable connector before disconnecting the cable. When attaching an interface cable to the system board, be sure that the locking tabs snap into place, ensuring that the cable is firmly attached to the connector on the system board.

NOTICE: When connecting an interface cable, do not reverse the interface cable (do not place the colored strip away from pin 1 of the connector). Reversing the cable prevents the drive from operating and could damage the controller, the drive, or both.

Most interface connectors are keyed for correct insertion; that is, a notch or a missing pin on one connector matches a tab or a filled-in hole on the other connector (see [Figure 5](#)). Keying ensures that the pin-1 wire in the cable (indicated by the colored strip along one edge of the cable) goes to the pin-1 end of the connector.

The pin-1 end of a card-edge connector is usually identified by a notch cut about a quarter of an inch from the end of the connector, as shown in [Figure 5](#). A header connector is usually keyed by the omission of one of its pins (see [Figure 5](#)), with the corresponding hole filled in on the connector cable.

The pin-1 end of a connector on a board or a card is usually indicated by a silk-screened "1" printed directly on the board or card.

Installing a Drive in the 5.25-Inch Drive Bay

The 5.25-inch drive bays can accommodate any of the following types of drives:

- A diskette drive or tape drive that uses the diskette/tape drive interface on the system board
- A CD-ROM or tape drive that uses an EIDE interface on the system board
- A CD-ROM or tape drive that uses its own controller card



NOTE: For information on configuring, connecting, and installing SCSI drives, see "[Installing SCSI Devices](#)."



CAUTION: To avoid the possibility of electric shock, turn off the computer and any peripherals, disconnect them from their electrical outlets, and then wait at least 5 seconds before you remove the computer cover. Also, before you install an expansion card, see "[Safety First — For You and Your Computer](#)."

To install a drive in a 5.25-inch drive bay, follow these steps.

NOTICE: When you unpack the drive, do not set it on a hard surface, which may damage the drive. Instead, set the drive on a surface, such as a foam pad, that will sufficiently cushion it.

1. Unpack the drive and prepare it for installation.

Check the documentation that accompanied the drive to verify that the drive is configured for your computer system. Change any settings necessary for your configuration.



NOTE: If you are installing a non-EIDE tape drive, check the documentation for the drive to determine the jumper or switch settings used to designate the drive as drive address DS4 (not DS2 or DS3 as may be indicated in the drive documentation). Unless the drive is already set to drive 4, reconfigure its jumper or switch setting (see "[Jumpers](#).")

If you are installing an EIDE CD-ROM or EIDE tape drive, configure the drive for the Cable Select setting.

2. Remove the computer cover as instructed in "[Removing the Computer Cover](#)."
3. Remove the 3.5-inch diskette drive/bracket assembly.

Press outward on the two tabs on the left side of the drive bay to disengage the bracket from the chassis (see Figure 6). Then rotate the bracket upward, and remove it from the chassis.

Figure 6. Removing the 3.5-Inch Diskette Drive/Bracket Assembly

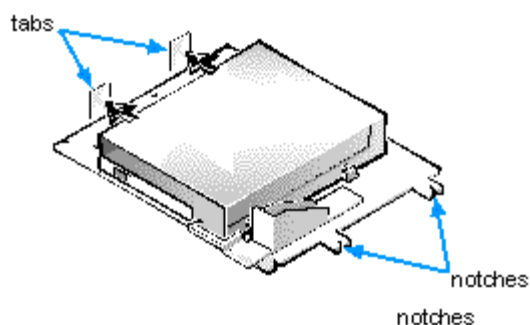

4. Lift the 5.25-inch drive bracket straight up and out of the chassis (see [Figure 7](#)).

If a drive is already installed in the bay and you are replacing it, be sure to disconnect the DC power cable and interface cable from the back of the drive before removing the drive/bracket assembly. To remove the old drive from the bracket, turn the drive/bracket assembly upside down and unscrew the four screws that secure the drive to the bracket (see Figure 7).

Figure 7. Removing the 5.25-Inch Diskette Drive/Bracket

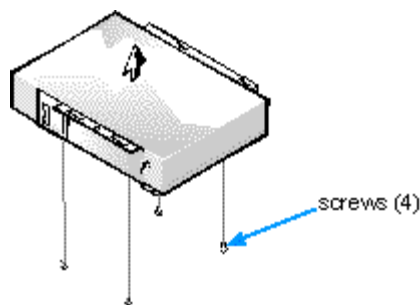

5. Attach the bracket to the new drive.

Turn the drive upside down, and locate the four screw holes around its perimeter. Fit the bracket over the drive so that the notched end aligns with the front of the drive.

Use the score marks on the drive bracket to help align the screw holes on the drive with the screw holes on the bracket (see Figure 8).

Figure 8. Installing the 5.25-Inch Diskette Drive Bracket

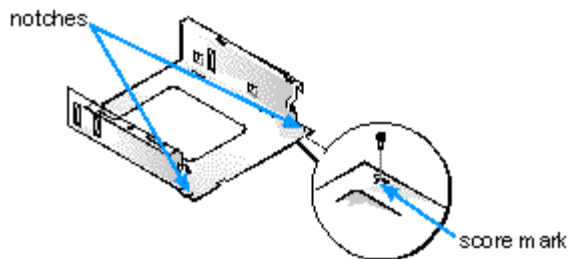

To further ensure proper positioning of the drive in the chassis, insert and tighten all four screws in the order in which the holes are numbered (the holes are marked "1" through "4").

6. Reinstall the 5.25-inch drive/bracket assembly in the chassis.

Align the notches on the front of the drive bracket (see [Figure 8](#)) with the front of the computer. Hold the bracket level, and lower the assembly straight down into place (see Figure 9).

Figure 9. Inserting the Drive into the Drive Bay

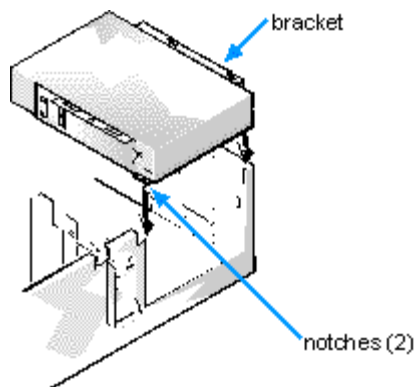

7. If you are installing a drive that has its own controller card, install the controller card in an expansion slot.

See "[Installing an Expansion Card.](#)"

8. Connect a DC power cable to the power input connector on the back of the drive (see [Figure 10](#)).

NOTICE: You must match the colored strip on the cable with pin 1 on the drive's interface connector to avoid possible damage to your system.

9. Connect the appropriate interface cable to the interface connector on the back of the drive (see [Figure 10](#)).

If your system came with an EIDE CD-ROM or tape drive, use the spare connector on the existing interface cable. Otherwise, use the EIDE interface cable provided in the drive kit.

Figure 10. Attaching Cables to a Drive in the 5.25-Inch Drive Bay

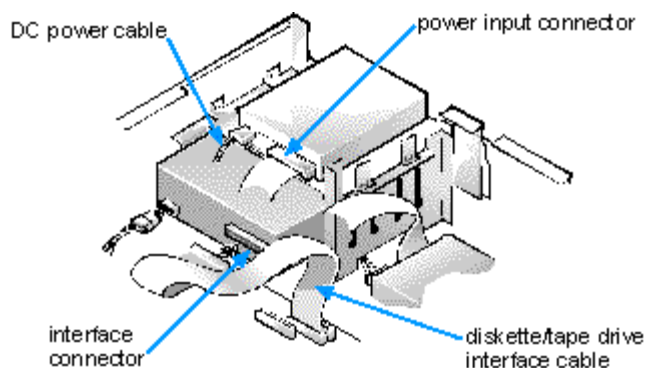

10. For an EIDE tape drive or CD-ROM drive, connect the other end of the interface cable to the interface connector labeled "IDE2" on the system board.

For a diskette drive or non-EIDE tape drive, connect the cable from the drive to the interface connector labeled "DSKT" on the system board.

For a drive that comes with its own controller card, connect the other end of the interface cable to the controller card.

Check all cable connections. Fold cables out of the way to provide airflow for the fan and cooling vents.

11. If the 5.25-inch drive bay was previously empty, remove the front-panel insert from the computer cover.

See "[Removing and Replacing Front-Panel Inserts](#)."

12. [Replace the computer cover](#).

If the bezel on your drive is not flush with the bezel on your computer, remove the drive and adjust the position of the drive on the bracket, making sure to insert and tighten the screws in the order marked. Replace the drive in the drive bay, and then replace the computer cover.

13. Reconnect your computer and peripherals to an electrical outlet and turn them on.



NOTE: If Enabled, the [Chassis Intrusion](#) option will cause the following message to be displayed at the next system start-up:

```
ALERT! Cover was previously removed.
```

14. Enter the [System Setup program](#) and update your system configuration information.

For a diskette drive, update the appropriate Diskette Drive option (A or B) on Page 1 of the System Setup screens to reflect the size and capacity of your new diskette drive.

If you installed a non-EIDE tape drive as the second drive, set the Diskette Drive B option to Not

Installed.

For EIDE CD-ROM and tape drives, set the appropriate Drive option (0 or 1) under Drives: Secondary to Auto.

15. Run the Dell Diagnostics to verify that your system works correctly.

See your *Diagnostics and Troubleshooting Guide* for information on running the Dell Diagnostics and troubleshooting any problems that may occur. Use the following guidelines to determine which test to use:

- If you installed a diskette drive, test it by running all of the subtests in the Diskette Drive(s) Test Group of the Dell Diagnostics.
- If you installed a CD-ROM drive, see the documentation that came with the drive for instructions on loading device drivers and using the drive. If it is an EIDE CD-ROM drive, test it by running all of the subtests in the IDE CD-ROM Drives Test Group of the Dell Diagnostics.
- If you installed a tape drive, first verify that your diskette drive is still operating correctly by running all of the subtests in the Diskette Drive(s) Test Group of the Dell Diagnostics. Then perform a tape backup and verification test with the drive as instructed in the tape-drive software documentation that came with the tape drive.



NOTE: *The tape drives sold by Dell come with their own operating software and documentation. After you install a tape drive, refer to the documentation that came with the drive for instructions on installing and using the tape drive software.*

Installing an EIDE Hard-Disk Drive

This section includes information on installing, partitioning, and formatting EIDE hard-disk drives. An EIDE drive (which must be 1-inch high or less) can be installed in the hard-disk drive bracket in the left front corner of the chassis. For instructions on installing, partitioning, and formatting SCSI hard-disk drives, see "[Installing SCSI Devices](#)."

EIDE Drive Addressing

All EIDE devices should be configured for the Cable Select jumper position, which assigns master and slave status to devices by their position on the interface cable. When two EIDE devices are connected to a single EIDE cable and are configured for the Cable Select jumper position, the device attached to the last connector on the interface cable is the master, or boot, device (drive 0) and the device attached to the middle connector on the interface cable is the slave device (drive 1). Refer to the drive documentation in your upgrade kit for information on setting devices to the Cable Select jumper position.



NOTE: *If you want to install a second EIDE drive that is a different type from the first drive but you do not have the specifications for the first drive, do one of the following:*

- *If you purchased the drive from Dell, you can contact Dell for the necessary reconfiguration information. (See the chapter titled "Getting Help" in the *Diagnostics and Troubleshooting Guide* for instructions on obtaining technical assistance.)*
- *If you did not purchase the drive from Dell, call the drive manufacturer.*

With the two EIDE interface connectors on the system board, your system can support up to four EIDE devices. EIDE hard-disk drives should be connected to the EIDE interface connector labeled "IDE1." (EIDE tape drives and CD-ROM drives should be connected to the EIDE interface connector labeled "IDE2.")

Installing an EIDE Hard-Disk Drive in the Hard-Disk Drive Bracket



CAUTION: To avoid the possibility of electric shock, turn off the computer and any peripherals, disconnect them from their electrical outlets, and then wait at least 5 seconds before you remove the computer cover. Also, before you install an expansion card, see "[Safety First — For You and Your Computer.](#)"

Install an EIDE hard-disk drive in the hard-disk drive bracket as follows:

1. If you are replacing a hard-disk drive that contains data you want to keep, be sure to make a backup of your files before you begin this procedure.

NOTICE: When you unpack the drive, do not set it on a hard surface, which may damage the drive. Instead, set the drive on a surface, such as a foam pad, that will sufficiently cushion it.

2. Unpack the drive and prepare it for installation.

Check the documentation that accompanied the drive to verify that the drive is configured for your computer system. Change any settings necessary for your configuration.



NOTE: If you are installing a non-EIDE tape drive, check the documentation for the drive to determine the jumper or switch settings used to designate the drive as drive address DS4 (not DS2 or DS3 as may be indicated in the drive documentation). Unless the drive is already set to drive 4, reconfigure its jumper or switch setting (see "[Jumpers.](#)")

If you are installing an EIDE CD-ROM or EIDE tape drive, configure the drive for the Cable Select setting.

3. Remove the computer cover as instructed in "[Removing the Computer Cover.](#)"
4. Remove the expansion-card cage as instructed in "[Removing and Replacing the Expansion-Card Cage.](#)"
5. Remove the hard-disk drive bracket from the chassis.

If a hard-disk drive is already installed on the drive bracket and you are replacing it, disconnect the DC power cable and EIDE cable from the drive. Loosen the captive screw that secures the hard-disk drive bracket to the chassis. Then rotate the bracket upward, and lift it out of the chassis (see Figure 11). Detach the hard-disk drive from the bracket by removing the four screws.

Figure 11. Removing the Hard-Disk Drive Bracket

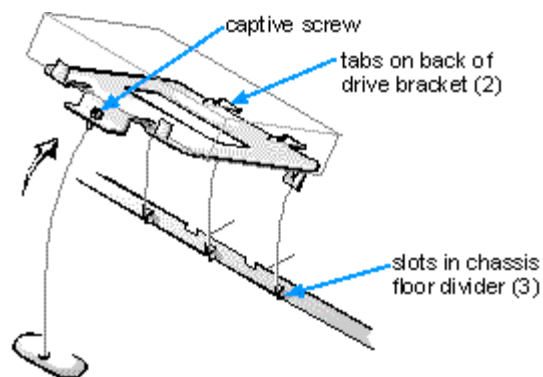

- Secure the drive bracket to the new drive.

Turn the drive upside down, and locate the four screw holes around its perimeter.

Orient the drive bracket so that the end labeled "CONNECTOR" faces the side of the drive containing the interface and power connectors. Place the bracket on the drive, and secure it with four screws (see Figure 12).

Figure 12. Securing the Hard-Disk Drive to the Bracket

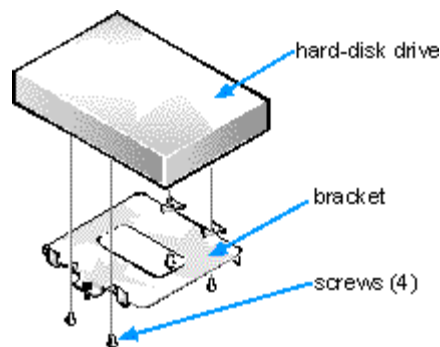

- Reinstall the hard-disk drive/bracket assembly in the chassis.

Grasp the bracket by the tab containing the captive screw, and hold the bracket at a 45-degree angle to the chassis floor. Align the two tabs on the other side of the bracket with the score marks on the chassis floor. Insert the two tabs into the slots in the chassis floor divider, and rotate the assembly downward. Then tighten the captive screw until the bracket is securely fastened to the chassis floor (see [Figure 11](#)).

NOTICE: You must match the colored strip on the EIDE cable with pin 1 on the drive's interface connector to avoid possible damage to your system.

- Connect one end of the EIDE cable to the 40-pin interface connector on the back of the hard-disk drive (see Figure 13).

The cable is keyed so that the colored edge of the EIDE cable lines up with the pin-1 end of the interface connector.

Figure 13. Attaching Hard-Disk Drive Cables

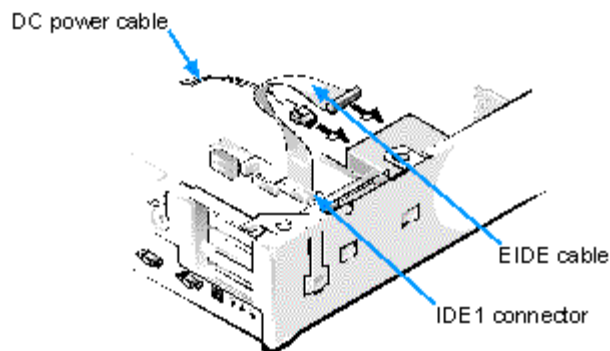

9. If it is not already connected, connect the other end of the EIDE cable to the IDE1 connector on the system board.

NOTICE: You must match the colored strip on the EIDE cable with pin 1 on the system board connector to avoid possible damage to your system.

To locate the system board IDE connector, see "[System Board Features](#)."

10. Connect a DC power cable to the power input connector on the back of the drive (see [Figure 13](#)).
Check all connectors to be certain that they are properly cabled and firmly seated.
11. Replace the expansion-card cage as instructed in "[Replacing the Expansion-Card Cage](#)."
12. [Replace the computer cover](#), and reconnect your computer and peripherals to their power sources.
13. Turn on the peripherals connected to the computer.
14. Start the computer system.



NOTE: If the drive you just installed is the primary drive and no operating system is installed, you must start the computer using a bootable diskette or CD.

- o To boot the system from a diskette, insert a bootable diskette (such as an operating system installation or recovery diskette) into diskette drive A, and turn on the computer.
- o To boot the system from a CD, enter the [System Setup program](#) and set the [Boot Sequence](#) to CD-ROM First. Insert a bootable CD (such as an operating system installation CD or the *Dell ResourceCD*) into CD-ROM drive, and turn on the computer.



NOTE: If Enabled, the [Chassis Intrusion](#) option will cause the following message to be displayed at the next system start-up:

ALERT! Cover was previously removed.

15. Enter the [System Setup program](#) and update the [Drives: Primary and Secondary](#) options.

After you update the System Setup options, reboot the system.

16. Partition and logically format your drive, as described in "[Partitioning and Logically Formatting Your EIDE Hard-Disk Drive](#)," before proceeding to the next step.

17. Run the Hard-Disk Drive(s) Test Group in the Dell Diagnostics to verify that the new hard-disk drive is operating properly.

See your *Diagnostics and Troubleshooting Guide* for information on running the Dell Diagnostics and troubleshooting any problems that may occur.

18. If the drive you just installed is the primary drive, install the operating system on the hard-disk drive.

Refer to the documentation that came with the operating system.

Partitioning and Logically Formatting Your EIDE Hard-Disk Drive

EIDE hard-disk drives must be physically formatted, partitioned, and logically formatted before they can be used to store data. Every hard-disk drive from Dell is physically formatted before it is sent to you.



NOTE: On systems with hard-disk drives larger than 2 gigabytes (GB), create a primary partition of 2 GB and divide the remaining capacity into partitions of 2 GB or less. For example, a system with a 2.5-GB hard-disk drive would have a primary partition of 2 GB (drive C) and a second partition of 500 megabytes (MB) (drive D).

Hard-disk drives must be partitioned this way because MS-DOS®-based operating systems (including Microsoft® Windows NT® when you use a file allocation table [FAT] 16 file system) do not support drive partitions larger than 2 GB.

To partition and logically format your hard-disk drive, use the program(s) offered by your operating system.

For MS-DOS, use the **fdisk** and **format** commands to perform these procedures. The **fdisk** and **format** commands are described in the MS-DOS reference documentation.

NOTICE: If you format your hard-disk drive under the OS/2 High Performance File System (HPFS), you cannot reformat the drive for MS-DOS without losing all HPFS data. See your OS/2 documentation for details.

For OS/2®, see the discussion on partitioning and logical formatting in the documentation that came with the operating system.

NOTICE: If you format your hard-disk drive under the Windows NT File System (NTFS), you cannot reformat the drive for MS-DOS without losing all NTFS data. See your Windows NT documentation for details.

For Windows NT, see the discussion on partitioning and logical formatting in the documentation that came with the operating system.

For the UNIX® operating system, refer to your UNIX documentation.

Installing SCSI Devices

To use SCSI devices in your Dell computer, you must have a SCSI host adapter card, which comes with its own SCSI cable. This cable can be used to attach a variety of SCSI devices (hard-disk drives, tape drives, and so on). The SCSI host adapter configures the devices attached to it as one subsystem—not as independent devices.

Although SCSI devices are installed essentially the same way as other devices, their configuration requirements are different.

SCSI Configuration Guidelines

For details on configuring your SCSI subsystem, refer to the documentation that came with your SCSI devices and/or your host adapter card. The following subsections offer some general guidelines.

SCSI ID Numbers

Each device attached to a SCSI host adapter card, as well as the card itself, must have a unique SCSI ID number from 0 to 7. When SCSI devices are shipped from Dell, the default SCSI ID numbers are assigned as follows:

- A SCSI host adapter card is configured as SCSI ID 7 (typically the default ID for a host adapter card).
- A SCSI tape drive or digital audio tape (DAT) drive is configured as SCSI ID 6 (typically the default ID number for a tape drive).
- A SCSI CD-ROM drive is configured as SCSI ID 5.
- SCSI hard-disk drives are usually configured as SCSI ID 0. (The drive used to boot your system should always be configured as SCSI ID 0.)



*NOTE: There is **no** requirement that SCSI ID numbers be assigned sequentially or that devices be attached to the cable in order by ID number.*

SCSI Cable and SCSI Termination

The type of cabling you receive with your SCSI device depends on the type of device you are installing.

- If you are installing internal SCSI devices (such as CD-ROM, hard-disk, or tape drives), you have internal SCSI cables as shown in [Figure 14](#). Narrow SCSI devices use a 50-pin cable; wide SCSI devices use a 68-pin SCSI cable. One end of each cable attaches to the SCSI host adapter. The connectors on the other end of the cable attach to the internal SCSI devices.
- If you are installing an external SCSI device, you have a shielded external cable that connects to the external SCSI connector on the SCSI host adapter card. You have a separate power cable to connect the SCSI device to an AC power source.

Before installing SCSI devices in your computer, you may need to configure the termination on your SCSI device(s). Both types of internal SCSI cables contain terminators on the device end of the cables, so the devices connected to these cables must have termination disabled (see Figure 14). External SCSI cables do not have terminators, so termination must be enabled on the SCSI device itself.

Figure 14. Internal SCSI Cables

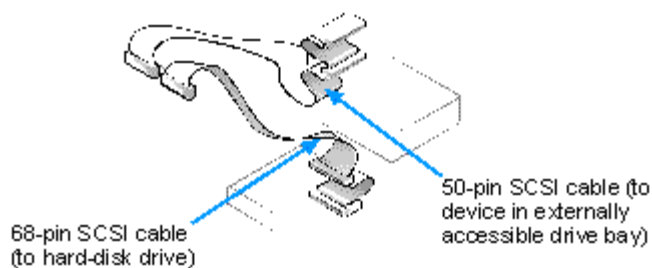

NOTICE: Do not connect devices to all three connectors (internal narrow connector, internal wide connector, and external connector) on a single SCSI host adapter card. Such a configuration is a violation of the SCSI specification. You can safely connect devices to any two of these three connectors on a single SCSI host adapter card.

If you are installing only internal SCSI devices, verify that termination is enabled on the SCSI host adapter and disabled for all other internal SCSI devices. If you are installing both internal and external SCSI devices, verify that termination is enabled on the external SCSI device and disabled for the SCSI host adapter and all internal SCSI devices.

General Procedure for Installing SCSI Devices

CAUTION: To avoid the possibility of electric shock, turn off the computer and any peripherals, disconnect them from their electrical outlets, and then wait at least 5 seconds before you remove the computer cover. Also, before you install an expansion card, see "[Safety First — For You and Your Computer.](#)"

Configure and install one or more SCSI devices in your computer as follows:

1. Determine which connector on the internal SCSI cable you will attach to each SCSI device.

See "[SCSI Configuration Guidelines.](#)"

NOTICE: When you unpack the drive, do not set it on a hard surface, which may damage the drive. Instead, set the drive on a surface, such as a foam pad, that will sufficiently cushion it.

2. Unpack each SCSI device and prepare it for installation.

Configure the device for a SCSI ID number and, if necessary, enable or disable termination. For instructions, see the documentation that came with the SCSI device and "[SCSI Configuration Guidelines.](#)"

3. Remove the computer cover as instructed in "[Removing the Computer Cover.](#)"

4. If you are installing a SCSI host adapter card, configure the adapter card.

For instructions on configuring the card, see the documentation that came with the adapter card and "[SCSI Configuration Guidelines.](#)"

5. Install the SCSI devices as appropriate.

- To install an internal SCSI hard-disk drive, complete steps 3 through 7 of "[Installing an EIDE Hard-Disk Drive in the Hard-Disk Drive Bracket](#)." Then continue with step 5 of this procedure.
 - To install a SCSI tape drive, CD-ROM drive, or DAT drive, complete steps 2 through 6 of "[Installing a Drive in a 5.25-Inch Drive Bay](#)." Then continue with step 5 of this procedure.
 - To install an external SCSI tape drive, continue with step 5 of this procedure.
6. If you are installing a new SCSI host adapter card, install it in an expansion slot now.

See "[Installing an Expansion Card](#)."

If a SCSI host adapter card is already installed, remove, reconfigure, and reinstall the card at this time. See the documentation that came with the SCSI host adapter card, "[Removing an Expansion Card](#)," and "[Installing an Expansion Card](#)."

Connect the hard-disk drive access cable to the SCSI host adapter card and to the HDLED connector on the riser board (see "[Riser-Board Expansion-Card Connectors](#)"). This cable carries a signal from the SCSI host adapter card to the hard-disk drive access indicator on the computer's front panel whenever one of the SCSI hard-disk drives is accessed.

7. Attach a SCSI cable to each SCSI device.

For additional instructions on connecting SCSI devices, see "[SCSI Cable and SCSI Termination](#)."

NOTICE: You must match the colored strip on the cable with pin 1 on the drive's interface connector to avoid possible damage to your system.

If you are installing an internal SCSI device, firmly press the SCSI cable's header connector onto the 50- or 68-pin connector on the back of the device.

The connectors on narrow SCSI cables are keyed for proper positioning - a raised area on the outside of the header connector fits into a notch on the device connector. The connectors on wide SCSI cables are shaped so that they can be attached one way only.

If you are installing an external SCSI device, connect one end of the external SCSI cable to the SCSI bus connector on the back of the device.

8. Attach the SCSI cable to the connector on the SCSI host adapter card.

NOTICE: You must match the colored strip on the internal SCSI cable with pin 1 on the adapter card connector to avoid possible damage to your system.

- If you are installing an internal SCSI device, connect the colored edge on the internal SCSI cable to the pin-1 end of the 50-pin connector (for a narrow SCSI device) or the 68-pin connector (for a wide SCSI device) on the adapter card, and then press the cable connector firmly onto the adapter card connector.
- If you are installing an external SCSI device, connect the other end of the external SCSI cable to the external connector on the adapter card.

For additional instructions, see the documentation that came with the adapter card.

9. Connect the SCSI device(s) to power.

- If you are installing an internal SCSI device, connect a DC power cable to the power input connector on the SCSI device.
- If you are installing an external SCSI device, connect the socket end of the power cable into the AC power receptacle on the back of the SCSI device. Connect the other end of the power cable into a standard electrical wall outlet.

Check all other cable connections. Fold all internal cables out of the way to provide airflow for the fan or cooling vents.

10. If you installed an externally accessible device, remove a front-panel insert for the drive bay.

See "[Removing and Replacing Front-Panel Inserts](#)" for instructions.

11. [Replace the computer cover](#), and reconnect your computer and peripherals to their power sources.
12. Turn on the peripherals connected to the computer.
13. Start the computer system.



NOTE: If the device you just installed is the primary hard-disk drive and no operating system is installed, you must start the computer using a bootable diskette or CD.

- To boot the system from a diskette, insert a bootable diskette (such as an operating system installation or recovery diskette) into diskette drive A, and turn on the computer.
- To boot the system from a CD, enter the [System Setup program](#) and set the [Boot Sequence](#) to CD-ROM First. Insert a bootable CD (such as an operating system installation CD or the *Dell ResourceCD*) into CD-ROM drive, and turn on the computer.



NOTE: If Enabled, the [Chassis Intrusion](#) option will cause the following message to be displayed at the next system start-up:

ALERT! Cover was previously removed.

14. If necessary, enter the [System Setup program](#) and update the system configuration information.

If you installed a SCSI hard-disk drive, set the Drive Type option for the appropriate drive under [Drives: Primary and Secondary](#) to None.



NOTE: Tape drives attached to a SCSI host adapter card are not part of the system configuration information.

After you update the System Setup options, reboot the system.

15. If you installed a SCSI hard-disk drive, partition and format the drive, as described in "[Partitioning and Formatting SCSI Hard-Disk Drives](#)," before proceeding to the next step.

16. Run the SCSI Device(s) test group of the Dell Diagnostics to verify that the new SCSI device is operating properly.

See your *Diagnostics and Troubleshooting Guide* for information on running the Dell Diagnostics and troubleshooting any problems that may occur.

To test a SCSI tape drive, refer to the documentation for the tape drive software to perform a tape drive backup and verification test.

17. If the device you just installed is the primary hard-disk drive, install the operating system on the hard-disk drive.

Refer to the documentation that came with the operating system.

Partitioning and Formatting SCSI Hard-Disk Drives

You may need to use different programs than those provided with the operating system to partition and format SCSI hard-disk drives. Refer to the documentation that came with your SCSI software drivers for information on installing the appropriate drivers and preparing your SCSI hard-disk drive for use.



NOTE: On systems with hard-disk drives larger than 2 GB, create a primary partition of 2 GB and divide the remaining capacity into partitions of 2 GB or less. For example, a system with a 2.5-GB hard-disk drive would have a primary partition of 2 GB (drive C) and a second partition of 500 MB (drive D). Hard-disk drives must be partitioned this way because MS-DOS-based operating systems (including Windows NT when using a FAT16 file system) do not support drive partitions larger than 2 GB.

[Back to Contents Page](#)

[Back to Contents Page](#)

Technical Specifications: Dell™ OptiPlex™ GX1 Low-Profile Managed PC Systems

- [Microprocessor](#)
- [System Information](#)
- [Expansion Bus](#)
- [Memory](#)
- [Drives](#)
- [Ports](#)
- [Video](#)
- [Key Combinations](#)
- [Controls and Indicators](#)
- [Power](#)
- [Physical](#)
- [Environmental](#)

Microprocessor

Microprocessor type	Intel® Pentium® II or Pentium III microprocessor
Internal cache	32 KB (16-KB data cache, 16-KB instruction cache)
L2 cache memory	512-KB pipeline burst, 4-way set-associative, write-back SRAM
Math coprocessor	internal to Pentium II or Pentium III microprocessor

System Information

System chip set	Intel 82440BX PCI/AGP
Data bus width	64 bits
Address bus width	32 bits
DMA channels	eight
Interrupt levels	15
System BIOS	2-Mb flash chip
System clock	66 or 100 MHz (matches external processor speed)

Expansion Bus

Bus types	PCI and ISA
-----------	-------------

Bus speed	PCI: 33 MHz ISA: 8.33 MHz
PCI expansion-card connectors	two (one PCI connector shares an expansion-card slot with an ISA connector)
ISA expansion-card connectors	two (one ISA connector shares an expansion-card slot with a PCI connector)
ISA expansion-card connector size	98 pins
ISA expansion-card connector data width (maximum)	16 bits
PCI expansion-card connector size	120 pins
PCI expansion-card connector data width (maximum)	32 bits

Memory

Architecture	64-bit (non-ECC) or 72-bit (ECC), noninterleaved, "PC100" 100 MHz
DIMM sockets	three
DIMM capacities	32-, 64-, 128-, and 256-MB SDRAM
Standard RAM	32 MB minimum
Maximum RAM	768 MB
BIOS address	F0000h

Drives

Externally accessible bays	one 5.25-inch bay for diskette, tape, or CD-ROM drive; one 3.5-inch bay for a diskette drive
Internally accessible bays	one 3.5-inch bay for a 1-inch-high hard-disk drive

Ports

Externally accessible:

Serial (DTE)	two 9-pin connectors; 16550-compatible
Parallel	one 25-hole connector (bidirectional)
Video	one 15-hole connector

Optional integrated NIC	RJ45 connector
PS/2-style keyboard	6-pin mini-DIN
PS/2-compatible mouse	6-pin mini-DIN
USB	two USB-compliant connectors
Audio line-in	miniature audio jack
Audio line-out (amplified source)	miniature audio jack
Microphone	miniature audio jack

Internally accessible:

Primary EIDE hard-disk drive	40-pin connector on PCI local bus
Secondary EIDE hard-disk drive	40-pin connector on PCI local bus
Diskette drive	34-pin connector

Video

Video type	ATI 3D Rage Pro AGP 2X controller
Video memory	4 MB standard (upgradable to 8 MB)
Maximum resolution	1600 x 1200 pixels, 256 colors

Key Combinations

<Ctrl><Alt>	restarts (reboots) the system
<Ctrl><Alt><Enter>	starts System Setup program (during POST only)
<Ctrl><Alt><\\>	toggles microprocessor speeds on 101-key keyboard (in MS-DOS® real mode only)
<Ctrl><Alt><#>	toggles microprocessor speeds on 102-key keyboard (in MS-DOS real

	mode only)
<Ctrl><Enter>	disables the system password at start-up

Controls and Indicators

Reset control	push button
Power control	push button
Power indicators	green LEDs (one on front panel, one on riser board); blinking green in sleep state
Hard-disk drive access indicator	green LED
Link integrity indicator (on optional integrated NIC connector)	green LED
Activity indicator (on optional integrated NIC connector)	yellow LED

Power

DC power supply:

Wattage	145 W
Heat dissipation	913 BTUs (fully loaded system without monitor)
Voltage	90 to 135 V at 60 Hz; 180 to 265 V at 50 Hz
Backup battery	3-V CR2032 coin cell

Physical

Height	10.9 cm (4.3 inches)
Width	40.89 cm (16.1 inches)
Depth	43.69 cm (17.2 inches)
Weight	10.89 kg (24 lb) or more, depending on options installed

Environmental

Temperature:

Operating	10° to 35°C (50° to 95°F)
Storage	–40° to 65°C (–40° to 149°F)
Relative humidity	8% to 80% (noncondensing)

Maximum vibration:

Operating	0.25 G at 3 to 200 Hz at 1 octave/min
Storage	0.5 G at 3 to 200 Hz at 1 octave/min

Maximum shock:

Operating	left side (vertical orientation) and bottom half-sine pulse with a change in velocity of 20 inches/sec (50.8 cm/sec)
Storage	27-G faired square wave with a velocity change of 200 inches/sec (508 cm/sec)

Altitude:

Operating	–16 to 3048 m (–50 to 10,000 ft)
Storage	–16 to 10,600 m (–50 to 35,000 ft)

NOTE: For the full name of an abbreviation or acronym used in this table, see the Glossary in the online System User's Guide.

[Back to Contents Page](#)

[Back to Contents Page](#)

ISA Configuration Utility Messages: Dell™ OptiPlex™ GX1 Low-Profile Managed PC Systems

[Overview](#)[Configuration Manager Messages](#)[ICU Error Messages](#)

Overview

The ISA Configuration Utility (ICU) and its Configuration Manager are capable of identifying problems and alerting you to them. Both utilities can alert you to problems with card configuration and problems that prevent proper operation of the utility. This appendix describes each type of message and lists the possible causes and actions you can take to resolve problems indicated by a message. See the following tables to locate your message and identify possible corrective actions.

ICU Error Messages

The ICU displays a variety of error messages while in operation. These messages alert you to problems that prevent the ICU from running correctly and inform you of resource conflicts that prevent the configuration of various cards in your computer. If you receive a message from the ICU, see the following table for suggestions on resolving problems indicated by the message.

Message	Probable Cause	Corrective Action
Out of memory Memory allocation failed	Either of these messages can appear if the system runs out of memory during operation of the utility.	Disable any TSR programs or any unneeded device drivers.
Not enough memory to run the ICU	This message appears when you start the ICU if the system does not have enough memory to run the utility.	Disable any TSR programs or any unneeded device drivers.
Can't open index file. This file is required for ICU to run.	The ICU cannot find the index file for its database.	Make sure to switch to drive A before attempting to start the utility.
No Configuration Manager.	The device driver needed by the ICU is corrupted or is not correctly configured.	Verify that the following device statement appears in your config.sys file: <code>device=drive:\directory\</code>

		<p>drivers\dos\dwcfgmg.sys</p> <p>In this statement, <i>drive</i> and <i>directory</i> represent the drive and directory where the driver resides. The default is c:\plugplay.</p>
<p>At least one Plug and Play card in your system is not configured due to conflicts. These are marked "config err" in the list of configured cards.</p> <p>Due to conflicts, the ICU could only configure some Plug and Play cards in your system. Unconfigured cards are marked "config err" in the list of configured cards.</p>	<p>The Configuration Manager or the ICU cannot configure at least one Plug and Play expansion card because of resource conflicts with one or more cards.</p>	<p>You must reconfigure the conflicting card(s). To find the conflicting card, perform the following steps:</p> <ol style="list-style-type: none"> 1. Select the Plug and Play expansion card marked with <code>config err</code>, and then click the Modify button. <p>The Card Configuration dialog box displays the functions assigned to the Plug and Play expansion card.</p> <ol style="list-style-type: none"> 2. Select a function and then click Settings. Click Cancel if the ICU does not display a message naming the conflicting card. 3. Repeat step 2 until the ICU displays a message box naming the conflicting card and the resource(s) in conflict. See the following table entry for an explanation of this message box.
<p>This device is unconfigurable because of a resource conflict with card <i>card_name</i>. The conflicting resource is <i>resource_name</i>. To fix, reconfigure the conflicting card.</p>	<p>The selected card is unconfigurable because one of its resources is already being used by another device.</p>	<p>Perform the following procedure:</p> <ol style="list-style-type: none"> 1. Make a note of the card name and the type of conflicting resource. 2. Follow the procedure in "Modifying a Card" and change the value for <i>resource_name</i> used by <i>card_name</i>.
<p>The ICU has successfully configured all Plug and Play cards in your system. For the new configuration to take effect, save the configuration, then reboot your system.</p>	<p>The ICU has successfully configured all of the Plug and Play expansion cards that were not configured by the Configuration Manager.</p>	<p>To accept these settings, save the configuration information into NVRAM by selecting Exit from the File menu and then selecting Yes to save. You must reboot your system for these settings to take effect.</p>
<p>The loaded card is not a</p>	<p>The category you have</p>	<p>Select OK. The ICU automatically opens</p>

category card. Press OK to proceed.	chosen is not the correct category under which to add this card.	the correct category's dialog box. Continue the procedure for adding the card as described in " Adding a Listed Card " or " Adding an Unlisted Card ."
<p>No more DMA values can be added.</p> <p>No more interrupt values can be added.</p> <p>No more memory values can be added.</p> <p>No more I/O port values can be added.</p>	No more values are available for the resource you are trying to add or modify.	<p>The maximum number of values for each resource is as follows:</p> <ul style="list-style-type: none"> • 4 DMA channels • 7 IRQ lines • 9 memory address blocks • 20 I/O ports <p>To free values for the resource you are trying to add or modify, delete some of the values listed in the resource box for the card. If your card requires all of the values listed, contact your card manufacturer to resolve the issue.</p>
The ICU detects a resource conflict between this card and <i>conflicting_card</i> . The conflicting resource was: <i>resource</i> .	You added or modified a card that now requires a <i>resource</i> value already in use by <i>conflicting_card</i> .	<p>Try each of the following options until the problem is resolved:</p> <ul style="list-style-type: none"> • Modify the card you are adding so that it uses a different value for <i>resource</i>. See "Modifying a Card" for instructions. • Modify <i>conflicting_card</i> so that it uses a different value for resource. See "Modifying a Card" for instructions. • If <i>conflicting_card</i> is not the system board, remove it from the computer. See "Removing a Card" for instructions. • Remove all expansion cards from the ICU, and then add them back one at a time, beginning with the new card and resolving resource conflicts as they arise. See "Removing a Card" and "Adding a Listed Card" or "Adding an Unlisted Card" for instructions. • If you cannot resolve the resource conflict by any of the preceding methods, remove the new card. If you were modifying an existing card, reset the modified card to its previous resource value.
The configuration (.cfg)	This message appears	Use the following procedure:

<p>file used by the ICU for this card is now invalid or does not exist. Do you wish to load the file?</p> <p>No configuration (.cfg) file exists for the card being modified. Do you want to load one?</p>	<p>when you try to add a listed card and the configuration file for this card has been corrupted or deleted from the database.</p> <p>This message appears when you modify a card and its configuration file does not exist or has been deleted.</p>	<ol style="list-style-type: none"> 1. Insert the original ICU diskette into the diskette drive. <p>You can create an <i>ISA Configuration Utility</i> diskette from the <i>Dell ResourceCD</i>. See "Preparing to Use the ICU."</p> <ol style="list-style-type: none"> 2. Change to the db subdirectory on the diskette drive. <p>For example, type <code>cd a:\db</code>.</p> <ol style="list-style-type: none"> 3. Use a text editor to search the icu.ndx file for the card ID of the card you want to add or modify. <p>The card ID forms part of the name of the configuration file. For example, if the card ID is ICU0200, the configuration file is !icu0200.cfg.</p> <ol style="list-style-type: none"> 4. Copy the configuration file from the original ICU diskette to the backup diskette.
<p>This is an EISA system. Use an ECU, not the ICU, to configure your system.</p>	<p>This message appears if you attempt to run the ICU on an EISA system.</p>	<p>To use the ICU, you must load the utility onto a non-EISA system.</p>
<p>You have added a card using settings different from factory default. Reconfigure the card to the settings in the next display (see the card's manual) before installing it.</p>	<p>This message can appear in two situations:</p> <ul style="list-style-type: none"> • You added an ISA expansion card, selected OK, and the ICU had to use resource values different from the card's defaults to avoid conflicts. • You added an ISA expansion card, selected Advanced, and chose resource 	<p>Make note of the new card configuration shown in the Card Resource Usage dialog box displayed after this message. Change jumper settings on the ISA expansion card to match the new card configuration.</p>

values different from the card's defaults.
--

NOTE: For the full name of an abbreviation or acronym used in this table, see the Glossary in the online System User's Guide.

Configuration Manager Messages

The Configuration Manager for the ICU identifies problems following system boot and generates messages if necessary. These messages alert you to any unsuccessful attempts to configure Plug and Play or Peripheral Component Interconnect (PCI) expansion cards, as well as any problems that interfere with the operation of the Configuration Manager. If you receive a message from the Configuration Manager, see the following table for suggestions on resolving problems indicated by the message.

Message	Probable Cause	Corrective Action
Found Plug and Play ISA card: <i>Plug and Play ISA Card Name</i> .	This message appears at system start-up for each Plug and Play ISA expansion card recognized by the Configuration Manager.	Status message; no action is required.
NOTICE: Boot Device Not Active! CSN= <i>Card Select Number</i> .	A boot device was found to be inactive.	Status message; no action is required. The Configuration Manager automatically configures and activates the device.
One or more active devices have been reconfigured - system requires reboot. Press any key to reboot system.	You modified the resource values of one or more PCI or Plug and Play ISA expansion cards.	Reboot the system to reconfigure the card(s).
The Plug and Play ISA card has been successfully configured. Card Count Plug and Play ISA cards have been successfully configured.	The Configuration Manager has successfully configured the given number of cards.	If this message does not match the number of Plug and Play ISA expansion cards installed in your computer, reinstall any Plug and Play expansion cards not listed and reboot the system.
ERROR: Insufficient CM Memory	There is not enough memory available to the Configuration	Disable any TSR programs or any unneeded device drivers.

	Manager for it to run.	
ERROR: Fatal BIOS error Internal Error Code.	A BIOS call failed with an internal error. The most likely cause is an incompatibility between the BIOS and the Configuration Manager.	See " Getting Help " in your <i>Diagnostics and Troubleshooting Guide</i> for instructions on obtaining technical assistance.
ERROR: Could not read NVS, Error= <i>Internal Error Code</i> .	An attempt to read the NVRAM failed.	See " Getting Help " in your <i>Diagnostics and Troubleshooting Guide</i> for instructions.
ERROR: Failed NVS write. Error= <i>Internal Error Code</i> .	An attempt to write to NVRAM failed.	Run the Dell Diagnostics to verify the integrity of your system NVRAM. See "Running the Dell Diagnostics" in your <i>Diagnostics and Troubleshooting Guide</i> for instructions. If you are unable to determine the cause of the error, see " Getting Help " in your <i>Diagnostics and Troubleshooting Guide</i> for instructions.
ERROR: Failed to activate device, CSN= <i>Card Select Number</i> .	A Plug and Play expansion card could not be activated.	Use the following procedure: 1. Exit the ICU and turn off your system. 2. Remove the Plug and Play expansion card that could not be activated. Follow steps 2 through 6 of " Removing an Expansion Card " and then return to this procedure. 3. Reinstall the Plug and Play expansion card. Follow steps 5 through 10 of " Installing an Expansion Card " and then return to this procedure. If you still receive the error message, contact the manufacturer of the Plug and Play expansion card for assistance.
WARNING: Could not configure <i>Plug and Play Card Name</i> . WARNING: Could not	The card(s) mentioned are not fully configured due to resource conflicts.	If you have documentation that lists the allowable resource values for your Plug and Play or PCI expansion card, you can use the following procedure to locate and resolve the resource conflict.

configure PCI device,
ID=*DeviceID*.

Failed to configure *Number of Total Count Plug and Play* ISA devices. Use your system's configuration utility to resolve conflicts. Press any key to continue.

NOTE: If you do not have documentation listing the allowable resource values, see the corrective action for these messages in the next table entry.

1. Start the ICU.

Any Plug and Play or PCI expansion cards that could not be configured should be marked with `config err` on the list of cards in the ICU window.
2. Select the System Resources option from the View menu.

The System Resource Usage dialog box displays all resources currently used by the system.
3. Select one of the resources used by your Plug and Play or PCI expansion card, and click Used By Card.

The Card Resources Usage dialog box identifies which device is using the resource.
4. Repeat step 3 until you have identified all conflicting resources and the cards that use them.
5. Modify the cards, as needed, to free the resources required by the unconfigured Plug and Play or PCI expansion card.

See "[Modifying a Card](#)" for instructions.

WARNING: Could not configure *Plug and Play Card Name*.

WARNING: Could not configure PCI device,
ID=*DeviceID*.

Failed to configure *Number of Total Count Plug and*

The card(s) mentioned are not fully configured due to resource conflicts.

If you do not know the allowable resource values for your Plug and Play or PCI expansion card, use the following procedure to locate and resolve the resource conflict:

1. Remove all card configurations from the ICU.

See "[Removing a Card](#)" for instructions.

<p>Play ISA devices. Use your system's configuration utility to resolve conflicts. Press any key to continue.</p>		<ol style="list-style-type: none"> 2. Reboot your system. <p>The ICU should automatically configure your Plug and Play or PCI expansion card.</p> <ol style="list-style-type: none"> 3. Add the ISA expansion cards back into the ICU, resolving any resource conflicts as they arise. <p>See "Adding a Listed Card" for instructions.</p> <p>If your Plug and Play or PCI expansion card is not automatically configured when you reboot the system with all other cards removed, you should contact the manufacturer of the card or see "Getting Help" in your <i>Diagnostics and Troubleshooting Guide</i>.</p>
---	--	--

<p>WARNING: Boot Device conflict detected! CSN=Card Select Number Error=Error.</p>	<p>One of the devices is attempting to use one or more resources assigned to the system's boot device.</p>	<p>Perform the following procedure:</p> <ol style="list-style-type: none"> 1. Start the ICU. 2. Identify the card marked config err. <p>This card is attempting to use one or more resources required by the system's boot device.</p> <ol style="list-style-type: none"> 3. Follow the procedure for the preceding error message in this table.
--	--	---

NOTE: For the full name of an abbreviation or acronym used in this table, see the Glossary in the online System User's Guide.

[Back to Contents Page](#)