

Dell™ Dimension™ 4600 Series

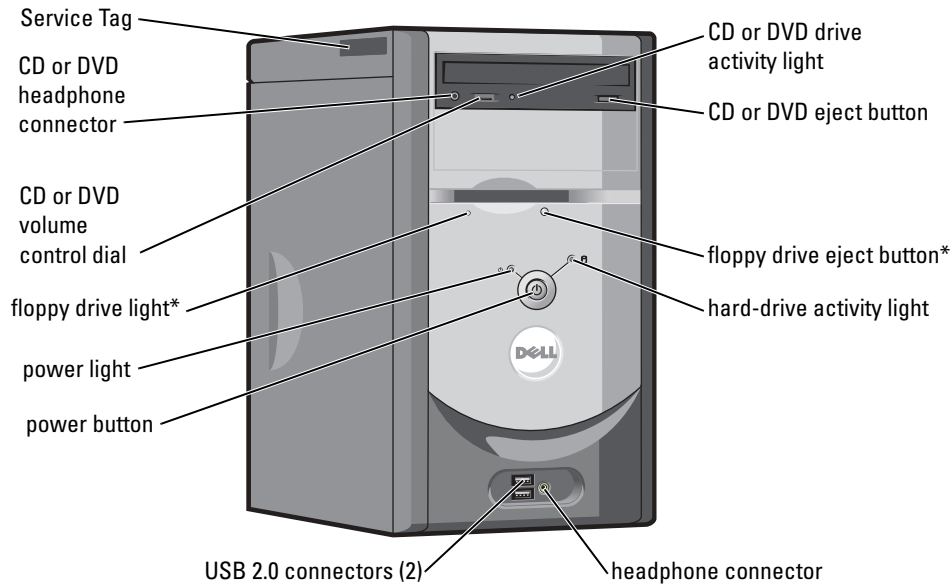

*On computers with an optional floppy drive.

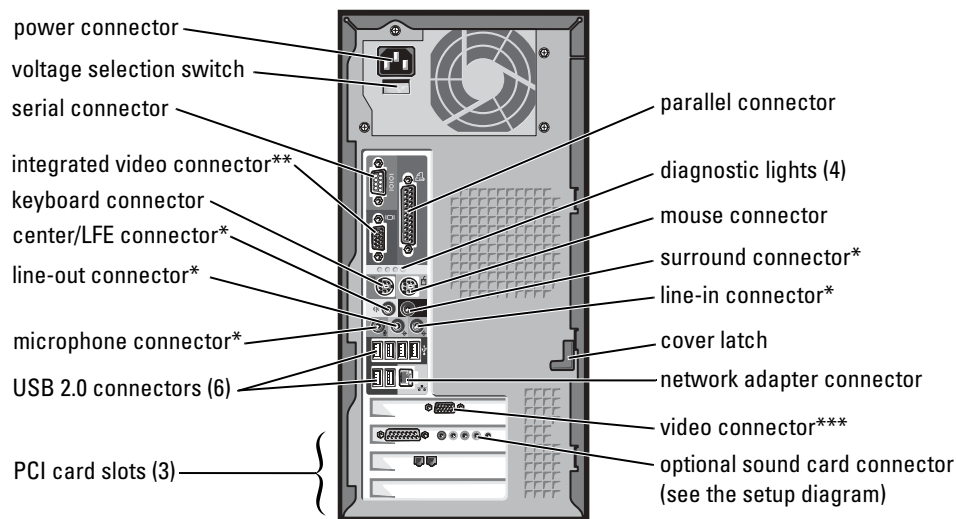

*On computers with integrated sound.

**On computers with integrated video.

***On computers with a video card.

Model DMC, MTC2

Notes, Notices, and Cautions



NOTE: A NOTE indicates important information that helps you make better use of your computer.



NOTICE: A NOTICE indicates either potential damage to hardware or loss of data and tells you how to avoid the problem.



CAUTION: A CAUTION indicates a potential for property damage, personal injury, or death.

Abbreviations and Acronyms

For a complete list of abbreviations and acronyms, see the *Tell Me How* help file. To access help files, see page 21.

If you purchased a Dell™ n Series computer, any references in this document to Microsoft® Windows® operating systems are not applicable.

Information in this document is subject to change without notice.

© 2003–2004 Dell Inc. All rights reserved.

Reproduction in any manner whatsoever without the written permission of Dell Inc. is strictly forbidden.

Trademarks used in this text: *Dell*, the *DELL* logo, *DellNet*, *Inspiron*, *Dell Precision*, *Dimension*, *OptiPlex*, *PowerVault*, *PowerApp*, *PowerEdge*, *PowerConnect*, *Axim*, and *Latitude* are trademarks of Dell Inc.; *Intel*, *Pentium*, and *Celeron* are registered trademarks of Intel Corporation; *Microsoft* and *Windows* are registered trademarks of Microsoft Corporation; *EMC* is a registered trademark of EMC Corporation.

Other trademarks and trade names may be used in this document to refer to either the entities claiming the marks and names or their products. Dell Inc. disclaims any proprietary interest in trademarks and trade names other than its own.

Model DMC, MTC2

July 2004

P/N G7279

Rev. A00

Contents

Safety Instructions	7
Finding Information for Your Computer	9
1 Setting Up and Using Your Computer	
Setting Up a Printer	11
Printer Cable	11
Connecting a Parallel Printer	11
Connecting a USB Printer	12
Setting Up a Home and Office Network	13
Connecting to a Network Adapter	13
Network Setup Wizard	14
Connecting to the Internet	14
Setting Up Your Internet Connection	15
Copying CDs and DVDs	16
How to Copy a CD or DVD	16
Using Blank CD-Rs and CD-RWs	16
Helpful Tips	17
Hyper-Threading	17
Booting to a USB Device	18
Turning Off Your Computer	18
2 Solving Problems	
Finding Solutions	19
Finding Help Information	21
Battery Problems	21
Drive Problems	21
Floppy drive problems	21
CD drive problems	22

Problems writing to a CD-RW drive.	23
DVD drive problems.	23
Hard drive problems.	24
E-Mail, Modem, and Internet Problems	24
Error Messages	25
General Problems	26
The computer stops responding	26
A program stops responding.	27
A program crashes repeatedly.	27
A program is designed for an earlier Microsoft® Windows® operating system	27
A solid blue screen appears	27
Other software problems	27
Other technical problems	28
General hardware problems.	28
IEEE 1394 Device Problems.	29
Keyboard Problems	30
Mouse Problems.	30
Network Problems.	31
Power Problems.	32
Printer Problems.	33
Scanner Problems	34
Sound and Speaker Problems	35
No sound from speakers.	35
No sound from headphones	36
Video and Monitor Problems	36
If the screen is blank	36
If the screen is difficult to read.	37

3 Advanced Troubleshooting

Diagnostic Lights	39
Dell Diagnostics	43
Starting the Dell Diagnostics	43
Dell Diagnostics Main Menu	44
Drivers	45
What Is a Driver?	45
Identifying Drivers	45
Reinstalling Drivers	45
Restoring Your Operating System	46
Using Microsoft Windows XP System Restore	47
Using Dell PC Restore by Symantec	48
Resolving Software and Hardware Incompatibilities	49

4 Adding Parts

Front and Back View of the Computer	51
Front View	51
Back View	53
Removing the Computer Cover	55
Looking Inside Your Computer	57
System Board	58
Adding Cards	59
Adding or Replacing the AGP Card	61
Removing an AGP Card	62
Installing an AGP Card	62
Adding or Replacing a Second Hard Drive	63
Adding a Floppy Drive	66
Adding a Second CD or DVD Drive	70

Adding Memory	75
DDR Memory Overview	75
Memory Installation Guidelines	75
Installing Memory	76
Replacing the Computer Cover	78
5 Appendix	
Specifications	79
System Setup	82
Overview	82
Viewing Settings	83
Boot Sequence	84
Clearing Forgotten Passwords	85
Replacing the Battery	86
Dell Technical Support Policy (U.S. Only)	88
Definition of "Dell-Installed" Software and Peripherals	88
Definition of "Third-Party" Software and Peripherals	88
FCC Notices (U.S. Only)	88
Class A	89
Class B	89
FCC Identification Information	90
Contacting Dell	90
Index	107

Safety Instructions

See your *Product Information Guide* for safety instructions.

Finding Information for Your Computer

What are you looking for?

- How to set up my computer

Find It Here**Setup Diagram**

-
- Tips on using the Microsoft® Windows® operating system
 - How to clean my computer
 - How to use my mouse and keyboard

Tell Me How Help File

- 1 Click the **Start** button and click **Help and Support**.
- 2 Click **User and system guides** and click **User's guides**.
- 3 Click **Tell Me How**.

-
- Express Service Code and Service Tag
 - Microsoft Windows License Label

Express Service Code and Product Key Label

These labels are located on your computer.

What are you looking for?	Find It Here
<ul style="list-style-type: none"> • Latest drivers for my computer • Answers to technical service and support questions • Online discussions with other users and technical support • Documentation for my computer 	<p data-bbox="646 432 1170 457">Dell Support Website — support.dell.com</p> <p data-bbox="646 468 1295 493">The Dell Support website provides several online tools, including:</p> <ul style="list-style-type: none"> • Solutions — Troubleshooting hints and tips, articles from technicians, and online courses • Community Forum — Online discussion with other Dell customers • Upgrades — Upgrade information for components, such as memory, the hard drive, and the operating system • Customer Care — Contact information, order status, warranty, and repair information • Downloads — Drivers, patches, and software updates • Reference — Computer documentation, product specifications, and white papers
<ul style="list-style-type: none"> • How to use Windows XP • Documentation for my computer • Documentation for devices (such as a modem) 	<p data-bbox="646 835 1170 861">Windows XP Help and Support Center</p> <ol style="list-style-type: none"> 1 Click the Start button and click Help and Support. 2 Type a word or phrase that describes your problem and click the arrow icon. 3 Click the topic that describes your problem. 4 Follow the instructions on the screen.

Setting Up and Using Your Computer

Setting Up a Printer

 **NOTICE:** Complete the operating system setup before you connect a printer to the computer.

See the documentation that came with the printer for setup information, including how to:

- Obtain and install updated drivers.
- Connect the printer to the computer.
- Load paper and install the toner or ink cartridge.
- Contact the printer manufacturer for technical assistance.

Printer Cable

Your printer connects to your computer with either a USB cable or a parallel cable. Your printer may not come with a printer cable, so if you purchase a cable separately, ensure that it is compatible with your printer. If you purchased a printer cable at the same time you purchased your computer, the cable may arrive in the computer box.

Connecting a Parallel Printer

- 1 Complete the operating system setup, if you have not already done so.
- 2 Shut down the computer through the **Start** menu (see page 18).

 **NOTICE:** For best results, use a 3-m (10-ft) or shorter parallel cable.

- 3 Attach the parallel printer cable to the parallel connector on the computer and tighten the two screws. Attach the cable to the connector on the printer and snap the two clips into the two notches.

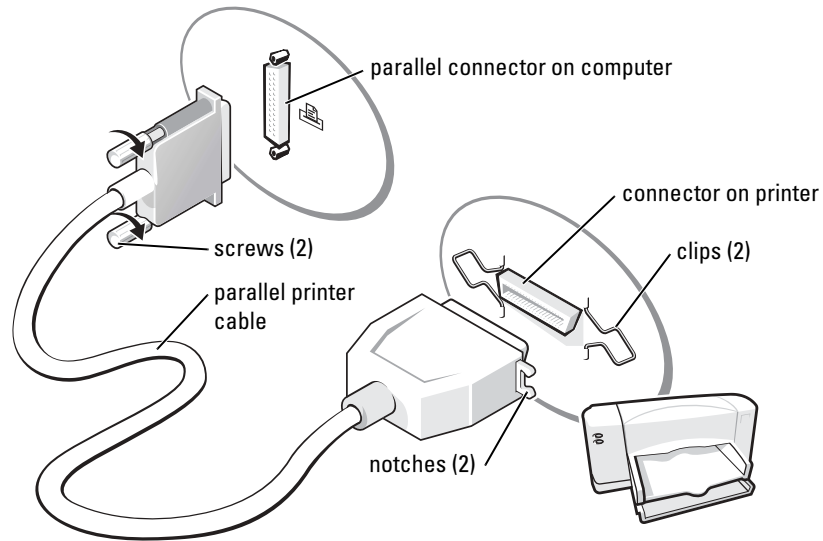

- 4 Turn on the printer and then turn on the computer. If the **Add New Hardware Wizard** window appears, click **Cancel**.
- 5 Install the printer driver if necessary. See the documentation that came with your printer.

Connecting a USB Printer

 **NOTE:** You can connect USB devices while the computer is turned on.

- 1 Complete the operating system setup if you have not already done so.
- 2 Install the printer driver if necessary. See the documentation that came with your printer.
- 3 Attach the USB printer cable to the USB connectors on the computer and the printer. The USB connectors fit only one way.

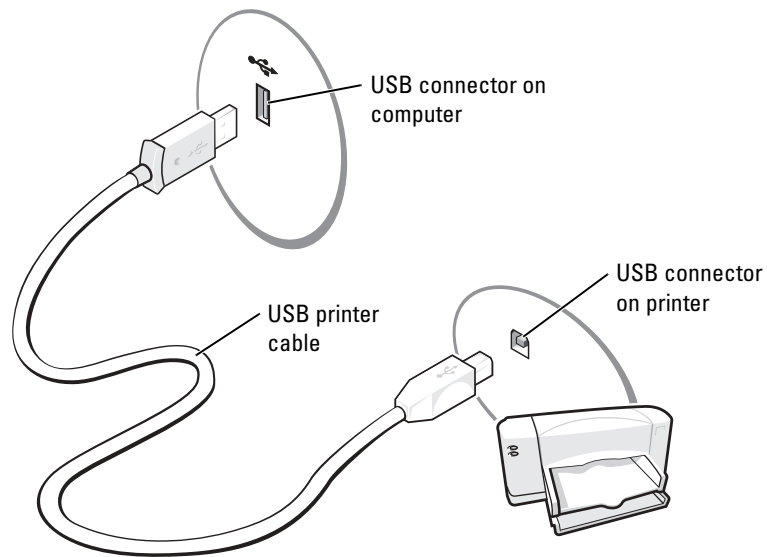

Setting Up a Home and Office Network

Connecting to a Network Adapter

Before you connect your computer to a network, the computer must have a network adapter installed and a network cable connected to it.

To connect a network cable:

- 1 Connect the network cable to the network adapter connector on the back of your computer.

 **NOTE:** Insert the cable until it clicks into place, and then gently pull it to ensure that it is secure.

- 2 Connect the other end of the network cable to a network connection device, such as a network wall jack.

 **NOTE:** Do not use a network cable with a telephone wall jack.

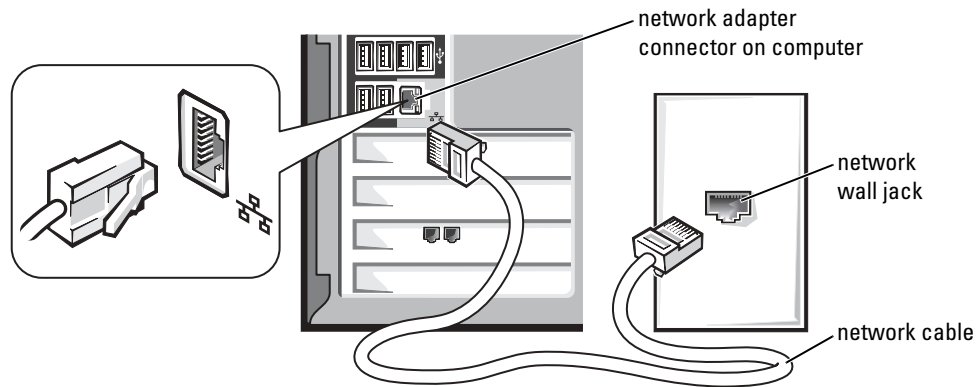

Network Setup Wizard

The Microsoft® Windows® XP operating system provides a Network Setup Wizard to guide you through the process of sharing files, printers, or an Internet connection between computers in a home or small office.

- 1 Click the **Start** button, point to **All Programs**→ **Accessories**→ **Communications**, and then click **Network Setup Wizard**.
- 2 On the welcome screen, click **Next**.
- 3 Click **Checklist for creating a network**.

 **NOTE:** Selecting the connection method **This computer connects directly to the Internet** enables the integrated firewall provided with Windows XP.

- 4 Complete the checklist and required preparations, and return to the Network Setup Wizard.
- 5 Follow the instructions on the screen.

Connecting to the Internet

 **NOTE:** ISPs and ISP offerings vary by country.

To connect to the Internet, you need a modem or network connection and an Internet service provider (ISP), such as AOL or MSN. Your ISP will offer one or more of the following Internet connection options:

- Dial-up connections that provide Internet access through a phone line. Dial-up connections are considerably slower than DSL and cable modem connections.
- DSL connections that provide high-speed Internet access through your existing phone line. With a DSL connection, you can access the Internet and use your phone on the same line simultaneously.

- Cable modem connections that provide high-speed Internet access through your local cable TV line.

If you are using a dial-up connection, connect a telephone line to the modem connector on your computer and to the telephone wall jack before you set up your Internet connection. If you are using a DSL or cable modem connection, contact your ISP for setup instructions.

Setting Up Your Internet Connection

To set up an AOL or MSN connection:

- 1 Save and close any open files, and exit any open programs.
- 2 Double-click the **MSN Explorer** or **AOL** icon on the Windows® desktop.
- 3 Follow the instructions on the screen to complete the setup.

If you do not have an **MSN Explorer** or **AOL** icon on your desktop or if you want to set up an Internet connection with a different ISP:

- 1 Save and close any open files, and exit any open programs.
- 2 Click the **Start** button and click **Internet Explorer**.
The **New Connection Wizard** appears.
- 3 Click **Connect to the Internet**.
- 4 In the next window, click the appropriate option:
 - If you do not have an ISP and want to select one, click **Choose from a list of Internet service providers (ISPs)**.
 - If you have already obtained setup information from your ISP but you did not receive a setup CD, click **Set up my connection manually**.
 - If you have a CD, click **Use the CD I got from an ISP**.
- 5 Click **Next**.

If you selected **Set up my connection manually**, continue to step 6. Otherwise, follow the instructions on the screen to complete the setup.



NOTE: If you do not know which type of connection to select, contact your ISP.

- 6 Click the appropriate option under **How do you want to connect to the Internet?**, and then click **Next**.
- 7 Use the setup information provided by your ISP to complete the setup.

If you cannot connect to the Internet but have successfully connected in the past, the ISP might have a service outage. Contact your ISP to check the service status, or try connecting again later.

Copying CDs and DVDs

 **NOTE:** Ensure that you follow all copyright laws when you create CDs.

This section applies only to computers that have a CD-R, CD-RW, DVD+RW, DVD+R, or DVD/CD-RW combo drive.

The following instructions show how to make an exact copy of a CD or DVD. You can also use Sonic RecordNow for other purposes, including creating CDs from audio files on your computer and creating MP3 CDs. For instructions, see the Sonic RecordNow documentation that came with your computer. Open Sonic RecordNow, click the question mark icon in the upper-right corner of the window, and click **RecordNow Help** or **RecordNow Tutorial**.

How to Copy a CD or DVD

 **NOTE:** If you have a DVD/CD-RW combo drive and you experience recording problems, check for available software patches at the Sonic support website at support.sonic.com.

 **NOTE:** Most commercial DVDs have copyright protection and cannot be copied using Sonic RecordNow.

- 1 Click the **Start** button, point to **All Programs**→ **Sonic**→ **RecordNow!**→ **RecordNow!**.
- 2 Click either the audio tab or the data tab, depending on the kind of CD you are planning to copy.
- 3 Click **Exact Copy**.
- 4 To copy the CD or DVD:
 - *If you have one CD or DVD drive*, ensure that the settings are correct and click **Copy**. The computer reads your source CD or DVD and copies it to a temporary folder on your computer hard drive.
When prompted, insert a blank CD or DVD into the CD or DVD drive and click **OK**.
 - *If you have two CD or DVD drives*, select the drive into which you have inserted your source CD or DVD and click **Copy**. The computer copies the data on the CD or DVD to the blank CD or DVD.

Once you have finished copying the source CD or DVD, the CD or DVD that you have created automatically ejects.

Using Blank CD-Rs and CD-RWs

Your CD-RW drive can write to two different types of recording media—CD-Rs and CD-RWs. Use blank CD-Rs to record music or permanently store data files. After creating a CD-R, you cannot write to that CD-R again without changing your method of recording (see the Sonic documentation for more information). Use blank CD-RWs to write to CDs or to erase, rewrite, or update data on CDs.

Helpful Tips

- Use Microsoft® Windows® Explorer to drag and drop files to a CD-R or CD-RW only after you start Sonic RecordNow and open a RecordNow project.
- You must use CD-Rs to burn music CDs that you want to play in regular stereos. CD-RWs do not play in most home or car stereos.
- You cannot create audio DVDs with Sonic RecordNow.
- Music MP3 files can be played only on MP3 players or on computers that have MP3 software installed.
- Do not burn a blank CD-R or CD-RW to its maximum capacity; for example, do not copy a 650-MB file to a 650-MB blank CD. The CD-RW drive needs 1 or 2 MB of the blank CD to finalize the recording.
- Use a blank CD-RW to practice CD recording until you are familiar with CD recording techniques. If you make a mistake, you can erase the data on the CD-RW and try again. You can also use blank CD-RWs to test music file projects before you record the project permanently to a blank CD-R.
- See the Sonic support website at support.sonic.com for additional information.

Hyper-Threading

Hyper-Threading is an Intel® technology that can enhance overall computer performance by allowing one physical microprocessor to function as two logical microprocessors, capable of performing certain tasks simultaneously. It is recommended that you use the Microsoft® Windows® XP operating system because Windows XP is optimized to take advantage of Hyper-Threading technology. While many programs can benefit from Hyper-Threading, some programs have not been optimized for Hyper-Threading and may require an update from the software manufacturer. Contact the software manufacturer for updates and information about using Hyper-Threading with your software.

To determine if your computer is using Hyper-Threading technology:

- 1** Click the **Start** button, right-click **My Computer**, and then click **Properties**.
- 2** Click **Hardware** and click **Device Manager**.
- 3** In the **Device Manager** window, click the plus (+) sign next to the processor type. If Hyper-Threading is enabled, the processor is listed twice.

You can enable or disable Hyper-Threading through system setup. For more information on Hyper-Threading, search the Knowledge Base on the Dell Support website at support.dell.com.

Booting to a USB Device

 **NOTE:** To boot to a USB device, the device must be bootable. To make sure your device is bootable, check the device documentation.

To restart your computer to a USB device such as a floppy drive, memory key, or CD-RW drive:

- 1 Connect the USB device to a USB connector.
- 2 Shut down (see page 18) and restart the computer.
- 3 Turn on the computer. When the DELL™ logo appears, press <F12> immediately.

If you wait too long and the Microsoft® Windows® logo appears, continue to wait until you see the Windows desktop. Then shut down your computer through the **Start** menu and try again.

 **NOTE:** This procedure changes the boot sequence for one time only. On the next start-up, the computer boots according to the devices specified in system setup.

- 4 When the boot device list appears, highlight **USB Flash Device** and press <Enter>. The computer restarts to the connected USB device.

Turning Off Your Computer

 **NOTICE:** To avoid losing data, turn off your computer by performing a Microsoft® Windows® operating system shutdown, as described next, rather than by pressing the power button.

- 1 Save and close any open files, exit any open programs, click the **Start** button, and then click **Turn Off Computer**.
- 2 In the **Turn off computer** window, click **Turn off**.

The computer turns off after the shutdown process finishes.

Solving Problems

Finding Solutions

Sometimes it's difficult to figure out where to go for answers. Use this chart to help you quickly find the answers to your questions.

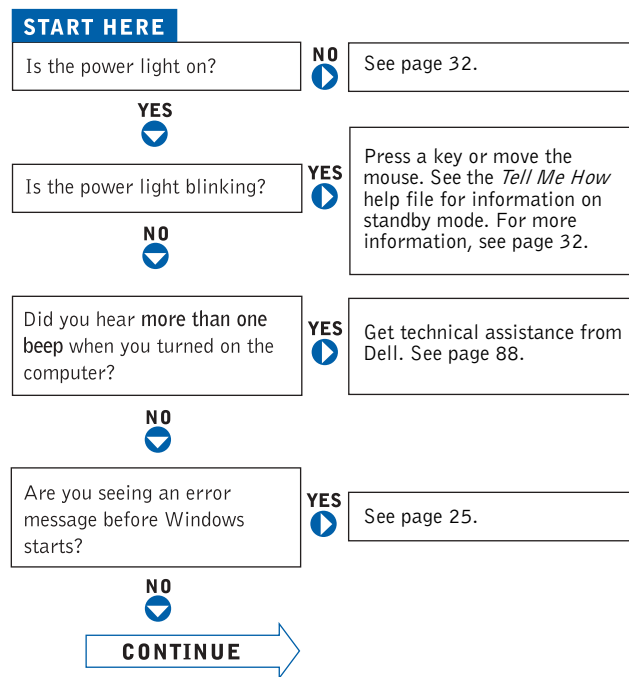

Are you having a problem with... NO	<input type="checkbox"/>	video or the monitor?	YES	See page 36.
	<input type="checkbox"/>	sound or the speakers?	YES	See page 35.
	<input type="checkbox"/>	the printer?	YES	See page 33.
	<input type="checkbox"/>	the modem?	YES	See page 24.
	<input type="checkbox"/>	the mouse?	YES	See page 30.
	<input type="checkbox"/>	the keyboard?	YES	See page 30.
	<input type="checkbox"/>	the hard drive or a disk drive?	YES	See page 21.
	<input type="checkbox"/>	the network adapter?	YES	See page 31.
	<input type="checkbox"/>	the scanner?	YES	See page 34.
	<input type="checkbox"/>	Windows error messages?	YES	See page 25.
	<input type="checkbox"/>	a program?	YES	See page 26.
	<input type="checkbox"/>	the Internet?	YES	See page 24.
	<input type="checkbox"/>	your e-mail?	YES	See page 24.
	Are you having some other type of problem?	YES	See page 26.	

Finding Help Information

TO ACCESS THE TELL ME HOW HELP FILE —

- 1 Click the **Start** button and click **Help and Support**.
- 2 Click **User and system guides** and click **User's guides**.
- 3 Click **Tell Me How**.

TO ACCESS WINDOWS HELP —

- 1 Click the **Start** button and click **Help and Support**.
- 2 Type a word or phrase that describes your problem and click the arrow icon.
- 3 Click the topic that describes your problem.
- 4 Follow the instructions shown on the screen.

TO LOCATE ADDITIONAL INFORMATION FOR YOUR COMPUTER — See page 9.

Battery Problems



CAUTION: There is a danger of a new battery exploding if it is incorrectly installed. Replace the battery only with the same or equivalent type recommended by the manufacturer. Discard used batteries according to the manufacturer's instructions.



CAUTION: Before you begin any of the procedures in this section, follow the safety instructions located in the *Product Information Guide*.

REPLACE THE BATTERY — If you have to repeatedly reset time and date information after turning on the computer, or if an incorrect time or date displays during start-up, replace the battery (see page 86). If the battery still does not work properly, contact Dell (see page 90).

Drive Problems

Floppy drive problems

ENSURE THAT WINDOWS® RECOGNIZES THE DRIVE — Click the **Start** button and click **My Computer**. If the floppy drive is not listed, perform a full scan with your antivirus software to check for and remove viruses. Viruses can sometimes prevent Windows from recognizing the drive.

TEST THE DRIVE —

- Insert another disk to eliminate the possibility that the original floppy disk is defective.
- Insert a bootable floppy disk and reboot the computer.

ENSURE THAT THE DISK IS NOT FULL OR WRITE-PROTECTED — Ensure that the disk has available space and that it is not write-protected (locked). See the following figure.

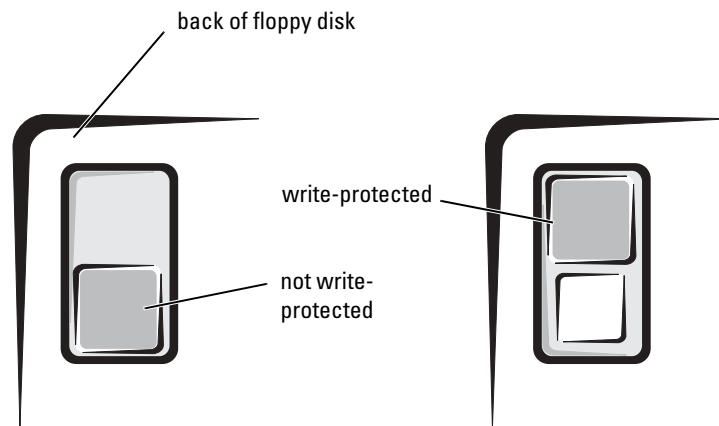

NOTICE: Do not attempt to clean drive heads with a swab. You may accidentally misalign the heads, which can render the drive inoperable.

CLEAN THE DRIVE — Use a commercially available cleaning kit.

CD drive problems

NOTE: High-speed CD drive vibration is normal and may cause noise, which does not indicate a defect in the drive or the CD.

ADJUST THE WINDOWS VOLUME CONTROL — Click the speaker icon in the lower-right corner of your screen.

- Ensure that the volume is turned up by clicking the slider and dragging it up.
- Ensure that the sound is not muted by clicking any boxes that are checked.

TEST THE DRIVE WITH ANOTHER CD — Insert another CD to eliminate the possibility that the original CD is defective.

CHECK THE SPEAKERS AND SUBWOOFER — See "Sound and Speaker Problems" on page 35.

ENSURE THAT WINDOWS RECOGNIZES THE DRIVE — Click the **Start** button and click **My Computer**. If the CD drive is not listed, perform a full scan with your antivirus software to check for and remove viruses. Viruses can sometimes prevent Windows from recognizing the drive.

CLEAN THE DISC — See the *Tell Me How* help file for instructions on cleaning your CDs. To access help files, see page 21.

Problems writing to a CD-RW drive

CLOSE OTHER PROGRAMS — The CD-RW drive must receive a steady stream of data when writing. If the stream is interrupted, an error occurs. Try closing all programs before writing to the CD-RW.

TURN OFF STANDBY MODE IN WINDOWS BEFORE WRITING TO A CD-RW DISC — For information on power conservation modes, see the *Tell Me How* help file or search for the keyword *standby* in Windows Help. To access help files, see page 21.

DVD drive problems



NOTE: Because of different regions worldwide and different disc formats, not all DVD titles work in all DVD drives.

TEST THE DRIVE WITH ANOTHER DVD — Insert another DVD to eliminate the possibility that the original DVD is defective.

ENSURE THAT WINDOWS RECOGNIZES THE DRIVE — Click the **Start** button and click **My Computer**. If the DVD drive is not listed, perform a full scan with your antivirus software to check for and remove viruses. Viruses can sometimes prevent Windows from recognizing the drive.

CLEAN THE DISC — See the *Tell Me How* help file for instructions on cleaning your DVDs. To access help files, see page 21.

CHECK FOR INTERRUPT REQUEST CONFLICTS — See page 49.

Hard drive problems

RUN CHECK DISK —

- 1 Click the **Start** button and click **My Computer**.
- 2 Right-click the drive letter (local disk) that you want to scan for errors, and then click **Properties**.
- 3 Click the **Tools** tab.
- 4 Under **Error-checking**, click **Check Now**.
- 5 Click **Start**.

E-Mail, Modem, and Internet Problems



NOTE: Connect the modem to an analog telephone jack only. The modem does not operate while it is connected to a digital telephone network.

CHECK THE TELEPHONE LINE CONNECTION — Verify that the telephone line is connected to the jack on the modem. (The jack has either a green label or a connector-shaped icon next to it.) Ensure that you hear a click when you insert the telephone line connector into the modem.

CHECK THE TELEPHONE JACK — Disconnect the telephone line from the modem and connect it to a telephone. Listen for a dial tone.

CONNECT THE MODEM DIRECTLY TO THE TELEPHONE WALL JACK — If you have other telephone devices sharing the line, such as an answering machine, fax machine, surge protector, or line splitter, then bypass them and use the telephone to connect the modem directly to the telephone wall jack.

USE A DIFFERENT TELEPHONE LINE — If you are using a line that is 3 m (10 ft) or more in length, try a shorter one.

RUN THE MODEM HELPER DIAGNOSTICS — Click the **Start** button, point to **All Programs**, and then click **Modem Helper**. Follow the instructions on the screen to identify and resolve modem problems. (Modem Helper is not available on all computers.)

VERIFY THAT THE MODEM IS COMMUNICATING WITH WINDOWS® —

- 1 Click the **Start** button and click **Control Panel**.
 - 2 Click **Printers and Other Hardware**.
 - 3 Click **Phone and Modem Options**.
 - 4 Click the **Modems** tab.
 - 5 Click the COM port for your modem.
 - 6 Click **Properties**, click the **Diagnostics** tab, and then click **Query Modem** to verify that the modem is communicating with Windows.
- If all commands receive responses, the modem is operating properly.

TURN OFF CALL WAITING (CATCH-PHONE) — See your telephone directory for instructions on deactivating this feature. Then adjust the dial-up networking connection properties.

- 1 Click the **Start** button and click **Control Panel**.
- 2 Click **Printers and Other Hardware**, and then click **Phone and Modem Options**.
- 3 Click your connection type to highlight it.
- 4 Click the **Dialing Rules** tab and click **Edit**.
- 5 Click the **To Disable Call Waiting** box to place a checkmark in it.
- 6 Select the disable code from the drop-down menu (for example, *70).
- 7 Click **Apply** and click **OK**.

ENSURE THAT YOU ARE CONNECTED TO THE INTERNET — With the Outlook Express e-mail program open, click **File**. If **Work Offline** has a checkmark next to it, click the checkmark to remove it and connect to the Internet.

ENSURE THAT YOU HAVE SUBSCRIBED TO AN INTERNET SERVICE PROVIDER — Contact an Internet service provider to subscribe.

CONTACT YOUR INTERNET SERVICE PROVIDER — Contact your Internet service provider for assistance.

Error Messages

If the message is not listed, see the documentation for the operating system or the program that was running when the message appeared.

A FILENAME CANNOT CONTAIN ANY OF THE FOLLOWING CHARACTERS: \ / : * ? " < > | — Do not use these characters in filenames.

A REQUIRED .DLL FILE WAS NOT FOUND — The program that you are trying to open is missing an essential file. To remove and then reinstall the program:

- 1 Click the **Start** button and click **Control Panel**.
- 2 Click **Add or Remove Programs**.
- 3 Select the program you want to remove.
- 4 Click the **Change or Remove Program** icon.
- 5 See the program documentation for installation instructions.

INSERT BOOTABLE MEDIA — The operating system is trying to boot to a nonbootable floppy disk or CD. Insert a bootable floppy disk or CD.

NON-SYSTEM DISK ERROR — A floppy disk is in the floppy drive. Remove the floppy disk and restart the computer.

NOT ENOUGH MEMORY OR RESOURCES. CLOSE SOME PROGRAMS AND TRY AGAIN — You have too many programs open. Close all windows and open the program that you want to use. In some cases, you might have to restart your computer to restore computer resources. If so, run the program that you want to use first.

OPERATING SYSTEM NOT FOUND — Contact Dell (see page 90).

THE FILE BEING COPIED IS TOO LARGE FOR THE DESTINATION DRIVE — The file that you are trying to copy is too large to fit on the disk. Try copying the file to a blank disk or using a larger-capacity disk.

⌵ IS NOT ACCESSIBLE. THE DEVICE IS NOT READY — The floppy drive cannot read the disk. Insert a floppy disk into the drive and try again.

General Problems

The computer stops responding

TURN THE COMPUTER OFF — If your computer locks up and you are unable to get a response by pressing a key on your keyboard or moving your mouse, press and hold the power button for at least 8 to 10 seconds until the computer turns off. Then press the power button again to turn on the computer. You might lose data if you are unable to perform an operating system shutdown.

A program stops responding

END THE PROGRAM —

- 1 Press <Ctrl><Shift><Esc> simultaneously.
- 2 Click **Applications**.
- 3 Click the program that is no longer responding.
- 4 Click **End Task**.

A program crashes repeatedly



NOTE: Software usually includes installation instructions in its documentation or on a floppy disk or CD.

CHECK THE SOFTWARE DOCUMENTATION — Many software manufacturers maintain websites with information that may help you solve the problem. Ensure that you properly installed and configured the program. If necessary, uninstall and then reinstall the program.

A program is designed for an earlier Microsoft® Windows® operating system

RUN THE PROGRAM COMPATIBILITY WIZARD —

Windows XP provides a Program Compatibility Wizard that configures a program so it runs in an environment similar to non-Windows XP operating system environments.

- 1 Click the **Start** button, point to **All Programs**→**Accessories**, and then click **Program Compatibility Wizard**.
- 2 In the welcome screen, click **Next**.
- 3 Follow the instructions on the screen.

A solid blue screen appears

TURN THE COMPUTER OFF — If the computer does not respond to a keystroke or a proper shutdown, press the power button for at least 8 to 10 seconds until the computer turns off. Press the power button again to restart the computer. The chkdsk program automatically runs during the start-up process. Follow the instructions on the screen.

Other software problems

CHECK THE SOFTWARE DOCUMENTATION OR CONTACT THE SOFTWARE MANUFACTURER FOR TROUBLESHOOTING INFORMATION

BACK UP YOUR FILES IMMEDIATELY — If your computer has a CD-RW drive or a zip drive installed, see the drive's documentation for instructions.

ENSURE THAT YOU HAVE NOT MADE AN ERROR WHILE ENTERING DATA — See the program documentation to ensure that the values or characters you are entering are valid.

CHECK FOR VIRUSES — Use a virus-scanning program to check the hard drive, floppy disks, or CDs.

RESTART THE COMPUTER — Save and close any open files, exit any open programs, and then shut down your computer through the **Start** menu instead of by pressing the power button. Otherwise, you may lose data.

CHECK FOR COMPATIBILITY —

- Ensure that the program is compatible with the operating system installed on your computer and that your computer meets the minimum hardware requirements needed to run the software. See the software documentation for information.
- If necessary, uninstall and then reinstall the program.

ENSURE THAT YOU PROPERLY INSTALLED AND CONFIGURED THE PROGRAM — See the software documentation for information. If necessary, uninstall and then reinstall the program.

Other technical problems

GO TO THE DELL SUPPORT WEBSITE — Go to support.dell.com for help with general usage, installation, and troubleshooting questions. The support website offers several different tools to help you, such as Dell Forum—a chat room where you can communicate with other Dell customers about their computers and gain access to technical support through e-mail. See "Dell Technical Support Policy (U.S. Only)" on page 88 for a description of the hardware and software support provided by Dell.

CALL DELL — If you cannot solve your problem using the Dell Support website or e-mail service, call Dell for technical assistance (see page 90). See "Dell Technical Support Policy (U.S. Only)" on page 88 for a description of the hardware and software support provided by Dell.

General hardware problems

If your computer exhibits one or more of the following symptoms, a device conflict may exist:

- Your computer locks up, particularly while using a specific device.
- A recently added device does not work.
- A sound card emits noise or demonstrates other problems.

- Unintelligible characters print from the printer.
- The mouse pointer does not move or "stutters" when it moves.
- Messages appear stating that the computer is not operating at maximum performance.
- Errors occur and programs crash for no apparent reason.
- Nothing displays on the monitor.

REMOVE ANY RECENTLY ADDED HARDWARE TO SEE IF IT RESOLVES THE CONFLICT — If removing the hardware resolves the conflict, see the hardware documentation for configuration and troubleshooting instructions. If the problem persists, contact the hardware manufacturer for technical assistance.

CHECK YOUR OPERATING SYSTEM DOCUMENTATION FOR ADDITIONAL TROUBLESHOOTING INFORMATION

CHECK FOR INTERRUPT REQUEST CONFLICTS — See page 49.

IEEE 1394 Device Problems

 **NOTE:** Check Windows Explorer to see if your device is listed as a drive.

CHECK THE IEEE 1394 DEVICE — Ensure that the IEEE 1394 device is properly inserted into the connector.

ENSURE THAT THE IEEE 1394 DEVICE IS RECOGNIZED BY WINDOWS® —

- 1 Click the Start button.
- 2 Click Control Panel.
- 3 Click Printers and Other Hardware.

If your IEEE 1394 device is listed, Windows recognizes the device.

IF YOU HAVE PROBLEMS WITH A DELL-PROVIDED IEEE 1394 DEVICE — Contact Dell (see page 90).

IF YOU HAVE PROBLEMS WITH AN IEEE 1394 DEVICE NOT PROVIDED BY DELL — Contact the IEEE 1394 device manufacturer.

Keyboard Problems

RESTART THE COMPUTER —

- If the mouse is functioning, shut down the computer through the **Start** menu (see page 13). After the computer shuts down, press the power button to restart the computer.
- If the computer does not respond to a keystroke or the mouse, press the power button for at least 8 to 10 seconds until the computer turns off. Press the power button again to restart the computer.

CHECK THE KEYBOARD CABLE —

- Ensure that the keyboard cable is firmly connected to the computer.
- Shut down the computer (see page 13), reconnect the keyboard cable as shown on the setup diagram for your computer, and then restart the computer.
- Check the cable connector for bent or broken pins and for damaged or frayed cables. Straighten bent pins.
- Remove keyboard extension cables and connect the keyboard directly to the computer.

TEST THE KEYBOARD — Connect a properly working keyboard to the computer, and try using the keyboard. If the new keyboard works, the original keyboard is faulty.

CHECK FOR INTERRUPT REQUEST CONFLICTS — See page 49.

Mouse Problems

RESTART THE COMPUTER —

- 1 Simultaneously press <Ctrl><Esc> to display the **Start** menu.
- 2 Type u, press the keyboard arrow keys to highlight **Shut down** or **Turn Off**, and then press <Enter>.
- 3 After the computer turns off, press the power button to restart the computer.

IF YOU CONNECTED THE MOUSE BEFORE TURNING ON THE COMPUTER, RECONNECT THE MOUSE CABLE —

- 1 Simultaneously press <Ctrl><Esc> to display the **Start** menu.
- 2 Type u, press the keyboard arrow keys to highlight **Shut down** or **Turn Off**, and then press <Enter>.
- 3 After the computer turns off, reconnect the mouse cable as shown on the setup diagram for your computer.
- 4 Start the computer.

IF YOU CONNECTED THE MOUSE AFTER TURNING ON THE COMPUTER, REMOVE THE POWER CABLE, AND THEN RECONNECT THE MOUSE CABLE — If the mouse is connected after the power is turned on, the mouse appears to be nonfunctional. To make the mouse function properly:

- 1 While your computer is on, remove the power cable from the back of the computer.
- 2 Connect the mouse to the computer.
- 3 Reconnect the power cable.
- 4 Turn on your computer.

Pressing the power button does not clear the computer's settings and does not restore mouse functionality.

CHECK THE MOUSE CABLE —

- Check the cable connector for bent or broken pins and for damaged or frayed cables. Straighten bent pins.
- Ensure that the cable is firmly connected to the computer.

TEST THE MOUSE — Connect a properly working mouse to the computer, and try using the mouse. If the new mouse works, the original mouse was faulty.

CHECK THE MOUSE SETTINGS —

- 1 Click the Start button, click Control Panel, and then click Printers and Other Hardware.
- 2 Click Mouse.
- 3 Try adjusting the settings.

REINSTALL THE MOUSE DRIVER — See page 45.

CHECK FOR INTERRUPT REQUEST CONFLICTS — See page 49.

Network Problems

CHECK THE NETWORK CABLE CONNECTOR — Ensure that the network cable is connected as shown on page 14.

CHECK THE NETWORK LIGHTS ON THE BACK OF THE COMPUTER — No light indicates that no network communication exists. Replace the network cable.

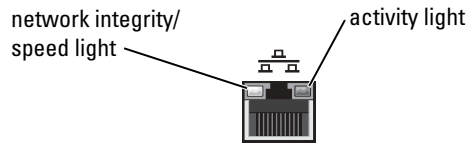

RESTART THE COMPUTER AND TRY TO LOG ON TO THE NETWORK AGAIN

CHECK YOUR NETWORK SETTINGS — Contact your network administrator or the person who set up your network to verify that your network settings are correct and that the network is functioning.

CHECK FOR INTERRUPT REQUEST CONFLICTS — See page 49.

Power Problems



CAUTION: Before you begin any of the procedures in this section, follow the safety instructions located in the *Product Information Guide*.

ADJUST THE POWER PROPERTIES — Your computer may be in standby or hibernate mode. For information on power conservation modes, see the *Tell Me How* help file, or search for the keyword *standby* or *hibernate* in Windows® Help. To access help files, see page 21.

IF THE POWER LIGHT IS BLINKING GREEN — The computer is in standby mode. Press a key on the keyboard or move the mouse to resume normal operation.

IF THE POWER LIGHT IS OFF — The computer is either turned off or is not receiving power.

- Reseat the power cable into both the power connector on the back of the computer and the electrical outlet.
- If the computer is plugged into a power strip, ensure that the power strip is plugged into an electrical outlet and that the power strip is turned on.
- Ensure that the electrical outlet is working by testing it with another device, such as a lamp.
- Bypass power protection devices, power strips, and power extension cables to verify that the computer turns on.
- Ensure that the main power cable is securely connected to the system board.
- Ensure that the front panel cable is securely connected to the system board.
- If the problem persists, contact Dell (see page 90).

IF THE POWER LIGHT IS STEADY AMBER — The computer is receiving electrical power, but an internal power problem might exist.

- Ensure that the microprocessor power cable is securely connected to the system board.
- Remove and then reinstall the memory modules.
- Remove and then reinstall any cards.
- If the problem persists, contact Dell (see page 90).

IF THE POWER LIGHT IS BLINKING AMBER — A device might be malfunctioning or incorrectly installed.

- Ensure that the main power cable is securely connected to the system board.
- If the problem persists, contact Dell (see page 90).

ELIMINATE INTERFERENCE — Electrical appliances on the same circuit or operating near the computer can cause interference. Other causes of interference are:

- Power extension cables
- Keyboard and mouse extension cables
- Too many devices on a power strip
- Multiple power strips connected to the same electrical outlet

Printer Problems



NOTE: If you need technical assistance for your printer, call the printer's manufacturer. See the printer documentation for the correct phone number.

CHECK THE PRINTER DOCUMENTATION — See the printer documentation for setup and troubleshooting information.

ENSURE THAT THE PRINTER IS TURNED ON — See the printer documentation for power button information.

VERIFY THE PRINTER CABLE CONNECTIONS —

- See the printer documentation for cable connection information.
- Ensure that the printer cables are securely connected to the printer and the computer (see page 11).

TEST THE ELECTRICAL OUTLET — Ensure that the electrical outlet is working by testing it with another device, such as a lamp.

VERIFY THAT THE PRINTER IS RECOGNIZED BY WINDOWS® —

- 1 Click the **Start** button.
- 2 Click **Control Panel**.
- 3 Click **Printers and Other Hardware**.
- 4 Click **View installed printers or fax printers**.
If the printer is listed, right-click the printer icon.
- 5 Click **Properties**, and then select the **Ports** tab. For a parallel printer, ensure that the **Print to the following port(s)**: setting is **LPT1 (Printer Port)**. For a USB printer, ensure that the **Print to the following port(s)**: setting is **USB**.

REINSTALL THE PRINTER DRIVER — See the printer documentation for instructions.

Scanner Problems

 **NOTE:** Dell does not cover the scanner's warranty. If you need technical assistance for your scanner, call the scanner's manufacturer. See the scanner documentation for the correct phone number.

CHECK THE SCANNER DOCUMENTATION — See the scanner documentation for setup and troubleshooting information.

UNLOCK THE SCANNER — Ensure that your scanner is unlocked if it has a locking tab or button.

RESTART THE COMPUTER AND TRY THE SCANNER AGAIN

CHECK THE CABLE CONNECTIONS —

- If your scanner has a power cable, ensure that the power cable is firmly connected to a working electrical outlet and that the scanner is turned on.
- Ensure that the scanner cable is firmly connected to the computer and to the scanner.

VERIFY THAT THE SCANNER IS RECOGNIZED BY MICROSOFT® WINDOWS® —

- 1 Click the **Start** button and click **Control Panel**.
- 2 Click **Printers and Other Hardware**.
- 3 Click **Scanners and Cameras**.
If your scanner is listed, Windows recognizes the scanner.

REINSTALL THE SCANNER DRIVER — See the scanner documentation for instructions.

Sound and Speaker Problems

No sound from speakers

 **NOTE:** The volume control in some MP3 players overrides the Windows® volume setting. If you have been listening to MP3 songs, ensure that you did not turn the player volume down or off.

CHECK THE SPEAKER CABLE CONNECTIONS — Ensure that the speakers are connected as shown on the setup diagram supplied with the speakers. If you purchased a sound card, ensure that the speakers are connected to the card.

ENSURE THAT THE SUBWOOFER AND THE SPEAKERS ARE TURNED ON — See the setup diagram supplied with the speakers. If your speakers have volume controls, adjust the volume, bass, or treble to eliminate distortion.

ADJUST THE WINDOWS VOLUME CONTROL — Click or double-click the speaker icon in the lower-right corner of your screen. Ensure that the volume is turned up and that the sound is not muted.

DISCONNECT HEADPHONES FROM THE HEADPHONE CONNECTOR — Sound from the speakers is automatically disabled when headphones are connected to the computer's front-panel headphone connector.

TEST THE ELECTRICAL OUTLET — Ensure that the electrical outlet is working by testing it with another device, such as a lamp.

ENABLE DIGITAL MODE — Your speakers do not work if the CD drive is operating in analog mode. To enable digital mode:

- 1 Click the **Start** button, click **Control Panel**, and then click **Sounds, Speech, and Audio Devices**.
- 2 Click **Sounds and Audio Devices**.
- 3 Click the **Hardware** tab.
- 4 Double-click the name of your CD drive.
- 5 Click the **Properties** tab.
- 6 Check the **Enable digital CD audio for this CD-ROM device** box.

ELIMINATE POSSIBLE INTERFERENCE — Turn off nearby fans, fluorescent lights, or halogen lamps to check for interference.

RUN THE SPEAKER DIAGNOSTICS — Some speaker systems have self- diagnostics. See the speaker documentation for diagnostics instructions.

REINSTALL THE AUDIO (SOUND) DRIVER — See page 45.

CHECK FOR INTERRUPT REQUEST CONFLICTS — See page 49.

No sound from headphones

CHECK THE HEADPHONE CABLE CONNECTION — Ensure that the headphone cable is securely inserted into the headphone connector (see page 49).

DISABLE DIGITAL MODE — Your CD or DVD drive headphones do not work if the CD or DVD drive is operating in digital mode. To disable digital mode:

- 1 Click the **Start** button, click **Control Panel**, and then click **Sounds, Speech, and Audio Devices**.
- 2 Click **Sounds and Audio Devices**.
- 3 Click the **Hardware** tab.
- 4 Double-click the name of your CD drive.
- 5 Click the **Properties** tab.
- 6 Uncheck the **Enable digital CD audio for this CD-ROM device box**.

ADJUST THE WINDOWS VOLUME CONTROL — Click or double-click the speaker icon in the lower-right corner of your screen. Ensure that the volume is turned up and that the sound is not muted.

Video and Monitor Problems

If the screen is blank

 **NOTE:** See the monitor documentation for troubleshooting procedures.

CHECK THE MONITOR POWER LIGHT — If the power light is off, firmly press the button to ensure that the monitor is turned on. If the power light is lit or blinking, the monitor has power. If the power light is blinking, press a key on the keyboard or move the mouse.

CHECK THE MONITOR CABLE CONNECTION — Check the connector for bent or broken pins. (It is normal for monitor cable connectors to have missing pins.) Ensure that the video cable is connected as shown on the setup diagram for your computer.

TEST THE ELECTRICAL OUTLET — Ensure that the electrical outlet is working by testing it with another device, such as a lamp.

SWAP THE POWER CABLES — Swap the computer and monitor power cables to determine if the power cable is defective.

TEST THE VIDEO EXTENSION CABLE (IF USED) — If you are using a video extension cable and removing the cable solves the problem, the cable is defective.

TEST ANOTHER MONITOR — If another monitor is available, connect it to the computer.

CHECK THE DIAGNOSTIC LIGHTS — See page 44.

If the screen is difficult to read

CHECK THE MONITOR SETTINGS — See the monitor documentation for instructions on adjusting the contrast and brightness, demagnetizing (degaussing) the monitor, and running the monitor self-test.

MOVE THE SUBWOOFER AWAY FROM THE MONITOR — If your speaker system includes a subwoofer, ensure that the subwoofer is at least 60 cm (2 ft) away from the monitor.

MOVE THE MONITOR AWAY FROM EXTERNAL POWER SOURCES — Fans, fluorescent lights, halogen lamps, and other electrical devices can cause the screen image to appear "shaky." Turn off nearby devices to check for interference.

ROTATE THE MONITOR TO FACE A DIFFERENT DIRECTION — Eliminate sunlight glare, which can cause poor picture quality.

ADJUST THE WINDOWS® DISPLAY SETTINGS —

- 1 Click the Start button and click Control Panel.
- 2 Click Appearance and Themes.
- 3 Click Display and click the Settings tab.
- 4 Try different settings for Screen resolution and Color quality.

RESTORE THE RECOMMENDED SETTINGS — Restore the original resolution and refresh rate settings. See the *Tell Me How* help file for instructions. To access help files, see page 21.

Advanced Troubleshooting

Diagnostic Lights

To help you troubleshoot a problem, your computer is equipped with four lights on the back panel labeled "A," "B," "C," and "D" (see page 39). These lights can be yellow or green. When the computer starts normally, the lights flash. After the computer starts, the lights remain green. If the computer malfunctions, the color and sequence of the lights identify the problem.

 **CAUTION:** Before you begin any of the procedures in this section, follow the safety instructions located in the *Product Information Guide*.



Light Pattern	Problem Description	Suggested Resolution
 A B C D	The computer is in a normal off condition or a possible pre-BIOS failure has occurred.	Verify that the computer is plugged into a working electrical outlet and that you have pressed the power button.



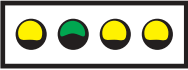

 = yellow



 = green

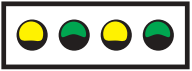

 = off



Light Pattern	Problem Description	Suggested Resolution
 <p>A B C D</p>	<p>Memory modules are detected, but a memory failure has occurred.</p>	<ul style="list-style-type: none"> • If you have one memory module installed, reinstall it (see page 75) and restart the computer. • If you have two or more memory modules installed, remove the modules, reinstall one module (see page 75), and then restart the computer. If the computer starts normally, reinstall an additional module. Continue until you have identified a faulty module or reinstalled all modules without error. • If available, install properly working memory of the same type into your computer (see page 75). • If the problem persists, contact Dell (see page 90).
 <p>A B C D</p>	<p>A possible expansion card failure has occurred.</p>	<ol style="list-style-type: none"> 1 Determine if a conflict exists by removing a card (not the video card) (see page 62) and then restarting the computer. 2 If the problem persists, reinstall the card that you removed, remove a different card, and then restart the computer. 3 Repeat this process for each card. If the computer starts normally, troubleshoot the last card removed from the computer for resource conflicts (see "Resolving Software and Hardware Incompatibilities" on page 49). 4 If the problem persists, contact Dell (see page 90).

-  = yellow
-  = green
-  = off

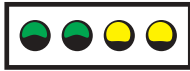

Light Pattern	Problem Description	Suggested Resolution
 <p>A B C D</p>	<p>A possible video card failure has occurred.</p>	<ul style="list-style-type: none"> • If the computer has a video card, remove the card and reinstall it (see page 62), and restart the computer. • If the problem still exists, install a video card that you know works and restart the computer. • If the problem persists or the computer has integrated video, contact Dell (see page 90).
 <p>A B C D</p>	<p>A possible floppy or hard drive failure has occurred.</p>	<p>Reseat all power and data cables and restart the computer.</p>
 <p>A B C D</p>	<p>A possible USB failure has occurred.</p>	<p>Reinstall all USB devices, check cable connections, and then restart the computer.</p>
 <p>A B C D</p>	<p>No memory modules are detected.</p>	<ul style="list-style-type: none"> • Reinstall all memory modules (see page 75) and restart the computer. • To eliminate the possibility of a faulty memory connector, remove all memory modules (see page 75), reinstall one memory module (if the computer supports a single module), and then restart the computer. If the computer starts normally, move the memory module to a different connector and restart the computer. Continue until you have identified a faulty connector or reinstalled all modules without error.

-  = yellow
-  = green
-  = off

Light Pattern	Problem Description	Suggested Resolution
 <p>A B C D</p>	Memory modules are detected, but a memory configuration or compatibility error exists.	<ul style="list-style-type: none"> • Ensure that there are no special memory module/memory connector placement requirements (see page 75). • Verify that the memory modules that you are installing are compatible with your computer (see page 75). • If the problem persists, contact Dell (see page 90).
 <p>A B C D</p>	A possible expansion card failure has occurred.	<ol style="list-style-type: none"> 1 Determine if a conflict exists by removing a card and then restarting the computer. 2 If the problem persists, reinstall the cards that you removed, remove a different card, and then restart the computer. 3 Repeat this process for each card. If the computer starts normally, troubleshoot the last card removed from the computer for resource conflicts (see "Resolving Software and Hardware Incompatibilities" on page 49). 4 If the problem persists, contact Dell (see page 90).
 <p>A B C D</p>	Other failure has occurred.	<ul style="list-style-type: none"> • Ensure that the cables are properly connected from the hard drive, CD drive, and DVD drive to the system board (see page 70). • If the problem persists, contact Dell (see page 90).

-  = yellow
-  = green
-  = off

Light Pattern	Problem Description	Suggested Resolution
 A B C D	The computer is in a normal operating condition after POST.	None.

-  = yellow
-  = green
-  = off

Dell Diagnostics

If you experience a problem with your computer, perform the checks in "Solving Problems" (see page 19) and run the Dell Diagnostics before you contact Dell for technical assistance. Running the Dell Diagnostics may help you resolve the problem without contacting Dell. If you do contact Dell, the test results can provide important information for Dell's service and support personnel.

The Dell Diagnostics allows you to:

- Perform express, extended, or custom tests on one or all devices
- Select tests based on a symptom of the problem you are having
- Choose how many times a test is run
- Display test results
- Suspend testing if an error is detected
- Access online help information that describes the tests and devices
- Receive status messages that tell you whether tests completed successfully
- Receive error messages if problems are detected

Starting the Dell Diagnostics

 **NOTICE:** Only use the Dell Diagnostics to test your Dell™ computer. Using this program with other computers can result in error messages.

- 1 Shut down and restart the computer.
- 2 When the DELL™ logo appears, press <F12> immediately.
- 3 If you wait too long and the Microsoft® Windows® logo appears, continue to wait until you see the Windows desktop. Then shut down your computer through the **Start** menu and try again.
- 4 When the boot device list appears, highlight **Boot to Utility Partition** and press <Enter>.
- 5 When the Dell Diagnostics Main Menu appears, select the test you want to run (see page 44).

Dell Diagnostics Main Menu

- 1 After the Dell Diagnostics loads and the **Main Menu** screen appears, click the button for the option you want.

 **NOTE:** The Service Tag for your computer is located at the top of each test screen.

Option	Function
Express Test	Performs a quick test of devices. This test typically takes 10 to 20 minutes and requires no interaction on your part. Run Express Test first to increase the possibility of tracing the problem quickly.
Extended Test	Performs a thorough check of devices. This test typically takes an hour or more and requires you to answer questions periodically.
Custom Test	Tests a specific device. You can customize the tests you want to run.
Symptom Tree	Lists the most common symptoms encountered and allows you to select a test based on the symptom of the problem you are having.

- 2 If a problem is encountered during a test, a message displaying the error code and a description of the problem appear. Write down the error code and problem description and follow the instructions on the screen.
If you cannot resolve the error condition, contact Dell (see page 90).
- 3 If you run a test from the **Custom Test** or **Symptom Tree** option, click the applicable tab described in the following table for more information.

Tab	Function
Results	Displays the results of the test and any error conditions encountered.
Errors	Displays error conditions encountered, error codes, and problem description.
Help	Describes the test and may indicate requirements for running the test.
Configuration	Displays your hardware configuration for the selected device. The Dell Diagnostics obtains your configuration information for all devices from system setup, memory, and various internal tests and displays it in the device list in the left pane of the screen. The device list may not display the names of all the components installed on your computer or all devices attached to your computer.
Parameters	Allows you to customize the test by changing the test settings.

- 4 Close the test screen to return to the **Main Menu** screen. To exit the Dell Diagnostics and restart the computer, close the **Main Menu** screen.

Drivers

What Is a Driver?

A driver is a program that controls a device such as a printer, mouse, or keyboard. All devices require a driver program.

A driver acts like a translator between the device and any other programs that use the device. Each device has its own set of specialized commands that only its driver recognizes.

Dell ships your computer to you with required drivers already installed—no further installation or configuration is needed.

Many drivers, such as the keyboard driver, come with your Microsoft® Windows® operating system. You may need to install drivers if you:

- Upgrade your operating system.
- Reinstall your operating system.
- Connect or install a new device.

Identifying Drivers

If you experience a problem with any device, identify whether the driver is the source of your problem and, if necessary, update the driver.

Windows XP

- 1 Click the **Start** button and click **Control Panel**.
- 2 Under **Pick a Category**, click **Performance and Maintenance**.
- 3 Click **System**.
- 4 In the **System Properties** window, click the **Hardware** tab.
- 5 Click **Device Manager**.
- 6 Scroll down the list to see if any device has an exclamation point (a yellow circle with a [!]) on the device icon.

If an exclamation point is next to the device name, you may need to reinstall the driver or install a new driver (see page 45).

Reinstalling Drivers



NOTICE: The Dell Support website at support.dell.com provides approved drivers for Dell™ computers. If you install drivers obtained from other sources, your computer might not work correctly.

Using Windows XP Device Driver Rollback

If a problem occurs on your computer after you install or update a driver, use Windows XP Device Driver Rollback to replace the driver with the previously installed version.

- 1 Click the **Start** button and click **Control Panel**.
- 2 Under **Pick a Category**, click **Performance and Maintenance**.
- 3 Click **System**.
- 4 In the **System Properties** window, click the **Hardware** tab.
- 5 Click **Device Manager**.
- 6 Right-click the device for which the new driver was installed and click **Properties**.
- 7 Click the **Drivers** tab.
- 8 Click **Roll Back Driver**.

If Device Driver Rollback does not resolve the problem, then use System Restore to return your computer to the operating state that existed before you installed the new driver.

Manually Reinstalling Drivers

- 1 After copying the required driver files to your hard drive, click the **Start** button and right-click **My Computer**.
- 2 Click **Properties**.
- 3 Click the **Hardware** tab and click **Device Manager**.
- 4 Double-click the type of device for which you are installing the driver.
- 5 Double-click the name of the device for which you are installing the driver.
- 6 Click the **Driver** tab and click **Update Driver**.
- 7 Click **Install from a list or specific location (Advanced)** and click **Next**.
- 8 Click **Browse** and browse to the location to which you previously extracted the driver files.
- 9 When the name of the appropriate driver appears, click **Next**.
- 10 Click **Finish** and restart your computer.

Restoring Your Operating System

You can restore your operating system in the following ways:

- Microsoft Windows XP System Restore returns your computer to an earlier operating state without affecting data files.
- Dell PC Restore by Symantec restores your hard drive to the operating state it was in when you purchased the computer. Dell PC Restore permanently deletes all data on the hard drive and removes any applications installed after you received the computer.

Using Microsoft Windows XP System Restore

The Microsoft Windows XP operating system provides System Restore to allow you to return your computer to an earlier operating state (without affecting data files) if changes to the hardware, software, or other system settings have left the computer in an undesirable operating state. See the Windows Help and Support Center for information on using System Restore. To access help, see page 10.

 **NOTICE:** Make regular backups of your data files. System Restore does not monitor your data files or recover them.

 **NOTE:** The procedures in this document were written for the Windows default view, so they may not work if you set your Dell™ computer to the Windows Classic view.

Creating a Restore Point

- 1 Click the **Start** button and click **Help and Support**.
- 2 Click **System Restore**.
- 3 Follow the instructions on the screen.

Restoring the Computer to an Earlier Operating State

If problems occur after you install a device driver, use Device Driver Rollback (see page 47) to resolve the problem. If that is unsuccessful, then use System Restore.

 **NOTICE:** Before you restore the computer to an earlier operating state, save and close any open files and exit any open programs. Do not alter, open, or delete any files or programs until the system restoration is complete.

- 1 Click the **Start** button, point to **All Programs**→**Accessories**→**System Tools**, and then click **System Restore**.
- 2 Ensure that **Restore my computer to an earlier time** is selected and click **Next**.
- 3 Click a calendar date to which you want to restore your computer.

The **Select a Restore Point** screen provides a calendar that allows you to see and select restore points. All calendar dates with available restore points appear in boldface type.

- 4 Select a restore point and click **Next**.
If a calendar date has only one restore point, then that restore point is automatically selected. If two or more restore points are available, click the restore point that you prefer.
- 5 Click **Next**.

The **Restoration Complete** screen appears after System Restore finishes collecting data and then the computer restarts.

- 6 After the computer restarts, click **OK**.

To change the restore point, you can either repeat the steps using a different restore point, or you can undo the restoration.

Undoing the Last System Restore

 **NOTICE:** Before you undo the last system restore, save and close all open files and exit any open programs. Do not alter, open, or delete any files or programs until the system restoration is complete.

- 1 Click the **Start** button, point to **All Programs**→**Accessories**→**System Tools**, and then click **System Restore**.
- 2 Click **Undo my last restoration** and click **Next**.

Using Dell PC Restore by Symantec

Use Dell PC Restore by Symantec only as the last method to restore your operating system. PC Restore restores your hard drive to the operating state it was in when you purchased the computer. Any programs or files added since you received your computer—including data files—are permanently deleted from the hard drive. Data files include documents, spreadsheets, e-mail messages, digital photos, music files, and so on. If possible, back up all data before using PC Restore.

 **NOTICE:** Using PC Restore permanently deletes all data on the hard drive and removes any applications or drivers installed after you received your computer. If possible, back up the data before using PC Restore.

To use PC Restore:

- 1 Turn on the computer.
During the boot process, a blue bar with **www.dell.com** appears at the top of the screen.
- 2 Immediately upon seeing the blue bar, press <Ctrl><F11>.
If you do not press <Ctrl><F11> in time, let the computer finish restarting, and then restart the computer again.

 **NOTICE:** If you do not want to proceed with PC Restore, click **Reboot** in the following step.

- 3 On the next screen that appears, click **Restore**.
- 4 On the next screen, click **Confirm**.
The restore process takes approximately 6–10 minutes to complete.
- 5 When prompted, click **Finish** to reboot the computer.

 **NOTE:** Do not manually shut down the computer. Click **Finish** and let the computer completely reboot.

- 6 When prompted, click **Yes**.
The computer restarts. Because the computer is restored to its original operating state, the screens that appear, such as the End User License Agreement, are the same ones that appeared the first time the computer was turned on.

- 7 Click **Next**.

The **System Restore** screen appears and the computer restarts.

- 8 After the computer restarts, click **OK**.

Enabling System Restore

If you reinstall Windows XP with less than 200 MB of free hard-disk space available, System Restore is automatically disabled. To see if System Restore is enabled:

- 1 Click the **Start** button and click **Control Panel**.
- 2 Click **Performance and Maintenance**.
- 3 Click **System**.
- 4 Click the **System Restore** tab.
- 5 Ensure that **Turn off System Restore** is unchecked.

Resolving Software and Hardware Incompatibilities

Windows XP IRQ conflicts occur if a device either is not detected during the operating system setup or is detected but incorrectly configured.

To check for conflicts on a computer running Windows XP:

- 1 Click the **Start** button and click **Control Panel**.
- 2 Click **Performance and Maintenance** and click **System**.
- 3 Click the **Hardware** tab and click **Device Manager**.
- 4 In the **Device Manager** list, check for conflicts with the other devices.
Conflicts are indicated by a yellow exclamation point (!) beside the conflicting device or a red x if the device has been disabled.
- 5 Double-click any conflict to display the **Properties** window.
If an IRQ conflict exists, the **Device** status area in the **Properties** window reports the cards or devices that share the device's IRQ.
- 6 Resolve conflicts by reconfiguring the devices or removing the devices from the **Device Manager**.

To use the Windows XP Hardware Troubleshooter:

- 1 Click the **Start** button and click **Help and Support**.
- 2 Type `hardware troubleshooter` in the **Search** field and click the arrow to start the search.
- 3 Click **Hardware Troubleshooter** in the **Search Results** list.
- 4 In the **Hardware Troubleshooter** list, click **I need to resolve a hardware conflict on my computer**, and click **Next**.

Adding Parts

Front and Back View of the Computer

Front View

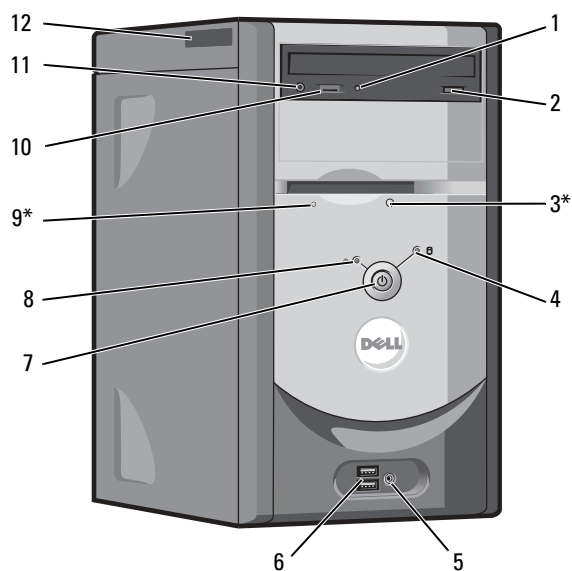

*On computers with an optional floppy drive.

1	CD or DVD drive activity light	The drive activity light is on when the computer reads data from the CD or DVD drive.
2	CD or DVD eject button	Press to eject your CD from the CD or DVD drive.
3	floppy-drive eject button	Press to eject a disk from the floppy drive. (On computers with an optional floppy drive.)
4	hard-drive activity light	The hard-drive light is on when the computer reads data from or writes data to the hard drive. The light might also be on when a device such as your CD player is operating.
5	headphone connector	Use the headphone connector to attach headphones and most speakers for listening to all sounds in your computer, including your CD player and system sounds such as beeps.
6	USB 2.0 connectors (2)	Use the front USB connectors for devices that you connect occasionally, such as joysticks or cameras. It is recommended that you use the back USB connectors for devices that typically remain connected, such as printers and keyboards.
7	power button	Press to turn on the computer.  NOTICE: To avoid losing data, do not use the power button to turn off the computer. Instead, perform an operating system shutdown.
8	power light	The power light illuminates and blinks or remains solid to indicate different states. For more information, see page 32.
9	floppy-drive activity light	The floppy-drive light is on when the computer reads data from or writes data to the floppy drive. Wait until this light turns off before you remove the floppy disk from the drive. (On computers with an optional floppy drive.)
10	CD or DVD volume control dial	Move the dial to adjust the volume of your CD or DVD disc.
11	CD or DVD headphone connector	Use the headphone connector to attach headphones to the CD or DVD drive. Your headphones will not work if the drive is operating in digital mode. To disable digital mode, see "No sound from headphones" on page 36.
12	Service Tag	The tag is used to identify your computer when you access the Dell Support website or call technical support.

Back View

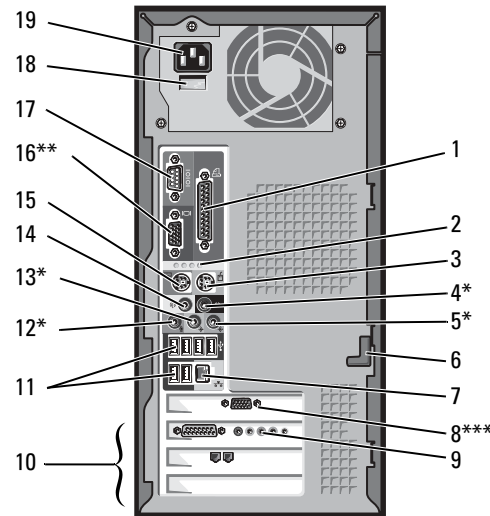



*On computers with integrated sound.

**On computers with integrated video.

***On computers with a video card.

1	parallel connector	Connect a parallel device, such as a printer, to the parallel connector. If you have a USB printer, plug it into a USB connector.
2	diagnostic lights (4)	Use the lights to help you troubleshoot a computer problem based on the diagnostic code. For more information, see "Diagnostic lights" on page 39.
3	mouse connector	Plug a standard mouse into the green mouse connector. Turn off the computer and any attached devices before you connect a mouse to the computer. If you have a USB mouse, plug it into a USB connector.
4	surround connector	Use the black surround connector (available on computers with integrated sound) to attach multichannel-capable speakers. (On computers with a sound card, use the connector on the card.)
5	line-in connector	Use the blue line-in connector (available on computers with integrated sound) to attach a record/playback device such as a cassette player, CD player, or VCR. (On computers with a sound card, use the connector on the card.)
6	cover latch	Releases the cover from the computer.

7	network adapter connector	<p>To attach your computer to a network or modem, connect one end of a network cable to either a network jack or your network device. Connect the other end of the network cable to the network adapter connector on the back panel of your computer. A click indicates that the network cable has been securely attached.</p> <p>On computers with a network connector card, use the connector on the card.</p> <p>It is recommended that you use Category 5 wiring and connectors for your network. If you must use Category 3 wiring, force the network speed to 10 Mbps to ensure reliable operation.</p> <div style="display: flex; justify-content: space-around; align-items: center;"> <div style="text-align: center;">  <p>network jack</p> </div> <div style="text-align: center;">  <p>modem jack</p> </div> </div>
8	video connector	<p>Plug the cable from your monitor into the blue connector. (On computers with a video card.)</p>
9	optional sound card connector	<p>If you purchased the optional sound card, plug your sound equipment (speakers, microphone, and so on) into the appropriate sound card connectors.</p>
10	card slots (3)	<p>Access connectors for any installed PCI cards.</p>
11	USB 2.0 connectors (6)	<p>Use the back USB connectors for devices that typically remain connected, such as printers and keyboards.</p> <p>It is recommended that you use the front USB connectors for devices that you connect occasionally, such as joysticks or cameras.</p>
12	microphone connector	<p>Use the pink microphone connector (available on computers with integrated sound) to attach a personal computer microphone for voice or musical input into a sound or telephony program.</p> <p>(On computers with a sound card, the microphone connector is on the card.)</p>
13	line-out connector	<p>Use the green line-out connector (available on computers with integrated sound) to attach headphones and most speakers with integrated amplifiers.</p> <p>(On computers with a sound card, use the connector on the card.)</p>
14	center/LFE connector	<p>Use the yellow center/Low-Frequency Effects (LFE) connector (available on computers with integrated sound) to attach your subwoofer.</p> <p>(On computers with a sound card, use the connector on the card.)</p>
15	keyboard connector	<p>If you have a standard keyboard, plug it into the purple keyboard connector. If you have a USB keyboard, plug it into a USB connector.</p>

16	integrated video connector	If this connector has a protective cap over it, then your computer has the optional video card installed. If this connector does not have a protective cap over it, plug the cable from your monitor into the blue connector. (On computers with integrated video.)
17	serial connector	Connect a serial device, such as a handheld device, to the serial port.
18	voltage selection switch (may not be available on all computers)	For more information, see the safety instructions located in the <i>Project Information Guide</i> .
19	power connector	Insert the power cable.

Removing the Computer Cover



CAUTION: Before you begin any of the procedures in this section, follow the safety instructions located in the *Product Information Guide*.

- 1 Shut down the computer through the **Start** menu (see page 18).
- 2 Ensure that your computer and attached devices are turned off. If your computer and attached devices did not automatically turn off when you shut down your computer, turn them off now.



NOTICE: To disconnect a network cable, first unplug the cable from your computer and then unplug it from the network wall jack.

- 3 Disconnect any telephone or telecommunication lines from the computer.
- 4 Disconnect your computer and all attached devices from their electrical outlets, and then press the power button to ground the system board.



CAUTION: To guard against electrical shock, always unplug your computer from the electrical outlet before opening the cover.

- 5 Lay your computer on its side with the computer cover facing up.
- 6 If your computer cover has a cover latch, slide and hold the cover latch.
- 7 Grip the indents on the computer cover, and slide the computer cover toward the back of the computer.

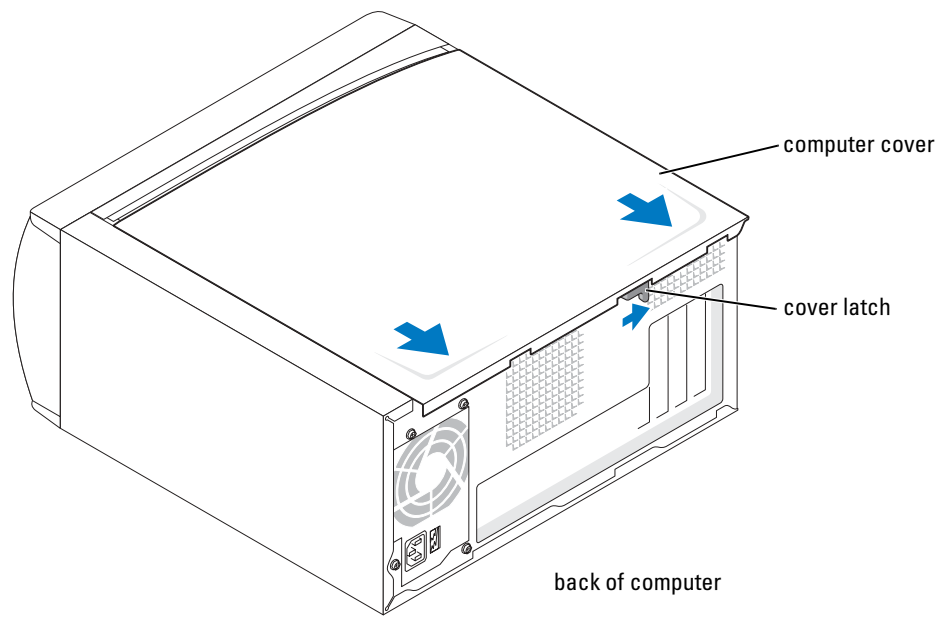

- 8 Place the computer cover on a level surface.

Looking Inside Your Computer

⚠ CAUTION: Before you begin any of the procedures in this section, follow the safety instructions located in the *Product Information Guide*.

⚠ CAUTION: To guard against electrical shock, always unplug your computer from the electrical outlet before opening the computer cover.

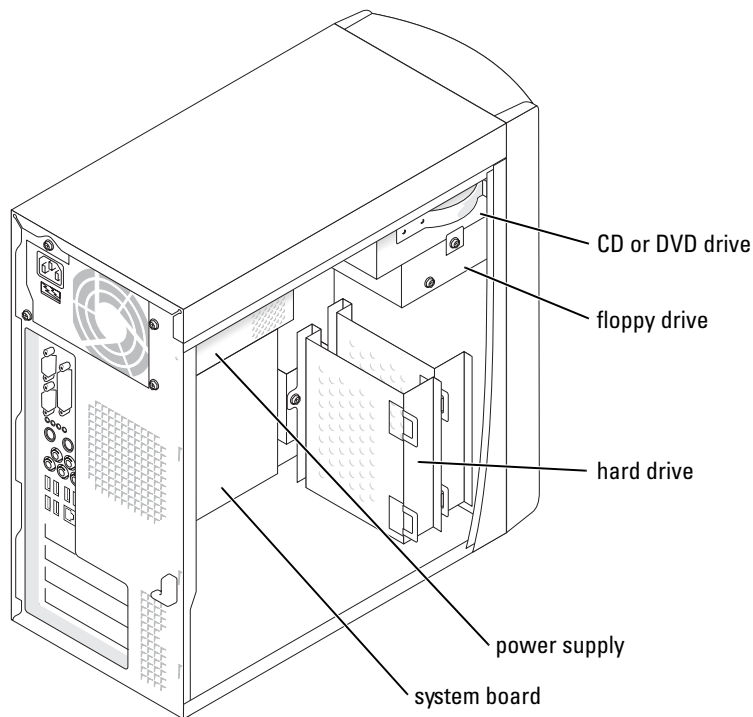

System Board

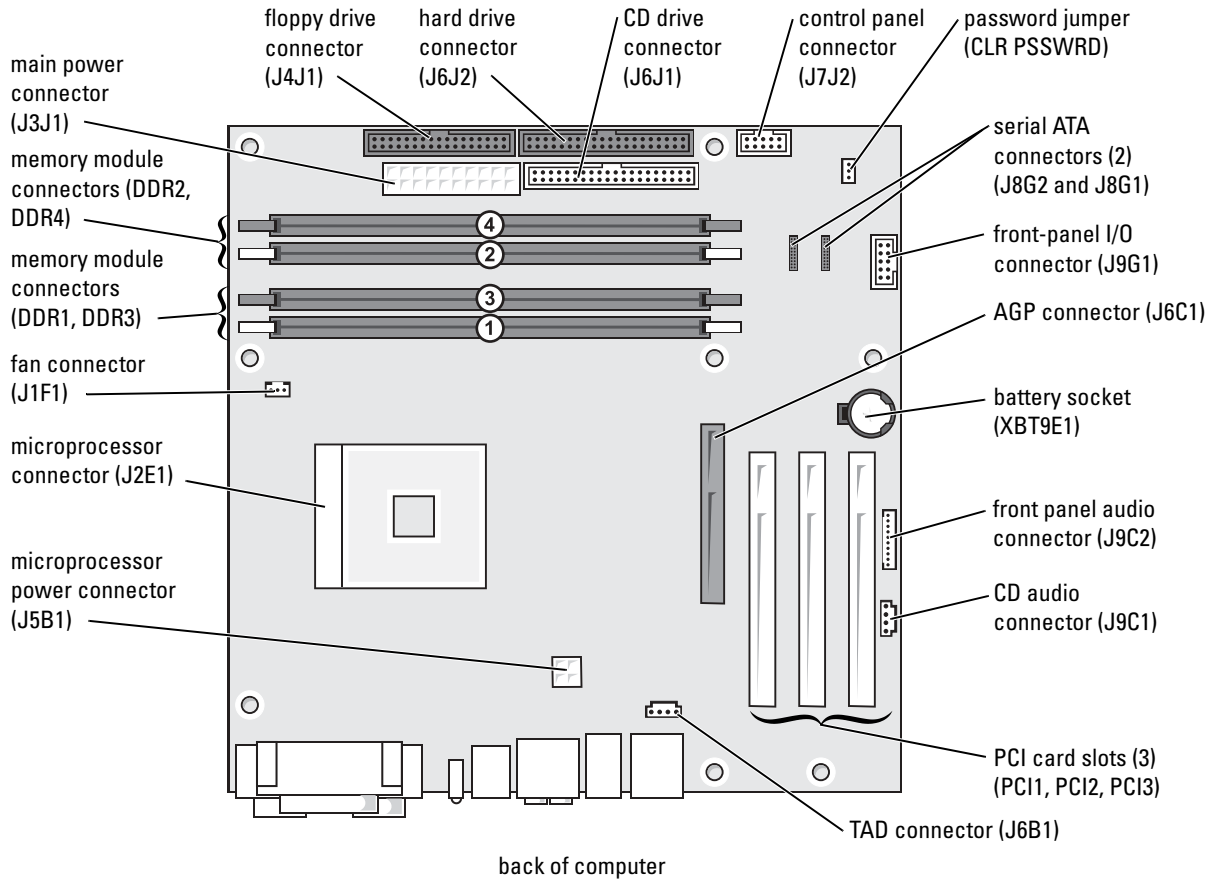

Adding Cards

⚠ CAUTION: Before you begin any of the procedures in this section, follow the safety instructions located in the *Product Information Guide*.

- 1 Shut down the computer through the **Start** menu (see page 18).
- 2 Ensure that your computer and attached devices are turned off. If your computer and attached devices did not automatically turn off when you shut down your computer, turn them off now.

🔄 NOTICE: To disconnect a network cable, first unplug the cable from your computer and then unplug it from the network wall jack.

- 3 Disconnect any telephone or telecommunication lines from the computer.
- 4 Disconnect your computer and all attached devices from their electrical outlets, and then press the power button to ground the system board.

⚠ CAUTION: To guard against electrical shock, always unplug your computer from the electrical outlet before opening the cover.

- 5 Remove the computer cover (see page 55).
- 6 Lay the computer on its side so that the system board is on the bottom of the inside of the computer.
- 7 Unscrew and remove the filler bracket for the card slot you want to use.

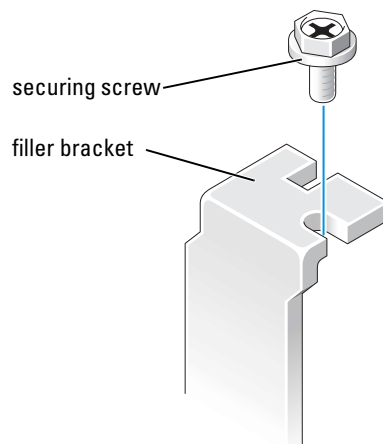

⚠ CAUTION: Some network adapters automatically start the computer when they are connected to a network. To guard against electrical shock, be sure to unplug your computer from its electrical outlet before installing any cards.

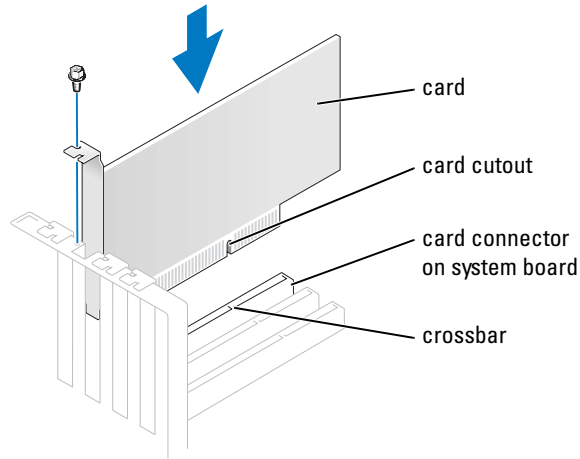

- 8 Align the cutout on the bottom of the card with the crossbar in the system board connector. Gently rock the card into the connector until it is fully seated.

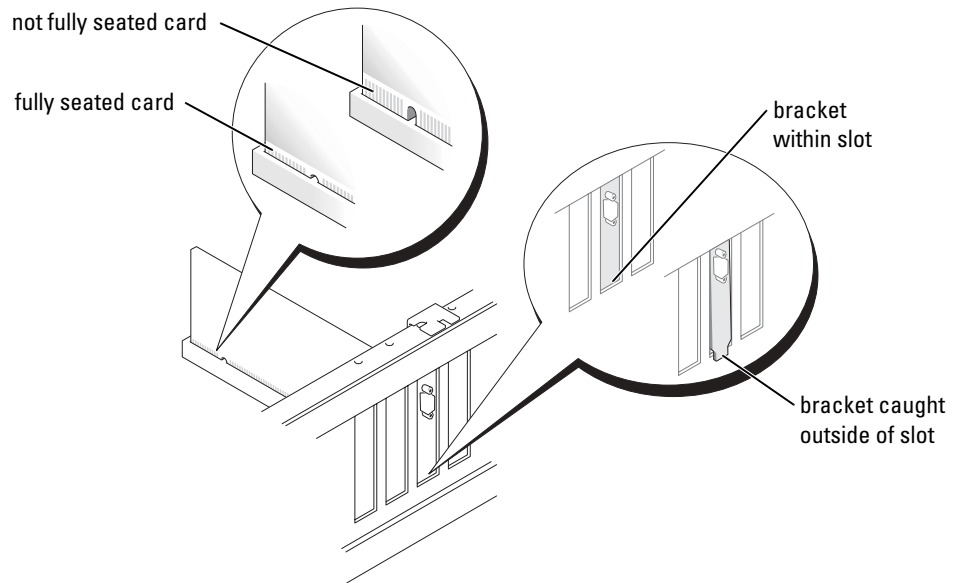

Ensure that the card is fully seated and that its bracket is within the card slot.



- 9 Secure the filler bracket onto the end of the card with the screw you removed in step 7.

- 10 Connect any cables that should be attached to the card.
See the documentation for the card for information about the card's cable connections.
-  **NOTICE:** Do not route card cables over or behind the cards. Cables routed over the cards can cause damage to the equipment.
- 11 Replace the computer cover (see page 78).
-  **NOTICE:** To connect a network cable, first plug the cable into the network wall jack and then plug it into the computer.
- 12 Connect your computer and devices to electrical outlets, and turn them on.
- 13 Install any drivers required for the card as described in the card documentation.

Adding or Replacing the AGP Card



CAUTION: Before you begin any of the procedures in this section, follow the safety instructions located in the *Product Information Guide*.

Your Dell™ computer provides a connector for an AGP card.

- 1 Shut down the computer through the **Start** menu (see page 18).
- 2 Ensure that your computer and attached devices are turned off. If your computer and attached devices did not automatically turn off when you shut down your computer, turn them off now.



NOTICE: To disconnect a network cable, first unplug the cable from your computer and then unplug it from the network wall jack.

- 3 Disconnect any telephone or telecommunication lines from the computer.
- 4 Disconnect your computer and all attached devices from their electrical outlets, and then press the power button to ground the system board.



CAUTION: To guard against electrical shock, always unplug your computer from the electrical outlet before opening the cover.

- 5 Remove the computer cover (see page 55).
- 6 Lay the computer on its side so that the system board is on the bottom of the inside of the computer.

Removing an AGP Card

- 1 Press the card lever toward the PCI connector.
- 2 Pull the card up and out of the card clip.

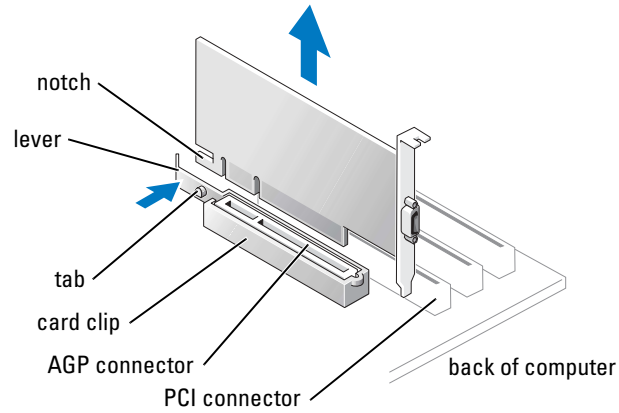

Installing an AGP Card

- 1 To add or replace the card, press the card lever toward the PCI connector and gently press the card into the AGP connector until it clicks into place.

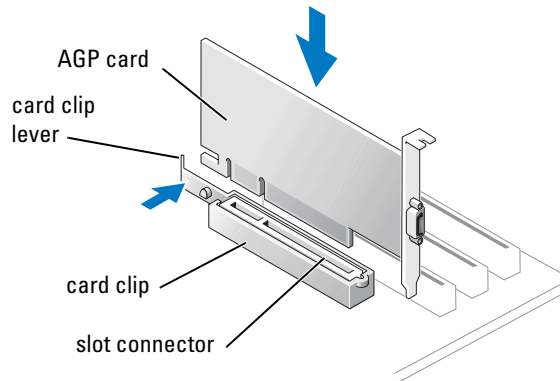

- 2 Release the card lever, ensuring that the tab fits into the notch on the front end of the card.
- 3 Secure the card with the securing screw.

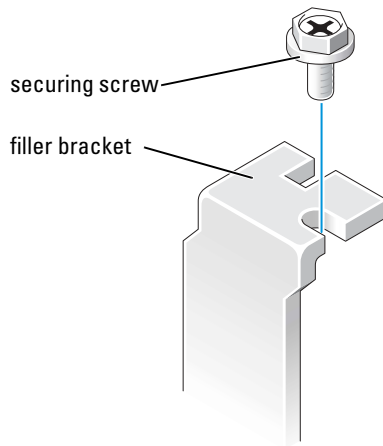

- 4 If your computer did not previously have an AGP card installed, move the monitor cable to the VGA connector on the new card.
- 5 Replace the computer cover (see page 78).
- ➡ **NOTICE:** To connect a network cable, first plug the cable into the network wall jack and then plug it into the computer.
- 6 Connect your computer and devices to electrical outlets, and turn them on.

Adding or Replacing a Second Hard Drive

- ⚠ **CAUTION:** Before you begin any of the procedures in this section, follow the safety instructions located in the *Product Information Guide*.
 - ⚠ **CAUTION:** To avoid damage to the drive, do not set it on a hard surface. Instead, set the drive on a soft surface, such as a foam pad, that will sufficiently cushion it.
- 1 Shut down the computer through the **Start** menu (see page 18).
 - 2 Ensure that your computer and attached devices are turned off. If your computer and attached devices did not automatically turn off when you shut down your computer, turn them off now.
- ➡ **NOTICE:** To disconnect a network cable, first unplug the cable from your computer and then unplug it from the network wall jack.
- 3 Disconnect any telephone or telecommunication lines from the computer.
 - 4 Disconnect your computer and all attached devices from their electrical outlets, and then press the power button to ground the system board.
- ⚠ **CAUTION:** To guard against electrical shock, always unplug your computer from the electrical outlet before opening the cover.

5 Remove the computer cover.

NOTICE: Before touching anything inside your computer, ground yourself by touching an unpainted metal surface, such as the metal at the back of the computer. While you work, periodically touch an unpainted metal surface to dissipate any static electricity that could harm internal components.

6 Remove the existing hard drive.

7 Remove the additional hard drive bracket from the computer:

- a Remove the bracket-securing screws for the additional drive.
- b Remove the bracket for the additional drive from the computer.

8 If you are replacing the additional hard drive, remove the drive from the bracket:

- a Remove the hard drive-securing screws.
- b Remove the hard drive from the bracket.

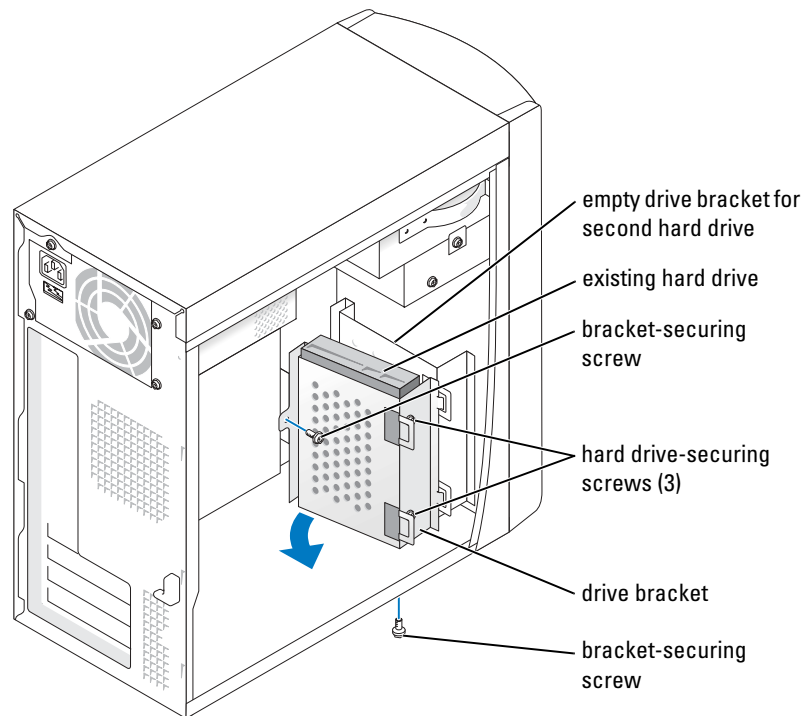

NOTICE: Ground yourself by touching an unpainted metal surface on the back of the computer.

NOTICE: When you unpack the drive, do not set it on a hard surface, which may damage the drive. Instead, set the drive on a soft surface, such as a foam pad, that will sufficiently cushion it.

- 9 Unpack the additional hard drive.
- 10 Check the jumper setting on the back of the second drive.
Ensure that the jumper setting on the new device is set for "cable select" (see the documentation that came with the drive for information).
- 11 Install the additional hard drive:
 - a Insert hard-drive securing screws.
 - b Place the two bracket tabs into the drive slots inside the computer's front panel.
 - c Swing the bracket forward so that it is flush with the computer's front panel.
 - d Replace the bracket-securing screws.

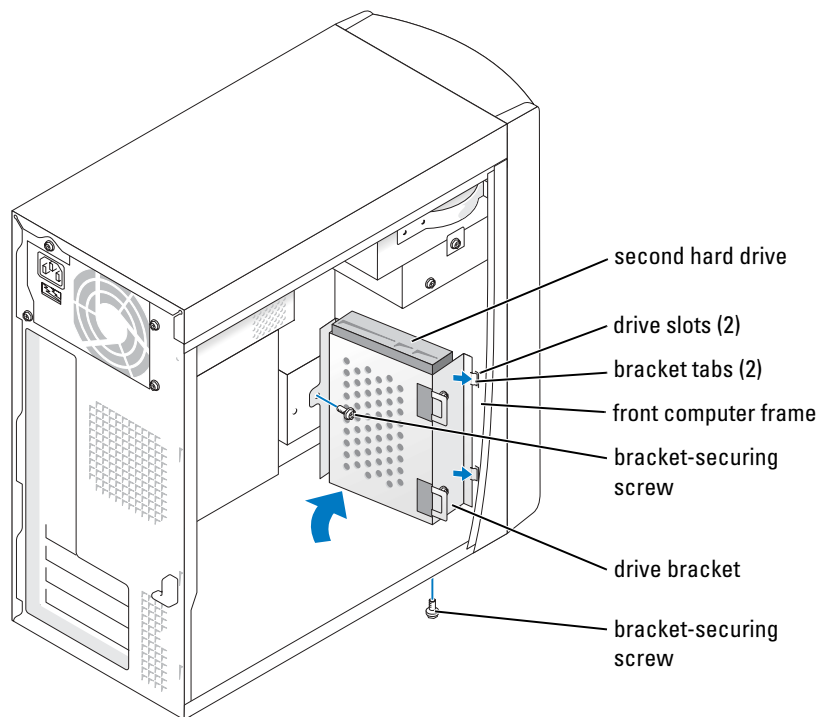

- 12 Reinstall the existing hard drive into the computer.
- ⚠ **CAUTION: Match the colored strip on the cable with pin 1 on the drive (pin 1 is marked as "1").**
- 13 Connect the power and data cables to the back of the drives.

14 Replace the computer cover.

 **NOTICE:** To connect a network cable, first plug the cable into the network wall jack and then plug it into the computer.

15 Connect your computer and devices to electrical outlets, and turn them on.

See the documentation that came with the drive for instructions on installing any software required for drive operation.

Adding a Floppy Drive

 **CAUTION:** Before you begin any of the procedures in this section, follow the safety instructions located in the *Product Information Guide*.

- 1 Shut down the computer through the **Start** menu (see page 18).
- 2 Ensure that your computer and attached devices are turned off. If your computer and attached devices did not automatically turn off when you shut down your computer, turn them off now.

 **NOTICE:** To disconnect a network cable, first unplug the cable from your computer and then unplug it from the network wall jack.

- 3 Disconnect any telephone or telecommunication lines from the computer.
- 4 Disconnect your computer and all attached devices from their electrical outlets, and then press the power button to ground the system board.

 **CAUTION:** To guard against electrical shock, always unplug your computer from the electrical outlet before opening the cover.

- 5 Remove the computer cover (see page 55).
- 6 Release and remove the front panel:
 - a Push the release lever to release the top tab.
 - b Reach inside the computer and push the bottom tab towards you to release it (the middle tab releases automatically).
 - c Rotate the front panel to separate it from the side hinges.

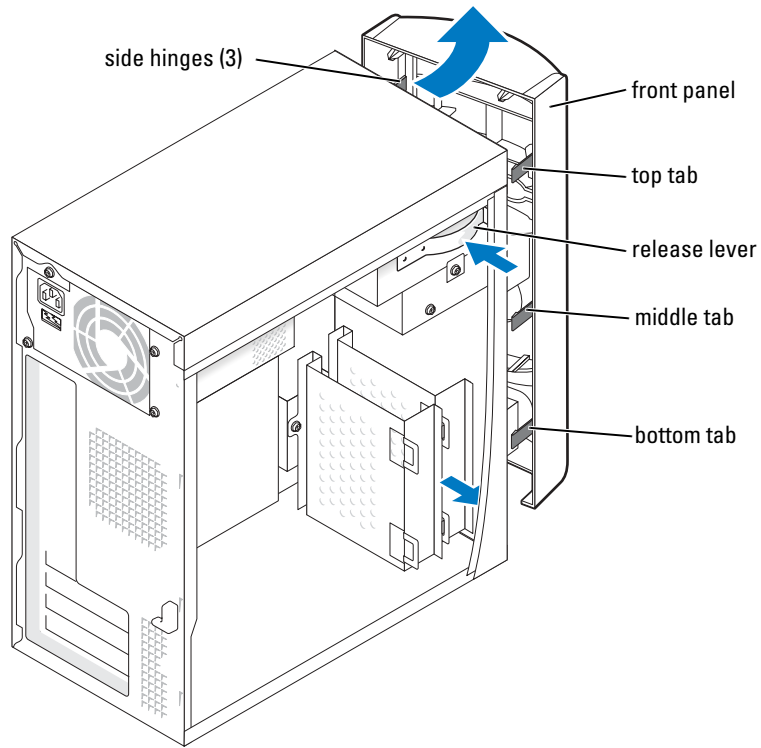

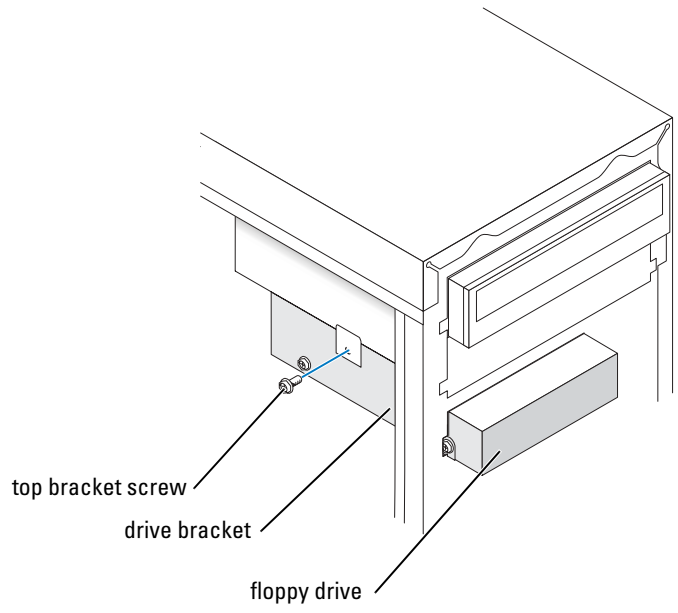
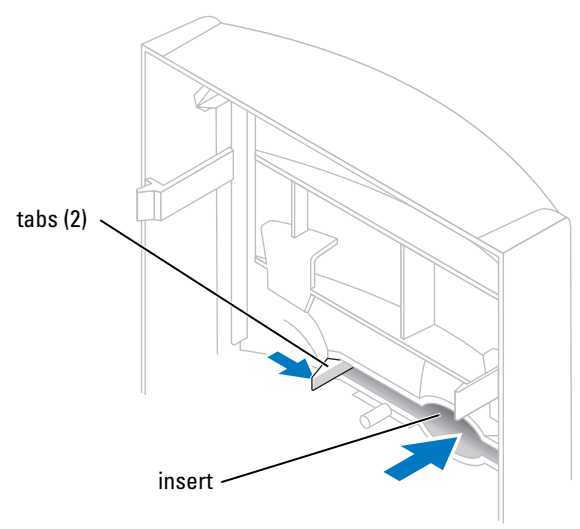

7 Press in the two insert tabs, and then push out the front-panel insert.

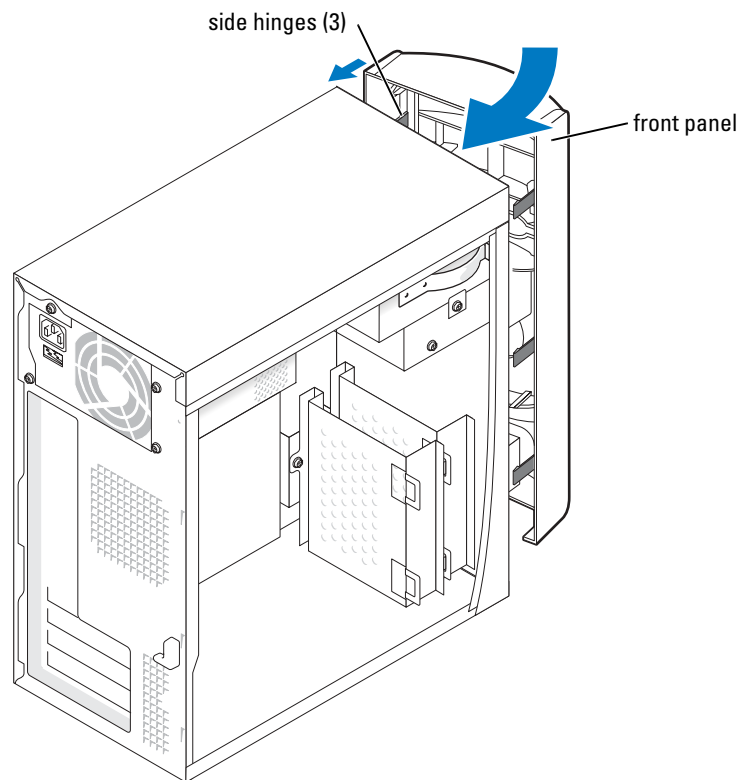

- 8 Connect the floppy-drive power cable to the back of the drive.
- CAUTION:** Match the colored strip on the cable with pin 1 on the drive (pin 1 is marked as "1").

- 9 Connect the data cable to the back of the drive and to the floppy drive connector on the system board (see page 58).
 - 10 Position the top of the floppy drive bracket so that it is completely flush with the bottom of the upper drive bay, and then slide the floppy drive bracket forward into position.
-  **NOTE:** The top of the floppy drive bracket has two slots that fit into two clips on the bottom of the upper drive bay. When the floppy drive bracket is properly mounted, it remains in place without support.
- 11 Secure the floppy drive bracket with the top bracket screw that came with your drive.
 - 12 Reattach the front panel to the side hinges, and then rotate it until it snaps onto the front of the computer.



- 13 Check all cable connections, and fold cables out of the way to provide airflow for the fan and cooling vents.
 - 14 Replace the computer cover (see page 78).
-  **NOTICE:** To connect a network cable, first plug the cable into the network wall jack and then plug it into the computer.

- 15 Connect your computer and devices to electrical outlets, and turn them on.
- 16 After you turn on your computer, press <F2> when you are prompted to enter setup mode.
- 17 Highlight **Drive Configuration** and press <Enter>.
- 18 Use the left and right arrows to change **Diskette Drive A** from **Not Installed** to **3.5 inch, 1.44MB**.
- 19 Press <Enter>.
- 20 Highlight **Integrated Devices (LegacySelect Options)** and press <Enter>.
- 21 Make sure that the **Diskette Interface** entry is set to **Auto**. If necessary, use the left and right arrows to set it to **Auto**.
- 22 Press <Enter>.
- 23 Press <Esc>.
- 24 Press <Enter> to save changes and exit.

The computer restarts.

See the documentation that came with the drive for instructions on installing any software required for drive operation.

Adding a Second CD or DVD Drive



CAUTION: Before you begin any of the procedures in this section, follow the safety instructions located in the *Product Information Guide*.

- 1 Shut down the computer through the **Start** menu (see page 18).



NOTE: Drives sold by Dell come with their own operating software and documentation. After you install a drive, see the documentation that came with the drive for instructions on installing and using the drive software.

- 2 Ensure that your computer and attached devices are turned off. If your computer and attached devices did not automatically turn off when you shut down your computer, turn them off now.



NOTICE: To disconnect a network cable, first unplug the cable from your computer and then unplug it from the network wall jack.

- 3 Disconnect any telephone or telecommunication lines from the computer.
- 4 Disconnect your computer and all attached devices from their electrical outlets, and then press the power button to ground the system board.



CAUTION: To guard against electrical shock, always unplug your computer from the electrical outlet before opening the cover.

- 5 Remove the computer cover (see page 55).

- 6** Release and remove the front panel:
- a** Push the release lever to release the top tab.
 - b** Reach inside the computer and push the bottom tab towards you to release it (the middle tab releases automatically).
 - c** Rotate the front panel to separate it from the side hinges.

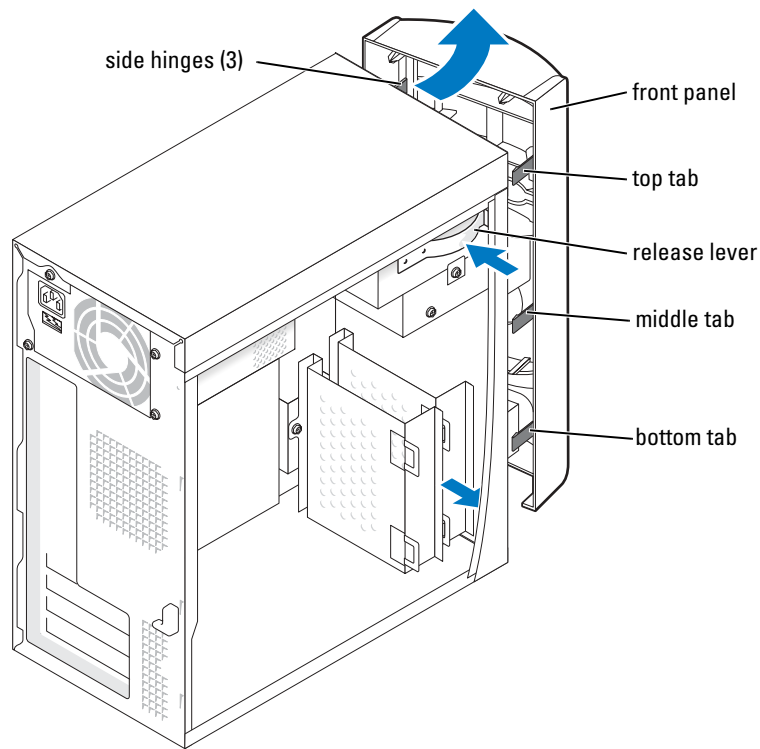

- 7 Pull the two front-panel tabs towards you, and then push out the front-panel insert.

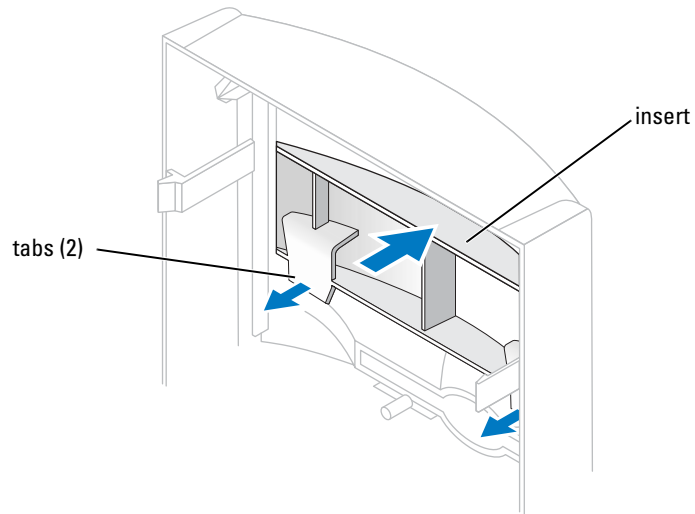

- 8 Ensure that the jumper setting on the new drive is set for "cable select" (see the documentation that came with the drive for information).
- 9 Remove two extra alignment screws, shown in the illustration on page 72, from the front of the computer and insert them into the drive.

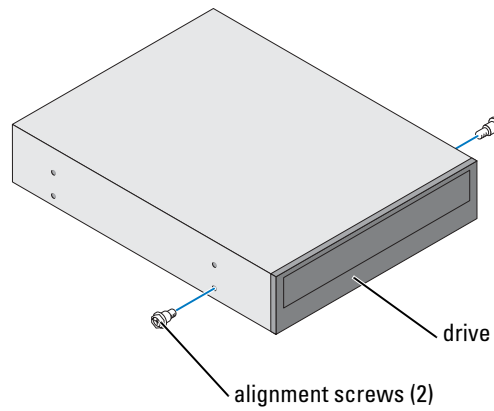

NOTE: Some computers come with only two extra alignment screws; others come with four. You only need two alignment screws for this procedure.

- 10 Gently slide the drive into place.

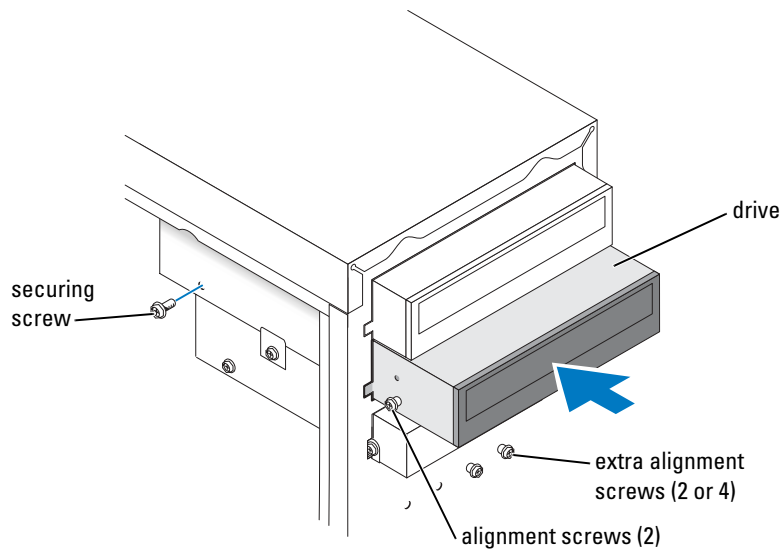

- 11 Once the drive is in place, apply pressure to ensure that the drive is fully seated.
- 12 Use the securing screw that came with the drive to attach the drive to the computer.
- NOTICE:** Match the colored strip on the cable with pin 1 on the drive (pin 1 is marked as "1").
- 13 Connect the power cable to the system board.
- 14 Locate the data cable from the CD or DVD drive in the upper drive bay and connect its middle data connector to the new drive.
- 15 Check all cable connections, and then fold the cables out of the way to provide airflow for the fan and cooling vents.
- 16 Reattach the front panel to the side hinges, and then rotate it until it snaps onto the front of the computer.

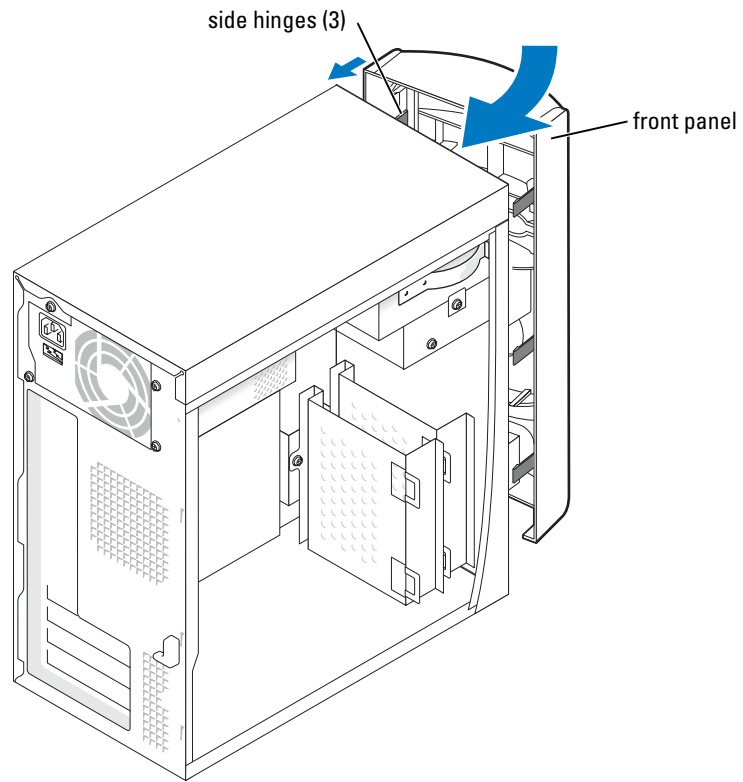

17 Replace the computer cover (see page 78).

👉 NOTICE: To connect a network cable, first plug the cable into the network wall jack and then plug it into the computer.

18 Connect your computer and devices to electrical outlets, and then turn them on.

See the documentation that came with the drive for instructions on installing any software required for drive operation.

Adding Memory

You can increase your computer memory by installing memory modules on the system board.

 **NOTE:** DDR 333 memory operates at 320 MHz when used with an 800-MHz front-side bus.

DDR Memory Overview

DDR memory modules should be installed in *pairs of matched memory size*. This means that if you purchased your computer with 128 MB of memory installed and you want to add another 128 MB of memory, you should install it in the appropriate connector. If the DDR memory modules are not installed in matched pairs, the computer will continue to operate, but with a slight reduction in performance.

 **NOTE:** Always install DDR memory modules in the order indicated on the system board.

The recommended memory configurations are:

- Install a pair of matched memory modules in connectors DIMM1 and DIMM2.
or
- Install a pair of matched memory modules in connectors DIMM1 and DIMM2 and another matched pair in connectors DIMM3 and DIMM4.
- Do not install ECC memory modules.
- If you install mixed pairs PC2700 (DDR 333-MHz) and PC3200 (DDR 400-MHz) memory, the modules function at the slowest speed installed.
- Be sure to install a single memory module in DIMM 1 or the connector closest to the processor before you install modules in the other connectors.

Memory Installation Guidelines

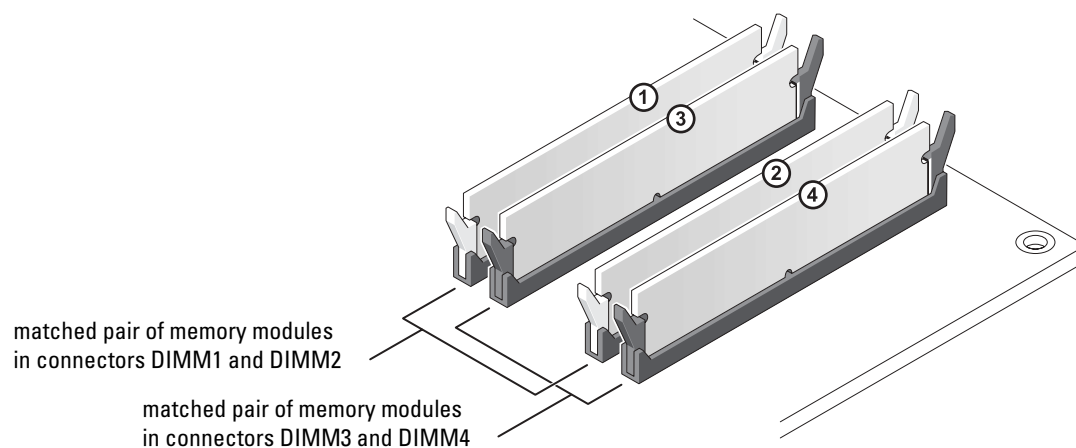

-  **NOTICE:** If you remove your original memory modules from the computer during a memory upgrade, keep them separate from any new modules that you may have, even if you purchased the new modules from Dell. You should install your original memory modules in pairs either in connectors DIMM1 and DIMM2 or connectors DIMM3 and DIMM4. If possible, *do not* pair an original memory module with a new memory module. Otherwise, your computer may not function at optimal performance.

-  **NOTE:** Memory purchased from Dell is covered under your computer warranty.

Installing Memory

-  **CAUTION:** Before you begin any of the procedures in this section, follow the safety instructions located in the *Product Information Guide*.

- 1 Shut down the computer through the **Start** menu (see page 18).
- 2 Ensure that your computer and attached devices are turned off. If your computer and attached devices did not automatically turn off when you shut down your computer, turn them off now.

-  **NOTICE:** To disconnect a network cable, first unplug the cable from your computer and then unplug it from the network wall jack.

- 3 Disconnect any telephone or telecommunication lines from the computer.
- 4 Disconnect your computer and all attached devices from their electrical outlets, and then press the power button to ground the system board.

-  **CAUTION:** To guard against electrical shock, always unplug your computer from the electrical outlet before opening the cover.

- 5 Remove the computer cover (see page 55).
- 6 Lay the computer on its side so that the system board is on the bottom of the inside of the computer.

-  **NOTE:** For easier access to the memory modules, remove the AGP card (see page 62) first.

- 7 If necessary, remove a memory module:
 - a Press out the securing clip at each end of the memory module connector.
 - b Grasp the module and pull up.
If the module is difficult to remove, gently ease the module back and forth to remove it from the connector.
- 8 To insert a module, press out the securing clip at each end of the memory module connector.

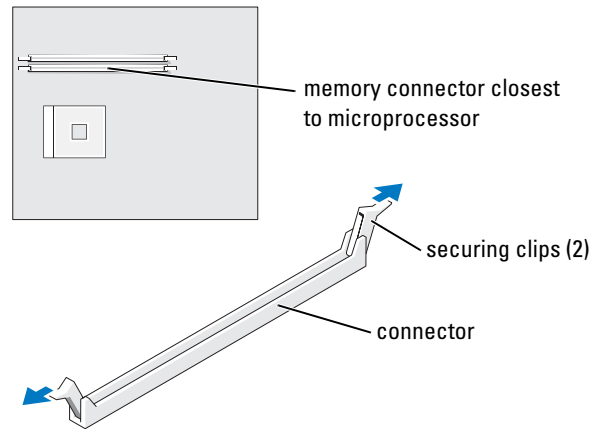

- 9 Align the notch on the bottom of the module with the crossbar in the connector.

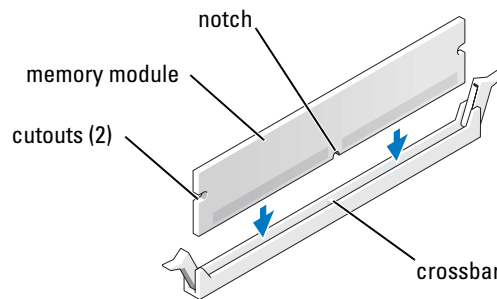

NOTICE: To avoid breaking the memory module, do not press near the middle of the module.

- 10 Insert the module straight down into the connector, ensuring that it fits into the vertical guides at each end of the connector. Press firmly on the ends of the module until it snaps into place.

If you insert the module correctly, the securing clips snap into the cutouts at each end of the module.

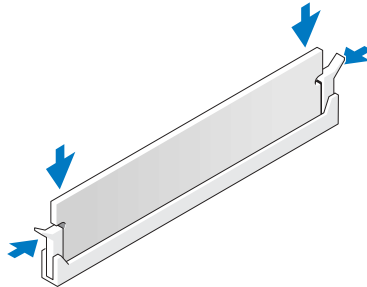

- 11 Replace the computer cover (see page 78).
- ➡ **NOTICE:** To connect a network cable, first plug the cable into the network wall jack and then plug it into the computer.
- 12 Connect your computer and devices to electrical outlets, and then turn them on.
- 13 Click the **Start** button, right-click **My Computer**, and then click **Properties**.
- 14 Click the **General** tab.
- 15 To verify that the memory is installed correctly, check the amount of memory (RAM) listed.

Replacing the Computer Cover

- 1 Ensure that all cables are connected, and fold cables out of the way.
- 2 Ensure that no tools or extra parts are left inside the computer.
- 3 Place the cover on the computer.
- 4 Slide the cover towards the front of the computer until it fits completely into place.
- ➡ **NOTICE:** To connect a network cable, first plug the cable into the network wall jack and then plug it into the computer.
- 5 Connect your computer and devices to electrical outlets, and turn them on.

Appendix

Specifications

Microprocessor

Microprocessor type	Intel® Pentium® 4
Level 1 (L1) cache	8 KB first-level
Level 2 (L2) cache	512-KB or 1-MB pipelined-burst, eight-way set associative, write-back SRAM

System Information

System chip set	Intel 865PE or 865G
DMA channels	eight
Interrupt levels	24 APIC mode
System BIOS chip	4 Mb (512 KB)
System clock	533- or 800-MHz data rate

Expansion Bus

Bus types	PCI
Bus speed	PCI: 33 MHz
PCI connectors	three
PCI connector size	120 pins
PCI connector data width (maximum)	32 bits
AGP	AGP 1X, 4X, 8X

Memory	
Architecture	Dual Channel DDR SDRAM
Memory connectors	Four
Memory capacities	128-, 256-, 512-MB or 1-GB
Minimum memory	128-MB DDR SDRAM
	NOTE: Between 32 and 64 MB of system memory may be allocated to support graphics, depending on system memory size and other factors.
Maximum memory	4 GB
Memory type	PC2700 (333-MHz) or PC3200 (400-MHz) DDR SDRAM (non-ECC)

Drives	
Externally accessible	two 5.25-inch bays one 3.5-inch bay
Internally accessible	Two bays for 1-inch-high IDE hard drives

Ports and Connectors	
Externally accessible:	
Serial	9-pin connector; 16550C-compatible
Parallel	25-hole connector (bidirectional)
Video	15-hole connector
Keyboard	6-pin mini-DIN connector
Mouse	6-pin mini-DIN connector
USB	two front-panel and six back-panel USB 2.0-compliant connectors
Network	RJ-45 connector
Audio	Five back miniature connectors for line-in, line-out, microphone, surround and center/Low-Frequency Effects (LFE) channel
Headphone	one front miniature connector for line-out

Ports and Connectors (continued)

Internally accessible:

Primary IDE channel	40-pin connector on PCI local bus
Secondary IDE channel	40-pin connector on PCI local bus
Floppy drive	34-pin connector
Serial ATA	two 7-pin connectors

Video

Type	Integrated Intel Extreme Graphics controller
------	--

Audio

Audio controller	ADI 1980
------------------	----------

Network

Network controller	Integrated Intel [®] PRO 10/100 Ethernet
--------------------	---

Controls and Lights

Power control	push button
Front-panel power light	solid green for power-on state; blinking green for standby state
Hard-drive access light	green
Diagnostic code lights	four bicolor (amber and green) located on back panel

Power

DC power supply:

Wattage	250 W
Heat dissipation	853 BTU (fully-loaded computer without monitor)
Voltage (see the safety instruction located in the <i>Product Information Guide</i> for important voltage setting information)	100 to 120 V at 60 Hz; 200 to 240 V at 50 Hz
Backup battery	3-V CR2032 coin cell

Physical

Height x Width x Depth	36.8 x 18.4 x 42.6 cm (14.5 x 7.25 x 16.75 inches)
Weight	10.4 kg (23 lb)

Environmental

Temperature:

Operating

10° to 35°C (50° to 95°F)

NOTE: At 35°C (95°F), the maximum operating altitude is 914 m (3000 ft).

Storage

-40° to 65°C (-40° to 149°F)

Relative humidity

20% to 80% (noncondensing)

Maximum vibration:

Operating

0.25 G at 3 to 200 Hz

Storage

2.20 Grms at 10 to 500 Hz

Maximum shock:

Nonoperating (half-sine pulse)

105 G, 2 ms

Nonoperating (faired-square wave)

32 G with a velocity change of 596.9 cm/sec (235 inches/sec)

Altitude:

Operating

-15.2 to 3048 m (-50 to 10,000 ft)

NOTE: At 35°C (95°F), the maximum operating altitude is 914 m (3000 ft).

Storage

-15.2 to 10,670 m (-50 to 35,000 ft)

System Setup

Overview

Use system setup as follows:

- To change the system configuration information after you add, change, or remove any hardware in your computer
- To set or change a user-selectable option such as the user password
- To read the current amount of memory or set the type of hard drive installed

Before you use system setup, you must know the kind of floppy drive(s) and hard drive(s) installed in your computer. It is recommended that you write down the system setup screen information for future reference.



NOTICE: Unless you are an expert computer user, do not change the settings for this program. Certain changes can make your computer work incorrectly.

Viewing Settings

- 1 Turn on (or restart) your computer.
- 2 When the blue DELL™ logo appears, press <F2> immediately.

If you wait too long and the operating system logo appears, continue to wait until you see the Microsoft® Windows® desktop. Then shut down your computer (see page 18) and try again.

System Setup Screens

System setup screens display the current configuration information for your computer. Information on the screen is divided into five areas:

- Title — The box at the top of all screens that lists the computer name.
- Computer data — Two boxes below the title box that display your computer processor, L2 cache, Service Tag, and the version number of the BIOS.
- Options — A scrollable box listing options that define the configuration of your computer, including installed hardware, power conservation, and security features.

Fields to the right of the option titles contain settings or values. When <Enter> appears to the right of an option title, press <Enter> to access a pop-up menu of additional options.

- Help — A feature that gives you information on the option that is selected (highlighted) when you press <F1>.
- Key functions — A line of boxes across the bottom of all screens that lists keys and their functions within system setup.

Keys	Action
<Tab> or down arrow	Moves to the next field.
<Shift>, <Tab> or up arrow	Moves to the previous field.
back arrow or forward arrow	Cycles through the options in a field. In many fields, you can also type the appropriate value.
<Page Down> or <Page Up>	Scrolls through help information.
<Enter>	Enters the selected field's pop-up options menu.
spacebar, <=> or <->	In the selected field's pop-up options menu, cycles through the options in a field.
<Alt> <x>	Exits system setup without restarting the computer and returns the computer to the boot routine.
<Alt> 	Exits system setup and restarts the computer, implementing any changes you have made.

Keys	Action
<Alt> <d>	Resets the selected option to the default setting.
<Alt> <f>	Restores all system settings to the default configuration.

Boot Sequence

This feature allows you to change the boot sequence for devices.

Option Settings

- **Normal** — (Available only for the current boot process) The computer attempts to boot from the sequence of devices specified in system setup.
- **Diskette Drive** — The computer attempts to boot from the floppy drive. If the floppy disk in the drive is not bootable, or if no floppy disk is in the drive, the computer generates an error message.
- **Hard Drive** — The computer attempts to boot from the primary hard drive. If no operating system is on the drive, the computer generates an error message.
- **CD Drive** — The computer attempts to boot from the CD drive. If no CD is in the drive, or if the CD has no operating system, the computer generates an error message.
- **PXE** — (Available only for the future boot process) As the computer boots, it prompts the user to press <Ctrl><Alt>. Pressing this key combination causes a menu to display that allows you to select a method for booting from a network server. If a boot routine is not available from the network server, the system attempts to boot from the next device in the boot sequence list.
- **USB Flash Device** — Insert the memory device into a USB port and restart the computer. When **F12 = Boot Menu** appears in the upper-right corner of the screen, press <F12>. The BIOS detects the device and adds the USB flash option to the boot menu.



NOTE: To boot to a USB device, the device must be bootable. To make sure your device is bootable, check the device documentation.

Changing Boot Sequence for the Current Boot

You can use this feature, for example, to restart your computer to a USB device such as a floppy drive, memory key, or CD-RW drive.

- 1 Turn on (or restart) your computer.
- 2 When **F2 = Setup**, **F12 = Boot Menu** appears in the upper-right corner of the screen, press <F12>.

If you wait too long and the operating system logo appears, continue to wait until you see the Microsoft Windows desktop. Then shut down your computer (see page 18) and try again.

The **Boot Device Menu** appears, listing all available boot devices. Each device has a number next to it.

- 3 At the bottom of the menu, enter the number of the device that is to be used for the current boot only.

Changing Boot Sequence for Future Boots

- 1 Enter system setup (see page 82).
- 2 Use the arrow keys to highlight the **Boot Sequence** menu option and press <Enter> to access the pop-up menu.

 **NOTE:** Write down your current boot sequence in case you want to restore it.

- 3 Press the up- and down-arrow keys to move through the list of devices.
- 4 Press the spacebar to enable or disable a device (enabled devices have a checkmark).
- 5 Press plus (+) or minus (-) to move a selected device up or down the list.

Clearing Forgotten Passwords



 **CAUTION:** Before you begin any of the procedures in this section, follow the safety instructions located in the *Product Information Guide*.

 **CAUTION:** To guard against electrical shock, always unplug your computer from the electrical outlet before opening the cover.

- 1 Shut down the computer through the **Start** menu (see page 18).
-  **NOTICE:** To disconnect a network cable, first unplug the cable from your computer and then unplug it from the network wall jack.
- 2 Turn off any attached devices and disconnect them from their electrical outlets.
 - 3 Disconnect the computer power cable from the wall outlet, and then press the power button to ground the system board.
 - 4 Remove the computer cover (see page 55).
 - 5 Locate the 3-pin password jumper (see page 58) on the system board, and then attach the jumper to both pins.

When you receive your computer, the jumper is attached to only one pin.

- 6 Replace the computer cover (see page 78).
-  **NOTICE:** To connect a network cable, first plug the cable into the network wall jack and then plug it into the computer.
- 7 Connect your computer and devices to electrical outlets, and then turn them on.
 - 8 If you are prompted to press <F1> to continue, press <F1>.

- 9 After the Microsoft Windows desktop appears on your computer, shut down the computer through the **Start** menu (see page 18).
-  **NOTICE:** To disconnect a network cable, first unplug the cable from your computer and then unplug it from the network wall jack.
- 10 Turn off any attached devices and disconnect them from their electrical outlets.
- 11 Disconnect the computer power cable from the wall outlet, and then press the power button to ground the system board.
- 12 Remove the computer cover (see page 78).
- 13 Remove the password jumper.
Attach the jumper to only one pin so that you do not lose it.
- 14 Replace the computer cover (see page 78).
-  **NOTICE:** To connect a network cable, first plug the cable into the network wall jack and then plug it into the computer.
- 15 Connect your computer and devices to electrical outlets, and turn them on.
- 16 If you are prompted to press <F1> to continue, press <F1>.

Replacing the Battery

 **CAUTION:** Before you begin any of the procedures in this section, follow the safety instructions located in the *Product Information Guide*.

 **CAUTION:** To guard against electrical shock, always unplug your computer from the electrical outlet before opening the cover.

A coin-cell battery maintains computer configuration, date, and time information. The battery can last several years.

If you have to repeatedly reset time and date information after turning on the computer, replace the battery.

 **CAUTION:** A new battery can explode if it is incorrectly installed. Replace the 3-V CR2032 battery only with the same or equivalent type recommended by the manufacturer. Discard used batteries according to the manufacturer's instructions.

- 1 Record all the screens in system setup (see page 82) so that you can restore the correct settings when you perform step 11.
- 2 Shut down the computer through the **Start** menu (see page 18).
-  **NOTICE:** To disconnect a network cable, first unplug the cable from your computer and then unplug it from the network wall jack.
- 3 Turn off any attached devices and disconnect them from their electrical outlets.
- 4 Disconnect the computer power cable from the wall outlet, and then press the power button to ground the system board.

5 Remove the computer cover (see page 78).

6 Locate the battery socket (see page 82).

NOTICE: If you pry the battery out of its socket with a blunt object, be careful not to touch the system board with the object. Ensure that the object is inserted between the battery and the socket before you attempt to pry out the battery. Otherwise, you may damage the system board by prying off the socket or by breaking circuit traces on the system board.

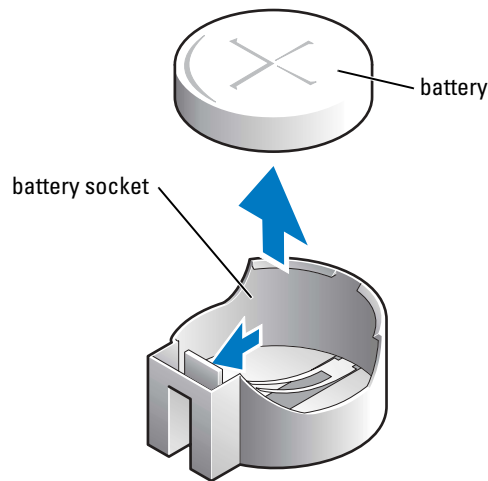

7 Remove the battery by carefully prying it out of its socket with your fingers or with a blunt, nonconducting object such as a plastic screwdriver.

8 Insert the new battery into the socket with the side labeled "+" facing up, and snap the battery into place.

9 Replace the computer cover (see page 78).

NOTICE: To connect a network cable, first plug the cable into the network wall jack and then plug it into the computer.

10 Connect your computer and devices to electrical outlets, and turn them on.

11 Enter system setup (see page 82) and restore the settings you recorded in step 1.

12 Properly dispose of the old battery. See the *Product Information Guide* for battery disposal information.

Dell Technical Support Policy (U.S. Only)

Technician-assisted technical support requires the cooperation and participation of the customer in the troubleshooting process and provides for restoration of the operating system, software programs, and hardware drivers to the original default configuration as shipped from Dell, as well as the verification of appropriate functionality of the computer and all Dell-installed hardware. In addition to this technician-assisted technical support, online technical support is available at support.dell.com. Additional technical support options may be available for purchase.

Dell provides limited technical support for the computer and any "Dell-installed" software and peripherals¹. Support for third-party software and peripherals is provided by the original manufacturer, including those purchased and/or installed through Dell Software and Peripherals, Readyware, and Custom Factory Integration².

- ¹ Repair services are provided pursuant to the terms and conditions of your limited warranty and any optional support service contract purchased with the computer.
- ² All Dell-standard components included in a Custom Factory Integration (CFI) project are covered by the standard Dell limited warranty for your computer. However, Dell also extends a parts replacement program to cover all nonstandard, third-party hardware components integrated through CFI for the duration of the computer's service contract.

Definition of "Dell-Installed" Software and Peripherals

Dell-installed software includes the operating system and some of the software program that is installed on the computer during the manufacturing process (Microsoft Office, Norton Antivirus, and so on).

Dell-installed peripherals include any internal expansion cards, or Dell-branded module bay or PC Card accessories. In addition, any Dell-branded monitors, keyboards, mice, speakers, microphones for telephonic modems, docking stations/port replicators, networking products, and all associated cabling are included.

Definition of "Third-Party" Software and Peripherals

Third-party software and peripherals include any peripheral, accessory, or software program sold by Dell not under the Dell brand (printers, scanners, cameras, games, and so on). Support for all third-party software and peripherals is provided by the original manufacturer of the product.

FCC Notices (U.S. Only)

Most Dell computer systems are classified by the Federal Communications Commission (FCC) as Class B digital devices. To determine which classification applies to your computer system, examine all FCC registration labels located on the bottom, side, or back panel of your computer, on card-mounting brackets, and on the cards themselves. If any one of the labels carries a Class A rating, your entire system is considered to be a Class A digital device. If *all* labels carry an FCC Class B rating as distinguished by either an FCC ID number or the FCC logo, (**FC**), your system is considered to be a Class B digital device.

Once you have determined your system's FCC classification, read the appropriate FCC notice. Note that FCC regulations provide that changes or modifications not expressly approved by Dell could void your authority to operate this equipment.

This device complies with Part 15 of the FCC Rules. Operation is subject to the following two conditions:

This device may not cause harmful interference.

This device must accept any interference received, including interference that may cause undesired operation.

Class A

This equipment has been tested and found to comply with the limits for a Class A digital device pursuant to Part 15 of the FCC Rules. These limits are designed to provide reasonable protection against harmful interference when the equipment is operated in a commercial environment. This equipment generates, uses, and can radiate radio frequency energy and, if not installed and used in accordance with the manufacturer's instruction manual, may cause harmful interference with radio communications. Operation of this equipment in a residential area is likely to cause harmful interference, in which case you will be required to correct the interference at your own expense.

Class B

This equipment has been tested and found to comply with the limits for a Class B digital device pursuant to Part 15 of the FCC Rules. These limits are designed to provide reasonable protection against harmful interference in a residential installation. This equipment generates, uses, and can radiate radio frequency energy and, if not installed and used in accordance with the manufacturer's instruction manual, may cause interference with radio communications. However, there is no guarantee that interference will not occur in a particular installation. If this equipment does cause harmful interference to radio or television reception, which can be determined by turning the equipment off and on, you are encouraged to try to correct the interference by one or more of the following measures:

- Reorient or relocate the receiving antenna.
- Increase the separation between the equipment and the receiver.
- Connect the equipment into an outlet on a circuit different from that to which the receiver is connected.
- Consult the dealer or an experienced radio/television technician for help.

FCC Identification Information

The following information is provided on the device or devices covered in this document in compliance with FCC regulations:

- Model numbers: DMC, MTC2

Company name:

Dell Inc.
One Dell Way
Round Rock, Texas 78682 USA
512-338-4400

Contacting Dell

To contact Dell electronically, you can access the following websites:

- www.dell.com
- support.dell.com (technical support)
- premiersupport.dell.com (technical support for educational, government, healthcare, and medium/large business customers, including Premier, Platinum, and Gold customers)

For specific web addresses for your country, find the appropriate country section in the table below.

NOTE: Toll-free numbers are for use within the country for which they are listed.

When you need to contact Dell, use the electronic addresses, telephone numbers, and codes provided in the following table. If you need assistance in determining which codes to use, contact a local or an international operator.

Country (City) International Access Code Country Code City Code	Department Name or Service Area, Website and E-Mail Address	Area Codes, Local Numbers, and Toll-Free Numbers
Anguilla	General Support	toll-free: 800-335-0031
Antigua and Barbuda	General Support	1-800-805-5924

Country (City) International Access Code Country Code City Code	Department Name or Service Area, Website and E-Mail Address	Area Codes, Local Numbers, and Toll-Free Numbers
Argentina (Buenos Aires) International Access Code: 00 Country Code: 54 City Code: 11	Website: www.dell.com.ar E-mail: us_latin_services@dell.com E-mail for desktop and portable computers: la-techsupport@dell.com E-mail for servers and EMC: la_enterprise@dell.com Customer Care Tech Support Tech Support Services Sales	toll-free: 0-800-444-0730 toll-free: 0-800-444-0733 toll-free: 0-800-444-0724 0-810-444-3355
Aruba	General Support	toll-free: 800-1578
Australia (Sydney) International Access Code: 0011 Country Code: 61 City Code: 2	E-mail (Australia): au_tech_support@dell.com E-mail (New Zealand): nz_tech_support@dell.com Home and Small Business Government and Business Preferred Accounts Division (PAD) For servers and storage For desktop and portable computers Customer Care Corporate Sales Transaction Sales Fax	1-300-65-55-33 toll-free: 1-800-633-559 toll-free: 1-800-060-889 toll-free: 1-800-505-095 toll-free: 1-800-733-314 toll-free: 1-800-819-339 toll-free: 1-800-808-385 toll-free: 1-800-808-312 toll-free: 1-800-818-341
Austria (Vienna) International Access Code: 900 Country Code: 43 City Code: 1	Website: support.euro.dell.com E-mail: tech_support_central_europe@dell.com Home/Small Business Sales Home/Small Business Fax Home/Small Business Customer Care Preferred Accounts/Corporate Customer Care Home/Small Business Technical Support Preferred Accounts/Corporate Technical Support Switchboard	0820 240 530 00 0820 240 530 49 0820 240 530 14 0820 240 530 16 0820 240 530 14 0660 8779 0820 240 530 00
Bahamas	General Support	toll-free: 1-866-278-6818

Country (City) International Access Code Country Code City Code	Department Name or Service Area, Website and E-Mail Address	Area Codes, Local Numbers, and Toll-Free Numbers
Barbados	General Support	1-800-534-3066
Belgium (Brussels)	Website: support.euro.dell.com	
International Access Code: 00	E-mail for French Speaking Customers: support.euro.dell.com/be/fr/emaildell/	
Country Code: 32	Technical Support	02 481 92 88
City Code: 2	Technical Support Fax	02 481 92 95
	Customer Care	02 713 15 .65
	Corporate Sales	02 481 91 00
	Fax	02 481 92 99
	Switchboard	02 481 91 00
Bermuda	General Support	1-800-342-0671
Bolivia	General Support	toll-free: 800-10-0238
Brazil	Website: www.dell.com/br	
International Access Code: 00	Customer Support, Technical Support	0800 90 3355
Country Code: 55	Technical Support Fax	51 481 5470
City Code: 51	Customer Care Fax	51 481 5480
	Sales	0800 90 3390
British Virgin Islands	General Support	toll-free: 1-866-278-6820
Brunei	Customer Technical Support (Penang, Malaysia)	604 633 4966
Country Code: 673	Customer Service (Penang, Malaysia)	604 633 4949
	Transaction Sales (Penang, Malaysia)	604 633 4955
Canada (North York, Ontario)	Online Order Status: www.dell.ca/ostatus	
International Access Code: 011	AutoTech (automated technical support)	toll-free: 1-800-247-9362
	Customer Care (Home Sales/Small Business)	toll-free: 1-800-847-4096
	Customer Care (med./large business, government)	toll-free: 1-800-326-9463
	Technical Support (Home Sales/Small Business)	toll-free: 1-800-847-4096
	Technical Support (med./large bus., government)	toll-free: 1-800-387-5757
	Sales (Home Sales/Small Business)	toll-free: 1-800-387-5752
	Sales (med./large bus., government)	toll-free: 1-800-387-5755
	Spare Parts Sales & Extended Service Sales	1 866 440 3355
Cayman Islands	General Support	1-800-805-7541

Country (City) International Access Code Country Code City Code	Department Name or Service Area, Website and E-Mail Address	Area Codes, Local Numbers, and Toll-Free Numbers
Chile (Santiago) Country Code: 56 City Code: 2	Sales, Customer Support, and Technical Support	toll-free: 1230-020-4823
China (Xiamen) Country Code: 86 City Code: 592	Technical Support website: support.dell.com.cn Technical Support E-mail: cn_support@dell.com Technical Support Fax Technical Support (Dimension™ and Inspiron™) Technical Support (OptiPlex™, Latitude™, and Dell Precision™) Technical Support (servers and storage) Technical Support (projectors, PDAs, printers, switches, routers, and so on) Customer Advocacy Customer Advocacy Fax Home and Small Business Preferred Accounts Division Large Corporate Accounts GCP Large Corporate Accounts Key Accounts Large Corporate Accounts North Large Corporate Accounts North Government and Education Large Corporate Accounts East Large Corporate Accounts East Government and Education Large Corporate Accounts Queue Team Large Corporate Accounts South Large Corporate Accounts West Large Corporate Accounts Spare Parts	818 1350 toll-free: 800 858 2969 toll-free: 800 858 0950 toll-free: 800 858 0960 toll-free: 800 858 2920 toll-free: 800 858 2060 592 818 1308 toll-free: 800 858 2222 toll-free: 800 858 2557 toll-free: 800 858 2055 toll-free: 800 858 2628 toll-free: 800 858 2999 toll-free: 800 858 2955 toll-free: 800 858 2020 toll-free: 800 858 2669 toll-free: 800 858 2572 toll-free: 800 858 2355 toll-free: 800 858 2811 toll-free: 800 858 2621
Colombia	General Support	980-9-15-3978
Costa Rica	General Support	0800-012-0435

Country (City) International Access Code Country Code City Code	Department Name or Service Area, Website and E-Mail Address	Area Codes, Local Numbers, and Toll-Free Numbers
Czech Republic (Prague)	Website: support.euro.dell.com	
International Access Code: 00	E-mail: czech_dell@dell.com	
Country Code: 420	Technical Support	02 2186 27 27
City Code: 2	Technical Support Fax	02 2186 27 28
	Customer Care	02 2186 27 11
	Customer Care Fax	02 2186 27 14
	Switchboard	02 2186 27 11
Denmark (Copenhagen)	Website: support.euro.dell.com	
International Access Code: 00	E-mail Support (portable computers): den_nbk_support@dell.com	
Country Code: 45	E-mail Support (desktop computers): den_support@dell.com	
	E-mail Support (servers): Nordic_server_support@dell.com	
	Technical Support	7023 0182
	Customer Care (Relational)	7023 0184
	Home/Small Business Customer Care	3287 5505
	Switchboard (Relational)	3287 1200
	Switchboard Fax (Relational)	3287 1201
	Switchboard (Home/Small Business)	3287 5000
	Switchboard Fax (Home/Small Business)	3287 5001
Dominica	General Support	toll-free: 1-866-278-6821
Dominican Republic	General Support	1-800-148-0530
Ecuador	General Support	toll-free: 999-119
El Salvador	General Support	01-899-753-0777

Country (City) International Access Code Country Code City Code	Department Name or Service Area, Website and E-Mail Address	Area Codes, Local Numbers, and Toll-Free Numbers
Finland (Helsinki) International Access Code: 990 Country Code: 358 City Code: 9	Website: support.euro.dell.com	
	E-mail: fin_support@dell.com	
	E-mail Support (servers): Nordic_support@dell.com	
	Technical Support	09 253 313 60
	Technical Support Fax	09 253 313 81
	Relational Customer Care	09 253 313 38
	Home/Small Business Customer Care	09 693 791 94
	Fax	09 253 313 99
Switchboard	09 253 313 00	
France (Paris) (Montpellier) International Access Code: 00 Country Code: 33 City Codes: (1) (4)	Website: support.euro.dell.com	
	E-mail: support.euro.dell.com/fr/fr/emaildell/	
	Home and Small Business	
	Technical Support	0825 387 270
	Customer Care	0825 823 833
	Switchboard	0825 004 700
	Switchboard (calls from outside of France)	04 99 75 40 00
	Sales	0825 004 700
	Fax	0825 004 701
	Fax (calls from outside of France)	04 99 75 40 01
	Corporate	
	Technical Support	0825 004 719
	Customer Care	0825 338 339
	Switchboard	01 55 94 71 00
Sales	01 55 94 71 00	
Fax	01 55 94 71 01	

Country (City) International Access Code Country Code City Code	Department Name or Service Area, Website and E-Mail Address	Area Codes, Local Numbers, and Toll-Free Numbers
Germany (Langen)	Website: support.euro.dell.com	
International Access Code: 00	E-mail: tech_support_central_europe@dell.com	
Country Code: 49	Technical Support	06103 766-7200
City Code: 6103	Home/Small Business Customer Care	0180-5-224400
	Global Segment Customer Care	06103 766-9570
	Preferred Accounts Customer Care	06103 766-9420
	Large Accounts Customer Care	06103 766-9560
	Public Accounts Customer Care	06103 766-9555
	Switchboard	06103 766-7000
Greece	Website: support.euro.dell.com	
International Access Code: 00	E-mail: support.euro.dell.com/gr/en/emailldell/	
Country Code: 30	Technical Support	00800-44 14 95 18
	Gold Service Technical Support	00800-44 14 00 83
	Switchboard	2108129810
	Gold Service Switchboard	2108129811
	Sales	2108129800
	Fax	2108129812
Grenada	General Support	toll-free: 1-866-540-3355
Guatemala	General Support	1-800-999-0136
Guyana	General Support	toll-free: 1-877-270-4609

Country (City) International Access Code Country Code City Code	Department Name or Service Area, Website and E-Mail Address	Area Codes, Local Numbers, and Toll-Free Numbers
Hong Kong	Website: support.ap.dell.com	
International Access Code: 001	E-mail: apsupport@dell.com	
Country Code: 852	Technical Support (Dimension™ and Inspiron™)	2969 3188
	Technical Support (OptiPlex™, Latitude™, and Dell Precision™)	2969 3191
	Technical Support (PowerApp™, PowerEdge™, PowerConnect™, and PowerVault™)	2969 3196
	Gold Queue EEC Hotline	2969 3187
	Customer Advocacy	3416 0910
	Large Corporate Accounts	3416 0907
	Global Customer Programs	3416 0908
	Medium Business Division	3416 0912
	Home and Small Business Division	2969 3155
India	Technical Support	1600 33 8045
	Sales	1600 33 8044
Ireland (Cherrywood)	Website: support.euro.dell.com	
International Access Code: 16	E-mail: dell_direct_support@dell.com	
Country Code: 353	Technical Support	1850 543 543
City Code: 1	U.K. Technical Support (dial within U.K. only)	0870 908 0800
	Home User Customer Care	01 204 4014
	Small Business Customer Care	01 204 4014
	U.K. Customer Care (dial within U.K. only)	0870 906 0010
	Corporate Customer Care	1850 200 982
	Corporate Customer Care (dial within U.K. only)	0870 907 4499
	Ireland Sales	01 204 4444
	U.K. Sales (dial within U.K. only)	0870 907 4000
	Fax/Sales Fax	01 204 0103
	Switchboard	01 204 4444

Country (City) International Access Code Country Code City Code	Department Name or Service Area, Website and E-Mail Address	Area Codes, Local Numbers, and Toll-Free Numbers
Italy (Milan)	Website: support.euro.dell.com	
International Access Code: 00	E-mail: support.euro.dell.com/it/it/emaildell/	
Country Code: 39	Home and Small Business	
City Code: 02	Technical Support	02 577 826 90
	Customer Care	02 696 821 14
	Fax	02 696 821 13
	Switchboard	02 696 821 12
	Corporate	
	Technical Support	02 577 826 90
	Customer Care	02 577 825 55
	Fax	02 575 035 30
	Switchboard	02 577 821
Jamaica	General Support (dial from within Jamaica only)	1-800-682-3639

Country (City) International Access Code Country Code City Code	Department Name or Service Area, Website and E-Mail Address	Area Codes, Local Numbers, and Toll-Free Numbers
Japan (Kawasaki)	Website: support.jp.dell.com	
International Access Code: 001	Technical Support (servers)	toll-free: 0120-198-498
Country Code: 81	Technical Support outside of Japan (servers)	81-44-556-4162
City Code: 44	Technical Support (Dimension™ and Inspiron™)	toll-free: 0120-198-226
	Technical Support outside of Japan (Dimension and Inspiron)	81-44-520-1435
	Technical Support (Dell Precision™, OptiPlex™, and Latitude™)	toll-free:0120-198-433
	Technical Support outside of Japan (Dell Precision, OptiPlex, and Latitude)	81-44-556-3894
	Technical Support (PDAs, projectors, printers, routers)	toll-free: 0120-981-690
	Technical Support outside of Japan (PDAs, projectors, printers, routers)	81-44-556-3468
	Faxbox Service	044-556-3490
	24-Hour Automated Order Service	044-556-3801
	Customer Care	044-556-4240
	Business Sales Division (up to 400 employees)	044-556-1465
	Preferred Accounts Division Sales (over 400 employees)	044-556-3433
	Large Corporate Accounts Sales (over 3500 employees)	044-556-3430
	Public Sales (government agencies, educational institutions, and medical institutions)	044-556-1469
	Global Segment Japan	044-556-3469
	Individual User	044-556-1760
	Switchboard	044-556-4300
Korea (Seoul)	Technical Support	toll-free: 080-200-3800
International Access Code: 001	Sales	toll-free: 080-200-3600
Country Code: 82	Customer Service (Seoul, Korea)	toll-free: 080-200-3800
City Code: 2	Customer Service (Penang, Malaysia)	604 633 4949
	Fax	2194-6202
	Switchboard	2194-6000

Country (City) International Access Code Country Code City Code	Department Name or Service Area, Website and E-Mail Address	Area Codes, Local Numbers, and Toll-Free Numbers
Latin America	Customer Technical Support (Austin, Texas, U.S.A.)	512 728-4093
	Customer Service (Austin, Texas, U.S.A.)	512 728-3619
	Fax (Technical Support and Customer Service) (Austin, Texas, U.S.A.)	512 728-3883
	Sales (Austin, Texas, U.S.A.)	512 728-4397
	SalesFax (Austin, Texas, U.S.A.)	512 728-4600 or 512 728-3772
Luxembourg	Website: support.euro.dell.com	
International Access Code: 00	E-mail: tech_be@dell.com	
Country Code: 352	Technical Support (Brussels, Belgium)	3420808075
	Home/Small Business Sales (Brussels, Belgium)	toll-free: 080016884
	Corporate Sales (Brussels, Belgium)	02 481 91 00
	Customer Care (Brussels, Belgium)	02 481 91 19
	Fax (Brussels, Belgium)	02 481 92 99
	Switchboard (Brussels, Belgium)	02 481 91 00
Macao	Technical Support	toll-free: 0800 582
Country Code: 853	Customer Service (Penang, Malaysia)	604 633 4949
	Transaction Sales	toll-free: 0800 581
Malaysia (Penang)	Technical Support (Dell Precision, OptiPlex, and Latitude)	toll-free: 1 800 88 0193
International Access Code: 00		
Country Code: 60	Technical Support (Dimension and Inspiron)	toll-free: 1 800 88 1306
City Code: 4	Technical Support (PowerEdge and PowerVault)	toll-free: 1800 88 1386
	Customer Service	04 633 4949
	Transaction Sales	toll-free: 1 800 888 202
	Corporate Sales	toll-free: 1 800 888 213

Country (City) International Access Code Country Code City Code	Department Name or Service Area, Website and E-Mail Address	Area Codes, Local Numbers, and Toll-Free Numbers
Mexico International Access Code: 00 Country Code: 52	Customer Technical Support Sales Customer Service Main	001-877-384-8979 or 001-877-269-3383 50-81-8800 or 01-800-888-3355 001-877-384-8979 or 001-877-269-3383 50-81-8800 or 01-800-888-3355
Montserrat	General Support	toll-free: 1-866-278-6822
Netherlands Antilles	General Support	001-800-882-1519
Netherlands (Amsterdam) International Access Code: 00 Country Code: 31 City Code: 20	Website: support.euro.dell.com Technical Support Technical Support Fax Home/Small Business Customer Care Relational Customer Care Home/Small Business Sales Relational Sales Home/Small Business Sales Fax Relational Sales Fax Switchboard Switchboard Fax	020 674 45 00 020 674 47 66 020 674 42 00 020 674 4325 020 674 55 00 020 674 50 00 020 674 47 75 020 674 47 50 020 674 50 00 020 674 47 50
New Zealand International Access Code: 00 Country Code: 64	E-mail (New Zealand): nz_tech_support@dell.com E-mail (Australia): au_tech_support@dell.com Technical Support (for desktop and portable computers) Technical Support (for servers and storage) Home and Small Business Government and Business Sales Fax	0800 443 563 0800 505 098 0800 446 255 0800 444 617 0800 441 567 0800 441 566
Nicaragua	General Support	001-800-220-1006

Country (City) International Access Code Country Code City Code	Department Name or Service Area, Website and E-Mail Address	Area Codes, Local Numbers, and Toll-Free Numbers
Norway (Lysaker)	Website: support.euro.dell.com	
International Access Code: 00	E-mail Support (portable computers):	
Country Code: 47	nor_nbk_support@dell.com	
	E-mail Support (desktop computers):	
	nor_support@dell.com	
	E-mail Support (servers):	
	nordic_server_support@dell.com	
	Technical Support	671 16882
	Relational Customer Care	671 17514
	Home/Small Business Customer Care	23162298
	Switchboard	671 16800
	Fax Switchboard	671 16865
Panama	General Support	001-800-507-0962
Peru	General Support	0800-50-669
Poland (Warsaw)	Website: support.euro.dell.com	
International Access Code: 011	E-mail: pl_support_tech@dell.com	
Country Code: 48	Customer Service Phone	57 95 700
City Code: 22	Customer Care	57 95 999
	Sales	57 95 999
	Customer Service Fax	57 95 806
	Reception Desk Fax	57 95 998
	Switchboard	57 95 999
Portugal	Website: support.euro.dell.com	
International Access Code: 00	E-mail: support.euro.dell.com/pt/en/emailldell/	
Country Code: 351	Technical Support	707200149
	Customer Care	800 300 413
	Sales	800 300 410 or 800 300 411 or 800 300 412 or 21 422 07 10
	Fax	21 424 01 12
Puerto Rico	General Support	1-800-805-7545
St. Kitts and Nevis	General Support	toll-free: 1-877-441-4731

Country (City) International Access Code Country Code City Code	Department Name or Service Area, Website and E-Mail Address	Area Codes, Local Numbers, and Toll-Free Numbers
St. Lucia	General Support	1-800-882-1521
St. Vincent and the Grenadines	General Support	toll-free: 1-877-270-4609
Singapore (Singapore)	Technical Support (Dimension and Inspiron)	toll-free: 1800 394 7430
International Access Code: 005 Country Code: 65	Technical Support (Optiplex, Latitude, and Precision)	toll-free: 1800 394 7488
	Technical Support (PowerEdge and PowerVault)	toll-free: 1800 394 7478
	Customer Service (Penang, Malaysia)	604 633 4949
	Transaction Sales	toll-free: 800 6011 054
	Corporate Sales	toll-free: 800 6011 053
South Africa (Johannesburg)	Website: support.euro.dell.com	
International Access Code: 09/091	E-mail: dell_za_support@dell.com	
Country Code: 27	Gold Queue	011 709 7713
City Code: 11	Technical Support	011 709 7710
	Customer Care	011 709 7707
	Sales	011 709 7700
	Fax	011 706 0495
	Switchboard	011 709 7700
Southeast Asian and Pacific Countries	Customer Technical Support, Customer Service, and Sales (Penang, Malaysia)	604 633 4810
Spain (Madrid)	Website: support.euro.dell.com	
International Access Code: 00	E-mail: support.euro.dell.com/es/es/emaildell/	
Country Code: 34	Home and Small Business	
City Code: 91	Technical Support	902 100 130
	Customer Care	902 118 540
	Sales	902 118 541
	Switchboard	902 118 541
	Fax	902 118 539
	Corporate	
	Technical Support	902 100 130
	Customer Care	902 115 236
	Switchboard	91 722 92 00
	Fax	91 722 95 83

Country (City) International Access Code Country Code City Code	Department Name or Service Area, Website and E-Mail Address	Area Codes, Local Numbers, and Toll-Free Numbers
Sweden (Upplands Vasby) International Access Code: 00 Country Code: 46 City Code: 8	Website: support.euro.dell.com E-mail: swe_support@dell.com E-mail Support for Latitude and Inspiron: Swe-nbk_kats@dell.com E-mail Support for OptiPlex: Swe_kats@dell.com E-mail Support for Servers: Nordic_server_support@dell.com Technical Support Relational Customer Care Home/Small Business Customer Care Employee Purchase Program (EPP) Support Technical Support Fax Sales	08 590 05 199 08 590 05 642 08 587 70 527 20 140 14 44 08 590 05 594 08 590 05 185
Switzerland (Geneva) International Access Code: 00 Country Code: 41 City Code: 22	Website: support.euro.dell.com E-mail: Tech_support_central_Europe@dell.com E-mail for French-speaking HSB and Corporate Customers: support.euro.dell.com/ch/fr/emaildell/ Technical Support (Home and Small Business) Technical Support (Corporate) Customer Care (Home and Small Business) Customer Care (Corporate) Fax Switchboard	0844 811 411 0844 822 844 0848 802 202 0848 821 721 022 799 01 90 022 799 01 01
Taiwan International Access Code: 002 Country Code: 886	Technical Support (portable and desktop computers) Technical Support (servers and storage) Corporate Sales	toll-free: 00801 86 1011 toll-free: 00801 60 1256 toll-free: 00801 651 227
Thailand International Access Code: 001 Country Code: 66	Technical Support (Optiplex, Latitude, and Precision) Technical Support (PowerEdge and PowerVault) Customer Service (Penang, Malaysia) Sales	toll-free: 1800 0060 07 toll-free: 1800 0600 09 604 633 4949 toll-free: 0880 060 09

Country (City) International Access Code Country Code City Code	Department Name or Service Area, Website and E-Mail Address	Area Codes, Local Numbers, and Toll-Free Numbers
Trinidad/Tobago	General Support	1-800-805-8035
Turks and Caicos Islands	General Support	toll-free: 1-866-540-3355
U.K. (Bracknell)	Website: support.euro.dell.com	
International Access Code: 00 Country Code: 44 City Code: 1344	Customer Care website: support.euro.dell.com/uk/en/ECare/Form/Home.asp E-mail: dell_direct_support@dell.com	
	Technical Support (Corporate/Preferred Accounts/PAD [1000+ employees])	0870 908 0500
	Technical Support (direct/PAD and general)	0870 908 0800
	Global Accounts Customer Care	01344 373 186
	Home and Small Business Customer Care	0870 906 0010
	Corporate Customer Care	01344 373 185
	Preferred Accounts (500–5000 employees) Customer Care	0870 906 0010
	Central Government Customer Care	01344 373 193
	Local Government & Education Customer Care	01344 373 199
	Health Customer Care	01344 373 194
	Home and Small Business Sales	0870 907 4000
	Corporate/Public Sector Sales	01344 860 456
	Home and Small Business Fax	0870 907 4006
Uruguay	General Support	toll-free: 000-413-598-2521

Country (City) International Access Code Country Code City Code	Department Name or Service Area, Website and E-Mail Address	Area Codes, Local Numbers, and Toll-Free Numbers
U.S.A. (Austin, Texas)	Automated Order-Status Service	toll-free: 1-800-433-9014
International Access Code: 011 Country Code: 1	AutoTech (portable and desktop computers)	toll-free: 1-800-247-9362
	Consumer (Home and Home Office)	
	Technical Support	toll-free: 1-800-624-9896
	Customer Service	toll-free: 1-800-624-9897
	DellNet™ Service and Support	toll-free: 1-877-Dellnet (1-877-335-5638)
	Employee Purchase Program (EPP) Customers	toll-free: 1-800-695-8133
	Financial Services website: www.dellfinancialservices.com	
	Financial Services (lease/loans)	toll-free: 1-877-577-3355
	Financial Services (Dell Preferred Accounts [DPA])	toll-free: 1-800-283-2210
	Business	
	Customer Service and Technical Support	toll-free: 1-800-822-8965
	Employee Purchase Program (EPP) Customers	toll-free: 1-800-695-8133
	Printers and Projectors Technical Support	toll-free: 1-877-459-7298
	Public (government, education, and healthcare)	
	Customer Service and Technical Support	toll-free: 1-800-456-3355
	Employee Purchase Program (EPP) Customers	toll-free: 1-800-234-1490
	Dell Sales	toll-free: 1-800-289-3355 or toll-free: 1-800-879-3355
	Dell Outlet Store (Dell refurbished computers)	toll-free: 1-888-798-7561
	Software and Peripherals Sales	toll-free: 1-800-671-3355
	Spare Parts Sales	toll-free: 1-800-357-3355
	Extended Service and Warranty Sales	toll-free: 1-800-247-4618
	Fax	toll-free: 1-800-727-8320
	Dell Services for the Deaf, Hard-of-Hearing, or Speech-Impaired	toll-free: 1-877-DELLTY (1-877-335-5889)
U.S. Virgin Islands	General Support	1-877-673-3355
Venezuela	General Support	8001-3605

Index

A

audio. *See* sound

B

battery
 problems, 21
 replacing, 86

BIOS, 82

booting to a USB device, 18

C

CD drive
 adding, 70
 problems, 22

CD-RW drive
 problems, 23

CDs
 copying, 16

Check Disk, 24

computer
 back view, 53
 crashes, 26-27
 front view, 51
 restore to previous operating
 state, 46
 stops responding, 26

computer cover
 removing, 55
 replacing, 78

conflicts
 resolving software and
 hardware
 incompatibilities, 49

copying CDs and DVDs
 general information, 16
 helpful tips, 17
 how to, 16

D

Dell
 contacting, 90

Dell Diagnostics, 43

Dell support policy, 88

Dell Support website, 10, 28

diagnostic lights, 39

diagnostics, Dell, 43

display. *See* monitor

documentation
 finding, 9
 help file, 9
 online, 10
 setup diagram, 9

drivers, 45
 about, 45
 identifying, 45

drives
 problems, 21

DVD drive
 problems, 23

DVDs
 copying, 16

E

e-mail
 problems, 24

error messages
 diagnostic lights, 39

Express Service Code, 9

F

Files and Settings Transfer
 Wizard, 13

fixing problems
 Dell Diagnostics, 43

floppy drive
 problems, 21

H

hard drive
 problems, 24

hardware
 problems, 28

Hardware Troubleshooter, 49

Help and Support Center, 10

help files
 accessing, 9, 21
Hyper-Threading, 17

I

IEEE 1394
 problems, 29
Internet
 problems, 24
Internet connection
 about, 14
 options, 14
 setting up, 15
IRQ conflicts, 49

K

keyboard
 problems, 30

L

lights
 back of computer, 39
 diagnostic, 39

M

memory
 adding, 75
messages
 error, 25
Microsoft License Label, 9

modem
 problems, 24
monitor
 blank, 36
 hard to read, 37
 problems, 36

N

network
 problems, 31

O

operating system
 reinstalling Windows XP, 47

P

password
 clearing system setup, 85
PC Restore, 48
power
 problems, 32
 turning off your computer, 18
power light
 conditions, 32
printer
 cable, 11
 connecting, 11
 parallel, 11
 problems, 33
 setting up, 11
 USB, 12

problems
 battery, 21
 blue screen, 27
 CD drive, 22
 CD-RW drive, 23
 computer crashes, 26-27
 computer stops responding, 26
 drives, 21
 DVD drive, 23
 e-mail, 24
 error messages, 25
 finding solutions, 19
 floppy drive, 21
 general, 26
 hard drive, 24
 hardware, 28
 IEEE 1394, 29
 Internet, 24
 keyboard, 30
 modem, 24
 monitor hard to read, 37
 monitor is blank, 36
 network, 31
 other, 28
 power, 32
 power light conditions, 32
 printer, 33
 program crashes, 27
 program stops responding, 27
 programs and Windows
 compatibility, 27
 restore to previous operating
 state, 46
 scanner, 34
 screen hard to read, 37
 screen is blank, 36
 software, 27
 sound and speakers, 35

problems (*continued*)
troubleshooting chart, 19
video and monitor, 36
volume adjusting, 35

Program Compatibility
Wizard, 27

R

reinstalling
Windows XP, 47

S

safety instructions, 7
scanner
problems, 34
screen. *See* monitor
settings
system setup, 82
setup diagram, 9
shutting down your
computer, 18
software
Hyper-Threading, 17
problems, 27
sound
problems, 35
volume, 35
speaker
problems, 35
volume, 35
specifications, 79

support
contacting Dell, 90
System Restore, 46
system setup, 82

T

Tell Me How help file
accessing, 21
troubleshooting
conflicts, 49
Dell Diagnostics, 43
diagnostic lights, 39
Hardware Troubleshooter, 49
Help and Support Center, 10
restore to previous operating
state, 46
troubleshooting. *See*
problems
turning off your computer, 18

U

USB devices, booting to, 18

V

video
problems, 36
voltage selection switch, 55
volume
adjusting, 35

W

Windows XP
Device Driver Rollback, 46
Hardware Troubleshooter, 49
Help and Support Center, 10
help, accessing, 21
Hyper-Threading, 17
Program Compatibility
Wizard, 27
reinstalling, 47
scanner, 34
System Restore, 46
wizards
Program Compatibility
Wizard, 27

