

Cello

Digital Servo Drive Cable Kits

 <p>Main Feedback: CBL-DFDBK (general purpose) CBL-DFDBK-5</p>	 <p>Encoder: CBL-MTRENC2 (for SAR, SA,SB,SC) CBL-MTRENC2-5</p>
 <p>Encoder: CBL-MTRENC4 (for SE) CBL-MTRENC4-5</p>	 <p>Aux. Feedback: CBL-CELAUX CBL-CELAUX-5</p>
 <p>General I/O: CBL-CELIO1 (J1) CBL-CELIO1-5</p>	 <p>General I/O: CBL-CELIO2 (J2) CBL-CELIO2-5</p>
 <p>Aux. Power: CBL-CEL24 CBL-CEL24-5</p>	 <p>Motor Power Cable: CBL-MTRPWRCEL (General Purpose) CBL-MTRPWRCEL-5</p>
 <p>Motor Power: CBL-MTRPWR1CEL (for SAR, SA,SB,SC) CBL-MTRPWR1CEL-5</p>	 <p>Motor Power: CBL-MTRPWR2CEL (for SE) CBL-MTRPWR2CEL-5</p>
 <p>RS-232 Com.: CBL-RJ452321 CBL-RJ452321-5</p>	 <p>CAN Com.: CBL-RJ45CAN1 CBL-RJ45CAN1-5</p>
 <p>CAN Com.: CBL-RJ45CAN2 CBL-RJ45CAN2-5</p>	

Important Notice

This guide is delivered subject to the following conditions and restrictions:

- This guide contains proprietary information belonging to Elmo Motion Control Ltd. Such information is supplied solely for the purpose of assisting users of Elmo's Cello servo drives in assembling the required cables for their drive.
- The text and graphics included in this manual are for the purpose of illustration and reference only. The specifications on which they are based are subject to change without notice.
- Information in this document is subject to change without notice.

Doc. No. MAN-CBLKIT-CEL
Copyright ©2004
Elmo Motion Control Ltd.
All rights reserved.

Revision History

Document version 1.0: November 2004 (MAN-CBLKIT-CEL.pdf)

Elmo Motion Control Inc.
1 Park Drive, Suite 12
Westford, MA 01886
USA
Tel: +1 978 399-0034
Fax: +1 978 399-0035
info-us@elmomc.com

Elmo Motion Control GmbH
Steinbeisstrasse 41
D-78056, Villingen-Schwenningen
Germany
Tel: +49 07720 8577-60
Fax: +49 07720 8577-70
info-de@elmomc.com

Elmo
Motion Control
www.elmomc.com

Contents

1. Introduction	1
1.1 Cello Connectors	1
1.2 Cable Cross-Reference	2
2. Cable Kits	3
3. Main Feedback Cables	4
3.1 Gen.-Purpose Main Feedback Cable (CBL-DFDBK-5)	4
3.2 Encoder Cable (CBL-MTRENC2-5 for SAR, SA, SB, SC)	5
3.3 Encoder Cable (CBL-MTRENC4-5 for SE)	6
4. Auxiliary Feedback Cable (CBL-CELAUX-5)	7
5. General I/O J1 (CBL-CELIO1-5)	8
6. General I/O J2 (CBL-CELIO2-5)	9
7. Auxiliary Power Cable (CBL-CEL24-5)	10
8. Motor Power Cables	10
8.1 Motor Power Cable (CBL-MTRCEL-5)	10
8.2 Motor Power Cable (CBL-MTRPWR1CEL-5)	11
8.3 Motor Power Cable (CBL-MTRPWR2CEL-5)	11
9. Communication Cables	12
9.1 RS-232 Option (CBL-RJ452321-5)	12
9.2 CAN Option (CBL-RJ45CAN1-5)	13
9.3 CAN Option (CBL-RJ45CAN2)	14

1. Introduction

This document provides the wiring details for the cables used to connect Cello digital servo drives with the end-user application. The servo drive-side pinouts are provided in Chapter 3 of the drive’s installation guide.

The cables come in two lengths: 2 meters (6 ½ feet) and 5 meters (16 ½ feet). The cable length is indicated in the cable part number by use of an extended suffix to indicate 5 meter length. For example, cable CBL-CELAUX is a 2 meter cable while CBL-CELAUX-5 is a 5 meter cable.

CBL-RJ45CAN2, is an exception, it is only 20 cm long.

1.1 Cello Connectors

The following connectors are used for wiring the Cello.

Type	Function	Port	Connector Location
5-pin Phoenix (1 st two pins) (provided)	Power	VP+, PR	<p>The diagram shows a power connector with a 24V supply terminal, three ground screws labeled PE, and a 5-pin Phoenix connector. The Phoenix connector pins are labeled VP+, PR, M1, M2, and M3. Arrows point from the labels 'Optional Back-up Supply', 'Ground', and 'Power & Motor' to their respective locations on the connector.</p>
5-pin Phoenix (last 3 pins) (provided)	Motor	M1, M2, M3	
3 ground screws	Ground	PE, PE, PE	
2-pin Phoenix (provided)	Optional Back-up Supply	24 VDC	

Table 1-1: The Cello’s Power Connectors

Type	Function	Port	Connector Location
15-pin D-Sub	Feedback A	Feedback A	<p>The diagram shows three 15-pin D-Sub connectors on the Cello. From left to right, they are labeled J2, J1, and Feedback A. Arrows point from the labels 'J2: I/O', 'J1: I/O', and 'Feedback A' to their respective connectors.</p>
15-pin D-Sub (high-density)	General I/O	J1	
15-pin D-Sub (high-density)	General I/O	J2	

Table 1-2: The Cello’s I/O and Feedback A Connectors

Type	Function	Port	Connector Location
8-pin RJ-45	CANopen	CAN	
8-pin RJ-45	CANopen	CAN	
15-pin D-Sub (high-density)	Feedback B	Feedback B	
8-pin RJ-45	RS-232	RS-232	

Table 1-3: The Cello’s Communications and Feedback B Connectors

1.2 Cable Cross-Reference

Cable Application	Cable Part. No.	No. of Pins	Label on Cello	pg
Main Feedback (gnrl-purpose)	CBL-DFDBK-5	15	FEEDBACK A	4
Encoder (for SAR, SA, SB, SC)	CBL-MTRENC2-5	15		5
Encoder (for SE)	CBL-MTRENC4-5	15		6
Auxiliary Feedback	CBL-CELAUX-5	15	FEEDBACK B	7
General I/O 1	CBL-CELIO1-5	15	J1	8
General I/O 2	CBL-CELIO2-5	15	J2	9
Auxiliary Power	CBL-CEL24-5	2	24v	10
Motor Power (gnrl-purpose)	CBL-MTRPWRCEL-5	4	PE/M1 /M2/M3	10
Motor Power (for SAR, SA, SB, SC)	CBL-MTRPWR1CEL-5	4		11
Motor Power (for SE)	CBL-MTRPWR2CEL-5	4		11
RS-232 Communications	CBL-RJ452321-5	8	RS232	12
CAN Communications	CBL-RJ45CAN1-5	8	CAN	13
CAN Communications	CBL-RJ45CAN2-5	8	CAN	14

2. Cable Kits

Several Cable Kits can be purchased from Elmo. Each contain a set of 8 cables. The -5 suffix on the kits and on the cables (CBL-DFDBK-5 for example) indicate that the cables are 5m long. Cables and kits without that suffix are 2m long (except for CBL-RJ45CAN2 which is 20cm long). **Customers may purchase cables in kits, or individually in multiples of 10 each.** The contents of the kits are listed below:

Cable Application	Cable Part. No.	CBL-CELKIT01 -CELKIT01-5	CBL-CELKIT02 -CELKIT02-5
Main Feedback (gnrl-purpose)	CBL-DFDBK-5	1	-
Encoder (for SAR, SA, SB, SC)	CBL-MTRENC2-5	-	1
Encoder (for SE)	CBL-MTRENC4-5	-	-
Auxiliary Feedback	CBL-CELAUX-5	1	1
General I/O 1	CBL-CELIO1-5	1	1
General I/O 2	CBL- CELIO2-5	1	1
Auxiliary Power	CBL-CEL24-5	1	1
Motor Power (general-purpose)	CBL-MTRPWRCEL-5	1	-
Motor Power (SAR, SA, SB, SC)	CBL-MTRPWR1CEL-5	-	1
Motor Power (for SE)	CBL-MTRPWR2CEL-5	-	-
RS-232 Communications	CBL-RJ452321-5	1	1
CAN Communications	CBL-RJ45CAN1-5	1	1
CAN Communications	CBL-RJ45CAN2-5	-	-

3. Main Feedback Cables

The main feedback cables are made of 24-AWG shielded cable. There are 3 types of feedback cables, all use a 15-pin D-sub plug which connects to the FEEDBACK A port on the Cello.

- The General-Purpose Main Feedback Cable (CBL-DFDBK) is open on the motor side so that it can be connected to customer-specific connectors.
- Encoder Cable CBL-MTRENC2 has a 15-pole socket on the motor side for Metronix APM-SAR, SA, SB and SC motors.
- Encoder Cable CBL-MTRENC4 has a 17-pole Amphenol socket on the motor side for Metronix APM-SE motors.

3.1 Gen.-Purpose Main Feedback Cable (CBL-DFDBK-5)



Pin No.	Color	Pairs		
1	Green	pair	 <p>15 Pin D-sub Plug</p>	
10	Yellow			
2	Pink			
3	White	pair		
4	Brown			
5	Orange	pair		
6	Cyan			
7	Blue	pair		
8	Red			
9	-			
11	-			
12	-			
13	-			
14	Black	pair		 <p>The specific functionality of each pin is fully outlined in the <i>Cello Installation Guide</i>.</p>
15	Purple			



Figure 1: Single-sided Main Feedback Cable (Part No. CBL-DFDBK-5)

3.2 Encoder Cable (CBL-MTRENC2-5 for SAR, SA, SB, SC)

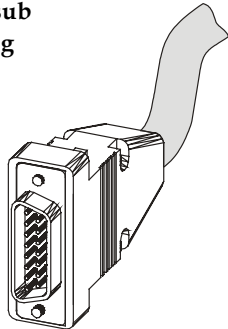
D-Type Pin No.	Color	Socket Pin No.	Signal	Pair	Description	
1	Green	11	HC	pair	Hall sensor C input	 <p>15 Pin D-sub Plug</p>
10	Yellow	9	HB		Hall sensor B input	
2	Pink	7	HA		Hall sensor A input	
3	White	14	SUPRET	pair	Supply return	
4	Brown	13	+5V		Encoder\Hall supply +5 V	
5	Orange	2	CHA-	pair	Channel A complement	
6	Cyan	1	CHA		Channel A	
7	Blue	6	INDEX-	pair	Index complement	 <p>Pin No.5 Socket Connector Pin No.1</p>
8	Red	5	INDEX		Index	
9	-	-	-		-	
11	-		-			
12	-		-			
13	-		-			
14	Black	4	CHB-	pair	Channel B complement	
15	Purple	3	CHB		Channel B	



Figure 2: Encoder Cable (Part No. CBL-MTRENC2-5 for Metronix SAR, SA, SB, SC motors)

3.3 Encoder Cable (CBL-MTRENC4-5 for SE)

D-Type Pin No.	Color	Socket Pin No.	Signal		Description		
1	Green	P	HC	pair	Hall sensor C input	 <p>15 Pin D-sub Plug</p>	
10	Yellow	M	HB		Hall sensor B input		
2	Pink	K	HA		Hall sensor A input		
3	White	G	SUPRET	pair	Supply return		
4	Brown	H	+5V		Encoder\Hall supply +5 V		
5	Orange	B	CHA-	pair	Channel A complement		
6	Cyan	A	CHA		Channel A		
7	Blue	F	INDEX-	pair	Index complement		 <p>17 Pin Amphenol Socket</p>
8	Red	E	INDEX		Index		
9	-	-	-		-		
11	-	-	-		-		
12	-	-	-		-		
13	-	-	-		-		
14	Black	D	CHB-	pair	Channel B complement		
15	Purple	C	CHB		Channel B		
-	Drain Wire	J	PE		Drain Wire Connection		

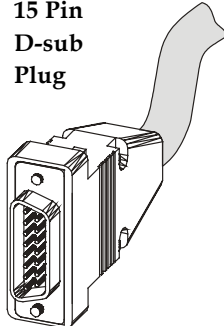
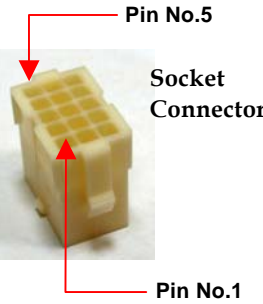

Figure 3: Encoder Cable (Part No. CBL-MTRENC4-5 for Metronix SE motors)

4. Auxiliary Feedback Cable (CBL-CELAUX-5)

The auxiliary feedback cable is a 24-AWG shielded cable. It is connected using an 15-pin Hi-density D-sub plug which connects to the Cello’s FEEDBACK B port.

Four options – described in the Auxiliary Feedback section of the *Cello Installation Guide* – are available for auxiliary feedback:

- Main encoder buffered outputs
- Differential encoder inputs
- Single-ended encoder input
- Pulse-and-direction input

The general pinout of the auxiliary feedback cable is as follows:

Port	Pin	Color	Pair	Description	Pin Position
B1	1	Cyan	pair	see Installation Guide	 <p>15 Pin high density D-Sub Plug</p> <p>The specific functionality of each pin is fully outlined in the <i>Cello Installation Guide</i>.</p>
B1	2	Orange			
B1	3	Purple	pair	see Installation Guide	
B1	4	Black			
B1	5	Red	pair	see Installation Guide	
B1	10	Blue			
B2	6	Pink	pair	see Installation Guide	
B2	7	Grey			
PWR	8	Brown	pair	+5V	
PWR	9	White		SUPRET	
B2	11	Yellow	pair	see Installation Guide	
B2	12	Green			
B2	13	White/Red	pair	see Installation Guide	
B2	14	White/Black			
PWR	15	White/Yellow		see Installation Guide	



Figure 4: Auxiliary Feedback Cable (Part No. CBL-CELAUX-5)

5. General I/O J1 (CBL-CELIO1-5)

The digital input cable is a 24-AWG shielded cable. It is connected using an 15-pin Hi-Density D-sub socket.

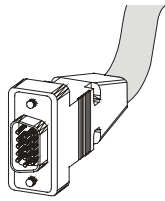
Pin	Color	Signal	Pair	Function	Pin Position
1	Orange	IN1	pair	Programmable input 1	 <p>15 Pin D-sub Socket</p>
2	Cyan	IN2		Programmable input 2	
3	Purple	IN3	pair	Programmable input 3	
8	Black	IN8		Programmable input 8	
4	Gray	OUT2	pair	Programmable output 2	
5	Pink	OUT3		Programmable output 3	
6	Blue	IN4	pair	Programmable input 4	
7	Red	IN7		Programmable input 7	
9	White/ Yellow	INRET		General input return	
10	White/ Red	OUTRET2-3		Programmable output return 2 & 3	
11	Yellow	OUT4	pair	Programmable output 4	
13	Green	OUT5		Programmable output 5	
12	White/ Black	OUTRET4-5		Programmable output return 4 & 5	
14	Brown	OUT1	pair	Programmable output 1	
15	White	OUTRET 1		Programmable output return 1	



Figure 5: General Purpose I/O Cable (Part No. CBL-CELIO1-5)

6. General I/O J2 (CBL-CELIO2-5)

The digital output cable is a 26-AWG shielded cable. It is connected using a 15-pin Hi-Density D-sub plug.

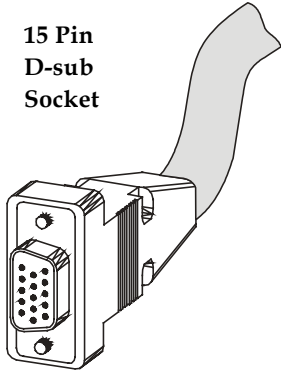
Pin	Color	Signal	Pair	Function	Pin Position
1	Orange	IN5	pair	Programmable input 5	 <p>15 Pin Hi-Density D-sub Plug</p>
6	Cyan	INRET5		Programmable input return 5	
2	Purple	IN6	pair	Programmable input 6	
7	Black	INRET6		Programmable input return 6	
3	Blue	IN9	pair	Programmable input 9	
8	Red	INRET9		Programmable input return 9	
4	Pink	IN10	pair	Programmable input 10	
9	Gray	INRET10		Programmable input return 10	
5	Yellow	ANLIN1+	pair	Analog input 1	
10	Green	ANLIN1-		Analog input 1	
11	Brown	ANLIN2+	pair	Analog input 2	
12	White	ANLIN2-		Analog input 2	
13	White/ Black	ANLRET	pair	Analog return	
14	White/ Red	ANLRET		Analog return	
15	White/ Yellow	SUPRET		Supply return	



Figure 6: General Purpose I/O Cable (Part No CBL-CELIO2-5)

7. Auxiliary Power Cable (CBL-CEL24-5)

The auxiliary power cable is a 24-AWG shielded cable terminated by pins on the *SimplIQ* side. The pins are screwed into the 2-pole Pheonix Terminal Block provided with the Cello.

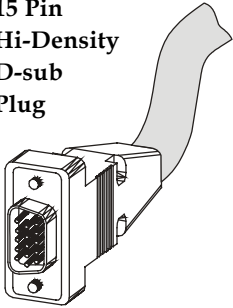
Pin No.	Color	Twisted & Shielded Wire	Signal	Description
1	Red	Pair	+24VDC	+24 VDC auxiliary power supply
2	Black		RET24VDC	Return (common) of 24 VDC auxiliary power supply



Figure 7: Auxiliary Power Cable (Part No. CBL-CEL24-5)

8. Motor Power Cables

There are three types of power cables:

8.1 Motor Power Cable (CBL-MTRPWRCEL-5)

CBL-MTRPWRCEL is a general-purpose motor power cable. It is made from four 14-AWG shielded wires with pin terminals on the Cello drive. The pins are connected to the Pheonix Terminal Block supplied with the Cello. The other end is open so that it can be attached to a customer-specific connector.

Color	Signal	Description
White	M1	Motor Phase 1 (U)
Black	M2	Motor Phase 2 (V)
Red	M3	Motor Phase 3 (W)
Green	PE	Ground

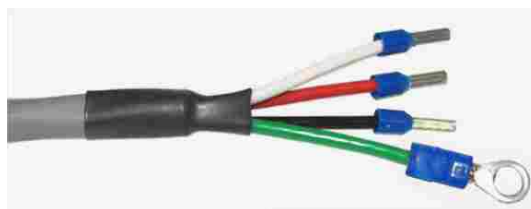

Figure 8: General-Purpose Motor Power Cable (Part No. CBL-MTRPWRCEL-5)

8.2 Motor Power Cable (CBL-MTRPWR1CEL-5)

CBL-MTRPWR1CEL-5 is a 24-AWG shielded cable in which each wire, on the *SimplIQ* drive side, is connected to a pin terminal and the wires on the motor side are connected to a 4-pole socket. This cable is designed for connecting a Cello to a Metronix APM-SAR, SA, SB or SC motor.

Color	Signal Drive Side	Description	AMP Pin No. Motor Side
Brown & White	M1	Motor Phase 1 (U)	1
Pink & Grey	M2	Motor Phase 2 (V)	2
Blue & Red	M3	Motor Phase 3 (W)	3
Green & Yellow	PE	Ground	4



Figure 9: SAR, SA, SB, SC-type Motor Power Cable (Part No. CBL-MTRPWR1CEL-5)

8.3 Motor Power Cable (CBL-MTRPWR2CEL-5)

CBL-MTRPWR2CEL is designed to provide power to Metronix SE motors. It is made from four 14-AWG shielded wires with pin terminals on the Cello side. The other end has an Amphenol 4-pole socket so that it can be attached to an Amphenol plug on the motor.

Color	Signal Drive Side	Description	Amphenol Pin No. Motor Side
White	M1	Motor Phase 1 (U)	A
Black	M2	Motor Phase 2 (V)	B
Red	M3	Motor Phase 3 (W)	C
Green	PE	Ground	D



Figure 10: SE-type Motor Power Cable (Part No. CBL-MTRPWR2CEL-5)

9. Communication Cables

The communication cables use 26-AWG twisted pair shielded cable. They are connected using an 8-pin RJ-45 plug. Elmo drives can communicate using the following options:

- RS-232, full duplex
- CANopen

9.1 RS-232 Option (CBL-RJ452321-5)

RJ45 Pin No.	Color	D-type Female Pin No.	Signal	Description
3	Brown	2	Tx	RS-232 transmit
5	White	5	COMRET	Communication return
6	Green	3	Rx	RS-232 receive
body	Drain Wire	body	shield	cable shield

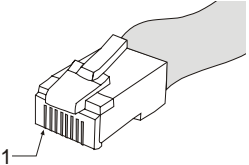



The shields of the RJ-45 and D-type plugs are connected to each other through the cable braid.



Figure 11: RS-232 Communications Cable (Part No. CBL-RJ452321-5)

9.2 CAN Option (CBL-RJ45CAN1-5)

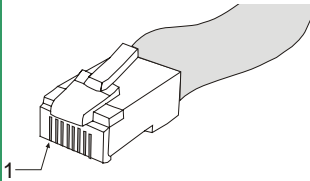
RJ45 Pin No.	Color	D-type Female Pin No.	Signal	Description
1	Green	7	CAN-H	CAN_H bus line
2	Yellow	2	CAN_L	CAN_L bus line
3	White	3	CAN_GND	CAN ground
4	—	—	—	—
5	—	—	—	—
7	—	—	—	—
8	—	—	—	—
body	Drain Wire	body	shield	cable shield



The shields of the RJ-45 and D-type plugs are connected to each other through the cable braid.

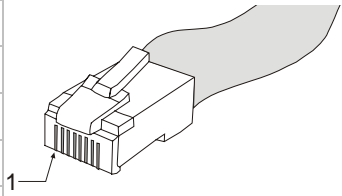

Figure 12: CAN Cable (Part No. CBL-RJ45CAN1-5)

9.3 CAN Option (CBL-RJ45CAN2)

Cable CBL-RJ45CAN2 is 20 cm long, it is used for “daisy-chaining” CAN nodes. On the Harmonica this cable is connected to the External Dual Can Port.

RJ45 Pin No.	Color	RJ45 Pin No.	Signal	Description
1	Green	1	CAN-H	CAN_H bus line
2	Yellow	2	CAN_L	CAN_L bus line
3	White	3	CAN_GND	CAN ground
4	—	—	—	—
5	—	—	—	—
7	—	—	—	—
8	—	—	—	—
body	Drain Wire	body	shield	cable shield



 The shields of the two RJ-45 plugs are connected to each other through the cable braid.



Figure 13: CAN Cable (Part No. CBL-RJ45CAN2)