



# Power Macintosh User's Guide



*Includes setup, troubleshooting, and important health-related information for Power Macintosh 8100 series computers*

 Apple Computer, Inc.

© 1994 Apple Computer, Inc. All rights reserved.

Under the copyright laws, this manual may not be copied, in whole or in part, without the written consent of Apple. Your rights to the software are governed by the accompanying software license agreement.

The Apple logo is a trademark of Apple Computer, Inc., registered in the U.S. and other countries. Use of the “keyboard” Apple logo (Option-Shift-K) for commercial purposes without the prior written consent of Apple may constitute trademark infringement and unfair competition in violation of federal and state laws.

Every effort has been made to ensure that the information in this manual is accurate. Apple is not responsible for printing or clerical errors.

Apple Computer, Inc.  
1 Infinite Loop  
Cupertino, CA 95014-2084  
(408) 996-1010

Apple, the Apple logo, AppleScript, AppleShare, AppleTalk, ImageWriter, Inter•Poll, LaserWriter, LocalTalk, Macintosh, MacTerminal, and StyleWriter are trademarks of Apple Computer, Inc., registered in the U.S. and other countries.

Apple Desktop Bus, AudioVison, Balloon Help, Disk First Aid, Finder, GeoPort, Macintosh PC Exchange, PlainTalk, Power Macintosh, PowerTalk, and QuickDraw GX are trademarks of Apple Computer, Inc.

Adobe, Adobe Illustrator, and PostScript are trademarks of Adobe Systems Incorporated, registered in the United States. Adobe Photoshop is a trademark of Adobe Systems Incorporated.

ExposurePro is a registered trademark of Baseline Publishing, Inc.

Helvetica and Times are registered trademarks of Linotype-Hell Company.

IBM is a registered trademark of International Business Machines Corporation.

Motorola is a registered trademark of Motorola Corporation.

NuBus is a trademark of Texas Instruments.

PowerPC and the PowerPC logo are trademarks of International Business Machines Corporation, used under license therefrom.

QMS is a registered trademark and ColorScript is a trademark of QMS, Inc.

QuarkXPress is a registered trademark of Quark, Inc.

SuperPaint is a registered trademark of Aldus Corporation.

Tektronix is a registered trademark and Phaser is a trademark of Tektronix, Inc.

Simultaneously published in the United States and Canada.

Mention of third-party products is for informational purposes only and constitutes neither an endorsement nor a recommendation. Apple assumes no responsibility with regard to the performance or use of these products.



# Contents



Communications regulation information vi

**Preface Welcome to Power Macintosh ix**

**1 Getting Started 1**

Plugging in the computer 1

Installing an expansion card 3

Connecting a monitor 3

Connecting the mouse and keyboard 8

Connecting other equipment 9

Turning the computer on 10

Problems turning your computer on? 13

What's next? 14

Learning the basics 15

Reviewing the basics 16

Turning the computer off 17

Where to find answers 18

<b>2</b>	<b>Getting Help</b>	<b>19</b>
	Getting answers to your questions	20
	Identifying objects on the screen	28
	Learning useful shortcuts	29
<b>3</b>	<b>Connecting Additional Equipment</b>	<b>31</b>
	Your computer at a glance	31
	Connecting audio equipment	34
	Connecting video equipment	39
	Expanding memory	49
	Installing internal drives	50
<b>4</b>	<b>Installing and Using Application Programs</b>	<b>51</b>
	Installing application programs	51
	Working with several programs at a time	53
	Backing up your files	54
	Using Power Macintosh application programs	55
	Using older Macintosh programs	56
<b>5</b>	<b>Troubleshooting</b>	<b>57</b>
	When you have questions	57
	When you run into trouble	57
	Solutions to common problems	61
	If your computer's performance decreases	73
	Solving printer problems	74
	Choosing the correct networking software	75
	If you have trouble using a monitor with an AV-equipped Power Macintosh	76
	Initializing a hard disk	81
	Repairing a damaged disk	85
	Installing or reinstalling system software	90

<b>Appendix A</b>	<b>Health, Safety, and Maintenance Tips</b>	<b>99</b>
	Health-related information about computer use	99
	Safety instructions	104
	Handling your computer equipment	105
	Cleaning your equipment	109
<b>Appendix B</b>	<b>Installing an Expansion Card</b>	<b>111</b>
	Installing a card with a DAV connector in your AV-equipped Power Macintosh computer	112
	NuBus power requirements	113
	Installing a NuBus card	113
<b>Appendix C</b>	<b>Special Keys on Your Keyboard</b>	<b>121</b>
	<b>Index</b>	<b>123</b>

## Communications regulation information

### FCC statement

This equipment has been tested and found to comply with the limits for a Class B digital device in accordance with the specifications in Part 15 of FCC rules. See instructions if interference to radio or television reception is suspected.

### Radio and television interference

The equipment described in this manual generates, uses, and can radiate radio-frequency energy. If it is not installed and used properly—that is, in strict accordance with Apple’s instructions—it may cause interference with radio and television reception.

This equipment has been tested and found to comply with the limits for a Class B digital device in accordance with the specifications in Part 15 of FCC rules. These specifications are designed to provide reasonable protection against such interference in a residential installation. However, there is no guarantee that interference will not occur in a particular installation.

You can determine whether your computer system is causing interference by turning it off. If the interference stops, it was probably caused by the computer or one of the peripheral devices.

If your computer system does cause interference to radio or television reception, try to correct the interference by using one or more of the following measures:

- Turn the television or radio antenna until the interference stops.
- Move the computer to one side or the other of the television or radio.
- Move the computer farther away from the television or radio.
- Plug the computer into an outlet that is on a different circuit from the television or radio. (That is, make certain the computer and the television or radio are on circuits controlled by different circuit breakers or fuses.)

If necessary, consult an Apple-authorized service provider or Apple. See the service and support information that came with your Apple product. Or, consult an experienced radio/television technician for additional suggestions. You may find the following booklet helpful: *Interference Handbook* (stock number 004-000-00493-1). This booklet, prepared by the Federal Communications Commission, is available from the U.S. Government Printing Office, Washington, DC 20402.

**IMPORTANT** Changes or modifications to this product not authorized by Apple Computer, Inc., could void the FCC Certification and negate your authority to operate the product.

This product was tested for FCC compliance under conditions that included the use of Apple peripheral devices and Apple shielded cables and connectors between system components. It is important that you use Apple peripheral devices and shielded cables and connectors between system components to reduce the possibility of causing interference to radios, television sets, and other electronic devices. You can obtain Apple peripheral devices and the proper shielded cables and connectors through an Apple-authorized dealer. For non-Apple peripheral devices, contact the manufacturer or dealer for assistance.

### DOC statement

*DOC Class B Compliance* This digital apparatus does not exceed the Class B limits for radio noise emissions from digital apparatus as set out in the interference-causing equipment standard entitled “Digital Apparatus,” ICES-003 of the Department of Communications.

*Observation des normes—Classe B* Cet appareil numérique respecte les limites de bruits radioélectriques applicables aux appareils numériques de Classe B prescrites dans la norme sur le matériel brouilleur : “Appareils Numériques”, NMB-003 édictée par le ministre des Communications.

### VCCI statement

#### 情報処理装置等電波障害自主規制について

この装置は、第二種情報装置（住宅地域又はその隣接した地域において使用されるべき情報装置）で住宅地域での電波障害防止を目的とした情報処理装置等電波障害自主規制協議会（VCCI）基準に適合しております。

しかし、本装置をラジオ、テレビジョン受信機に近接してご使用になると、受信障害の原因となることがあります。

取扱説明書に従って正しい取り扱いをしてください。

### CD-ROM drive

**WARNING** Making adjustments or performing procedures other than those specified in your equipment’s manual may result in hazardous exposure.

**WARNING** Do not attempt to disassemble the cabinet containing the laser. The laser beam used in this product is harmful to the eyes. The use of optical instruments, such as magnifying lenses, with this product increases the potential hazard to your eyes. For your safety, have this equipment serviced only by an Apple-authorized service provider.

If you have an internal Apple CD-ROM drive in your computer, your computer is a Class 1 laser product. The Class 1 label, located on the computer, indicates that the drive meets minimum safety requirements. A service warning label is on the CD-ROM drive inside the computer.









## Welcome to Power Macintosh



Congratulations on the purchase of your new Macintosh. Your computer is designed to give you the highest performance combined with real ease of use—it's easy to set up, easy to use, and easy to expand. This book will guide you through the setup procedure, tell you how to expand your Macintosh, and provide many tips on using your new system.

Your Macintosh computer is powered by the new **PowerPC** microprocessor (or “chip”). This microprocessor was designed by Apple Computer, Inc., Motorola, Inc., and IBM Corporation. The **PowerPC** microprocessor uses Reduced Instruction Set Computing (RISC) technology to deliver very high performance at the lowest possible cost. The **PowerPC** RISC microprocessor represents the state of the art in microprocessor design.

Your new Macintosh will run almost all your existing Macintosh software, but for best performance and greatest speed, look for the new software programs designed especially for Power Macintosh computers. You'll find Power Macintosh programs at any software store that carries products for Macintosh.

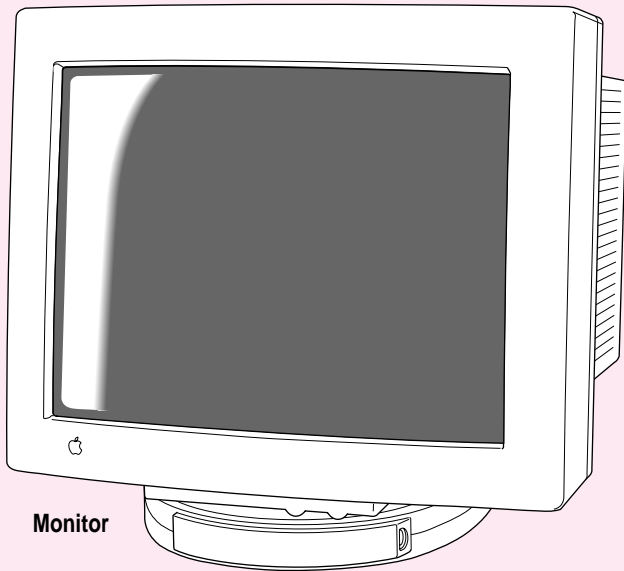

**Monitor**

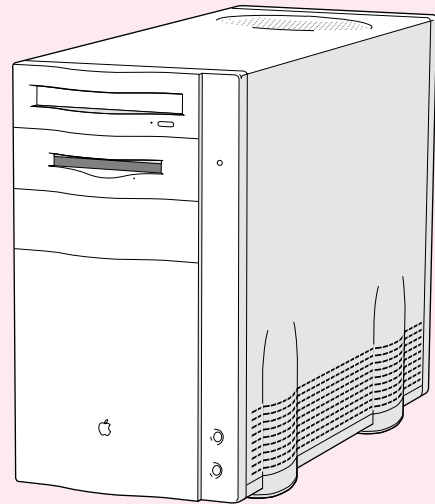

**Macintosh computer**

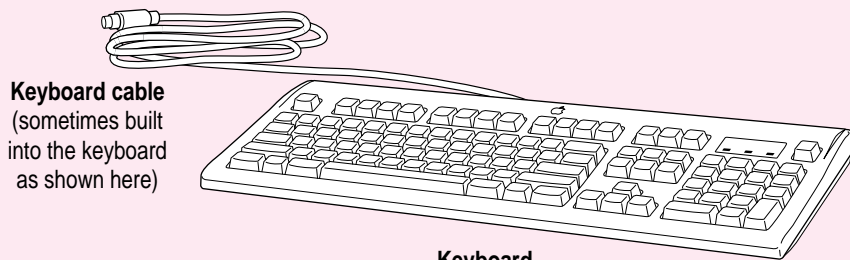

**Keyboard cable**  
(sometimes built into the keyboard as shown here)

**Keyboard**

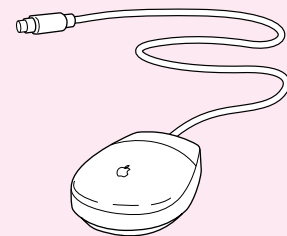

**Mouse**

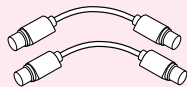

**Adapters for composite video**  
(AV-equipped Power Macintosh only)

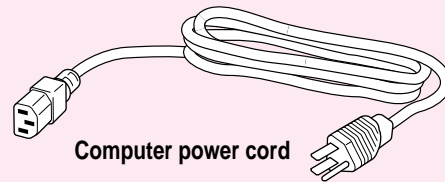

**Computer power cord**

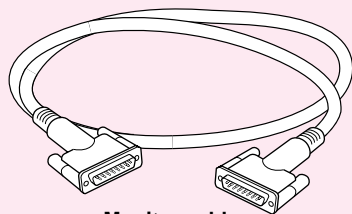

**Monitor cable**  
(sometimes built into the monitor)

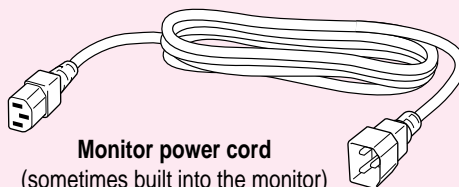

**Monitor power cord**  
(sometimes built into the monitor)

Follow the instructions in this chapter to set up your computer and learn the basics.

# 1

## Getting Started



The illustration on the facing page shows all the equipment you will need to set up your computer and begin using it. Place your equipment on a sturdy, flat surface near a grounded wall outlet. Before following the setup instructions in this chapter, you may want to read “Arranging Your Office” in Appendix A (in the section on health-related information) for tips on adjusting your work furniture so that you’re comfortable when using the computer.

### Plugging in the computer

Before you plug your Macintosh into a wall socket, carefully read all the setup instructions in this chapter. Then, before you connect anything to your Macintosh, follow the instructions in this section to plug it in. The plug grounds the computer and protects it from electrical damage while you are setting up.

When you are ready to begin, follow these steps:

- 1 Plug the socket end of the computer's power cord into the recessed power socket (marked with the symbol ~) on the back of the computer.
- 2 Plug the other end of the power cord into a three-hole grounded outlet or power strip.

**WARNING** This equipment is intended to be electrically grounded. Your Macintosh is equipped with a three-wire grounding plug—a plug that has a third (grounding) pin. This plug will fit only a grounded AC outlet. This is a safety feature. If you are unable to insert the plug into the outlet, contact a licensed electrician to replace the outlet with a properly grounded outlet. Do not defeat the purpose of the grounding plug!

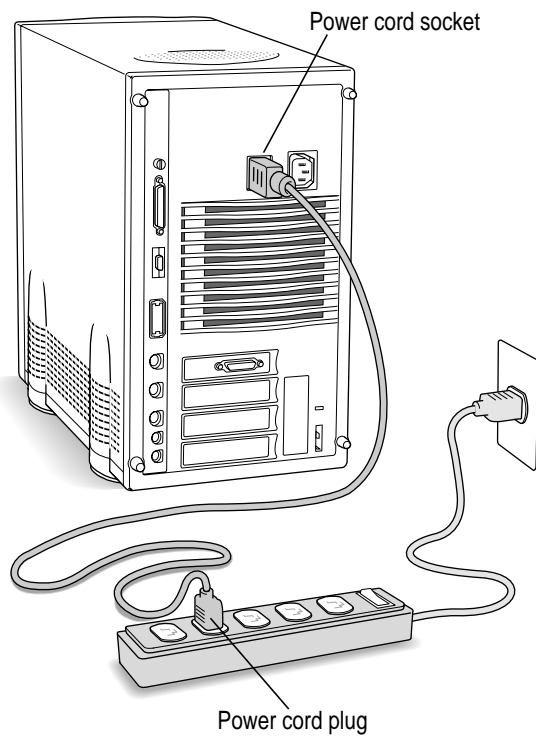

**IMPORTANT** Be sure that at least one end of the power cord is within easy reach so that you can unplug the computer when you need to.

**3 If necessary, switch the computer off.**

If you heard a tone when you plugged in the computer, the computer has started up and you need to turn it off before proceeding. Press the power switch to turn the computer off. (The power switch is located on the back of the computer and is marked with the symbol )

## Installing an expansion card

If you purchased an expansion card for your Macintosh, install it now. (See Appendix B, “Installing an Expansion Card,” for instructions.) If you don’t have an expansion card, go on to the next section, “Connecting a Monitor.”

## Connecting a monitor

You can connect many types of monitors to your Macintosh computer, including the following:

- Apple AudioVision monitors. AudioVision monitors have built-in speakers, microphone, video, and a port for connecting such input devices as a keyboard.
- Most standard monitors. See the *Technical Information* booklet that came with your computer for a complete list.

This section contains instructions on connecting both types of monitors. If you are connecting a monitor from a manufacturer other than Apple, also refer to the instructions that came with the monitor.

## Connecting the monitor power cord

Monitors have two cords to connect: a power cord and a monitor cable. To connect the monitor power cord, follow these steps:

### 1 Place the monitor next to the computer.

Keep these considerations in mind:

- Allow a few inches for air circulation around the computer and monitor.
- Make sure that the top of the screen is slightly below eye level when you're sitting at the keyboard.
- Position the monitor to minimize glare and reflections on the screen from overhead lights and windows.

For further suggestions about locating your computer equipment, consult "Arranging Your Office" in Appendix A (in the section on health-related information).

### 2 Connect the monitor power cord to the monitor.

On some monitors, the cord is already attached.

**3 Plug in the monitor power cord.**

Some monitor power cords are designed to plug into the back of your computer. If you have an Apple AudioVision monitor, be sure to plug the monitor power cord into the back of the computer, not into an outlet.

Some monitor power cords must be connected to a grounded electrical outlet, not to the computer. Check the information that came with the monitor.

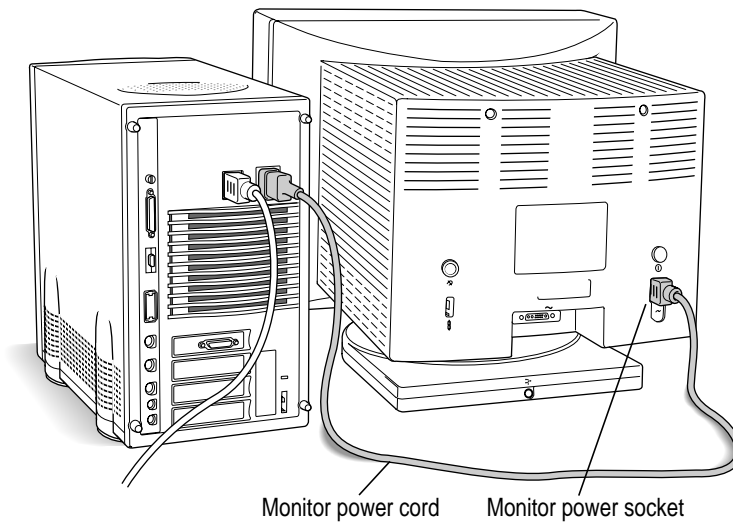

## Connecting the monitor cable

After you plug in the monitor power cord, you connect the monitor cable to the computer's monitor port. Your computer has two monitor ports: a high-density monitor port and a second monitor port. The high-density port accepts a monitor with a screen 16 inches or smaller (measured diagonally).

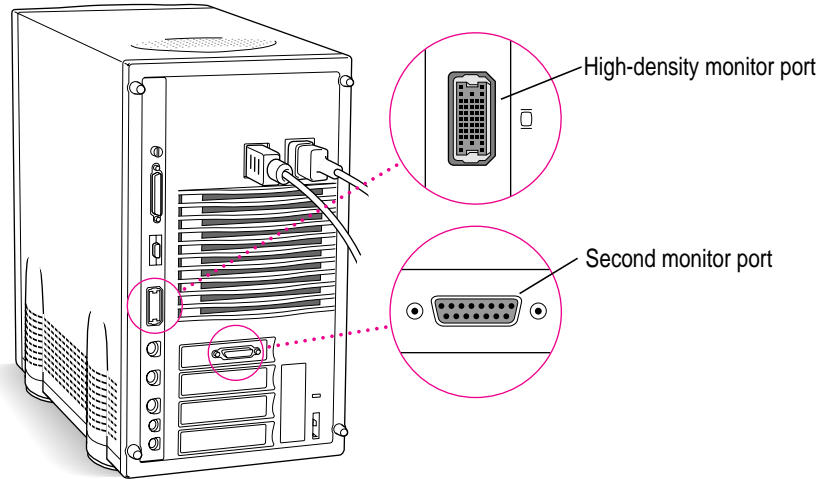

You can connect one or two monitors of either type, or one of each type.



To connect the monitor cable, follow these steps:

**1 Attach the monitor cable to the monitor.**

On some monitors, the cable is already attached.

**2 Attach the monitor cable to one of the monitor ports on the back panel of the computer.**

If you have a standard monitor, attach the monitor cable to the second monitor port. If you have an AudioVision monitor, you can attach the monitor cable to the computer's high-density monitor port. However, if you plan to use your AudioVision monitor for video digitizing, you will get better results if you use the adapter cables from the AudioVision adapter kit to attach the monitor to the second monitor port. (If you don't have the adapter kit, you can purchase it from an Apple-authorized dealer.)

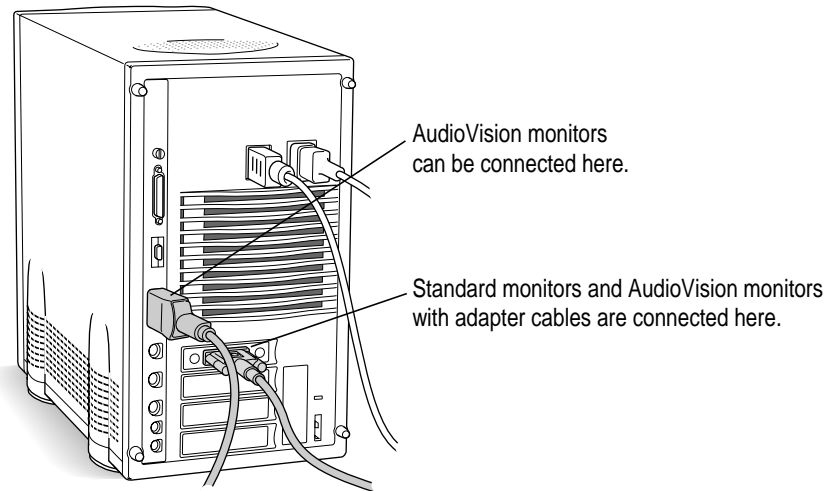

If you have an AudioVision monitor, see the information that came with the monitor to use its special features.

## Connecting the mouse and keyboard

You have a choice of several keyboards for your Macintosh. The way you connect the mouse and keyboard depends on whether the keyboard has a separate cable or a built-in cable.

### Connecting a keyboard with a separate cable

- 1 Plug the mouse cable into the port on either side of the keyboard.**

Most right-handed people prefer to use the mouse with their right hand; most left-handed people prefer to use their left hand. Plug the mouse into the port on the side you prefer.

The plug and the port are marked with the  icon (symbol). Align the symbols before you insert the plug. (The positions of the port and icon on your keyboard may be different from those pictured here.)

*By the way:* A port marked with the  icon is called an Apple Desktop Bus (ADB) port.

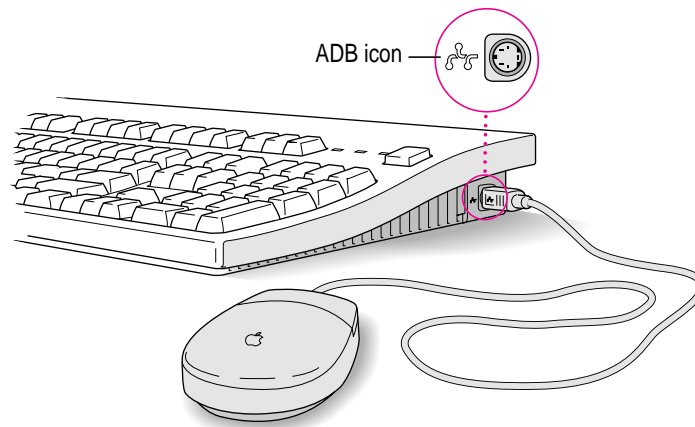

- 2 Plug the keyboard cable (both ends are the same) into the other port on the keyboard.**

If you plugged the mouse cable in on the right, for example, plug the keyboard cable in on the left.

- 3 Plug the keyboard cable into the port marked with the  icon on the back of the computer.**

Some monitors have a port to which you can connect the keyboard or mouse. See the information that came with your monitor.

## Connecting a keyboard with a built-in cable

- 1 Plug the mouse cable into the recessed port on the back of the keyboard.**

The plug and the port are marked with the ⌘ icon (symbol). The positions of the port and icon on your keyboard may be different from those pictured.

*By the way:* A port marked with the ⌘ icon is called an Apple Desktop Bus (ADB) port.

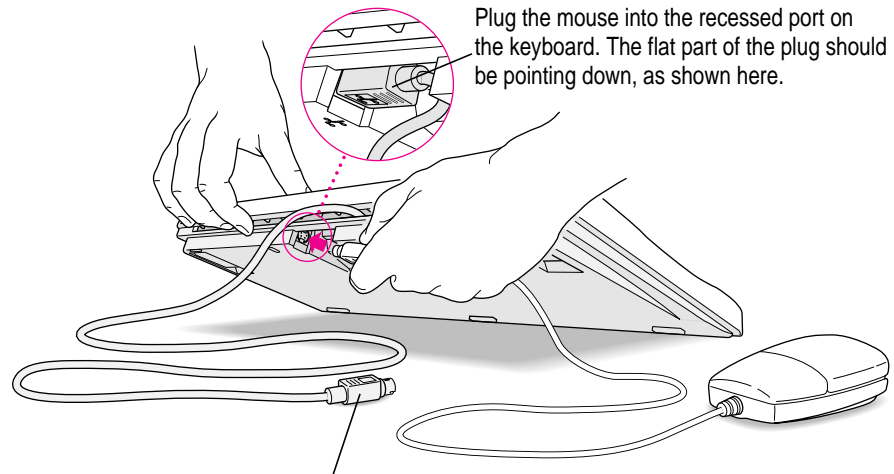

This cable plugs into the Apple Desktop Bus (ADB) port on the back of the computer. The ADB port on the computer is marked with the ⌘ icon.

- 2 Plug the keyboard cable into the port marked with the ⌘ icon on the back of the computer.**

Some monitors have a port to which you can connect the keyboard or mouse. See the information that came with your monitor.

## Connecting other equipment

If you are new to the Macintosh, it's a good idea to get some experience using your computer before you connect other equipment, such as a printer or scanner. To learn basic Macintosh skills, continue with the instructions in this chapter.

When you're ready to connect other equipment to your Macintosh, see the instructions in Chapter 3.

## Turning the computer on

To turn on the computer for the first time, follow these steps:

**1 Turn on your monitor.**

See the information that came with your monitor for the location of the power switch. On Apple monitors, the power switch is marked with the symbol .

*By the way:* You only need to turn on the monitor once. From now on, the monitor will turn off automatically when you shut down the computer, and it will turn on automatically when you start up the computer. (If the monitor is not plugged into the computer, it must be turned on separately each time you turn on the computer.)

**2 Turn on your computer by pressing the Power key on the keyboard.**

The Power key is marked with a triangle. Its location depends on which keyboard you have.

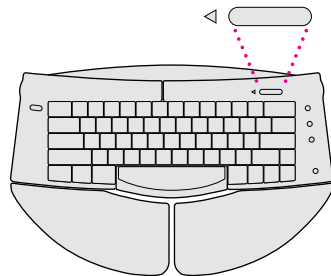
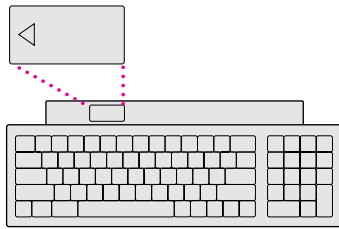
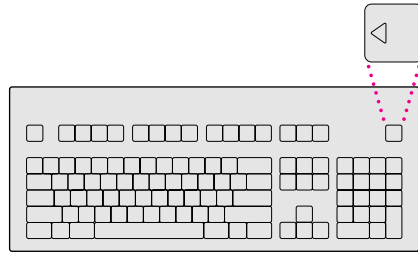

You hear a tone from the computer as it starts up.

**3 Check to see what's on your screen.**

- If you see the Macintosh desktop, shown here, your system software is already set up correctly. Skip now to “What's Next?”

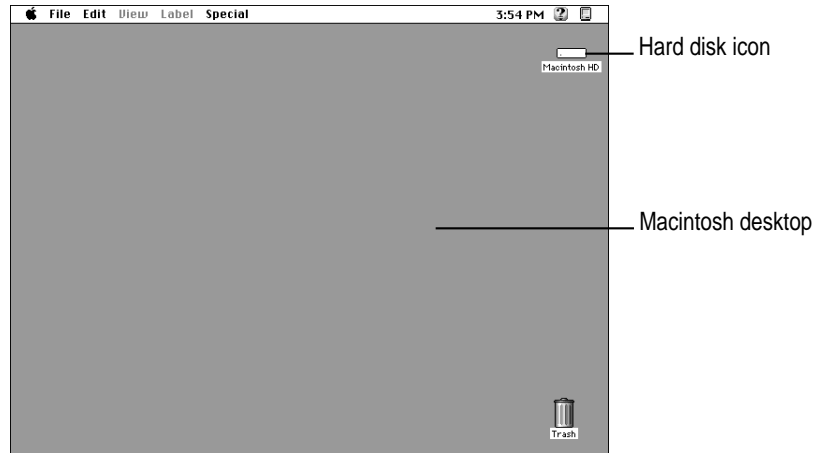



- If you see a blinking question mark, you need to install system software on the computer's hard disk. (System software is a set of programs the computer uses to start itself up.)

See “Installing or Reinstalling System Software” in Chapter 5 of this book for information on installing system software.

- If you see anything else on your screen, or if you see nothing at all, see the next section, “Problems Turning Your Computer On?”

## Problems turning your computer on?

If you don't see anything on the screen, check these items to see if you can identify the problem:

- Is the computer plugged into a power source? If it is plugged into a power strip, is the power strip turned on?
- Is the computer turned on? The power-on light on the front panel should be on. If it isn't on, press the power switch (marked with the symbol .
- Are the keyboard and mouse cables connected correctly? (Don't disconnect the keyboard or mouse cable while the computer is on. You could damage your equipment.)
- Is the monitor power cord plugged in?
- Is the monitor turned on? (Check the power-on light on the front of the monitor.)
- Is the monitor cable attached firmly to both the monitor and computer?
- Is the brightness control on the monitor adjusted correctly? (On Apple monitors, the brightness control is marked with the symbol .)

## What's next?

You've finished setting up your computer. Continue with one of the following steps:

- If you are new to the Macintosh, turn to the next section, “Learning the Basics.”
- If you are an experienced Macintosh user, turn to Chapter 2, “Getting Help,” to learn about Macintosh Guide, your main source of information when you're working with the Macintosh.
- If you want to connect additional equipment, such as a microphone, to your computer, see Chapter 3 of this book for instructions.
- If you want to install application software on your computer, see Chapter 4 of this book for information on setting up your programs and managing memory. You'll need this information to properly set up any software programs specifically designed for Power Macintosh computers.

**IMPORTANT** If you need to turn off your computer at any point, please see “Turning the Computer Off” later in this chapter. It is very important to use the correct procedure for shutting down your Macintosh before turning it off.



## Learning the basics

If you are new to the Macintosh, you should begin by looking at the easy-to-use program called the Macintosh Tutorial. The tutorial teaches you the basic skills you'll need to use your computer. To start the tutorial, follow these steps:

**1 Slide your mouse along your mouse pad or desk.**

Hold the mouse as shown, with the cable pointing away from you. Don't press the mouse button (under your index finger). Notice that the arrow (↔) on the screen moves in the same direction that you move the mouse.

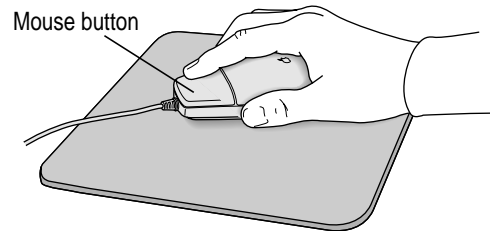

If the arrow doesn't move, make sure that the cables connecting the mouse and keyboard are secure and that your mouse is positioned as shown in the illustration.

**2 Move the tip of the arrow (↔) to the question mark (?) in the upper-right portion of the screen.**

If you run out of room on your mouse pad or desk while moving the mouse, pick up the mouse and place it where there's more room. (The arrow on the screen moves only when the mouse is in contact with the mouse pad or desk.)

**3 With the tip of the arrow on the question mark, press and hold down the mouse button.**

A list of choices (called a *menu*) appears. This is the Guide (?) menu, which is the place to go when you have a question about how to use your computer.



- 4 While holding down the mouse button, move the arrow until the words “Macintosh Tutorial” are highlighted, then release the mouse button.

A window appears welcoming you to the tutorial. You can set this book aside for now and follow the instructions on the screen. When you have completed the tutorial, return to this book.

## Reviewing the basics

The following illustration summarizes many of the basic skills and terms you learned from the tutorial.

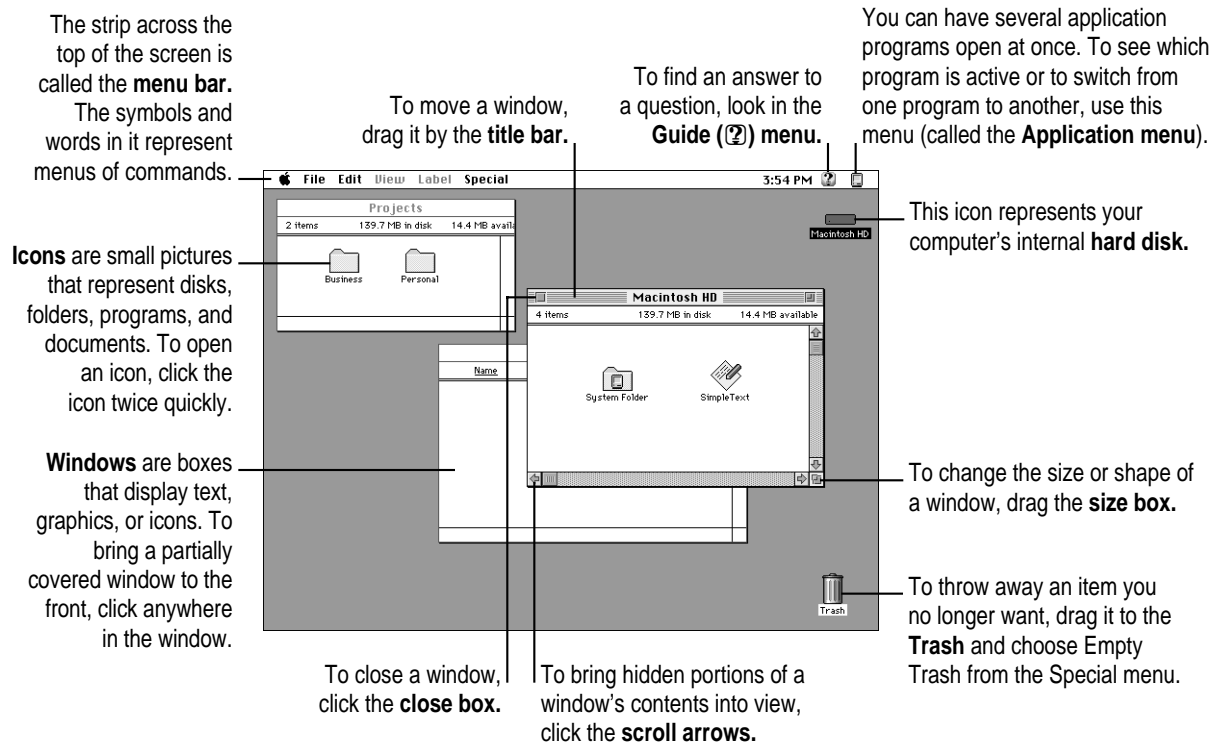

## Turning the computer off

To turn your computer off, you choose Shut Down from the Special menu. Detailed instructions follow.

- 1 Move the tip of the arrow (⬅) to the word “Special” at the top center of the screen.



If the word “Special” does not appear at the top of the screen, you’re working in the wrong program. Pull down the Application menu (to the right of the Guide [?] menu) and choose Finder. Then try step 1 again.

- 2 With the tip of the arrow on the word “Special,” press and hold down the mouse button.
- 3 While holding down the mouse button, move the arrow down until the words “Shut Down” are highlighted, then release the mouse button.



Choosing Shut Down readies the hard disk for a fast restart next time you turn on the computer. It also prompts you to save any unsaved work on a disk before turning the power off.

To turn the computer on again, just press the Power key on the keyboard.

**WARNING** Do not turn the computer off by pressing the power switch on the back panel. If you do so, you will lose any work you haven’t previously saved onto a disk. You also risk losing open documents.

## Where to find answers

When you have questions about using your Macintosh, there are several places you can look for answers.

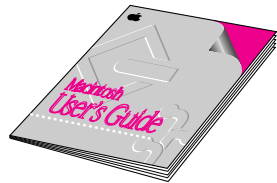

### In this book

Use this book to help you set up your computer and learn about it, or to find solutions to problems.



### In the Guide menu

The Guide menu (marked with the  icon) is your main source of information about the Macintosh. To learn how to get different kinds of help from the Guide menu, see Chapter 2 in this book.

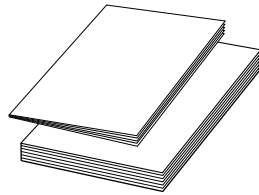

### In other manuals

For answers to questions about other equipment or about application programs you have purchased, see the manuals that came with the equipment or programs.



### From Apple's customer support hotline

If you can't find an answer in any of the materials provided, call the customer support hotline. (The phone number for the hotline is in the service and support information that came with your computer.)

Use the instructions in this chapter to learn about the help available to you in the Guide menu.

## 2 Getting Help

The Guide menu is your main source of information when you're working with your computer. The menu is identified by a question mark (🔍) in the upper-right corner of the screen.



## Getting answers to your questions

When you have a question while working with your computer, you can get the answer by choosing Macintosh Guide from the Guide menu.

- 1 Pull down the Application menu (in the upper-right corner of the screen) and choose Finder to make it the active application program.



A checkmark in the menu indicates that the Finder is the active program.

- 2 Pull down the Guide menu (marked with the ? icon) and choose Macintosh Guide.

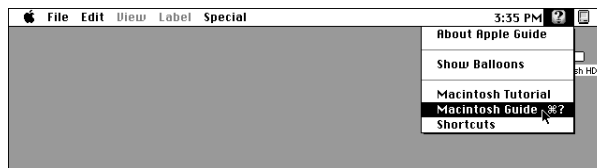

The Macintosh Guide window appears.

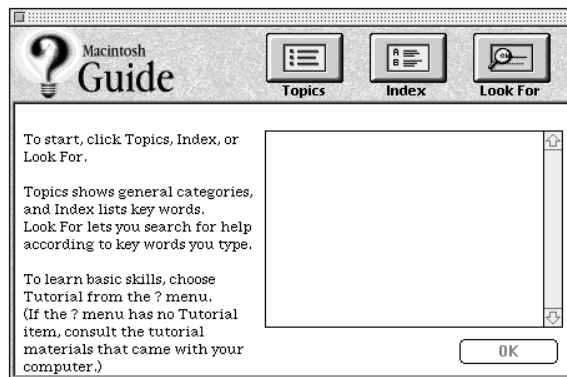

Whenever you use Macintosh Guide, its window remains in front of other windows. If the window gets in your way, you can move it by dragging its title bar (the gray bar across the top of the window).

- 3 Notice the three buttons at the top of the window: Topics, Index, and Look For.



Macintosh Guide gives you three ways of finding information:

- **Topics** lets you choose from a list of general subjects; it is like the table of contents in a book.
- **Index** lets you choose from an alphabetical list of more specific subjects; it is like the index in a book.
- **Look For** lets you search for information related to a specific word or phrase that you type.

In the following sections you will practice using each method.

If you have problems while using Macintosh Guide, see “Tips for Using Macintosh Guide” later in this chapter.

## Getting answers with the Topics button

- 1 In the Macintosh Guide window, click the Topics button.

A list of general topics appears on the left side of the Macintosh Guide window. (Depending on the hardware and software you have, the list of topics may look different.)

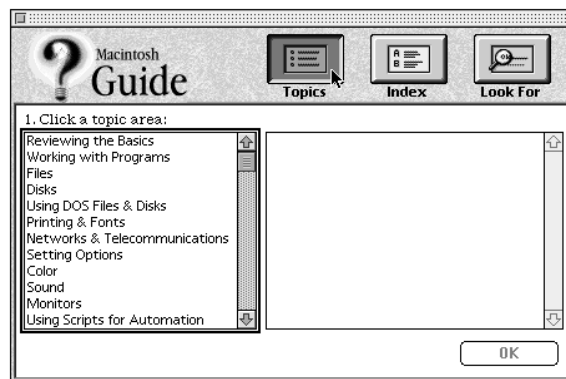

**2 Click “Setting Options” in the list of topics.**

When you click any topic area, a list of related questions appears on the right side of the Macintosh Guide window.

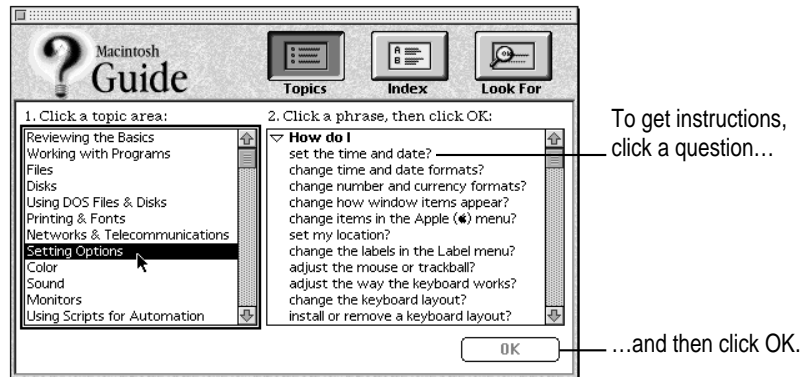

**3 Click the question “How do I set the time and date?” and then click OK. Or double-click the question.**

A small window appears with instructions for you to follow.

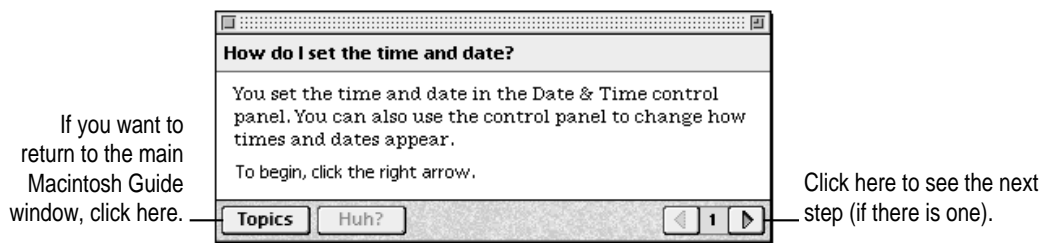

**4 Read and follow the instructions in this window.**

Macintosh Guide provides step-by-step instructions to answer the question you selected. When you have completed each step, click the right arrow in the lower-right corner to see the next step.

**5 When you have completed all the steps, click the Topics button in the lower-left corner to return to the main Macintosh Guide window.**

Now continue with the next section.



## Getting answers with the Index button

- 1 In the Macintosh Guide window, click the Index button.

An alphabetical list of subjects appears on the left side of the window.

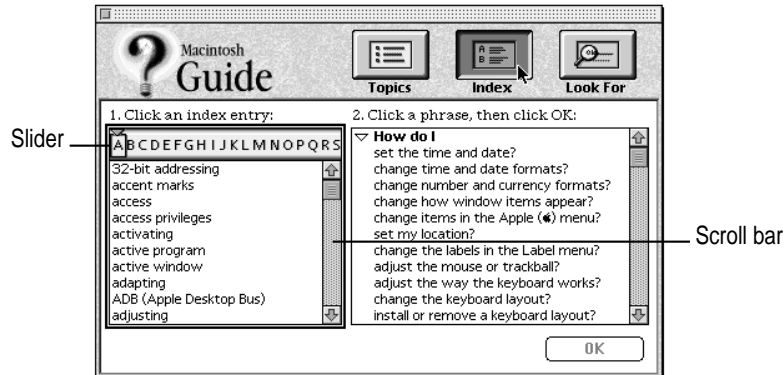

- 2 Scroll through the alphabetical list until the phrase “background pattern” is visible.

You can scroll through the list either by dragging the slider to the letter *B* or by using the scroll bar at the right of the list.

- 3 Click the phrase “background pattern” in the alphabetical list.

When you click any index entry, a list of related questions appears on the right side of the Macintosh Guide window.

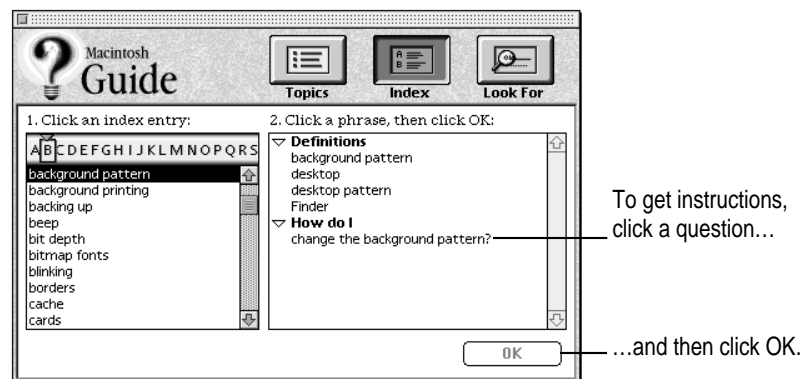

- 4 Click the question “How do I change the background pattern?” and then click OK. Or double-click the question.

A small window appears with instructions for you to follow.

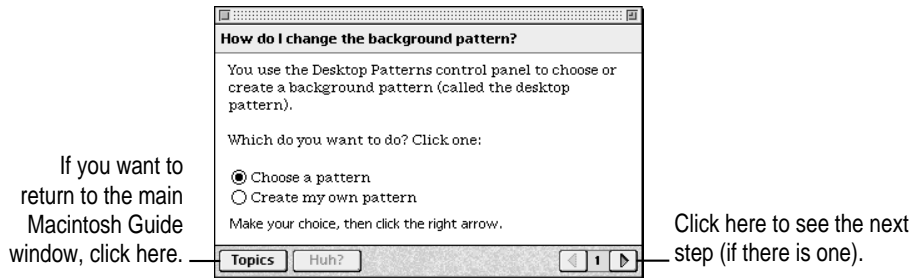

- 5 Read and follow the instructions in the window.

Macintosh Guide provides step-by-step instructions to answer the question you selected. When you have completed each step, click the right arrow in the lower-right corner to see the next step.

- 6 When you have completed all the steps, click the Topics button in the lower-left corner to return to the main Macintosh Guide window.

Now continue with the next section.

## Getting answers with the Look For button

- 1 In the Macintosh Guide window, click the Look For button.

A small box appears on the left side of the window, where you can type text.

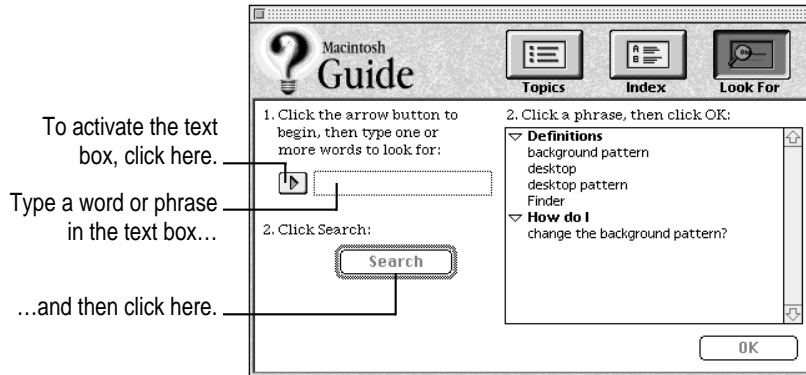

- 2 Click the arrow button to activate the text box.
- 3 Type "sound" in the text box and then click Search.

When you click Search, a list of questions related to the word or phrase you typed appears on the right side of the Macintosh Guide window.

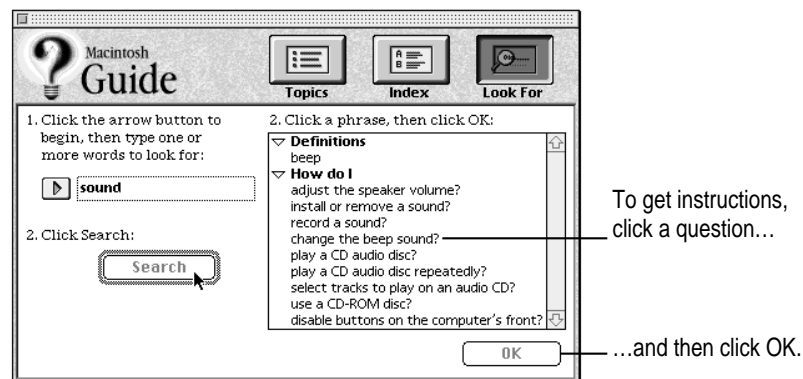

- 4 Click the question “How do I change the beep sound?” and then click OK. Or double-click the question.

A small window appears with instructions for you to follow.

If you want to close  
Macintosh Guide,  
click here.

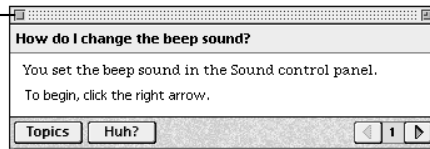

Click here to see the next  
step (if there is one).

- 5 Read and follow the instructions in the window.

Macintosh Guide provides step-by-step instructions to answer the question you selected. When you have completed each step, click the right arrow in the lower-right corner to display the next step.

- 6 When you have completed all the steps, click the close box in the upper-left corner to close Macintosh Guide.

## Tips for using Macintosh Guide

Here are a few tips for using Macintosh Guide effectively:

- Macintosh Guide is available only when you are in the Finder—the desktop area where you can see the icons of disks, folders, and files. (Other programs may also have help available in the Guide menu, however.) If you don't see Macintosh Guide in the Guide menu, pull down the Application menu (to the right of the Guide menu) and choose Finder.
- Follow the steps when you're instructed to; don't skip ahead or read ahead. That way the computer can check to make sure you've done a step correctly.
- Unlike most windows, the Macintosh Guide window stays in front of other windows on the screen so that your instructions are never covered. If you need to move the Guide window out of the way, drag it by the title bar at the top of the window.

You can also move the window out of the way by clicking the zoom box. Click the box once to shrink the window; click it a second time to expand the window to its original size.

- If you need more information about an instruction or a term, click the button labeled “Huh?” to get further explanation. (The “Huh?” button is dimmed when no additional information is available.)
- If you want to return to the main Macintosh Guide window, click the Topics button in the lower-left corner of the Guide window.
- When you're finished using Macintosh Guide, click the close box in the upper-left corner of the window.

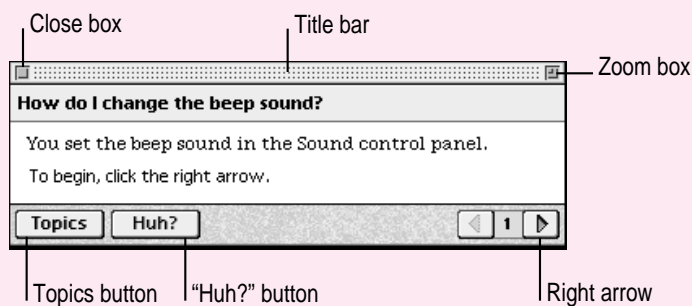

## Identifying objects on the screen

Sometimes you'll see an unfamiliar item on the screen and ask yourself, "What's that?" You can get an answer by using a Macintosh feature known as Balloon Help.

Balloon Help explains the function of icons, menus, commands, and other items on the Macintosh screen in balloons like those you see in comic strips.

Follow these steps to use Balloon Help:

- 1 Pull down the Guide menu (marked with the  icon) and choose Show Balloons.**



- 2 Point to any object on the screen that you want to identify.**

A balloon appears next to the object. In the following illustration, for example, pointing to the Trash displays a balloon that explains how to use the Trash to throw items away.



Although balloons appear next to items when you point to them, the way you work does not change; you can still select icons, choose commands, and so on.

- 3 When you're finished using Balloon Help, choose Hide Balloons from the Guide menu.**

## Learning useful shortcuts

You can perform many tasks in the Finder more quickly if you use keyboard or mouse shortcuts. For example, instead of clicking an icon and choosing Open from the File menu, you can simply double-click the icon to open it.

Follow these steps to learn keyboard and mouse shortcuts:

- 1 Pull down the Guide menu (marked with the ) and choose Shortcuts.

The main Macintosh Shortcuts window appears.

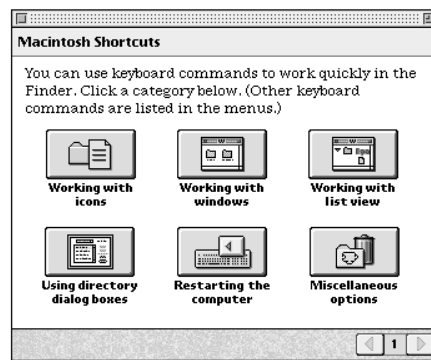

**2 Click one of the category buttons.**

Another window appears, describing shortcuts for that category.

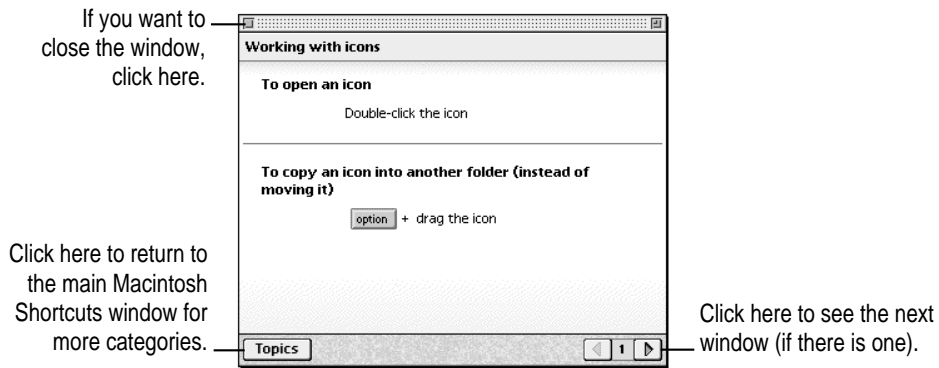

**3 Read about the shortcuts available for the category you selected.**

Click the right arrow in the lower-right corner of the window to display the next window (if there is one).

**4 When you finish reading about the shortcuts for your category, click the Topics button in the lower-left corner to return to the main Macintosh Shortcuts window. Or click the close box in the upper-left corner to close the window.**



Read this chapter for information on expanding your computer system with additional hardware.

# 3

## Connecting Additional Equipment



### Your computer at a glance

The illustration shows a basic Power Macintosh 8100 series system, ready to use. However, you can also expand your computer system.

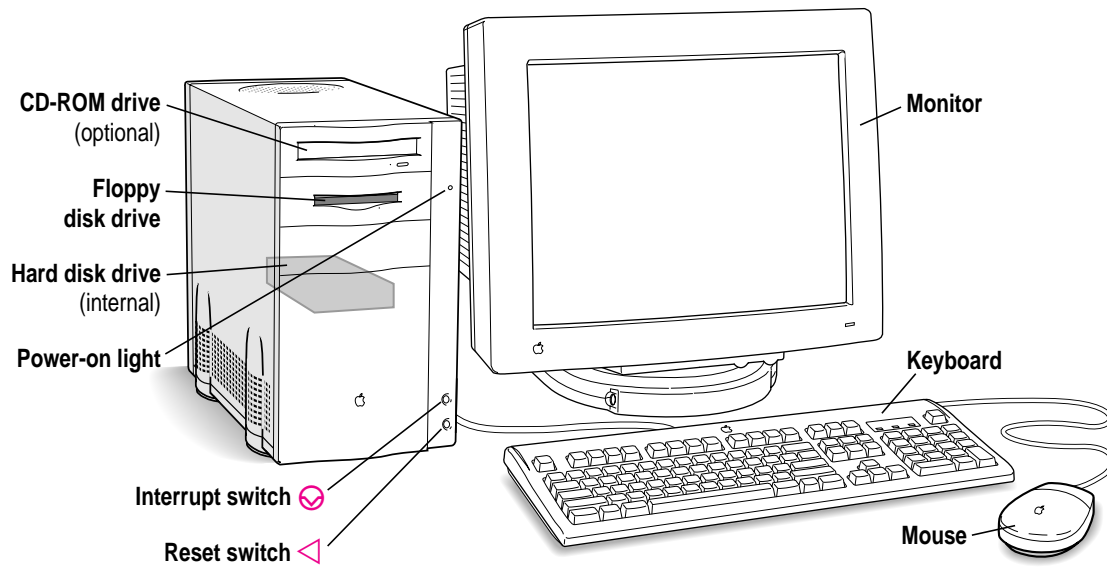

The illustrations on this page and the next show where equipment should be connected to your computer.

For instructions on connecting audio or video equipment, refer to the next two sections of this chapter. For instructions on connecting other equipment, such as a CD-ROM drive, see the manual that came with the equipment.

## Power Macintosh 8100 series computer

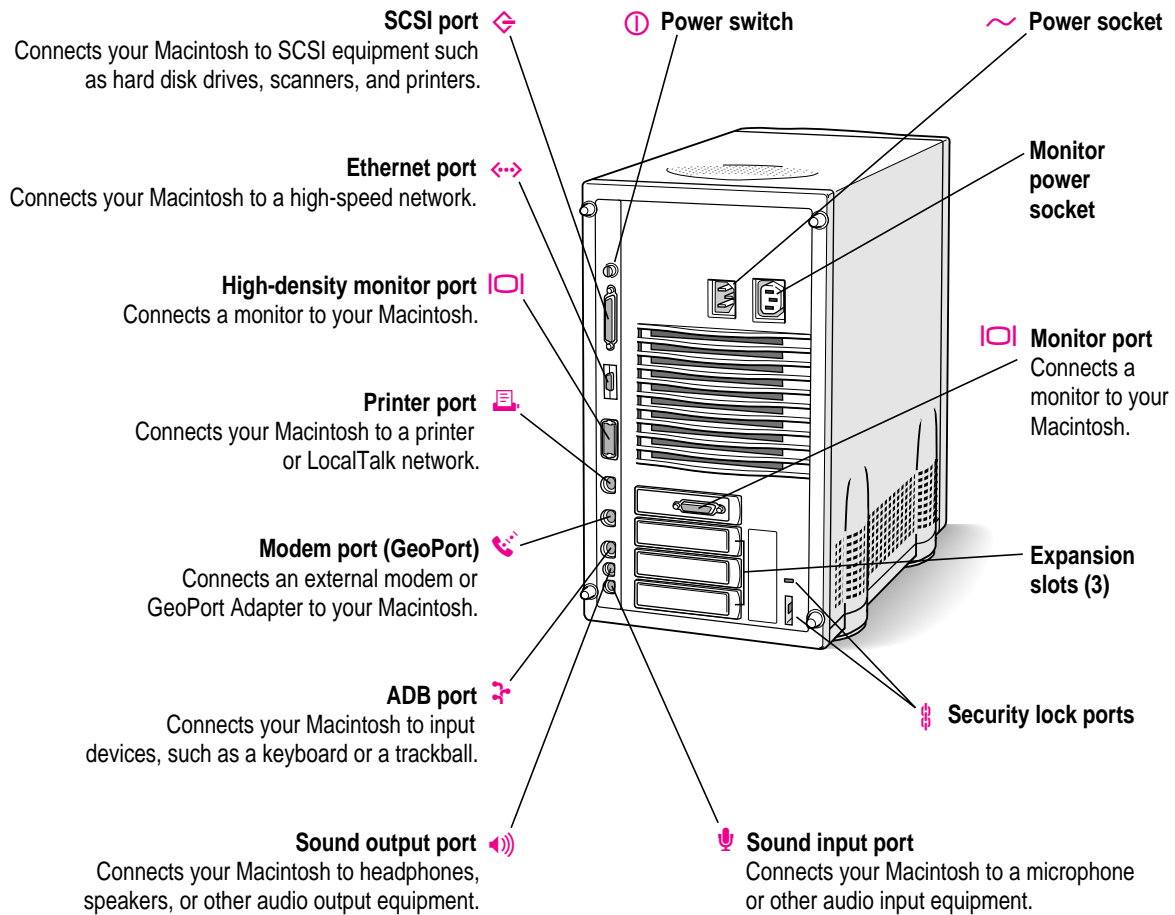

## AV-equipped Power Macintosh 8100 series computer

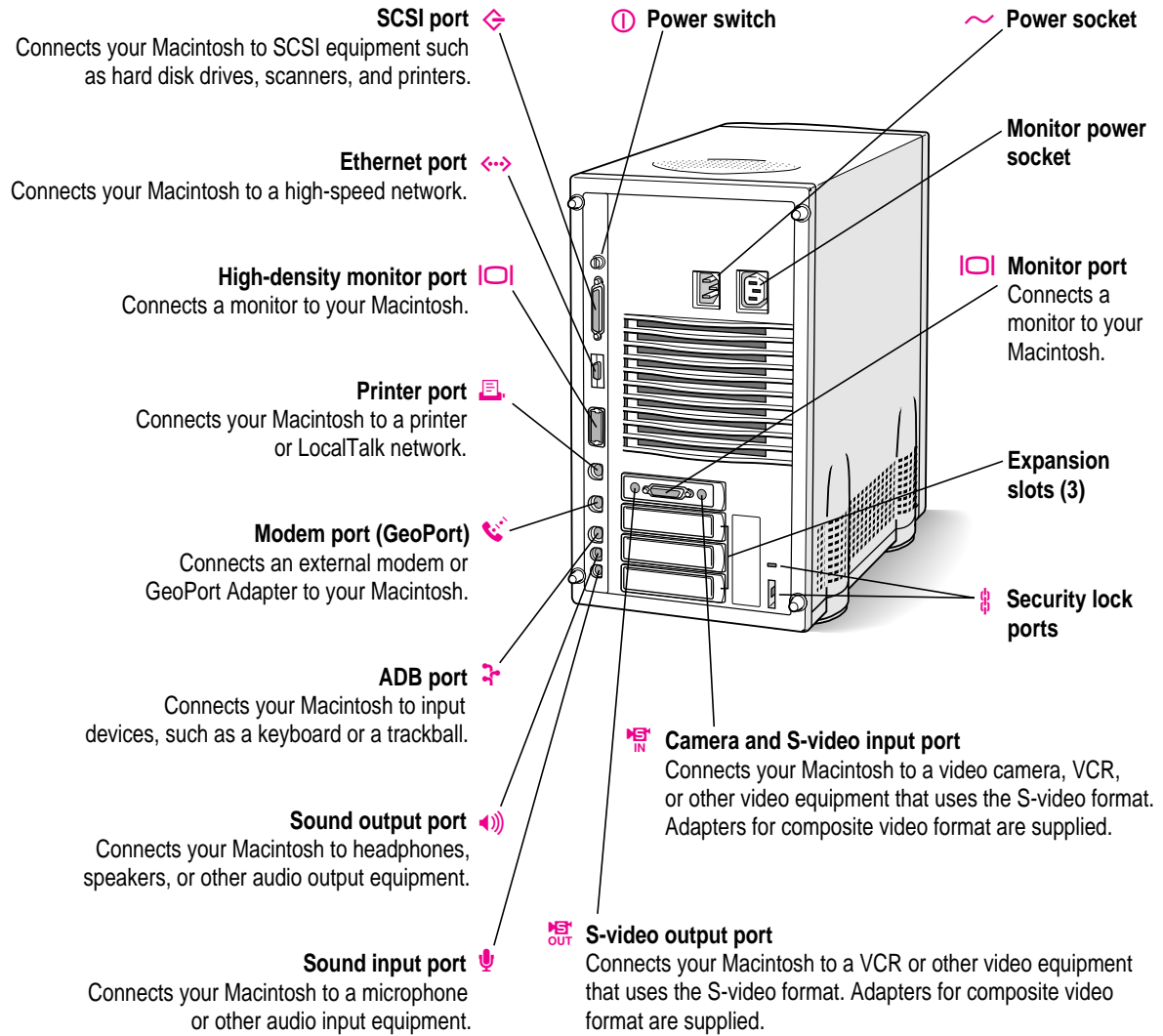

## Connecting audio equipment

Your Macintosh can play and record stereo sound from a variety of sources. You can listen to or reproduce stereo sound by connecting audio equipment to the sound input and output ports on the computer. If you have an internal CD-ROM drive, you can also use your computer to play and record sound from audio compact discs (CDs).

For information on using Macintosh system software to choose audio input and output options, record an alert sound, or play audio CDs, see the “Sound” topic of Macintosh Guide, available in the Guide (Ⓜ) menu.

### About your computer's sound ports

The sound input port is marked with an icon of a microphone. The sound output port is marked with an icon of a speaker.

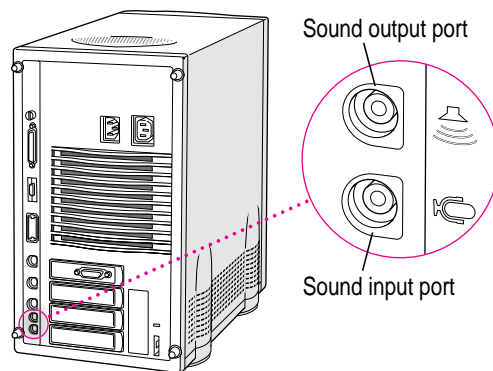

When audio equipment is connected to the sound input port (Ⓜ), you can hear or record the incoming sound on the computer.

When audio equipment is connected to the sound output port (Ⓜ), you can record the sound produced by the computer or play that sound through external speakers.

The computer's sound ports accept an audio connector known as a *stereo miniplug*. This connector is the type used on headphones for a personal tape player, for example. If your equipment has a different type of connector, you can purchase an adapter at an electronics supply store.



Stereo miniplug

### Connecting audio equipment

To play or record sound with your Macintosh, you can attach a microphone, amplifier, tape recorder, or a pair of speakers.

For specific instructions on connecting a microphone, skip to the next section, “Connecting and Positioning a Microphone.” For specific instructions on connecting speakers, see “Connecting External Stereo Speakers,” later in this chapter.

If your Macintosh has audio-visual (AV) capabilities, you can record sound and video simultaneously by connecting a VCR to your Macintosh. For instructions, see “Connecting Video Equipment for Output From the Computer,” later in this chapter.

Follow these steps to connect audio equipment to the Macintosh:

- 1 Make sure that the audio equipment has a cable with a stereo miniplug connector.**  
If it does not, attach an adapter that has a stereo miniplug.
- 2 Place the audio equipment near the Macintosh.**
- 3 Shut down the Macintosh and turn off the audio equipment.**

**4 Attach the cable to the audio equipment and to the appropriate sound port on the Macintosh.**

To hear or record incoming sound on the computer, connect the audio equipment to the sound input port (Ⓜ).

To record the sound produced by the computer or play that sound through external speakers, connect the audio equipment to the sound output port (Ⓜ).

**5 Turn on the computer and the audio equipment.**

You're now ready to begin listening to and working with sound. For more information on working with sound, see the "Sound" topic of Macintosh Guide, available in the Guide (Ⓜ) menu.

### Connecting and positioning a microphone

With appropriate software, you can use a microphone to give spoken commands to your Macintosh and to record your voice or other sounds.

You need the Apple PlainTalk Microphone (or a compatible microphone) to use speech-recognition technology with the Macintosh. Some models of the Macintosh come with the microphone. You can obtain the microphone from an Apple-authorized dealer. (You can't use the round microphone supplied with some other Macintosh models.)

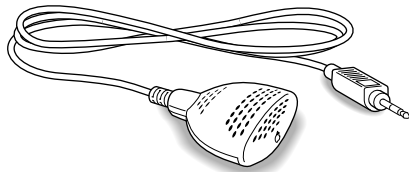

The Apple AudioVision 14 Display has the Apple PlainTalk Microphone built in.

Follow these steps to connect and position the microphone:

- 1** Shut down the Macintosh.
- 2** Plug the microphone's connector into the sound input port (🎧) on the back of the computer.
- 3** Place the microphone at the top center of the monitor, so that the microphone's Apple (🍏) icon is facing you.

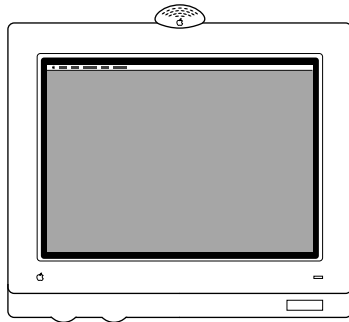

If you can't place the microphone on top of the monitor, position the microphone according to these guidelines:

- The microphone should be between 1 and 3 feet away from you.
  - The microphone should be directly in front of you to minimize the effect of background noises.
- 4** Turn on the computer.

You're now ready to begin using your microphone.

To install Apple PlainTalk software, which enables you to give spoken commands to the computer, get computer-voice feedback to your spoken commands, and have the computer read text to you, see Chapter 4.

For further instructions on how to use speech, see the “Speech” topic of Macintosh Guide, available in the Guide (🔍) menu.

## Connecting external stereo speakers

You can take advantage of your computer's stereo sound output by attaching external powered (amplified) speakers.

**1 Assemble the speakers and the cable you need.**

You need a cable with stereo miniplugs at each end to connect one or both speakers to the computer. (Some speakers require a dual-plug adapter. Others, like those shown in the next illustration, accept a single stereo miniplug and are joined by standard speaker wires.)

**2 Turn off the Macintosh.**

**3 Plug a stereo miniplug into the sound output port (🔊) on the Macintosh.**

**4 Plug a stereo miniplug into the Audio In port on one of the speakers.**

If the speakers take a dual-plug cable, connect both plugs.

**5 Connect the speakers together with speaker wires, if necessary.**

Your finished connections should look like this:

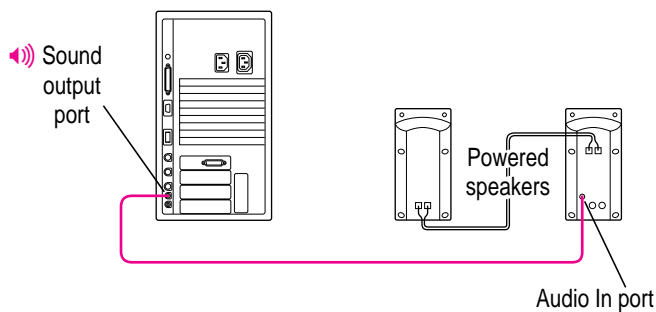

**6 Turn on the computer.**

Now you hear the computer's sound through the external speakers.

*Note:* To control the volume of your external speakers, open the Sound control panel and choose Volumes in the pop-up menu. Use the Built-in Headphones slider to adjust the volume for your external speakers. If you are playing an audio CD, you may also need to adjust the volume control in the program you're using to play CDs.



## Connecting video equipment

If you have an AV-equipped Power Macintosh, you can connect video equipment so that you can display, edit, and store video images on the computer. You can also view or record the computer's images on a television or videocassette recorder (VCR).

*Note:* On AV-equipped Power Macintosh computers, the letters “AV” are included at the end of the computer's name (for example, “Power Macintosh 8100/80AV”).

To connect video equipment to a Power Macintosh that is not AV-equipped, you need to install a video card. For more information, see Appendix B, “Installing an Expansion Card.”

In this section you will learn to

- connect video equipment for input, so that you can view the video image on your monitor, capture single frames, or save digitized video in files
- connect video equipment for output, so that you can display or record images or sound from the computer

Your AV-equipped Macintosh can display and use video images from a variety of sources. To view video on your monitor, you connect video equipment to the video input port on the computer. To display or record the computer's output, you connect video equipment to the video output port.

Your Macintosh can work with two major video formats:

- S-video
- composite video

S-video is a high-quality video format used by many video cameras and VCRs. Televisions, most VCRs, and laserdisc players use the composite format. To find out which format your equipment uses, check the manual that came with your equipment.

## About your computer's S-video input and output ports

Your AV-equipped Macintosh has two S-video ports. The input port brings in images from connected external equipment, such as a VCR. The output port sends images out from the computer to the external equipment.

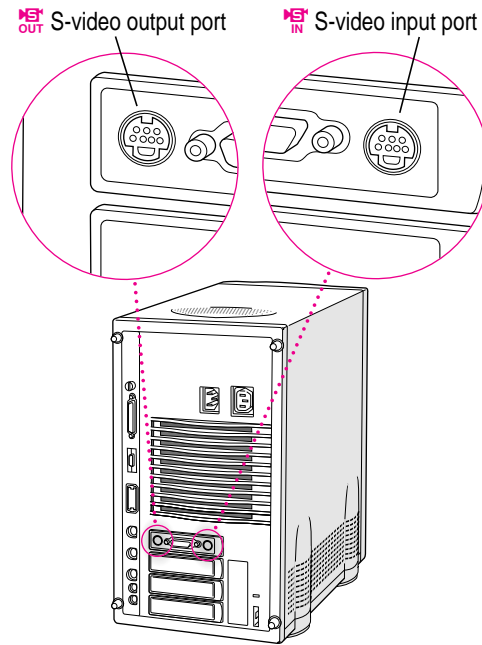

The S-video connector is a round plug with several small metal pins. You can plug this type of connector into your computer's S-video input or output port.

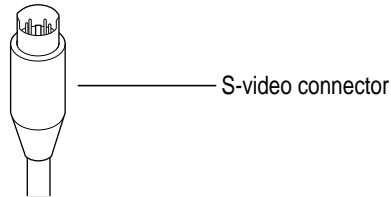

**IMPORTANT** The S-video connector resembles other Macintosh connectors, such as those for a printer, modem, mouse, or keyboard. Don't confuse the connectors; they're not interchangeable.

### Using adapters for composite video

Many video devices use composite video format instead of S-video. The cables for these devices have RCA-type plugs.

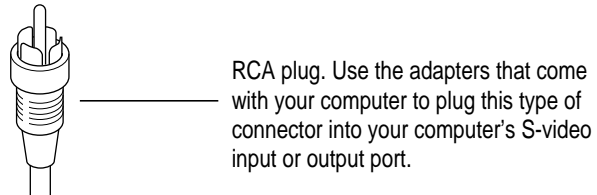



Two adapters for RCA plugs come with your computer. To connect a cable with RCA plugs to your computer, connect the RCA plug to one of the adapters, and connect the adapter to the appropriate S-video port (input or output) on the back of your computer.

Connect the end marked with the  icon to the computer's S-video output port. (The flat side of the connector should face up.)

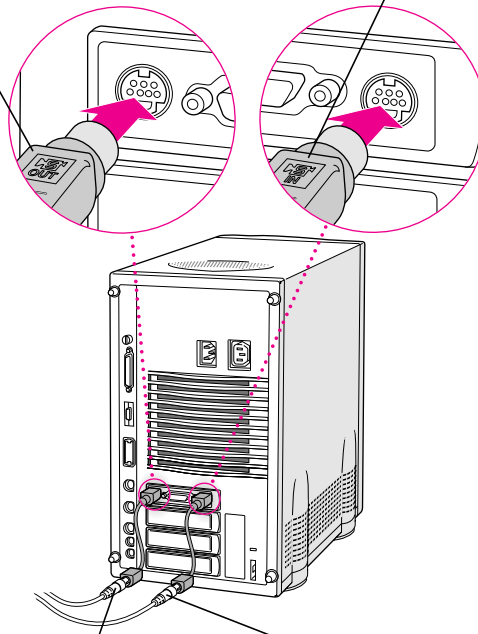
Connect the end marked with the  icon to the computer's S-video input port. (The flat side of the connector should face up.)



To record images from your computer on a VCR or other video equipment, attach the end of the adapter marked with the  icon to a cable with RCA plugs, then connect the cable's other RCA plug to the video input port on the video device.

To view images from your VCR or other video equipment on your monitor, attach the end of the adapter marked with the  icon to a cable with RCA plugs, then connect the cable's other RCA plug to the video output port on the video device.

## Connecting video equipment for input to the computer

When you connect video equipment to the Power Macintosh 8100/80AV, you can view video on the computer, capture video frames, and hear the sound from the video equipment through the computer's speaker. The instructions that follow are for connecting a stereo VCR, but you can use them as a model for connecting your computer to any video equipment.

Before you start:

- Make sure that the VCR has a cable with either a composite (RCA plug) connector or an S-video connector.

If the VCR has an RCA plug, make sure you have the adapter for composite video marked with the  icon.

- Place the VCR near the Macintosh.
- Shut down the Macintosh and turn off the VCR.

Then follow these steps:

### 1 Assemble the cables you need to connect the VCR to the Macintosh.

You need the following cables (available at an electronics supply store):

- Video cable with S-video connectors or RCA plugs at each end. (If you're using a video cable with RCA plugs, you'll also need the adapter cable for composite video.)

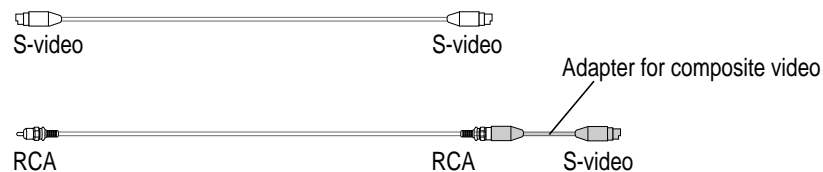

- Audio cable with dual RCA plugs at one end and a 3.5-mm stereo miniplug at the other end.



You can also use an all-in-one cable (with one video and two audio RCA plugs at each end) if you attach appropriate adapters.

**IMPORTANT** A Y-shaped adapter is supplied with the round microphone for some models of the Macintosh. This adapter is not compatible with your Power Macintosh.

- 2 Attach one end of the video cable to the Video Out port on the VCR.**

Follow the directions that came with the VCR.

- 3 Plug the other end of the video cable (or adapter) into the S-video input port (S) on the Macintosh.**

If the connector doesn't slide easily into the port, realign it and try again. Don't use force, which could damage the computer or cable.

- 4 Plug the dual RCA plugs on the audio cable into the left and right Audio Out ports on the VCR.**

- 5 Plug the stereo miniplug on the audio cable into the sound input port (S) on the Macintosh.**

Your finished connections should look like this:

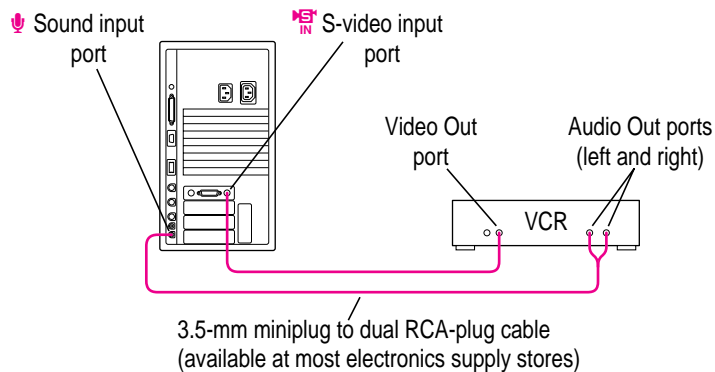

- 6 Turn on the computer and the VCR.**

You can now begin working with the video equipment connected to your Macintosh. For instructions on how to view video images, capture frames, and use video in other ways, see the "Video" topic of Macintosh Guide, available in the Guide (G) menu.

## Connecting video equipment for output from the computer

You can deliver and record a sophisticated presentation by combining the video and sound capabilities of your Macintosh. The steps that follow explain how to set up equipment for recording the computer's output on videotape and adding voice annotation with a microphone.

To ensure that your presentation is recorded on videotape and shown on the television, you must connect the VCR to the computer and the television to the VCR.

Before you start:

- Make sure that the VCR has a cable with either a composite (RCA plug) connector or an S-video connector.

If the VCR has an RCA plug, make sure you have the adapter for composite video marked with the  icon.

- Place the VCR and television near the Macintosh.
- Shut down the Macintosh and turn off the VCR and television.

Then follow these steps:

**1 Assemble the VCR, television, microphone, and cables you need.**

Be sure to use a microphone designed for your model of the Macintosh, such as the Apple PlainTalk Microphone.

You need the following cables (available at an electronics supply store):

- Video cable with S-video connectors or RCA plugs at each end. (If you're using a video cable with RCA plugs, you'll also need the adapter cable for composite video.)

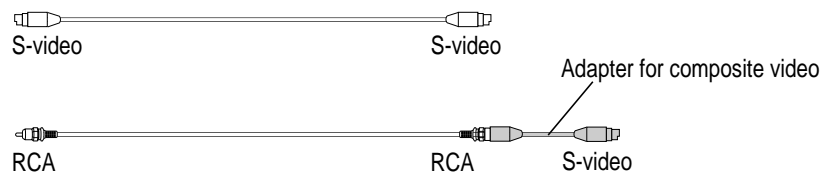

- Audio cable with dual RCA plugs at one end and a 3.5-mm stereo miniplug at the other end.



- A cable to connect your VCR to your television.

Use a cable with an RCA or S-video plug to connect the VCR to the television. Do not use coaxial cable.

You can also use an all-in-one cable (with one video and two audio RCA plugs at each end) if you attach appropriate adapters.

**IMPORTANT** A Y-shaped adapter is supplied with the round microphone for some models of the Macintosh. This adapter is not compatible with your Power Macintosh.

**2 Attach one end of the video cable to the Video In port on the VCR.**

Follow the directions that came with the VCR.



- 3 Plug the other end of the video cable (or adapter) into the S-video output port (S<sub>OUT</sub>) on the Macintosh.**

If the connector doesn't slide easily into the port, realign it and try again. Don't use force, which could damage the computer or cable.

- 4 Plug the dual RCA plugs on the audio cable into the left and right Audio In ports on the VCR.**
- 5 Plug the stereo miniplug on the audio cable (or adapter) into the sound output port (S<sub>OUT</sub>) on the Macintosh.**
- 6 Connect the VCR's Video Out port to the television's Video In port.**
- 7 Connect the microphone to the sound input port (S<sub>IN</sub>) on the Macintosh.**

Your finished connections should look like this:

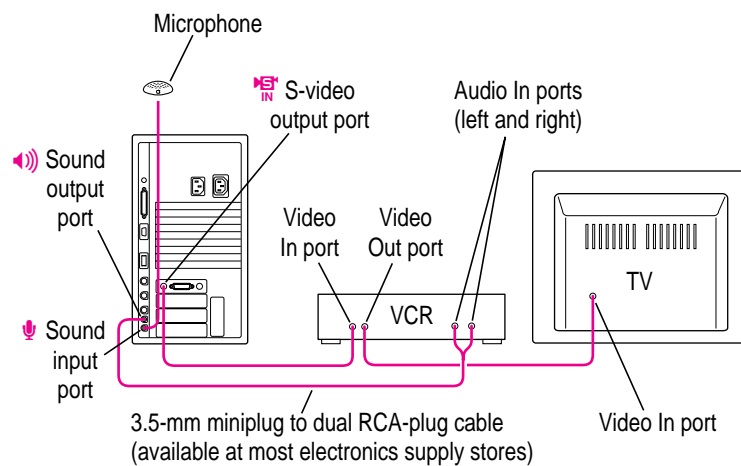

- 8 Turn on the computer, the VCR, and the television.**
- 9 Select "line input" on your VCR.**

See the manual that came with your VCR for instructions on how to select the line input source.

For further instructions on how to record the computer's output on videotape and add voice annotation, see the "Video" topic of Macintosh Guide, available in the Guide (G) menu.

## Using a television as a monitor

There are two ways to use a television as a monitor:

- As described in the previous section, you can connect a VCR to the computer's S-video output port, and connect a television to the VCR's Video Out port. Then you can record a presentation on videotape as it is displayed on the television.
- You can connect a television directly to the computer's S-video output port and display the computer's images on it. This capability is especially useful if you're using your Macintosh to give a presentation and you have access to a large-screen television. If your television does not support S-video, attach the adapter for composite video as described earlier in this chapter. (Be sure to use the adapter marked with the  icon.)

For further instructions on using a television as a monitor, see the "Video" topic of Macintosh Guide, available in the Guide () menu.

## Expanding memory

The random-access memory (RAM) in your computer can be expanded. Installing additional RAM adds more memory chips to your computer and expands its capabilities. The *Technical Information* booklet that came with your computer describes how much additional memory can be installed in your Power Macintosh.

Memory for your computer is provided in packages called DRAM Single Inline Memory Modules (SIMMs). The SIMMs must be the correct type for your computer, and should be installed in pairs of the same size into paired slots in your computer.

In a Power Macintosh that is not AV-equipped, the memory used to display images on the screen (called video RAM, or VRAM) can also be expanded. In an AV-equipped Power Macintosh computer, VRAM cannot be expanded.

**WARNING** To avoid damage to your computer, Apple recommends that only an Apple-certified technician install additional RAM. Consult the service and support information that came with your computer for instructions on how to contact an Apple-authorized service provider or Apple for service. If you attempt to install additional RAM yourself, any damage you may cause to your equipment will not be covered by the limited warranty on your computer. See an Apple-authorized dealer or service provider for additional information about this or any other warranty question.

It is very important that the DRAM SIMMs be correctly installed in your Power Macintosh, because incorrect installation can result in errors, unpredictable results, and damage to your equipment and data.

**WARNING** Do not remove any factory-installed cards from inside your computer. Removing a factory-installed card at an angle can damage your equipment. Any NuBus™ expansion cards installed in your computer will not operate properly if the factory-installed card is removed. If a factory-installed card needs to be removed, see an Apple-authorized service provider.

## Installing internal drives

Your Macintosh can hold up to four internal storage devices, including a floppy disk drive, a CD-ROM drive, and two hard disk drives (several capacities are available). These drives may already be installed. If you want to add an internal drive to your Macintosh, see your Apple-authorized dealer.

Read this chapter for information on installing and working with application programs on your computer.

# 4

## Installing and Using Application Programs



### Installing application programs

Your computer has several application programs already installed, as well as some programs that need to be installed before you can use them. The programs that come with your computer include

- AppleScript, which allows you to automate any actions you perform repeatedly on your Macintosh
- PlainTalk, which enables you to use spoken commands with your Macintosh
- PowerTalk, which provides built-in mail and collaboration services
- QuickDraw GX, which gives your computer more powerful printing capabilities

You'll find these programs in the Apple Extras folder on your hard disk. To find out if a program needs to be installed, look inside the program's folder for an icon labeled Installer. If you find an Installer icon and want to use that program, double-click the Installer and follow the instructions on the screen.

One program that comes with your computer, Video Monitor, is for use with computers that have AV capabilities. If you have an AV-equipped Power Macintosh computer, see the "Video" topic of Macintosh Guide, available in the Guide (⌘) menu, for information on using Video Monitor.

You'll probably want to buy and install additional programs. See the manuals you receive with your programs for instructions on installing and using them.

In most cases, you'll install an application program on your internal hard disk from floppy disks that contain the program. The illustration shows how to insert a floppy disk into your computer's disk drive.

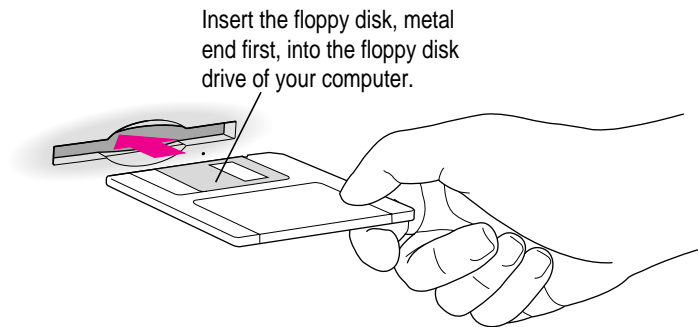

For instructions on how to eject floppy disks, see the “Disks” topic of Macintosh Guide, available in the Guide (🔍) menu.

To use your programs most effectively, follow these guidelines:

- Put only one copy of each program on your hard disk. Having more than one copy can cause errors.
- Whenever you copy a program disk to your hard disk, be careful not to copy a System Folder. Always check to see what you've copied, and drag any extra System Folders to the Trash.
- If a program malfunctions consistently, try installing a fresh copy. If that doesn't help, find out from the software manufacturer whether your version of the program is compatible with the system software you're using.

## Working with several programs at a time

You can open as many application programs and desk accessories as your computer's memory allows.

All open programs are listed in the Application menu at the right end of the menu bar. The name of the active program (the one you're using right now) has a checkmark next to it, and its icon appears in the menu bar.

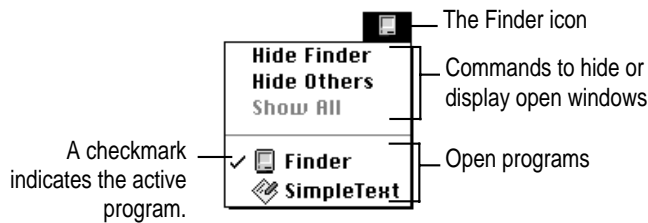

## Finding out which programs are open

If you have several programs and windows open, you can find out which program is active and which other programs are open by pulling down the Application menu.

## Switching programs

You can switch to another open program or desk accessory by choosing its name from the Application menu.

If a program's icon is dimmed in the menu, that means its windows are hidden. Choosing the program from the Application menu displays its windows.

You can also switch to another program by clicking in a window that belongs to an open program, or by double-clicking a program icon (or the icon of a document that was created with the program).

## Hiding and showing windows on the desktop

You can hide all windows except those of the active program by choosing Hide Others from the Application menu.

The other programs remain open even though their windows are hidden. When you switch to another program, its windows become visible again.

If you want to see all the open windows, choose Show All from the Application menu.

## Backing up your files

Making backup copies of important files is good protection against possible damage to the originals.

- You can back up files stored on your hard disk by copying them to floppy disks.
- You can back up an entire floppy disk by copying it to another floppy disk, or to a hard disk.
- You can use a commercial backup program to copy new and changed files from a hard disk to another hard disk, to a tape drive, or to a series of floppy disks.
- If your computer is on a network, you can back up files by copying them to a shared disk on the network.



## Using Power Macintosh application programs

Your Power Macintosh is compatible with most application programs intended for use with Macintosh computers. But certain programs are designed especially for Power Macintosh computers. (These are sometimes called “native” applications.) You’ll find that these programs take best advantage of your computer’s speed.

### Special memory requirements

Some Power Macintosh programs may be slightly larger than other programs and may take up more memory. If you find that you are running out of memory when you use your Power Macintosh programs, you can use space on your computer’s hard disk as additional memory. For instructions on how to use hard disk space as memory, see the “Memory” topic of Macintosh Guide, available in the Guide (Ⓜ) menu.

You can also add more memory to your computer, as described in “Expanding Memory” in Chapter 3.

### Shared libraries

Power Macintosh programs use special files called *shared libraries*. These files help Power Macintosh programs to run more efficiently, and can be used by more than one Power Macintosh program simultaneously. Any necessary shared libraries are installed automatically in the System Folder when you install Power Macintosh programs.

If a Power Macintosh program requires a shared library and there is not enough memory available for the shared library, you’ll see a message that the program could not be opened because of insufficient system memory. If this happens, see the “Memory” topic of Macintosh Guide, available in the Guide (Ⓜ) menu, for instructions on turning on virtual memory.

If a required shared library is missing, you’ll see a message that the program could not be opened because the shared library could not be found. If this happens, follow the directions that came with your program to reinstall the program. If the shared library is still missing, contact the program’s manufacturer for assistance.

## Using older Macintosh programs

If you experience problems using an older Macintosh program, it may be incompatible with your Power Macintosh. You may be able to use your older program if you change the Modern Memory Manager setting in your Memory control panel. For detailed instructions on using older programs with your Power Macintosh, see the “Working with Programs” topic of Macintosh Guide, available in the Guide (🔍) menu.



Consult this chapter if you experience problems using your computer.

# 5

## Troubleshooting



### When you have questions

If you want to know how to do a particular task with your computer, refer to Macintosh Guide in the Guide (🔗) menu. For instructions on using Macintosh Guide, see Chapter 2 of this manual.

### When you run into trouble

While you're using your computer, you may occasionally see a bomb icon or an error message, or you may have a problem such as the pointer (⏏) “freezing” on the screen. If you have trouble with your computer, take a few minutes to read the information in this chapter. If your problem is related to a particular procedure, you should also look for information on that procedure in Macintosh Guide, available in the Guide (🔗) menu. For additional troubleshooting information and a list of common questions relating to your system software, see the “Troubleshooting” topic of Macintosh Guide.

If you are unable to access Macintosh Guide (for example, if your screen is “frozen”), refer to this chapter to see if you can resolve the problem.

## Take your time

When you see an error message, you don't have to take action immediately. The message stays on the screen until you click the OK button or turn off the Macintosh.

To help diagnose and correct the problem, gather as much information on the situation as you can before starting over.

- Make a note of exactly what you were doing when the problem occurred. Write down the message on the screen and its ID number (if any). Also list the programs you were using and the names of any items you know have been added to the System Folder since the system software was installed. This information will help a service person diagnose the problem. (It is helpful to keep a printed copy of the items in your System Folder. For instructions on printing the contents of a folder, see the "Printing & Fonts" topic of Macintosh Guide, available in the Guide [?] menu.)
- Check the screen for any clues. Is a menu selected? What programs and document icons are open? Note anything else that seems relevant.
- If you were typing text and were not able to save it before the problem occurred, you can write down the parts of the text still visible on the screen so that some of your work will be easy to replace.
- Ask other Macintosh users about the problem you're having; they may have a solution for it.

If you need repair service, consult the service and support information that came with your computer for instructions on how to contact an Apple-authorized service provider or Apple for assistance.

## Start over

Often you can eliminate a problem simply by clearing the computer's memory and starting over.

If you can, save any open documents before restarting the Macintosh. If your system is frozen and does not respond to anything you do, or if you have a “bomb” message on the screen, saving may not be possible. You can try pressing ⌘-Option-Esc to quit the program in use when the problem occurred; if this works, you can then save the documents open in other programs before restarting.

To restart your Macintosh, try the following steps:

- 1 If you can, choose Restart from the Special menu or from the dialog box that's on the screen.**

Dialog boxes contain messages from the computer. If something goes wrong, a message may appear on the screen, asking you to restart the computer.

- 2 If you can't choose Restart, hold down the ⌘ and Control keys while you press the Power key (marked with a triangle).**

This key combination restarts the computer. (Use this key combination only when you can't choose Restart from the Special menu.)

- 3 If nothing happens, press the reset switch on the front of your Macintosh and press it (it's marked with a triangle).**

Pressing the reset switch is like turning the power switch off and then on again. You will lose any work you haven't saved.

- 4 If pressing the reset switch does nothing, turn off your computer with the power switch, wait at least 10 seconds, and then turn it on again.**

- 5 If the power switch doesn't turn off the computer, unplug your Macintosh.**

If you suspect that the problem is with other equipment, such as a printer or an external hard disk that's attached to your computer, turn that equipment off for 10 seconds or longer, then turn it on again and restart the Macintosh.

## Rebuild your desktop regularly

A process known as “rebuilding the desktop” helps your Macintosh keep track of data on your startup disks. Although you usually use the hard disk in your computer as a startup disk, you can also start up from any other disk that has system software installed. It’s a good idea to rebuild the desktop of your startup disks once a month or so.

To rebuild the desktop of a startup disk, follow these steps:

- 1 Hold down the Option and ⌘ keys while you start up your computer.**

Do not release the keys until you see a message asking whether you want to rebuild the desktop.

- 2 Click OK.**

## Solutions to common problems

### The computer is turned on but the screen is dark.

One of the following is probably the cause:

- You have a screen saver program that darkens the screen when the computer has not been used for a certain period.

Press a key or move the mouse to turn off the screen saver.

- The monitor's brightness control (☼) is not adjusted properly.

Check the monitor's brightness control and turn it up if necessary.

- The Macintosh or the monitor is not getting power.

If you have a separate monitor, check that the monitor is plugged in and turned on, and that the monitor cable is firmly connected to both the computer and the monitor.

Check that the computer's power cord is firmly connected to the computer and plugged into a grounded electrical outlet, and that the outlet has power.

If you have more than one monitor, and only one is dark, check that it is set up correctly in the Monitors control panel. For information on using more than one monitor, see the "Monitors" topic of Macintosh Guide, available in the Guide (📖) menu.

If you are displaying video from your computer on a television screen, it is normal for your computer monitor to be dark.

### The computer's clock keeps time inaccurately.

Your computer has a clock that runs continuously. When the computer is turned off, a battery keeps the clock running. If your clock begins to keep time inaccurately, have your Apple-authorized service provider replace the battery.

When you start up, a disk icon with a blinking question mark appears in the middle of the screen.



This icon indicates that your Macintosh cannot find the system software it needs to start up. One of the following is probably the cause:

- Your computer may be having a problem recognizing external equipment that uses the Small Computer System Interface (SCSI).

Turn off all external SCSI equipment and disconnect the first SCSI device in the chain from your computer's SCSI port. Then restart the computer. If the computer starts up after you disconnect your SCSI equipment, refer to the manuals that came with the equipment for information on the proper way to connect SCSI equipment and assign SCSI ID numbers.

If you have a printer connected to your computer's SCSI port, make sure your printer is not supposed to be connected to the printer port instead. Check the manuals that came with your printer for information on how to properly connect it.

- System software is not installed on the startup hard disk, the system software is damaged, or the hard disk is not working properly.

Start up your computer using the *Disk Tools* floppy disk or (if you have a built-in CD-ROM drive) with the CD-ROM disc that contains system software. (For instructions on how to start up your computer from the CD-ROM disc, see "Starting Up From a CD-ROM Disc" in the section "Initializing a Hard Disk" later in this chapter.) Then follow the instructions in "Repairing a Damaged Disk" later in this chapter to test your startup hard disk and repair any damage.

If repairing the disk doesn't help, follow the instructions in "Installing or Reinstalling System Software" later in this chapter to reinstall system software on your startup hard disk.



**When you try to start up from a floppy disk, a disk icon with an X appears in the middle of the screen and the floppy disk is ejected.**



This icon indicates that the floppy disk you tried to start up from is not a startup disk.

Wait a few seconds. The computer should start up from its internal hard disk. Make sure you insert floppy disks only after the computer has begun starting up.

**A “sad Macintosh” icon appears and the computer won’t start up.**



This icon indicates that your Macintosh cannot start up because of a problem with the system software or the computer hardware.

Eject any floppy disks by turning off the computer and then holding down the mouse button while you turn the computer on again. Try starting up with the *Disk Tools* floppy disk or (if you have a built-in CD-ROM drive) with the CD-ROM disc that contains system software. (For instructions on how to start up your computer from the CD-ROM disc, see “Starting Up From a CD-ROM Disc” in the section “Initializing a Hard Disk” later in this chapter.) If the “sad Macintosh” icon appears again, consult the service and support information that came with your computer for information on contacting an Apple-authorized service provider or Apple for assistance.

**The hard disk icon does not appear on the desktop.**

If you don’t see a hard disk icon on the desktop, try the following:

- If the hard disk is internal, shut down your computer, wait at least 10 seconds, and then turn it on again.
- If the hard disk is external, make sure that it is turned on and that its cable is connected firmly; then restart the Macintosh.
- Check the ID numbers of all SCSI equipment connected to your computer. See the manuals that came with your SCSI equipment for information on setting SCSI ID numbers.

- If the hard disk is your startup disk, start your computer using the *Disk Tools* floppy disk or (if you have a built-in CD-ROM drive) with the CD-ROM disc that contains system software. (For instructions on how to start up your computer from the CD-ROM disc, see “Starting Up From a CD-ROM Disc” in the section “Initializing a Hard Disk” later in this chapter.) Then follow the instructions in “Repairing a Damaged Disk” later in this chapter to test your startup hard disk and repair any damage.

If repairing the disk doesn't help, follow the instructions in “Installing or Reinstalling System Software” later in this chapter to reinstall system software on your startup hard disk.

#### **Icons do not appear correctly on your screen.**

You need to rebuild the desktop—a process that helps your Macintosh keep track of files and folders on your hard disk. For instructions, see “Rebuild Your Desktop Regularly” in the section “When You Run Into Trouble” earlier in this chapter.

If icons do not appear correctly after you rebuild the desktop, restart your computer while pressing the Shift key to temporarily turn off system extensions. When you see the “Welcome to Macintosh—extensions off” message, release the Shift key and press the Option and ⌘ keys until you see a message asking if you want to rebuild the desktop.

#### **Your Macintosh can't read a floppy disk.**

If you see a message that a floppy disk is unreadable, try one of the following:

- If the disk has never been used, you may simply need to initialize it. For instructions, see the “Disks” topic of Macintosh Guide, available in the Guide (Ⓜ) menu.
- The disk may be damaged. See “Repairing a Damaged Disk” later in this chapter for information on testing and repairing disks.

If you are trying to use a DOS disk, consider the following:

- The disk may have been formatted incorrectly on a DOS computer. On DOS computers it's possible to format a standard double-sided disk in a high-density (1440K) format, and vice versa. Disks formatted in this way cannot be read by a Macintosh computer.

When formatting disks on a DOS computer, always format standard double-sided disks in the 720K format. Always format high-density disks in the 1440K format.

If a disk has been formatted incorrectly, use a DOS computer to copy its contents onto another disk that has been properly formatted.

**The pointer (⌘) freezes on the screen.**

Your system has a software problem.

- Press ⌘-Option-Esc to quit the application program in use when the problem occurred. If this works, you can save the documents open in other programs before restarting.
- Restart your Macintosh. (For instructions, see “Start Over” in the section “When You Run Into Trouble” earlier in this chapter.) Most software problems are temporary, and restarting usually corrects the problem.
- Check the startup disk and program you were using when the problem occurred. Make sure that all programs, desk accessories, and system extensions you’re using are compatible with the system software.
- Sometimes incompatible system extensions or control panels can cause system software problems. Restart while holding down the Shift key; this temporarily turns off all system extensions. If your computer works normally after you do this, remove all extensions from the Extensions folder (inside the System Folder) and put them back into the Extensions folder one at a time. Restart after you add each extension. This procedure should identify any incompatible extensions.

You can also use the Extensions Manager control panel to turn off individual extensions. For information on using this control panel to manage system extensions, see the “Setting Options” topic of Macintosh Guide, available in the Guide (🔍) menu.

- If the problem recurs, you may need to reinstall system software. See “Installing or Reinstalling System Software” later in this chapter for instructions.

**A dialog box with a bomb appears.**

Your system has a software problem.

- Write down what you were doing when the message appeared, and write down the message's text and its number, if there is one.
- Restart your Macintosh. (See "Start Over" in the section "When You Run Into Trouble" earlier in this chapter for instructions.) Most software problems are temporary, and restarting usually corrects the problem.
- Check the startup disk and application program you were using when the dialog box appeared. Make sure that all programs, desk accessories, and system extensions you're using are compatible with the system software. Reinstalling the system software may correct the problem.
- Sometimes incompatible system extensions or control panels can cause system software problems. Restart while holding down the Shift key; this temporarily turns off all system extensions. If your computer works normally after you do this, remove all extensions from the Extensions folder (inside the System Folder) and put them back into the Extensions folder one at a time. Restart after you add each extension. This procedure should identify any incompatible extensions.

You can also use the Extensions Manager control panel to turn off individual extensions. For information on using this control panel to manage system extensions, see the "Setting Options" topic of Macintosh Guide, available in the Guide (Ⓜ) menu.

- If the problem recurs, you may need to reinstall system software. See "Installing or Reinstalling System Software" later in this chapter for instructions.

**The pointer (⏏) doesn't move when you move the mouse.**

One of the following situations is probably the cause:

- Your system has a software problem.

Press ⌘-Option-Esc to quit the application program in use when the problem occurred. If this works, you can save the documents open in other programs before restarting.

Restart your Macintosh. See "Start Over" in the section "When You Run Into Trouble" earlier in this chapter for instructions.

Check the startup disk and program you were using when the problem occurred. Make sure that all programs, desk accessories, and system extensions you're using are compatible with the system software. Try starting up the computer from the *Disk Tools* disk or the CD-ROM disc that contains system software. (For instructions on how to start up your computer from the CD-ROM disc, see "Starting Up From a CD-ROM Disc" in the section "Initializing a Hard Disk" later in this chapter.) If your computer starts up normally, there may be an extension conflict.

If the problem recurs, you may need to reinstall system software. See "Installing or Reinstalling System Software" later in this chapter for instructions.

- The mouse is not connected properly.

Turn the computer off using the power switch, check that the mouse and keyboard cables are connected properly, and then restart the computer.

- Signals from the mouse are not reaching the computer, either because the mouse needs cleaning or because there is something wrong with the mouse.

Clean the mouse according to the instructions in Appendix A of this book.

If you have another mouse or pointing device, try connecting and using it. (Turn off the computer before connecting it.) If the new device works, there is probably something wrong with the mouse you replaced.

If none of these procedures solves the problem, consult the service and support information that came with your computer for instructions on how to contact an Apple-authorized service provider or Apple for assistance.

#### **Typing on the keyboard produces nothing on the screen.**

One of the following is probably the cause:

- Your system has a software problem.

Restart your Macintosh. For instructions, see "Start Over" in the section "When You Run Into Trouble" earlier in this chapter.

Check the startup disk and application program you were using when the problem occurred. Make sure that all programs, desk accessories, and system extensions you're using are compatible with the system software.

If the problem recurs, you may need to reinstall system software. See “Installing or Reinstalling System Software” later in this chapter for instructions.

- You haven’t selected any text or set the insertion point (I).

Make sure the program you want to type in is the active program. Then place the pointer (Ⓜ) in the active window and click to set an insertion point (I) or drag to select text (if you want to replace the text with your typing).

- The keyboard is not connected properly.

Turn off the computer using the power switch, then check that the keyboard cable is connected properly at both ends.

If you have a keyboard with an ADB port (marked with the ⌘ icon) on each end, turn off the Macintosh using the power switch and plug the keyboard cable into the other ADB port on the keyboard. (You may have to unplug the mouse to do this.) Then restart the computer.

Many Macintosh computers have two ADB ports on the back panel. Also, some monitors have one or two ADB ports. Turn off the Macintosh using the power switch and connect your keyboard cable to a different ADB port on the computer or monitor. Then restart the computer.

- The keyboard is damaged.

If you have access to another keyboard, try using it instead. (Turn the computer off before connecting it.) If the new keyboard works, there is probably something wrong with the one you replaced.

If none of these procedures solves the problem, consult the service and support information that came with your computer for instructions on how to contact an Apple-authorized service provider or Apple for assistance.



**You can't start an application program or it quits unexpectedly. Or, when you try to open a program, you see a message that not enough memory is available.**

One of the following is probably the cause:

- The Macintosh ran out of memory.

Quit the programs that you have open and then open the program you want to use, or restart your Macintosh.

Use the Memory control panel to turn on virtual memory. (This is especially important if you have a Power Macintosh computer or Power Macintosh upgrade card and are using programs designed specifically for the Power Macintosh.) For more information on virtual memory, see the “Memory” topic of Macintosh Guide, available in the Guide (🔍) menu.

- The program needs more memory.

Use the program's Info window to give it more memory. For more information on increasing a program's memory, see the “Memory” topic of Macintosh Guide, available in the Guide (🔍) menu.

- The program requires special hardware, such as a floating-point unit (FPU), and your computer doesn't have the hardware installed.

Check the documentation that came with the program to find out if the program requires a Macintosh with special hardware, such as an FPU. Then check the *Technical Information* booklet that came with your Macintosh to find out if your computer is equipped with such special hardware, or if the hardware can be installed. Consult your Apple-authorized service provider for information on installing special hardware in your computer.

**You see a message that an application program can't be found.**

The following dialog box appears if you try to open a document that was created with software that is not on your hard disk.

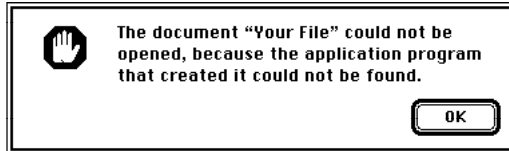

Normally, you see this message if you try to open a document that came from another Macintosh with software that is different from yours.

- Some documents can be opened by more than one application program. Try starting a program that you think might be able to open the document, then choose Open from the program's File menu to try to open the document.
- Purchase and install the correct software to use the document, or find out if the creator of the document can convert it to a form that one of your programs can use.
- Don't try to open the files in your System Folder. Most of the files in your System Folder are used by your computer for internal purposes and are not intended to be opened.
- Rebuild your desktop by holding down the Option and ⌘ keys while starting up your computer. Keep holding down the keys until you see a message asking whether you want to rebuild the desktop. Click OK.
- If the document is from a DOS computer, use the PC Exchange control panel to specify which Macintosh program will open the document. For information about working with DOS documents on your Macintosh, see the "Using DOS Files & Disks" topic of Macintosh Guide, available in the Guide (📖) menu.



**You experience problems using a document from a DOS computer.**

If you can't open a DOS document using a Macintosh program, try the following:

- Open the document from within the program by choosing Open in the program's File menu.
- Use the PC Exchange control panel to change the document's type to one that can be opened by the program.

If a DOS document is displayed incorrectly, or you see strange codes or characters in the document, try one of the following:

- Your application program may have special procedures for opening and saving documents with different file formats. See the information that came with your program.
- Try opening the document in another program.

*Note:* Some characters that can be displayed on the Macintosh are not accurately displayed on DOS computers.

For more information about working with DOS documents on your Macintosh, see the "Using DOS Files & Disks" topic of Macintosh Guide, available in the Guide (Ⓜ) menu.

**You see a message that your application program can't be opened because a file can't be found.**

Power Macintosh programs use special files called *shared libraries*. Any necessary shared libraries should be installed automatically when you install Power Macintosh programs.

Follow the directions that came with your program to reinstall the program. If the shared library is still missing, contact the software program's manufacturer for assistance.

**You experience problems using an older Macintosh program.**

Some older Macintosh programs are not completely compatible with Power Macintosh computers.

Open the Memory control panel and turn off Modern Memory Manager. For more detailed instructions, see the "Working with Programs" topic of Macintosh Guide, available in the Guide (🔍) menu.

## If your computer's performance decreases

If you notice a decrease in your computer's speed and general performance after you add special software (a control panel, system extension, or custom utility), it may be because your special software does not work well with Power Macintosh computers.

- To find out if your special software is the problem, hold down the Shift key while you restart the computer. This temporarily turns off certain kinds of software. If the computer performs better without this software, the software is likely to be the problem.
- Use the Extensions Manager control panel to turn off a system extension or set of extensions. For detailed instructions, see the "Setting Options" topic of Macintosh Guide, available in the Guide (🔍) menu. If the computer performs better when an extension is turned off, contact the extension's manufacturer for information or an upgrade.
- Drag special software items out of the System Folder or remove them permanently. (The special software may be in the Control Panels or Extensions folder inside the System Folder.) If the computer performs better when the software is removed, contact the software's manufacturer for information or an upgrade.

*Hint:* If you have more than one special software item, drag all the special items out of the Control Panels and Extensions folders. Then return them one at a time, restarting and checking your computer's performance each time until you identify the one that is causing problems.

If you still do not notice an improvement, follow the instructions in "Installing or Reinstalling System Software" later in this chapter to reinstall system software on your startup hard disk.

## Solving printer problems

- *LaserWriter Select 360, LaserWriter Pro 630, and LaserWriter Pro 810:* These printers require the latest printer software (called a *driver*) to print properly. If you use one of these printers, install the LaserWriter 8.1.1 printer driver, which is the latest LaserWriter driver, on your computer. You'll find the LaserWriter 8.1.1 driver, and instructions on how to install and use it, in the Apple Extras folder on your computer's hard disk.
- *Personal LaserWriter LS, LaserWriter Select 300, and Personal LaserWriter 300:* The system software installed on your computer includes a new version (version 1.2) of the Personal LaserWriter 300 printer driver. This driver works with all three of these printers. Do not install your older Personal LaserWriter LS or LaserWriter Select 300 drivers; the older printer drivers are not compatible with Power Macintosh computers.
- *StyleWriter and StyleWriter II printers:* The system software installed on your computer includes a new version (version 1.2) of the StyleWriter II printer driver. This driver works with both the StyleWriter II and the StyleWriter printers. Do not install your older StyleWriter driver; the older driver is not compatible with Power Macintosh computers.

If your printer is different from the ones just mentioned, its driver may not be included on the Power Macintosh hard disk. You should install the driver for your printer if you encounter printing problems. The following list shows where you can find the drivers not included on the Power Macintosh hard disk.

Printer	Print driver used	Version	Where to get it
LaserWriter IISC	Personal LaserWriter SC	7.0.1	System 7.0.1
Personal LaserWriter SC	Personal LaserWriter SC	7.0.1	System 7.0.1
ImageWriter LQ	LQ ImageWriter	7.0.1	System 7.0.1
AppleTalk ImageWriter LQ	LQ AppleTalk ImageWriter	7.0.1	System 7.0.1
LaserWriter Select 310	LW Select 310	7.0	Printer's disks
Apple Color Printer	Apple Color Printer	1.0	Printer's disks
Color StyleWriter Pro	Color StyleWriter Pro	1.5	Printer's disks
Portable StyleWriter	Portable StyleWriter	1.0	Printer's disks

## Choosing the correct networking software

Use networking software no older than the following versions with your Power Macintosh computer.

Network software	Version
AppleShare Server	4.0.2
Apple Internet Router	3.0.1
Inter•Poll	1.0.1
MacTerminal	3.0
Apple Remote Access	2.0 (client; personal server) 2.0.1 (MultiPort server)



## If you have trouble using a monitor with an AV-equipped Power Macintosh

Read the information in this section if you are having trouble using monitors with an AV-equipped Power Macintosh.

**The Monitors control panel indicates that you have two monitors, but you have only one.**

If you have only one monitor and it is connected to the high-density monitor port, the Monitors control panel assumes that a monitor is connected to the second monitor port, even if a second monitor isn't connected. In this situation, the Monitors control panel displays an image of a second, "ghost" monitor.

**IMPORTANT** Do not attempt to move the menu bar to the "ghost" monitor. If you do, follow these steps to restore normal video:

- 1 Shut down your computer. If you cannot see the Special menu, use the power switch to turn the computer off.**
- 2 Connect a monitor to the second monitor port. (For instructions, see "Connecting a Monitor" in Chapter 1.)**

If you have only one monitor, disconnect it from the high-density monitor port, and connect it to the second monitor port.

If your monitor is an AudioVision model, before you can connect it to the second monitor port you must attach the adapter cables from the AudioVision adapter kit. (If you don't have the adapter kit and don't have access to a second monitor, contact Apple for assistance.)

- 3 Restart your computer.**
- 4 Choose Control Panels from the Apple (🍏) menu and open the Monitors control panel.**
- 5 Make sure that the menu bar appears on the picture that represents your monitor.**
- 6 Close the Monitors control panel.**

If you don't want to leave the monitor connected to the second monitor port, you can shut down your computer, disconnect the monitor, and reconnect it to the high-density monitor port before restarting your computer.

*Note:* If you have only one monitor, there are several good reasons to leave it connected to the second monitor port instead of the high-density monitor port:

- You avoid setting up the “ghost monitor” situation just described.
- The second monitor port provides more colors on all monitors 13 inches or larger (measured diagonally), including the AudioVision 14 Display.
- If you are using the S-video input port to connect equipment for capturing video images, you’ll get a better video input frame rate with the monitor connected to the second monitor port.

**You see static or a blank screen after switching from a television to a monitor connected to the second monitor port.**

- Be sure the monitor you want to switch to is connected to your computer.

*Note:* If a monitor isn’t connected to the second monitor port, the television screen will go blank when you switch from the television to the monitor, and you will have to restart your computer to make the desktop appear on the television again. Don’t try to make the desktop appear by dragging the menu bar to the television and selecting Rearrange On Close in the Monitors control panel. (If you do, the menu bar will disappear, and you will have to restart your computer.)

- If you use a PAL-format television as your startup monitor, you must restart your computer before switching to a monitor connected to the second monitor port. Follow these steps each time you switch from a PAL-format television to a monitor:

**1** Quit all application programs (save any open documents before quitting).

**2** Be sure both the television and the monitor are connected to your computer.

If the monitor is not connected, shut down your computer and then connect the monitor.

**3** Choose Control Panels from the Apple () menu and open the Monitors control panel.

- 4 Click the picture that represents the television, then click Options.

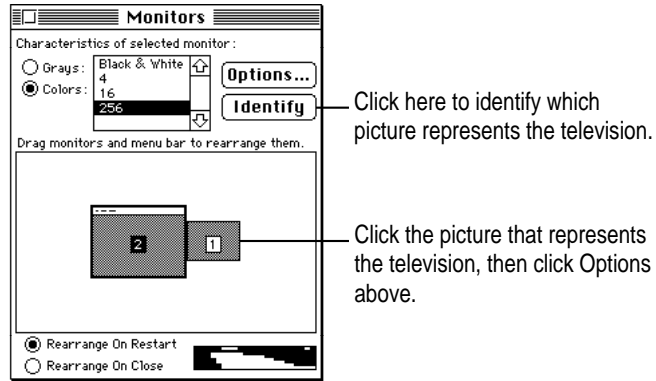

- 5 Make sure the box labeled "Upon Restart Display Video on Television" is not selected.

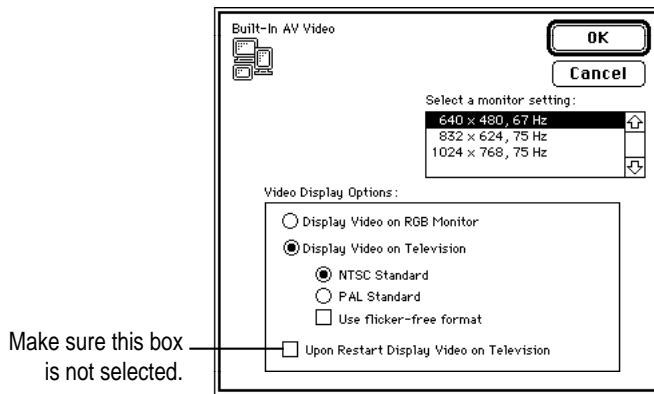

- 6 Close the Monitors control panel and restart your computer.



**You see wavy lines or static after switching to a television from a monitor connected to the second monitor port.**

If the regular (RGB) monitor is still connected, switch back to it. If the monitor is no longer connected, or you can't switch back to it, restart your computer. The next time you want to switch to a television, follow these steps:

- 1** Quit all application programs (save any open documents before quitting).
- 2** Be sure both the television and the monitor are connected to your computer.

If the television is not connected, shut down your computer and then connect the television.

- 3** Choose Control Panels from the Apple () menu and open the Monitors control panel.
- 4** Click the picture that represents the monitor, and click Options.

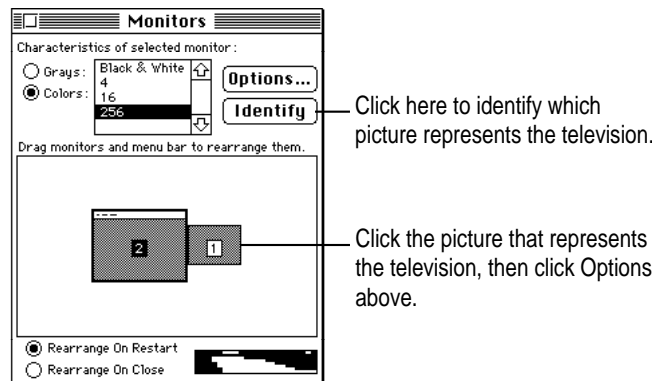

- 5 Select “Display Video on Television”; then select NTSC Standard, PAL Standard, or “Use flicker-free format,” and click OK.

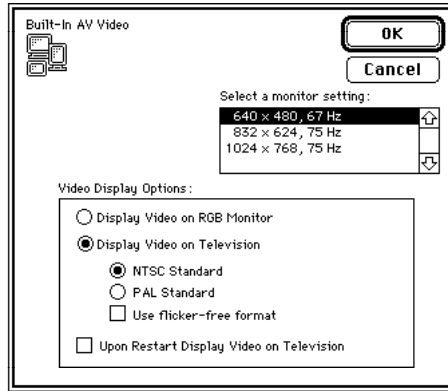

For information about video standards, see the “Video” topic of Macintosh Guide, available in the Guide (🔍) menu.

- 6 Click Switch in the dialog box that appears; then close the Monitors control panel.

**You can’t see the color wheel or other items.**

This problem can occur if you use a single monitor and it is not attached to the second monitor port. (See Chapter 1 for an illustration of the two monitor ports.)

The color wheel, and other color-choosing features, are set to be displayed on a screen that has the greatest color depth. On AV-equipped computers, the second monitor port may provide the greatest color depth. Even though you have no monitor attached to the second monitor port, your computer assumes that a monitor is attached there, and attempts to display the color wheel on that monitor instead of the real monitor.

Follow these steps:

- 1 Choose Control Panels from the Apple (🍏) menu, and open the Monitors control panel. The Monitors control panel displays two pictures representing monitors, even though you have only one monitor.
- 2 Click the picture that represents the “ghost” monitor; then click Black & White.
- 3 Close the Monitors control panel.

## Initializing a hard disk

Before you can use a new disk, the disk must be prepared so that the computer knows where to store information on the disk. This preparation is called *initializing* (or *formatting*) the disk.

### When do you need to initialize a hard disk?

The hard disk inside your computer was initialized at the factory, so you shouldn't need to initialize it. You need to initialize a hard disk only if

- you purchase a hard disk that has not been initialized at the factory
- your hard disk is damaged

If a hard disk needs to be initialized, the disk's icon does not appear on the desktop when you start up the computer using another disk.

**WARNING** Initializing a disk erases any information that may be on it. Before you initialize a damaged disk, try to repair it as described in “Repairing a Damaged Disk” later in this chapter.

### Starting up from a CD-ROM disc

To initialize, test, or repair a hard disk, or to install system software on a hard disk, you need start up your computer from another disk. If your computer has a CD-ROM drive, you can start up your computer using the CD-ROM disc containing system software that came with the computer.

To start up the computer using the CD-ROM disc, follow these steps:

- 1 Turn your computer on.
- 2 Press the Open/Close button on your CD-ROM drive, and quickly insert the CD-ROM disc containing system software into the drive.
- 3 Immediately press the C key on your keyboard.

Continue to hold down the key until you see the “Welcome to Macintosh” message.

*If a blinking question mark appears, or if the computer starts up from your hard disk:* You did not insert the CD-ROM disc quickly enough for the computer to recognize it as a startup disk. Follow these steps:

**1 Shut down your computer.**

The CD-ROM disc will remain in the CD-ROM drive.

**2 Turn the computer on.**

**3 Immediately press the C key on the keyboard.**

Continue to hold down the key until you see the “Welcome to Macintosh” message.

### Starting up from a floppy disk

To initialize, test, or repair a hard disk, or to install system software on a hard disk, you need to start up your computer from another disk. If you don't have a built-in CD-ROM drive, you can start up the computer using either the *Disk Tools* or *Install Disk 1* floppy disk that came with your computer.

To start up your computer using a floppy disk, follow these steps:

**1 Shut down your computer.**

**2 Insert the floppy disk into the disk drive.**

If you want to initialize, test, or repair your hard disk, use the *Disk Tools* disk to start up your computer. If you want to install system software, use the *Install Disk 1* disk.

**3 Turn on the computer.**

## How to initialize a hard disk

You initialize an Apple SCSI hard disk by using a program called Apple HD SC Setup, which is on the floppy disk labeled *Disk Tools* that came with your computer. If your computer came with a CD-ROM drive and you didn't receive floppy disks, you can find Apple HD SC Setup on the CD-ROM disc that contains system software.

- 1 **Start up your computer from the *Disk Tools* disk or the CD-ROM disc that contains system software.**

See “Starting Up From a CD-ROM Disc” or “Starting Up From a Floppy Disk” earlier in this section.

- 2 **Open the Apple HD SC Setup icon.**

You may need to look in a folder called Utilities to find Apple HD SC Setup.



Apple HD SC Setup

- 3 **Click Drive until the disk you want to initialize appears.**

You cannot initialize the disk that you used to start up your computer or the disk that contains the Apple HD SC Setup program.

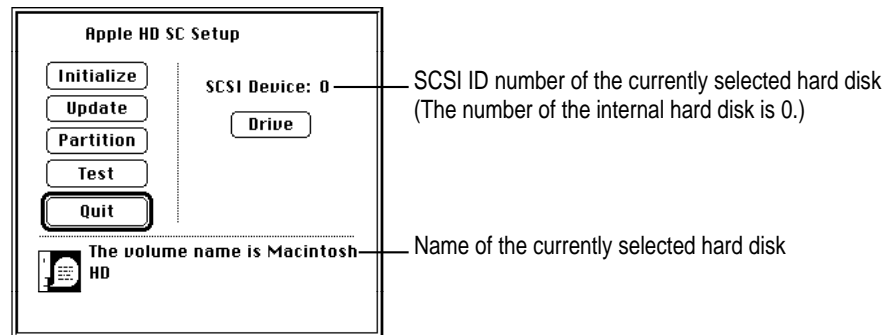

- 4 **Click Initialize.**

- 5 Click Init to initialize the hard disk.

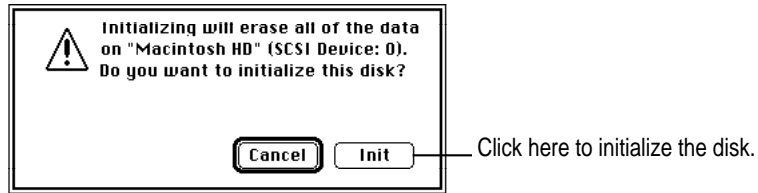

- 6 If a message appears asking you to name the disk, type a name and then click OK.
- 7 Click Quit when you see a message reporting that initialization was successful.

If a message reports that initialization failed, try again. If initialization fails a second time, take the disk to your Apple-authorized service provider for repair.

## Repairing a damaged disk

Disks can become damaged by repeated use and handling.

### When do you need to repair a disk?

If you see a message reporting that a disk is damaged or unreadable, you may need to repair the disk.

### Try these suggestions first

If you can't start up from a hard disk or you don't see the hard disk icon on the desktop, try the following:

- If the hard disk is internal, shut down your Macintosh, wait at least 10 seconds, and then turn it on again.
- If the hard disk is external, make sure that it is turned on and that its cable is connected firmly; then restart the Macintosh.
- If the hard disk is your startup disk, start up with a different startup disk. If the hard disk's icon appears on your desktop, reinstall system software on the hard disk (see “Installing or Reinstalling System Software” later in this chapter).
- Check the ID numbers of all SCSI equipment connected to your computer. Each device must have a unique ID number (the computer itself has the ID number 7, and the internal hard disk has the number 0). Also check that the chain of devices is terminated properly. For information on setting SCSI ID numbers and terminating a SCSI chain, see the manuals that came with your SCSI equipment.
- Test the disk following the instructions that come next.

## How to test a hard disk

You can test an Apple SCSI hard disk with the Apple HD SC Setup program, which is on the floppy disk labeled *Disk Tools* that came with your computer. If your computer has a built-in CD-ROM drive, and you didn't receive floppy disks, you can find the Apple HD SC Setup program on the CD-ROM disc that contains system software.

- 1 **Start up your computer from the *Disk Tools* disk or the CD-ROM disc that contains system software.**

See “Starting Up From a CD-ROM Disc” or “Starting Up From a Floppy Disk” in the section “Initializing a Hard Disk” earlier in this chapter.

- 2 **Open the Apple HD SC Setup icon.**

You may need to look in a folder called Utilities to find Apple HD SC Setup.



- 3 **Click Drive until the disk you want appears.**

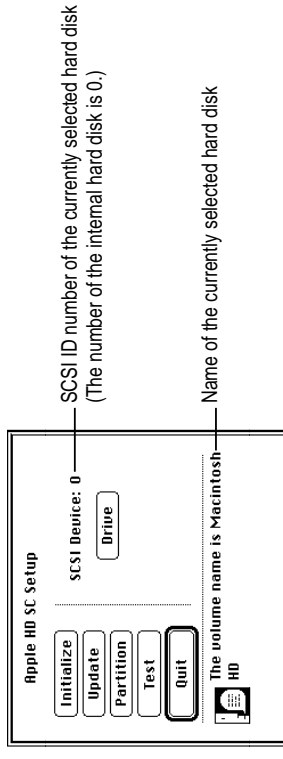

- 4 **Click Test.**
- 5 **When a message tells you that testing is complete, click Quit.**



If the test reveals a problem, you may be able to correct it by using Disk First Aid or another disk repair program (see the instructions in the next section), or you may need to reinitialize the disk (see “Initializing a Hard Disk” earlier in this chapter). Consult an Apple-authorized service provider for assistance if necessary.

### How to repair a hard disk or floppy disk

You can repair some types of disk damage by using the Disk First Aid program, which is included either on the *Disk Tools* floppy disk or on the CD-ROM disc containing system software that came with your computer.

- 1 **Start up your computer from the *Disk Tools* disk or the CD-ROM disc that contains system software.**

See “Starting Up From a CD-ROM Disc” or “Starting Up From a Floppy Disk” in the section “Initializing a Hard Disk” earlier in this chapter.

- 2 **Open the Disk First Aid icon.**

You may need to look in a folder called Utilities to find Disk First Aid.



Disk First Aid

- 3 Click the icon of the disk you want to test.

Disk icons appear in a box at the top of the Disk First Aid window.

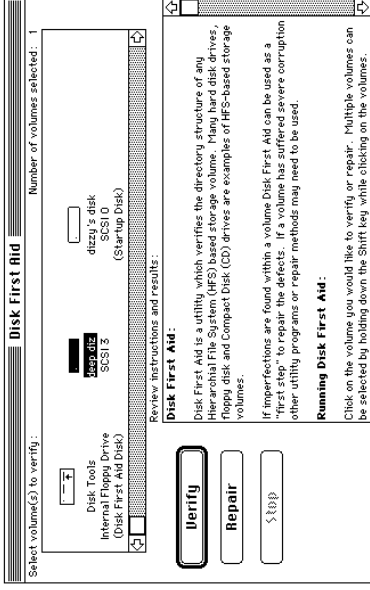

- 4 Click Repair to begin testing and repairing the disk.

You can't repair the startup disk or the disk that contains the Disk First Aid program, but you can test these disks by clicking Verify. If the program reveals a problem with either of these disks, start up the computer from another disk so that you can repair the damaged disk.

If you want to test and repair another disk, click its icon and then click Repair.

- 5 When testing and repair are finished, choose Quit from the File menu.

### **If Disk First Aid cannot correct the problem**

- Try repairing the disk again. Sometimes repeating the process corrects the problem.
- Use another disk repair or recovery program. Some disk repair programs let you recover information from a damaged disk.
- Consult a computer repair specialist for help.
- Once you have recovered all the information you can, erase (reinitialize) the disk. If initialization doesn't work, discard the damaged disk (if it's a floppy disk), or take it to your Apple-authorized service provider for repair (if it's a hard disk).

## Installing or reinstalling system software

System software is the set of programs and other files that your computer uses to start itself up, keep track of your files, and run the application programs you use. System software is kept in the folder called the System Folder. When you turn on your computer, it looks for a startup disk, which is a disk that contains the system software. The startup disk is usually the hard disk that's inside your computer, though another hard disk or a floppy disk can also be a startup disk.

The accessory kit that came with your Macintosh provides system software on either a set of floppy disks or a CD-ROM disc. You can use the floppy disks or the CD-ROM disc to install the system software on your Macintosh if you need to do so.

### When should you install system software?

Your Macintosh came with all the necessary system software installed on its internal hard disk, so you don't need to install system software on that disk unless you encounter software problems.

If you have a new hard disk or a newly initialized hard disk that doesn't contain system software, or if you want to upgrade to a more recent version of system software on a hard disk, follow the instructions in "Installing System Software" later in this chapter.

### When should you reinstall system software?

If you have a problem with your system software, you may see this icon in the middle of the screen:



If this icon appears, follow the instructions in "Repairing a Damaged Disk" earlier in this chapter to test your startup hard disk and repair any damage.

If repairing the disk doesn't help, follow the instructions in the next section, "Installing System Software," to reinstall system software on your startup hard disk.

## Installing system software

Follow the steps in this section to do what is commonly called a “normal” installation of system software.

If you’re installing system software on a hard disk for the first time, make sure that your hard disk has been initialized, a process that prepares the disk to store information. If you see the hard disk’s icon on the desktop when you start up the computer, the disk has been initialized. If no disk icon appears when you start up, see “Initializing a Hard Disk” earlier in this chapter for instructions.

To do a normal installation, follow these steps:

- 1 Start up your computer from the *Disk Tools* disk or the CD-ROM disc that contains system software.**

See “Starting Up From a CD-ROM Disc” or “Starting Up From a Floppy Disk” in the section “Initializing a Hard Disk” earlier in this chapter.

- 2 Find and open the Disk First Aid icon.**

You may need to look in a folder called Utilities to find Disk First Aid.



Disk First Aid

After Disk First Aid starts, follow the instructions on the screen. Disk First Aid checks your hard disk for any problems.

- 3 When Disk First Aid has finished checking your hard disk, choose Quit from the File menu.**
- 4 Open the Apple HD SC Setup program.**

You use the Apple HD SC Setup program to update your hard disk.
- 5 Make sure the disk indicated on the screen is your startup disk, then click Update.**
- 6 When you are finished, quit Apple HD SC Setup.**
- 7 Shut down your computer.**

- 8 Start up your computer from the *Install Disk 1* disk or the CD-ROM disc that contains system software.

See “Starting Up From a CD-ROM Disc” or “Starting Up From a Floppy Disk” in the section “Initializing a Hard Disk” earlier in this chapter.

The Installer’s Welcome screen appears. You may have to double-click the System Software Installer icon to open the Installer program.

- 9 Click OK.

The Easy Install dialog box appears.

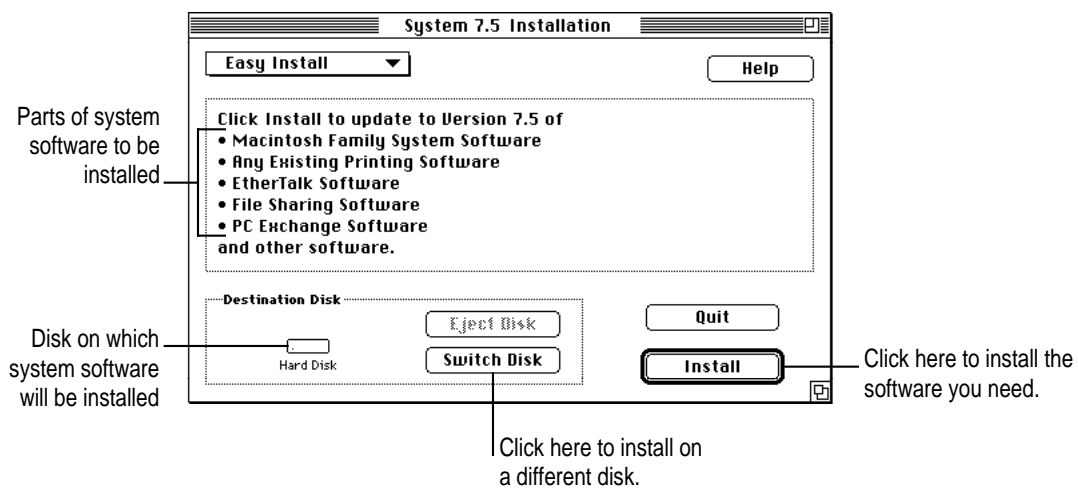

- 10 Make sure that the hard disk named in the box is the one on which you want to install system software.

If it isn't, click Switch Disk until the correct disk name appears.

- 11 Click Install.

- 12 Follow the instructions that appear on the screen.

If you're installing system software from floppy disks, you see messages asking you to insert different disks.

**13** When you see a message reporting that the installation was successful, click **Restart**.

If a message reports that installation was not successful, try installing again. (Follow the instructions on the screen.)

If, after reinstalling system software by doing a normal installation, you still experience problems with your computer, follow the steps in the next section for doing a “clean” installation of system software.

**IMPORTANT** Certain system extensions or application programs that were originally on your hard disk may not be installed with the Installer program. If you notice that a certain extension or program was not installed, you may need to install it separately. You can find these additional extensions and programs on the CD-ROM disc that contains system software. If you don't have a CD-ROM drive, see the service and support information that came with your computer for information on how to contact Apple directly for assistance.

### Doing a clean installation of system software

The steps in this section outline what is commonly called a “clean” installation of system software. Do a clean installation if you can't determine what is damaged in your System Folder (especially if you think any special software, such as control panels, system extensions, or custom utilities, may be causing the problems you're experiencing). You should also do a clean installation if you're still having problems with your computer after you've reinstalled system software by doing a normal installation.

To do a clean installation, follow these steps:

- 1 Start up your computer from the *Disk Tools* disk or the CD-ROM disc that contains system software.**

See “Starting Up From a CD-ROM Disc” or “Starting Up From a Floppy Disk” in the section “Initializing a Hard Disk” earlier in this chapter.

- 2 Find and open the Disk First Aid icon.**

You may need to look in a folder called Utilities to find Disk First Aid.



Disk First Aid

After Disk First Aid starts, follow the instructions on the screen. Disk First Aid checks your hard disk for any problems.

- 3 When Disk First Aid has finished checking your hard disk, choose Quit from the File menu.**
- 4 Find and open the Apple HD SC Setup icon.**

You may need to look in a folder called Utilities to find Apple HD SC Setup.



Apple HD SC Setup

- 5 Click Drive until the disk on which you want to reinstall system software appears.**
- 6 Click Update and follow the instructions on the screen.**
- 7 When you see a message that the update was successful, click Quit.**



- 8 Insert the *Install Disk 1* disk into the floppy disk drive, or insert the CD-ROM disc that contains system software into the CD-ROM drive.

The Installer's Welcome screen appears. You may have to double-click the System Software Installer icon to open the Installer program.

- 9 Click Continue.

The Easy Install dialog box appears.

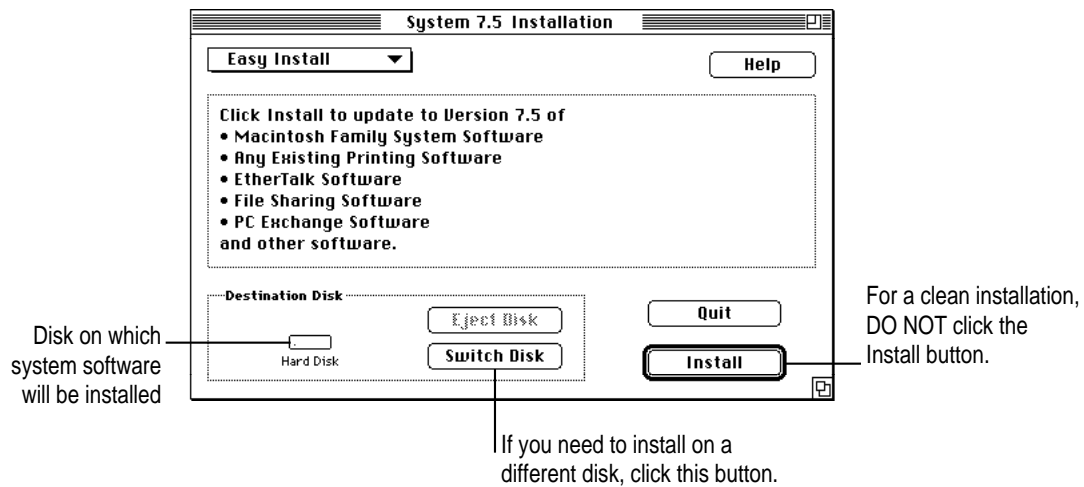

- 10 Make sure that the hard disk named in the Destination Disk box is the one on which you want to install system software.

If it isn't, click Switch Disk until the correct disk name appears.

- 11 Hold down Shift-⌘-K to start the clean installation.

The following dialog box appears.



- 12 Click the Install New System Folder button and click OK.

The Easy Install dialog box appears. The Install button has changed to Clean Install, and the contents of your old System Folder have been moved to a new folder named Previous System Folder.

- 13 Click Clean Install.

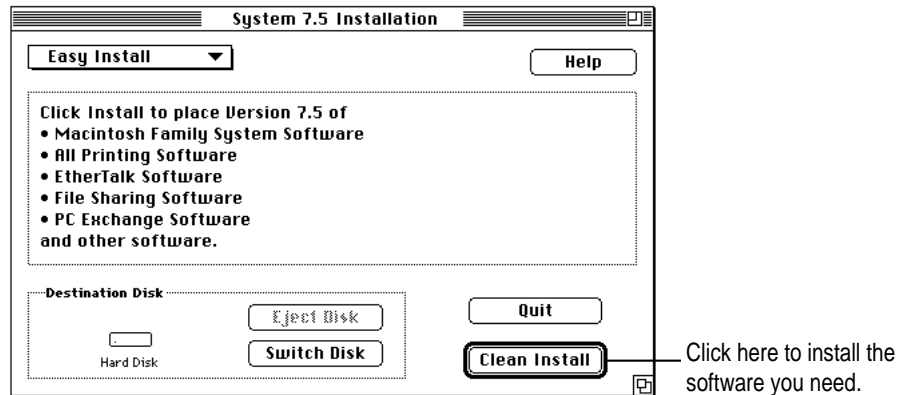

- 14 Follow the instructions that appear on the screen.

It takes a few minutes to complete the installation.

- 15 When you see a message reporting that the installation was successful, you may need to click Restart.

You need to click Restart only if you installed software onto the startup disk.

If a message reports that installation was not successful, try repeating the clean installation procedure.

### Replacing special software

- 1 Copy any special software items from the Previous System Folder back to your System Folder one item at a time, restarting the computer after copying each item.

Special software consists of items such as control panels, system extensions, or custom utilities that you may have added to your System Folder.

**IMPORTANT** Be very careful not to *replace* (copy over) any of the files in the System Folder with files from the Previous System Folder.

- 2 Check after each restart to make sure your computer is not having any software problems.

If any of your special software items cause software problems, contact the software manufacturer for assistance or an upgrade.

## Doing a custom installation

For most Macintosh users, the Easy Install procedure described in the previous sections is appropriate, because it automatically installs all the items you need. However, if you'd like to select a combination of system software files for your specific needs, you can customize your system software installation. You use custom installation to install or update one or more specific files, or to save space on your hard disk by installing only the files you want.

To install customized system software, follow these steps:

- 1 **Start up your computer from the *Install Disk 1* disk or the CD-ROM disc that contains system software.**

See “Starting Up From a CD-ROM Disc” or “Starting Up From a Floppy Disk” in the section “Initializing a Hard Disk” earlier in this chapter.

- 2 **Click OK.**

The Easy Install dialog box appears.

- 3 **Choose Custom Install from the pop-up menu.**

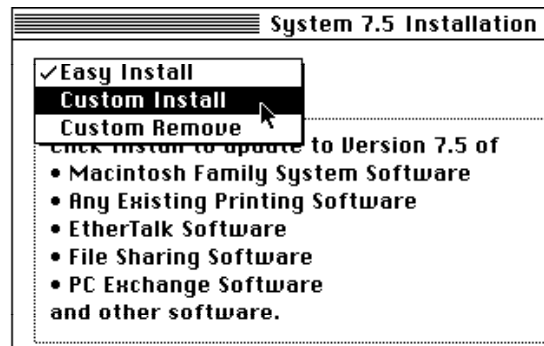

The Custom Install dialog box appears, listing all available system software components.

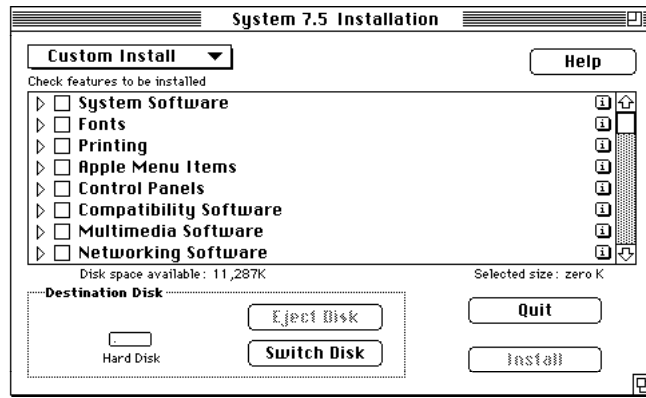

- 4 Scroll through the list of components, clicking the checkbox next to each component you want to install.

To get additional information about each component listed, click the box with the letter *i* in it to the right of the component.

- 5 Click Install.
- 6 Follow the instructions that appear on the screen.
- 7 When you see a message reporting that the installation was successful, click Quit.

If a message reports that installation was not successful, try installing again. (Follow the instructions on the screen.)

- 8 Restart your Macintosh.

The system software is installed and your computer is ready to use.

Read this appendix for important health and safety instructions, as well as tips on keeping your computer in good working order.



## Appendix A Health, Safety, and Maintenance Tips



For your own safety and that of your equipment, follow all the instructions in this chapter. Keep these instructions available for reference by you and others.

### Health-related information about computer use

Muscle soreness, eye fatigue, and other discomforts and injuries sometimes associated with using computers can occur from performing any number of activities. In fact, misuse of the same muscles during multiple activities can create a problem that might not otherwise exist. For example, if you engage in nonwork activities that involve repetitive stress on the wrist—such as bicycling—and also use your computer’s keyboard improperly, you may increase your likelihood of developing wrist problems. Some individuals are at greater risk of developing these problems because of their health, physiology, lifestyle, and general exposure to stress. Work organization and conditions, such as workstation setup and lighting, also play a part in your overall health and comfort. Preventing health problems is a multifaceted task that requires careful attention to the way you use your body every hour of every day.

The most common health effects associated with using a computer are musculoskeletal discomfort and eye fatigue. We’ll discuss each area of concern below.

## Musculoskeletal discomfort

As with any activity that involves sitting for long periods of time, using a computer can make your muscles sore and stiff. To minimize these effects, set up your work environment carefully, using the guidelines that follow, and take frequent breaks to rest tired muscles. To make working with your computer more comfortable, allow enough space in your work area so that you can change position frequently and maintain a relaxed posture.

Another type of musculoskeletal concern is repetitive stress injuries (RSIs), also known as cumulative trauma disorders (CTDs). These problems can occur when a certain muscle or tendon is repeatedly overused and forced into an unnatural position. The exact causes of RSIs are not totally understood, but in addition to awkward posture, such factors as the amount of repetition, the force used in the activity, the individual's physiology, workplace stress level, and lifestyle may affect the likelihood of experiencing an RSI.

RSIs did not suddenly arise when computers were invented; tennis elbow and writer's cramp, for example, are two RSIs that have been with us for a long time. Although less common than other RSIs, one serious RSI discussed more often today is a wrist problem called carpal tunnel syndrome, which may be aggravated by improper use of computer keyboards. This nerve disorder results from excessive pressure on the median nerve as it passes through the wrist to the hand.

This section offers advice on setting up your work area to enhance your comfort while you use your computer. Since the effects of repetitive movements associated with using a computer can be compounded by those of other work and leisure activities to produce or aggravate physical problems, proper use of your computer system must be considered as just one element of a healthy lifestyle.

No one, of course, can guarantee that you won't have problems even when you follow the most expert advice on using computer equipment. You should always check with a qualified health specialist if muscle, joint, or eye problems occur.

## Eye fatigue

Eye fatigue can occur whenever the eyes are focused on a nearby object for a long time. This problem occurs because the eye muscles must work harder to view an object that's closer than about 20 feet (6 meters). Improper lighting can hasten the development of eye fatigue. Although eye fatigue is annoying, there's no evidence that it leads to permanent damage.

Whenever you're engaged in an activity that involves close-up work—such as reading a magazine, doing craft work, or using a computer—be sure to have sufficient glare-free lighting and give your eyes frequent rest breaks by looking up and focusing on distant objects. Remember to have your eyes examined regularly.

To prevent discomfort and eye fatigue:

- Arrange your work space so that the furniture is properly adjusted for you and doesn't contribute to an awkward working posture.
- Take frequent short breaks to give your muscles and eyes a chance to rest.

## Arranging your office

Here are some guidelines for adjusting the furniture in your office to accommodate your physical size and shape.

- An adjustable chair that provides firm, comfortable support is best. Adjust the height of the chair so your thighs are horizontal and your feet flat on the floor.

The back of the chair should support your lower back (lumbar region). Follow the manufacturer's instructions for adjusting the backrest to fit your body properly.

- When you use the computer keyboard, your shoulders should be relaxed. Your upper arm and forearm should form an approximate right angle, with your wrist and hand in roughly a straight line.

You may have to raise your chair so your forearms and hands are at the proper angle to the keyboard. If this makes it impossible to rest your feet flat on the floor, you can use a footrest with adjustable height and tilt to make up for any gap between the floor and your feet. Or you may lower the desktop to eliminate the need for a footrest. Another option is to use a desk with a keyboard tray that's lower than the regular work surface.

- Position the mouse at the same height as your keyboard. Allow adequate space to use the mouse comfortably.
- Arrange the monitor so the top of the screen is slightly below your eye level when you're sitting at the keyboard. The best distance from your eyes to the screen is up to you, although most people seem to prefer 18 to 28 inches (45 to 70 cm).
- Position the monitor to minimize glare and reflections on the screen from overhead lights and windows. You may want to use a tiltable monitor stand. The stand lets you set the monitor at the best angle for viewing, helping to reduce or eliminate glare from lighting sources you can't move.

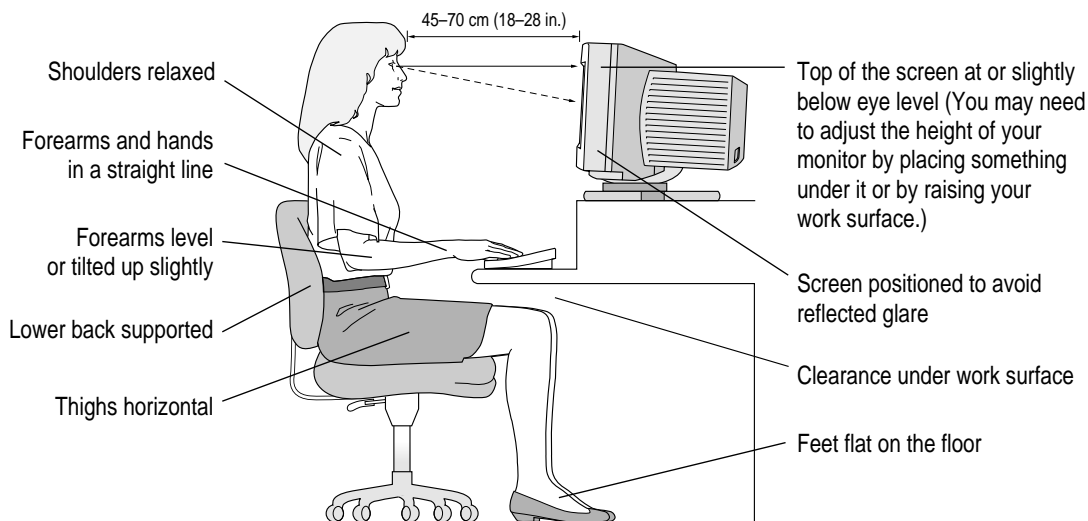



## Avoiding fatigue

- Change your seated position, stand up, or stretch whenever you start to feel tired. Frequent short breaks are helpful in reducing fatigue.
- Use a light touch when typing or using a mouse and keep your hands and fingers relaxed.
- Some computer users may develop discomfort in their hands, wrists, or arms after intensive work without breaks. If you begin to develop chronic pain or discomfort in your hands, wrists, or arms, consult a qualified health specialist.
- Allow adequate work space so that you can use your keyboard and mouse comfortably. Place papers or other items so you can view them easily while using your computer. A document stand may make reading papers more comfortable.
- Eye muscles must work harder to focus on nearby objects. Occasionally focus your eyes on a distant object, and blink often while you work.
- Clean your screen regularly. Keeping the screen clean helps reduce unwanted reflections.

## What about electromagnetic emissions?

There has been recent public discussion of the possible health effects of prolonged exposure to extremely low frequency (ELF) and very low frequency (VLF) electromagnetic fields. Such fields are associated with electromagnetic sources such as television sets, electrical wiring, and some household appliances—as well as computer monitors.

Apple has reviewed scientific reports and sought the counsel of government regulatory agencies and respected health organizations. Based on the prevailing evidence and opinions, Apple believes that the electric and magnetic fields produced by computer monitors do not pose a health risk.

In response to those customers who wish to reduce their exposure to electromagnetic fields, Apple has lowered the emission levels of our products. We are also actively encouraging further scientific research so we can continue to promote the health and safety of our customers and employees.

## Safety instructions

For your own safety and that of your equipment, always take the following precautions.

Turn off the computer completely and disconnect the power plug (by pulling the plug, not the cord) if any of the following conditions exists:

- the power cord or plug becomes frayed or otherwise damaged
- you spill something into the case
- your Macintosh is exposed to rain or any other excess moisture
- your Macintosh has been dropped or the case has been otherwise damaged
- you suspect that your Macintosh needs service or repair
- you want to clean the case (use only the recommended procedure described later in this chapter)

Be sure that you always do the following:

- Keep your Macintosh away from sources of liquids, such as wash basins, bathtubs, shower stalls, and so on.
- Protect your Macintosh from dampness or wet weather, such as rain, snow, and so on.
- Read all the installation instructions carefully before you plug your Macintosh into a wall socket.
- Keep these instructions handy for reference by you and others.
- Follow all instructions and warnings dealing with your system.

**WARNING** Electrical equipment may be hazardous if misused. Operation of this product, or similar products, must always be supervised by an adult. Do not allow children access to the interior of any electrical product and do not permit them to handle any cables.

## Handling your computer equipment

Follow these guidelines for handling your computer and its components:

- When setting up your computer, place components on a sturdy, flat surface, and carefully follow all setup instructions.
- When connecting or disconnecting a cable, always hold the cable by its connector (the plug, not the cord).
- Turn off your computer and all its components before connecting or disconnecting any cables to add or remove any component. Failure to do so could seriously damage your equipment.
- Never force a connector into a port. If the connector and port do not join with reasonable ease, they probably don't match. Make sure that the connector matches the port and that you have positioned the connector correctly in relation to the port.
- Take care not to spill any food or liquid on the computer, keyboard, mouse, or other components. If you do, turn your computer off immediately and unplug it before cleaning up the spill. Depending on what you spilled and how much of it got into your equipment, you may have to bring your equipment to an Apple-authorized service provider.
- Protect the computer and its components from direct sunlight and rain or other moisture.
- Keep all ventilation openings clear and unobstructed. Without proper air circulation, components can overheat, causing damage or unreliable operation.

**WARNING** This equipment is intended to be electrically grounded. Your Macintosh is equipped with a three-wire grounding plug—a plug that has a third (grounding) pin. This plug will fit only a grounded AC outlet. This is a safety feature. If you are unable to insert the plug into the outlet, contact a licensed electrician to replace the outlet with a properly grounded outlet. Do not defeat the purpose of the grounding plug!

## Handling the monitor

Follow these procedures for handling a monitor:

- Turn down the screen brightness control if you leave the computer turned on for extended periods. If the brightness is not turned down, the image on the screen could “burn in” and damage the screen.

You can also use a “screen saver” program, which dims or varies the image on the screen when the computer has been idle for a specified period of time. These programs are available from independent suppliers and user groups.

- Make sure that the ventilation openings on the computer and the monitor are clear and unobstructed.
- Some large monitors cannot safely be placed on top of the computer. Check the instructions that came with the monitor for setup information.
- If there is interference on the monitor’s screen or on a television or radio near your computer, move the affected equipment farther away.

## Handling the keyboard

Take care not to spill any liquid on the keyboard. If you do, turn off your computer immediately.

- If you spill liquid that is thin and clear, unplug the keyboard, turn it upside down to let the liquid drain out, and let it dry for 24 hours at room temperature. If, after you take these steps, the keyboard doesn’t work, take it to an Apple-authorized service provider for repair.
- If you spill liquid that is greasy, sweet, or sticky, unplug the keyboard and take it to an Apple-authorized service provider for repair.

## Handling floppy disks

Store disks at temperatures between 50° F and 125° F.

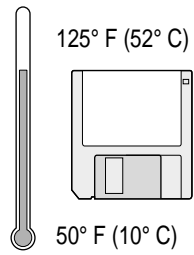

Do not use a pencil or an eraser on a disk or disk label.

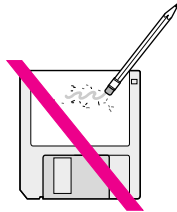

Keep disks dry.

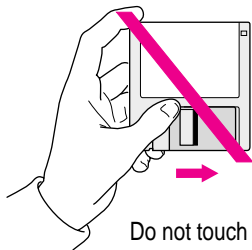
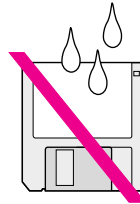

Do not touch the exposed part of the disk behind the metal shutter.

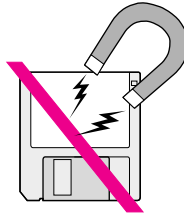

Keep disks away from magnets.

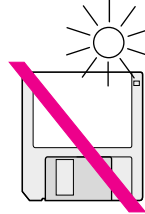

Avoid exposing disks to extremely hot temperatures.

## Ejecting a disk

For instructions on ejecting a floppy disk, a CD-ROM disc, or a removable media disk, see the “Disks” topic of Macintosh Guide, available in the Guide (🔍) menu.

## If you can't eject a floppy disk

If you can't eject a floppy disk in the usual way, try the following in order:

- Hold down the ⌘ and Shift keys and press the number 1 key on your keyboard to eject a disk in the internal disk drive.
- Turn off the computer. If the disk isn't ejected, then hold down the button on your mouse or other pointing device while you turn the computer on again.
- Locate the small hole near the disk drive's opening, and carefully insert the end of a large straightened paper clip into it. Push gently until the disk is ejected. Do not use excessive force.

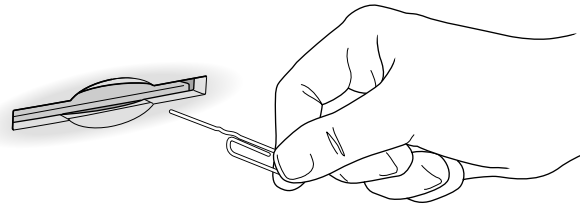

If nothing works, take the computer or disk drive to your Apple-authorized service provider to have the disk removed.

## Power supply

The power supply in your computer is a high-voltage component and should not be opened for any reason, even when the computer is off. If the power supply needs service, contact your Apple-authorized dealer or service provider.

## Cleaning your equipment

Follow these general rules when cleaning the outside of your computer and its components:

- Use a damp, soft, lint-free cloth to clean the computer's exterior. Avoid getting moisture in any openings.
- Don't use aerosol sprays, solvents, or abrasives.

### Cleaning the computer case

To clean the case, do the following:

- 1 Turn off the computer completely and then disconnect the power plug. (Pull the plug, not the cord.)
- 2 Wipe the surfaces lightly with a clean, soft cloth dampened with water.

### Cleaning the monitor

To clean the screen, put household glass cleaner on a soft cloth and wipe the screen. Don't spray the cleaner directly on the screen, because the liquid might drip into the monitor or computer.

### Cleaning the mouse

The mouse contains a small ball that must roll smoothly for the mouse to work properly. You can keep this ball free of dirt and grease by using the mouse on a clean, lint-free surface and cleaning it occasionally.

You need a few cotton swabs and a clean, soft, lint-free cloth.

- 1 Turn off your computer.

- 2 Turn the mouse upside down and turn the plastic ring on the bottom counterclockwise to disengage it.

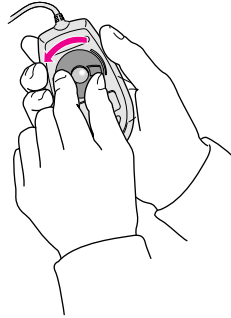

If you have an older mouse, you may need to press the plastic ring (rather than turn it) to disengage it.

- 3 Turn the mouse right side up with one hand and catch the ring and the ball with your other hand.
- 4 Clean the three small rollers inside the mouse with a cotton swab moistened with water. Rotate the rollers to clean all around them.

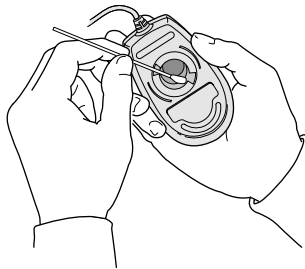

- 5 Wipe the mouse ball with a clean, soft, dry, and lint-free cloth.
- 6 If necessary, wash the mouse ball with warm soapy water (use a mild soap such as a dishwashing liquid) and then dry the mouse ball thoroughly.
- 7 Gently blow into the mouse case to remove any dust that has collected there.
- 8 Put the ball and the ring back in place.

Your mouse should roll smoothly across your mouse pad or desk. If it doesn't, repeat these instructions carefully.



Read this appendix for instructions  
on installing an expansion card  
in your computer.



## Appendix B Installing an Expansion Card

•••••

You can install printed circuit boards (called *cards*) for video and graphics applications, networking and communications, additional processing power, or other purposes. The cards fit into connectors, called *expansion slots*, inside the computer.

Your Macintosh has three expansion slots, each designed to accept a NuBus card.

**WARNING** Be sure to use the Macintosh NuBus Adapter Card designed specifically for your model of the computer. Failure to do so could damage the card and your computer.

**WARNING** Do not remove any factory-installed cards from inside your computer. Pulling a factory-installed card out at an angle can damage your equipment. Any NuBus expansion card you install will not operate properly if the factory-installed card has been removed. If a factory-installed card needs to be removed, see an Apple-authorized service provider.

**IMPORTANT** Some cards may need to be installed by an Apple-authorized service provider. Check the information that came with the card.

## Installing a card with a DAV connector in your AV-equipped Power Macintosh computer

If you have a Power Macintosh with built-in AV capabilities, you can install a NuBus card that contains a Digital Audio and Video (DAV) connector. This connector provides direct access to the specialized digital audio and video hardware built into your computer.

The illustration below shows the location of the expansion slots in your computer. If you wish to install a NuBus card that contains a DAV connector, you must use the indicated expansion slot (the one nearest the center of the computer's case).

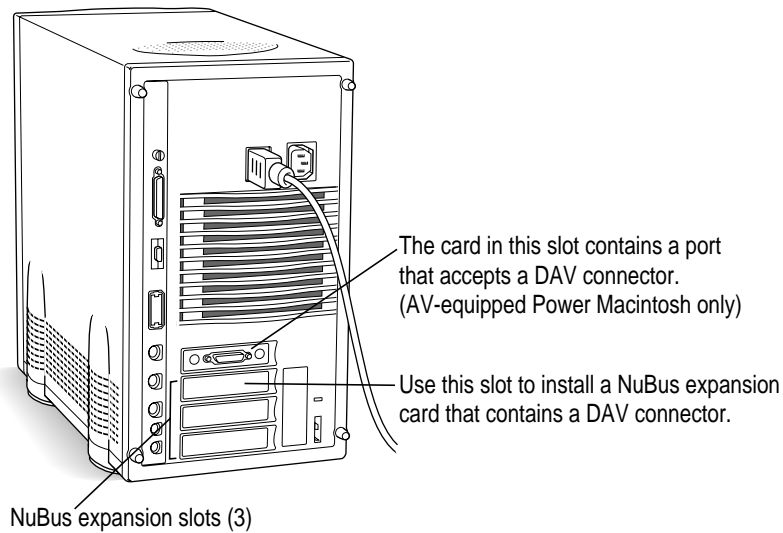

## NuBus power requirements

The combined power consumption of NuBus cards must not exceed the limits specified for your Macintosh model. If you have more than one NuBus card installed, check the information that came with your cards to make sure that their power consumption is within the limits specified in the *Technical Information* booklet.

## Installing a NuBus card

**IMPORTANT** Some cards may need to be installed by an Apple-authorized service provider. Check the information that came with the card.

Follow these steps to install a NuBus expansion card or a DAV card.

- 1 Turn off and unplug the computer.**

Make sure the computer is turned off and unplugged.

- 2 Loosen the four large screws at the corners of the back panel.**

Do not remove the screws or the back panel.

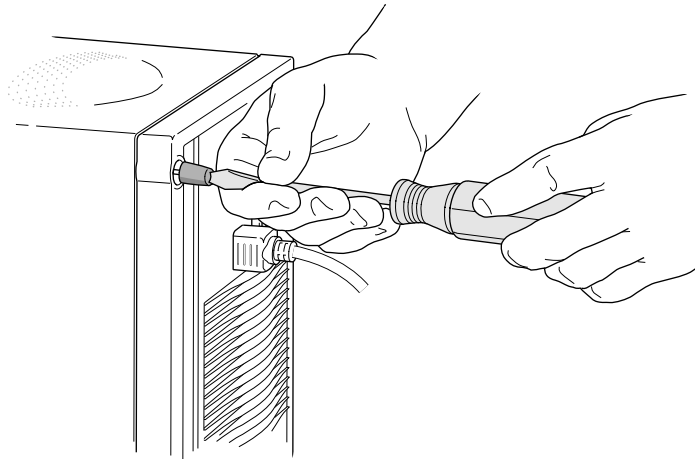

**3 Remove the cover from the computer.**

Slide the cover away from the back panel an inch or two. Then raise the cover straight up and off the computer.

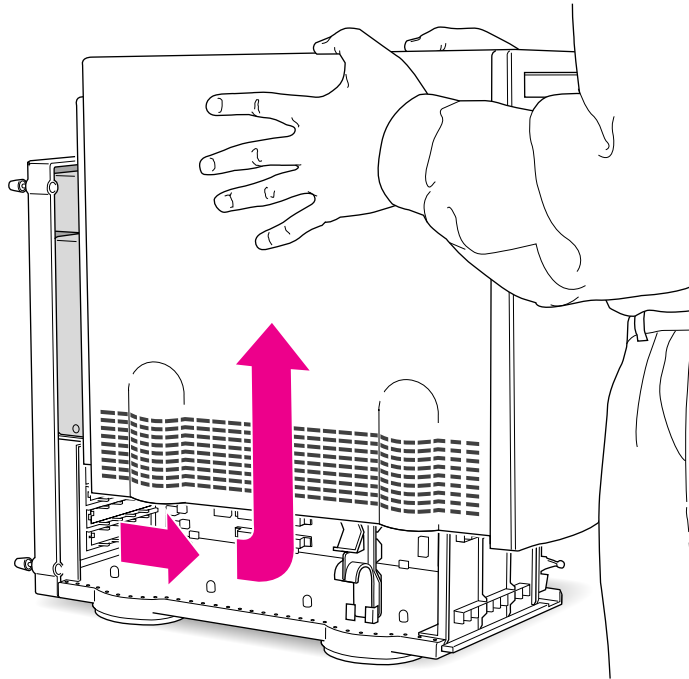

- 4 **Touch the metal part of the power supply case inside the computer to discharge static electricity.**

Always do this before you touch any parts, or install any components, inside the computer.

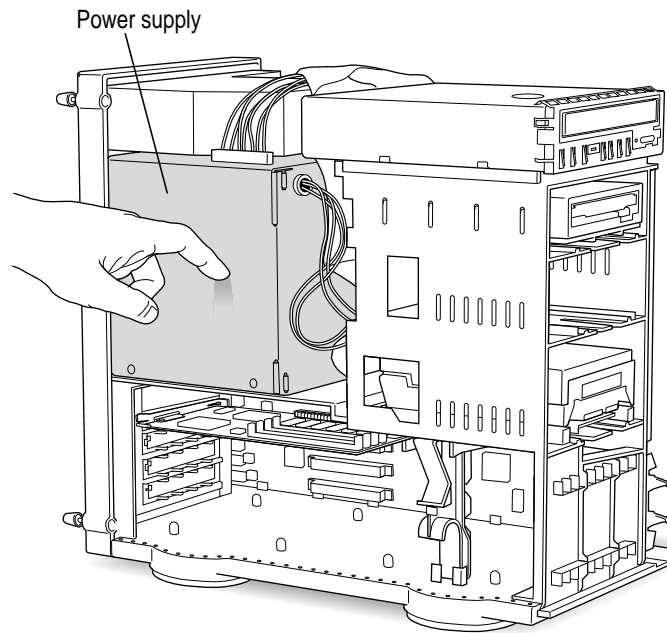

**5 Remove the expansion card clip.**

Grasp the clip handles with your thumb and forefinger and squeeze. Pull the clip straight out.

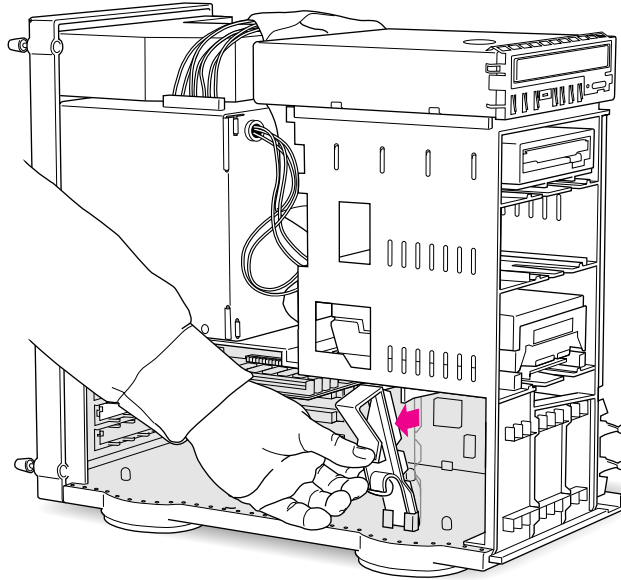

- 6** Pull out the plastic cover plate behind the expansion slot you want to use, and set the cover plate aside.

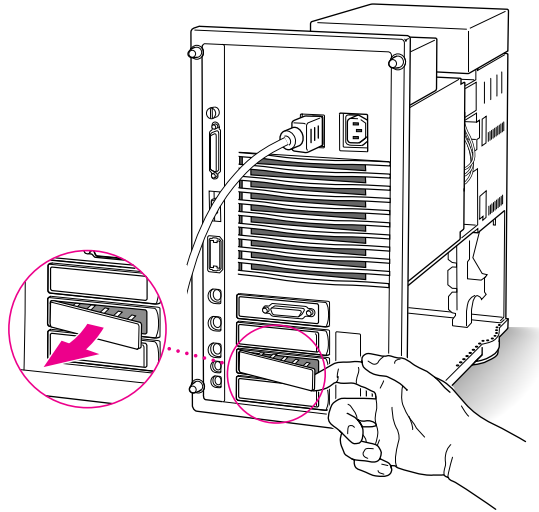

*Note:* If you are installing a card with a DAV connector, make sure to use the slot nearest the center of the computer's case. (See “Installing a Card With a DAV Connector in Your AV-Equipped Power Macintosh Computer” earlier in this chapter.)

- 7** Remove the card from its static-proof bag.

Hold the card by its edges to avoid touching the connector.

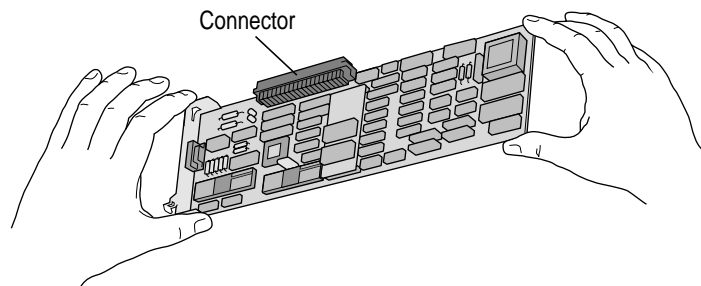

- 8** Align the connector end of the card with the expansion slot.

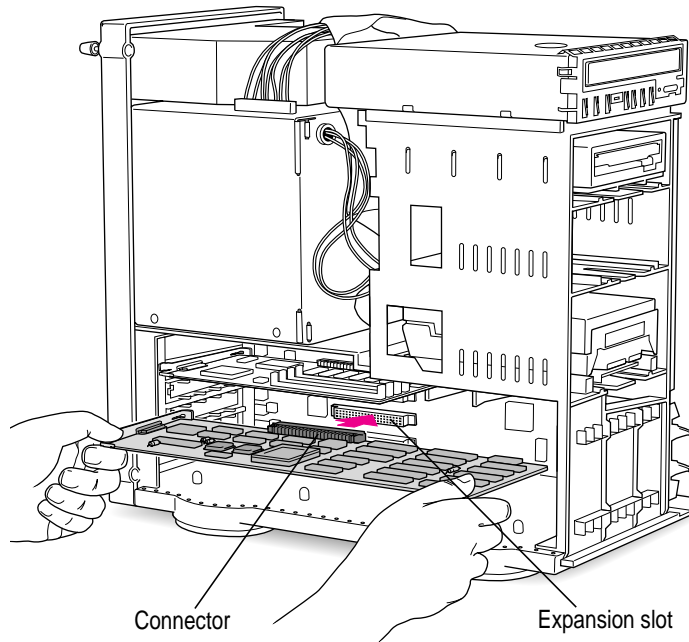

- 9** Press the card gently but firmly until the connector is fully inserted.

- Don't force the card. If you meet a lot of resistance, pull the card out and try again.
- To see if the card is properly connected, wiggle it gently. If it resists and stays in place, it's connected. (Make sure you don't wiggle the card so much that you accidentally disconnect it.)

If you have other cards to install, put them in now by repeating steps 6 through 9.



**10** Replace the expansion card clip.

Put the bottom of the clip in place first. Make sure the edge of the expansion card fits into one of the grooves on the clip.

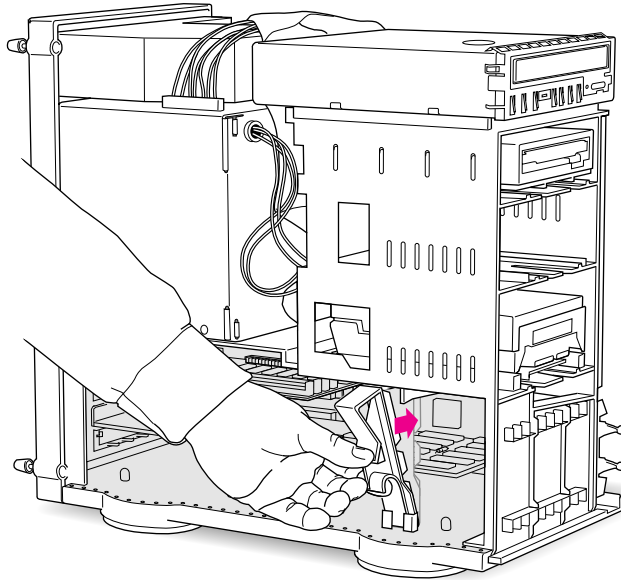

**11 Replace the cover on the computer.**

Lower the cover all the way down onto the case. Push the cover back until it touches the back panel.

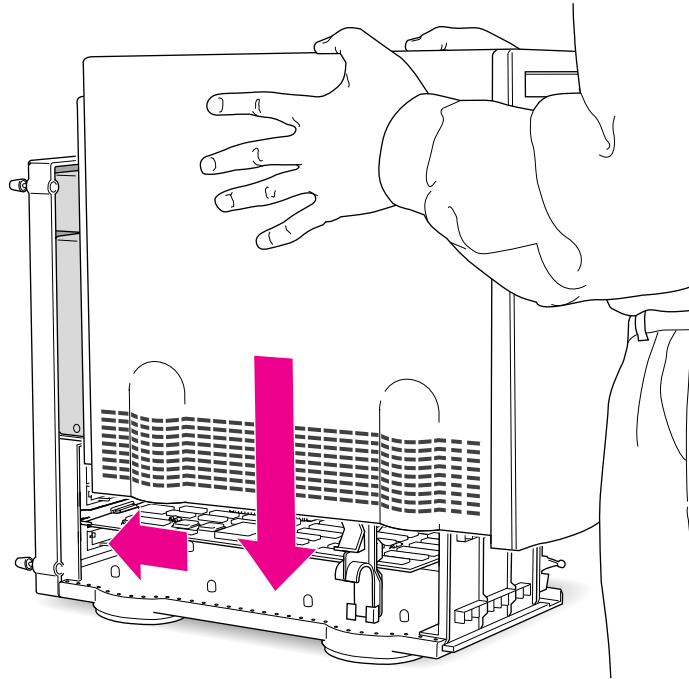

**12 Tighten the screws on the back panel.**

You are now finished installing the card. You may turn on the computer and start using the new card.

**WARNING** Always replace the cover before turning the computer on.





Read this appendix to learn how to use the special keys on your keyboard.

## Appendix C Special Keys on Your Keyboard

Your computer keyboard contains certain special keys that typewriter keyboards don't have. Many of these keys allow you to give commands to the computer without using the mouse. For example, in many application programs, pressing the ⌘ (Command) key at the same time as the Q key is often an alternative method of quitting a program.

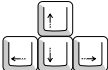











The following table describes what you can do with the special keys on your keyboard. The number of special keys on your keyboard may vary from this list; it depends on the model of keyboard you have.

### Special keys on Apple keyboards

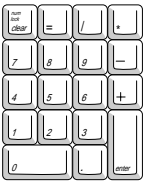
<b>Arrow keys</b>		Use to move the insertion point, as an alternative to using the pointer. In some programs, the arrow keys have other functions.
<b>Caps Lock key</b>		Use to capitalize a series of letters (numbers and symbols aren't affected).
<b>Clear key</b>		Use to delete the current selection (or use the Delete key). In some programs, Clear has other functions.
<b>⌘ (Command) key</b>		Use in combination with other keys as an alternative to choosing a menu command.

*continued* ►

## Special keys on Apple keyboards *(continued)*

<b>Control key</b>		In combination with other keys, this key provides shortcuts or modifies other actions.
<b>Delete key</b>		Use to delete selected material, or the character to the left of the insertion point.
<b>Enter key</b>		In a dialog box, pressing Enter is the same as clicking the outlined button. In some programs, pressing this key confirms information you have provided.
<b>Escape key</b>		The function of this key depends on the program you're using.
<b>Function keys</b>		Some programs allow you to use the 12 function keys to give commands. You can assign commands or action sequences to function keys with special utility programs.
<b>Option key</b>		Use in combination with other keys to produce special characters or modify actions.
<b>Numeric keys</b>		Use to produce numbers and mathematical symbols; some programs use these keys as function keys to initiate actions.
<b>Power key</b>		On some models, press to turn on the computer. Also press to shut down the computer on certain models.
<b>Return key</b>		Use to move the insertion point to the beginning of the next line. In a dialog box, pressing Return is the same as clicking the outlined button.
<b>Shift key</b>		Use to produce capital letters (or the upper character on the key).
<b>Other special keys</b>		The function of these keys depends on the operating system and program you're using.
<b>Tab key</b>		Use to move the insertion point to the next stopping place (such as a tab stop or field in a dialog box or program).

If you can't find what you're looking for in this index, look in Macintosh Guide—available in the Guide (🔍) menu on your computer.



## Index

• • • • •

### A

- accessory kit 90
- activating applications 20
- active applications, identifying 53
- adapter kit, AudioVision monitors 76
- adapters
  - for devices using composite video format 33, 41–42, 43
  - diagram x
  - Y-shaped 44, 46
- ADB (Apple Desktop Bus) port, location of 32, 33
- air circulation 4, 105
- amplifier, attaching 35
- Apple AudioVision monitors 3
- Apple Desktop Bus (ADB) icon 8
- Apple Desktop Bus (ADB) port 8, 68
- Apple Extras folder 51
- Apple HD SC Setup icon 83, 86
- Apple HD SC Setup program 83, 86, 91, 94
- Apple Internet Router network software 75
- Apple PlainTalk Microphone
  - connecting 46
  - and speech-recognition technology 36
- Apple PlainTalk software, for speech recognition 37
- Apple Remote Access network software 75
- AppleScript program 51
- AppleShare Server network software 75
- Application menu
  - choosing Finder 20, 27
  - Hide Others command 54
  - open programs listed 53
  - Show All command 54
- applications
  - activating 20
  - compatibility with system software 56, 66–67, 72–73
  - disk repair 87, 89
  - finding 70
  - identifying active 53
  - installing 51–52
  - memory usage of 55, 69
  - networking software 75
  - opening 55, 69–70, 72
  - preinstalled 51
  - quitting when system freezes 65–66
  - quit unexpectedly 69
  - screen saver 61, 106
  - starting 69
  - switching to another 53
  - troubleshooting 65–66, 69–70, 72
  - types for Power Macintosh ix, 55–56
  - working with several 53–54

- arranging equipment 4
- arrow keys 121
- arrow on screen
  - frozen 57, 65–66
  - moving 15
- audio and video input connections, diagram 44
- audio and video presentations, setup for 45–47
- audio cables, with dual RCA plugs and stereo miniplug 43, 46
- audio compact discs 34
- audio equipment. *See also* sound capabilities 34
  - connecting external stereo speakers 38
  - connecting a microphone 36–37
  - connecting to play or record sound 35–36
- audio input equipment, ports for connecting 32, 33
- audio output equipment, ports for connecting 32, 33
- Audio PlainTalk Microphone 46
- AudioVision monitors
  - adapter kit 76
  - connecting 8–9
- AV-equipped Power Macintosh
  - capabilities of 39
  - connecting video equipment 43–48
  - diagram of connections 33
  - monitor, problems with 76–77, 79–80
  - video equipment 39–42

## B

- backing up files and disks 54
- Balloon Help 28
- basic Macintosh skills 15–16
- battery, clock 61
- blinking question mark, at startup 12, 62
- bomb message 57, 59, 66
- brightness control 13, 61

## C

- cables
  - handling 105
  - keyboard 8–9, 68
  - monitor 61
  - mouse 8–9
  - with RCA-type plugs 42
  - used with AudioVision monitor 76
- camera, video 33
- capital letters, special keys for 121–122
- Caps Lock key 121
- cards
  - expansion 111
  - factory-installed 50, 111
- carpal tunnel syndrome 100
- case, cleaning 109
- CD-ROM drive
  - location of 31
  - starting up from 62–63, 81–82
- CD-ROM drives, adding 50
- CDs. *See* compact discs
- characters, special 122
- circuit boards, printed 111
- cleaning
  - case 109
  - keyboard 106
  - monitor 103, 109
  - mouse 109–110
  - spills 105–106
- Clear key 121
- clicking icons 29
- clock, troubleshooting 61
- closing Macintosh Guide window 27
- color wheel, problems viewing 80
- Command key 121
- commands
  - assigning to function keys 122
  - shortcuts for 29–30, 121–122
  - spoken 36–37
- compact discs 34
- composite video
  - format 33, 39
  - and RCA-type plug adapters 41–42

- computer
  - AV-equipped Power Macintosh, diagram for connecting equipment 33
  - non-AV Power Macintosh, diagram for connecting equipment 32
  - overheated 105
  - plugging in monitor power cord 5
  - removing cover 113–115
  - replacing computer cover 120
  - system at a glance 31
  - turning off 17
  - turning on 10–13
- computer equipment, handling 105–108. *See also* safety instructions
- computer power cord x
- computer system, at a glance 31
- connecting
  - audio equipment 34–38
  - an AudioVision monitor 7
  - equipment to AV-equipped Power Macintosh, diagram 33
  - equipment to non-AV Power Macintosh, diagram 32
  - keyboard 8–9
  - monitor power cord 4–5
  - monitors 3–7
  - mouse 8–9
  - a television 48
  - video equipment for input to computer 43–44
  - video equipment for output from computer 45–47
- connectors
  - handling 105
  - S-video 41
- Control key 122
- control panels, incompatible with system software 66
- copying files and disks 54
- cumulative trauma disorders 100
- customer support hotline 18

## D

- damage, to power plug 104
- DAV connector cards, location of
  - expansion slot for 112, 117
- deleting selected material 121–122
- desk accessories 53, 65–67
- desktop
  - hard disk icon doesn't appear 63
  - hiding and showing windows on 54
  - rebuilding 60, 64, 70
- Digital Audio and Video connector card. *See* DAV connector cards
- digital audio and video hardware, setup 112
- dimmed icons 53
- disk, damaged 85
- disk drive. *See* floppy disk drive; hard disk
- diskettes. *See* floppy disks
- Disk First Aid icon 87, 91
- Disk First Aid program 87, 89, 91, 94
- disk icons 62–63
- disk repair programs 87, 89
- Disk Tools* disk 62–63, 82, 86–87, 91, 94
- documents, DOS 70–71
- document stand 103
- DOS disks
  - formatting 65
  - troubleshooting 64
- DOS documents 70–71
- double-clicking icons 29
- DRAM Single Inline Memory Modules (SIMMs), for expanding memory 49

## E

- ejecting disks 63, 107–108
- electrical grounding 2, 61, 105
- electrical safety 104–105
- electricity, discharging static 114
- electromagnetic emissions 103
- Enter key 122
- equipment
  - cleaning 109–110
  - handling 105–108
  - location of ports for connecting 32, 33
  - for setup x
- erasing
  - floppy disks 89
  - hard disk 81
  - selected material 121–122
- error messages 57–58
- Escape key 122
- Ethernet port, non-AV
  - Power Macintosh 32
- expanding, the Macintosh
  - Guide window 27
- expansion cards
  - with DAV connector 112
  - factory-installed 50, 111
  - installing 3, 112–119
  - NuBus 50, 111
- expansion slots
  - location of 32, 33, 112
  - for NuBus card with DAV connector 112, 117
- extensions, incompatible 65–67, 73
- Extensions folder 65
- Extensions Manager control panel 65–66, 73
- eye fatigue 101, 103. *See also* health-related information

## F

- files
  - backing up 54
  - not found 72
- Finder
  - answering questions with Macintosh Guide 20, 27
  - shortcuts in 29–30
- Finder icon 53
- floating-point unit (FPU) 69
- floppy disk drive
  - adding 50
  - ejecting disk from 53, 107–108
  - inserting disk into 52
  - location of 31
- floppy disks
  - backing up 54
  - DOS 64
  - ejecting 63, 107–108
  - erasing 89
  - handling 107–108
  - initializing 64
  - inserting into drive 52
  - reading 64
  - repairing 62, 64, 87, 89
  - starting up from 63, 82
  - troubleshooting 64, 108
- formatting DOS disks 65.  
*See also* initializing
- FPU (floating-point unit) 69
- frozen system, troubleshooting 57, 59, 65
- function keys 122



## G

- GeoPort Adapter, location of ports for 32, 33
- glare, on screen 102–103
- grounded equipment 61, 105
- Guide menu. *See also* Balloon Help; Macintosh Guide window; Macintosh Shortcuts window and Balloon Help 28 and how to use the computer 15, 19–20 and learning shortcuts 29

## H

- hard disk
  - backing up files stored on 54
  - damaged 81
  - erasing 81, 89
  - initializing 81–84, 87
  - installing applications on 52
  - installing system software on 90–94, 97
  - repairing 84–85, 87, 89
  - starting up from 64
  - testing 86–87
  - troubleshooting 63, 84–97, 89
  - using space as additional memory 55
- hard disk drives
  - adding 50
  - location of internal 31
- hard disk icon, failure to appear 63
- health-related information. *See also* safety instructions and computer use 99–103
- help. *See* Balloon Help; Guide menu; Macintosh Guide window; troubleshooting
- Hide Balloons command (Guide menu) 28
- Hide Others command (Application menu) 54
- high-density monitor ports 6, 32, 33, 77
- Huh? button (Macintosh Guide window) 27

## I, J

- icons
  - Apple Desktop Bus (ADB) 8–9
  - Apple HD SC Setup 83, 86
  - bomb 57
  - clicking and double-clicking 29
  - dimmed 53
  - Disk First Aid 87, 91
  - disk with blinking question mark 12, 62
  - disk with X in center 63
  - Finder 53
  - hard disk 63
  - incorrect appearance of 64
  - microphone 34
  - opening 29
  - sad Macintosh 63
  - speaker 34
  - System Software Installer 92
- identifying objects on the screen 28
- Index button (Macintosh Guide window) 21, 23–24
- initializing
  - DOS disks 65
  - floppy disks 64
    - a hard disk 81, 83, 87
- input devices, location of ports for 32, 33
- insertion point, moving 122
- Install Disk 1* disk 82, 92, 95, 97
- Installer 92, 95
- installing
  - additional memory 49
  - applications 51–52
  - internal drives 50
  - printer drivers 74
  - system software 67, 90–94, 97
- installing expansion cards 111
- Inter•Poll network software 75
- interference 106
- internal drives, adding 50
- interrupt switch, location of 31

## K

- keyboard
  - connecting 8–9
  - handling spills on 106
  - location of ports for 32, 33
  - positioning 101–102
  - power key on 11
  - shortcuts 29–30
  - system diagram x
  - troubleshooting 68
  - and wrist pain 99–100, 103
- keyboard cable x, 8–9, 68
- keyboard port 8
- keys, special 121–122

## L

- LaserWriter printers, troubleshooting 74
- left-handed mouse use 8
- line input source, selecting 47
- Look For button (Macintosh Guide window) 21, 25–26

## M

- Macintosh basics 15–17
- Macintosh Guide window
  - choosing 20
  - Huh? button 27
  - Index button 21, 23–24
  - Look For button 21, 25–26
  - Memory topic 55
  - searching in 21–26
  - tips for using 27
  - Topics button 21–22
- Macintosh Shortcuts window 29–30
- Macintosh Tutorial, starting 15–16
- MacTerminal network software 75
- maintenance
  - cleaning equipment 109–110
  - handling equipment 105–108

- mathematical characters 122
- memory
  - clearing 59
  - expanding with DRAM SIMMs 49
  - hard disk space as 55
  - insufficient 69
  - special Macintosh requirements 55
- Memory control panel 69, 72
- menu commands. *See* commands
- microphone icon 34
- microphones
  - connecting 36–37, 47
  - ports for connecting 32, 33
  - setup for voice annotation 45–47
  - which to use 36, 46
- microprocessor, PowerPC ix
- modem, location of ports for 32, 33
- Modern Memory Manager 72
- moisture, avoiding 104, 106
- monitor x
  - AudioVision model 76
  - brightness control 13, 61, 106
  - cleaning 103, 109
  - connecting 3–7, 76
  - dark screen 61
  - glare on screen 102–103
  - interference on screen 106
  - location of ports for 32, 33
  - placement of 4
  - power cord x, 4
  - power-on light 13
  - preventing screen damage on 106
  - turning on automatically 10
  - types of 3
  - using a television 48
  - using second 77
- monitor cable x
  - connecting 6–7
- monitor cord, plugging into computer 5
- monitor ports 6–7, 32, 33
- monitor power cord x
  - connecting to monitor 4

- monitor power socket, location of 5, 32, 33
- mouse
  - cleaning 109–110
  - connecting to keyboard with a separate cable 8
  - setup equipment x
- mouse cable, plugging in 8
- mouse ports, for right- or left-hand use 8

## N

- network, location of ports for 32, 33
- networking software 75
- non-AV Power Macintosh, diagram of connections 33
- NuBus expansion cards
  - and DAV connector 112
  - inserting card 118–119
  - installation of 113
  - power requirements 113
  - removing computer cover 113–114
  - removing expansion card clip 116
  - removing plastic cover plate 117
  - replacing computer cover 120
  - and static electricity 114

## O

- opening
  - applications 55, 69–70, 72
  - DOS documents 71
  - icons 29
- Option key 122
- overheated computer 105

## P

- pain. *See* health-related information
- PC Exchange control panel 70–71
- performance, decreasing 73
- PlainTalk software 51
- plugging in the computer 1–3
- pointer
  - frozen 57, 65–66
  - moving 15
- ports
  - Apple Desktop Bus (ADB) 9, 68
  - diagrams 32, 33
  - monitor 6–7
  - on AV-equipped Power Macintosh computer 33
  - on non-AV Power Macintosh computer 32
  - S-video 40, 44, 47–48, 77
  - S-video and problems with high-density monitor 77
- posture, and equipment 100–102
- power cord
  - computer x
  - frayed or damaged 104
  - monitor 5
  - properly connected 61
  - when to disconnect 104
- power cord socket, recessed 2
- Power key 17, 59, 122
  - on keyboard 11
- Power Macintosh (AV-equipped), and digital audio and video capabilities 112
- Power Macintosh equipment for setup x
- Power Macintosh “native” applications, using 55
- Power Macintosh ports
  - diagram of AV-equipped 33
  - diagram of non-AV 32
- Power Macintosh software 69.  
*See also* applications

- power-on light 13, 31
- PowerPC microprocessor ix
- power plug, damaged 104
- power problems, troubleshooting 61
- power socket 32, 33
- power strip 2, 13
- power supply, computer 108
- power switch 13
  - location of 10, 32, 33
  - and losing work 17
- PowerTalk program, built-in
  - mail services 51
- printer drivers, obtaining 74
- printers
  - location of ports for 32, 33
  - troubleshooting 74
- Printing System Folder, contents of 58
- problems. *See* troubleshooting programs. *See* applications

## Q

- question mark disk icon 12, 62
- questions. *See* balloon help; Macintosh Guide window; troubleshooting
- QuickDraw GX printing program 51
- quitting applications, when system freezes 65

## R

- RAM, expanding 49
- random-access memory (RAM), expanding 49
- RCA-type plug adapters 41–42
- rebuilding desktop 60, 64, 70
- recording
  - computer images on VCR or video equipment 42
  - on videotape 45
  - sound presentations, connecting equipment for 45–47
  - videotape contents on the computer 43–44

- Reduced Instruction Set Computing (RISC) technology ix
- reinstalling system software 67, 90
- repairing
  - floppy disks 62, 64, 87, 89
  - hard disk 84–85, 87, 89
  - System Folder contents 93–94
- repair service 58
- repetitive stress injuries 99–100
- reset switch
  - clearing computer memory 59
  - location of 31
- Restart command (Special menu) 59
- restarting the Power Macintosh 59, 62, 66
- Return key 122
- RISC technology ix

## S

- sad Macintosh icon 63
- safety instructions 104
- screen
  - dark 61
  - frozen 57, 65
  - glare on 102–103
  - identifying objects on 28
  - image “burn in” 106
  - interference on 106
  - position of 102
  - troubleshooting 62–63, 85
- screen objects, identifying 28
- SCSI equipment, location of
  - ports for 32, 33
- SCSI ID numbers 62, 63, 85
- SCSI ports, location of 32, 33
- second monitor port 6, 32, 33, 77
- service and support 18, 58
- setup, equipment x
- shared libraries 55, 72
- Shift key 122
- Shortcuts (Guide menu) 29
- shortcuts, keyboard and mouse 29–30
- Show All command (Application menu) 54

- Show Balloons command
  - (Guide menu) 29
- Shrinking Macintosh Guide window 27
- Shut Down command (Special menu) 17
- slots, for NuBus cards 112
- Small Computer System Interface.
  - See* SCSI
- software. *See* applications; networking software; system software
- sound. *See also* audio equipment; microphone; speakers
  - listening or reproducing 34
- sound and video capabilities, connecting equipment for 45–48
- sound input and output ports 34
- sound ports
  - for audio-video input 44
  - for audio-video output 47
  - icons 34
  - location of 32, 33
  - and stereo miniplug 35
- speaker icon 34
- speakers 34, 38
- special keys 121–122
- Special menu 59
- speech-recognition technology 36–37
- spills 104–106
- standard monitors 3
- starting up
  - from CD-ROM disk 62–63, 81–82
  - from floppy disk 63, 82
  - from hard disk 64
  - troubleshooting 62–63
- startup disk
  - CD-ROM disc 62–63, 81–82
  - floppy disk 63, 82
  - hard disk 64
  - purpose of 90
  - rebuilding desktop 60
  - troubleshooting 62, 65
- StyleWriter printers, troubleshooting 74
- support and service 18, 58
- S-video equipment, ports for
  - connecting 33
- S-Video format 39
- S-video ports
  - connecting cables to 42, 44, 47
  - location of 33
  - purpose of 40
- system extensions, compatibility 65, 67, 73
- System Folder
  - Extensions folder 65
  - files in 90
  - printing contents of 58
  - repairing contents of 93–94
  - special software items 73
  - when not to open 70
- system software
  - clean installation 93–96
  - compatibility 65, 67, 72–73
  - custom installation 97
  - normal installation 91–93
  - printer drivers in 74
  - reinstalling 67, 90
  - replacing special software 96
  - troubleshooting 62–63, 65, 90, 93
- System Software Installer icon 92
- system startup. *See* starting up; startup disk

## T, U

Tab key 122  
tape recorder, attaching 35  
television  
    diagram for video output from  
        computer 47  
        switching from 77  
        troubleshooting 79  
        using as a monitor 48  
testing the hard disk 86–87  
text, failure to appear on screen 67  
Topics button  
    in Macintosh Guide window 21–22  
    in Macintosh Shortcuts window 30  
trackball, location of ports for 32, 33  
troubleshooting. *See also* Guide menu  
    applications 65, 69–70, 72  
    bomb message 57, 59, 66  
    clock 61  
    damaged disks 85, 87–88  
    decrease in computer performance 73  
    diagnosing problems 58  
    DOS disks 64  
    DOS documents 70–71  
    ejecting disks 108  
    error messages 57  
    file can't be found 72  
    and finding answers 18, 57  
    floppy disks 64, 108  
    frozen system 57, 59, 65  
    hard disk 63, 81, 84–88  
    icons don't appear correctly 64  
    installing system software 90–94, 97  
    keyboard 68  
    memory 55, 69  
    monitor 61, 76–77, 79–80, 106  
    mouse 67  
    “native” applications 55  
    networking software 75  
    old programs 56  
    pointer 66  
    power 59, 61

printer problems 74  
rebuilding desktop 60  
restarting Macintosh to solve  
    problems 59, 62  
sad Macintosh icon 63  
screen 57, 61, 64, 102–103, 106  
SCSI devices 62–63, 85  
starting applications 69  
startup disk 65  
System Folder 93  
system software 62–63, 65, 90, 93  
television 77, 79  
turning on the computer 13  
typing produces nothing 67  
turning off the computer 17, 122  
turning on the computer 10–12, 122  
    problems 13  
typing. *See also* keyboard; keys; text  
    produces nothing 67  
    using special keys 121–122  
    and wrist problems and fatigue  
        100, 103

## V

VCR  
    cables for connecting to Macintosh 43  
    diagram for video input to  
        computer 44  
    diagram for video output from  
        computer 47  
    ports for connecting 33  
    viewing or recording computer  
        images on 39, 42  
ventilation, of equipment 4, 105–106  
video  
    capturing frames 43  
    connecting equipment for input of  
        40, 42–44  
    connecting equipment for output of  
        40, 45–47  
    viewing on computer display  
        39, 42–43  
    viewing on television 48

- video and audio, setup for 45–47
- video and sound connections,
  - diagram 44
- video cables, with RCA plugs 43, 46
- video camera, ports for connecting 33
- videocassette recorder. *See* VCR
- video equipment
  - adapters for 41, 43
  - cables 43
  - capabilities of 39
  - connecting for input to computer 39, 43–44
  - connecting for output from computer 39, 45–47
  - using a television as a monitor 48
- video formats 39, 41
- Video Monitor program 51
- video RAM (VRAM) 49
- viewing VCR or video images, on
  - monitor 42
- virtual memory 55, 69
- VRAM 49

## W, X

- windows, hiding and showing on
  - desktop 54
- work area, arranging 100–102
- wrist problems 99–100, 103

## Y, Z

- Y-shaped adapters 44, 46



Apple Computer, Inc.  
1 Infinite Loop  
Cupertino, California 95014-2084  
408.996.1010  
TLX 171-576

030-5815-A  
Printed in U.S.A.