



# User Guide

Personal Computer

**VGN-A700 Series/VGN-FS600 Series**

## Contents

Before Use .....	6
Documentation .....	6
Ergonomic Considerations .....	8
Getting Started .....	10
Locating Controls and Ports .....	11
About the Indicator Lights .....	24
Connecting a Power Source .....	25
Using the Battery Pack.....	26
Shutting Down Your Computer Safely .....	33
Using Your VAIO Computer .....	34
Using the Keyboard.....	35
Using the Touch Pad.....	37
Using Special-function Buttons .....	38
Using the Optical Disc Drive .....	40
Using the TV Function (on Selected Models Only) .....	47
Using PC Cards .....	48
Using the Memory Stick Media .....	52
Using the Internet.....	56
Using Wireless LAN (WLAN) .....	57

Using Peripheral Devices .....	65
Connecting a Port Replicator .....	66
Using the Mouse (on Selected Models Only) .....	87
Connecting External Speakers .....	91
Using the Remote Commander .....	97
Connecting an External Display .....	100
Selecting Display Modes .....	108
Using the Multiple Monitors Function .....	111
Connecting an External Microphone .....	115
Connecting a Universal Serial Bus (USB) Device .....	116
Connecting a Printer .....	119
Connecting an i.LINK Device .....	121
Connecting to a Network (LAN) .....	123
Customizing Your VAIO Computer .....	125
Setting the Password .....	126
Setting Up Your Computer with VAIO Control Center .....	131
Using the Power Saving Modes .....	133
Managing Power with VAIO Power Management .....	138
Upgrading Your VAIO Computer .....	142
Adding and Removing Memory .....	143

Precautions .....	157
On Handling the LCD Screen.....	158
On Using the Power Source.....	159
On Handling Your Computer.....	160
On Handling Floppy Disks.....	162
On Handling Discs .....	163
On Using the Battery Pack.....	164
On Using Headphones.....	165
On Handling Memory Stick Media.....	165
On Handling the Hard Disk .....	166
Troubleshooting .....	167
Computer .....	168
System Security .....	178
Battery.....	180
Internet.....	182
Networking .....	184
CDs and DVDs.....	186
Display .....	189
Printing.....	192
Microphone .....	193
Mouse .....	194
Speakers.....	195
Touch Pad.....	196
Keyboard.....	198

Floppy Disks.....	199
PC Cards.....	200
Audio/Video.....	201
Memory Stick Media.....	202
Peripherals .....	203
Support Options .....	204
Sony Support Information .....	204
Program Support Information.....	207

## *Before Use*

Congratulations on your purchase of this Sony VAIO® computer, and welcome to the on-screen User Guide. Sony has combined leading-edge technology in audio, video, computing, and communications to provide state-of-the-art personal computing.

### *Documentation*

Your Documentation contains printed information and user guides to read on your computer.

#### *Printed Documentation*

- ❑ **Welcome mat** — Contains overview of connections, setting up information, etc.
- ❑ **Safety information** — Contains safety guidelines and owner information.

## Non-printed Documentation

- ❑ **User Guide (this manual)** — Contains features of your computer. It also includes information about the software programs included with your computer, as well as information on solving common problems.
- ❑ **Specifications** — The online **Specifications** sheet describes the hardware and software configuration of your VAIO computer.

To view the online **Specifications** sheet:

- 1 Connect to the Internet.
- 2 Go to the Sony online support Web site at <http://www.sony.com/pcsupport> for customers in USA and Canada, or at <http://kdb.sony-latin.com/> for customers in Latin American countries or areas.

- ❑ **VAIO Recovery Options Guide** — Provides information about restoring individual software programs, software drivers, and drive partition(s) or your entire hard disk drive to the original factory installed settings.

To access this online software information:

- 1 Click **Start**, point to **All Programs**, and click **VAIO Control Center**.
- 2 Click the **Categories** tab and then the **Documentation** folder.
- 3 Click **Recovery Guide**.

## Ergonomic Considerations

You will be using your computer as a portable device in a variety of environments. Whenever possible, you should attempt to take account of the following ergonomic considerations to both stationary and portable environments:

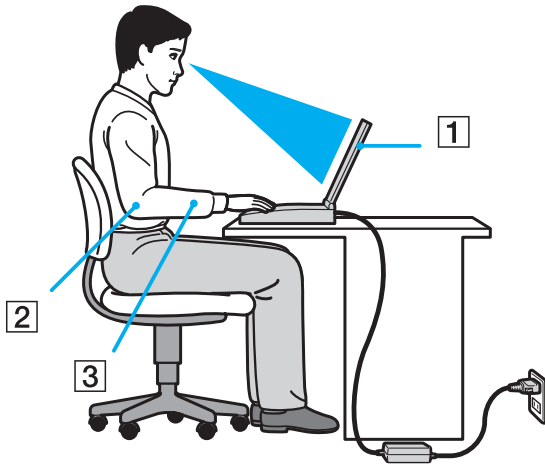

- ❑ **Position of your computer** – Place the computer directly in front of you (1). Keep your forearms horizontal (2), with your wrists in a neutral, comfortable position (3) while using the keyboard, touch pad, or external mouse. Let your upper arms hang naturally at your sides. Have breaks during sessions with your computer. Excessive use of the computer may strain muscles or tendons.
- ❑ **Furniture and posture** – Sit in a chair with good back support. Adjust the level of the chair so your feet are flat on the floor. A footrest may make you more comfortable. Sit in a relaxed, upright posture and avoid slouching forward or leaning far backwards.



- ❑ **Viewing angle of the computer's display** – Use the display's tilting feature to find the best position. You can reduce eye strain and muscle fatigue by adjusting the tilt of the display to the proper position. Adjust the brightness setting of the display as well.
- ❑ **Lighting** – Choose a location where windows and lights do not create glare and reflection on the display. Use indirect lighting to avoid bright spots on the display. You can also purchase accessories for your display that help reduce glare. Proper lighting adds to your comfort and work effectiveness.
- ❑ **Positioning an external display** – When using an external display, set the display at a comfortable viewing distance. Make sure the display screen is at eye level or slightly lower when you are sitting in front of the monitor.

## Getting Started

This section describes how to get started with using your VAIO computer.

- ❑ **Locating Controls and Ports** ([page 11](#))
- ❑ **About the Indicator Lights** ([page 24](#))
- ❑ **Connecting a Power Source** ([page 25](#))
- ❑ **Using the Battery Pack** ([page 26](#))
- ❑ **Shutting Down Your Computer Safely** ([page 33](#))

## *Locating Controls and Ports*

Take a moment to identify the controls and ports shown on the following pages.

! The following illustrations may appear different from your model, depending on the country or area of your residency.

## VGN-A700 Series models

## Front

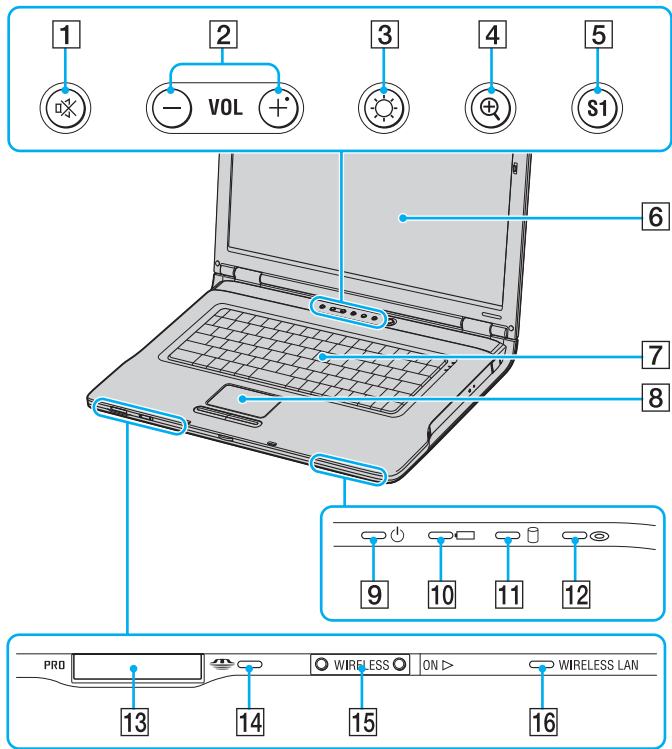

- 1 Mute button/indicator (page 38)
- 2 Volume buttons (page 38)
- 3 Brightness button (page 38)
- 4 Magnify screen button (page 38)
- 5 S1 button (page 38)
- 6 LCD screen (page 158)
- 7 Keyboard (page 35)
- 8 Touch pad (page 37)
- 9 Power indicator (page 24)
- 10 Battery indicator (page 24)
- 11 Hard disk drive indicator (page 24)
- 12 Optical disc drive indicator (page 24)
- 13 Memory Stick media slot\* (page 52)
- 14 Memory Stick media indicator (page 24)
- 15 WIRELESS switch (page 57)
- 16 WIRELESS LAN indicator (page 24)

\* Your computer supports Memory Stick Duo media and Memory Stick Pro high speed and high capacity capabilities.

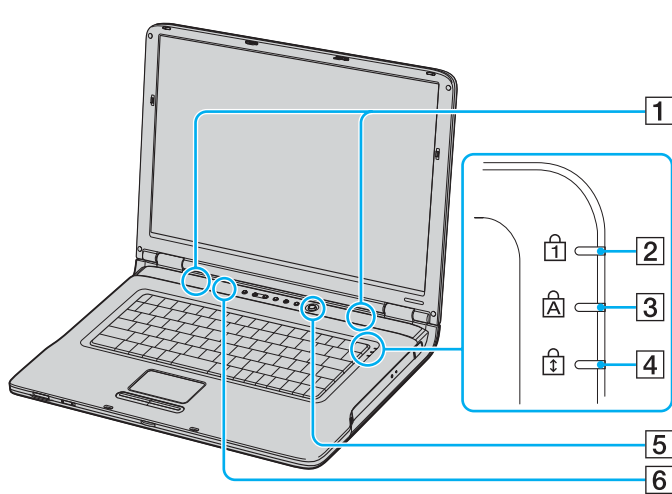

- 1 Speakers
- 2 Num lock indicator ([page 24](#))
- 3 Caps lock indicator ([page 24](#))
- 4 Scroll lock indicator ([page 24](#))
- 5 Power button
- 6 Auto luminance sensor ([page 38](#))

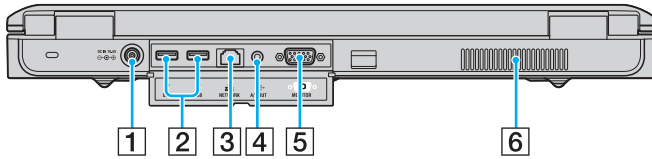
*Back*

- 1 DC In port ([page 25](#))
- 2 Hi-Speed USB (USB 2.0) ports\* ([page 116](#))
- 3 Network (Ethernet) port ([page 123](#))
- 4 AV Out jack ([page 104](#))
- 5 Monitor (VGA) port ([page 100](#))
- 6 Air vent

\* Supports high-/full-/low- speeds.

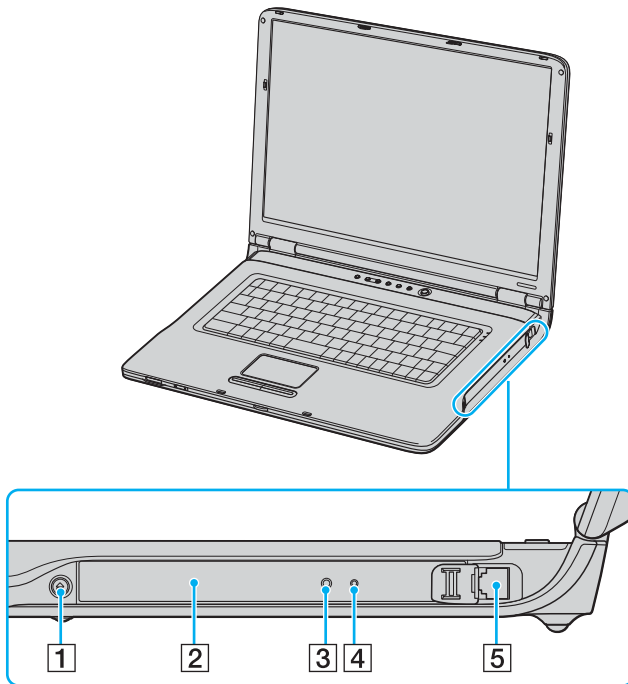
*Right*

- 1 Drive eject button ([page 40](#))
- 2 Optical disc drive ([page 40](#))
- 3 Drive eject button ([page 40](#))
- 4 Manual eject hole ([page 186](#))
- 5 Modem port ([page 56](#))



You can use either drive eject button to eject the optical disc drive tray. The drive eject button located next to the optical disc drive functions only with the Microsoft Windows operating system.

## Left

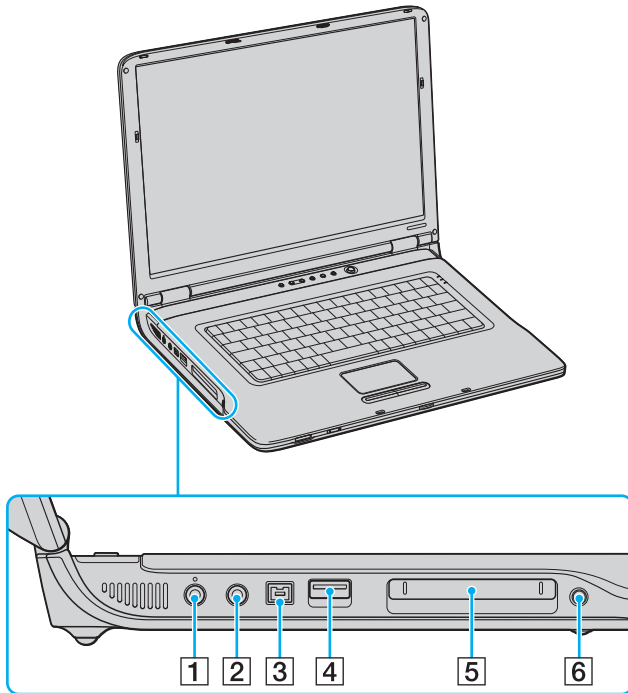

- 1 Microphone jack ([page 115](#))
- 2 Headphones jack ([page 91](#))
- 3 i.LINK® (IEEE1394) S400 port ([page 121](#))
- 4 Hi-Speed USB (USB 2.0) port\* ([page 116](#))
- 5 PC Card slot ([page 48](#))
- 6 PC Card eject button ([page 48](#))

\* Supports high-/full-/low- speeds.



## Bottom

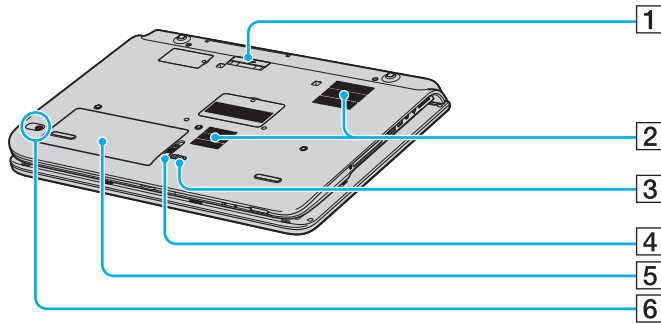

- 1 AV station/port replicator connector ([page 66](#))
- 2 Air vents
- 3 LOCK/UNLOCK switch ([page 26](#))
- 4 RELEASE switch ([page 26](#))
- 5 Battery bay ([page 26](#))
- 6 CONNECT button\* ([page 87](#))

\* On selected models with wireless mouse functionality.

## VGN-FS600 Series models

### Front

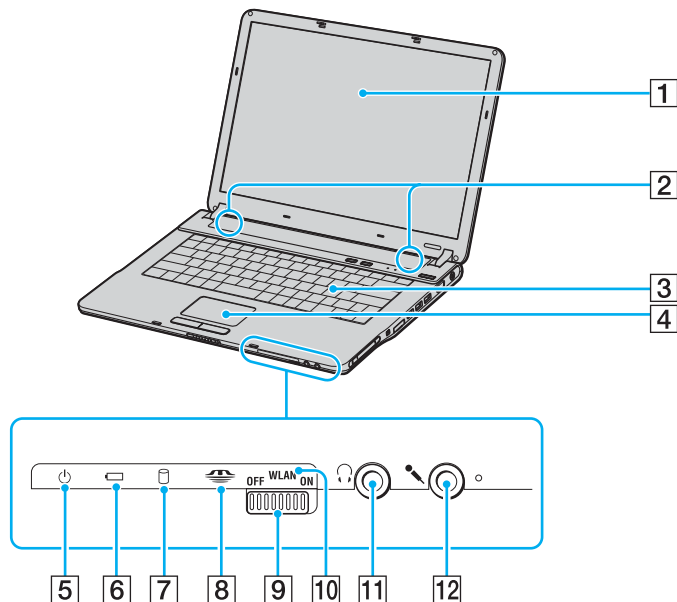

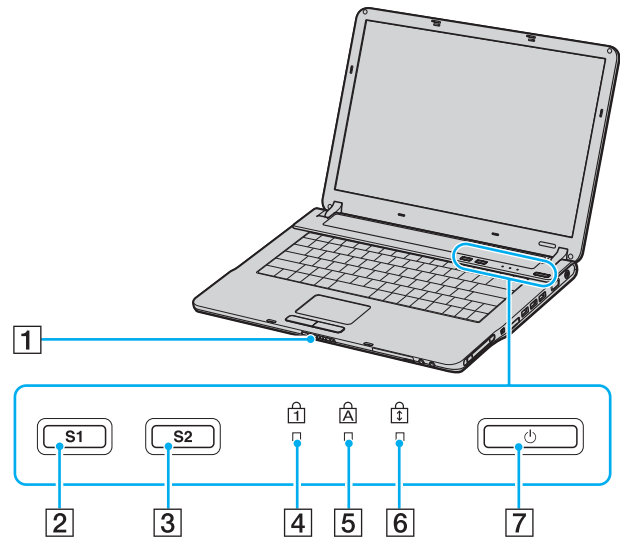

- 1 Display lock latch
- 2 S1 button ([page 38](#))
- 3 S2 button ([page 38](#))
- 4 Num lock indicator ([page 24](#))
- 5 Caps lock indicator ([page 24](#))
- 6 Scroll lock indicator ([page 24](#))
- 7 Power button

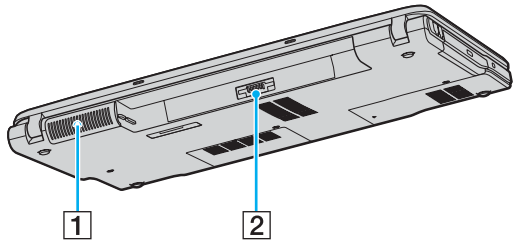
*Back*

- 1 Air vent
- 2 Battery connector ([page 26](#))

## Right

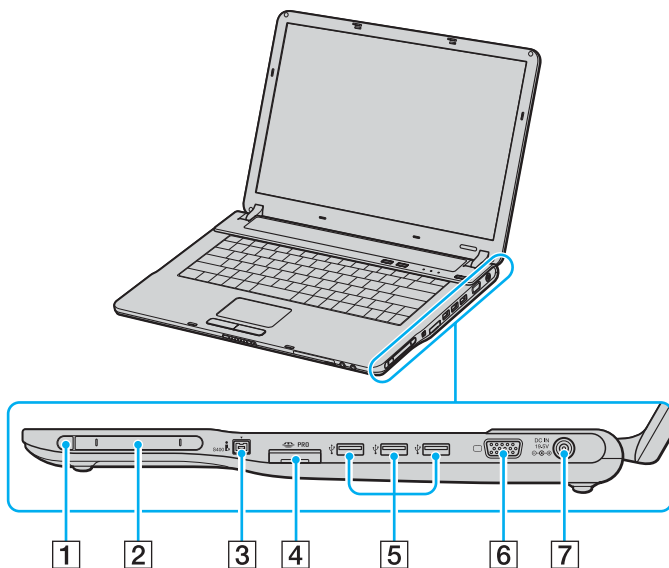

- 1 PC Card eject button ([page 48](#))
- 2 PC Card slot ([page 48](#))
- 3 i.LINK® (IEEE1394) S400 port ([page 121](#))
- 4 Memory Stick media slot\*<sup>1</sup> ([page 52](#))
- 5 Hi-Speed USB (USB 2.0) ports\*<sup>2</sup> ([page 116](#))
- 6 Monitor (VGA) port ([page 100](#))
- 7 DC In port ([page 25](#))

\*<sup>1</sup> Your computer supports Memory Stick Duo media and Memory Stick PRO high speed and high capacity capabilities.

\*<sup>2</sup> Supports high-/full-/low- speeds.

## Left

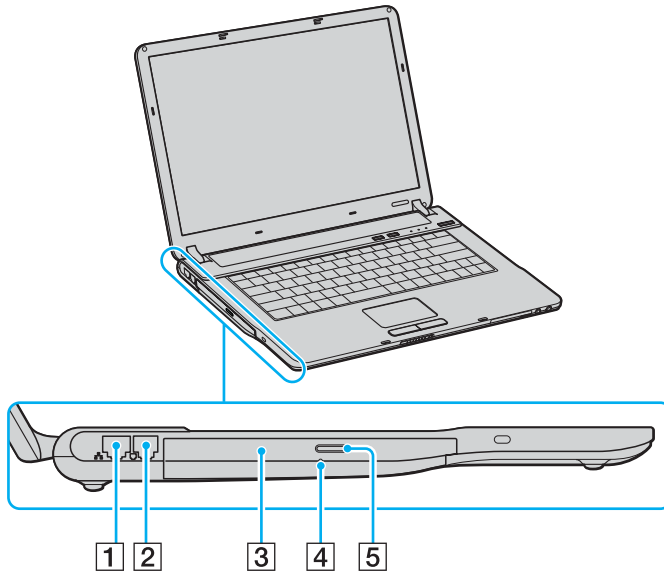



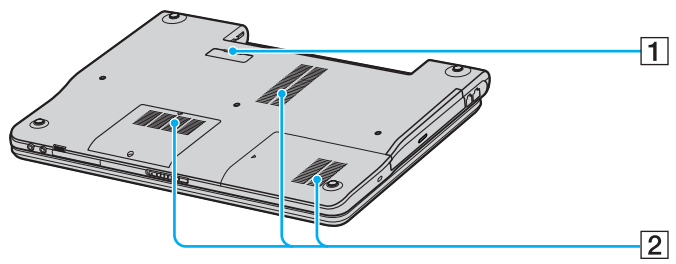







- 1 Network (Ethernet) port ([page 123](#))
- 2 Modem port ([page 56](#))
- 3 Optical disc drive ([page 40](#))
- 4 Manual eject hole ([page 186](#))
- 5 Drive eject button ([page 40](#))

*Bottom*

- 1** Port replicator connector ([page 66](#))
- 2** Air vents

## About the Indicator Lights

Indicator	Functions
Power 	Illuminates when the power of the computer is on, blinks in Standby mode, and turns off when the computer is in <b>Hibernate</b> mode or off.
Battery 	Illuminates when the computer is using battery power, blinks when the battery is running out of power, and double-blinks when the battery is charging.
Memory Stick Pro/Duo 	Illuminates when data is read from or written to the Memory Stick media. (Do not enter <b>Standby</b> mode or turn off the computer when this indicator is on.) When the indicator is off, the Memory Stick media is not being used.
Optical disc drive  *	Illuminates when data is read from or written to the optical disc. When the indicator is off, the optical disc is not being used.
Mute  *	Illuminates when the volume is turned off.
Brightness  *	Illuminates when the screen is on maximum brightness intensity.
Hard disk 	Illuminates when data is read from or written to the hard disk. Do not enter <b>Standby</b> mode or turn off the computer when this indicator is on.
Num Lock 	Press the <b>Num LK</b> key to activate the numeric keypad. Press it a second time to deactivate the numeric keypad. The numeric keypad is not active when the indicator is off.
Caps Lock 	Press the <b>Caps Lock</b> key to type letters in uppercase. Letters appear in lowercase if you press the <b>Shift</b> key while the indicator is on. Press the key a second time to turn off the indicator. Normal typing resumes when the <b>Caps Lock</b> indicator is off.
Scroll Lock 	Press the <b>Scroll Lock</b> key to change how you scroll the display. Normal scrolling resumes when the <b>Scroll Lock</b> indicator is off. The <b>Scroll Lock</b> key functions differently depending on the program you are using and does not work with all programs.
WIRELESS LAN	Illuminates when the wireless LAN function is running.

\* On selected models only.



## Connecting a Power Source

You can use either an AC adapter or a rechargeable battery pack as a power source.

### Using the AC Adapter

To use the AC adapter

- 1 Plug one end of the power cord (1) into the AC adapter.
- 2 Plug the other end of the power cord into an AC outlet (2).
- 3 Plug the cable attached to the AC adapter (3) into the DC In port (4) on the computer.

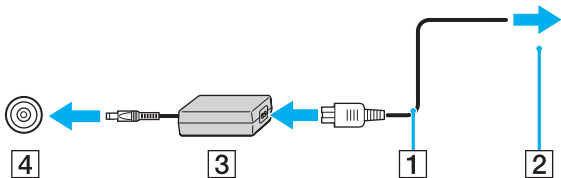

! The shape of the DC In plug varies depending on the AC adapter.



Use your computer only with the supplied AC adapter.

To disconnect your computer completely from AC power, unplug the AC adapter.

Make sure that the AC outlet is easily accessible.

If you do not use the AC adapter for a long period of time, put your computer into **Hibernate** mode. See **Using Hibernate Mode (page 136)**. This power saving mode saves you the time of shutting down in the normal way.

## Using the Battery Pack

The battery pack supplied with your computer is not fully charged at the time of purchase.

### Installing the Battery Pack

To install the battery pack

#### VGN-A700 Series models

- 1 Turn off your computer and close the LCD screen lid.
- 2 Slide the **LOCK/UNLOCK** switch (1) on the bottom of the computer to the **UNLOCK** position.
- 3 Slide the **RELEASE** switch (2) on the bottom of the computer to the **RELEASE** position.

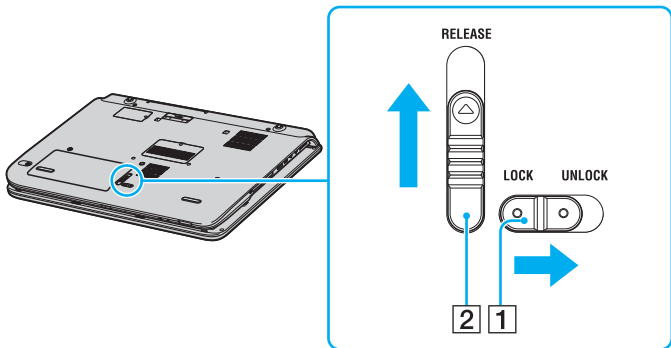

- 4 Remove the battery compartment cover.

- 5 Slide the battery in the battery compartment cover.

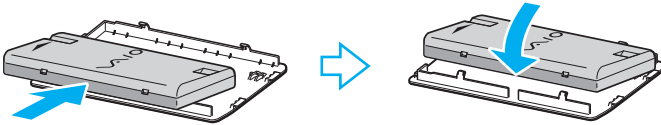

- 6 Turn over the battery attached to the battery compartment cover.
- 7 Insert the tab on the battery compartment cover into the notch, and push the battery down into the compartment until it clicks into place.
- 8 Slide the **LOCK/UNLOCK** switch to the **LOCK** position to secure the battery on the computer.

## VGN-FS600 Series models

- 1 Turn off your computer and close the LCD screen lid.
- 2 Slide the lock switch (1) to the **UNLOCK** position.

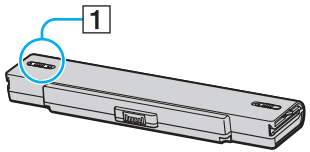

- 3 Slide the battery into the battery compartment until it clicks into place.

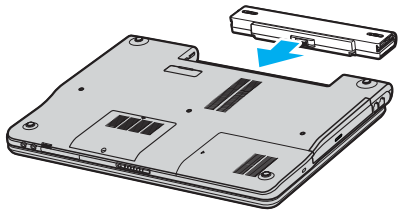

- 4 Slide the lock switch (1) to the **LOCK** position to secure the battery on the computer.



When the computer is directly connected to AC power and has a battery pack installed, it uses power from the AC outlet.



This computer is designed to operate only with genuine Sony batteries.

## Charging the Battery Pack

The battery pack supplied with your computer is not fully charged at the time of purchase.

To charge the battery pack

- 1 Install the battery pack.
- 2 Connect the AC adapter to the computer.  
The computer automatically charges the battery (the battery indicator light flashes in a double blink pattern as the battery charges).

<i>Battery indicator light status</i>	<i>Meaning</i>
On	The computer is using battery power.
Blinks	The battery is running out of power.
Double blinks	The battery is charging.
Off	The computer is using AC power.



When the battery is running out of power, both the battery and power indicator lights blink.

Keep the battery pack in the computer while it is directly connected to AC power. The battery pack continues to charge while you are using the computer.

If the battery level falls below 10%, you should either attach the AC adapter to recharge the battery or shut down your computer and install a fully charged battery.

The battery pack supplied with your computer is a lithium ion battery and can be recharged any time. Charging a partially discharged battery does not affect battery life.

The battery indicator light is on while you use the battery pack as a power source. When the battery life is nearly depleted, both the battery and power indicator lights start flashing.

For some software applications and some peripheral devices, your computer may not enter **Hibernate** mode even when battery life is low. To avoid loss of data when using battery power, you should save your data frequently and manually activate a power management mode, such as **Standby** or **Hibernate**. If the battery wears out when your computer enters **Standby** mode, you will lose any unsaved data. Going back to the previous work state is impossible. To avoid loss of data, you should save your data frequently.

When the computer is directly connected to AC power and has a battery pack installed, it uses power from the AC outlet.

## Removing the Battery Pack

To remove the battery pack

### VGN-A700 Series models

- 1 Turn off your computer and close the LCD screen lid.
- 2 Slide the **LOCK/UNLOCK** switch (1) on the bottom of the computer to the **UNLOCK** position.
- 3 Slide the **RELEASE** switch (2) on the bottom of the computer to the **RELEASE** position.  
The right edge of the battery compartment cover is pushed up.

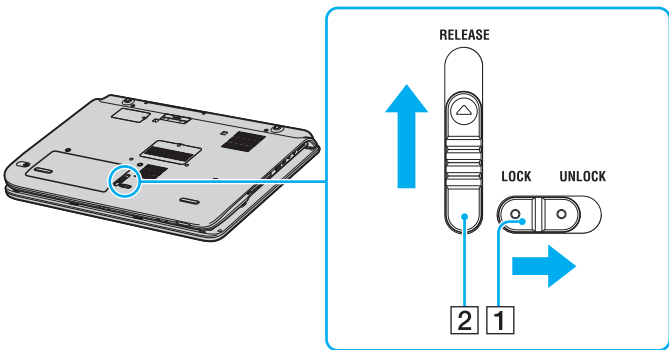

- 4 Raise the edge to remove the battery compartment cover.
- 5 Open the tabs on the battery compartment cover to release the battery and remove it from the battery compartment cover.
- 6 Insert the two tabs on the battery compartment cover diagonally into the notches and push the cover into the compartment until it clicks into place.

## VGN-FS600 Series models

- 1 Turn off your computer and close the LCD screen lid.
- 2 Slide the lock switch (1) to the **UNLOCK** position.

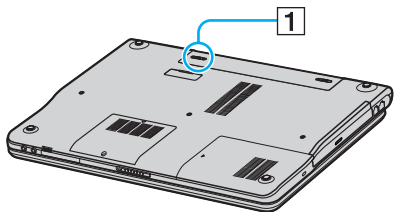

- 3 Slide and hold the release latch (2) and slide the battery away from the computer.

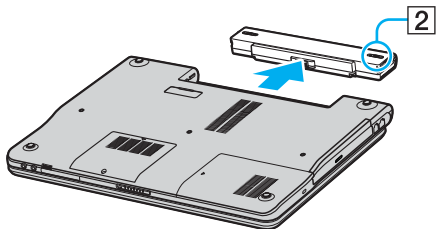

You may lose data if you remove the battery pack while the computer is on and not connected to the AC adapter or if you remove the battery while the computer is in **Standby** mode.



## *Shutting Down Your Computer Safely*

To avoid losing unsaved data, be sure to shut down your computer properly, as described below.

To shut down your computer

- 1 Turn off any peripherals connected to your computer.
- 2 Click **Start** and then **Turn Off Computer**.  
The **Turn off computer** window appears.
- 3 Click **Turn Off**.
- 4 Respond to any prompts warning you to save documents or to consider other users and wait for your computer to turn off automatically.  
The power indicator light turns off.

## *Using Your VAIO Computer*















This section describes how to get the most out of using your VAIO computer.

- ❑ **Using the Keyboard** ([page 35](#))
- ❑ **Using the Touch Pad** ([page 37](#))
- ❑ **Using Special-function Buttons** ([page 38](#))
- ❑ **Using the Optical Disc Drive** ([page 40](#))
- ❑ **Using the TV Function (on Selected Models Only)** ([page 47](#))
- ❑ **Using PC Cards** ([page 48](#))
- ❑ **Using the Memory Stick Media** ([page 52](#))
- ❑ **Using the Internet** ([page 56](#))
- ❑ **Using Wireless LAN (WLAN)** ([page 57](#))

## *Using the Keyboard*

Your keyboard is very similar to a desktop computer keyboard, but has additional keys that perform model-specific tasks. For more information on the standard keys, see Windows **Help and Support Center** and click on the **Customizing your computer** link.

## Combinations and Functions with the Fn Key

Combinations/Feature	Functions
<b>Fn +  (F2):</b> speaker switch*	Turns on and off the built-in speakers and the headphones.
<b>Fn +  (F3/F4):</b> speaker volume*	Adjusts the built-in speaker volume. To increase volume, press <b>Fn+F4</b> and then  or  , or keep pressing <b>Fn+F4</b> . To decrease volume, press <b>Fn+F3</b> and then  or  , or keep pressing <b>Fn+F3</b> .
<b>Fn +  (F5/F6):</b> brightness control	Adjusts the brightness of the LCD. To increase lightness intensity, press <b>Fn+F6</b> and then  or  , or keep pressing <b>Fn+F6</b> . To decrease lightness intensity, press <b>Fn+F5</b> and then  or  , or keep pressing <b>Fn+F5</b> .
<b>Fn +  (F7):</b> switch to the external display	Toggles between the LCD, external device (e.g. monitor) and both LCD and external device.
<b>Fn +  (F10):</b> zoom*	Changes the screen resolution to magnify/restore the screen view.  The magnified view is not as clear as the standard view, as it is implemented by applying a lower resolution to the LCD screen with a higher resolution. This key combination is disabled during video playback. Make sure to quit such software before pressing the key combination. This key combination may not work with graphic images as it magnifies the screen view by changing the resolution. The location and size of software windows may change when the screen view is magnified or the standard view is restored because pressing this key combination changes the resolution. When the LCD screen view is magnified, switching the view to the external display disables the function and restores the standard view.
<b>Fn +  (F12):</b> Hibernate	Provides for the lowest level of power consumption. When you execute this command, the states of the system and the peripheral devices are written to the hard disk and the system power is turned off. To return the system to its original state, use the power switch to turn on the power. For details on power management, see the section <b>Using the Power Saving Modes</b> ( <a href="#">page 133</a> ).

\* On selected models only.



Some functions are not available until Windows is launched.

## Using the Touch Pad

The keyboard contains a cursor-pointing device, your touch pad (1). You can point to, select, drag, and scroll objects on the screen using the touch pad.

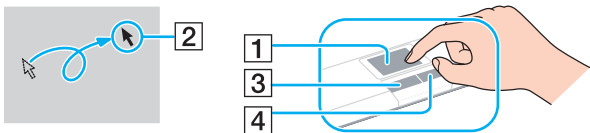





<i>Action</i>	<i>Description</i>
Point	Slide one finger on the touch pad to place the pointer (2) on an item or object.
Click	Press the left button (3) once.
Double-click	Press the left button twice.
Right-click	Press the right button (4) once. In many applications, this action displays a shortcut menu.
Drag	Slide one finger while pressing the left button.
Scroll	Move your finger along the right edge of the touch pad to scroll vertically. Move your finger along the bottom to scroll horizontally (the scroll function is available only with applications that support a touch pad scroll feature).

## Using Special-function Buttons

Your VAIO computer is provided with special buttons to help you use specific functions of the computer.

### VGN-A700 Series models

<i>Special-function button</i>	<i>Functions</i>
<b>Mute button</b> 	Turns the volume on and off. The LED turns on when the volume is turned off.
<b>Volume buttons</b>  (Volume down and Volume up)	Increase and decrease the volume.
<b>Brightness button</b> 	<p>You can increase and decrease the brightness intensity. When the screen is on maximum brightness intensity, the LED turns on.</p> <p><b>Auto luminance sensor:</b> By default, the light sensor senses the brightness from outside and the display brightness is adjusted accordingly. This setting applies only when the display is set to automatic brightness mode. Press the brightness button to set the display to automatic brightness mode. You can adjust the general level of the automatic brightness mode in <b>Setting Up Your Computer with VAIO Control Center (page 131)</b>.</p>
<b>Magnify screen button (Zoom)</b>  :	Changes the image resolution in all applications, except in those that use the DVD player.
<b>S1 button</b> 	The <b>S1</b> button, by default, launches the <b>VAIO Zone</b> software. You also can link to this shortcut button another action that you execute often. See <b>Setting Up Your Computer with VAIO Control Center (page 131)</b> .



When an external display is connected to your computer, the **Magnify screen** button is disabled.

The magnified view is not as clear as the standard view.



Pressing the **Magnify screen** button changes the resolution, thus may cause a defect to any running software that does not support change in resolution. Make sure to quit such software before pressing the **Magnify screen** button.

The **Magnify screen** button may not work with graphic images because it magnifies the screen view by changing the resolution.

The location and size of software windows may change when the screen view is magnified or when the standard view is restored.

When the LCD screen view is magnified, switching the view to the external display disables the function and restores the standard view.

## VGN-FS600 Series models

<i>Special-function button</i>	<i>Functions</i>
<b>S1/S2</b> buttons  	By default, the <b>S1</b> button turns the volume on and off and the <b>S2</b> button toggles the display output between the LCD and external device. You can also link to these shortcut buttons another action that you execute often. See <b>Setting Up Your Computer with VAIO Control Center</b> ( <a href="#">page 131</a> ).

## Using the Optical Disc Drive

Your computer is equipped with an optical disc drive.

To insert a disc

- 1 Turn on the computer.
- 2 Press the drive eject button (1) to open the drive.  
The tray slides out.
- 3 Place a disc in the middle of the tray with the label side facing up until the disc clicks into place.

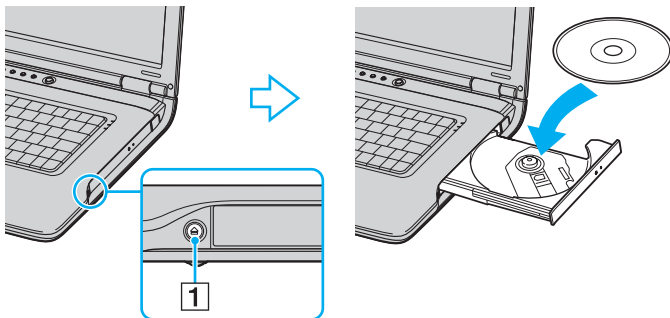

- 4 Close the tray by pushing it in gently.



Do not remove the optical disc when the computer is in a power saving mode (**Standby** or **Hibernate**). Doing so may cause the computer to malfunction.



If you plan to use an external optical disc drive, connect the drive before you launch any preinstalled CD/DVD program.



The location of the drive eject button depends on the model you purchased. See **Locating Controls and Ports** (page 11).



## Reading and Writing CDs and DVDs

Your computer plays and records CDs and DVDs, depending on the model you purchased. Check your specifications for the type of optical disc drive installed on your computer. Use the table below to see which types of media your optical disc drive supports.

<i>Optical disc drive</i>	<i>Plays</i>	<i>Records to</i>
CD-ROM	CD, CD-R, and CD-RW	—
DVD-ROM	DVD and most DVD-R, DVD-RW, DVD+R, DVD+RW and DVD+R DL (Double Layer)*	—
CD-RW	CD, CD-R, and CD-RW	CD-R and CD-RW
CD-RW/DVD-ROM	CD, CD-R, CD-RW, DVD, most DVD-R, DVD-RW, DVD+R, DVD+R DL (Double Layer)* and DVD+RW	CD-R and CD-RW
DVD-RW	CD, CD-R, CD-RW, DVD, DVD-R, DVD-RW, DVD+R, DVD+R DL (Double Layer)* and DVD+RW	CD-R, CD-RW, DVD-R and DVD-RW
DVD±RW	CD, CD-R, CD-RW, DVD, DVD-R, DVD-RW, DVD+R, DVD+R DL (Double Layer)* and DVD+RW	CD-R, CD-RW, DVD, DVD-R, DVD-RW, DVD+R, DVD+R DL (Double Layer)* and DVD+RW

\* On selected models only.

**!** This product is designed to playback discs that conform to the Compact Disc Digital Audio standard specifications (CD Standard). A DualDisc is a two sided disc product which mates DVD recorded material on one side with digital audio material on the other side. Please be aware that the audio side (non-DVD side) of a DualDisc may not play on this product because it does not conform to the CD Standard.

**!** Due to the multiple formats of discs now available, when buying pre-recorded or blank discs for use with a Sony VAIO computer, be sure to read the notices on the disc packaging carefully to check both playback and recording compatibility with your computer's optical disc drives. Sony does NOT guarantee the compatibility of VAIO CD drives with discs that not compliant with the official "CD" format standard (or "DVD" standard in relation to DVD drives). **USING NON-COMPLIANT DISCS CAN CAUSE FATAL DAMAGE TO YOUR VAIO PC OR CREATE SOFTWARE CONFLICTS AND CAUSE SYSTEM HANGING.** For inquiries about disc formats, contact the individual publisher of the pre-recorded disc or the manufacturer of the recordable disc.

## Notes on writing data onto a disc

- ❑ To make the data on a disc readable on an optical disc drive, you need to close the session when you eject it. To complete this process, follow the instructions included with your software.
- ❑ Only use circular discs. Do not use discs in any other shape (star, heart, card, etc.), as this may damage the optical disc drive.
- ❑ Do not strike or shake the computer while writing data onto a disc.
- ❑ Deactivate the screen saver and exit anti-virus software before writing data onto a disc.
- ❑ Do not use memory-resident utility software while writing data to a disc. This may cause the computer to malfunction.
- ❑ When using your software application to burn discs, make sure you exit and close all other applications.
- ❑ Never touch the surface of the disc. Fingerprints and dust on the surface of a disc may cause writing errors.
- ❑ Do not switch power modes while using the pre-installed software and while using the CD burning software.
- ❑ Never put stickers on discs. This will affect the use of the disc irreparably.
- ❑ Connect and use the AC adapter to power your computer or make sure your battery is at least 50 percent charged.
- ❑ Some DVD players and computer's DVD drives may not be able to play DVDs created by the **VAIO Zone** software.



Ultra-speed CD-RW is supported on VGN-A700 Series models but not on VGN-FS600 Series models.

Supports writing to DVD-RW discs compliant with DVD-RW version 1.1/1.2.

Supports 8cm disc reading, but does not support 8cm disc writing.

Because the maximum writing speed to DVD+R DL (Double Layer) discs is 2.4x speed, it may take a while to finish writing to such discs. See the online **Specifications** sheet for more information on the optical disc drive.

## Notes on playing DVDs

To achieve optimum performance when playing DVDs, you should follow these recommendations.

- ❑ You can play DVDs using the optical disc drive and the **VAIO Zone** software. See the help file on the **VAIO Zone** software for details.
- ❑ Close all open applications before playing a DVD movie.
- ❑ Do not use memory-resident utility software to speed up disc access when playing a DVD. This may cause the computer to malfunction.
- ❑ Deactivate the screen saver and exit anti-virus software before playing a disc.
- ❑ Some discs recorded at 20 or 24 bits may produce noise while playing. If you have audio devices connected, this may damage your hearing and the speakers. Reduce the volume before playing a DVD.
- ❑ Do not switch power saving modes while the computer is playing a DVD.
- ❑ Region code indicators are labeled on the DVDs to indicate in which region and on what type of player you can play the disc. If the DVD is labeled "all," this means that you can play this DVD in most regions of the world. If the region code of your residence area is different from the label on the DVD disc or on the packaging, you cannot play the disc on this player.



You can change the DVD region code only a limited number of times. When you have exceeded this number, the drive's DVD region code is permanently assigned and you will not be able to change it again. Reconfiguring your computer does not reset this count.

If you change the DVD region code while the **WinDVD** software is running, restart the software or eject the disc and re-insert it to make the new setting effective.

- ❑ If your computer has Wireless LAN and Wireless LAN is activated, playing DVDs may cause some interruptions in audio and video.
- ❑ When you are playing a DVD (video or audio) and you want to remove a USB device, such as USB-compatible speakers, make sure you stop the DVD first. Removing a USB-compatible device during DVD (video or audio) playback may cause a malfunction.

## *Playing CDs*

To play an audio CD

- 1 Insert the disc into the optical disc drive.
- 2 If nothing appears on the desktop once you insert an audio CD disc, then click **Start**, point to **All Programs**, and click to open a CD program, such as the **SonicStage** software.  
If the **Audio CD** window appears, click to select an option.

## Copying Files to CDs

To determine which type of CD your computer supports, see **Reading and Writing CDs and DVDs** ([page 41](#)).

To copy files to a CD-RW or CD-R

- 1 Insert a blank CD-R or CD-RW disc into the optical disc drive.  
If the **CD Drive** window appears, click **Take no action**.
- 2 Open Windows Explorer by pressing the **Windows** key and the **E** key simultaneously.
- 3 In the **Folders** panel on the left, locate the file(s) or folder(s) you want to copy and either:
  - Right-click the file(s) or folder(s), point to **Send To**, and click the optical disc drive\* name.
  - Drag the file(s) or folder(s) onto the optical disc drive icon in the **Files Stored on This Computer** panel.
- 4 Close Windows Explorer.
- 5 Click **Start** and then **My Computer**.
- 6 Click the optical disc drive icon under **Devices with Removable Storage**. A new window appears with the file(s) or folder(s) you want to copy listed under **Files Ready to Be Written to the CD**.
- 7 In the **CD Writing Tasks** box, click **Write these files to CD**.
- 8 Follow the instructions in the **CD Writing Wizard**.

\* The read/write drive letter designation may vary, depending on your system's hardware configuration.

**!**  
Do not strike or shake the computer while writing data onto a disc.

## *Playing DVDs*

To play a DVD

- 1 Close all open programs.
- 2 Insert the DVD into the optical disc drive.
- 3 Click **Start** and point to **All Programs**.
- 4 Select a DVD software program to play the DVD.

For instructions on how to use a program, see the help guide included with the DVD software program.

## *Copying Files to DVDs (on Selected Models Only)*

See the online **Specifications** sheet to see whether your model is equipped with an optical disc drive capable of DVD writing.

To copy files to a DVD-R or DVD-RW

- 1 Connect the AC adapter to the computer.
- 2 Insert the disc into the optical disc drive.
- 3 Click **Start** and point to **All Programs**.
- 4 Select a DVD software program you want to use from the submenu.

For instructions on how to use a program, see the help guide included with the DVD software program.

## Using the TV Function (on Selected Models Only)

If an A/V port replicator is delivered with the model you purchased, your computer is equipped with a TV tuner. In combination with Sony's **VAIO Zone** software, the TV tuner board allows you to:

- Watch, record and play back analog broadcasted cable and terrestrial TV programs, all by remote control.
- Digitize analog video and audio using the S-video or composite and audio inputs.
- Manage your video units (capsules), preview them and create multiple folders.
- Set up a timer to record channels at a repeated time.
- Suspend viewing TV (time-shifting).
- Stream your recorded TV contents via Ethernet (or WLAN) to connected PCs.



Sony cannot guarantee the streaming of recorded content if it does not meet a certain level of high quality.

To use the **VAIO Zone** software, you need to connect your computer and TV to the A/V port replicator and set up the **VAIO Zone** software for TV viewing. See **Attaching Your Computer to the Port Replicator (page 71)** and **Setting Up TV Connections (on Selected Models Only) (page 79)** for details.

Once your computer and TV are connected to the A/V port replicator, click **Start** and then **VAIO Zone**. When starting the **VAIO Zone** software for the first time, the VAIO Zone setup wizard opens automatically and prompts you to set up your TV channel source and establish the listings for your local TV program guide. Follow the on-screen instructions.

For details on using the software and the remote commander, please see the help file in the **VAIO Zone** software.

## Using PC Cards

PC Cards allow you to connect portable external devices.

### Inserting a PC Card

To insert a PC Card

- 1 Insert the PC Card into the PC Card slot with the front label facing up.
- 2 Gently push the PC Card into the slot.  
The PC Card is automatically detected by your system.  
The **Safely Remove Hardware** icon appears on the taskbar.

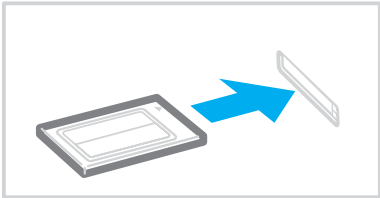





Some devices may not function properly if you continually switch to **Normal** mode from **Standby** mode or **Hibernate** mode. For some PC Cards, if you alternate between **Normal** mode and **Standby** or **Hibernate** mode while the card is inserted, you may find that a device connected to your system is not recognized. Restart your system to correct the problem. Restarting will restore the original state of the computer.

While the card is inserted, your computer may not enter **Hibernate** power management mode. It may enter **Standby** mode. We recommend that you remove the card before your computer enters **Hibernate** mode.

Some PC Cards or their functions may not be compatible with your computer.

Make sure you use the most recent software driver provided by the PC Card manufacturer.

If an "!" mark appears on the **Device Manager** tab in the **System Properties** window, remove the software driver and then reinstall it.

Do not force a PC Card into the slot. It may damage the connector pins. If you have difficulty inserting a PC Card, check that you are inserting the PC Card in the correct direction. See the manual supplied with your PC Card for more information on use.

Do not carry your computer while touching the head of a PC Card, because pressure or shock may damage the connector pins.

You do not need to shut down your computer before inserting or removing a PC Card.

## Removing a PC Card

Follow the steps below to remove the PC Card while your computer is on. If it is not removed properly, your system may not work properly.

To remove a PC Card



To remove a PC Card when your computer is off, skip steps 1 to 7.

- 1 Double-click the **Safely Remove Hardware** icon on the taskbar.  
The **Safely Remove Hardware** window appears.
- 2 Select the hardware you want to unplug.
- 3 Click **Stop**.  
The **Stop a Hardware Device** window appears.
- 4 Confirm that the device can be safely removed from the system.
- 5 Click **OK**.  
A window appears, explaining that it is safe to remove the device.
- 6 Click **OK**.
- 7 Click **Close**.
- 8 Push the PC Card release button so that the release button pops out.
- 9 Push the PC Card release button a second time so that the PC Card pops out.
- 10 Gently take hold of the Card and pull it out of the slot.
- 11 If the PC Card release button is still out, push it back in.



If you remove the PC Card from the computer when it is still turned on, your system could malfunction and you might lose any unsaved data.

Before you remove the PC Card, click the PC Card icon on the taskbar and close the card. Close any applications that use the PC Card before removing the card. Otherwise, data may be lost.

## Using the Memory Stick Media

Your VAIO computer supports the Memory Stick media. Memory Stick media is a compact, portable, and versatile device especially designed for exchanging and sharing digital data with compatible products, such as digital cameras, mobile phones and other devices. Because it is removable, it can be used for external data storage.

For the latest information on Memory Stick media, visit the Sony online support Web site at <http://www.sony.com/pcsupport> for customers in USA and Canada, or at <http://kdb.sony-latin.com/> for customers in Latin American countries or areas.

## Write-protecting a Memory Stick Media

Some versions of Memory Stick media are designed with an erasure prevention switch to protect valuable data from accidental erasure or overwriting.

Move the tab horizontally or vertically\* to set or release write-protection. When the erasure prevention switch is off, data can be saved on the Memory Stick media. When the erasure prevention switch is on, data can be read from but not saved on the Memory Stick media.

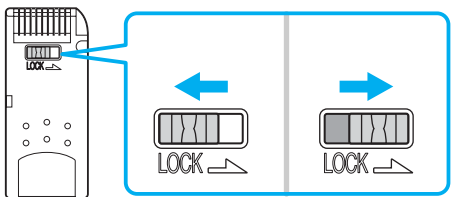

\* Some versions of Memory Stick media do not have an erasure prevention switch.

## Inserting a Memory Stick Media

There are two ways you can insert a Memory Stick media into your computer:

- ❑ Using the Memory Stick media slot;
- ❑ Using a PC Card slot. To do this, you need an optional PC Card adapter.

You can only insert one Memory Stick media at a time.

To insert a Memory Stick media using the Memory Stick media slot

- 1 Insert the Memory Stick media with the arrow facing up and toward the Memory Stick media slot.
- 2 If your computer is equipped with the Memory Stick media slot cover, lift the slot cover.
- 3 Carefully slide the Memory Stick media into the slot until it clicks in place.

The Memory Stick media is automatically detected by your system and appears in your **My Computer** window as a local drive, under the appropriate letter (depending on the configuration of your computer).

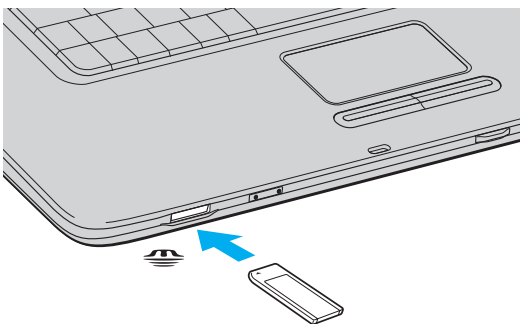

The location of the Memory Stick media slot depends on the model you purchased. See **Locating Controls and Ports** ([page 11](#)).

! Be sure to hold the Memory Stick media with the arrow pointing in the correct direction as you insert it into the slot. To avoid damaging the computer or the Memory Stick media, do not force the Memory Stick media into the slot if it does not insert smoothly.

Do not insert more than one Memory Stick media into the Memory Stick media slot. Inserting the media improperly may damage the computer.

 Your computer supports Memory Stick Duo media. For more information on Memory Stick Duo media, visit the Memory Stick web site at <http://www.memorystick.com/en/>.

## Viewing the Contents

Depending on the model you purchased, the **Memory Stick** window may appear when you insert a Memory Stick media. From this window, you can choose to view, print, copy or organize your images or data stored on the Memory Stick media. If the **Memory Stick** window does not appear when you insert the Memory Stick media, follow these steps:

To view the contents

- 1 Click **Start** and then **My Computer**.  
The **My Computer** window appears.
- 2 Click **Memory Stick**.  
The **Memory Stick** window appears, displaying the contents stored on the Memory Stick media.

## Formatting a Memory Stick Media

Memory Stick media is formatted for immediate use when you purchase it. If you need to reformat Memory Stick media, use the **Memory Stick Formatter** software that is provided with the media. For more information about using Memory Stick Formatter, see the **Memory Stick Formatter** help file.



Formatting Memory Stick media erases all data previously saved to it. Before you reformat Memory Stick media, confirm that the media does not contain files you want to keep. Back up important data before formatting the media.

### To format a Memory Stick media

- 1 Click **Start**, point to **All Programs, Memory Stick Utility**, and click **Memory Stick Formatter**. The **Memory Stick Formatter** window appears.
- 2 Click **Start Format**, and follow the on-screen instructions.
- 3 After formatting, click **Exit**.

## Removing a Memory Stick Media

### To remove a Memory Stick media using the Memory Stick media slot

- 1 Check that the Memory Stick media indicator is off.
- 2 Push the Memory Stick media in toward the computer. The Memory Stick media ejects.
- 3 Pull the Memory Stick media out of the slot.



Always remove the Memory Stick media gently, or it may pop out unexpectedly.

Do not remove the Memory Stick media while the Memory Stick media indicator is turned on. If you do, you may lose data. Large volumes of data may take time to load, so be sure the indicator is off before removing the Memory Stick media.

## Using the Internet

### Setting Up a Dial-up Internet Connection

Before you can connect to the Internet, you need to connect your computer to a telephone line via a telephone cable (not supplied). Once you set up your telephone cable, you're ready to connect to the Internet.

To connect a telephone cable

- 1 Plug one end of the phone cable (1) into the modem port  on the computer.
- 2 Plug the other end into the wall jack (2).

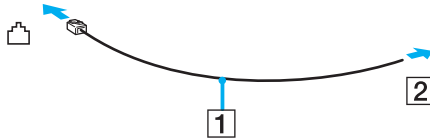

Your computer does not work with party lines, cannot be connected to a coin-operated telephone, and may not work with multiple telephone lines or a private branch exchange (PBX). Some of these connections may result in excess electrical current and could cause a malfunction in the internal modem.

If you connect a telephone cable coming through a splitter, the modem or connected device may not work properly.

To set up a dial-up connection to the Internet

- 1 Click **Start**, point to **All Programs, Accessories, Communications**, and click **New Connection Wizard**. The **New Connection Wizard** appears.
- 2 Click **Next**. If the **Location Information** window appears, follow the on-screen instructions.
- 3 If it is not already selected, click to select **Connect to the Internet**, and click **Next**.
- 4 Follow the on-screen instructions.



## Using Wireless LAN (WLAN)

Using the Sony Wireless LAN (WLAN), all your digital devices with built-in WLAN functionality communicate freely with each other through a powerful network. A WLAN is a network in which a user can connect to a local area network (LAN) through a wireless (radio) connection. So there is no need anymore to pull cables or wires through walls and ceilings.

Please note that the Wireless LAN functionality is equipped on selected models only.

The Sony WLAN supports all normal Ethernet activities, but with the added benefits of mobility and roaming. You can still access information, internet/intranet and network resources, even in the middle of a meeting, or as you move from one place to another.

You can communicate without an Access Point, which means that you can communicate between a limited number of computers (**ad-hoc**). Or you can communicate through an Access Point, which allows you to create a full infrastructure network (**infrastructure**).



WLAN uses the IEEE802.11b/g standard, which specifies the used technology. The standard includes the encryption method: **Wired Equivalent Privacy** (WEP), which is a security protocol and **WiFi Protected Access** (WPA - Proposed jointly by the IEEE and Wi-Fi Alliance, WiFi Protected Access is a specification of standards based, interoperable security enhancements that increase the level of data protection and access control for existing WiFi networks. WPA has been designed to be forward compatible with the IEEE802.11i specification. It utilizes the enhanced data encryption TKIP (Temporal Key Integrity Protocol) in addition to user authentication using 802.1X and EAP (Extensible Authentication Protocol)). Data encryption protects the vulnerable wireless link between clients and Access Points. Besides that, there are other typical LAN security mechanisms to ensure privacy, such as: password protection, end-to-end encryption, virtual private networks, and authentication.

Wireless LAN devices using the IEEE802.11a standard and the ones using the IEEE802.11b or g standard cannot communicate because the frequencies are different.

IEEE802.11b: The standard speed is 11 Mbps, or about 30 to 100 times faster than a standard dial up.

IEEE802.11a/g: The standard speed is 54 Mbps, or about 5 times faster than a Wireless LAN device using the IEEE802.11b standard.

## *Communicating without an Access Point (Ad-hoc)*

An ad-hoc network is a network in which a local network is created only by the wireless devices themselves, with no other central controller or Access Point. Each device communicates directly with other devices in the network. You can set up an ad-hoc network easily at home.

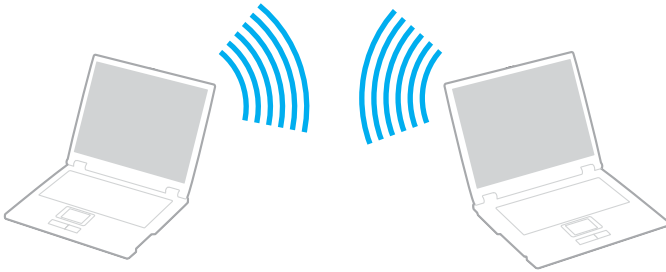

## To communicate without an Access Point (ad-hoc)

- 1 Turn on the **WIRELESS LAN** switch.  
The **WIRELESS LAN** indicator lights up.
- 2 Click **Start** and then **Control Panel**.
- 3 Click **Network and Internet Connections**.
- 4 Click **Network Connections**.  
The **Network Connections** window appears.
- 5 Right-click **Wireless Network Connection**, then click **Properties**.  
The **Wireless Network Connection Properties** window appears.
- 6 Select the **Wireless Networks** tab.
- 7 Click the **Add...** button.  
The **Wireless network properties** window appears.
- 8 Enter a **Network name (SSID)**<sup>\*1</sup>.  
You can choose a **32-digit** alphanumeric name.
- 9 Select **Open** from the **Network Authentication** drop-down box.
- 10 Select **WEP** from the **Data Encryption** drop-down box.
- 11 Deselect the **The key is provided for me automatically** option button.  
Some information becomes visible.
- 12 Enter the **Network key**<sup>\*1</sup>.  
The network key should be **5 or 13 alphanumeric characters** or **10 or 26 hexadecimal**<sup>\*2</sup> **characters** long. You can choose whatever you want.
- 13 Enter exactly the same **Network key** again, for confirmation.

- 14 Select the check box **This is a computer-to-computer (ad hoc) network; wireless access points are not used** at the bottom of the screen.
- 15 Click **OK**.  
Your **Network name** appears in the **Preferred networks**.
- 16 Click **Advanced**.  
The **Advanced** window appears.
- 17 Select the **Computer-to-computer (ad hoc) networks only** option button.
- 18 Click **Close**.
- 19 Click **OK**.  
Your computer is ready to communicate with another computer.

\*1 If you want to communicate between two or more computers, you need to configure all these computers the exact same way. This means that you need to enter the same **Network name** and the same **Network key** on all computers as on the first computer you configure.

\*2 **Hexadecimal**: A number representation using the digits 0-9, with their usual meaning, plus the letters A-F (or a-f) to represent hexadecimal digits with values of (decimal) 10 to 15.



An ad-hoc network does not support WPA.

To disconnect from a computer-to-computer (ad-hoc) network

- 1 Click **Start** and then **Control Panel**.
- 2 Click **Network and Internet Connections**.
- 3 Click **Network Connections**.  
The **Network Connections** window appears.
- 4 In the right panel under **LAN or High-Speed Internet**, double-click **Wireless Network Connection**.  
The **Wireless Network Connection Status** window appears.
- 5 Click **Properties**.  
The **Wireless Network Connection Properties** window appears.
- 6 On the **Wireless Networks** tab, click **Advanced**.  
The **Advanced** window appears.
- 7 Click to select **Any available network (access point preferred)**, and click **Close**.
- 8 Click **OK**.
- 9 Click **Close**.
- 10 Turn off the **WIRELESS LAN** switch.

## Communicating with an Access Point (Infrastructure)

An infrastructure network is a network that extends an existing wired local network to wireless devices by providing an Access Point, for example the **Sony Access Point**. The Access Point bridges the wireless and wired LAN and acts as a central controller for the Wireless LAN. The Access Point coordinates transmission and reception from multiple wireless devices within a specific range.

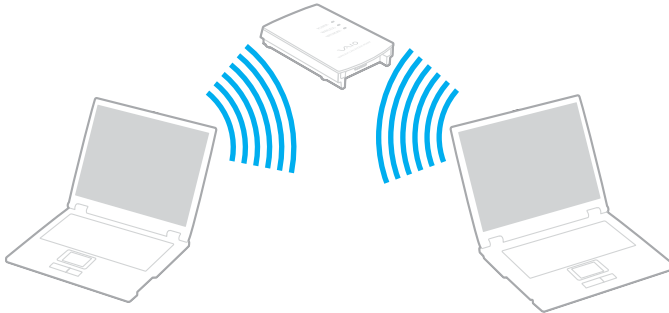

## To connect to a wireless network

Use the **VAIO Wireless Utility** to guide you through the set up process and provide you with more detailed information about wireless connections.

- 1 Make sure an access point is set up. See the instructions that accompanied the access point for more information.
- 2 Turn on the **WIRELESS LAN** switch.  
The WIRELESS LAN indicator lights up.
- 3 Click **Start**, point to **All Programs**, and click **VAIO Wireless Utility**.  
The **VAIO Wireless Utility** appears.
- 4 Follow the on-screen instructions.

## To disconnect from a wireless network

- Turn off the **WIRELESS LAN** switch.



Turning off the wireless LAN functionality while accessing remote documents, files, or resources may result in data loss.



The WPA key needs to contain at least 8 characters.

## Wireless LAN Channel Selection

In an 802.11b/g configuration, channel 1 to 11 can be used.

### (a) With an Access Point ("Infrastructure")

- ❑ The channel used will be the channel selected by the Access Point.

! For details on how to select the channel that will be used by the Access Point, see the access point manual.

### (b) Without an Access Point ("ad-hoc")

- ❑ If the Wireless connection is initiated by the VAIO computer, channel 11 will be selected.
- ❑ If the Wireless connection is initiated by a peer Wireless LAN equipment, the Wireless LAN communication will make use of the channel selected by the peer Wireless LAN equipment.



The 2.4 GHz bandwidth used by wireless LAN compatible devices is also used by other various devices. Although technologies to minimize interference from other devices that uses the same bandwidth are employed on wireless LAN compatible devices, such interference may cause lower communication speed, narrower communication range, or broken wireless connections.

The communication speed varies depending on the distance between communication devices, existence of obstacles between such devices, the device configuration, the radio conditions, and the software in use. In addition, communications may be cut off depending on the radio conditions.

The communication range varies depending on the actual distance between communication devices, existence of obstacles between such devices, the radio conditions, the ambient environment that includes existence of walls and materials of such walls, and the software in use.

Deploying IEEE802.11b and IEEE802.11g products on the same wireless network may reduce the communication speed due to radio interference. Taking this into consideration, the IEEE802.11g products are designed to reduce the communication speed to ensure communications with IEEE802.11b products. When the communication speed is not as fast as expected, changing the wireless channel on the access point may increase the communication speed.



## Using Peripheral Devices

You can add functionality to your computer by using the various ports on your unit.

- ❑ **Connecting a Port Replicator** ([page 66](#))
- ❑ **Using the Mouse (on Selected Models Only)** ([page 87](#))
- ❑ **Connecting External Speakers** ([page 91](#))
- ❑ **Using the Remote Commander** ([page 97](#))
- ❑ **Connecting an External Display** ([page 100](#))
- ❑ **Selecting Display Modes** ([page 108](#))
- ❑ **Using the Multiple Monitors Function** ([page 111](#))
- ❑ **Connecting an External Microphone** ([page 115](#))
- ❑ **Connecting a Universal Serial Bus (USB) Device** ([page 116](#))
- ❑ **Connecting a Printer** ([page 119](#))
- ❑ **Connecting an i.LINK Device** ([page 121](#))
- ❑ **Connecting to a Network (LAN)** ([page 123](#))

## *Connecting a Port Replicator*

Attaching a port replicator enables you to connect additional peripherals to your computer, such as a printer and an external display.

A port replicator may be delivered with your computer, depending on the model you purchased. If not, you can additionally purchase an optional port replicator.

## Locating Ports on the Port Replicator

### A/V port replicator for VGN-A700 Series models

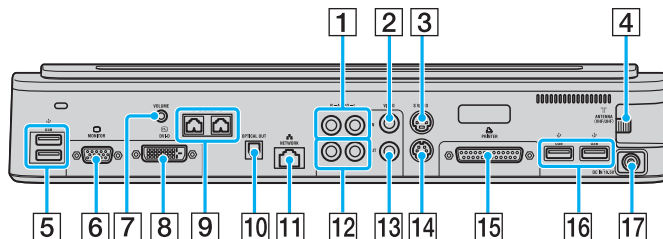

- 1 Composite Audio In jacks ([page 68](#))
  - 2 Composite Video In jack ([page 68](#))
  - 3 S Video In port ([page 68](#))
  - 4 VHF/UHF port ([page 79](#))
  - 5 Hi-Speed USB (USB 2.0) ports\* ([page 116](#))
  - 6 Monitor (VGA) port ([page 101](#))
  - 7 Volume jack ([page 93](#))
  - 8 DVI-D port ([page 101](#))
  - 9 Speaker jacks (right and left) ([page 93](#))
  - 10 Optical Out port Output frequency (96 kHz/48 kHz/44 kHz/Variable)
  - 11 Network (Ethernet) port (1000BASE-T / 100BASE-TX / 10BASE-T) ([page 123](#))
  - 12 Composite Audio Out jacks ([page 106](#))
  - 13 Composite Video Out jack ([page 106](#))
  - 14 S Video Out port ([page 106](#))
  - 15 Printer port ([page 119](#))
  - 16 Hi-Speed USB (USB 2.0) ports\* ([page 116](#))
  - 17 DC In port ([page 25](#))
- \* Supports high-/full-/low- speeds.



The printer port on this port replicator is intended for printer connections only.



To the A/V port replicator, you can connect an external video/audio source such as a video camera, VCR or DVD player. Connect your video/audio device's video cable to the S Video In or Composite Video In jack and the audio cable to the Composite Audio In Jacks.

## Business port replicator for VGN-A700 Series models

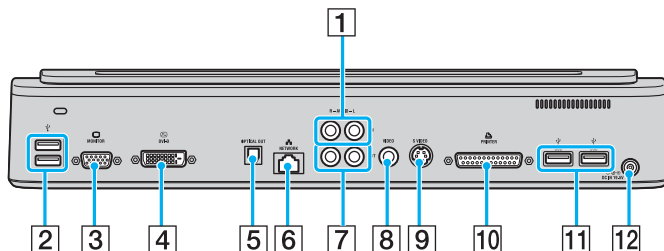

- 1 Composite Audio In jacks ([page 68](#))
  - 2 Hi-Speed USB (USB 2.0) ports\* ([page 116](#))
  - 3 Monitor (VGA) port ([page 101](#))
  - 4 DVI-D port ([page 101](#))
  - 5 Optical Out port Output frequency (96 kHz/48 kHz/44 kHz/ Variable)
  - 6 Network (Ethernet) port (1000BASE-T / 100BASE-TX / 10BASE-T) ([page 123](#))
  - 7 Composite Audio Out jacks ([page 106](#))
  - 8 Composite Video Out jack ([page 106](#))
  - 9 S Video Out port ([page 106](#))
  - 10 Printer port ([page 119](#))
  - 11 Hi-Speed USB (USB 2.0) ports\* ([page 116](#))
  - 12 DC In port ([page 25](#))
- \* Supports high-/full-/low- speeds.



To the business port replicator, you can connect an external audio device such as a CD player. Connect your audio device's audio cable to the Composite Audio In jack.



When a video cable is connected to each of the S Video Out and Composite Video Out jacks, the Composite Video Out jack is disabled.

## A/V port replicator for VGN-FS600 Series models

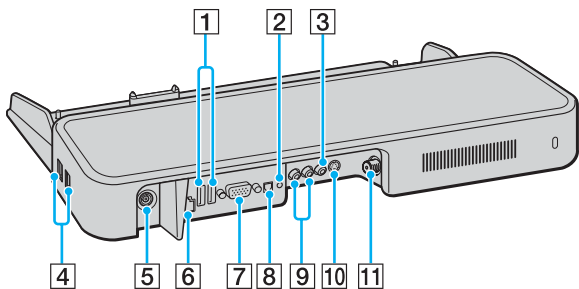

- 1 Hi-Speed USB (USB 2.0) ports\* ([page 116](#))
- 2 Headphones/Speakers jack ([page 91](#))
- 3 Composite Video In jack ([page 69](#))
- 4 Hi-Speed USB (USB 2.0) ports\* ([page 116](#))
- 5 DC In port ([page 25](#))
- 6 Network (Ethernet) port (100BASE-TX / 10BASE-T) ([page 123](#))
- 7 Monitor (VGA) port ([page 101](#))
- 8 Optical Out port Output frequency (96 kHz/48 kHz/44 kHz/ Variable)
- 9 Composite Audio In jacks ([page 69](#))
- 10 S Video In port ([page 69](#))
- 11 VHF/UHF port ([page 79](#))

\* Supports high-/full-/low- speeds.



To the A/V port replicator, you can connect an external video/audio source such as a video camera, VCR or DVD player. Connect your video/audio device's video cable to the S Video In or Composite Video In jack and the audio cable to the Composite Audio In Jacks.

## Business port replicator for VGN-FS600 Series models

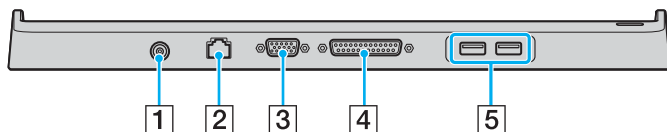

- 1 DC In port ([page 25](#))
- 2 Network (Ethernet) port (100BASE-TX / 10BASE-T) ([page 123](#))
- 3 Monitor (VGA) port ([page 101](#))
- 4 Printer port ([page 119](#))
- 5 Hi-Speed USB (USB 2.0) ports\* ([page 116](#))

\* Supports high-/full-/low- speeds.



The port replicator can be powered only through the AC adapter supplied with your computer. Do not unplug the AC adapter from the port replicator and the AC outlet while using the port replicator; this may cause data damage or hardware malfunctions.



The printer port on the port replicator is intended for printer connections only.

## Attaching Your Computer to the Port Replicator

To attach your computer to the port replicator

### VGN-A700 Series models

- 1 Disconnect all peripherals from the computer.
- 2 Plug the power cord (1) into the AC adapter and an AC outlet.
- 3 Plug the cable attached to the AC adapter (2) into the DC In port (3) on the port replicator (4).

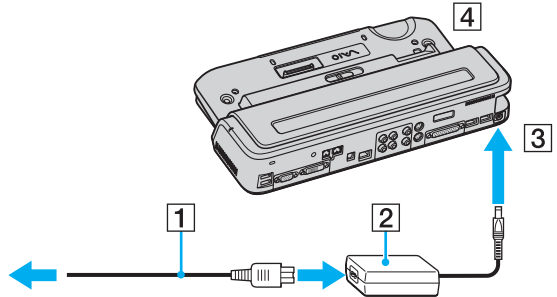

- 4 Open the port replicator connector cover.

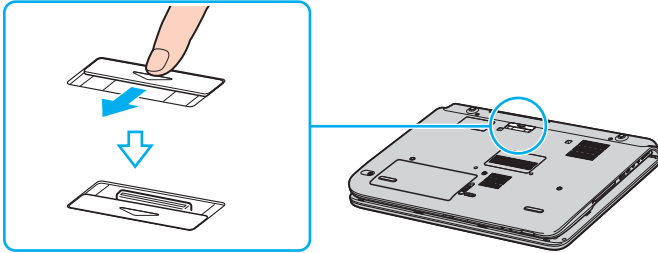

- 5 Align the bottom connector of the computer with the connector on the port replicator and push down until it clicks into place.

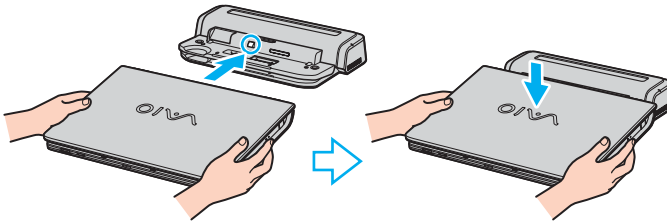



- 6 Slide the lock switch to **LOCK**.

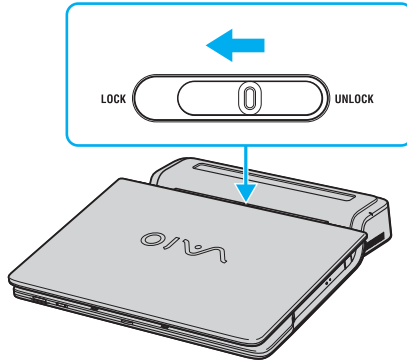

- 7 Turn on the computer.

### VGN-FS600 Series models

- 1 Disconnect all peripherals from the computer.
- 2 Plug the power cord (1) into the AC adapter and an AC outlet.
- 3 Plug the cable attached to the AC adapter (2) into the DC In port (3) on the port replicator (4).

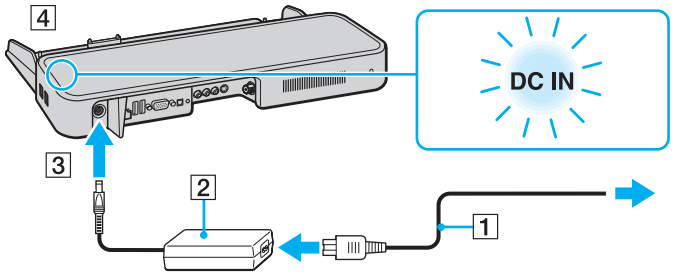

- 4 Open the port replicator connector cover.

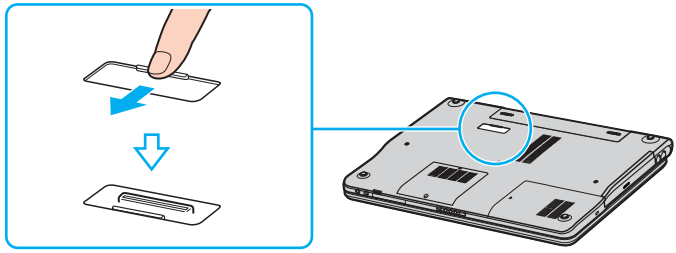

5 Align the bottom connector of the computer with the connector on the port replicator and push down until it clicks into place.

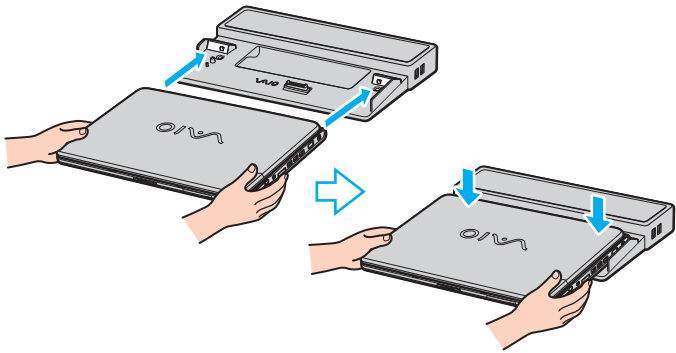

**!** When the A/V port replicator is attached to your computer, you cannot access the DC In port, the monitor (VGA) port, the third USB port from the front, and the network (Ethernet) port on the computer.

 Use the AC adapter that comes with your computer or the optional Sony adapter.

**!** Do not move your computer while attached to the port replicator; this may detach the port replicator and cause damage to the port replicator and the computer.

## Disconnecting Your Computer from the Port Replicator

**!** To prevent loss of unsaved data, be sure to turn off your computer before disconnecting it from the port replicator.

To disconnect your computer from the port replicator

### VGN-A700 Series models

- 1 Turn off the computer and the connected peripherals.
- 2 Slide the lock switch to **UNLOCK**.

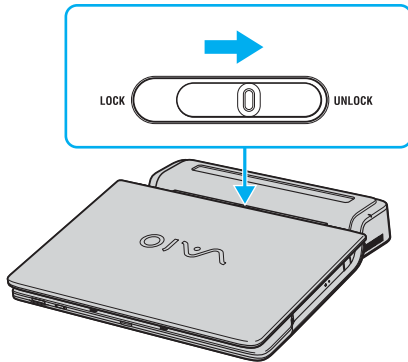

- 3 Lift the computer away from the port replicator.

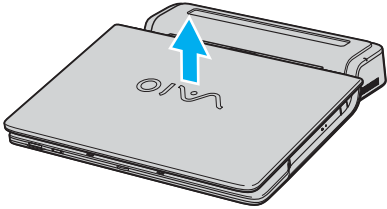

- 4 Close the port replicator connector cover on the bottom of your computer.

## VGN-FS600 Series models

- 1 Lift the computer away from the port replicator.

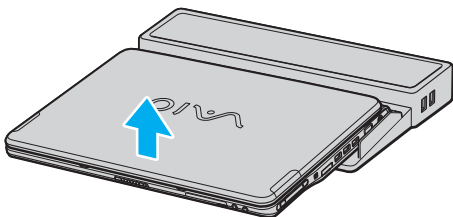

- 2 Close the port replicator connector cover on the bottom of your computer.



It is extremely important to close the port replicator connector cover after disconnecting your computer from the port replicator. If the cover is left open, dust may get inside and damage the computer.

To disconnect your port replicator completely from AC power, unplug the AC adapter.

### *Setting Up TV Connections (on Selected Models Only)*

The best method of connecting your computer system, TV monitor or display, and cable service access, depends on the type of cable connection available in your home.

TV signal reception strength will vary widely depending on service availability in your area as well as the type of connection available.



The A/V port replicator is supplied with certain audio and video cables. Depending on your in-home cable access, you may require extra cables, adapters or connection equipment not supplied with your computer.

One primary cable to connect your computer to a TV cable or antenna is the TV coaxial cable (supplied with the A/V port replicator). One end connects to the computer's VHF/UHF port, and the other end connects to the cable service access or antenna.



**1** TV coaxial cable

## Connecting to standard cable access (CATV)

To connect in CATV mode (Option 1)

- 1 Connect one end of the TV coaxial cable (1) (supplied) to your cable service access (wall outlet) (2).
- 2 Connect the other end of the coaxial cable to the VHF/UHF port (3) on the A/V port replicator.

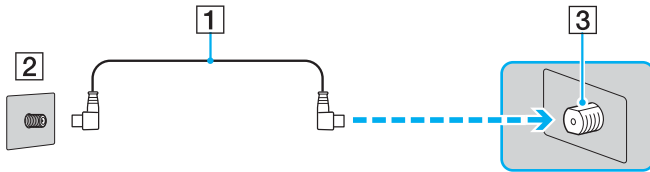

To connect in CATV mode (Option 2)

- 1 Connect the two metal hooks on the 75-ohm/300-ohm RCA transformer cable (1) (optional) to your cable service access (wall outlet) (2).
- 2 Connect the TV coaxial cable (3) (supplied) from the transformer end of the RCA transformer cable to the VHF/UHF port (4) on the port replicator.

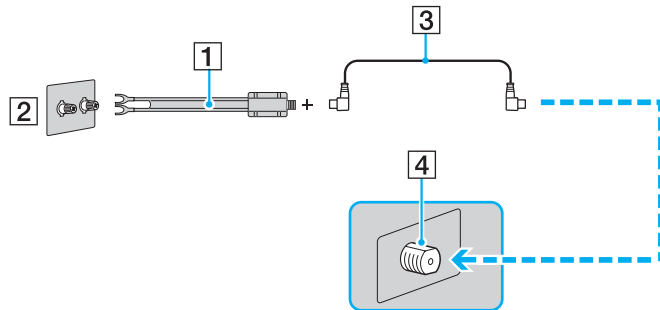



## *Connecting to a standard antenna*

You can connect your computer to an indoor/outdoor antenna system, using Option 1 or Option 2 from the previous section, **Connecting to standard cable access (CATV)** ([page 80](#)). Depending on the type of antenna system in your home, your connection may require a VHF/UHF RF combiner/transformer (optional) to connect your computer and the indoor/outdoor antenna system.



If you are connecting to an indoor/outdoor antenna, you may need to reorient the antenna for best reception. Move the antenna cable away from other power sources or connectors to reduce reception interference.

Your computer is supplied with certain audio and video cables. Depending on your in-home cable access, you may require extra cables, adapters or connection equipment not supplied with your computer.

To connect in terrestrial mode (Option 1)

- 1 Connect one end of a TV coaxial cable (1) (optional) to your antenna outlet (2). Connect the other end to a VHF/UHF RF combiner/transformer (3) (optional).
- 2 Connect the coaxial cable feed connector (4) (optional) to the VHF/UHF RF combiner/transformer (3).
- 3 Connect the TV coaxial cable (5) (supplied) from the feed connector (4) to the VHF/UHF port (6) on the port replicator.

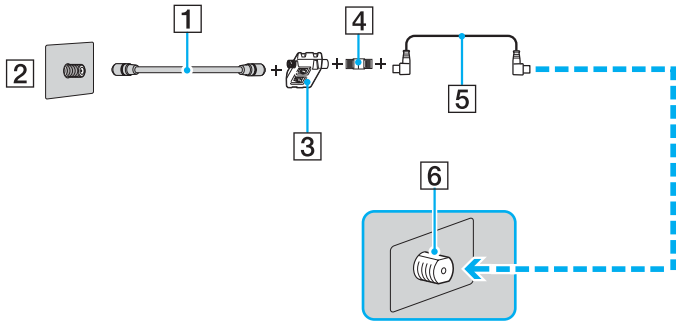

To connect in terrestrial mode (Option 2)

- 1 Connect one end of the antenna's 300-ohm twin lead cable (1) to the screw-type grips at your antenna outlet (2). Connect the other end to the grips on the VHF/UHF RF combiner/transformer (3).
- 2 Connect the coaxial cable feed connector (4) (optional) to the VHF/UHF RF combiner/transformer (3).
- 3 Connect the TV coaxial cable (5) (supplied) from the feed connector (4) to the VHF/UHF port (6) on the port replicator.

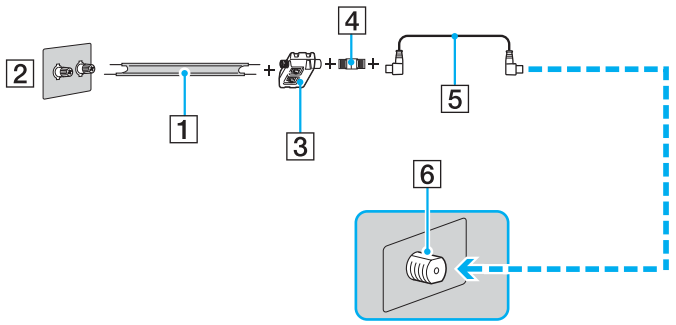

## *Connecting with a cable or satellite set-top box (STB)*

You can connect your computer to cable service access that uses a set-top box (cable or satellite). When using the set-top box (STB) setup, you can only change channels through the STB, using its controls or supplied remote commander.

When using the STB setup:

- ❑ A standard TV remote control cannot be used to change TV channels. You can use your TV remote control to set the TV to the channel-out number (channel 3, 4, etc.) or direct video input specified by your cable or satellite service provider.
- ❑ You may be able to use a universal remote control or commander to change TV channels, if the device is able to control the STB.

### To connect in STB mode (Option 1)

- 1 Connect one end of a TV coaxial cable (1) (optional) to your cable service access (wall outlet) (2). Connect the other end to the VHF/UHF IN jack on the back panel of your set-top box (STB) (3).
- 2 Connect a second TV coaxial cable (4) (optional) to the VHF/UHF OUT jack on your STB unit (3). Connect the other end to the single-connection end of a splitter device (5) (optional).
- 3 Connect a third TV coaxial cable (6) (supplied) to the double-connection end of the splitter device (5). Connect the other end to the VHF/UHF port (7) on the port replicator.
- 4 Connect a fourth TV coaxial cable (8) (optional) to the double-connection end of the splitter device (5). Connect the other end to the VHF/UHF port (9) on the rear of your TV monitor or display.

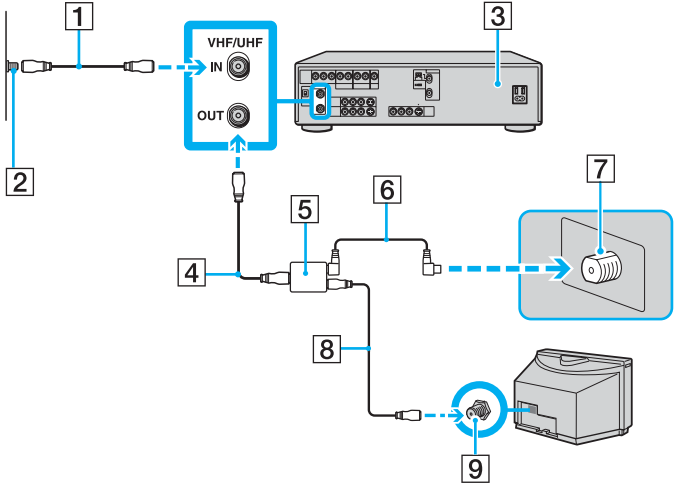

### To connect in STB mode (Option 2)

- 1 Connect one end of the TV coaxial cable (1) (supplied) to your cable service access (wall outlet) (2). Connect the other end to the VHF/UHF IN jack on the back panel of your set-top box (STB) (3).
- 2 Connect a second TV coaxial cable (4) (optional) to the VHF/UHF OUT jack on your STB unit (3). Connect the other end to the VHF/UHF port (5) on the rear of your TV monitor or display.
- 3 Connect one end of a stereo A/V dubbing cable with triple RCA jacks (6) (optional), to the Composite Audio Out (L/R) jacks (7) and the Video Out jack (8) on the back panel of your STB unit (3), matching the plug and jack colors.
- 4 Connect the other RCA jacks of the stereo A/V dubbing cable (6) into the Composite Audio In (L/R) jacks (9) and the Composite Video In jack (10) on the A/V port replicator, matching the plug and jack colors.

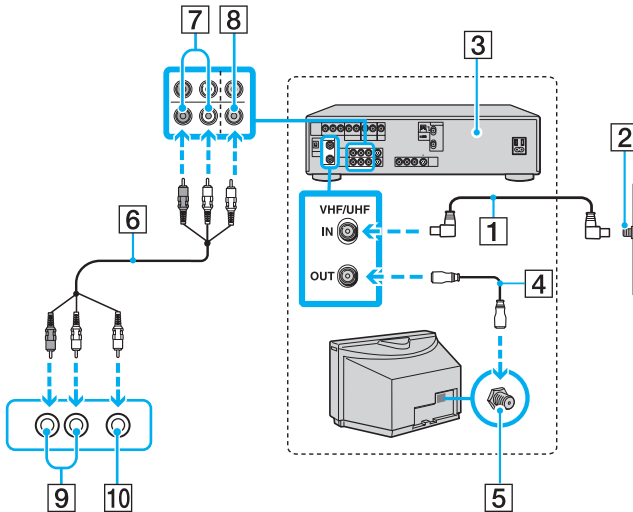

## Using the Mouse (on Selected Models Only)

Your computer includes a wireless optical mouse, which has no cables to plug in and uses a light-emitting diode (LED) instead of a ball. You can use the mouse anywhere you feel comfortable within a range of approximately 31 inches (80 cm)\* of the main unit. Avoid using the mouse on a piece of glass or other transparent material; this can interfere with smooth cursor movement on the screen.

\* Effective usage distance depends on the environment.

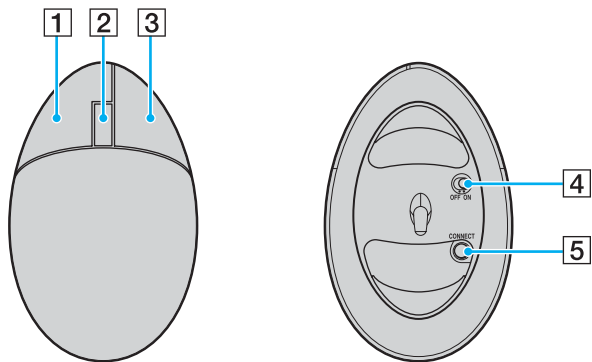

- 1** Left button  
Click or double-click the left button to select items. To drag and drop items, hold the left button down while sliding the mouse, then release the button to drop the item.
- 2** Central wheel  
Rotate the central wheel to scroll up or down a page. Press the wheel once to lock the scroll action and control the movement by moving the entire mouse (the scroll function is available only with applications that support it).
- 3** Right button  
Press the right button once to display a context-sensitive shortcut menu (not always an active function).
- 4** Power switch  
Slide the switch to turn the mouse on and off. This will help you save battery power.
- 5** **CONNECT** button  
Press to enable communication between your VAIO computer and the wireless mouse.

## Before You Use the Mouse

Before using the wireless mouse, you must establish communication between the computer and the mouse.

To connect the wireless mouse

- 1 Insert the two specific AA batteries into the wireless mouse as shown.



- 2 Turn on the computer.
- 3 Press the **CONNECT** button (1) on the computer.

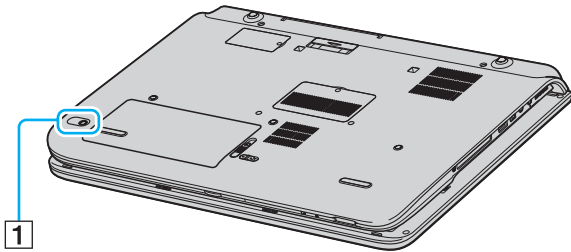



- 4 Turn over the wireless mouse, slide the power switch to the **ON** position, and press the **CONNECT** button. Communication between the wireless mouse and the computer should now be established.

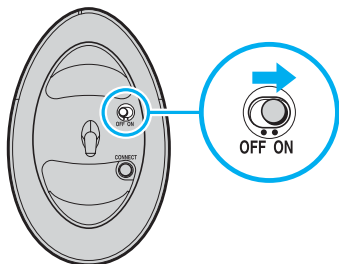

Step 3 and 4 must be completed within 10 seconds of each other.

Two AA batteries, specific for use in the wireless mouse, are supplied with your computer. They are identified by a sticker "For mouse" on the packaging.

If your wireless mouse does not operate properly, the batteries may need to be replaced. If your wireless mouse is not being used for an extended period of time, remove the batteries to avoid possible damage from battery leakage.

## *Adjusting the Mouse Functions*

- 1 Click **Start** and then **Control Panel**.
- 2 Click **Printers and Other Hardware**.
- 3 Click the **Mouse**.  
The **Mouse Properties** window appears.
- 4 Change the settings.

To set up your mouse for left-handed users

- 1 Click the **Buttons** tab on the **Mouse Properties** window.
- 2 Select the option button next to **Switch primary and secondary buttons**.
- 3 Click **OK**.  
The new mouse settings are now active.

## Connecting External Speakers

A pair of external speakers is delivered with your computer for extended use of the **VAIO Zone** software.

### External speakers for VGN-A700 Series models

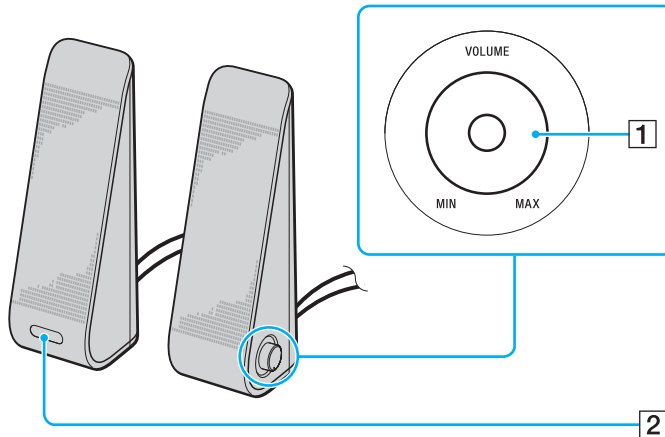

- 1** Volume control  
The right speaker is equipped with the volume control. Turn this control clockwise or counterclockwise to adjust the speaker volume.
- 2** Infrared receiver for remote commander **IR**  
The left speaker is equipped with the infrared receiver for communications with the remote commander. Point your remote commander to this sensor for operations.

## External speakers for VGN-FS600 Series models

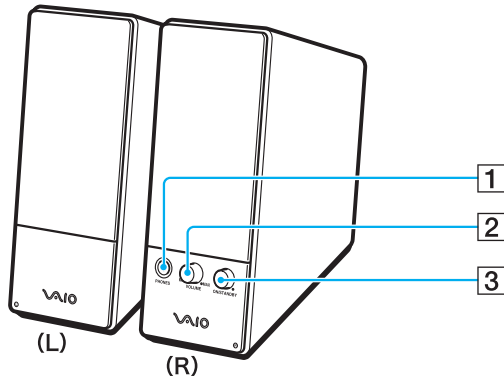

- 1** Headphones jack
- 2** Volume control  
Turn clockwise or counterclockwise to adjust the speaker volume.
- 3** Power button  
Turns on and off the speakers.

To connect the external speakers

**External speakers for VGN-A700 Series models**

- 1 Attach your computer to an A/V port replicator.
- 2 Plug the volume cable (1) of the speaker to the Volume jack on the port replicator.
- 3 Plug the speaker cables (2) to the Speaker jacks.
- 4 Plug the USB cable (3) to one of the USB ports.

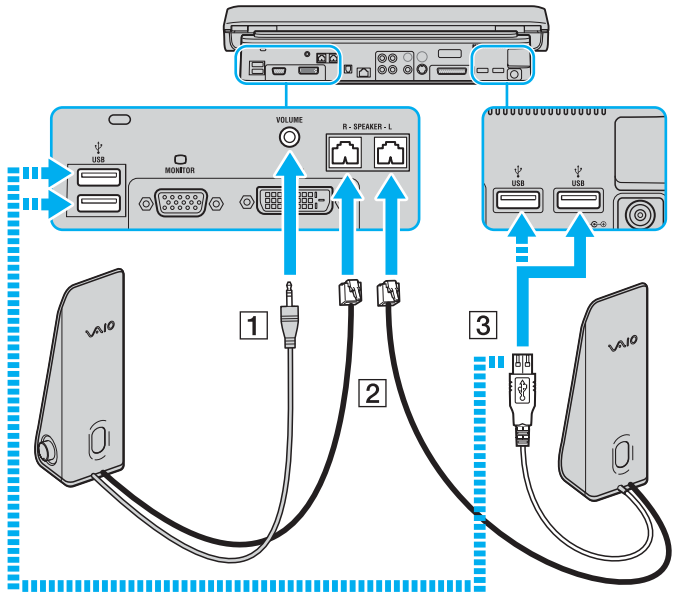

**!** To use a remote commander for volume control, make sure to connect the speaker's USB cable to the USB port.

Make sure to place the external speakers in a stable position.

Do not grasp the depression on the front of the speaker to take hold of it.

## External speakers for VGN-FS600 Series models

- 1 Attach your computer to an A/V port replicator.
- 2 Plug the power cord (1) to the AC adapter and a AC outlet.
- 3 Plug the cable attached to the AC adapter (2) to the right speaker (3).
- 4 Plug the cable from the left speaker (4) to the speaker L jack on the right speaker.
- 5 Plug the speaker cable (5) to the headphones jack on the port replicator.

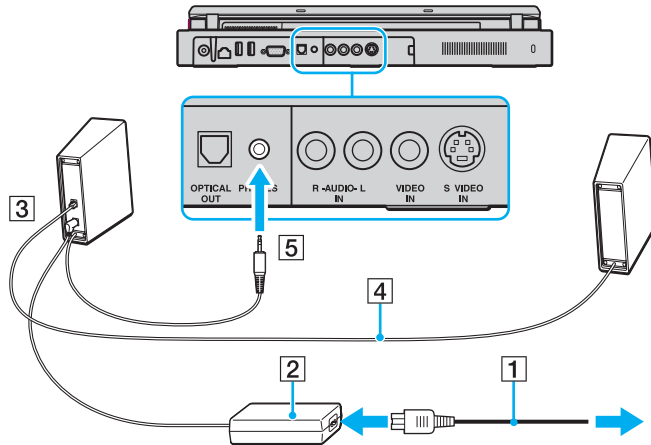

You can also enhance the sound quality of your computer by connecting other external speakers directly to your computer.

## To connect external speakers

- 1 Plug the speaker cable (1) into the headphones jack (2) .
- 2 Plug the other end of the speaker cable to the external speaker (3).
- 3 Turn down the volume of the speakers before you turn them on.

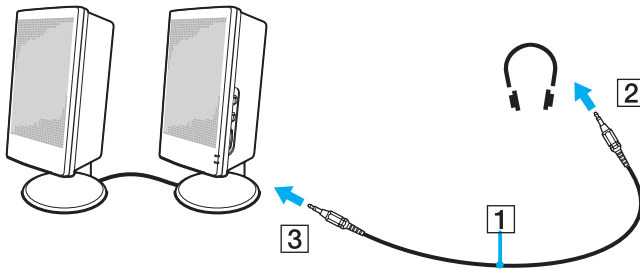

Make sure your speakers are designed for computer use.

**!** Do not place floppy disks on the speakers; their magnetic field may damage the data on the disks.



## *Using the Remote Commander*

A remote commander is delivered with your computer for extended use of the **VAIO Zone** software.

The infrared receiver for communications with the remote commander delivered with VGN-A700 Series models is located on the supplied left external speaker. Make sure to attach your computer to the supplied A/V port replicator and connect the speakers to your computer before using the remote commander.

If your computer is one of VGN-FS600 Series models, you need to connect the supplied external infrared receiver to your computer before using the remote commander.

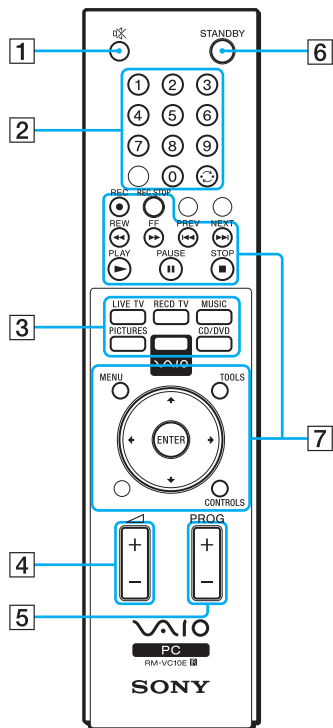

- 1** MUTING button  
Turns off the external speakers. Press the MUTING button to turn on the speakers.
- 2** Channel buttons  
Select the respective channels.
- 3** Direct buttons  
Activate individual features of **VAIO Zone**.
- 4** Volume button  
Increases\* or decreases the speaker volume.
- 5** Channel control button  
Switches the channel in the ascending or descending order.
- 6** STANDBY button  
Puts the system into Standby mode.
- 7** Operation buttons  
Use these buttons for **VAIO Zone** operations.

\* With the remote commander, you can increase the volume only up to the level set by the volume control on the external speaker.

### To connect the external infrared receiver to VGN-FS600 Series models

- 1 Choose the USB port (1) you prefer to use.
  - 2 Plug the external infrared receiver cable (2) into the USB port.
- You can now use your infrared receiver (3).

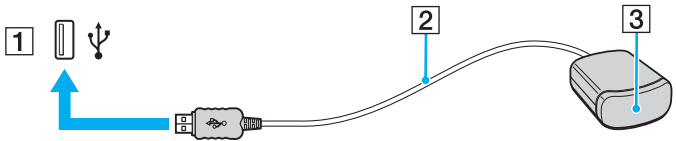

## Connecting an External Display

You can connect an external display to your computer. For example, you can use your computer with a computer display or a projector.

- ❑ **Connecting a Computer Display** ([page 101](#))
- ❑ **Connecting a Multimedia Computer Display** ([page 103](#))
- ❑ **Connecting a TV** ([page 104](#))
- ❑ **Connecting a Projector** ([page 107](#))



Connect the power cord after connecting all other cables.

Connected external displays are used as second screens.

On Windows systems only, you can also use an external display to set up multiple monitors.

## *Connecting a Computer Display*

You can connect a computer display (monitor) either directly to your computer or via the (optional) port replicator.

To connect a computer display

### **VGN-A700 Series models**

- 1 If necessary, plug one end of the display's power cord (1) into the display, and the other end into an AC outlet.
- 2 If you want to connect a VGA monitor, plug the display cable (2) (not supplied) into the monitor (VGA) port (3)  on the computer or on the port replicator.
- 3 If you want to connect a TFT/DVI monitor, plug the display cable (not supplied) into the DVI-D port on the port replicator.

## VGN-FS600 Series models

- 1 If necessary, plug one end of the display's power cord (1) into the display, and the other end into an AC outlet.
- 2 Plug the display cable (2) (not supplied) into the monitor (VGA) port (3) on the computer.

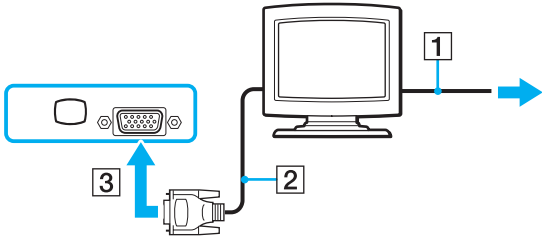

VGN-A700 Series models are equipped with the DVI-D port.

**DVI-D** stands for **Digital Visual Interface - Digital**. It is a type of DVI connector that supports only digital video signals (no analog video signals). It has 24 pins.

A **DVI-I** connector (**Digital Visual Interface - Integrated**) supports digital video and analog video signals. It has 29 pins.





You can not connect a DVI-I to VGA cable to a DVI-D port!

## Connecting a Multimedia Computer Display

You can connect the computer to a multimedia computer display that includes built-in speakers and a microphone.

To connect a multimedia computer display

- 1 Plug the power cord of the multimedia computer display (1) into an AC outlet.
- 2 Plug the display cable (2) (not supplied) into the monitor (VGA) port (3)  on the computer or on the (optional) port replicator.
- 3 Plug the speaker cable (4) into the headphones jack (5)  on the computer.
- 4 Plug the microphone cable (6) into the microphone jack (7)  on the computer.

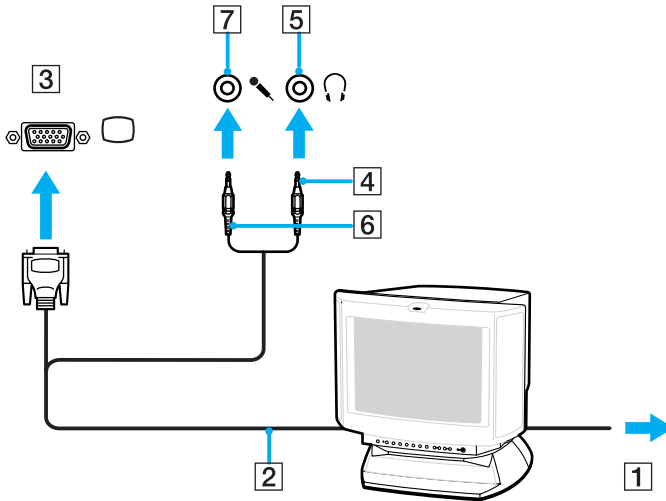

## Connecting a TV

You can connect a TV to VGN-A700 Series models or to the port replicator.

To connect a TV to the computer

- 1 Plug the power cord of the TV (1) into an AC outlet.
- 2 Plug one end of an audio/video cable (2) into the AV Out jack (3) ⇄ on the computer and the other to the TV.
- 3 Switch the input channel of the TV to external input.
- 4 Set up the TV configuration system.

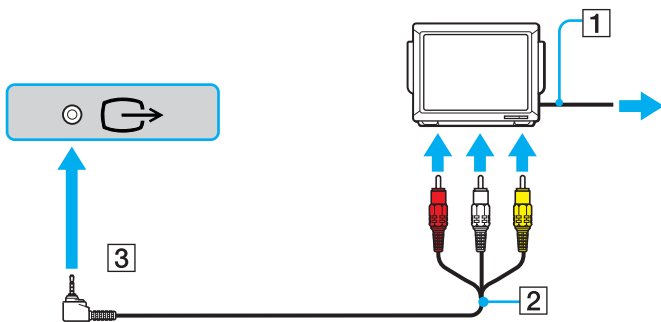

You need to use an AV cable that has a minijack connector on one end and 3 RCA (also called cinch) connectors on the other end. If your TV does not have RCA connectors, but it has a Scart connector, you need an RCA to Scart converter. If your computer has an S-video port, you can use this port as an alternative means of connection.





See the manual supplied with your peripheral for more information on installation and use.

If you insert a DVD in your DVD-ROM drive to watch a video on your TV, the **Fn+F7** key combination might not activate the function to toggle between your LCD and TV.

**Solution:**

- 1 Eject your DVD from your computer.
- 2 Once the DVD is ejected, toggle between your LCD and your TV with the **Fn+F7** key combination.

Your image appears now on both the LCD and the TV. Re-insert your DVD to launch your DVD software.

If the display resolution of your computer is more than 1024 x 768 pixels, a part of the image cannot be displayed on your TV. The hidden area on your TV can be seen by moving the cursor on your computer. If you want to display the full image, change the display resolution of your computer to **1024 x 768** pixels or lower.

## To connect a TV to the port replicator

- 1 Attach the port replicator to your computer.
- 2 Plug one end of an audio/video cable (1) into the Composite Audio Out jacks and the Composite Video Out Jack (2) on the port replicator and the other into the Composite Audio and Video jacks on your TV.  
If your TV has s-video input, you can have better visual quality by outputting image to s-video rather than composite video. In such a case, please plug one end of the S-Video cable (3) into the S Video Out jack (4) on the port replicator and the other end into the S Video jack on the TV. You will still need to connect Composite Audio Out jacks in order to hear sound through TV speakers.
- 3 Switch the input channel of the TV to external input.
- 4 Set up the TV configuration system.

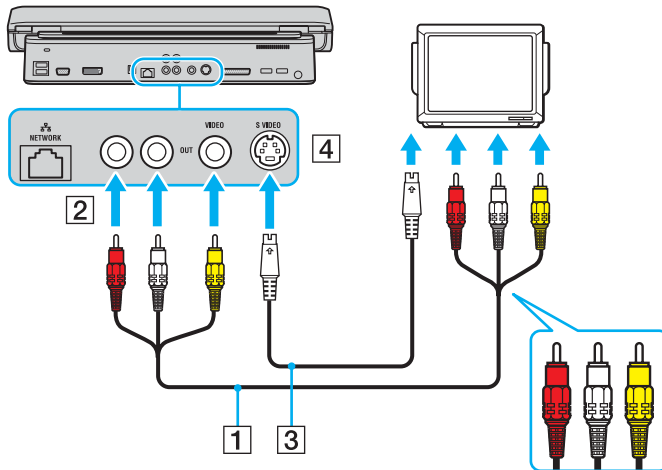

## Connecting a Projector

You can connect a projector (for example, the Sony LCD projector) directly to your computer or via the port replicator.

To connect a projector

- 1 Connect the power cord (1) of the projector into an AC outlet.
- 2 Plug the RGB signal cable (2) into the monitor (VGA) port (3) □ on the computer or on the (optional) port replicator.
- 3 Plug the audio cable (4) (not supplied) into the headphones jack (5) ♪.
- 4 Plug the RGB signal cable and the audio cable into the jack and port on the projector (6).

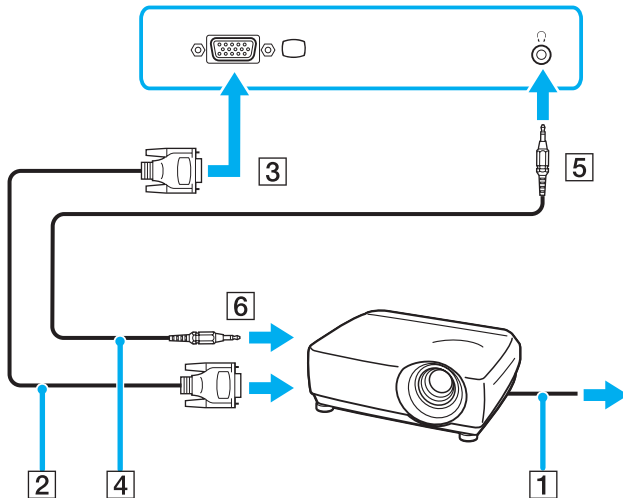

## Selecting Display Modes

You can select which display to be used as the primary monitor when an external display (desktop monitor, etc.) is connected to the computer. The procedure for selecting a display depends on the video controller used in your VAIO computer. See the online **Specifications Sheet** for detailed information on the video controller.

If you want to work on your computer's LCD and the external display at the same time, see **Using the Multiple Monitors Function (page 111)** for more information.

To select a display

### Models with the ATI video controller

- 1 Click **Start** and then **Control Panel**.
- 2 Click **Appearance and Themes**.
- 3 Click **Display**.
- 4 Click the **Settings** tab.
- 5 Click **Advanced**.
- 6 Click the **Displays** tab to select a display.
- 7 Click **Apply** and then **OK**.

## Models with the Intel 915GM video controller

- 1 Click **Start** and then **Control Panel**.
- 2 Click **Appearance and Themes**.
- 3 Click **Display**.
- 4 Click the **Settings** tab.
- 5 Click **Advanced**.
- 6 Click the tab with its name beginning with **Intel(R)**.
- 7 Click **Graphic Properties**.
- 8 Click the **Devices** tab to select a display.
- 9 Click **OK**.



You may not be able to display on your computer's LCD and the external display or projector at the same time, depending on the type of your external display or projector.

Before turning on your computer, turn on the peripheral devices.

## Models with the NVIDIA GeForce Go 6200 video controller

- 1 Click **Start** and then **Control Panel**.
- 2 Click **Appearance and Themes**.
- 3 Click **Display**.
- 4 Click the **Settings** tab.
- 5 Click **Advanced**.
- 6 Click the tab with its name beginning with **GeForce**.
- 7 Select **nView Display Settings** from the left menu.  
To change the current display, select the desired display from the **Current display** drop-down list.  
To display the output on your computer's LCD and the external display at the same time, select **Clone** from the **nView Display mode** drop-down list.  
To specify displays, use the **Primary Display/Secondary Display** drop-down list.
- 8 Click **OK** and then **YES**.

## Using the Multiple Monitors Function

The Multiple Monitors function allows you to distribute portions of your desktop across separate displays. For example, if you have an external display attached to the monitor (VGA) port, your computer's LCD and the external display can function as a single desktop.

You can move the cursor from one display to the other. This allows you to drag objects, such as an open application window or a toolbar, from one display to the other.

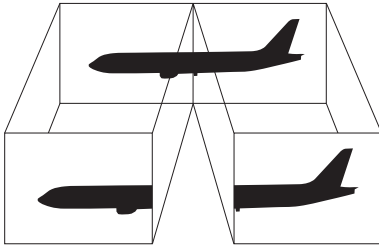

Your external display or TV may not support the Multiple Monitors function.

Certain software applications may not be compatible with Multiple Monitors settings.

Make sure that your computer does not enter **Standby** or **Hibernate** mode while you are using Multiple Monitors mode; otherwise your computer may not return to **Normal** mode.

If you set different colors on each display, do not divide one single window on two displays; otherwise your software may not work properly.

Set fewer colors or a lower resolution for each display.

To select the Multiple Monitors mode

! To find which video controller your computer includes, see the online **Specifications** sheet.

### Models with the ATI video controller

- 1 Click **Start** and then **Control Panel**.
- 2 Click **Appearance and Themes**.
- 3 Click **Display**.
- 4 Select the **Settings** tab.
- 5 Click the monitor icon marked **2**.
- 6 Select the **Extend my Windows desktop onto this monitor** option.
- 7 Click **Apply** and then **OK**.  
If the **Monitor Settings** window appears, click **YES**.



## Models with the NVIDIA video controller

- 1 Click **Start** and then **Control Panel**.
- 2 Click **Appearance and Themes**.
- 3 Click **Display**.
- 4 Select the **Settings** tab.
- 5 Click **Advanced**.
- 6 Click the tab with its name beginning with **GeForce**.
- 7 Select **nView Display Settings** from the left menu.
- 8 Select **Dualview** from the **nView Display Mode** drop-down list.
- 9 Select **Laptop Display** from the **Primary display** drop-down list.
- 10 Click **OK**.

## Models with the Intel video controller

- 1 Right-click on the desktop to display the context menu.
- 2 Point to **Graphics Options** and click **Graphics Properties**.
- 3 Select the **Devices** tab.
- 4 Click **Extended Desktop**.  
To change the primary and secondary device settings, use the **Primary Device** and **Secondary Device** drop-down lists under **Extended Desktop Settings**.
- 5 Click **OK**.  
If the **Monitor Settings** window appears, click **OK**.



To deactivate the Multiple Monitors mode, deselect the check box in Step 6.



On VGN-A700 Series models, you can also select and deactivate the Multiple Monitors mode just by pressing the **S1** button if you have changed its assignment to **Multiple Monitors** with **VAIO Control Center**. For details on changing the button assignment, see **Setting Up Your Computer with VAIO Control Center (page 131)**.



Additionally, you can set the display colors and resolution for each display and customize the Multiple Monitors mode.

## Connecting an External Microphone

If you need to use a sound input device (for example, to chat on the Internet) you need to plug in an external microphone.

To connect an external microphone

Plug the microphone cable (1) into the microphone jack (2) .

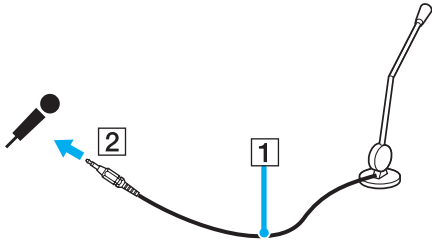

Make sure your microphone is designed for computer use.

## Connecting a Universal Serial Bus (USB) Device

To prevent your computer and/or USB devices from damage, observe the following:

- ❑ When moving your computer with USB devices connected, avoid any shock or force to the USB ports.
- ❑ Do not put your computer into a bag or carrying case when it has USB devices connected.

### Connecting a USB Mouse

To connect a USB mouse

- 1 Choose the USB port (1)  you prefer to use.
- 2 Plug the USB mouse cable (2) into the USB port.  
You can now use your USB mouse (3).

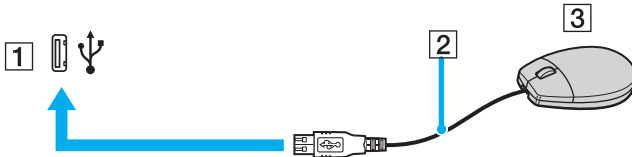

The VAIO USB mouse software driver is preinstalled on your computer. As a result, you only need to plug the USB mouse into the USB port and you can start working.

## Connecting a USB Floppy Disk Drive

You can purchase a USB floppy disk drive and connect it to your computer.

To connect a USB floppy disk drive

- 1 Choose the USB port  you prefer to use.
- 2 Plug the USB floppy disk drive cable into the USB port. The VAIO logo on the disk drive should be facing up. Your USB floppy disk drive is now ready for use.

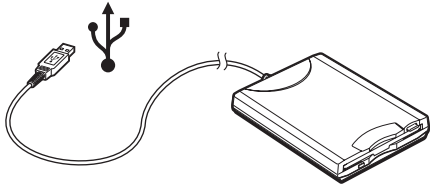

**!** When using a USB floppy disk drive, do not apply force on the USB port. This may cause a malfunction.

## *Disconnecting a USB floppy disk drive*

You can disconnect a USB floppy disk drive when the computer is on or off. Disconnecting the drive when the computer is in a power saving mode (**Standby** or **Hibernate**) may cause the computer to malfunction.

If your computer is off, you can unplug the USB cable directly from the computer.

### To disconnect a USB floppy disk drive

- 1 Close all programs accessing the floppy disk drive.
- 2 Double-click the **Safely Remove Hardware** icon on the taskbar.  
The **Safely Remove Hardware** window appears.
- 3 Select the floppy disk drive you want to unplug.
- 4 Click **Stop**.  
The **Stop a Hardware device** window appears.
- 5 Make sure the floppy disk drive is selected, and click **OK**. A message appears stating it is now safe to remove the hardware device.
- 6 Remove the floppy disk drive from the computer.

## Connecting a Printer

You can connect a Windows-compatible printer to your computer to print documents.

### Connecting a Printer Using the USB Port

You can connect a USB printer compatible with your version of Windows to your computer.

To connect a printer using the USB port

- 1 Plug the printer power cord into an AC outlet (1).
- 2 Choose the USB port (3)  you prefer to use.
- 3 Plug one end of a USB printer cable (2) into the USB port and the other end to your printer.

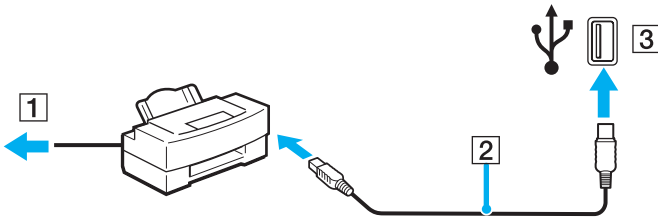

## Connecting a Printer Using the Printer Port

To connect a printer using the printer port

- 1 Plug the printer power cord (1) into an AC outlet.
- 2 Plug the printer cable (2) supplied with your printer into the printer port (3)  on the computer or on the (optional) port replicator\*.

\* Depending on the model you purchased. See the online **Specifications** sheet for details on your model.

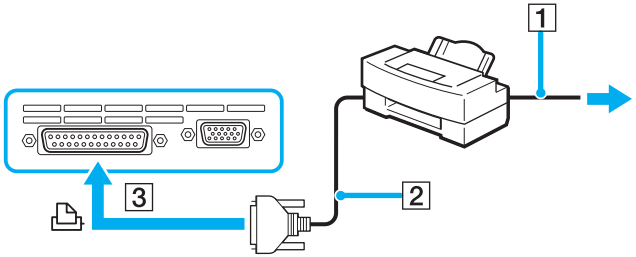

Before connecting the printer, turn off your computer and the printer, and unplug the AC adapter and the power cord.



## Connecting an i.LINK Device

### Notes on connecting i.LINK devices

- ❑ Your computer includes an i.LINK (IEEE1394) port, which you can use to connect to an i.LINK device such as a digital video camera recorder or to connect two VAIO computers in order to copy, delete or edit files.
- ❑ The i.LINK port of your computer does not supply power to external devices generally powered by i.LINK ports.
- ❑ The i.LINK port supports transfer rates up to 400 Mbps; however, the actual transfer rate depends on the transfer rate of the external device.
- ❑ i.LINK cables compatible with your VAIO computer include cables with the following part numbers:  
VMC-IL4415 (a 1.5 meter cable with a 4-pin connector at each end), VMC-IL4408 Series (a 0.8 meter cable with a 4-pin connector at each end).
- ❑ The optional i.LINK cables may not be available, depending on your country or region.
- ❑ An i.LINK connection with other compatible devices is not fully guaranteed.
- ❑ The i.LINK connection varies depending on the software applications, operating system and i.LINK compatible devices you use. Refer to the manual that came with your software for more information.
- ❑ Check the working conditions and OS compatibility of i.LINK-compatible PC peripherals (for example, an HDD or CD-RW drive) before you connect them to your computer.

## Connecting a Digital Video Camera Recorder

To connect a digital video camera recorder

- 1 Plug one end of the i.LINK cable (1) into the i.LINK port (2) on the computer and the other end into the DV In/Out ports (3) on the digital video camera recorder.
- 2 Launch the **DVgate Plus** software.

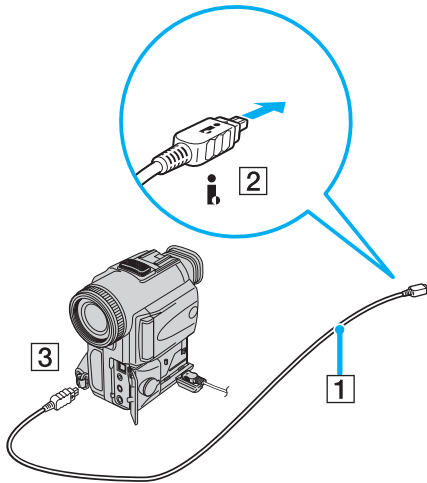

On Sony digital video cameras, ports labeled **DV Out**, **DV In/Out** or **i.LINK** are i.LINK-compatible.

The Sony digital video camera recorder shown here is an example; your digital video camera recorder may need to be connected differently.

You cannot access the pictures stored on a Memory Stick media when using an i.LINK connection.

## Connecting to a Network (LAN)

You can connect your computer to 1000BASE-T/100BASE-TX/10BASE-T-type networks\* via an Ethernet network cable. Connect one end of an optional network cable to the Network (Ethernet) port on the bottom panel of your computer and the other end to your network. For detailed settings and devices needed to connect to the network, see your Network Administrator.

\* Depending on the model you purchased. See the online **Specifications** sheet to see whether your model supports a 1000BASE-TX connection.

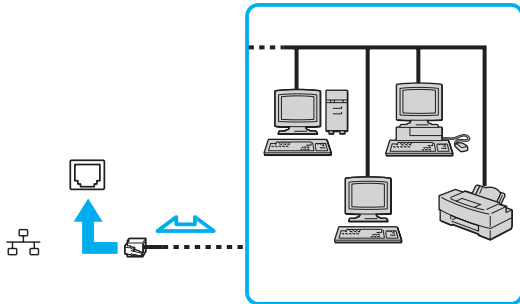

Your computer can be connected to the network with the default settings.

If the main unit is docked, you can only use the Network (Ethernet) port on the port replicator.

! Network and telephone lines cannot be connected to the Network (Ethernet) port on your computer. If the following connectors are connected to the telephone lines mentioned below, high electric current to the connectors may cause damage, overheating or fire.

- Home (intercom speakerphone) or business-use telephone lines (multi-line business telephone)
- Network lines such as 1000BASE-T, 100BASE-TX, and 10BASE-T lines (depending on the model you purchased)
- Public telephone subscriber line
- PBX (private branch exchange)
- Lines other than those mentioned above

! Do not plug a phone cable into your computer network port.

## *Customizing Your VAIO Computer*

This section briefly describes how to change the main settings of your computer.

- ❑ **Setting the Password** ([page 126](#))
- ❑ **Setting Up Your Computer with VAIO Control Center** ([page 131](#))
- ❑ **Using the Power Saving Modes** ([page 133](#))
- ❑ **Managing Power with VAIO Power Management** ([page 138](#))

## *Setting the Password*

Use one of the BIOS functions to set the password.

Once you have set the password, you will have to enter the password after the VAIO logo appears. In this way, you can protect your computer from unauthorized access.

! You cannot start your computer without entering the password. Make sure not to forget the password.

If you forget the password and need assistance to cancel it, a cancellation fee will be charged.

## Adding the Password

To add the password

### VGN-A700 Series models

- 1 Turn on your computer.
- 2 Press the **F2** key when the **VAIO** logo appears.  
The BIOS setup screen appears. If not, press the **F2** key several times.
- 3 Use the **←** or **→** key to select **Security** and press the **Enter** key.  
The password entry screen appears.
- 4 Enter the password **twice** and press the **Enter** key.  
The password should be **up to 7 alphanumeric characters** long.
- 5 When **Password installed** appears, press the **Enter** key.



The following is to configure your computer to prompt password entry when you turn on your computer or display the BIOS setup screen.

- 6 Select **Password when Power ON** under **Security**.  
Press the **Enter** key, use the **↑** or **↓** key to select **Enabled**, and then press the **Enter** key.
- 7 Use the **←** or **→** key to select **Exit** and then **Exit (Save Changes)**; and press the **Enter** key.  
On the **Save configuration changes and exit setup?** screen, confirm that **OK** is selected and then press the **Enter** key.

## VGN-FS600 Series models

- 1 Turn on your computer.
- 2 Press the **F2** key when the **VAIO** logo appears.  
The BIOS setup screen appears.
- 3 Use the **←** or **→** key to select **Security** to display another screen, select **Set Machine Password**, and then press the **Enter** key.
- 4 On the password entry screen, enter the password **twice** and press the **Enter** key.  
The password should be **up to 7 alphanumeric characters** long.



The following is to configure your computer to prompt password entry when you turn on your computer or display the BIOS setup screen.

- 5 Select **Password When Power ON** under **Security**.  
Press the space bar to change the setting from **Disabled** to **Enabled**.
- 6 Use the **←** or **→** key to select **Exit** and then **Exit (Save Changes)**; and press the **Enter** key.  
On the **Setup Confirmation** screen, confirm that **Yes** is selected and then press the **Enter** key.



## Changing/Removing the Password

To change or remove the password

### VGN-A700 Series models

- 1 Turn on your computer.
- 2 Press the **F2** key when the **VAIO** logo appears.  
The BIOS setup screen appears. If not, press the **F2** key several times.
- 3 Enter the current password for **Enter CURRENT Password**:
- 4 Use the **←** or **→** key to select **Security** to display another screen, select **Set Machine Password**, and then press the **Enter** key.  
The password entry screen appears.
- 5 Enter a new password **twice** and press the **Enter** key.  
Enter a new password both for **Enter New Password** and **Confirm New Password**.  
When **Password installed** appears, press the **Enter** key.  
To remove the password, leave **Enter New Password** blank and press the **Enter** key.
- 6 Use the **←** or **→** key to select **Exit** and then **Exit (Save Changes)**; and press the **Enter** key.  
On the **Save configuration changes and exit setup?** screen, confirm that **OK** is selected and then press the **Enter** key.

## VGN-FS600 Series models

- 1 Turn on your computer.
- 2 Press the **F2** key when the **VAIO** logo appears.  
The BIOS setup screen appears. If not, press the **F2** key several times.
- 3 Enter the current password for **Enter Password**:
- 4 Use the **←** or **→** key to select **Security** to display another screen, select **Set Machine Password**, and then press the **Enter** key.
- 5 On the password entry screen, enter the **current password once** and then a **new password twice**; and press the **Enter** key.  
To remove the password, leave **Enter New Password** and **Confirm New Password** blank and press **Enter**.
- 6 Use the **←** or **→** key to select **Exit** and then **Exit (Save Changes)**; and press the **Enter** key.  
On the **Setup Confirmation** screen, confirm that **Yes** is selected and then press the **Enter** key.

## Setting Up Your Computer with VAIO Control Center

The **VAIO Control Center** utility allows you to consult system information and specify preferences for system behavior.

To use VAIO Control Center

- 1 Click **Start**, point to **All Programs**, and click **VAIO Control Center**.  
The **VAIO Control Center** window appears.

<i>Control item</i>	<i>Description</i>
System Information	Displays the information about your operating system, the hardware configuration, and software information.
Initial Setting	You can specify the order in which the system checks for devices containing a bootable system when it starts.
Built-in Pointing Device	You can enable or disable the built-in pointing device.
S Button	You can change the functions assigned to the computer's S buttons. Available pre-defined assignments are as follows. For VGN-A700 Series models: <b>Stand by, Hibernate, External Display, Launch Application, VAIO Zone<sup>*1</sup>, Multiple Monitors</b> For VGN-FS600 Series models: <b>Muting<sup>*1</sup>, Stand by, Hibernate, Max Brightness, External Display<sup>*2</sup>, Launch Application, VAIO Zone, SSMS Audio Filter, Multiple Monitors</b>
Plug and Display	You can specify settings for automatic output to the external display.
Automatic Brightness <sup>*3</sup>	You can specify settings for the auto luminance sensor. The auto luminance sensor senses the brightness from outside then the display brightness is adjusted accordingly.
Station and Port replicator	You can specify the behavior when station or port replicator is connected to your computer.

<sup>\*1</sup> Default S1 button assignment

<sup>\*2</sup> Default S2 button assignment

<sup>\*3</sup> On selected models only.

- 2 Select the desired control item and change the settings.
- 3 Once finished, click **OK**.  
The setting of the desired item has been changed.



For more information about each option, click **Help** on the **VAIO Control Center** window to display the help file.

Some of the control items will not be visible if you open **VAIO Control Center** as a limited user.

## Using the Power Saving Modes

When you use a battery as the power source for your computer, you can take advantage of power management settings to conserve battery life. In addition to the normal operating mode, which allows you to turn off specific devices, your computer has two distinct power saving modes: **Standby** and **Hibernate**. When using battery power, you should be aware that the computer automatically enters **Hibernate** mode when the remaining battery charge becomes short, regardless of the power management setting you select.



If the battery level falls below 10 percent, you should either attach the AC adapter to recharge the battery or shut down your computer and install a fully charged battery.

## Using Normal Mode

This is the normal state of your computer when it is in use. The green power indicator light is on in this mode. To save power while not working, you can turn off a specific device such as the LCD or the hard disk.

## Using Standby Mode

Standby mode turns off the LCD screen and sets the hard disk and the CPU to a low power consumption mode. The amber power light flashes in this mode.

To activate Standby mode

- 1 Click **Start** and then **Turn Off Computer**.
- 2 Click **Stand By**.

To return to Normal mode

Press any key.



If you press the power button for more than four seconds, the computer will switch off automatically. You will lose any unsaved data.

When the computer is in **Standby** mode, you cannot insert a disc.

The computer comes out of **Standby** mode quicker than out of **Hibernate** mode.

**Standby** mode uses more power than **Hibernate** mode.

If the battery runs down when your computer enters **Standby** mode, you will lose any unsaved data. Going back to the previous work state is impossible.

To avoid loss of data, you should save your data frequently.

If the computer is not used for 25 minutes, it will enter **Standby** mode. To avoid this, you can change the **Standby** mode settings.

## To change the Standby mode settings

- 1 Right-click the **power status** icon on the taskbar.
- 2 Select **Adjust Power Properties**.  
The **Power Options Properties** window appears.
- 3 Select the **Power Schemes** tab.
- 4 Change the settings in **Settings for VAIO optimized power scheme**.

## Using Hibernate Mode

In **Hibernate** mode, the state of the system is saved on the hard disk and power is turned off. Even when the battery runs down, no data will be lost. The power indicator light is off in this mode.

To activate **Hibernate** mode

Press the **Fn+F12** keys.

The **Hibernating** screen appears and the computer enters **Hibernate** mode.

Alternatively,

- 1 Click **Start** and then **Turn Off Computer**.
- 2 Hold down the **Shift** key and click **Hibernate**.

To return to Normal mode

Turn on the computer by pressing the power button.

The computer returns to its previous state.





If you press the power button for more than four seconds, the computer will switch off automatically.

If you do not use the AC adapter for a long period of time, put your computer into **Hibernate** mode. This power saving mode saves you the time of shutting down in the normal way.

When the computer is in **Hibernate** mode, you cannot insert a disc.

**Hibernate** mode requires more time than **Standby** mode to be activated.

It takes more time to return to **Normal** mode from **Hibernate** mode than from **Standby** mode.

**Hibernate** mode uses less power than **Standby** mode.

Do not move the computer until its power indicator turns off.

## *Managing Power with VAIO Power Management*

Power management helps you to set up power schemes for running on AC power or batteries to suit your requirements for power consumption.

**VAIO Power Management** is a software application developed exclusively for VAIO computers. With this software application, you can enhance the Windows power management functions to ensure better operations of your computer and for longer battery life.

## Activating VAIO Power Management

When you start the computer, a **power status** icon appears on the taskbar. This icon indicates what kind of power source you are using at that time, for example, AC power. If you double-click this icon, the **Power Meter** window appears showing you the power status.

VAIO Power Management functionalities are added to the Windows **Power Options Properties**.

To activate VAIO Power Management

- 1 Right-click the **power status** icon on the taskbar.
- 2 Select **Adjust Power Properties**.  
The **Power Options Properties** window appears.
- 3 Select the **VAIO Power Management** tab.

To restore the default settings

- 1 On the **VAIO Power Management** tab, click **Advanced**.  
The **VAIO Power Management** window appears.
- 2 Click **Reset by default**.  
The **Confirm** window appears.
- 3 Select **Restore all power schemes to the original factory default settings**.
- 4 Click **OK**.  
The default settings are restored for all the power scheme options.

## Activating VAIO Power Management Power Schemes

**VAIO Power Management** provides several predefined **power schemes**. Each power scheme consists of a group of power management settings that are designed to meet specific power management goals, ranging from maximum power management to no power management.

To activate a VAIO Power Management power scheme

- 1 Right-click the **power status** icon on the taskbar.
- 2 Select **Adjust Power Properties**.  
The **Power Options Properties** window appears.
- 3 Select the **Power Schemes** tab.
- 4 Select a power scheme from the **Power schemes** drop-down list.
- 5 If you now select the **VAIO Power Management** tab, you see that the selected power scheme appears to the right of **Power Scheme**.
- 6 If necessary, you can change the items in the list, for example, the brightness of the LCD.
- 7 Click **OK**.  
The power scheme has been activated.



You must have computer administrator rights on your computer to set up a power scheme.

For more information on **VAIO Power Management** and **Power Schemes**, see the help guide of the **VAIO Power Management** software.

<i>Power Scheme</i>	<i>Description</i>
Power Management Off	Turns off all power management features such as <b>Standby</b> and <b>Hibernate</b> modes.
VAIO Optimized	The default power management state for either power source.
VAIO Maximum Battery	Provides power saving features to provide maximum battery life and good performance when battery power is in use. It reduces the brightness of the display and puts the system into <b>Standby</b> mode after a specified time period.
VAIO Ultimate Battery	Extends the <b>VAIO Maximum Battery</b> by completely disabling the optical disc drive.



If you have a mobile computer, a CPU control icon may appear on the taskbar. The CPU control icon indicates the CPU control status (Performance, Adaptive, Battery Life, Degrade). To display the icon, click the **Advanced** button on the **VAIO Power Management** tab. Select the **Show CPU status icon in the taskbar** box and then click **OK**.

For more details on the CPU control icon, see the online help file (**Other Information - Icons on the Notification Area**).

## Upgrading Your VAIO Computer

Your computer and memory modules use high precision components and electronic connectors technology. To avoid the invalidation of your guarantee due to mishandling, we recommend that:

- You contact your dealer to install a new memory module.
- You do not install it yourself, if you are not familiar with upgrading memory on a computer.
- You do not touch the connectors or open the memory panel.

For the type of module and amount of memory installed on your computer, refer to the online **Specifications** sheet.

For assistance, contact an authorized Sony Service Center. To find the nearest center or agent, visit the Sony online support Web site.

## Adding and Removing Memory

If you want to expand the functionality of your computer, you can increase the memory by installing optional memory modules. Before you upgrade your computer's memory, read the notes and procedures in the following pages. The number of available slots depends on the configuration of your computer.

### Notes on adding/removing memory modules

- ❑ Be careful when changing memory. Improper installation of memory modules may cause damage to your system. This damage may void your manufacturer's warranty.
- ❑ Only use memory modules that are compatible with your computer. If a memory module is not detected by your computer or Windows becomes unstable, contact your sales dealer or the manufacturer of your memory module.
- ❑ Electrostatic discharge can damage electronic components. Before touching a memory module, ensure the following:
  - ❑ The procedures described in this document assume familiarity with the general terminology associated with personal computers and with the safety practices and regulatory compliance required for using and modifying electronic equipment.
  - ❑ Turn off the computer and disconnect the system from its power source (that is, battery or AC adapter) and from any telecommunication links, networks, or modems before you open the computer. Failure to do so may result in personal injury or equipment damage.
  - ❑ Electrostatic Discharge (ESD) can damage memory modules and other components. Install the memory module only at an ESD workstation. If such a station is not available, do not work in a carpeted area, and do not handle materials that produce or hold static electricity (cellophane wrappers, for example). Ground yourself by maintaining contact with an unpainted metal portion of the chassis while performing the procedure.
  - ❑ Do not open the memory module package until you are ready to change the module. The package protects the module from ESD.
- ❑ Use the special bag delivered with the memory module or wrap the module in aluminum foil to protect it from electrostatic discharge.

- Introducing any liquids or any foreign substances or objects into the memory slots, or other internal components of the computer, will result in damage to the computer and any repair costs will not be covered by the warranty.
- Do not place the memory module in places subject to:
  - Heat sources such as radiators or air ducts
  - Direct sunlight
  - Excessive dust
  - Mechanical vibration or shock
  - Strong magnets or speakers that are not magnetically shielded
  - Ambient temperature of more than 95°F (35°C) or less than 41°F (5°C)
  - High humidity
- Handle the memory module with care. To avoid injuries to your hands and fingers, do not touch the edges of the components and circuit boards inside your computer.



## Removing and Installing a Memory Module

### VGN-A700 Series models

To change or add a memory module to the memory module slot on the bottom of the computer

- 1 Shut down your computer and disconnect all peripheral devices.
- 2 Unplug the computer and remove the battery.
- 3 Wait until the computer cools down.
- 4 Unscrew the central screw on the bottom of the computer and remove the memory module compartment cover.

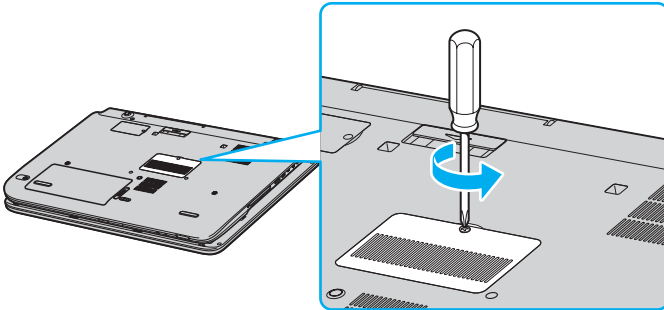

- 5 Touch a metal object (such as the connector panel on the back of the computer) to discharge static electricity.

**6** Remove the memory module:

- Pull the tabs in the direction of the arrows (1).  
The memory module is released.

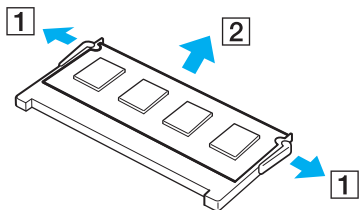

- Make sure that the memory module tilts up and then pull it out in the direction of the arrow (2).

**7** Remove the new memory module from its packaging.

**8** Install the memory module.

- Slide the memory module into the slot.

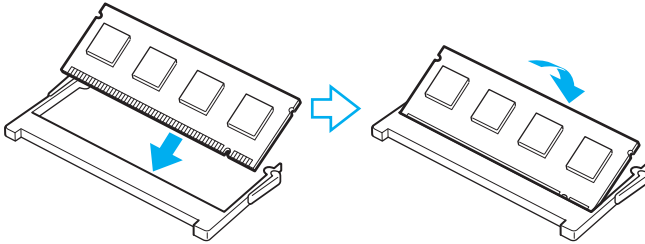

- Push in the memory module until it clicks into place.

**!**

Do not touch any other components on the motherboard.

**9** Close the memory module compartment cover and then tighten the screws on the bottom of the computer.**10** Reinstall the battery pack and turn on the computer.

To change or add a memory module to the memory module underneath the keyboard

- 1 Shut down your computer and disconnect all peripheral devices.
- 2 Unplug the computer and remove the battery pack.
- 3 Wait until the computer cools down.
- 4 Unscrew the two screws next to the memory slot.

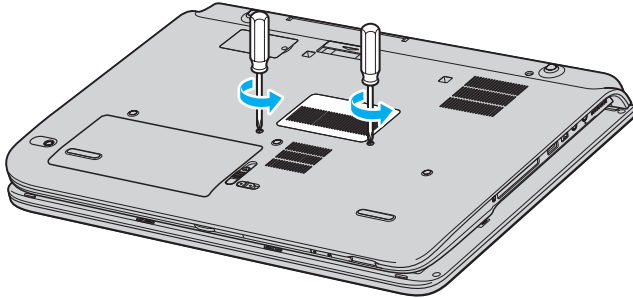

- 5 Turn over the computer upside down and open the LCD screen lid.

- 6 Introduce a sharp object (such as a fine screwdriver) between the keys indicated on the picture (1) and push gently upwards.

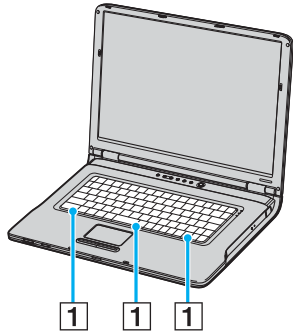

- 7 Lift the keyboard from the touch pad side, turn it over the indicators, and gently prop it up against the LCD display. Be careful not to detach the cable when lifting the keyboard.

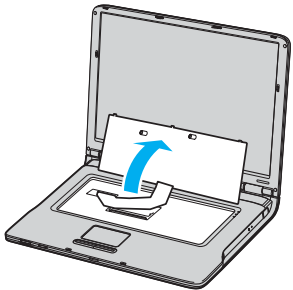

- 8 Touch a metal object (such as the connector panel on the back of the computer) to discharge static electricity.
- 9 Remove the memory module:
  - ❑ Pull the tabs in the direction of the arrows (1).  
The memory module is released.

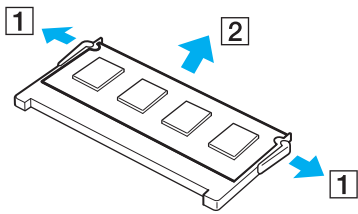

- ❑ Make sure that the memory module tilts up and then pull it out in the direction of the arrow (2).
- 10 Remove the new memory module from its packaging.

## 11 Install the memory module.

- ❑ Slide the memory module into the slot.

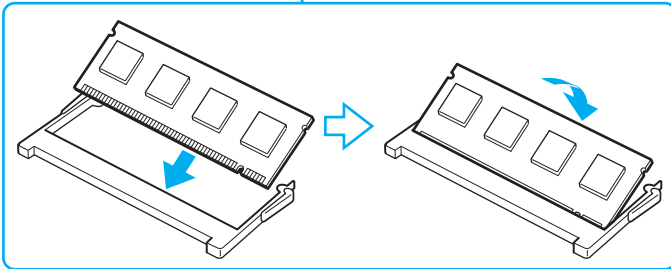
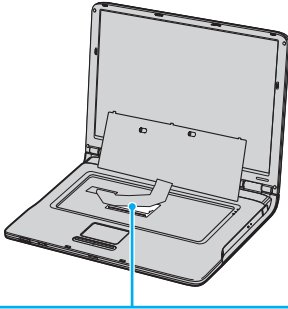

- ❑ Push in the memory module until it clicks into place.



Do not touch any other components on the motherboard.

**12** Gently replace the keyboard and then press it into the computer.

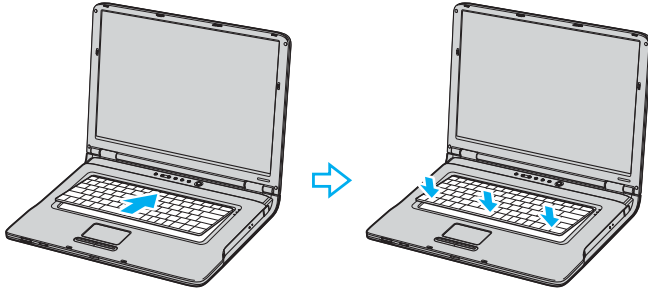

**13** Close the LCD screen lid and turn over the computer upside down.

**14** Close the memory module compartment cover and then tighten the screws on the bottom of the computer.

**15** Reinstall the battery and turn on the computer.



## VGN-FS600 Series models

To change or add a memory module

- 1 Shut down your computer and disconnect all peripheral devices.
- 2 Unplug the computer and remove the battery pack.
- 3 Wait until the computer cools down.
- 4 Unscrew the screw (indicated by the arrow below) on the bottom of the computer and remove the memory module compartment cover.

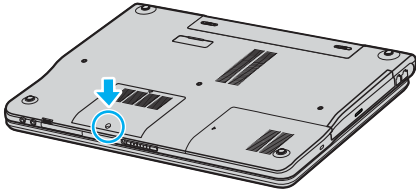

- 5 Touch a metal object (such as the connector panel on the back of the computer) to discharge static electricity.

**6** Remove the memory module:

- Pull the tabs in the direction of the arrows (1).  
The memory module is released.

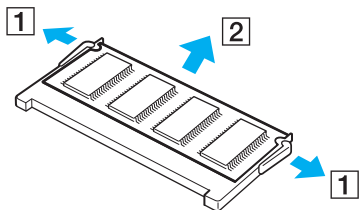

- Make sure that the memory module tilts up and then pull it out in the direction of the arrow (2).

**7** Remove the new memory module from its packaging.

- 8 Slide the memory module into the memory module slot and push it in until it clicks into place.

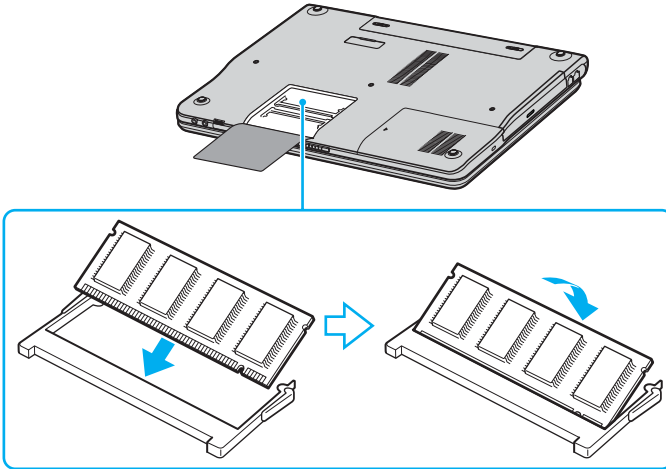

**!**  
Do not touch any other components on the motherboard.

Do not damage the inner film cover equipped for module protection.

- 9 Replace the memory module compartment cover.
- 10 Tighten the screw on the bottom of the computer.
- 11 Reinstall the battery and turn on the computer.

## Viewing the Amount of Memory

To view the amount of memory

- 1 Turn on the computer.
- 2 Click **Start**, point to **All Programs**, and click **VAIO Control Center**.
- 3 Double-click the **System Information** folder in the **VAIO Control Center** window.
- 4 Double-click the **System Information** icon in the **System Information** folder.  
You can view the amount of system memory. If the additional memory does not appear, repeat the whole procedure and restart the computer.

## Precautions

This section describes safety guidelines and precautions to help you protect your computer from potential damage.

- ❑ **On Handling the LCD Screen** ([page 158](#))
- ❑ **On Using the Power Source** ([page 159](#))
- ❑ **On Handling Your Computer** ([page 160](#))
- ❑ **On Handling Floppy Disks** ([page 162](#))
- ❑ **On Handling Discs** ([page 163](#))
- ❑ **On Using the Battery Pack** ([page 164](#))
- ❑ **On Using Headphones** ([page 165](#))
- ❑ **On Handling Memory Stick Media** ([page 165](#))
- ❑ **On Handling the Hard Disk** ([page 166](#))

## *On Handling the LCD Screen*

- ❑ Do not leave the LCD facing the sun. This could damage the LCD. Be careful when using the computer near a window.
- ❑ Do not scratch the LCD or exert pressure on it. This could cause a malfunction.
- ❑ Using the computer in low temperature conditions may produce a residual image on the screen. This is not a malfunction. When the computer returns to normal temperature, the screen returns to normal.
- ❑ A residual image may appear on the screen if the same image is displayed for a lengthy period of time. The residual image disappears in a while. You can use a screen saver to prevent residual images.
- ❑ The screen becomes warm during operation. This is normal and does not indicate a malfunction.
- ❑ The LCD is manufactured using high-precision technology. You may, however, see tiny black points and/or bright points (red, blue, or green) that continuously appear on the LCD. This is a normal result of the manufacturing process and does not indicate a malfunction.
- ❑ Avoid rubbing the LCD screen. This could damage the screen. Use a soft, dry cloth to wipe the LCD screen.

## *On Using the Power Source*

- ❑ See the online **Specifications** sheet to check the power operation of your computer.
- ❑ Do not share the AC outlet with other power-consuming equipment, such as a photocopier or shredder.
- ❑ You can purchase a power strip with a surge protector. This device prevents damage to your computer caused by sudden power surges, in an electrical storm, for example.
- ❑ Do not place heavy objects on the power cord.
- ❑ To disconnect the cord, pull it out by the plug. Never pull the cord itself.
- ❑ Unplug your computer from the AC outlet if you are planning to not use the computer for a long time.
- ❑ Make sure that the AC outlet is easily accessible.
- ❑ When the AC adapter is not used, unplug it from the AC outlet.
- ❑ Use the AC adapter that comes with your computer or genuine Sony products. Do not use any other AC adapter as it may cause a malfunction.

## *On Handling Your Computer*

- ❑ Clean the cabinet with a soft cloth, which is dry or lightly moistened with a mild detergent solution. Do not use any type of abrasive pad, scouring powder, or solvent such as alcohol or benzine, as these may damage the finish of your computer.
- ❑ If you drop a solid object or any liquid onto the computer, shut down your computer and then unplug it. You may want to have the computer checked by qualified personnel before operating it again.
- ❑ Do not drop the computer or place heavy objects on top of the computer.
- ❑ Do not place your computer in a location subject to:
  - ❑ Heat sources, such as radiators or air ducts
  - ❑ Direct sunlight
  - ❑ Excessive dust
  - ❑ Moisture or rain
  - ❑ Mechanical vibration or shock
  - ❑ Strong magnets or speakers that are not magnetically shielded
  - ❑ Ambient temperature of more than 95°F (35°C) or less than 41°F (5°C)
  - ❑ High humidity
- ❑ Do not place electronic equipment near your computer. The electromagnetic field of your computer may cause a malfunction.
- ❑ Provide adequate air circulation to prevent internal heat from building up. Do not place your computer on porous surfaces such as rugs or blankets, or near material such as curtains or draperies that may block its ventilation slots.
- ❑ The computer uses high-frequency radio signals and may cause interference to radio or TV reception. If this occurs, relocate the computer a suitable distance away from the set.
- ❑ Use only specified peripheral equipment and interface cables; otherwise, problems may occur.
- ❑ Do not use cut or damaged connection cables.



- ❑ If the computer is brought directly from a cold location to a warm one, moisture may condense inside your computer. In this case, allow at least one hour before turning on your computer. If any problems occur, unplug your computer and contact an authorized Sony Service Center. To find the nearest center or agent, visit the Sony online support Web site.
- ❑ Make sure you disconnect the power cord before cleaning the computer.
- ❑ To avoid losing data if your computer is damaged, back up your data regularly.

## *On Handling Floppy Disks*

- Do not open the shutter manually or touch the surface of the floppy disk.
- Keep floppy disks away from magnets.
- Keep floppy disks away from direct sunlight and other sources of heat.
- Keep the floppy disk away from any liquid. Do not let the floppy disk get wet. When you are not using the floppy disk, always remove it from the floppy disk drive and use a storage case.
- If the floppy disk comes with a label, make sure that the label is properly attached. If the edge of the label is curled up, the label may stick to the inside of the floppy disk drive and cause a malfunction or damage your floppy disk.

## On Handling Discs

- ❑ Do not touch the surface of the disc.
- ❑ Do not drop or bend the disc.
- ❑ Fingerprints and dust on the surface of a disc may cause read errors. Always hold the disc by its edges and central hole, as shown below:

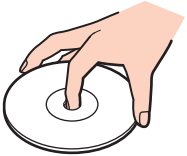

- ❑ Proper care of the disc is essential to its continuous reliability. Do not use solvents (such as benzene, thinner, alcohol, commercially available cleaners, or anti-static spray) which may cause damage to the disc.
- ❑ For normal cleaning, hold the disc by its edge and use a soft cloth to wipe the surface from the center out.
- ❑ If the disc is badly soiled, moisten a soft cloth with water, wring it out well, and use it to wipe the surface of the disc from the center out. Wipe off any remaining moisture with a dry soft cloth.
- ❑ Never put stickers on discs. This will affect the use of the disc irreparably.

## *On Using the Battery Pack*

- ❑ Do not leave the battery pack in temperatures above 140°F (60°C), such as in a car parked in the sun or under direct sunlight.
- ❑ Battery life is shorter in a cold environment. This is due to decreased battery efficiency at low temperatures.
- ❑ Charge the batteries at temperatures between 18°F to 86°F (10°C to 30°C). Lower temperatures require a longer charging time.
- ❑ This computer is designed to operate only with genuine Sony batteries.
- ❑ While the battery is in use or being charged, the battery pack heats up. This is normal and is not cause for concern.
- ❑ Keep the battery pack away from all sources of heat.
- ❑ Keep the battery pack dry.
- ❑ Do not open or try to disassemble the battery pack.
- ❑ Do not expose the battery pack to any mechanical shock.
- ❑ If you are not using the computer for an extended period of time, remove the battery pack from the computer to prevent damage to the battery.
- ❑ If, after fully charging the battery pack, the battery power is still low, the battery pack may be reaching the end of its life and should be replaced.
- ❑ You do not need to discharge the battery before recharging.
- ❑ If you have not used the battery pack for a considerable amount of time, recharge the battery.

## *On Using Headphones*

- ❑ **Road safety** – Do not use headphones while driving, cycling, or operating any motorized vehicle. It may create a traffic hazard and is illegal in some areas. It can also be potentially dangerous to play loud music while walking, especially at pedestrian crossings.
- ❑ **Preventing hearing damage** – Avoid using headphones at high volume. Hearing experts advise against continuous, loud and extended play. If you experience a ringing in your ears, reduce the volume or discontinue use.

## *On Handling Memory Stick Media*

- ❑ Do not use the media in locations that are subject to static electricity or electrical noise.
- ❑ Do not touch the Memory Stick media connector with your finger or metallic objects.
- ❑ Use only the label supplied with the Memory Stick media as a label.
- ❑ Do not bend, drop, or apply strong shock to the Memory Stick media.
- ❑ Do not disassemble or modify Memory Stick media.
- ❑ Do not let Memory Stick media get wet.
- ❑ Do not use or store Memory Stick media in a location subject to:
  - ❑ Extremely high temperatures, such as in a car parked in the sun
  - ❑ Direct sunlight
  - ❑ High humidity or
  - ❑ Corrosive substances
- ❑ Use the storage case supplied with the Memory Stick media.

## *On Handling the Hard Disk*

The hard disk has a high storage density and reads or writes data in a short time. However, it can be easily damaged by mechanical vibration, shock or dust.

Although the hard disk has the internal safety device to prevent losing data due to mechanical vibration, shock or dust, you should be careful when handling your computer.

### To avoid damaging your hard disk

- Do not subject your computer to sudden movements.
- Keep the computer away from magnets.
- Do not place your computer in a location subject to mechanical vibration or in an unstable position.
- Do not move your computer while the power is on.
- Do not turn off the power or restart the computer while reading or writing data to disk.
- Do not use your computer in a place subject to extreme changes in temperature.



If the hard disk is damaged, the data cannot be restored.

## Troubleshooting

This section describes how to solve common problems you might encounter when using your VAIO computer. Many problems have simple solutions. Try these suggestions before visiting the Sony online support Web site at <http://www.sony.com/pcsupport> for customers in USA and Canada, or at <http://kdb.sony-latin.com/> for customers in Latin American countries or areas.

- ❑ **Computer (page 168)**
- ❑ **System Security (page 178)**
- ❑ **Battery (page 180)**
- ❑ **Internet (page 182)**
- ❑ **Networking (page 184)**
- ❑ **CDs and DVDs (page 186)**
- ❑ **Display (page 189)**
- ❑ **Printing (page 192)**
- ❑ **Microphone (page 193)**
- ❑ **Mouse (page 194)**
- ❑ **Speakers (page 195)**
- ❑ **Touch Pad (page 196)**
- ❑ **Keyboard (page 198)**
- ❑ **Floppy Disks (page 199)**
- ❑ **PC Cards (page 200)**
- ❑ **Audio/Video (page 201)**
- ❑ **Memory Stick Media (page 202)**
- ❑ **Peripherals (page 203)**

## Computer

### *What should I do if my computer won't start?*

- Make sure the computer is securely plugged into a power source and turned on. Make sure the power indicator shows the power is on.
- Make sure the battery is installed properly and charged.
- Make sure the floppy disk drive (if applicable) is empty.
- If the computer is plugged into a power strip or uninterruptible power supply (UPS), make sure the power strip or UPS is turned on and working.
- If you are using an external display, make sure it is plugged into a power source and turned on. Make sure the brightness and contrast controls are adjusted correctly. See the manual that came with your display for details.
- Disconnect the AC adapter and remove the battery. Wait three to five minutes. Reattach the AC adapter and reinstall the battery, and press the power button to turn on the computer.
- Condensation may cause the computer to malfunction. If this occurs, do not use the computer for at least one hour.
- Remove any extra memory modules you may have inserted since purchase.
- Check that you are using the supplied Sony AC adapter. For your safety, use only genuine Sony rechargeable battery packs and AC adapters, which are supplied by Sony for your VAIO computer.



## *What should I do if a BIOS error appears when my computer starts?*

If the message "Press <F1> to resume, <F2> to setup" appears at the bottom of the screen

- 1 Press the **F2** key when the **VAIO** logo appears.  
The BIOS setup screen appears.
- 2 Set the date (month/day/year). Press **Enter**.
- 3 Press the **↓** key to select **System Time**, and then set the time (hour: minute: second). Press the **Enter** key.
- 4 Press the **→** key to select the **Exit** tab, and then press the **↓** key to select **Get Default Values**. The message **Load factory default values** appears.
- 5 Press the **Enter** key.  
The **Load Optimal Defaults** window appears.
- 6 Select **OK**, and press the **Enter** key.
- 7 Select **Exit (Save Changes)**, and press the **Enter** key.  
The **Save configuration changes and exit setup** window appears.
- 8 Select **OK**, and press the **Enter** key. The computer restarts.

If this occurs on a regular basis, contact an authorized Sony Service Center. To find the nearest center or agent, visit the Sony online support Web site.

*What should I do if the power indicator (Green) lights but my screen does not display anything when I turn on my computer?*

If nothing still appears on your screen after a while

- 1 Press the power button for more than four seconds to check that the power indicator goes out. Then turn on your computer again.
- 2 If nothing still appears on your screen, unplug the AC adapter, remove the battery, and leave your computer for about a minute. Then plug in the AC adapter, install the battery, and turn on your computer again.

## *What should I do if the message "Operating system not found" appears when my computer starts, and why won't Windows start?*

- ❑ Make sure the computer does not have a "non-bootable" floppy disk in the floppy disk drive (if applicable).
- ❑ If a non-bootable floppy disk is in the drive:
  - 1 Remove the floppy disk.
  - 2 Restart the computer and confirm that the Microsoft Windows operating system starts properly.
- ❑ If the Windows operating system still does not start, follow these steps to initialize the BIOS:
  - 1 If there is a disk in the floppy disk drive, remove it.
  - 2 Turn off the computer.
  - 3 Remove any peripheral devices connected to the computer.
  - 4 Restart the computer.
  - 5 Press the **F2** key when the **VAIO** logo appears.  
The BIOS setup screen appears.
  - 6 Press the **→** key to select the **Exit** menu.
  - 7 Press the **↓** key to select **Get Default Values**.  
The message **Load factory default values** appears.
  - 8 Press the **Enter** key.  
The **Load Optimal Defaults** window appears.
  - 9 Select **OK**, and press the **Enter** key.
  - 10 Select **Exit (Save Changes)**, and press the **Enter** key.  
The **Save configuration changes and exit setup** window appears.
  - 11 Select **OK**, and press the **Enter** key. The computer restarts.

## *What should I do if my computer or software stops responding?*

- ❑ It is best to turn off your computer using the **Turn Off Computer** option on the Microsoft Windows Start menu, located on the taskbar. Using other methods, including those listed below, may result in loss of unsaved data.
- ❑ Click **Start**, point to **Turn Off Computer**, and then click **Turn Off**.
- ❑ If your computer does not turn off, press the **Ctrl+Alt+Delete** keys simultaneously. When the **Windows Task Manager** window appears, click **Turn Off** from the **Shut Down** menu.  
When the **Windows Security** window appears, click **Shut Down**.
- ❑ If your computer still does not turn off, press and hold the power button or slide and hold the power switch until the computer turns off.
- ❑ If your computer stops responding while playing a CD or DVD, press the **Ctrl+Alt+Delete** keys simultaneously. You can turn off the computer from the **Windows Task Manager**.
- ❑ Pressing the **Ctrl+Alt+Delete** keys simultaneously or turning off the computer with the power button or switch may cause loss of data.
- ❑ Remove the AC adapter and battery.
- ❑ Try reinstalling the software.
- ❑ Contact the software publisher or designated provider for technical support.

## *Why won't my computer enter Standby or Hibernate mode?*

Your computer may become unstable if the operating mode is changed before the computer completely enters **Standby** or **Hibernate**.

To restore the computer to normal operating stability

- 1 Close all open programs.
- 2 Restart the computer. Follow these steps:
  - 1 Press the **Windows** key.
  - 2 Press the **U** key.
  - 3 Press the **R** key to select restart.
- 3 If the computer does not restart, follow these steps:
  - 1 Press the **Ctrl+Alt+Delete** keys simultaneously.  
The **Windows Task Manager** or **Windows Security** window appears.
  - 2 When the **Windows Task Manager** window appears, press and release the **Alt** key to highlight the menu bar, press the **→** key to select **Shut Down**, and then follow step 3 and 4.  
When the **Windows Security** window appears, press the **S** key to shut down.
  - 3 Press the **Enter** key.
  - 4 Press the **R** key to select restart.
- 4 If this procedure does not work, press and hold the power button or slide and hold the power switch until the computer turns off.

### *Why doesn't the computer start or the power button does not work when the battery indicator is flashing?*

- ❑ This symptom could be due to the battery pack not being installed properly. To resolve this symptom, switch off the computer and remove the battery pack. Then install the battery pack to the computer again. For details, see **Installing the Battery Pack (page 26)**.
- ❑ If the symptom persists after performing the above, it means the installed battery pack is not compatible. Remove the battery pack and contact an authorized Sony Service Center. To find the nearest center or agent, visit the Sony online support Web site.

### *Why does a window appear to notify of incompatibility of the battery pack and an operating mode shift to Hibernate?*

- ❑ This symptom could be due to the battery pack not being installed properly. To resolve this symptom, switch off the computer and remove the battery pack. Then install the battery pack to the computer again. For details, see **Installing the Battery Pack (page 26)**.
- ❑ If the symptom persists after performing the above, it means the installed battery pack is not compatible. Remove the battery pack and contact an authorized Sony Service Center. To find the nearest center or agent, visit the Sony online support Web site.

## *Why is the sound of my computer's fan so loud?*

The computer's fan may be running at a high speed to cool the CPU. By lowering the CPU speed, you also lower the speed and noise level of the computer's fan. You can use the power schemes to lower the CPU speed.

To lower the CPU speed using the power schemes\*

- 1 Click **Start** and then **Control Panel**.
- 2 Click **Performance and Maintenance**, and click **Power Options**.  
The **Power Options Properties** window appears.
- 3 Select **Portable/Laptop** in the **Power schemes** box.
- 4 Click **Apply**.
- 5 Click **OK**.

\* Available on selected models only.

## *Why does the System Properties window display a slower CPU speed than the maximum?*

This is normal. Because your computer's CPU utilizes a type of CPU speed controlling technology for power conservation purposes, System Properties may display the CPU's current speed instead of the maximum speed.

## *Why don't my changes appear on the computer screen (LCD)?*

You may need to refresh the computer screen. Press and hold the **Windows** key, and press **D** twice.

## *What should I do if I start my computer and the message "System Disabled" appears and Windows does not start?*

If you enter a wrong power-on password three times consecutively, the **System Disabled** message appears and Windows does not start. Press the power button for more than four seconds to check that the power indicator goes off. Wait for 10 or 15 seconds, then restart your computer and enter the correct password. When entering the password, check that the **Num Lock** indicator and **Caps Lock** indicator are off. If any are lit, press the **Num Lk** key or the **Caps Lock** key to turn off the indicator before entering the password.

## *What should I do if my game software does not work or it keeps crashing?*

- Check the web site of the game if there are any patches or updates to download.
- Make sure you have installed the latest video driver.
- On some VAIO models, the graphics memory is shared with the system. The optimal graphic performance in this case is not guaranteed.

## *What should I do if I cannot remember the password?*

If you have forgotten the password, contact an authorized Sony Service Center to cancel it. A cancellation fee will be charged. To find the nearest center or agent, visit the Sony online support Web site.



## *What should I do if I cannot use my computer as a VAIO Media server?*

To use your computer as a VAIO Media server

- 1 Click **Start**, point to **All Programs** and **Norton Internet Security**, and click **Norton Internet Security**.  
The **Norton Internet Security 2005** software is launched.
- 2 Click **Status & Settings** in the left pane under **Norton Internet Security**.  
The **System Status** list is displayed in the right pane.
- 3 Click **Personal Firewall** and then **Configure**.
- 4 Click the **Advanced** tab and then **General**.
- 5 Deselect the **UPNP Port 1900 Block Rule** check box.
- 6 Click **OK**.

## *Why does it take time before my computer starts?*

If Norton Internet Security's Personal Firewall is active, it may take some time before the Desktop screen appears due to network security checkups.

## System Security

This section provides information about keeping your computer operating smoothly and protecting against potential threats to your computer's security.

### *How can I protect my computer against security threats, such as viruses?*

The Microsoft Windows operating system is preinstalled on your computer. The best way to protect your computer against security threats, such as viruses, is to download and install the latest Windows updates regularly.

You can get important Windows updates by doing one of the following:

- The Automatic Updates feature — This feature automatically searches for and delivers updates directly to your computer whenever you are connected to the Internet.
- The Windows Updates web site — This site enables you to download computer updates without turning on the **Automatic Updates** feature.

Your computer must be connected to the Internet before you can receive updates.

### To use the Automatic Updates feature

- 1 Connect to the Internet.
- 2 Click the **Automatic Updates** icon on the **Taskbar notification** area.  
The **Automatic Updates Setup Wizard** appears.
- 3 Click **Next**, and follow the on-screen instructions to set up automatic or scheduled updates.

To visit the Windows Updates web site

- 1 Connect to the Internet.
- 2 Type <http://windowsupdate.microsoft.com/> in the address bar of your browser. The **Microsoft Windows Update and Security Warning** windows appear.
- 3 In the **Security Warning** window, click **Yes** to install and run **Windows Update**.
- 4 In the **Microsoft Windows Update** window, select **Express Install** or **Custom Install**, and follow the on-screen instructions.

### *How do I keep my preinstalled antivirus software updated?*

You can keep the preinstalled Norton Internet Security software program current with the latest updates from Symantec Corporation.

To download and install the latest security update

- 1 Double-click the **Norton Internet Security** icon on the **Taskbar notification** area. If you have not previously registered the antivirus software, a series of information wizards appear.
  - 1 Follow the on-screen instructions to complete each wizard.
  - 2 Double-click the **Norton Internet Security** icon again. The **Norton Internet Security** window appears. If you have previously registered this antivirus software, the Norton Internet Security window automatically appears.
- 2 Click **Live Update**, located near the top of the window.
- 3 Follow the on-screen instructions to select and download updates.

## Battery

### *How do I know when the battery is charged?*

To determine the remaining battery charge, see **Charging the Battery Pack (page 29)**.

### *When is the computer using AC power?*

When the computer is directly connected to the AC adapter, it uses AC power, even if a battery is installed.

### *When should I recharge the battery?*

- When the battery level falls below 10 percent.
- When both the battery and power indicators blink.
- When you have not used the battery for a long time.

### *When should I replace the battery?*

If the battery power is still low after charging it, the battery may be reaching the end of its life and should be replaced.

### *Should I be concerned that the installed battery is warm?*

No, it is normal for the battery to be warm when it is powering the computer.

### *Can my computer enter Hibernate mode while using battery power?*

Your computer can enter **Hibernate** mode while using battery power, but some software programs and peripheral devices prevent the system from entering **Hibernate** mode. If you are using a program that prevents the system from entering **Hibernate** mode, save your data frequently to avoid losing data. See **Using Hibernate Mode (page 136)** for information on how you can manually activate **Hibernate** mode.

## *Why doesn't my computer enter Hibernate mode?*

You may first need to enable Hibernate mode. Follow these steps:

- 1 Click **Start** and then **Control Panel**.
- 2 Click **Performance and Maintenance**.
- 3 Click **Power Options**.  
The **Power Options Properties** window appears.
- 4 Select the **Hibernate** tab.
- 5 Click to check the box next to **Enable hibernation**.

## Internet

### *Why doesn't my modem work?*

- Make sure the telephone cable is securely plugged into the Modem port on the computer and the wall jack.
- Make sure the telephone cable is working. Plug the cable into an ordinary telephone and listen for a dial tone.
- Make sure the telephone number the program is dialing is correct.
- Make sure the software you are using is compatible with the computer's modem. (All preinstalled Sony programs are compatible.)
- Make sure that the modem is the only device connected to your phone line.
- Check the following setting:
  - 1 Click **Start** and then **Control Panel**.
  - 2 Click **Printers and Other Hardware**.
  - 3 Click **Phone and Modem Options**.
  - 4 On the **Modems** tab, check that your modem is listed.
  - 5 On the **Dialing Rules** tab, check the location information is correct

## *Why is my modem connection slow?*

Your computer is equipped with a V.92/ V.90 compatible modem. Many factors may influence modem connection speed, including telephone line noise or compatibility with telephone equipment, such as fax machines or other modems. If you think your modem is not connecting properly to other PC-based modems, fax machines, or your Internet Service Provider (ISP), follow these steps:

- Ask your telephone company to verify your telephone line is free of any line noise.
- If your problem is fax-related, make sure there are no problems with the fax machine you are calling and that it is compatible with fax modems.
- If you are having a problem connecting with your ISP, make sure the ISP is not experiencing technical problems.
- If you have a second telephone line, try connecting the modem to that line.

## Networking

### *Why can't my computer connect to a wireless LAN access point?*

- Connection availability is affected by distance and obstructions. You may need to move your computer away from obstructions or closer to any access point you may be using.
- Make sure the **WIRELESS LAN** switch is on and the WIRELESS LAN indicator is lit on the computer.
- Make sure power to the access point is on.
- Check the following setting:
  - 1 Click **Start** and then **Control Panel**.
  - 2 Click **Network and Internet Connections**.
  - 3 Click **Network Connections**.
  - 4 Right-click **Wireless Network Connection**.
  - 5 Click **Properties**.
  - 6 Click the **Wireless Network** tab.
  - 7 Make sure the access point is displayed in the **Available networks**.
- Make sure the encryption key is correct.

### *Why can't I access the Internet?*

- Check the access point settings. See the instructions supplied with the access point.
- Make sure your computer and the access point are connected to one another.
- Move your computer away from obstructions or closer to any access point you may be using.
- Make sure your computer is properly configured for Internet access.



### *Why is the data transfer speed slow?*

- ❑ The wireless LAN data transfer speed is affected by distance and obstructions between devices and access points. Other factors include device configurations, radio conditions, and software compatibility. To maximize the data transfer speed, move your computer away from obstructions or closer to any access point you may be using.
- ❑ If you are using a wireless LAN access point, the device may be temporarily overloaded depending on how many other devices are communicating via the access point.
- ❑ If your access point interferes with other access points, change the access point channel. See your access point instructions for more information.

### *How do I avoid data transfer interruptions?*

- ❑ When your computer is connected to an access point, data transfer interruptions may occur when using large files or if the computer is in close proximity to microwaves and cordless telephones.
- ❑ Move the computer closer to the access point.
- ❑ Make sure the access point connection is intact.
- ❑ Change the access point channel. See your access point manual for more information.

### *What are channels?*

- ❑ Wireless LAN communication occurs on divided frequency bands known as channels. Third-party wireless LAN access point channels may be preset to different channels from Sony devices.
- ❑ If you are using a wireless LAN access point, see connectivity information contained in your access point instructions.

### *When I change the encryption key, the network connection stops. What should I do?*

Two computers with built-in wireless LAN may lose a peer-to-peer network connection if the encryption key is changed. You can either change the encryption key back to the original profile or re-enter the key on both computers so the key matches.

## CDs and DVDs

### *Why does my computer freeze when I try to read a disc?*

The disc your computer is trying to read may be dirty or damaged. Follow these steps:

- 1 Restart the computer by clicking **Start, Turn Off Computer,** and **Restart.**
- 2 Eject the disc from the optical disc drive.
- 3 Examine the disc for dirt or damage. If the disc is dirty, see **On Handling Discs (page 163)** for instructions on how to clean it.

### *What should I do if the drive tray won't open?*

- Make sure the computer is on.
- Press the drive eject button on the optical disc drive.
- If the drive eject button does not work, click **Start** and then **My Computer.** Right click the optical disc drive icon, and select **Eject** from the shortcut menu.
- If none of the above options work, insert a thin, straight object (such as a paper clip) in the manual eject hole near the drive eject button.
- Try restarting your computer.

## *What should I do if the optical disc drive isn't playing my CD or DVD properly?*

- ❑ Make sure the disc was inserted into the optical disc drive with the label facing up.
- ❑ Make sure the necessary program(s) is installed according to the manufacturer's instructions.
- ❑ If the CD or DVD is dirty or damaged, the computer will stop responding. Follow these steps:
  - 1 Restart the computer by pressing the **Ctrl+Alt+Delete** keys, and selecting **Restart** from the **Shut Down** menu of the **Windows Task Manager** window.
  - 2 Remove the CD or DVD from the optical disc drive.
  - 3 Check the disc for dirt or damage. If you need to clean the disc, see **On Handling Discs (page 163)** for instructions.
- ❑ If you are playing a CD or DVD and cannot hear sound, follow these steps:
  - ❑ Double-click the **Volume icon** on the **Taskbar Notification** area, and click to cancel the **Volume Control Mute All** and **Wave Mute** check boxes.
  - ❑ Check the volume setting in the audio mixer.
  - ❑ If you are using external speakers, check the volume settings on the speakers and the connections between the speakers and the computer.
  - ❑ Make sure the CD audio feature is enabled and the correct driver software is installed. Follow these steps:
    - 1 Click **Start and then Control Panel**.
    - 2 Click **Performance and Maintenance**.
    - 3 Click **System**.  
The **System Properties** window appears.
    - 4 Select the **Hardware** tab, and click **Device Manager** in the **Device Manager** box.  
A window with a listing of the computer's hardware devices appears.  
If an "X" or an exclamation point appears on the listed device, you may need to enable the device or reinstall the drivers.
    - 5 Double-click the optical disc drive device to open the submenu.

- 6 Double-click the listed drive, and select the **Properties** tab.
  - 7 Click to select the **Enable digital CD audio for this CD-ROM device** check box, if it is not selected. You can confirm the driver software by selecting the **Driver** tab, and clicking **Driver Details**.
  - 8 Click **OK** to close the window.
- Make sure an adhesive label was not attached to the CD or DVD. Adhesive labels can come off while the disc is in the optical disc drive and damage the drive or cause it to malfunction.
  - If a region code warning appears, the disc may be incompatible with the optical disc drive. Check the DVD package to make sure the region code is compatible with the optical disc drive.
  - If you notice condensation on the computer, do not use the computer for at least one hour. Condensation can cause the computer to malfunction.
  - Make sure your computer is running on AC power supply and try the disc again.

### *What should I do if I cannot write to CD?*

- Do not launch any software application or allow any to launch automatically, not even a screen saver.
- Do not use the keyboard.
- Do not use a CD-R/RW disc that has a label affixed to it. This could cause a write error or other damage.

### *What should I do if I cannot write to DVD? (on selected models only)*

- Are you using the correct DVD recordable media?
- Check which DVD recordable format is compatible with your computer's built-in DVD recorder (DVD-R / DVD-RW / DVD+R / DVD+RW). Note the possibility that some brands of DVD recordable media do not work.
- The preinstalled software on your computer does not support copying DVD movies. Macrovision or a similar video protection technology prevents users from copying DVD movies. Copying a DVD movie would be a copyright infringement and therefore illegal.

## Display

### *Why did the computer screen (LCD) go blank?*

- ❑ Your computer screen may go blank if the computer has lost power or has entered a power saving mode (**Standby** or **Hibernate**). If the computer is in **LCD (Video) Standby** mode, press any key to activate the computer screen. See **Using the Power Saving Modes (page 133)** for more information.
- ❑ Make sure the computer is plugged into a power source and is on. The power indicator on the computer will be on if the computer is on.
- ❑ If your computer is using battery power, make sure the battery is installed properly and is charged. See **Using the Battery Pack (page 26)** for more information.
- ❑ If the display mode is set to external display, use the **Fn+F7** key combination. See **Combinations and Functions with the Fn Key (page 36)** for more information.

### *Why can't I view the entire DVD video display on a TV screen?*

The display resolution may not be properly set. It is recommended that you adjust the display resolution to 1024 x 768 or smaller, depending on the size of the external display screen.

### *How do I adjust the image on the TV screen?*

Use the controls on your external display to adjust the image. See the help guide that accompanied your display for more information.

### *How do I change the video resolution on the TV screen?*

- ❑ The video may not appear on the entire TV screen if your computer resolution is set larger than 1024 x 768. Adjust the video resolution to 1024 x 768 or smaller.
- ❑ If you are using the AV Out jack, plug the audio-video (AV) cable into the computer before you start the computer.
- ❑ To change the video resolution, follow these instructions:
  - 1 Right-click the desktop, and select **Properties** from the shortcut menu.
  - 2 Select the **Settings** tab.
  - 3 Move the screen resolution slider to the left to reduce the size and to the right to increase the size of the video resolution.

### *How do I switch the computer screen from LCD to TV?*

Press the **Fn+F7** keys to view the image on either the computer screen (LCD) or the TV. See **Combinations and Functions with the Fn Key (page 36)** for more information.

### *What should I do if the screen does not display a video?*

- ❑ If the external display is selected for the output destination with the **Fn+F7** keys and the external display is disconnected, you cannot display a video on your screen.
- ❑ In such a case, stop video playback, press the **Fn+F7** keys to change the output destination to your screen, and then restart video playback.

### *What should I do if the screen is dark?*

- ❑ Press the **Fn+F6** keys to brighten the screen.
- ❑ Press the **Brightness** button.

## *What should I do if the brightness of the screen changes?*

The brightness of your screen when adjusted with the **Brightness** button and the **Fn+F5/F6** keys is temporary and this adjustment is overridden by the setting on the **VAIO Power Management** tab when another power scheme is selected.

To save this preference for the brightness



To do the following procedure, you must have administrator rights.

- 1 Click **Start** and then **Control Panel**.
- 2 Click **Performance and Maintenance**.
- 3 Click **Power Options**.
- 4 On the **Power Schemes** tab, select the desired power scheme from the **Power schemes** list.
- 5 On the **VAIO Power Management** tab, select **No change** under **Plugged in** and **Running on batteries** for **LCD Brightness**.
- 6 Click **OK**.

The preference for the brightness adjusted with the **Brightness** button or the **Fn+F5/F6** keys is saved and your screen brightness remains unchanged regardless of operating conditions.

## *What should I do if the external display (or TV) does not display anything?*

If you change the log-on user with the Fast User Switching function after your computer started, you will not be able to select a display by pressing the **Fn+F7** keys.

## Printing

### Why can't I print a document?

- Make sure the printer is on, and the printer cable is securely connected to the ports on your printer and computer.
- Make sure the printer is compatible with the Windows operating system installed on your computer.
- You may need to install the printer driver software before you use the printer. See the manual that accompanied the printer for more information.
- If the printer is not functioning after the computer resumes from a power saving mode (**Standby** or **Hibernate**), then restart the computer.
- If the bidirectional communication functions are provided with your printer, disabling the functions on your computer may enable printing. Follow these steps:
  - 1 Click **Start** and then **Control Panel**.
  - 2 Click **Printers and Other Hardware**.
  - 3 Click **Printers and Faxes**.
  - 4 Right-click an unused printer and select **Properties**.
  - 5 Click the **Ports** tab.
  - 6 Click to cancel the **Enable bidirectional support** check box.
  - 7 Click **OK**.

This change to the settings disables the bidirectional communication functions of your printer, such as data transfer, status monitoring, and remote panel.

When your printer is connected to the port replicator, check the port replicator to see if it is connected to an AC power source.



## *Microphone*

### *Why doesn't my microphone work?*

If you are using an external microphone, make sure the microphone is turned on and is properly plugged into the Microphone jack on the computer.

## Mouse

### *What should I do if the computer doesn't recognize the mouse?*

- Make sure the mouse is securely plugged into the port.
- Restart the computer with the mouse connected to the computer.

### *What should I do if the pointer doesn't move when I use the mouse?*

- Make sure another mouse is not installed.
- If you are playing a disc, press the **Ctrl+Alt+Delete** keys simultaneously to stop playback and restart the computer.
- If you still cannot use the pointer, restart the computer. You can restart the computer three different ways:
  - Press the **Windows** key, and press the **U** key. When the **Turn off computer** window appears, press the **R** key.
  - Press the **Ctrl+Alt+Delete** keys simultaneously. When the **Windows Task Manager** window appears, press the **Alt** key to highlight the menu bar, and press the **➔** key to select **Shut Down**. Press the **Enter** key, and then press the **R** key.
  - Press and hold the power button. When the computer turns off, wait 10 to 15 seconds then press the power button again to restart the computer.
- If you are using a wireless optical mouse:
  - Confirm that the supplied AA batteries are properly installed.
  - Press the **CONNECT** button on the mouse and the computer to re-establish the connection between the two devices.
- Avoid using radio-controlled toys or equipment, CB radios, and other wireless devices in the area near your wireless mouse. These devices may cause interference, causing your mouse to stop working properly.
- Do not place metal furniture near your computer or wireless mouse, as this may create interference, causing your mouse to stop working properly.

## Speakers

### *Why won't my speakers work?*

- Make sure the speakers are properly connected and the volume is turned up loud enough to hear sound.
- Your speakers may not be designed for computer use.
- If the speakers have a mute button, set the button to off.
- If the speakers have a volume control, make sure the volume is turned up loud enough to hear sound.
- If you have connected an audio cable to the Headphones jack, disconnect the cable and use the speaker cable that was supplied with the speakers.
- If you are using battery power, make sure the battery is installed properly and is charged.
- If the speakers require external power, make sure the speakers are connected to a power source. See the manual that accompanied the speakers for more information.

### *Why can't I hear sound from my speakers?*

- If the computer is using battery power, make sure the battery is properly installed and is charged.
- If you are using a program that has its own volume control, make sure the volume control is properly set. See that program's help guide for more information.
- Your speakers may be set to mute, the volume setting may be too low, or the audio option may be disabled.
- Check the volume controls in Windows.

## Touch Pad

### *What should I do if the touch pad does not work?*

- ❑ Try restarting your computer. Follow these steps:
  - 1 Press the **Windows** key.
  - 2 Press the **U** key. The **Turn off computer** window opens.
  - 3 Press the **R** key to restart the computer.
- ❑ If the computer does not restart, follow these steps:
  - 1 Press the **Ctrl+Alt+Delete** keys simultaneously. The **Windows Task Manager** window appears.
  - 2 Press and release the **Alt** key to highlight the menu bar, and press the **→** key to select **Shut Down**.
  - 3 Press the **Enter** key.
  - 4 Press the **R** key to restart the computer

If you still cannot restart your computer, press and hold the power button to turn off the computer.
- ❑ If the pointer does not move while playing a disc, press the **Ctrl+Alt+Delete** keys simultaneously to stop playback and restart the computer.
- ❑ If you are still experiencing problems, make sure another mouse is not installed.
- ❑ You may have disabled the touch pad without connecting a mouse to the computer. See **Using the Touch Pad** ([page 37](#)).

## *How do I change the left and right button assignments?*

If your computer is interpreting a single-click as a double-click, you may want to change the button assignments. Follow these steps:

- 1 Click **Start** and then **Control Panel**.
- 2 Click **Printers and Other Hardware**.
- 3 Click **Mouse**.
- 4 On the **Buttons** tab, select your preferences in the **Button Configuration** box, and then click **Apply** to install your settings. You may need to use the **Tab** key and the **↑** and **↓** keys to make your selections.
- 5 Click **OK** to close the window.

## Keyboard

### *What should I do if the keyboard configuration is wrong?*

- ❑ The language layout of your computer's keyboard is specified on the sticker on the box. If you choose a different regional keyboard when you complete the Windows setup, the key configuration will be mismatched.
- ❑ To change the keyboard configuration, follow these steps:
  - 1 Click **Start** and then **Control Panel**
  - 2 Click **Date, Time, Language and Regional Options**.
  - 3 Change the settings as desired.

### *What should I do if I cannot enter certain characters with the keyboard?*

If you cannot enter **U, I, O, P, J, K, L, M**, and so on, the **Num Lk** key may be activated. Check that the **Num Lock** indicator is off. If the **Num Lock** indicator is on, press the **Num Lk** key to turn it off before entering these characters.

## Floppy Disks

### *Why doesn't the Safely Remove Hardware icon appear on the taskbar when the drive is connected?*

The computer does not recognize the floppy disk drive. First, make sure the USB cable is properly connected to the USB port. If you need to secure the connection, wait a few moments for the computer to recognize the drive. If the icon still does not appear, follow these steps:

- 1 Close all programs that were accessing the floppy disk drive.
- 2 Wait for the LED indicator on the floppy disk drive to turn off.
- 3 Push the eject button to remove the disk, and disconnect the USB floppy disk drive from the computer.
- 4 Reconnect the floppy disk drive by inserting the USB connector (with the USB icon facing upward) into the USB port.
- 5 Restart the computer by clicking **Start, Turn Off Computer**, and then **Restart**.

### *Why is the drive unable to write data to a floppy disk?*

- Make sure the floppy disk is properly inserted in the drive.
- If the disk is inserted properly and you are still unable to write data to it, the disk may be full or write-protected. You can either use a floppy disk that is not write-protected or disable the write-protect feature.

## PC Cards

### *Why doesn't my PC Card work?*

- ❑ Make sure the PC Card is inserted properly. See **Inserting a PC Card (page 48)** for more information.
- ❑ Make sure the PC Card is compatible with the Microsoft Windows operating system installed on your computer.
- ❑ See the instructions that accompanied your PC Card. You may need to install driver software if you are not using a Sony PC Card.

### *Why doesn't my computer recognize attached devices?*

For some PC Cards, if you alternate between normal power operation and the **Standby** or **Hibernate** modes while the card is inserted into the PC Card slot, the computer may not recognize the PC Card or the connected device. Restart your computer.

### *Why can't I insert my PC Card?*

- ❑ Make sure you are inserting the card correctly. See **Inserting a PC Card (page 48)** for more information.
- ❑ You may not be able to use some PC Cards or some functions of the PC Card with this computer. Check the manual that accompanied your PC Card for more information on its use.



## Audio/Video

### *Why can't I use the DV camera recorder?*

You may not be able to use the DV camera recorder, and the message DV equipment seems to be disconnected or turned off may appear because the i.LINK cable is not securely plugged into the ports on the computer or camera. Unplug the connectors, and plug them in again. See **Connecting an i.LINK Device (page 121)** for more information.

i.LINK is a trademark of Sony used only to designate that a product contains an IEEE1394 connection. The i.LINK connection may vary, depending on the software applications, operating system, and compatible i.LINK devices. All products with an i.LINK connection may not communicate with each other. See the manual that came with your compatible i.LINK device for information on operating conditions and proper connection. Before connecting compatible i.LINK PC peripherals to your system, such as CD-RW or hard disk drive, confirm their operating system compatibility and required operating conditions.

## *Memory Stick Media*

### *Why can't I open my image files?*

You may need to reformat your Memory Stick media.

Formatting Memory Stick media erases all data, including music data, previously saved to it. Before you reformat Memory Stick media, back up important data and confirm that the media does not contain files you want to keep.

- 1 Copy the data from the Memory Stick media onto your computer's hard disk to save data or images.
- 2 Format the Memory Stick media using the **Memory Stick Formatter** software preinstalled on your computer. For instructions about formatting a Memory Stick media, see **Formatting a Memory Stick Media (page 55)**.

### *Why can't I save music files onto my Memory Stick media?*

- Copyright protected music cannot be checked out to any Memory Stick media other than MagicGate Memory Stick media.
- Using recorded music requires permission of the copyright holders.
- Sony is not responsible for music files that cannot be recorded from a CD or downloaded from other sources.

### *Can I copy images from a digital video camera using Memory Stick media?*

Yes, and you can view video clips that you have recorded with Memory Stick media-compatible video camera recorders.

## Peripherals

### *What should I do if I cannot connect a USB device?*

- ❑ If applicable, check the USB device is switched on and using its own power supply. For example, if you are using a digital camera, check the battery is charged. If you are using a printer, check the power cable is connected properly to the AC outlet.
- ❑ Try using a different USB port on your computer. The driver could be installed to the specific port you used the first time you connected the device.
- ❑ Check the manual provided with the USB device. You may need to install software before you connect the device.
- ❑ Try connecting a simple, low-powered device such as a mouse to test that the port is working at all.
- ❑ USB hubs may prevent a device from working because of the distribution of power. We recommend you connect the device directly to your computer without a hub.

## Support Options

The section contains information on where to go for answers to questions about your VAIO computer and the preinstalled software.

### *Sony Support Information*

See the following sources for answers in the sequence listed below.

#### 1 VAIO Computer Documentation

This on-screen **User Guide** (this manual) and the printed **Welcome mat** provide detailed information on how to maximize your computer's capabilities and solve common problems.

#### 2 Program Guides and Help Files

The preinstalled programs on your computer may come with individual help guides. These guides are stored on the hard disk as on-screen Help files. You can find the Help files from the Help menu under the specific program.

#### 3 Operating System Online Support

Your computer comes preinstalled with a Microsoft Windows operating system. For operating system support, you can visit Microsoft customer support at: <http://support.microsoft.com/directory/>.

#### 4 Sony Computing Support

This service provides instant access to information on commonly encountered problems. Type a description of the problem and the Knowledge Database searches for the corresponding solutions online. You can visit the Sony online support Web site at <http://www.sony.com/pcsupport> for customers in USA and Canada, or <http://kdb.sony-latin.com/> for customers in Latin American countries or areas.

## 5 VAIO Update

When your computer is connected to the Internet, **VAIO Update** automatically notifies you when critical software and security information is posted on the support web site. Click the **VAIO Update** notice to open the VAIO Support web site and view the information. You can also right-click the **VAIO Update** icon on the **Taskbar Notification** area and select **Go to VAIO Web Support** to open the support web site.

## For users in Latin American countries or areas

### Customer Information Center

If you do not find the information you are looking for at our site, you may call Sony directly. In order to receive the fastest and most efficient services, please have the following information readily available:

#### 1 Your VAIO® computer model

You can find it at the lower right corner of the display on the laptops, and in the same place on the front panel of the CPU on the desktops.

#### 2 Your computer's serial number

You can find it on the back of the laptops and on the back of the CPU on the desktops; the serial number is the last 7 digits of the number below the barcode.

#### 3 The operating system on your computer

#### 4 The hardware component or the software program that is causing you the problem

#### 5 A brief description of the problem

In order to contact a Sony technical support representative, please call the following numbers:

In Argentina:

(011) 6770-SONY (7669)

In Mexico:

In Mexico City: 2122-9819

In the Mexican Republic: 01-800-715-4331

In Colombia:

01-800-550-7000

In Peru:

0-801-1-7000 or 221-6699

In Chile:

Sony answers: 800-261-800

From cellular phones: 02-754-6333

In Venezuela:

0-800-1-SONY-00 (0-800-1-7669-00)

## Program Support Information

Depending on the computer model and particular configuration you purchased, your computer may not include all of the software programs listed below.

### **Adobe® Photoshop® Elements, Photoshop® Album, Premiere®, Reader®**

Adobe Systems Inc.

- For users in USA and Canada  
Web Site <http://www.adobe.com/support>  
Telephone 800-685-3652

### **America Online® (Broadband or Dial-Up)**

AOL, Inc.

- For users in USA and Canada  
Web Site <http://www.aol.com>

### **AOL® Instant Messenger™**

AOL, Inc.

- For users in USA and Canada  
Web Site <http://www.aim.com>

**Click to DVD™**

Sony Electronics Inc.

At the touch of a button, Click to DVD software allows you to automatically burn DVDs from a digital video (DV) device. Create DVDs by capturing video content straight from a DV device or by importing video from stored files — and you can also edit the video. Create DVD photo albums and slide shows with picture files or by importing pictures from a digital still camera. What's more, you can give a professional look to your DVDs by adding chapter menus, backgrounds, and menu screens. You are only a few clicks away from your own DVDs!

- For users in USA and Canada  
Web Site <http://www.sony.com/pcsupport>  
Telephone 888-4-SONY-PC (888-476-6972)
- For users in Latin American countries or areas  
Web Site <http://kdb.sony-latin.com/>

**DVgate Plus™**

Sony Electronics Inc.

Connect a compatible digital video camera to your computer's i.LINK® port and capture video clips and still images. Edit clips from your video, add new clips, and combine clips into new movie segments. Save your movies back to your digital video camera or in a variety of popular file formats.

- For users in USA and Canada  
Web Site <http://www.sony.com/pcsupport>  
Telephone 888-4-SONY-PC (888-476-6972)
- For users in Latin American countries or areas  
Web Site <http://kdb.sony-latin.com/>



**Google Toolbar™**

Google, Inc.

- For users in USA and Canada  
Web Site <http://toolbar.google.com/help.html>

**Microsoft® Office Basic Edition, Office Professional Edition, Office Small Business Edition, Office Small Business Edition Trial Version, Office Student and Teacher Edition Trial Version**

Microsoft Corp.

- For users in USA and Canada  
Web Site <http://support.microsoft.com>

**Microsoft® Internet Explorer, Movie Maker, Media Player, Works**

Microsoft Corp.

- For users in USA and Canada  
Web Site <http://support.microsoft.com>

**MoodLogic**

MoodLogic, Inc.

- For users in USA and Canada  
Web Site <http://www.moodlogic.com/support>  
E-mail [help@moodlogic.com](mailto:help@moodlogic.com)

**Netscape® Internet Service**

AOL Inc.

- For users in USA and Canada  
Web Site <http://isp.netscape.com/help>  
Telephone 866-541-8233

**Norton Internet Security™**

Symantec Corporation

- For users in USA and Canada  
Web Site <http://www.symantec.com/techsupp>

**PictureGear Studio™**

Sony Electronics Inc.

PictureGear Studio still image management software displays still images from your hard drive or a Sony digital still camera. The still images appear in a convenient light-table format so that you can easily view the contents of an entire folder, create your own photo albums, and make prints.

- For users in USA and Canada  
Web Site <http://www.sony.com/pcsupport>  
Telephone 888-4-SONY-PC (888-476-6972)
- For users in Latin American countries or areas  
Web Site <http://kdb.sony-latin.com/>

**Quattro Pro®**

Corel Corporation

- For users in USA and Canada  
Web Site <http://www.corel.com>

**Quicken® New User Edition**

Intuit Inc.

- For users in USA and Canada  
Web Site <http://www.intuit.com/support/quicken/>

**RecordNow!**

Sonic Solutions

- For users in USA and Canada  
Web Site <http://support.sonic.com/>

**SonicStage®**

Sony Electronics Inc.

The SonicStage jukebox software program gives you all the tools you need to manage music on your computer. SonicStage software sports high-quality digital audio storage, a sleek player skin design, and audio CD burning capability.

- For users in USA and Canada  
Web Site <http://www.sony.com/pcsupport>  
Telephone 888-4-SONY-PC (888-476-6972)
- For users in Latin American countries or areas  
Web Site <http://kdb.sony-latin.com/>

**SonicStage® Mastering Studio**

Sony Electronics Inc.

Use SonicStage® Mastering Studio software to record songs from analog records or cassette tapes into your computer and output them to CD-R or CD-RW discs or audio files in WAV format.

- For users in USA and Canada  
Web Site <http://www.sony.com/pcsupport>  
Telephone 888-4-SONY-PC (888-476-6972)
- For users in Latin American countries or areas  
Web Site <http://kdb.sony-latin.com/>

**SpySubtract®**

InterMute, Inc.

- For users in USA and Canada  
Web Site <http://www.intermute.com/support.html>

**VAIO Action Setup**

Sony Electronics Inc.

VAIO Action Setup manages the settings for your computer's shortcut keys.

- For users in USA and Canada  
Web Site <http://www.sony.com/pcsupport>  
Telephone 888-4-SONY-PC (888-476-6972)
- For users in Latin American countries or areas  
Web Site <http://kdb.sony-latin.com/>

**VAIO Control Center**

Sony Electronics Inc.

VAIO Control Center provides a central location that gathers resources to configure your VAIO® personal computer and view your computer's configuration and specifications.

- For users in USA and Canada  
Web Site <http://www.sony.com/pcsupport>  
Telephone 888-4-SONY-PC (888-476-6972)
- For users in Latin American countries or areas  
Web Site <http://kdb.sony-latin.com/>

## VAIO Edit Components

Sony Electronics Inc.

VAIO Edit Components is a software plug-in for Adobe® Premiere® software that provides maximum compatibility and video quality for capturing video from your Sony digital camcorder.

- For users in USA and Canada  
Web Site <http://www.sony.com/pcsupport>  
Telephone 888-4-SONY-PC (888-476-6972)
- For users in Latin American countries or areas  
Web Site <http://kdb.sony-latin.com/>

## VAIO Media™

Sony Electronics Inc.

VAIO Media™ software brings multimedia to your network, enabling you to share music, video, and still image files between your VAIO® computers. You can set up one or more VAIO computers as "media servers," which store your multimedia files and make them available to other compatible VAIO computers on your wired or wireless network.

- For users in USA and Canada  
Web Site <http://www.sony.com/pcsupport>  
Telephone 888-4-SONY-PC (888-476-6972)
- For users in Latin American countries or areas  
Web Site <http://kdb.sony-latin.com/>

### VAIO Update

Sony Electronics Inc.

The VAIO Update utility helps you keep your VAIO® computer up to date by regularly checking the Sony Online Support Web site for important software updates and information for your specific VAIO computer model.

- For users in USA and Canada  
Web Site <http://www.sony.com/pcsupport>  
Telephone 888-4-SONY-PC (888-476-6972)
- For users in Latin American countries or areas  
Web Site <http://kdb.sony-latin.com/>

### VAIO Wireless Utility

Sony Electronics Inc.

The VAIO Wireless Utility walks you through setting up your wireless network connection and offers useful diagnostic tests to help keep your wireless network running smoothly.

- For users in USA and Canada  
Web Site <http://www.sony.com/pcsupport>  
Telephone 888-4-SONY-PC (888-476-6972)
- For users in Latin American countries or areas  
Web Site <http://kdb.sony-latin.com/>

**VAIO Zone**

Sony Electronics Inc.

VAIO Zone software provides an effortless way to browse and enjoy pictures, music, and video files on your computer, all through an elegant, next-generation interface. You can even enjoy media content stored on other VAIO® computers on your network. On VAIO computer models with a recordable DVD drive, VAIO Zone enables you to record video and slide shows of pictures to DVD. On VAIO computer models with a built-in TV tuner, VAIO Zone includes a complete personal video recorder, enabling you to record TV programs and burn them to DVD.

- For users in USA and Canada  
Web Site <http://www.sony.com/pcsupport>  
Telephone 888-4-SONY-PC (888-476-6972)
- For users in Latin American countries or areas  
Web Site <http://kdb.sony-latin.com/>

**WinDVD® for VAIO®**

InterVideo, Inc.

- For users in USA and Canada  
Web site <http://www.intervideo.com/jsp/Support.jsp>  
Telephone 510-651-0888

**WordPerfect®**

Corel Corporation

- For users in USA and Canada  
Web site <http://www.corel.com/>