

Welcome

Congratulations on your purchase of the Sony VAIO® MX computer! Your new, high-performance, multimedia computer combines state-of-the-art computer functionality with the latest audio, video and information technology features.

Note:

Click [here](#) to find the latest updates and supplemental information about your computer.

About Your VAIO MX Computer

MiniDisc drive

Your MiniDisc drive can perform several audio functions. Use the MiniDisc drive to:

- Play music from your favorite MiniDisc.
- Record to a MiniDisc media.
- Integrate seamlessly with the other installed audio devices, using MiniDisc media and SonicStage Premium software.

Additionally, your MiniDisc uses Net MD technology, which enables:

- Secure, high-speed music data transfers.
- Support of the MagicGate copyright protection technology.
- Recording of copyright-protected music from the Internet or audio CDs, to your own MiniDisc.

SonicStage Premium software

SonicStage Premium software is a special jukebox application that supports high quality digital audio playback and recording using a variety of devices and media. You can record from the built-in equipment, such as the FM tuner or optical disc drive, and from external analog and digital audio devices, such as portable audio devices. SonicStage Premium software also includes several standard jukebox features, including a Music Visualizer, audio CD-burning component, and a parametric equalizer for fine-tuning your audio playback.

Giga Pocket Personal Video Recorder

Giga Pocket Personal Video Recorder is an interactive collection of audio/video hardware and software. The unique and versatile Giga Pocket features provide a wide array of television/video viewing, recording and playback capabilities.

DVD-RW drive

This new optical storage technology provides increased storage capacity and a dynamic multimedia computing experience. Your state-of-the-art DVD-RW drive writes to DVD-R/DVD-RW and CD-R/CD-RW media, and plays your favorite DVDs and CDs. This drive also functions as the ideal solution for making backups and archiving data, with the ability to store up to 4.7 GB of data on a single DVD-R/DVD-RW media. You can store up to 700MB of data on a single CD-R/CD-RW media. Save your personal movies, videos, and still images to share with family and friends.

Sony MagicGate Memory Stick® media slot

The next generation of digital storage media is smaller than a stick of gum. Easily deliver information from one Memory Stick media-equipped electronic device to another, so you can transfer images, sounds, data and text between cameras, computers, and more.

VAIO® AV applications

This suite of Sony original applications includes PictureGear, Smart Capture, DVgate, Digital Print, MovieShaker, VisualFlow, and Media Bar DVD Player. These software applications make it easy to use advanced multimedia techniques to develop your personal audio and video creations. Using the i.LINK ports, you can capture, view, and share both still and video images, then catalog everything for fast, easy storage and retrieval.

i.LINK® (IEEE1394) interface

Two built-in i.LINK ports, located on the front and rear panels, provide you with digital connection capability. The i.LINK name and logo identify a high-speed communication interface, which allows you to easily connect compatible digital camcorders.

Note:

i.LINK is a trademark of Sony used only to designate that a product contains an IEEE1394 connection. The i.LINK connection may vary, depending on the software applications, operating system and compatible i.LINK devices. All products with an i.LINK connection may not communicate with each other.

Please refer to the documentation that came with your compatible i.LINK device for information on operating conditions and proper connection. Before connecting compatible i.LINK PC peripherals to your system, such as an optical or hard disk drive, confirm their operating system compatibility and required operating conditions.

VAIO® keyboard

The innovative palm rest converts to a keyboard cover for a sleek look when your keyboard is not in use. There are four programmable keys on the keyboard that enable you to launch your favorite applications with the push of a button.

Sony audio and video quality

Take advantage of today's advanced multimedia applications, games, and entertainment software with the Sony high-fidelity audio system, high-powered 3-D graphics, and "Sony-Tuned" MPEG digital video playback.

Microsoft® Windows® XP operating system

Your system includes this latest consumer operating system from Microsoft.

Preinstalled software

All the software on your computer is preinstalled, configured, and ready for you to use right out of the box.

Communications

You have the choice of a variety of popular online services to browse the Internet, access e-mail, send faxes, and much more.

Exceptional performance

Your computer includes an Intel® processor, a 10BASE-T/100BASE-TX Fast Ethernet interface, and a V.90 data/fax modem.*

* Actual upload and download speeds may vary due to line conditions, ISP support, and government regulations.

Unpacking Your Computer

Computer and basic accessories

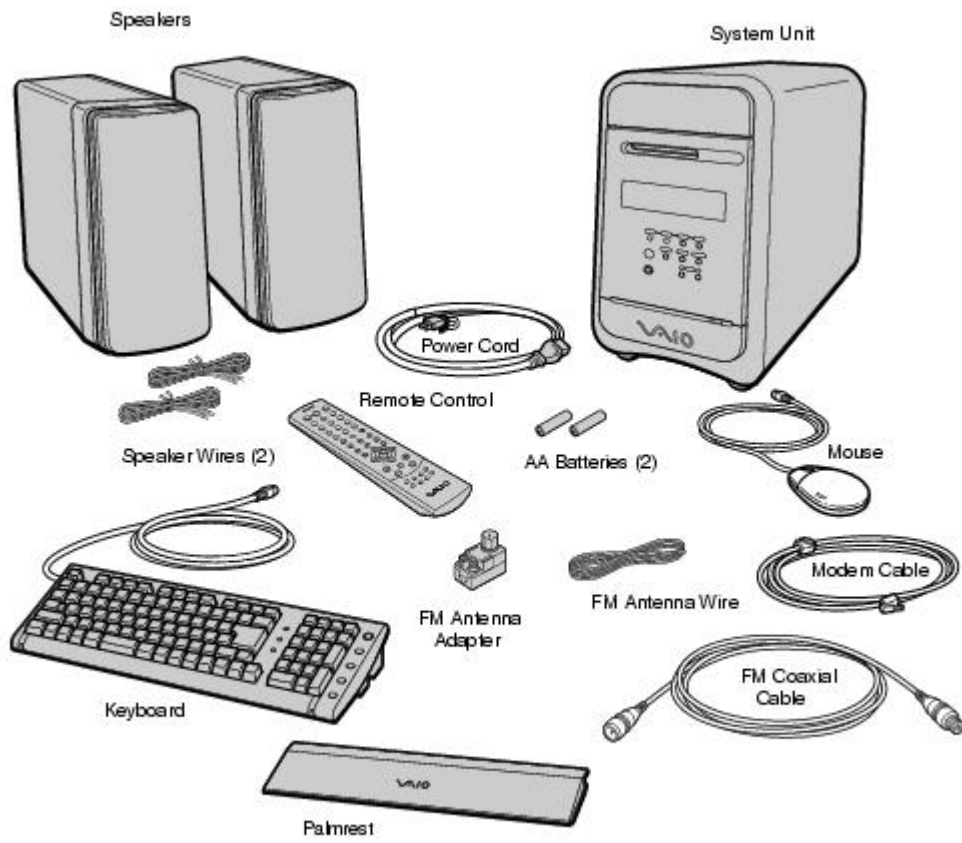

Unpacking Your Computer

Computer and basic accessories

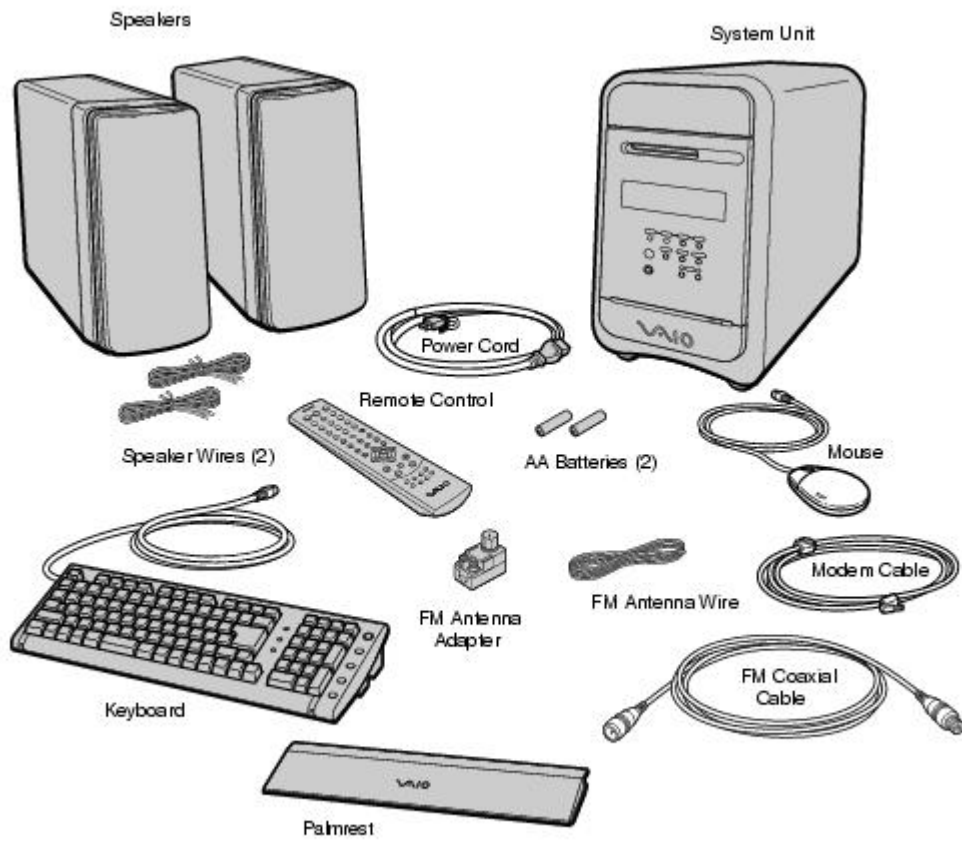

Giga Pocket Personal Video Recorder accessories

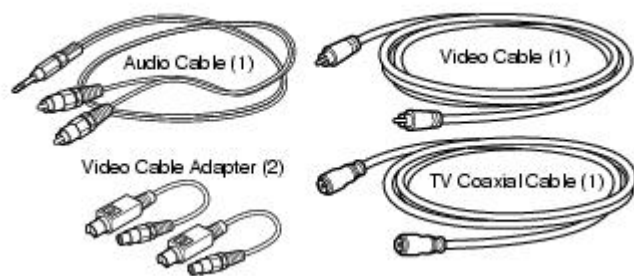

Manuals

- **VAIO® MX Computer QuickStart** — Contains information on unpacking and setting up your computer, supplementary updates, and software information.
- **VAIO® MX Computer User Guide** — Contains features and specifications of your computer. It also includes information on the applications included with your system, how to contact software vendors, and solve common problems.
- **VAIO® MX Computer Getting Started Guide** — Contains information on setting up and using the audio and video functions of the VAIO MX computer and accessories, SonicStage Premium software application, and Giga Pocket Personal Video Recorder equipment and software applications. This guide also has information about the Internet Electronic Program Guide (iEPG) service. You can use this new Internet-based Sony technology to locate, record and set up timer recordings of your favorite TV programs.
- **Home Networking Solutions** — (For models equipped with a HomePNA modem) Contains information on using a HomePNA modem with Sony VAIO computers.
- **Information About DVD Recording** — Contains information designed to help you become familiar with your DVD-RW drive and the DVD recording software applications included with your computer.
- **Safety Information** — Provides safety and legal information about your VAIO computer.
- **Specifications** — Describes the hardware and physical configurations of your VAIO computer.
- **Microsoft® Windows® XP guide** — Explains how to use the basic features of this latest Windows operating system.

Recovery CDs

- **System Recovery CD(s)** — Enables you to restore the software that shipped with your computer if they become corrupted or are erased. System Recovery CDs can only be used to restore the hard disk of the Sony computer you purchased.
- **Application Recovery CD(s)** — Enables you to reinstall individual applications if they become corrupted or are erased.
- **Driver Recovery CD** — Enables you to restore device drivers if they become corrupted or are erased.

Software library

The Software Library contains the Microsoft software license agreement and Sony end-user license agreement.

Other

Packet containing special product offers.

To Choose an Ergonomic Location for Your Computer

Before you get started, find the best location for your new computer.

Planning your work space

- **Stable work surface** — Use a stable work surface large enough to support the computer and other peripheral equipment.
- **Ventilation** — Leave at least eight inches of space on the left and back sides of your computer to enable proper ventilation.
- **Placement of the keyboard, mouse, and other input devices** — Place your keyboard, mouse, and other input devices so that your arms and hands are in a relaxed, comfortable position. The keyboard should be directly in front of you. Adjust the level of the keyboard so that your lower arms are parallel to the floor. Keep your wrists in a relaxed position when you are using the keyboard—not angled up or down. Use the palmrest only briefly, for resting. While typing, never use the palmrest or rest your hands on the table. Position the mouse at the same level as the keyboard. Hold the mouse with a relaxed hand, and use your whole arm to move it. Take breaks during sessions with your computer. Excessive use of the mouse or a joystick may strain muscles or tendons.
- **Furniture and posture** — Sit in a chair with good back support and armrests. Adjust the level of the chair so your feet are flat on the floor. A footrest may make you more comfortable. Sit with relaxed, upright posture—avoid slouching forward or leaning far backward.
- **Viewing angle of the display** — Position the display 18 to 26 inches directly in front of you, with the top of the screen at or a little below eye level. Use the display's tilting feature to find the best position. You can reduce eye strain and muscle fatigue by placing the display in the proper position.
- **Lighting** — Choose a location where windows and lights do not create glare and reflection on the display. Use indirect lighting to avoid bright spots on the display. You can also purchase accessories for your display that help reduce glare. Proper lighting adds to your comfort and work effectiveness.

Locating Controls And Connectors

Front Panel Overview

The front panel of your VAIO® MX computer enables access to the optical drive, MiniDisc drive, Memory Stick®, and PC Card slots. The front panel also provides access to the Universal Serial Bus (USB) and i.LINK® ports to connect your compatible peripheral devices.

Note:

i.LINK is a trademark of Sony used only to designate that a product contains an IEEE1394 connection. The i.LINK connection may vary, depending on the software applications, operating system, and compatible i.LINK devices. All products with an i.LINK connection may not communicate with each other.

Please refer to the documentation that came with your compatible i.LINK device for information on operating conditions and proper connection. Before connecting compatible i.LINK PC peripherals to your system, such as an optical or hard disk drive, confirm their operating system compatibility and required operating conditions.

Front panel

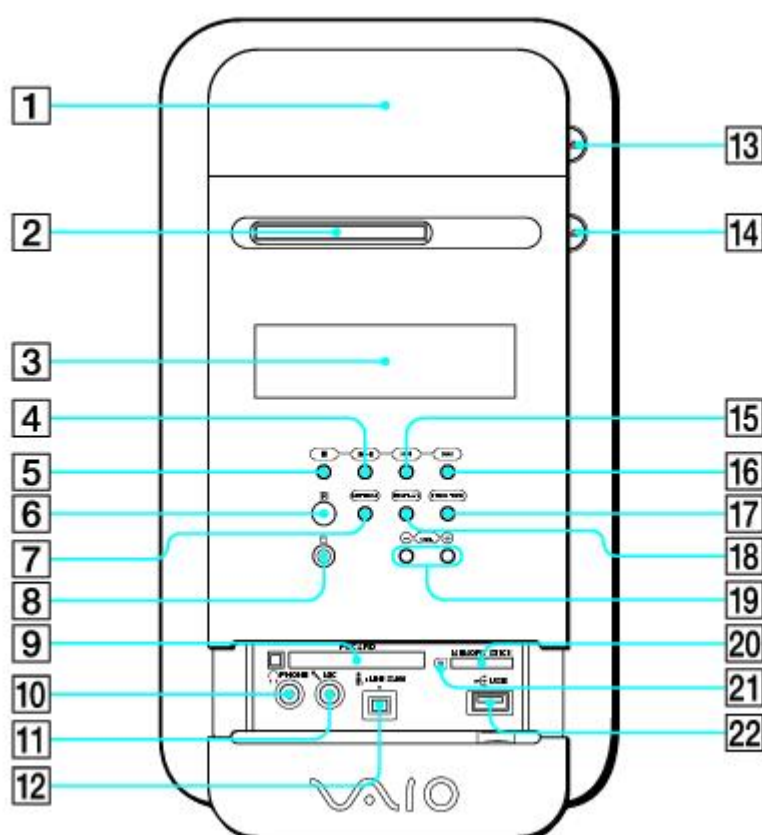

1 DVD-RW drive

Reads data from DVD or CD media. Writes data to a DVD-R, DVD-RW, CD-R, or CD-RW media.

2 MiniDisc drive

Plays and records music to and from a MiniDisc media. Supports Net MD protocol for secure music transfers.

3 LCD display screen

Displays the current operating mode and status of the computer.

4 Play button

Plays the current DVD, CD, or MiniDisc media contents.

5 Stop button

Stops the current playback of DVD, CD, or MiniDisc media.

6 Infrared Receiver

Enables the computer to receive signals from the remote control.
(For proper remote control operation, do not block the infrared receiver.)

7 Muting button

Mutes the current sound output.

8 Power button and indicator light

Turns the computer on and off. The indicator light is blue when the computer is on and amber when the computer is in Stand by mode.

9 PC Card slot

A PC card (also called a PCMCIA card) can be installed using this slot, to increase the functions of your system.

10 Headphone jack

Connection for headphones.

11 Microphone jack

Connection for a microphone.

12 i.LINK 4-pin port (IEEE1394)

Connection for a compatible digital device.

13 DVD-RW eject button

Ejects a disc from the DVD-RW drive.

14 MiniDisc media eject button

Ejects a MiniDisc media from the MiniDisc drive.

15 Previous/Rewind button

Skips to the previous track on the current playback of a DVD, CD or MiniDisc media.

16 Next/Fast Forward button

Skips to the next track on the current playback of a DVD, CD or MiniDisc media.

17 Function button

Selects the operation mode of the computer.

18 Display button

Selects the display mode on the LCD display screen.

19 Volume control buttons

Increases or decreases the volume.

20 MagicGate Memory Stick® media slot

Reads and writes data to and from a Memory Stick media.

21 MagicGate Memory Stick media access indicator light

The indicator light is amber when the Memory Stick media slot is in use.

22 Universal Serial Bus (USB) port

Connection for a compatible USB device.

 **Note:**

For your convenience, your computer includes USB and i.LINK ports and jacks on both the front and back panels. (The 4-pin i.LINK port is located on the front panel and the 6-pin i.LINK port is located on the back.)

Locating Controls And Connectors

Front Panel Overview

The front panel of your VAIO® MX computer enables access to the optical drive, MiniDisc drive, Memory Stick®, and PC Card slots. The front panel also provides access to the Universal Serial Bus (USB) and i.LINK® ports to connect your compatible peripheral devices.

Note:

i.LINK is a trademark of Sony used only to designate that a product contains an IEEE1394 connection. The i.LINK connection may vary, depending on the software applications, operating system, and compatible i.LINK devices. All products with an i.LINK connection may not communicate with each other.

Please refer to the documentation that came with your compatible i.LINK device for information on operating conditions and proper connection. Before connecting compatible i.LINK PC peripherals to your system, such as an optical or hard disk drive, confirm their operating system compatibility and required operating conditions.

Front panel

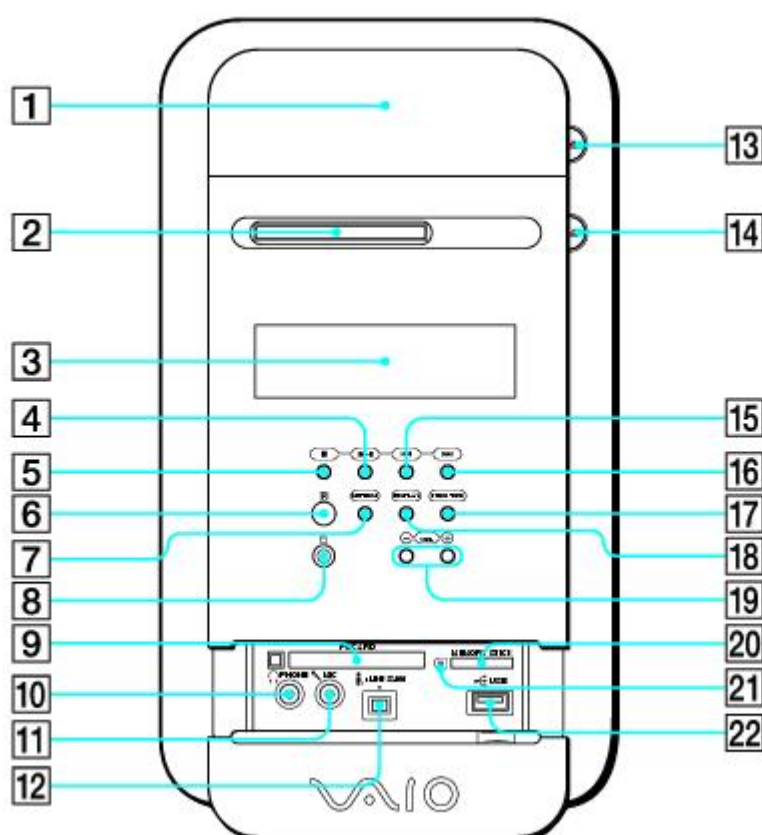

1 DVD-RW drive

Reads data from DVD or CD media. Writes data to a DVD-R, DVD-RW, CD-R, or CD-RW media.

2 MiniDisc drive

Plays and records music to and from a MiniDisc media. Supports Net MD protocol for secure music transfers.

3 LCD display screen

Displays the current operating mode and status of the computer.

4 Play button

Plays the current DVD, CD, or MiniDisc media contents.

5 Stop button

Stops the current playback of DVD, CD, or MiniDisc media.

6 Infrared Receiver

Enables the computer to receive signals from the remote control.
(For proper remote control operation, do not block the infrared receiver.)

7 Muting button

Mutes the current sound output.

8 Power button and indicator light

Turns the computer on and off. The indicator light is blue when the computer is on and amber when the computer is in Stand by mode.

9 PC Card slot

A PC card (also called a PCMCIA card) can be installed using this slot, to increase the functions of your system.

10 Headphone jack

Connection for headphones.

11 Microphone jack

Connection for a microphone.

12 i.LINK 4-pin port (IEEE1394)

Connection for a compatible digital device.

13 DVD-RW eject button

Ejects a disc from the DVD-RW drive.

14 MiniDisc media eject button

Ejects a MiniDisc media from the MiniDisc drive.

15 Previous/Rewind button

Skips to the previous track on the current playback of a DVD, CD or MiniDisc media.

16 Next/Fast Forward button

Skips to the next track on the current playback of a DVD, CD or MiniDisc media.

17 Function button

Selects the operation mode of the computer.

18 Display button

Selects the display mode on the LCD display screen.

19 Volume control buttons

Increases or decreases the volume.

20 MagicGate Memory Stick® media slot

Reads and writes data to and from a Memory Stick media.

21 MagicGate Memory Stick media access indicator light

The indicator light is amber when the Memory Stick media slot is in use.

22 Universal Serial Bus (USB) port

Connection for a compatible USB device.

 **Note:**

For your convenience, your computer includes USB and i.LINK ports and jacks on both the front and back panels. (The 4-pin i.LINK port is located on the front panel and the 6-pin i.LINK port is located on the back.)

Back Panel Overview

The back panel of your computer contains the ports for supplied and optional accessories. The back panel also provides access to Giga Pocket Personal Video Recorder ports and jacks. The icons on the back panel locate and identify the ports and jacks on your computer.

Back panel

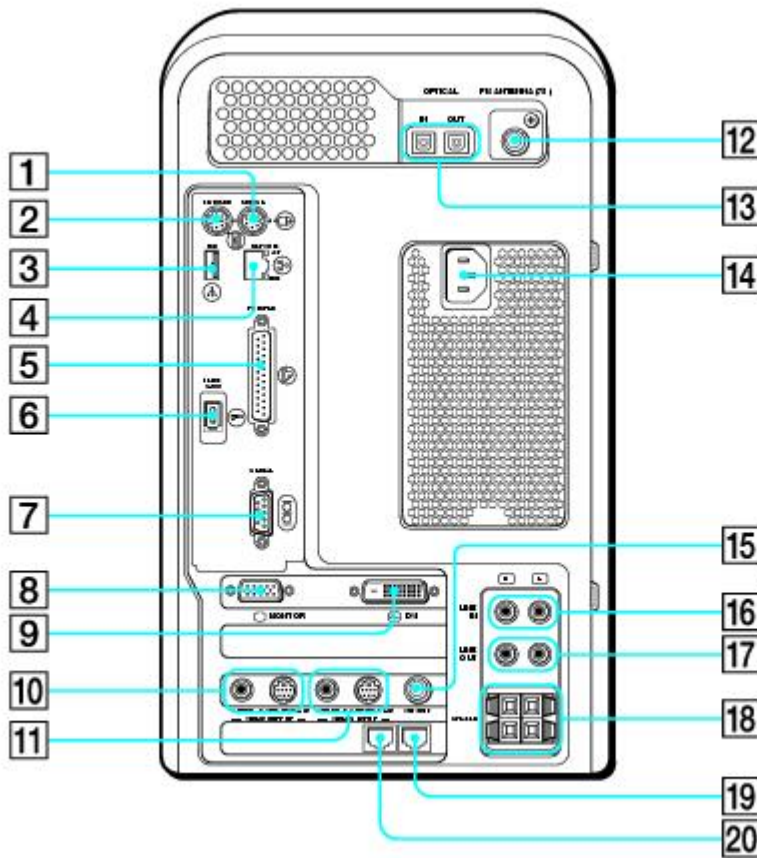

1 Mouse port

Connection for a PS/2® mouse.

2 Keyboard port

Connection for a PS/2 Keyboard.

3 Universal Serial Bus (USB) port

Connection for a compatible USB device.

4 Ethernet port

10BASE-T/100BASE-TX Fast Ethernet interface.

(The port marked with  (Network) is for LAN connections only.)

5 Printer port

Connection for a parallel device, such as a printer or scanner.

6 i.LINK 6-pin port (IEEE1394)

Connection for a compatible digital device.

7 Serial port

Connection for a compatible serial device.

8 Monitor port

Connection for a standard display.

9 DVI (LCD) Monitor port

Connection for an LCD display.

10 Audio Out jack

Connection for an audio cable (supplied).

Video/S-video Out port

Connection for a video cable adapter (supplied) or an S-video cable (optional).

11 Audio In jack

Connection for an audio cable (supplied).

Video/S-video In port

Connection for a video cable adapter (supplied) or an S-video cable (optional).

12 FM antenna port

Connection for an FM antenna.

13 S/P DIF (IN/OUT) optical ports

Connection for a digital audio or optical device.

14 AC Input port

Connection for the supplied power cord.

15 VHF/UHF port

Connection for a TV coaxial cable (supplied).

16 Line IN jacks (R/L)

Connection for an audio device.

17 Line OUT jacks (R/L)

Connection for an audio device.

18 Stereo speaker terminals (R/L)

Connection for the supplied stereo speakers to the computer.

19 Telephone cable jack

Connection for a phone cable to the computer.

20 Modem line jack

Connection for a modem (supplied) cable to the wall jack.

Remote Control Overview

The functions of the VAIO® MX Computer can be controlled using the remote control (supplied). The remote control can control the functions for the computer, FM Tuner, MiniDisc player, Memory Stick® media slot, Giga Pocket functions, and DVD/CD-ROM player.

Remote Control

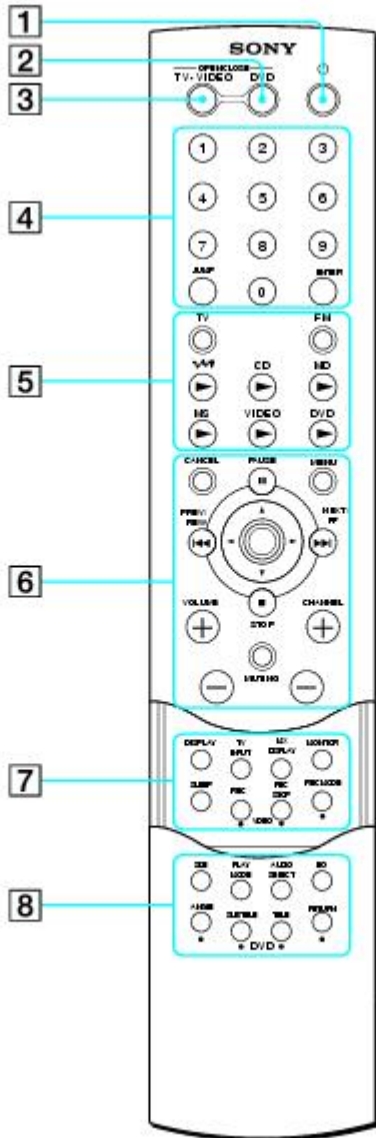

1 Power button

Press to turn the computer on or off.

2 DVD button

Press to control a DVD player.

3 TV/VIDEO button

Press to start or stop Giga Video Recorder. Giga Video Recorder is a feature of the Giga Pocket Personal Video Recorder system.

4 Channel number buttons

Press to select specific channels. Press the ENTER button to activate channel selection.

Jump button

Press to return to the previous channel. Press again to return to the current channel.

Enter button

Press to activate channel selection. See channel number buttons.

5 TV button

Press to control the onscreen TV image.

FM button

Press to control the FM tuner on the computer.

M button

Press to control the  (M drive) on the computer.

CD button

Press to control the CD-ROM drive on the computer.

MD button

Press to control the MiniDisc drive on the computer.

MS button

Press to control the Memory Stick media slot on the computer.

Video button

Press to control video playback.

DVD button

Press to control DVD playback.

6 Cancel button

Press to close a message dialog box.

Pause button

Press to pause playback.

Menu button

Press to display the menu options.

Prev/Rew button

Press to rewind to the previous selection.

Direction (center) button

Press in the arrow directions to locate desired content, such as a song or Video Capsule. Press down to select desired content.

Next/FF button

Press to fast forward to the next selection.

Stop button

Press to stop playback.

Volume buttons

Press to raise or lower the volume.

Muting button

Press to turn off the sound. Press again to restore the sound.

Channel buttons

Press to browse available channels.

7 Display button

Press to display information.

TV input button

Press to select the input source including a television tuner or external input.

MX Display button

Press to select the mode for the LCD display screen on the computer.

Monitor button

Press to set the display to Stand by mode. Press again to enable the monitor to resume. This feature is not available while Giga Pocket features are in use.

Sleep button

Press to program the computer to automatically enter Stand by mode.

Video Rec button

Press to start recording with Giga Video Recorder.

Video Rec Stop button

Press to stop recording on-screen images to Giga Video Recorder.

Video Rec Mode button

Press to select a recording mode for Giga Video Recorder.

8 Size button

Press to view SonicStage Premium software in Simple mode view. Press again to return to full-screen view.

Play Mode button

Press to select Play mode.

Audio Select button

Press to select audio mode.

EQ button

Press to adjust your equalizer.

Angle button

See the Media Bar DVD Player software online Help file for more information.

Subtitle button

See the Media Bar DVD Player software online Help file for more information.

Title button

See the Media Bar DVD Player software online Help file for more information.

Return button

See the Media Bar DVD Player software online Help file for more information.

Additional System Capabilities

To use the Memory Stick media slot

Your VAIO® MX computer is designed to support the Sony MagicGate  Memory Stick® media. A Memory Stick media is a compact, portable, and versatile data storage media designed for exchanging and sharing digital data with similarly equipped products.

Inserting a Memory Stick media

1. Slide front panel cover in the direction of arrow as shown, to open the lower front panel.

Opening the lower front panel

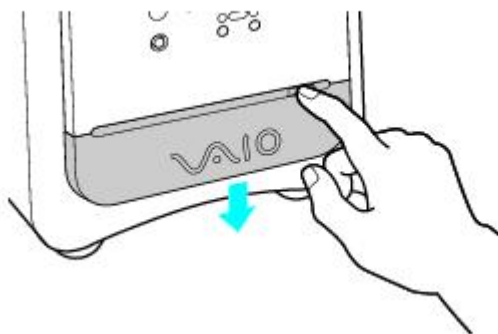

2. Insert the Memory Stick media into the Memory Stick media slot.

Inserting the Memory Stick Media

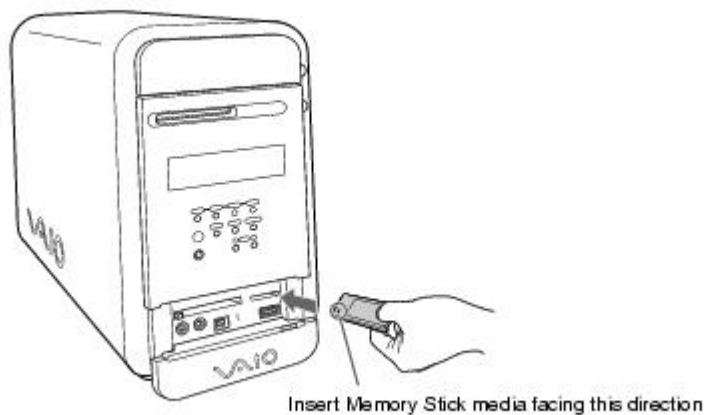

3. If the media does not insert easily, remove it from the slot and verify that it is not upside-down or backwards. Carefully reinsert the Memory Stick media, but do not force it into the slot.

Caution:

Do not remove the Memory Stick media while the media access indicator light is on. The media or its data may become damaged.

Removing a Memory Stick media

A small portion of the Memory Stick media remains extended when it is inserted into the Memory Stick media slot.

1. Press and release the extended portion of the Memory Stick media. The media extends out further from the slot.
2. Remove the Memory Stick media from the slot carefully.

Note:

Sony Memory Stick media do not support AVI file playback. First copy the AVI file to your hard disk drive and then playback the file.

Protecting data on Memory Stick media from accidental changes

Memory Stick media contain a write-protect tab. The write-protect tab prevents accidental changes to information recorded on your Memory Stick media. When you slide the write-protect tab to the LOCK position, your Memory Stick media is write-protected. You cannot delete, copy, or save information on the media while the write-protect tab is in the LOCK position. When you slide the tab to the un-LOCK position, you can write to or modify your Memory Stick media's contents.

Locking the Memory Stick Media

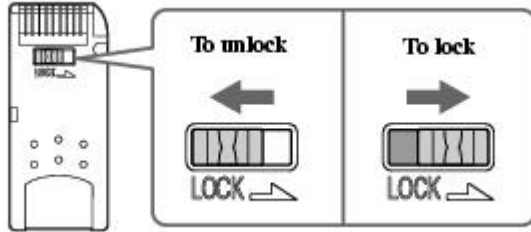

Additional System Capabilities

To use the Memory Stick media slot

Your VAIO® MX computer is designed to support the Sony MagicGate  Memory Stick® media. A Memory Stick media is a compact, portable, and versatile data storage media designed for exchanging and sharing digital data with similarly equipped products.

Inserting a Memory Stick media

1. Slide front panel cover in the direction of arrow as shown, to open the lower front panel.

Opening the lower front panel

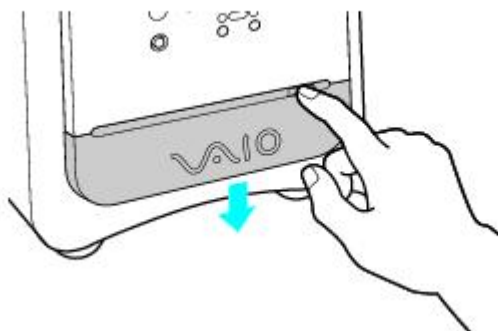

2. Insert the Memory Stick media into the Memory Stick media slot.

Inserting the Memory Stick Media

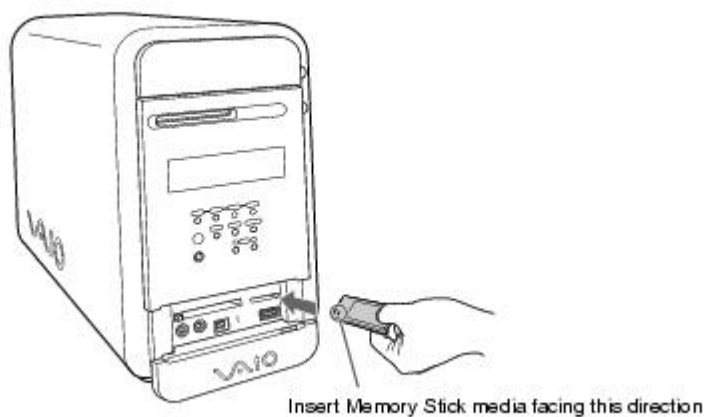

3. If the media does not insert easily, remove it from the slot and verify that it is not upside-down or backwards. Carefully reinsert the Memory Stick media, but do not force it into the slot.

Caution:

Do not remove the Memory Stick media while the media access indicator light is on. The media or its data may become damaged.

Removing a Memory Stick media

A small portion of the Memory Stick media remains extended when it is inserted into the Memory Stick media slot.

1. Press and release the extended portion of the Memory Stick media. The media extends out further from the slot.
2. Remove the Memory Stick media from the slot carefully.

Note:

Sony Memory Stick media do not support AVI file playback. First copy the AVI file to your hard disk drive and then playback the file.

Protecting data on Memory Stick media from accidental changes

Memory Stick media contain a write-protect tab. The write-protect tab prevents accidental changes to information recorded on your Memory Stick media. When you slide the write-protect tab to the LOCK position, your Memory Stick media is write-protected. You cannot delete, copy, or save information on the media while the write-protect tab is in the LOCK position. When you slide the tab to the un-LOCK position, you can write to or modify your Memory Stick media's contents.

Locking the Memory Stick Media

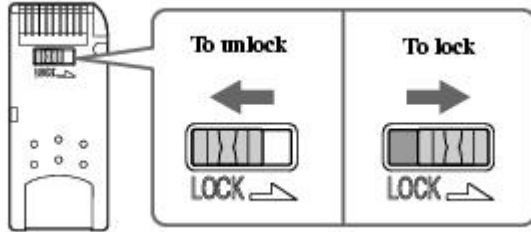

To use PC card slot

Your computer has a card bus PC card slot that supports Type I or Type II PC (PCMCIA) cards. You do not need to shut down your computer when inserting a PC card. For more information, see the instructions supplied with your PC card.

Inserting a PC card

1. Insert the PC card into the PC card slot until it clicks into position.

Inserting a PC card

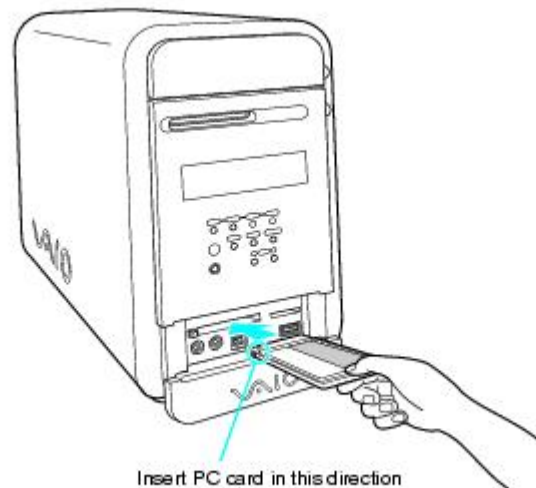

2. If the PC Card does not insert easily, remove it from the PC card slot and verify that it is not upside-down or backwards. Carefully reinsert the PC card, but do not force it into the slot.

Removing a PC card

1. Double-click the Safely Remove Hardware icon in the Windows® task tray.
2. Click to select the name of the card that you want to eject and click Stop. The Stop a Hardware Device window appears.
3. Click OK.
4. When the message "Safe to Remove Hardware" appears, push the PC card Eject button on the front panel of the system unit. You may need to extend the Eject button out from the computer before you can eject the card.
5. When the PC card ejects from the PC card slot, remove it by holding the edges and pulling it out carefully.

Note:

If you eject the PC card incorrectly, your computer may not work correctly.

Setting Up Your VAIO Computer

Your computer has many new and exciting features. This section contains information on setting up your computer and peripheral devices.

Note:

Install your equipment so that you can easily reach the power outlet in the event of an emergency.

To Set Up Your Computer

Your computer may not be equipped with the same hardware features shown in this section. See the Specifications sheet for your system's configuration.

Connecting a display (monitor)

1. Plug the display cable into the Monitor port.
2. If necessary, plug the display cable into the rear of the display.

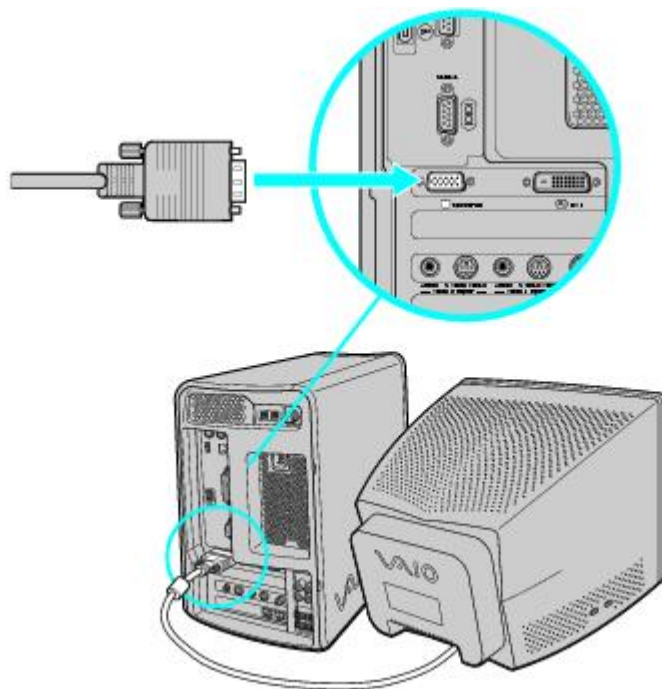

Connecting a DVI (LCD) display

1. Plug the display cable into the DVI monitor port.
2. If necessary, plug the display cable into the rear of the display.

Connecting a DVI display

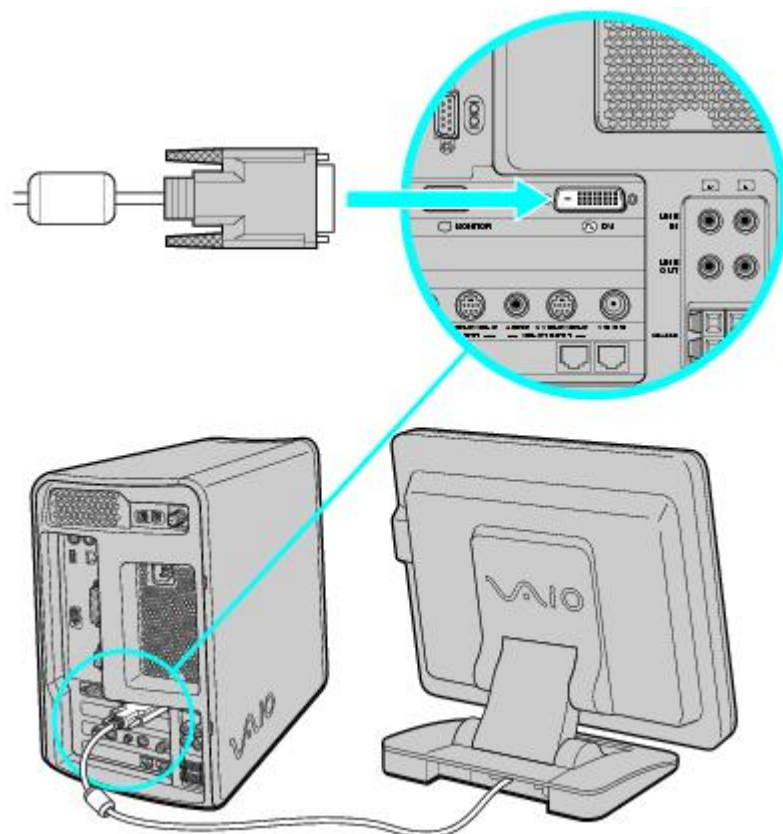

Note:

Do not attempt to connect a CRT and an LCD display to your computer at the same time. Your VAIO® MX computer does not support the simultaneous use of two different monitors.

Connecting the stereo speakers

Your computer system is supplied with speaker wires (2) to connect the stereo speakers to the terminals on the system unit. At the ends of each speaker wire are two wire leads, one with black-line color-coding to identify the proper compatibility with the speaker terminals on the system unit.

To connect the speaker wires to the computer

1. Press and hold the black tab on the lower left-side speaker terminal, located on your computer's back panel.
2. Insert the black-line lead into the lower left-side speaker terminal on the computer. Release the black tab and gently pull on the speaker wire to set the lead firmly.

Connecting the speakers to the computer

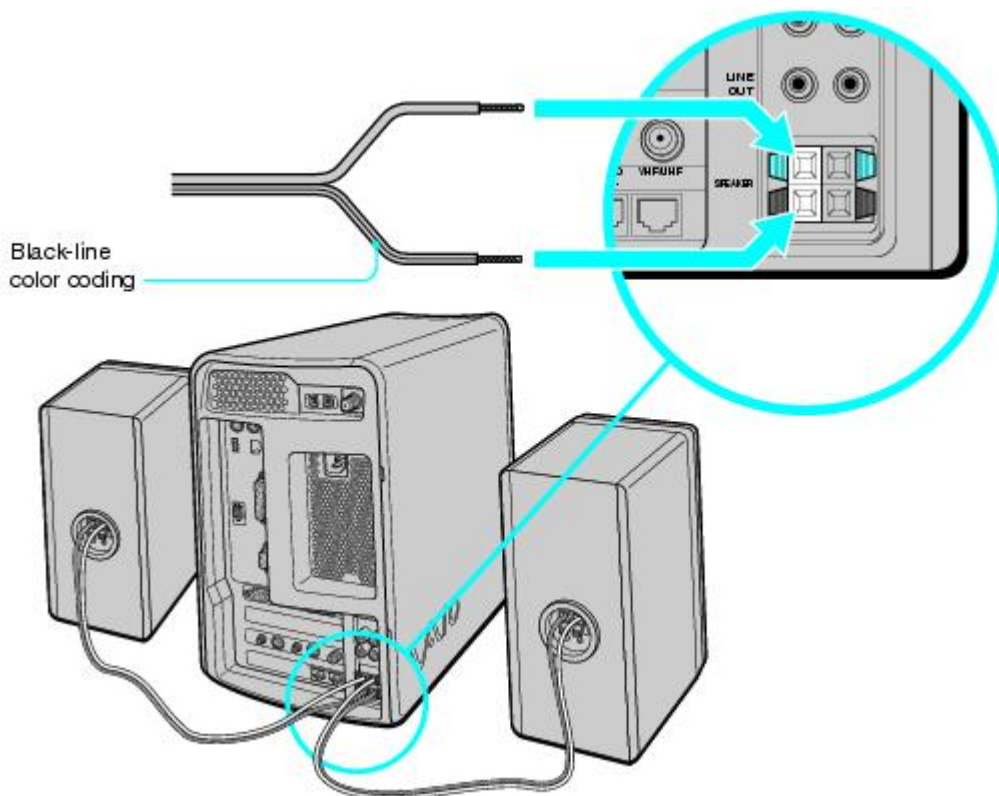

3. Press and hold the red tab on the upper left-side speaker terminal, located on your computer's back panel.
4. Using the same speaker wire, insert the other lead into the upper left-side speaker terminal. Release the red tab and gently pull on the wire to set the lead firmly.
5. Repeat the above steps to connect the left speaker to the computer.

To connect the speaker cables to the speakers

1. Press and hold the left, black tab \ominus on the back of the speaker. Insert the black-line lead of the speaker wire into the terminal. Release the black tab and gently pull on the wire to set the lead firmly.
2. Press and hold the right, red tab \oplus on the back of the speaker. Insert the other lead of the same speaker wire into the terminal. Release the red tab and gently pull on the wire to set the lead firmly.

Connecting the speaker cable to the speakers

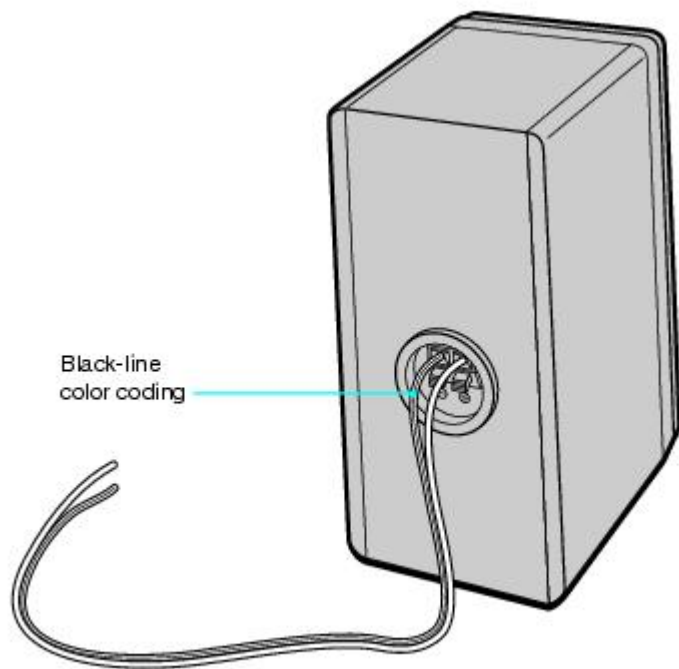

Black-line
color coding

3. Repeat the above steps to connect the second speaker wire to the other speaker.

Connecting the keyboard and mouse

1. Plug the keyboard cable into the Keyboard port on the back of the computer.
2. Plug the mouse cable into the Mouse port.

Connecting the keyboard and mouse

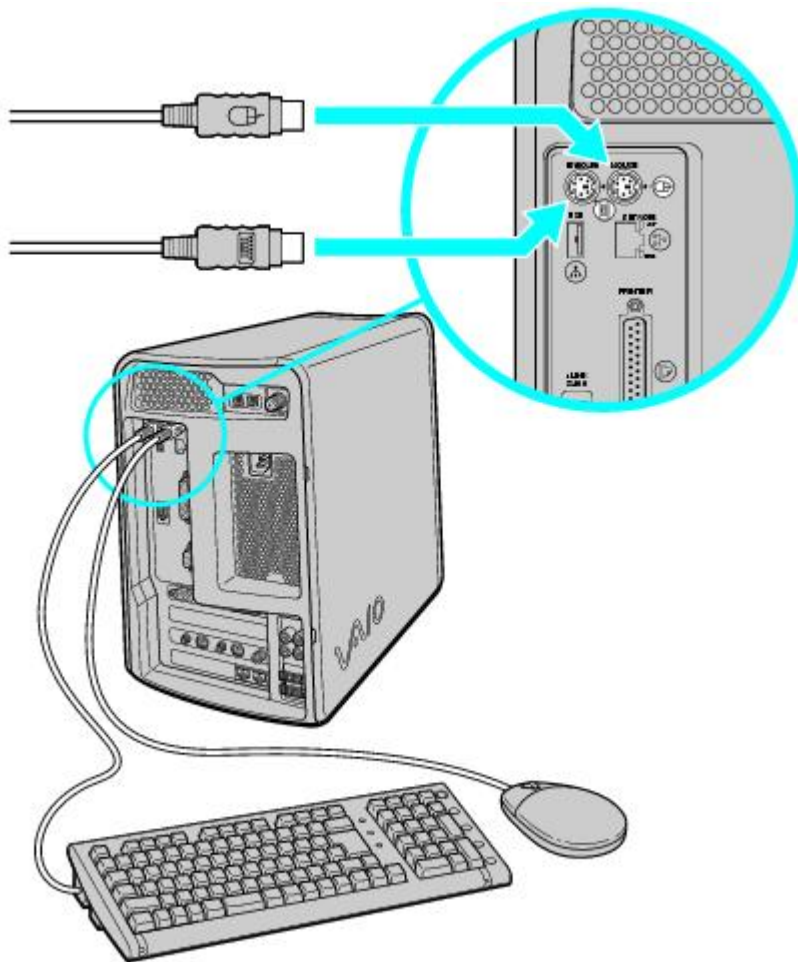

Connecting the phone and modem cables

1. Unplug your phone's cable from the wall jack, and plug it into the Telephone jack on the computer.
2. Plug the modem cable (supplied) into the Line jack on the computer, and then plug the other end of the cable into the wall jack.

Connecting the phone and modem cables

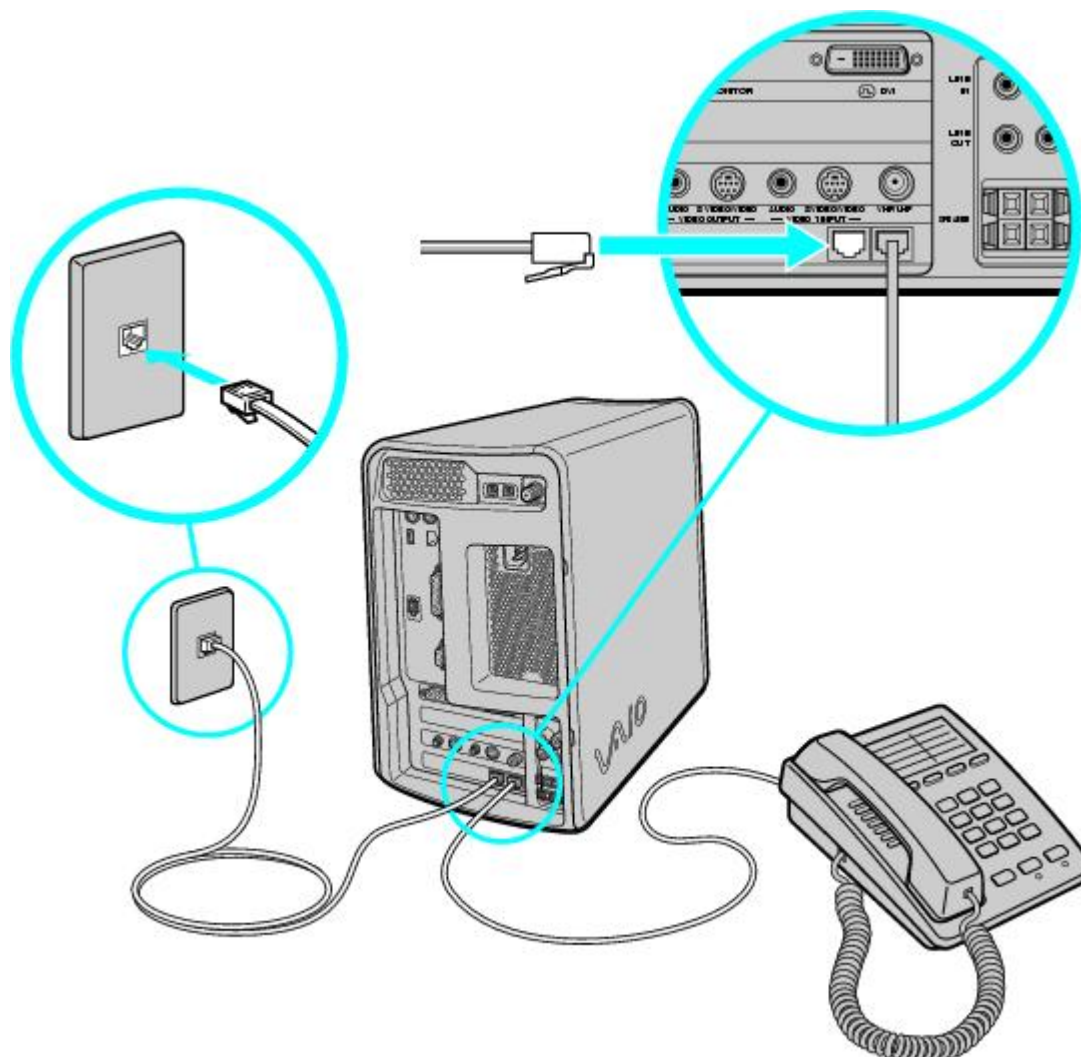

⚠ Caution:

Your computer has a protective sticker  covering the Ethernet port located on the rear panel. Connect only 10BASE-T and 100BASE-TX cables to the Ethernet port. Using other cables or a telephone cable may result in an electric current overload and can cause a malfunction, excessive heat or fire in the port. For help on connecting to a network, see your network administrator.

Connecting the power cords

1. Plug the power cord into the back of the computer.
2. Plug both the display and power cords into a grounded AC wall outlet or a power strip.

Connecting the power cords

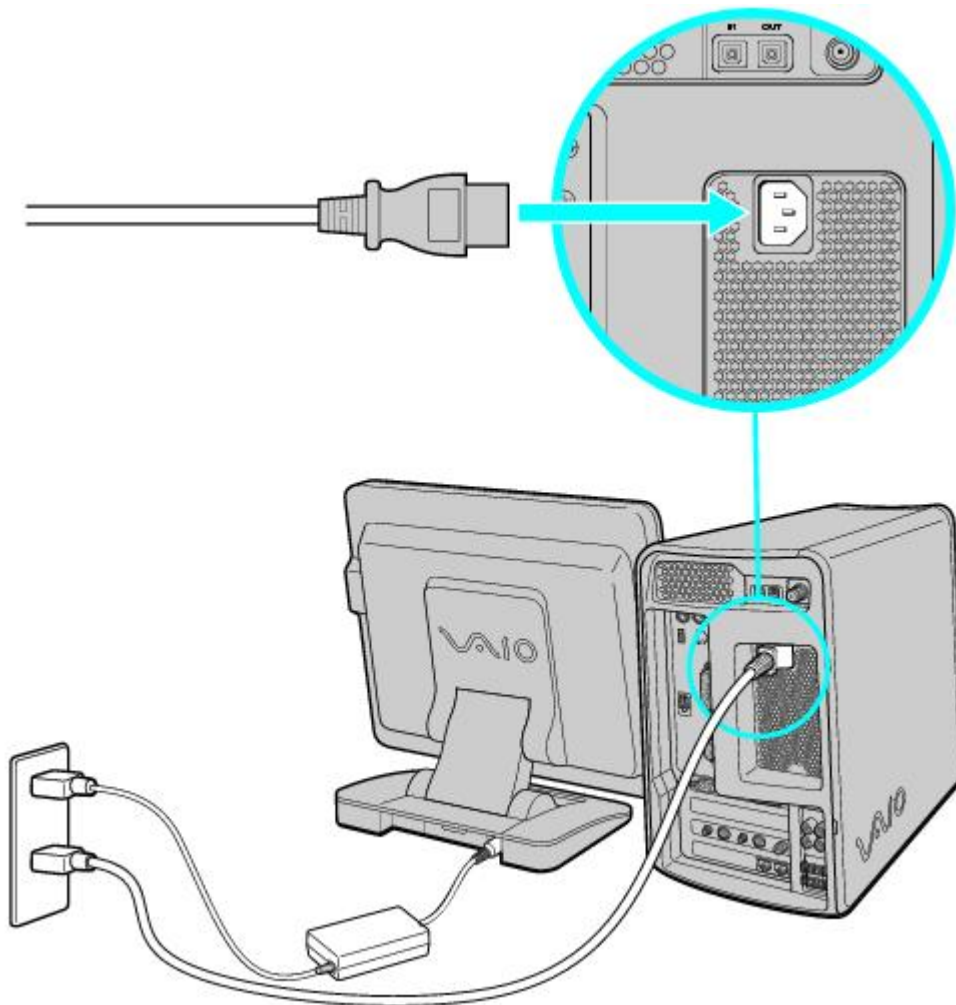

Note:

When you plug the AC power cord into the wall outlet, the power indicators on the computer may light up momentarily, and the fan may turn on briefly. This is not a system malfunction.

After you connect the power cord to the wall outlet, wait five seconds before pressing the power button to start the computer.

To Turn On Your Computer

1. Press the power switch on the display to turn on the power.
2. Press the power switch on the computer to turn on the power.

Note:

When you start your system for the first time, your computer may detect new equipment and display a dialog box that asks you to restart your computer. Please respond to this request immediately.

To turn on your computer

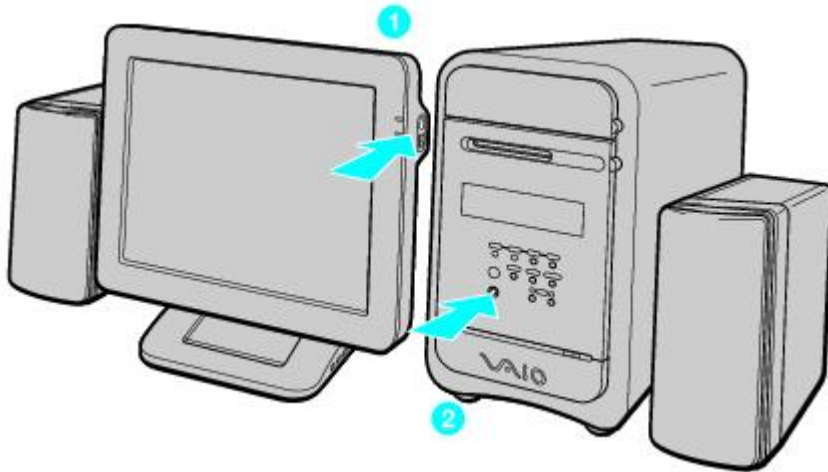

To Register Your Computer

Take advantage of the Sony commitment to quality customer support and receive these benefits by registering your computer:

- **Sony Customer Support** — Communicate with a Support Representative to troubleshoot problems you may be having with your computer.
- **Limited warranty** — Protect your investment. See the Warranty Card for more details.

Note:

You are prompted to register your computer the first time you turn on the unit. Follow the on-screen instructions to complete the registration process. If you are not able to register your computer during the first session, you are provided with additional registration opportunities later.

To Set Up Your Dial-up Connection

The first time you turn your computer on, follow these steps to set up your dial-up connection:

1. Click Start from the Windows taskbar and select All Programs.
2. Point to Accessories, point to Communications, and then click New Connection Wizard.

The Location Information window appears.

Location Information window

Location Information

Before you can make any phone or modem connections, Windows needs the following information about your current location.

What country/region are you in now?
United States

What area code (or city code) are you in now?
[]

If you need to specify a carrier code, what is it?
[]

If you dial a number to access an outside line, what is it?
[]

The phone system at this location uses:
 Tone dialing Pulse dialing

OK Cancel

3. Enter in your information as requested. Click OK.
The Phone and Modem Options window appears.

Phone and Modem Options window

Phone and Modem Options

Dialing Rules

The list below displays the locations you have specified. Select the location from which you are dialing.

Locations:

Location	Area Code
My Location	555

New... Edit... Delete

OK Cancel Apply

4. Click to select your dialing location and then click OK.

The New Connection Wizard appears.

New Connection Wizard window



5. Follow the on-screen instructions to finish setting up your dial-up connection.

To Use the Stand By Mode

When you plan to stop using your computer for a short period of time, you can put it in Stand By mode instead of turning it off completely. Putting the computer in Stand By mode saves energy and allows a quick return to normal computer use.

Before you set your computer in Stand By mode:

- Save your work.
- Close all open applications.
- End your Internet session, if applicable.
- Leave the Windows® operating system running.

Caution:

Your installed Lucent Win Modem does not support the Wake On Ring (WOR) feature of the Microsoft® Windows® XP operating system. For optimal use, Sony recommends that you do not change the preset modem settings.

Initiating Stand By mode

To set the computer to enter Stand By mode using the Stand By key

Press the  (Stand By) key on the upper right corner of the keyboard. The computer goes into Stand By mode.

To set the computer to enter Stand By mode using the Windows taskbar

1. Click Start in the Windows taskbar, then select Turn Off Computer.
2. Click Stand By.

To set the computer to enter Stand By mode using the Power button

Briefly press the Power button on the front panel to place your computer into Stand By mode.

To set the computer to enter Stand By mode using the remote control

Briefly press the power button on the remote control.

To set the computer to enter Stand By mode automatically

1. Click Start in the Windows taskbar, click Control Panel, then select the category, Performance and Maintenance.
The Performance and Maintenance dialog box appears.
2. Click the Power Options icon.
The Power Options Properties dialog box appears.
3. Select the Power Schemes tab. Choose an option from the Power schemes drop-down list.

Note:

To save the settings under a name that is not offered in the Power schemes drop-down menu, choose your settings and then click Save As.

4. Click Apply and then click OK.

The computer will go into Stand By mode according to your settings.

To resume from Stand By mode

To resume from Stand By mode:

- Press the space bar on your keyboard.
- Briefly press the power button on your computer.
- Press the  (Stand By) key on the upper right corner of the keyboard.
- Briefly press the power button on the remote control.

Stand By mode indicators

You can identify which mode the computer is in by the color of the power indicator light.

Color Mode

Amber Computer is in Stand By mode.

Blue Computer is in Normal mode, ready to use.

No color Computer is turned off or in Hibernate mode.

To Use the System Hibernate Mode

System hibernate mode enables your computer to store everything in its memory to the hard disk drive before shutting down. When you bring the system out of hibernation mode, it returns to the previous state.

Initiating Hibernate mode

You can set your computer to automatically enter hibernate mode after a certain time period.

To set the computer to enter Hibernate mode

1. Click Start in the Windows taskbar, click Control Panel, then select the category, Performance and Maintenance.
The Performance and Maintenance dialog box appears.
2. Click the Power Options icon.
The Power Options Properties dialog box appears.
3. In the section, Settings for Home/Office Desk (default Power scheme), select the Power Schemes tab.
4. Click the System hibernate drop-down list and select the period of inactivity before your computer goes into hibernate mode.
5. Select the Hibernate tab and verify that Hibernate is enabled with a check mark in the Enable hibernation check box.
6. Click Apply and then click OK.

Your computer is set to go into hibernation mode automatically, according to your settings.

To Shut Down Your Computer

When you are ready to turn off your computer for an extended period of time, use this procedure.

Caution:

To avoid loss of data, do not use the Power switch to turn off the computer.

Turning off your computer

1. Click Start in the Windows taskbar, then select Turn Off Computer.

The Turn Off Computer dialog box appears.

2. Select the Turn Off option.

Note:

Respond to any prompts about saving your documents.

3. Wait for your computer to turn off automatically—the power indicator light turns off.
4. Turn off any peripheral devices connected to your computer.

Note:

If you plan to turn off your computer for a short period of time, you may want to use Stand By mode instead.

About the Power switch

If your system stops responding, press and hold the Power switch for more than four seconds to force your system to shut down. You may need to repeat this procedure if your system does not shut down on the first attempt.

VAIO Action Setup

VAIO Action Setup manages the settings for your VAIO® keyboard's Shortcut keys (S keys) and your computer's internal timer.

To Use the Shortcut Keys

The programmable S Keys are set to perform the following functions:

- **S1** — Outlook® Express
- **S2** — Internet Explorer
- **S3** — SonicStage Premium
- **S4** — Giga Pocket Personal Video Recorder

Changing the settings of the S keys

You can reprogram the S keys to launch other applications, by following these steps:

1. Click Start in the Windows taskbar and select All Programs.
2. Select VAIO Action Setup, then click VAIO Action Setup.

Note:

You can also double-click  the VAIO Action Setup icon, located in the Windows taskbar, to launch VAIO Action Setup.

3. Click the S Key you want to change.
4. From the Select Application dialog box, click the option for the desired type of function. The corresponding applications appear in the list box on the right.
5. Select an application from the list. Click Next.

Note:

You can drag an application to place it into the list box.

6. The Confirmation Application Name window appears. Click Next.
7. You may now type a new name and description, if desired. Then click Finish.

To Set the Internal Timer

The VAIO Action Setup utility enables you to set your computer's internal timer to launch certain applications or documents automatically.

Note:

Some software applications take longer than others to launch. It is advisable to confirm in advance the amount of time your selected application requires to start.

To select the timer's launch application

1. Click Start in the Windows taskbar, and select All Programs.
2. Select VAIO Action Setup, then click VAIO Action Setup.

Note:

You can also double-click  the VAIO Action Setup icon, located in the Windows taskbar, to launch VAIO Action Setup.

3. Select the Timer tab on the left side of the VAIO Action Setup window.
4. From the Time Setting tab, click the  (Time Schedule Setting icon) button.
5. Follow the Select Application wizard instructions.
6. Click Finish to activate your settings.

To set up the timer start

1. Double-click . The VAIO Action Setup window appears.
2. Select the Timer tab on the left side of the VAIO Action Setup window.
3. From the Time Setting tab, click Set.
4. Follow the Timer Setup wizard instructions.
5. Click Finish to activate your settings.

To Change the Sony Software Window Design

You can select from different window designs for your Sony software and create your own personal computing environment.

Changing the window design

1. Click Start in the Windows taskbar and select the Control Panel.
2. Click Other Control Panel Options.
3. Click UI Design Selector.
4. Click << or >> and select the desired design.
5. Click Apply.
6. The "UI Design Selector" window design changes. The window design for your Sony software will match the "UI Design Selector" window.
7. To try another selection, click << or >>, then click Apply.
8. When you have made your selection, click OK. The UI Design Selector closes and the Sony software window design displays.

Note:

You may only use this feature with compatible UI Design Selector software.

Configuring Your VAIO Computer

Hard Disk Drive Partition

To maintain optimum system performance, you should defragment your computer's D partition regularly.

To improve the performance of Sony audio and video software applications, the hard disk drive on your computer has been formatted with two partitions, C and D. Some Sony software applications save files to the D partition. This prevents large video captures from consuming the available space on your C partition.

Configuring Your VAIIO Computer

Hard Disk Drive Partition

To maintain optimum system performance, you should defragment your computer's D partition regularly.

To improve the performance of Sony audio and video software applications, the hard disk drive on your computer has been formatted with two partitions, C and D. Some Sony software applications save files to the D partition. This prevents large video captures from consuming the available space on your C partition.

Defragmenting your hard disk drive

If you encounter frame dropping while recording digital video onto your hard disk drive, defragmentation may be necessary.

1. Deactivate your screen saver and close other open applications, if applicable.
2. Click Start in the Windows Taskbar and select All Programs.
3. Point to Accessories, point to System Tools, and then select Disk Defragmenter.

The Disk Defragment dialog box appears.

4. Select Action from the menu bar and click Defragment.

Note:

It may take more than a couple of hours to complete defragmentation, depending on the data capacity and current utilization of your computer's hard disk drive(s).

i.LINK (IEEE1394) Compatibility

Your VAIO computer may include either 4-pin or 6-pin, or both types, of i.LINK ports.

Note:

i.LINK is a trademark of Sony used only to designate that a product contains an IEEE1394 connection. The i.LINK connection may vary, depending on the software applications, operating system and compatible i.LINK devices. All products with an i.LINK connection may not communicate with each other.

Please refer to the documentation that came with your compatible i.LINK device for information on operating conditions and proper connection. Before connecting compatible i.LINK PC peripherals to your system, such as an optical or hard disk drive, confirm their operating system compatibility and required operating conditions.

A 6-pin i.LINK port can:

- supply power from the computer to the connected device if the device is equipped with a 6-pin connector.
- supply 10V to 12V.

A 4-pin i.LINK port cannot supply power to a connected device.

Caution:

The total power supplied by the 6-pin i.LINK port cannot exceed 6 watts.

The following Sony i.LINK 400 Mbps cables are available and recommended for use with your computer: VMC-IL4415, VMC-IL4435, VMC-IL4615, VMC-IL4635, VMC-IL6615, and VMC-IL6635.

Sony computer supplies, accessories, and peripherals can be purchased from your local retailer or by accessing the Sony VAIO Direct Web site (<http://vaio.sonymstyle.com>), or by calling 1-888-315-7669 (toll free).

Connecting an i.LINK (IEEE1394) device

1. Use the  symbol to locate the i.LINK port on your compatible i.LINK device and on your computer. Plug the i.LINK cable connector into this port.
2. Plug the other end of the cable into the corresponding 4- or 6-pin i.LINK port on your computer.

 **Note:**

See the instructions that came with your i.LINK device for more information on installation and use.

About The Software On Your Computer

Your VAIO® computer is ready to help you work, play, learn, and communicate as soon as you turn it on. This section provides an overview of the software titles preinstalled on your computer.

Overview of Software Applications

Note:

Your computer may not be supplied with all of the software applications listed, depending on the system configuration you purchased.

Adobe® Acrobat Reader®

Adobe Systems Inc.

Acrobat Reader software allows you to view, navigate, and print electronic documents in Adobe's Portable Document Format (PDF), an open file format that is intended to preserve the fidelity of documents created on all major computer platforms.

Adobe® Photoshop® Elements (On selected models)

Adobe Systems Inc.

Using state-of-the-art image editing tools, you can unleash your artistic ability and create digital images for print, e-mail and posting to the Web. The versatile image capturing options allow you to start working with digital and traditional photos immediately. Explore endless creative possibilities for your personal images with Adobe Photoshop Elements.

Adobe® Premiere® LE (On selected models)

Adobe Systems Inc.

Adobe Premiere LE offers interface and editing tools for producing movies for video, multimedia, or the Web. View source clips and edited footage simultaneously on-screen. You can create your own personal video clips that are up to three hours in length, with complete audio-video synchronization.

America Online®

America Online, Inc.

America Online is a popular Internet online service. Stay in touch with family and friends with easy-to-use e-mail. Manage your personal finances, get the latest news and sports scores, and chat with thousands of others who share your interests.

ArcSoft PhotoPrinter 2000 Pro

ArcSoft Inc.

PhotoPrinter Pro is an easy-to-use, yet advanced printing program that lets you quickly lay out multiple images in multiple sizes on a single sheet of paper. PhotoPrinter Pro offers a wide selection of templates including landscape, portrait, free-style, mixed sizes, custom templates and more. The application includes enhancement tools and special effects for improving photos while giving you the ability to add text to any image. With PhotoPrinter 2000 Pro you can create business cards, handouts, calendars, mailing labels, and much more.

DigitalPrint

Sony Electronics Inc.

This image management software makes it fun and easy to edit, import, and organize your digital pictures in a photo album for rich digital printing to any standard color laser or inkjet printer. Digital Print can also be used to make custom CD labels for your audio CDs.

DVgate

Sony Electronics Inc.

Connect a digital video camera recorder to the i.LINK® port and capture your own video clips and still images. You can edit clips from your video, add new clips, and combine clips into new movie segments. You can also save your images in a variety of popular file formats.

DVDit! for VAIO (On selected models)

Sonic Solutions

DVDit! is a new and exciting production software that is easy to use. DVDit! has easy-to-use features, that automatically convert your multimedia source files into the correct format for recording onto a DVD-R or CD-R, or a DVD folder on your system hard drive. You can combine your favorite MPEG and digital stills, creating professional quality DVDs.

EarthLink Network Total Access

EarthLink Network Inc.

An Internet Service Provider that supplies access, information, and assistance to its customers, introducing them to the Internet. Member benefits include e-mail, newsgroups, a Personal Start Page, a free 6 MB Web site, a member magazine, and 24-hour technical support.

Giga Pocket Personal Video Recorder (On selected models)

Sony Electronics Inc.

Giga Pocket Personal Video Recorder is a unique set of hardware and software components that provide you with excellent TV viewing, recording and playback experiences. You can watch and record your favorite TV programs from your computer, create custom playlists, and play your Video Capsules on other computers. Giga Pocket enables your computer, TV, VCR, and other video player devices to work in harmony.

Media Bar DVD Player

Sony Electronics Inc.

Media Bar DVD Player is created especially for high-quality DVD playback. You can enjoy the superior digital video quality and the effects features. You can rewind or fast-forward scenes from the DVD Player monitor as you would with any ordinary DVD player, to easily find the scene you want to view. Typical DVD playback features are available, such as multiple angles, audio language tracks, and subtitles. Media Bar DVD Player seamlessly integrates a premium audio/visual experience with an easy-to-use software interface.

Microsoft® Internet Explorer

Microsoft Corp.

Internet Explorer delivers the World Wide Web the way you want it. It's secure, easy to use, and you can personalize how you access the Internet. Outlook Express and other features of Internet Explorer deliver a great Internet experience.

Microsoft Office XP Professional (On selected models)

Microsoft Corp.

Microsoft Office XP redefines the relationship between people and software by providing a smarter, simpler way of working. New Office XP features include context-sensitive smart tags, enhanced formatting options, and more, that enable you to continually integrate additional services into Office and access information anytime.

Microsoft Office XP Small Business Edition (On selected models)

Microsoft Corp.

With Microsoft Office XP you'll find a powerful new technology that will help you get work done more quickly by providing real-time, context-sensitive options for important actions, from formatting to error correction. Task panes consolidate important tasks into a single integrated view, enabling you to conduct searches, launch and format documents, and view the contents of your Clipboard from one location.

Microsoft® Outlook® Express

Microsoft Corp.

This messaging tool that takes your e-mail and newsgroup communications to new heights. Outlook Express is easy to set up and use, and provides you with secure, personalized, and comprehensive features that protect and enhance your online communication experience.

Microsoft® Word (On selected models)

Microsoft Corp.

Microsoft Word makes it easy to create common Web, e-mail, and print documents for use around the world. It embraces HTML as a first-class file format and extends Word's ease-of-use to the Web and e-mail. Word also extends that ease-of-use to international users, making it easy to create multilingual documents.

MovieShaker

Sony Electronics Inc.

Sony's original MovieShaker software creates personal movies that have transitions, background music, and text. Just import your video clips and "shake" with a click of the mouse. Your personal movies are easy to create and fun to share with family and friends.

PC-Cillin® 2000

Trend Micro, Inc.

PC-Cillin provides portable, easy-to-use, real-time antivirus security at your computer's entry point (beaming, synchronization, Internet access) to defend against potential threats hidden inside files, e-mail, or on the Web.

PicoPlayer

Sony Electronics Inc.

PicoPlayer software is a video player application that enables you to use Giga Pocket Personal Video Recorder functions on a computer that does not have Giga Pocket Personal Video Recorder installed. You can play Video Capsules created by Giga Pocket Personal Video Recorder. If a Giga Pocket equipped computer is available on your home network, you can use PicoPlayer to watch TV and use the Giga Pocket Server's TV programming and recording functions.

PictureGear

Sony Electronics Inc.

This image management software displays images from your hard drive, a Sony digital still camera, or a Sony Mavica® camera. The images appear in a convenient light-table format, so that you can easily view the contents of an entire **Table 63**

Quicken® 2002

Intuit Inc.

Quicken is the fastest, easiest way to organize your finances. Quicken works just like your checkbook, so it's easy to learn and use. You can even pay your bills online. Quicken manages all of your finances, bank accounts, credit cards, investments, and loans.

RealJukebox®

RealNetworks Inc.

RealJukebox is a popular digital music system that gives you the ability to easily acquire, play and manage digital music files. You can locate and download your favorite music from the Internet and organize your own personal music collection.

RealPlayer®

RealNetworks Inc.

RealPlayer is a high-quality streaming media player that supports many digital media formats. The user-friendly interface has enhanced navigation capabilities, allowing you to access and enjoy audio and video programming over the Internet. RealPlayer is your gateway to a superb Internet multimedia experience.

RecordNow DX (On selected models)

VERITAS Software Corp.

RecordNow is the ideal DVD/CD disc mastering software for all your simple recording needs. The new RecordNow DX wizard makes it easy for the novice user to start recording right away, while the more advanced user will appreciate extended features such as recording jobs, a detailed activity log, and the ability to customize drive settings.

Simple DVD Maker (On selected models)

Sony Electronics Inc.

Simple DVD Maker software enables you to write Giga Pocket Video Capsules and video Playlists to DVD-R/DVD-RW media, using DVD video format. The DVDs that you create can be played back with compatible DVD players and computers that have compatible DVD drives.

Smart Capture

Sony Electronics Inc.

Smart Capture is a fun new way to send multimedia messages via e-mail. Smart Capture manages the i.LINK connection between your notebook and a Sony Digital Handycam Camcorder that supports the i.LINK interface. It allows you to capture compressed video or still images and save them to your hard disk drive or share via e-mail. A smart solution for computer, digital audio/video and network convergence.

SonicStage Premium (On selected models)

Sony Electronics Inc.

SonicStage Premium software is a special jukebox application that supports high quality digital audio playback and recording from the NetMD, FM Tuner, and DVD-RW devices in your VAIO® MX Desktop PC. Recording from external analog and digital audio devices, such as CD players and MiniDisc players, is also supported. SonicStage Premium software includes several standard jukebox features, including a music visualizer, audio CD burning capability, and a parametric equalizer for fine-tuning audio playback.

Sony on Yahoo!

Yahoo! Inc.

Personalize your own web portal with Sony on Yahoo! Get a free webmail account, customized news and local weather reports, comics, and more.

VAIO Action Setup

Sony Electronics Inc.

VAIO Action Setup manages the settings for your computer's Shortcut keys.

VisualFlow

Sony Electronics Inc.

VisualFlow software is a state-of-the-art Sony multimedia browser designed specifically for Memory Stick® media. It displays any still picture, movie or sound file stored in a Memory Stick media in a visually pleasing, artistic manner. VisualFlow software not only plays a selected movie or sound file, but also enables playback of files by other applications like PictureGear, Memory Stick Slideshow and Windows® Explorer.

WordPerfect®

Corel Corp.

WordPerfect is the word processor component of the WordPerfect Office suite. Create professional-looking documents, such as newsletters, reports and brochures with this robust word processing application, adding graphics, charts and tables with

ease. Features such as RealTime Preview enable you to preview formatting before applying it to your documents, and Reveal Codes increases the control you have over your document structure.

For Answers to Your Software Questions

This section provides support information for your computer's preinstalled software applications. Check this support listing to locate information from the Internet, by e-mail, or by telephone.

Note:

Your computer may not be supplied with all of the software applications listed, depending on the system configuration you purchased.

Support for preinstalled software

Adobe® Acrobat Reader®, Photoshop® Elements, Premiere® LE (On selected models) (Adobe Systems Inc.)

Web site <http://www.adobe.com>

phone 206-675-6126 (fee-based support)

fax 206-628-5737

e-mail techdocs@adobe.com

hours M - F, 6 AM - 5 PM PST

America Online® (America Online, Inc.)

Web site <http://www.aol.com>

phone 800-827-6364

hours 7 days a week, 24 hours a day

ArcSoft PhotoPrinter® 2000 Pro (ArcSoft, Inc.)

Web site <http://www.arcsoft.com>

phone 510-440-9901

e-mail support@arcsoft.com

hours M - F, 8:30 AM - 5:30 PM PST

DVDit!® for VAIO (On selected models) (Sonic Solutions)

Web site <http://www.dvdit.com>

Online Support <http://www.dvdit.com/support>

phone 877-DVD-1124*

e-mail support@dvdit.com

hours M - F, 9 AM - 6 PM PST

* Telephone support is fee-based per incident and available only within the U.S. and Canada. Online support is free of charge.

EarthLink Network Total Access (EarthLink Network Inc.)

Web site <http://help.earthlink.net/techsupport>

phone 800-395-8410

e-mail support@earthlink.net

hours 7 days a week, 24 hours a day

**Microsoft® Windows® XP operating system, Internet Explorer, Office XP Professional (On selected models), Office XP Small Business Edition (On selected models), Outlook® Express, Word (On selected models)
(Microsoft Corporation)**

Web site <http://www.sony.com/pcsupport>

phone 888-4-SONY-PC (888-476-6972)*

hours 7 days a week, 24 hours a day

* Support from 888-4-SONY-PC is free of charge for 90 days after the original date of purchase.

PC-Cillin® 2000 (Trend Micro, Inc.)

Web site <http://www.antivirus.com/pc-cillin>

phone 949-387-7800; 900-820-8324*

e-mail support@trendmicro.com

hours M - F, 8AM - 5PM PST

* Support from 949-987-7800 is free of charge. Support from 900-820-8324 is fee-based.

Quicken® 2002 Basic (Intuit, Inc.)

Web site and Online support <http://www.intuit.com/support>

phone 900-555-4688

hours 7 days a week, 24 hours a day

RealPlayer®, RealJukebox (RealNetworks, Inc.)

Web site <http://service.real.com/rjoptions.html>

e-mail <http://service.real.com/help/call.html>

RecordNow DX (VERITAS Software Corp.)

Web site <http://www.easy.co.jp/jrndx/sony>

phone 800-326-9551*

* Telephone support is provided by Sony.

Sony Applications (Sony Electronics Inc.)

Web site and Online support <http://www.sony.com/pcsupport>

phone 888-4-SONY-PC (888-476-6972)*

hours 7 days a week, 24 hours a day

Support from 888-4-SONY-PC is free of charge for 90 days after the original date of purchase.

WordPerfect® (Corel Corporation)

Web site http://www.corel.com/support/product_specific/wp9.htm

phone 613-274-0500*

hours M - F, 8:30 AM - 7:30 PM EST

* Support from 613-274-0500 is fee-based. The online support is free of charge.

Sony Service Center

For the Sony Service Center nearest you, call 1-888-4-SONY-PC (1-888-476-6972). This service is free of charge for 90 days after the original date of purchase.

System, Application And Driver Recovery CDs

System Recovery CD(s)

Sony Electronics Inc.

The System Recovery CD utility enables you to restore the operating system and software that shipped with your computer if they become corrupted or are erased. It can be used only to restore the hard disk of the Sony computer you purchased.

Application Recovery CD(s)

Sony Electronics Inc.

The Application Recovery CD program enables you to reinstall individual applications. Use it to restore corrupted or erased files.

Driver Recovery CD

Sony Electronics Inc.

The Driver Recovery CD program enables you to reinstall individual device drivers. Use it to restore corrupted or erased files.

To Use the System Recovery CD(s)

The System Recovery utility formats your hard disk drive and restores all the original software applications. Your computer is returned to the original factory settings.

Caution:

The System Recovery process removes all software that you may have installed since you started using your computer. Reinstall any applications that were not included with the computer when you purchased it.

If you experience a problem with your computer, reinstalling an individual application or device driver may correct the problem. You may not need to recover the entire contents of your hard drive.

Note:

Use the Application Recovery CD(s) to reinstall individual applications.

When you successfully complete your system recovery, you are prompted to complete the Windows registration process.

System Recovery options

System Drive Recovery

All data on Drive C is deleted. The factory default settings and software applications are restored on this drive only.

Change Partition Size

All partitions, custom installations, and changes are removed from the hard disk drive. You can set the partition sizes for both the Drive C and Drive D. The original, preinstalled operating system and software applications are restored.

Recovery to Original Factory Defaults

All data and partitions are removed from the hard disk drive. All original factory settings, operating system, and preinstalled software is restored.

Caution:

The System Recovery utility does not back up your system's data. If you wish to retain your system data, perform a back up to an external media.

Using the System Recovery CD(s)

Your system may take a few minutes to load necessary files. A blue screen appears during the downloading process.

1. Insert the System Recovery CD in your computer's optical drive.

The System Recovery utility starts from the optical drive. The first CD must be in the drive when you turn on your computer.

2. Turn off your computer.
3. Wait 30 seconds and turn on your computer. Your screen displays the downloading progress, "Starting VAIIO Recovery Utility."
4. The VAIIO System Recovery Utility dialog box appears. Click Next.
5. At the pop-up prompt, select Yes to begin the system recovery process.

Follow the on-screen instructions.

Note:

Your system may include one or more System Recovery CDs. If you have more than one System Recovery CD, insert the first CD to run the System Recovery program. You are prompted to insert the next CD(s) once the information from the first CD has been installed.

The recovery process takes approximately 30 to 60 minutes to complete.

After recovering your system using the System Recovery CD(s), you may be prompted to insert your Application Recovery CD(s) after restarting Windows. Use the Application Recovery CD(s) to complete full restoration of your system.

To Use the Application Recovery CD(s)

The Application Recovery CD utility enables you to reinstall individual software applications if they become corrupted or are erased. Reinstalling an individual software application may correct a problem that you are experiencing with your computer or specific application. You may not need to reinstall the entire contents of your hard drive.

 **Note:**

If you need to reinstall all of the software that shipped with your computer, use the System Recovery CD(s).

You must be in Windows to run the Application Recovery CD utility.

Using the Application Recovery CD(s)

1. Turn on your computer. If your computer is already on, save and close all open applications.
2. When the Windows desktop appears, insert the Application Recovery CD into your computer's optical drive. The Application Recovery utility loads automatically.
3. When the Application Recovery menu appears, follow the on-screen instructions to complete the recovery process.

Note:

Your system may include one or more Application Recovery CDs. If you have more than one Application Recovery CD, insert the first CD to run the Application Recovery utility. You may be prompted to insert the next CD(s), depending on the software application you wish to restore.

If you have any questions about using the Application Recovery CD(s), visit <http://www.sony.com/pcsupport>, or contact Sony Customer Support at 1-888-4-SONY-PC.

To Use the Driver Recovery CD

The Driver Recovery CD utility enables you to reinstall individual drivers and repair software applications if they become corrupted or are erased. You can reinstall an individual driver to correct a problem that you are experiencing with your computer, peripheral hardware, or software application.

 **Note:**

If you need to reinstall all of the software applications that shipped with your computer, use the System Recovery CD(s).

You must be in Windows to run the Driver Recovery CD utility.

Reinstalling device drivers with the Driver Recovery CD

1. Turn on your computer. If your computer is already on, close all applications.
2. When the Windows desktop appears, insert the Driver Recovery CD into the optical disc drive.
3. Click Start in the Windows taskbar and click Control Panel.
The Control Panel window appears.
4. Click Performance and Maintenance and click System.
The System Properties dialog box appears.
5. From the Hardware tab, click Device Manager.
6. Click to select the unknown device or the device that requires the driver installation. The unknown device(s) is identified by a yellow question mark.
7. From the Action menu, click Uninstall. This removes the device driver from your system. Click OK. Repeat for each device driver as necessary.
8. Restart your computer. Click Start in the Windows taskbar, select Turn Off Computer, and then click Restart.
9. When the desktop appears, Windows automatically reinstalls the device driver(s) from the Driver Recovery CD.

Troubleshooting

This section describes how to solve common problems you may encounter when using your computer. Many problems have simple solutions, so try these suggestions before you call Sony Customer Support.

Topics

My computer does not start.

- Check that the computer is plugged into a power source and that it is turned on. Check that the power light is lit on the front panel of the computer.
- Confirm that a disk is not in the floppy disk drive (unless you are using a bootable floppy disk).
- Confirm that the power cord and all cables are connected firmly.
- If you plugged the computer into a power strip or Uninterruptible Power Supply (UPS), make sure the power strip or UPS is turned on and working.
- Check that the monitor is plugged into a power source and turned on. Check that the brightness and contrast controls are adjusted correctly. See the manual that came with your display for details.
- Check that the computer is not in standby mode.

My files are corrupted or deleted. I want to recover applications that came with my computer.

See [To Use the Application Recovery CD\(s\)](#) for more information.

My drivers are corrupted or deleted. I want to recover drivers that came with my computer.

See [To Use the Driver Recovery CD](#) for more information.

My computer or software application stopped responding.

You can try to locate and close the software application that has stopped responding.

1. Press the Ctrl+Alt+Delete keys. The Windows Task Manager window appears.
2. From the Applications tab, locate the application that has the status message, "Not responding."
3. Click to select the application and then click End Task. Windows attempts to close the application.

If your computer does not respond or the application does not close, try the following steps:

1. Save any open files, if possible.
2. Press the Alt+F4 keys. The Turn Off Computer window appears.
3. Click the Restart button.

If your computer still does not respond and you cannot restart, shut down your computer by pressing and holding the power button for more than six seconds.

If the software application continues to stop responding or causes your computer to stop responding, contact the software publisher or designated technical support provider.

Caution:

Pressing and holding the power button for more than six seconds, may result in the loss of data from files that are currently open.

Why does the Windows® operating system stop responding during shutdown?

The Windows operating system may not shut down properly for many reasons, including incompatible or conflicting drivers, damaged files, or non-responsive hardware. For troubleshooting information, you can search Windows online Help.

1. Click Start in the Windows taskbar and select VAIO Help and Support. The VAIO Help and Support dialog box appears.
2. Select Fixing a Problem and then select Startup and Shut Down problems. A list of specific problem topics appears on the right side of the dialog box.
3. Select Startup and Shutdown Troubleshooter. Follow the onscreen instructions according to your specific situation.

How do I change the parallel port type to ECP, EPP, or bi-directional?

You can change the parallel port type using the System Setup utility (CMOS Setup Utility). To access System Setup:

1. Click Start in the Windows taskbar, and select Turn Off Computer. Select Restart.
2. When the Sony screen displays, press the F2 key on your keyboard.
3. Select the Advanced tab from the Setup Utility screen.
4. Select "I/O Device Configuration" and press Enter.
5. Use the arrow keys to highlight Parallel Port Mode and press Enter.

 **Note:**

You can toggle between the Normal (bi-directional), EPP, ECP, and ECP+EPP options using the directional arrow keys.

6. Select the desired setting displays, and press Enter.
7. Press the F10 key to Save and Exit.

My optical drive tray does not open.

Use the Eject button

1. Make sure the computer is turned on.
2. Press the Eject button on the right of the drive.

Use the My Computer icon

1. Click Start in the Windows taskbar, then select My Computer.
2. Right-click the appropriate optical drive icon.
3. Select Eject from the shortcut menu.

 **Note:**

Avoid using adhesive labels to identify your CD media. Adhesive labels may come off while the CD media is in use in your optical drive(s) and may cause damage to the unit.

I cannot play a DVD or CD.

- After inserting your optical disc, wait a few seconds for it to be detected before trying to access it.
- Verify that the disc is in the tray with the label side facing up.
- Install your optical drive software according to the manufacturer's instructions.
- If your drive reads some DVD or CDs, but not others, check the shiny side of the disc for dirt or scratches. You may also need to clean the disc drive lens with an appropriate cleaner.

 **Note:**

To recover the optical drive software applications that are preinstalled on your computer, see [To Use the Application Recovery CD\(s\)](#) for more information.

I cannot play a MiniDisc.

- After inserting your MiniDisc, wait a few seconds for it to be detected before trying to access it.
- If your drive reads some MiniDiscs, but not others, check the shutter or case for possible damage.

I cannot play a DVD.

If a region code warning appears when you are using the DVD player application, it may be that the region code of the DVD you are trying to play is incompatible with the region code setting of your optical drive. A region code is listed on the disc packaging. Region code indicators such as "1" or "ALL" are labeled on some DVDs to indicate the type of player that can play the disc. Unless a "1" or "ALL" appears on the DVD or on its packaging, you cannot play the disc on this system.

If you hear audio but cannot see video, your computer's video resolution may be set too high. To improve video resolution, verify that your screen area is set to 1024 x 768, using 32-bit color (preset factory default). To check your video resolution, see the Troubleshooting topic, [How do I change the video resolution of my display?](#)

If you see video but cannot hear audio, check all of the following:

- Verify that your DVD player's mute feature is turned off.
- Check the master volume setting in the Audio Mixer.

- Check the volume settings on your computer speakers.
- Check the connections between your speakers and the computer.
- Verify that drivers are installed properly, by following these steps:
 1. Click Start in the Windows taskbar, then select Control Panel.
 2. Click Performance and Maintenance and then click Systems. The System Properties dialog box appears.
 3. Select the Hardware tab and then select the Device Manager button to view installed drivers.

A dirty or damaged disc may also cause the computer to stop responding while it tries to read the disc. If necessary, remove the disc and check that it is not dirty or damaged.

Note:

To recover the optical drive software applications that are preinstalled on your computer, see [To Use the Application Recovery CD\(s\)](#) for more information.

When I click an application icon, a message such as "You must insert the application CD into your drive" appears and the software does not start.

- Some software applications require specific files that are located on the application's CD-ROM. Insert the disc and try starting the program again.
- Check to make sure you inserted the CD-ROM with the label side facing up.

Why doesn't my optical drive (DVD-RW or CD-RW) record at the highest speed?

If you are having difficulty formatting DVD-RW or CD-RW media for recording purposes, try changing the write speed to a lower setting.

See the online Help or documentation that came with your DVD or CD recording software for details on adjusting write speed settings.

Why is my computer operating improperly after downloading the CD-burning feature of RealJukebox® software?

Sony does not guarantee the performance of the "Create CD" feature that is provided by the software, RealJukebox2 Basic for Sony. Some CD-ROM drives or drivers may experience problems when using this feature. For more information about this issue, visit the RealNetworks Service and Support Web site at <http://service.real.com>.

How do I change the video resolution of my display?

1. Click Start in the Windows taskbar, and then select Control Panel.
2. Select Appearance and Themes, then select "Change the screen resolution."
3. Click the Settings tab.
4. Change the Screen resolution and Color quality to the desired levels.
5. Click Apply and then click OK.

Why is there no sound in any application?

- Check that the speakers are connected to the proper terminals.
- If your speakers have a mute button, verify that it is turned off.
- If your speakers are powered by batteries, verify that the batteries are inserted properly and fully charged.
- If your speakers use an external power source, verify that the power cord is plugged into a grounded wall outlet or power strip.
- If your speakers have volume control, check the volume level.
- You cannot hear sound from your speakers if headphones are connected to your computer.
- If the software application you are using has its own volume control, check that the volume is turned up.
- Check the volume controls in the Windows® operating system using these steps:
 1. Click Start in the Windows taskbar, then select Control Panel.
 2. Select Sounds, Speech, and Audio Devices, then click "Adjust the system volume."
 3. From the Volume tab, adjust the Device volume by moving the slider bar to the desired sound level.

Verify that the Mute option is not selected.

- Check that the Mute check box is not selected in the Windows volume control.

Note:

You may need to reinstall the sound drivers. See [To Use the Driver Recovery CD](#) for more information.

My modem connection is slow.

Many factors influence modem connection speed:

- Telephone line noise
- Incompatibility with other telephone equipment such as fax machines or other modems.
- Internet Service Providers (ISP) connection capability may vary.

If you think your modem is not connecting properly to other PC-based modems, fax machines, or your ISP, check the following:

- Contact your phone company and ask them to verify that your phone line is free from line noise.
- If your problem is fax-related, check that there are no problems with the fax machine you are calling and that it is compatible with fax modems.
- For optimum performance, verify that your ISP point of presence (POP) phone number is compliant with V.90 standards.
- If you are having a problem connecting with your ISP, check that they are not experiencing technical problems.
- Try connecting your modem through another phone line, if available.

My modem does not work.

Your modem may be experiencing equipment or software conflicts. If your modem is not functioning properly, check the following:

- Check that the phone line is plugged into the Line jack.
- Check that the phone line is working. You can check the line by plugging in a standard telephone and listening for a dial tone.
- Check that the access phone number (POP) is correct.
- All software applications that are preinstalled by Sony are compatible with your computer modem. If you have installed other software, contact the software publisher for information on how to configure the software to recognize the modem.
- If it appears that your modem is not functioning properly, check the device status.
 1. Click Start in the Windows taskbar, then click Control Panel.
 2. Click Printers and Other Hardware and then select Phone and Modem Options.
 3. From the Modems tab, click to select your modem.
 4. Click Properties. The Modem Properties window appears.
 5. Review the information in the Device status section. If your modem is not working properly, click the troubleshoot button. The VAIIO Help and Support Center window appears.
 6. Follow the onscreen instructions to resolve the problem.

Note:

You may need to reinstall the modem drivers. See [To Use the Driver Recovery CD](#) for more information.

Why does my modem disconnect when my computer goes into Stand by mode?

The preinstalled Lucent Win Modem does not support the Wake On Ring (WOR) feature of the Microsoft® Windows® XP operating system. For optimal use, Sony recommends that you do not change the preset modem settings in the Power Management Properties window.

How do I change my modem to rotary or Touch-Tone dialing?

1. Click Start in the Windows taskbar, then click Control Panel.
2. Click Printers and Other Hardware, then click Phone and Modem options.

3. From the Dialing Rules tab, click Edit.
The Edit Location dialog box appears.
4. Select the Tone or Pulse option. Click OK.

My microphone is too sensitive to background noise.

If you find there is too much background noise when you record sound, you should adjust the microphone gain by following these steps:

1. Click Start in the Windows taskbar, then click Control Panel.
2. Click Sounds, Speech, and Audio Devices, then click Sounds and Audio Devices.
3. From the Audio tab, locate the Sound recording section and click the Volume button.
The Recording Control dialog box appears.
4. Select the Options menu and click Properties.
The Properties dialog box appears.
5. In the section, "Adjust volume for," select the Recording option. Click OK.
6. From the Recording Control dialog box, decrease the microphone volume level by moving the slider bar down.
7. Close the Recording Control dialog box and then close the Sounds and Audio Devices Properties window.

My microphone does not work.

Check that the microphone is plugged into the Microphone jack.

My mouse does not work.

- Check that the mouse is plugged securely into the mouse port.
- Save and close all open applications. Turn off your computer, wait approximately 10 seconds, and then restart your computer.
- There may be dust or dirt inside the mouse mechanism. To clean the mouse, follow these steps:
 1. Save and close all applications, and turn off your computer.
 2. Turn the mouse upside down.
 3. Remove the mouse ball cover on the back of the mouse by turning clockwise the ring that covers the mouse ball.
 4. Turn the mouse upright, and drop the mouse ball into your hand.
 5. Using a piece of tape, remove any dust or dirt on the mouse ball and inside the mouse ball socket.
 6. Return the mouse ball to the socket, and replace the mouse ball cover. Secure the cover by turning the ring counter-clockwise.

Note:

You may need to reinstall the mouse drivers. See [To Use the Driver Recovery CD](#) for more information.

My mouse needs to be set up for left-hand use.

1. Click Start in the Windows taskbar, then click Control Panel.
2. Click Printers and Other Hardware, then click Mouse.
The Mouse Properties dialog box appears.
3. From the Buttons tab, select "Switch primary and secondary buttons" under the Button Configuration options.
4. Click Apply, then click OK.

My keyboard does not work.

- Check that the keyboard is securely plugged into the Keyboard port.
- Save and close all open applications. Turn off your computer, wait approximately 10 seconds, and then restart your computer.

I cannot find the Windows® taskbar.

The Windows taskbar may be hidden or minimized.

- Use the mouse to locate a hidden taskbar by pointing to the left, right, top, and bottom edges of the screen. The taskbar appears when the cursor is placed over its location.
 1. Right-click on the taskbar and select Properties from the shortcut menu.
 2. Clear the check box for Autohide the taskbar, then click OK.
- Use the mouse to locate a minimized taskbar by pointing to the left, right, top and bottom edges of the display screen. The taskbar has been located when the cursor changes to a double arrow cursor. Left-click and drag away from the edge of the display screen. The minimized taskbar resizes and becomes visible.

Why is my system running slowly?

- The system responsiveness varies depending with the number of applications that are open and running. Close any applications that you are not currently using.
- Increasing the system memory may also help. For information on installing memory, please see the online VAIO User Guide.

How do I install a printer?

- If your printer has a USB, IEEE1394, or infrared connection, contact the printer manufacturer for information or updates that may be required for proper installation.
- Check the printer manufacturer's Web site for the latest drivers for your operating system before proceeding with installation. Some printers do not function properly without the updated drivers for specific operating systems.
- To install your printer, follow these steps:
 1. Click Start in the Windows taskbar, then click Control Panel.
 2. Click Printers and Other Hardware, then click Add a Printer.
 3. From the Add Printer Wizard, click Next.
 4. Select Local Printer, then click Next.

Note:

Place a check mark in the box for "Automatically detect and install my Plug and Play printer", if you are installing a recently manufactured printer with Plug and Play capability.

5. Select the appropriate port, usually LPT1, and then click Next.
6. Select the appropriate printer manufacturer and model.
7. Follow the onscreen instructions to print a test page and complete printer installation.

Note:

If the printer is not included in the list and the printer manufacturer included a disk with a Windows® XP Printer driver, choose Have Disk, enter the appropriate path for the disk or CD and click OK.

If the printer is not included on the list and no drivers are included with the printer, choose an alternate printer driver that your printer may emulate. Refer to the manual that came with your printer for specific emulation information.

My connected printer doesn't function after the computer resumes from a power saving mode.

Clear the printer memory by turning the printer off for approximately 10 seconds, and then turning it back on.

To contact Sony for technical support

For further technical assistance, call 1-888-4-SONY-PC (1-888-476-6972) or access the Web site at:
<http://www.sony.com/pcsupport>.

The power source

- Your computer operates on 100-120 V AC 50/60 Hz only.
- Plug all the power cords for your computer and its peripheral equipment into the same AC supply line. AC derived from different supply lines may result in voltage differences that can cause unstable operation or unwanted weak currents at the time of connection.
- Do not share the AC outlet with any other power-consuming equipment, such as copying machines or shredders.
- You can purchase a power strip with a surge protector. This device prevents damage to your computer caused by sudden power surges such as those that may occur during an electrical storm.
- If you live in an area that experiences frequent power fluctuations, you may want to purchase an Uninterruptible Power Supply (UPS). This device contains both a surge protector and a battery backup. The surge protector prevents damage to your computer caused by power surges. The battery backup safeguards your data during a brief period of power loss.
- The power control button on the front panel does not turn off the system AC power. To remove power from the system, you must turn off the computer and then unplug the AC power cord from the wall outlet or power strip.
- Do not place heavy objects on the power cord.
- Do not operate the system with the cover removed. Always reinstall the cover before turning on the system.
- To disconnect the cord, pull it out by the plug. Never pull the cord itself.
- Unplug your computer from the wall outlet if you will not be using the computer for a long time.
- Before touching anything inside the computer, turn the system off and let it cool for ten minutes. This will ensure that the processor heat sink will not be hot.
- Do not attempt to open the power supply. There are no user-serviceable parts in the power supply. To avoid personal injury or damage to your equipment, refer the repair or replacement of the power supply to qualified personnel only.

The power source

- Your computer operates on 100-120 V AC 50/60 Hz only.
- Plug all the power cords for your computer and its peripheral equipment into the same AC supply line. AC derived from different supply lines may result in voltage differences that can cause unstable operation or unwanted weak currents at the time of connection.
- Do not share the AC outlet with any other power-consuming equipment, such as copying machines or shredders.
- You can purchase a power strip with a surge protector. This device prevents damage to your computer caused by sudden power surges such as those that may occur during an electrical storm.
- If you live in an area that experiences frequent power fluctuations, you may want to purchase an Uninterruptible Power Supply (UPS). This device contains both a surge protector and a battery backup. The surge protector prevents damage to your computer caused by power surges. The battery backup safeguards your data during a brief period of power loss.
- The power control button on the front panel does not turn off the system AC power. To remove power from the system, you must turn off the computer and then unplug the AC power cord from the wall outlet or power strip.
- Do not place heavy objects on the power cord.
- Do not operate the system with the cover removed. Always reinstall the cover before turning on the system.
- To disconnect the cord, pull it out by the plug. Never pull the cord itself.
- Unplug your computer from the wall outlet if you will not be using the computer for a long time.
- Before touching anything inside the computer, turn the system off and let it cool for ten minutes. This will ensure that the processor heat sink will not be hot.
- Do not attempt to open the power supply. There are no user-serviceable parts in the power supply. To avoid personal injury or damage to your equipment, refer the repair or replacement of the power supply to qualified personnel only.

Disposal of the lithium battery

Dispose of the lithium battery properly. In some areas, the disposal of lithium batteries in household or business trash may be prohibited. You can return your unwanted lithium batteries to your nearest Sony Service Center or Factory Service Center. For the Sony Service Center nearest you, call 1-888-4-SONY-PC (1-888-476-6972).

Caution:

Do not handle damaged or leaking lithium batteries. The lithium battery may explode if mistreated. Do not disassemble it or dispose of it in fire.

Replace the battery with a Sony CR2032 lithium battery. Using a type of battery other than a CR2032 may present a risk of fire or explosion.

Handling the computer system

- Do not place your Sony computer in a location subject to:
 - Heat sources, such as radiators or air ducts
 - Direct sunlight
 - Excessive dust
 - Mechanical vibration or shock
 - Strong magnets or speakers that are not magnetically shielded
 - Ambient temperature of more than 95°F (35°C) or less than 50°F (10°C)
 - High humidity, moisture, or rain
- Do not place electronic equipment near your computer. The computer's electromagnetic field may cause a malfunction.
- Provide adequate air circulation to prevent internal heat build-up. Do not place your computer on loose surfaces (such as rugs or blankets) or near materials (such as curtains or draperies) that may block its ventilation slots. Leave a space of at least 8 inches from the back panel of your computer.
- Clean the cabinet with a soft, dry cloth or a soft cloth lightly moistened with a mild detergent solution. Do not use any type of abrasive pad, scouring powder, or solvent such as alcohol or benzine, as it may damage the finish of your Sony computer.
- Should any solid object or liquid fall into the cabinet, keyboard, or mouse, shut down your computer and then unplug it. You may want to have the computer checked by qualified personnel before operating it any further.
- The computer uses high-frequency radio signals and may cause interference to radio or TV reception. Should this occur, relocate the computer a suitable distance away from the set.
- Use only specified peripheral equipment and interface cables; otherwise, problems may result.
- Do not use cut or damaged connection cables.
- Always switch the power off before connecting your computer to peripheral equipment; otherwise, damage may occur to the integrated circuits in your computer.
- Your computer, keyboard, and mouse consist of high-precision electronic parts. Do not drop them or bump them against other objects.
- Your Sony computer will not work with party lines, cannot be connected to a coin-operated telephone, and may not work with multiple phone lines or a private branch exchange (PBX).
- If the telephone company makes a service call to your home or office and determines that your computer is responsible for the problem, the telephone company may bill you for the service call. If you do not disconnect your computer when it is adversely affecting the telephone line, the telephone company has the right to disconnect your service until you correct the problem.

Moisture condensation

If your computer is brought directly from a cold location to a warm one, moisture may condense inside your computer. In this case, allow at least an hour before turning on your computer. If any problem occurs, unplug your computer, and contact your Sony Service Center.

Upgrading the computer system

- The upgrading procedures described in the online manual, assume familiarity with the general terminology associated with personal computers and with the safety practices and regulatory compliance required for using and modifying electronic equipment.
- Disconnect the system from its power source and from telecommunications links, networks, or modems before you open the system or follow any of the upgrading procedures described in the online manual. Failure to do so may result in personal injury or equipment damage.
- Electrostatic discharge (ESD) can damage disk drives, add-on cards, and other components. Follow the upgrading procedures described in the online manual while working at an ESD workstation. If such a station is not available, use these precautions:
 - Avoid working in a carpeted area
 - Do not handle materials that may produce or hold static electricity, such as cellophane wrappers.
 - Ground yourself by maintaining continuous contact with an unpainted metal portion of the chassis while performing the procedure.
- When removing a slot cover, be careful not to damage components on the system board or add-on cards. You may need to temporarily remove add-on cards that are next to the slot cover you want to remove.

Handling a CRT display

- Do not change the CRT display refresh rate to 85 Hz, as DVD playback and the DVgate software may not function correctly. Sony recommends that you keep your CRT display at the preset, optimal refresh rate (75 Hz).
- Do not place the display near a strong magnetic force.
- Do not block the ventilation slots on the display.
- Using the computer in low temperature conditions may produce a residual image on the screen. This is not a malfunction. When the computer returns to normal temperature, the screen returns to normal.
- A residual image may appear on the screen if the same image is displayed for a lengthy period of time. The image disappears after a period of time. You can use a screen saver to prevent residual images.
- The screen becomes warm during operation. This is normal and does not indicate a malfunction.

Handling an LCD display

- Do not leave the display directly facing the sun for a long period of time as it can damage the LCD screen.
- Do not scratch the LCD screen or exert pressure on it. This may cause damage to the screen or cause a malfunction.
- Using the computer in low temperature conditions may produce a residual image on the screen. This is not a malfunction. When the computer returns to normal temperature, the screen returns to normal.
- A residual image may appear on the screen if the same image is displayed for a lengthy period of time. The image disappears after a period of time.
- You can use a screen saver to prevent residual images.
- The screen becomes warm during operation. This is normal and does not indicate a malfunction.

Using the hard disk drive

- Do not place the computer in a location that is subject to vibration or shock.
- Do not move the computer during operation.
- Do not subject the computer to sudden changes in temperature.
- Do not turn off the power while the computer is accessing the hard disk drive.

Handling floppy disks

- Do not open the shutter manually and touch the surface of the floppy disk.
- Keep floppy disks away from magnets.
- Keep floppy disks away from direct sunlight and other heat sources.

Handling CD or DVD media

- Do not touch the surface of the CD or DVD media.
- Do not drop or bend the CD or DVD media.
- Do not use adhesive labels to identify the CD or DVD media. The label may come off while the disc is in use in the optical drive and damage the drive.
- Always keep media in a safe storage or carrying case.
- Do not place the media where it will be subject to extreme temperatures, moisture, and dust.

Handling MiniDisc media

- Attach the labels supplied with MiniDisc media, in the designated location.
- Do not break open the shutter on the case.
- Do not place the media where it will be subject to extreme temperatures, moistures, and dust.
- Always keep media in a safe storage or carrying case.

Cleaning CD or DVD media

- Fingerprints and dust on the surface of a CD or DVD media may cause read errors. Proper care of the disc is essential to maintain its reliability. Do not use solvents such as benzine, as they may cause damage to the disc. Use commercially available cleaners or anti-static spray.
- For normal cleaning of a CD or DVD media, hold the disc by its edge and use a soft cloth to wipe the surface from the center out.
- If the CD or DVD media is badly soiled, slightly moisten a soft cloth with water, and wipe the surface of the disc from the center out. Wipe off any remaining moisture with a dry soft cloth.

Cleaning MiniDisc media

Clean the MiniDisc case, using a soft, dry cloth. Do not use solvents such as benzine, as they may cause damage to the disc.

Protecting MiniDisc media contents

Slide open the tab located on the side of the MiniDisc. This protects the media contents from being over-written. Slide the tab closed to resume recording.

Support Resources

Check these sources for answers to your questions about your computer or the preinstalled software:

Resource listing

VAIO® QuickStart The QuickStart contains information on how to set up your computer quickly and easily.

VAIO® Computer

User Guide The *User Guide* contains information on how to get the most from your computer, find help, and solve common problems. **(Note: The User Guide is not available in hard copy for all models.)**

VAIO® MX Getting Started Guide The VAIO MX Getting Started Guide contains information on setting up and using the special audio, video, and software features and functions of your computer.

Online (Electronic) Documentation The *User Guide* is available electronically on your hard drive. Two additional guides, *Upgrading and Maintaining your VAIO Computer* and the *Troubleshooting Help* are also available online.

To access online documentation:

1. Click Start and point to VAIO Help and Support Center.
2. Click on the VAIO User Guide.

Software application manuals and online help files Most manuals for preinstalled software are located on your hard disk drive as online help files. You can access online help files from the Help menu within the specific application. A printed manual may be available for some applications.

Knowledge Database This database provides instant access to information on commonly encountered problems. Enter a description of your problem and the Knowledge Database searches for the corresponding solutions online. Access the Sony Knowledge Database on the Sony Computing Support Web site at <http://www.sony.com/pcsupport>.

Sony Fax-on-Demand This service provides you with answers to commonly asked questions. You can use this automated service to request a list of available topics. Select the topics that you want to view. To contact the Sony fax-on-demand service, call 1-888-4-SONY-PC (1-888-476-6972). (Requires a fax machine or fax software.)

Software Updates You can download the latest software updates and patches for your Sony computer by selecting Software Updates on the Sony Computing Support Web site at <http://www.sony.com/pcsupport>.

VAIO Computer System Reference Manual This advanced reference manual supplies detailed technical information about your computer's hardware. This document is available on the Sony Computing Support Web site at <http://www.sony.com/pcsupport>.

Upgrading And Maintaining Your VAIO MX Computer

In the future you may want to increase the functionality of your VAIO® MX computer. This section describes how to upgrade your computer and perform basic maintenance. For more information on upgrading your Sony computer, see the computer *System Reference Manual*. You can download the *System Reference Manual* from the Sony Computing Support Web site at <http://www.sony.com/pcsupport>.

Overview

The procedures in this section assume that you are familiar with the general terminology associated with personal computers and with the safety practices and regulatory compliance required for using and modifying electronic equipment.

Before you upgrade your computer

Disconnect the computer from its power source and from telecommunications links, networks, or modems before you open the unit or follow any of the procedures described in this section. Failure to do so may result in personal injury or equipment damage.

Electrostatic discharge (ESD) can damage disk drives, add-on cards, and other components. Work at an ESD workstation when following the procedures described in this section. If such a station is not available, use these precautions:

- Avoid working in a carpeted area
- Do not handle materials that may produce or hold static electricity, such as cellophane wrappers.
- Ground yourself by maintaining continuous contact with an unpainted metal portion of the chassis while performing the procedure.

When removing a slot cover, avoid rough handling that may damage components on the system board or add-on cards. You may need to temporarily remove add-on cards that are near the slot cover you plan to remove.

Caution:

Electrostatic discharge (ESD) can damage disk drives, add-on cards, and other components. Follow the procedures described here only at an ESD workstation. If such a station is not available, do not work in a carpeted area and do not handle materials that produce or hold static electricity (for example, cellophane wrappers). Ground yourself by maintaining continuous contact with an unpainted metal portion of the chassis while performing the procedure.

Always turn the power off before you open the system or connect your computer to peripheral equipment. Otherwise, damage may occur to the integrated circuits in your computer.

To Remove the Side Panel

1. Shut down your computer and turn off all peripheral devices, such as your printer.
2. Unplug your computer and any peripheral devices.
3. Gently place the system unit on its side, as shown in the illustration.
4. Locate the release tabs on the edge of the side panel. Press and hold the tabs while sliding the panel towards you.
5. When the side panel releases, lift it up and away from the unit.

Removing the Side Panel

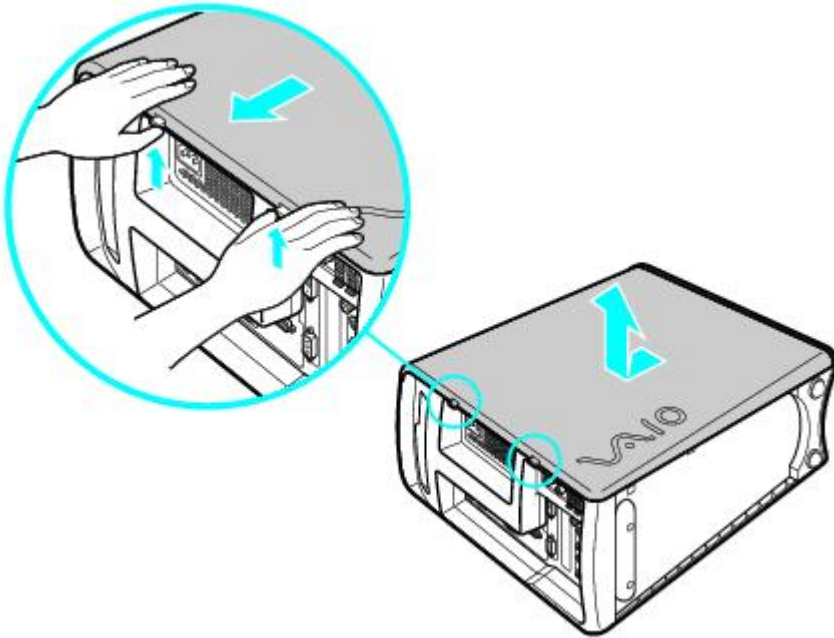

⚠ Caution:

If you remove the side panel immediately after you shut down your computer, the components may be too hot to touch. Wait until the internal parts of the system unit cool down before you attempt to remove the side panel.

To Install a PCI Add-on Card

Your computer may have one or more open PCI expansion slots, depending on the model configuration. A PCI expansion slot enables you to install add-on cards to expand the functionality of your system.

For detailed information on installing add-on cards, see the *System Reference Manual*. You can download the *System Reference Manual* from the Sony Computing Support Web site at: <http://www.sony.com/pcsupport>.

Caution:

Observe the proper safety precautions when you install add-on cards to your Sony computer. See [Before you upgrade your computer](#).

To Install Memory

The preinstalled memory configuration may vary, depending on the computer you purchased. All memory slots in your system may have memory modules already installed. See the Specifications sheet for information about the amount of memory installed in your computer. For memory upgrades, use only 2.5V 64-bit, PC2100 DDR-SDRAM, Dual Inline Memory Modules (DIMM). Your system does not support PC100 or PC133 SDRAM DIMM.

Note:

You can purchase additional memory modules, accessories, and peripheral equipment from your local retailer.

Caution:

Observe the proper safety precautions when you add or remove memory in your Sony computer. Before upgrading your Sony computer, see

Removing memory

1. Shut down your computer and turn off all peripheral devices, such as your printer.
2. Unplug your computer and all peripheral devices.
3. Gently place the unit on its side and remove the side panel. See [To Remove the Side Panel](#).
4. Locate the memory module(s) you wish to remove. If necessary, remove any cables, add-on boards, or other components to access the DIMM slots.
5. Push down on the latches located on each side of the module to release it from the slot.
6. Grasp one edge of the DIMM and lift it out carefully. Store the module in a static-free bag.

Removing/Installing memory

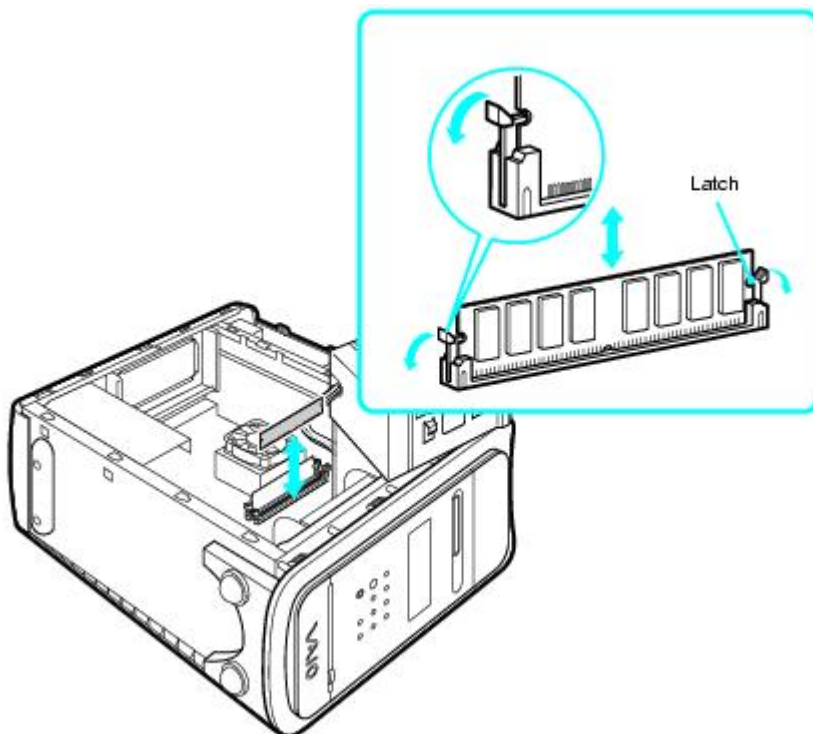

Installing memory

1. Shut down your computer and turn off all peripheral devices, such as your printer.
2. Unplug your computer and any peripheral devices.
3. Gently place the unit on its side and remove the side panel. See [To Remove the Side Panel](#).
4. Locate the memory module slots. If necessary, remove any cables, add-on cards, or other components to access the DIMM slots.

Remove the power supply before installing the memory modules, by following these steps:

- Remove the screw that secures the power supply unit to the chassis.
- Pull the tab that releases the power supply from the chassis.

- Slide the power supply unit up until it clears the chassis.
 - Rotate the power supply to an upside down position and rest it on top of the chassis.
5. Handle the DIMM only by the edges, and remove it from its anti-static package.
 6. Locate the notches on the bottom edge of the DIMM.
 7. Align the module over the open memory slot.
 8. Firmly insert the bottom edge of the DIMM into the slot.
 9. Press down evenly against the upper corners of the DIMM. The end latches snap into position to hold the module in place.
 10. Reinstall any components or add-on cards you removed.

 **Caution:**

To avoid damaging the DIMM slot, move the end latches slightly outward to relieve pressure. The module clicks into place.

11. Reinstall the power supply by following these steps:
 - Rotate the power supply to its original position and slide it into the chassis until the tab snaps into position.
 - Replace the screw that secures the power supply to the chassis.
12. Replace the side panel. See [To Replace the Side Panel](#).

To Replace the Lithium Battery

The lithium battery starts to weaken after several years and the system settings, such as the date and time stored in CMOS RAM, may become inaccurate. Replace the lithium battery when this occurs. For detailed information on replacing the lithium battery, see the *System Reference Manual*. You can download the *System Reference Manual* from the Sony Computing Support Web site at: <http://www.sony.com/pcsupport>.

Caution:

There is danger of the battery exploding if it is replaced incorrectly. Replace the battery only with a CR2032-type lithium battery.

Dispose of the lithium battery properly. In some areas, the disposal of lithium batteries in household or business trash may be prohibited. You can return your unwanted lithium batteries to your nearest Sony Service Center or Factory Service Center. To locate a Service Center near you, call 1-888-4-SONY-PC (1-888-476-6972).

To Install an Additional Hard Disk Drive

Your computer comes with an available internal bay to hold a second standard 3½-inch hard disk drive. Some models, such as Configure-to-order (CTO) systems, may already have a second hard disk drive installed. Your system can support ATA-33, ATA-66, or ATA-100 hard disk drives. Sony recommends using an ATA-100 hard disk drive to take full advantage of your system's features.

Note:

The hard disk drive access light blinks when either internal drive is active.

For detailed information on how to install additional drives, see the *System Reference Manual*. You can download the *System Reference Manual* from: <http://www.sony.com/pcsupport>.

Caution:

Observe the proper safety precautions when you upgrade your Sony computer. See [Before you upgrade your computer](#).

Installing an additional hard disk drive

1. Shut down your computer and turn off all peripheral devices, such as your printer.
2. Unplug your computer and any peripheral devices.
3. Gently place the unit on its side and remove the side panel. See [To Remove the Side Panel](#).
4. Configure the jumpers on the new drive as a slave. See the configuration instructions that came with your drive.
5. Detach the power and drive cables from the hard disk drive that is already installed in your computer.
6. Unlock the drive holder from the chassis by pulling down and pushing the center portion of the tab located at the bottom of the drive holder.
7. Slide the drive holder out.

Removing the drive holder

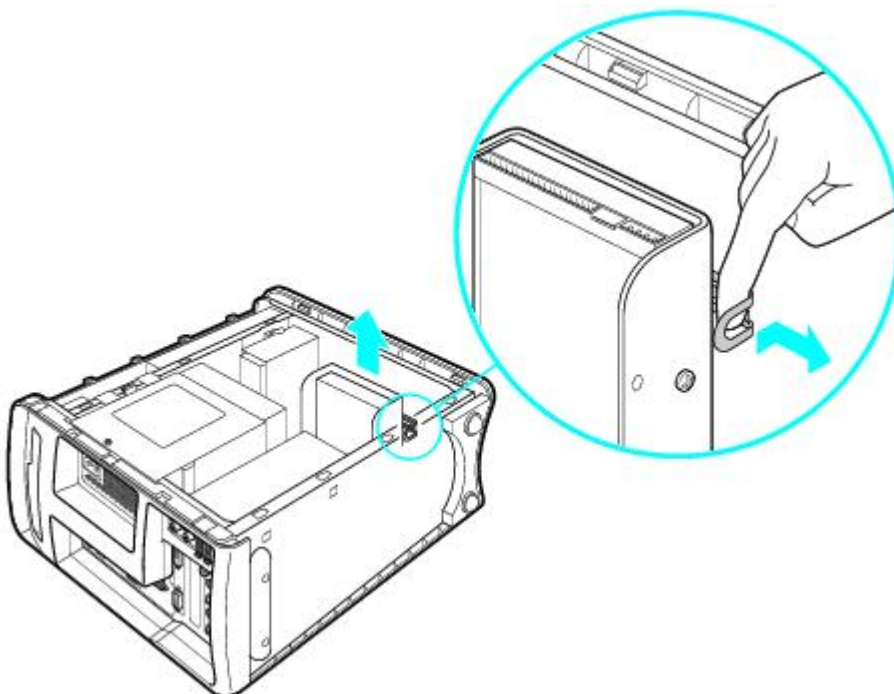

8. Slide the new drive into the drive holder and align the holes on each side of the drive bay.

Attaching the drive screws

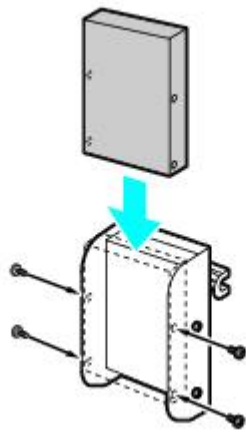

9. Secure the drive to the drive holder with screws, using the two holes on each side of the drive holder.

Note:

Your new hard disk drive is supplied with the necessary screws. Do not overtighten the screws when securing the drive to the drive holder.

10. Align the drive holder with the slots on the inside of the chassis. Slide the drive holder in completely.
11. Push up on the bottom tab of the drive holder to lock it into position.
12. Connect the second drive connector to the new drive. Be sure to orient the connector so that pin 1 on the red side of the ribbon cable is aligned with pin 1 of the new drive.
13. Connect the second power connector to the new drive. See the instructions that came with your drive.

Replacing the drive holder

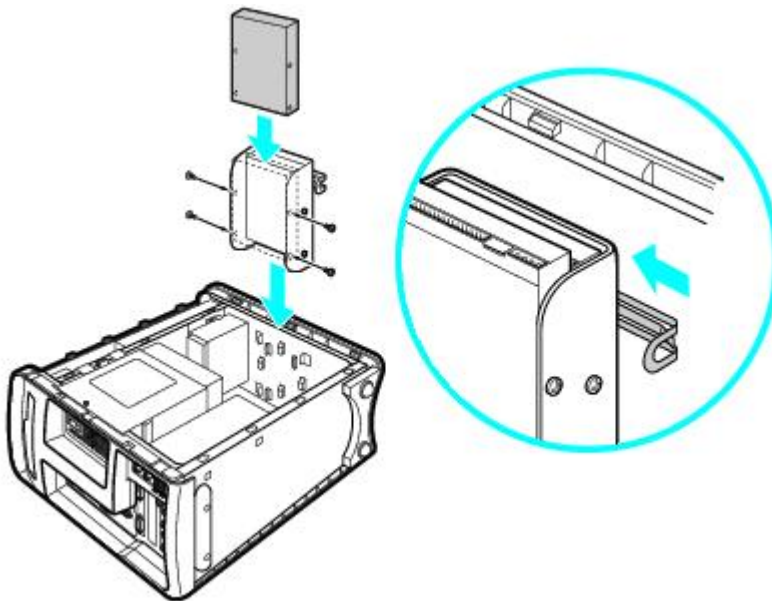

14. Replace the side panel. See [To Replace the Side Panel](#).
15. Reconnect the power to your computer.

To identify additional hard disk space

When you initialize the new hard disk drive, it must be configured as an extended partition in Windows NT file system (NTFS) format.

1. Log on in Windows® as Administrator.
2. Click Start in the Windows taskbar and right-click on My Computer. A shortcut menu appears.
3. Select Manage. The Computer Management window appears.
4. From the file directory on the right, go to Storage and then select Disk Management.
5. Right-click on the newly installed, unformatted drive (Disk label identified with red marking), and from the shortcut menu, select Initialize Disk.
6. Click on the Unallocated area of the drive and then right-click to display the shortcut menu.

7. Select New Partition. The New Partition wizard appears.
8. Follow the onscreen instructions to complete the process.

The Windows® XP operating system recognizes the new hard disk drive and applies the NTFS file system format.

To Replace the Side Panel

1. Carefully align the tabs on the side panel to the chassis frame. The side panel should lie flat against the chassis, with approximately 3/8 inch of clearance between the front edge of the side panel and the front of the chassis.
2. Press the side panel firmly against the unit and slide it forward until the panel snaps into place.

Replacing the side panel

