



USER'S MANUAL FOR BUILT-IN OVEN

Multifunction KS, cod. 7120 043

Foster spa

via M.S. Ottone, 18/20

42041 Brescello (RE) - Italy

tel. +39.0522.687425 - tel. Servizio Assistenza +39.0522.684450

fax +39.0522.686019 - fax Servizio Ricambi +39.0522.962166

e-mail: service@fosterspa.com

www.fosterspa.com

D In Übereinstimmung mit den Anforderungen der Europäischen Richtlinie 2002/96/EG über Elektro- und Elektronik-Altgeräte (WEEE) ist vorliegendes Gerät mit einer Markierung versehen. Sie leisten einen positiven Beitrag für den Schutz der Umwelt und die Gesundheit des Menschen, wenn Sie dieses Gerät einer gesonderten Abfallsammlung zuführen. Im unsortierten Siedlungsmüll könnte ein solches Gerät durch unsachgemäße Entsorgung negative Konsequenzen nach sich ziehen. Auf dem Produkt oder der beiliegenden Produktdokumentation ist

folgendes Symbol  einer durchgestrichenen Abfalltonne abgebildet. Es weist darauf hin, dass eine Entsorgung im normalen Haushaltsabfall nicht zulässig ist. Entsorgen Sie dieses Produkt im Recyclinghof mit einer getrennten Sammlung für Elektro- und Elektronikgeräte. Die Entsorgung muss gemäß den örtlichen Bestimmungen zur Abfallbeseitigung erfolgen. Bitte wenden Sie sich an die zuständigen Behörden Ihrer Gemeindeverwaltung, an den lokalen Recyclinghof für Haushaltsmüll oder an den Händler, bei dem Sie dieses Gerät erworben haben, um weitere Informationen über Behandlung, Verwertung und Wiederverwendung dieses Produkts zu erhalten.

GB This appliance is marked according to the European directive 2002/96/EC on Waste Electrical and Electronic Equipment (WEEE). By ensuring this product is disposed of correctly, you will help prevent potential negative consequences for the environment and human health, which could otherwise be caused by inappropriate waste handling of this product.

The symbol  on the product, or on the documents accompanying the product, indicates that this appliance may not be treated as household waste. Instead it shall be handed over to the applicable collection point for the recycling of electrical and electronic equipment. Disposal must be carried out in accordance with local environmental regulations for waste disposal. For more detailed information about treatment, recovery and recycling of this product, please contact your local city office, your household waste disposal service or the shop where you purchased the product.

F Cet appareil porte le symbole du recyclage conformément à la Directive Européenne 2002/96/CE concernant les Déchets d'Équipements Électriques et Électroniques (DEEE ou WEEE). En procédant correctement à la mise au rebut de cet appareil, vous contribuerez à empêcher toute conséquence nuisible pour l'environnement et la santé de l'homme.

Le symbole  présent sur l'appareil ou sur la documentation qui l'accompagne indique que ce produit ne peut en aucun cas être traité comme déchet ménager. Il doit par conséquent être remis à un centre de collecte des déchets chargé du recyclage des équipements électriques et électroniques. Pour la mise au rebut, respectez les normes relatives à l'élimination des déchets en vigueur dans le pays d'installation. Pour obtenir de plus amples détails au sujet du traitement, de la récupération et du recyclage de cet appareil, veuillez vous adresser au bureau compétent de votre commune, à la société de collecte des déchets ou directement à votre revendeur.

NL Dit apparaat is voorzien van het merkteken volgens de Europese richtlijn 2002/96/EG inzake Afdgedankte elektrische en elektronische apparaten (AEEA). Door ervoor te zorgen dat dit product op de juiste manier als afval wordt verwerkt, helpt u mogelijk negatieve consequenties voor het milieu en de menselijke gezondheid te voorkomen die anders zouden kunnen worden veroorzaakt door onjuiste verwerking van dit product als afval.

Het symbool  op het product of op de bijbehorende documentatie geeft aan dat dit product niet als huishoudelijk afval mag worden behandeld. In plaats daarvan moet het worden afgegeven bij een verzamelpunt voor recycling van elektrische en elektronische apparaten. Afdanking moet worden uitgevoerd in overeenstemming met de plaatselijke milieuvorschriften voor afvalverwerking. Voor nadere informatie over de behandeling, terugwinning en recycling van dit product wordt u verzocht contact op te nemen met het stadskantoor in uw woonplaats, uw afvalophaaldienst of de winkel waar u het product heeft aangeschaft.

E Este aparato lleva el marcado CE en conformidad con la Directiva 2002/96/EC del Parlamento Europeo y del Consejo sobre residuos de aparatos eléctricos y electrónicos (RAEE). La correcta eliminación de este producto evita consecuencias negativas para el medioambiente y la salud.

El símbolo  en el producto o en los documentos que se incluyen con el producto, indica que no se puede tratar como residuo doméstico. Es necesario entregarlo en un punto de recogida para reciclar aparatos eléctricos y electrónicos. Deséchelo con arreglo a las normas medioambientales para eliminación de residuos.

Para obtener información más detallada sobre el tratamiento, recuperación y reciclaje de este producto, póngase en contacto con el ayuntamiento, con el servicio de eliminación de residuos urbanos o la tienda donde adquirió el producto.

P Este aparelho está classificado de acordo com a Directiva Europeia 2002/96/EC sobre Resíduos de equipamento eléctrico e electrónico (REEE).

Ao garantir a eliminação adequada deste produto, estará a ajudar a evitar potenciais consequências negativas para o ambiente e para a saúde pública, que poderiam derivar de um manuseamento de desperdícios inadequado deste produto.

O símbolo  no produto, ou nos documentos que acompanham o produto, indica que este aparelho não pode receber um tratamento semelhante ao de um desperdício doméstico.

Pelo contrário, deverá ser depositado no respectivo centro de recolha para a reciclagem de equipamento eléctrico e electrónico. A eliminação deverá ser efectuada em conformidade com as normas ambientais locais para a eliminação de desperdícios.

Para obter informações mais detalhadas sobre o tratamento, a recuperação e a reciclagem deste produto, contacte o Departamento na sua localidade, o seu serviço de eliminação de desperdícios domésticos ou a loja onde adquiriu o produto.

I Questo apparecchio è contrassegnato in conformità alla Direttiva Europea 2002/96/EC, Waste Electrical and Electronic Equipment (WEEE). Assicurandosi che questo prodotto sia smaltito in modo corretto, l'utente contribuisce a prevenire le potenziali conseguenze negative per l'ambiente e la salute.

Il simbolo  sul prodotto, o sulla documentazione di accompagnamento, indica che questo prodotto non deve essere trattato come rifiuto domestico ma deve essere consegnato presso l'idoneo punto di raccolta per il riciclaggio di apparecchiature elettriche ed elettroniche.

Disfarsene seguendo le normative locali per lo smaltimento dei rifiuti. Per ulteriori informazioni sul trattamento, recupero e riciclaggio di questo prodotto, contattare l'idoneo ufficio locale, il servizio di raccolta dei rifiuti domestici o il negozio presso il quale il prodotto è stato acquistato.

Table of contents

Instructions for the user	3-6
Installation instruction	6-9
Control panel	10
Description of cooking functions	11-12
Cooking table	13
Using the grill	14
Using the rotisserie	14
Minute minder	15
End of cooking 120'	15
Analog programmer	16
Analog timer	16
Electronic programmer	17-29
Turning plate	30-31
Replacing the oven light	32
Removing the oven door	32
Removing the oven door inner glass panel	33-34
Removing and refitting the oven door (when hooked on the side)	35-36
Optional	37
Cleaning and maintenance	38

Thank you for choosing one of our products. It will offer you many years of excellent performance.

Please carefully read the instructions and suggestions contained in this manual for correct use of our products.

TECHNICAL DATA

Dimensions:

Height:	591mm
Width:	597mm
Depth:	547mm

Voltage regulations: 220-230V~ 50/60Hz

Electrical connection:

Make sure that the voltage supply is the same as what is on the rating plate which can be found on the right side of the oven face.

The oven must be connected at the back using a cable with minimum section of 1.5mm providing an omnipole switch in compliance with current regulations with a contact opening distance of at least 3mm.

DECLARATION OF CE COMPLIANCE

This appliance is in compliance with the following European Directives:

93/68 – General regulations

2006/95/CE – Concerning low tensions

89/336/CEE – Electromagnetic compatibility

CE Regulation n° 1935/2004 :

this appliance is suitable to come in contact with food products.

INSTRUCTIONS FOR THE USER

This manual is an integral part of the appliance.

It is necessary to keep it for the life cycle of the oven and to read it carefully for the installation, use, maintenance, cleaning and handling of the appliance.

Unplug the appliance before undertaking any sort of intervention on it.

Attention: earth connection is required by law.

During oven operation, keep children away.

During operation the oven becomes very hot.

Do not touch heating elements on the inside.

Do not use steam cleaners to clean the oven.

Do not use the appliance to heat the room.

The manufacturer will not be held liable if accident prevention measures are not observed.

The manufacturer will not be held liable for damage to persons or property due to poor or lacking maintenance of the appliance.

The manufacturer reserves the right to make any changes to the product which are felt to be useful or necessary without any advance notice.

Packaging materials (sheets, polystyrene) may be hazardous to children (danger of suffocation). Keep packaging materials out of the reach of children.

The appliance is designed for adult users who are familiar with these instructions.

Children are often not able to recognize the risks involved with the use of the appliance.

Please supervise properly and do not let children play with the appliance.

Heat is generated during cooking; the door of the appliance may get very hot, specially if it is made of glass. There is the risk of burns; do not touch and keep children away.

The physically impaired must be assisted by capable adults.

Do not carry out any modifications, tampering or repair attempts, especially with tools such as screwdrivers on the inside or outside of the appliance.

Repair work, especially on the electrical parts, must be performed only by specialized personnel.

Improper repair work can cause serious accidents, damage the appliance and equipment as well as impair proper operation.

Appliances repaired in technical service centres must undergo routine tests, especially a continuity test of the earth circuit.

THIS PRODUCT WAS DESIGNED FOR HOME USE.

THE MANUFACTURER WILL NOT BE HELD LIABLE FOR DAMAGE TO PERSONS OR PROPERTY CAUSED BY IMPROPER INSTALLATION, OR BY IMPROPER, WRONG OR SENSELESS USE.

WARNING: IN CASE OF DISASSEMBLY, MAINTENANCE AND CLEANING OF THE APPLIANCE, PLEASE USE SUITABLE PREVENTION AND PROTECTION EQUIPMENT (GLOVES, ECT.).

In case of a failure in operation or an indispensable repair job, ask for the intervention of the customer technical service centre.

If the oven shows visible signs of damage, do not use it.

Unplug it and contact the customer technical service centre.

The oven must be unplugged as soon as an operating problem is discovered.

Make sure the power cord of the appliance is not crushed by the oven door as this may damage the electrical insulation.

If the power cord has been damaged, it must be replaced by the technical service centre in order to avoid the creation of hazardous situations.

Before closing the oven door, make sure there are no foreign bodies or pets inside the oven.

Do not place heat-sensitive or flammable materials in the oven such as detergents, oven sprays, and so on.

The oven gets extremely hot during operation.

The oven remains hot for a long time, even after it has been turned off, and cools off only very slowly until reaching room temperature. Wait for a suitable period of time before carrying out work such as cleaning.

When opening the oven door, steam and water droplets may come out.

If the oven contains steam, it is not advisable to insert the hands.

Superheated grease and oil may easily catch fire.

Never use water in an attempt to extinguish burning grease or oil (there is the danger of explosion). Suffocate the fire with wet cloths.

The rack, the plates and the cooking containers become extremely hot.

Use insulated glove or pot holders.

When using and maintaining the oven, be careful not to get fingers caught in the door hinges to avoid crushing or other injuries.

This is specially important when children are around.

Leave the door open only in an ajar position.

If the door is open there is the hazard of tripping or crushing the fingers.

Do not sit or lean on the door and do not use it as a work surface.

All work on the appliances must be carried out by qualified personnel.

For maintenance, moving, installation and cleaning of the appliance use suitable prevention and protection equipment (gloves, etc.).

Lifting and moving of appliances weighing more than 25 kg must be carried out using proper equipment, or by two persons, in order to avoid risks or injuries.

Preparation of the oven and pre-use

Attention: the oven must be unplugged from the electrical mains. Before using the oven, carefully clean the interior, the racks and the drip pan with non-abrasive soap and lukewarm water. Insert the racks and the drip pan into their respective runners. When this operation is complete, plug the oven into the electrical mains and bring it up to maximum temperature for at least 20 minutes in order to eliminate any residual grease, oil or resins from manufacturing which may cause unpleasant odours during cooking; then ventilate the room.

After completing this simple operation, the oven is ready to cook for the first time.

Important notices for the installation

The oven can be built into a standard 560mm housing unit (see pics. 1a and 1b), either when built under the work top or built in a tall housing unit.

In both cases ventilation provisions must be made; for this reason, there must be a gap of 85-90mm at the back of the housing unit (see pics. 1a and 1b).

The fixing of the oven in the cabinet is made by 4 screws A that are on the corners of the oven door frame (see pics. 1a and 1b).

When placing the appliance in the housing unit, do not use the oven door as a lever for lifting the oven.

To open the oven door, always take the handle in the middle.

Do not place heavy objects on or lean on the oven door when open, as this can cause damage to the hinges.

Multifunction oven

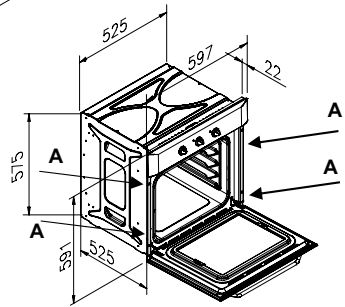
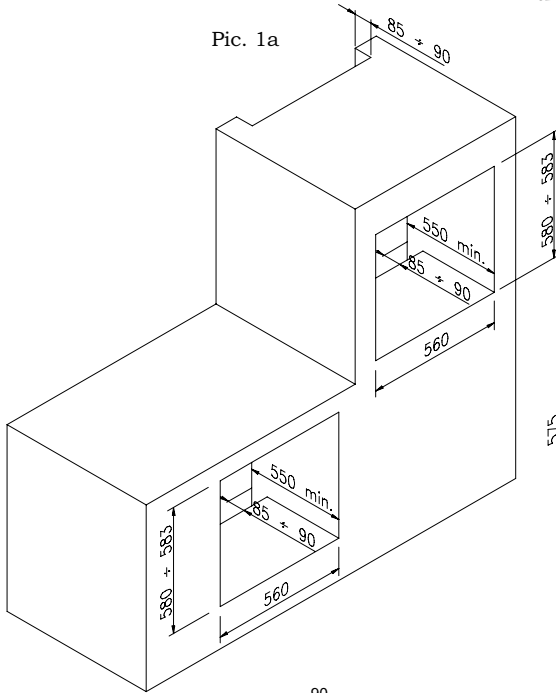

Static oven

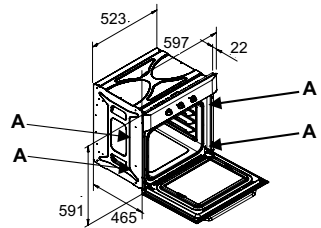
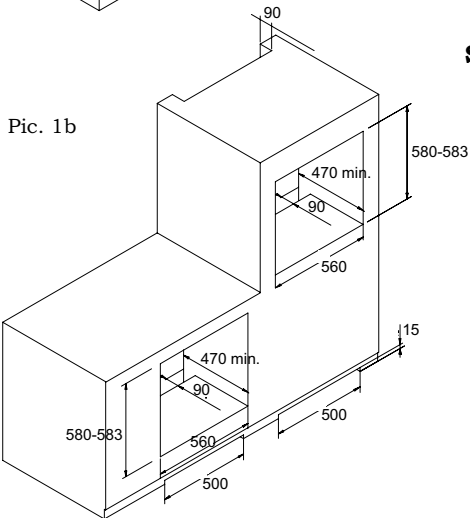

Pics. 1c-1d :
Installation scheme for the oven with reversable door

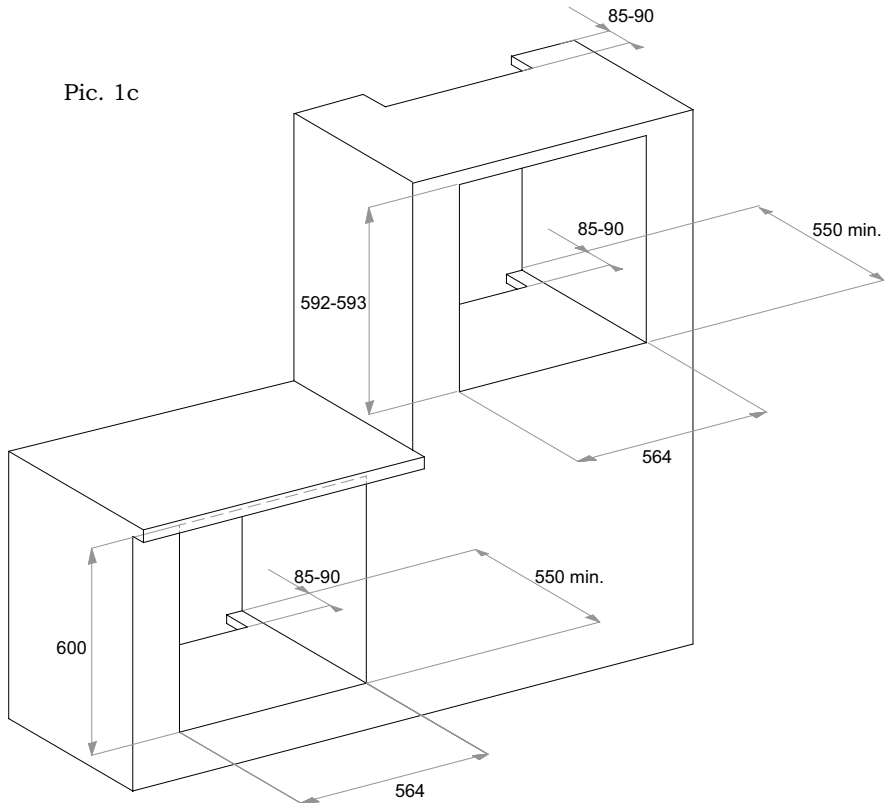

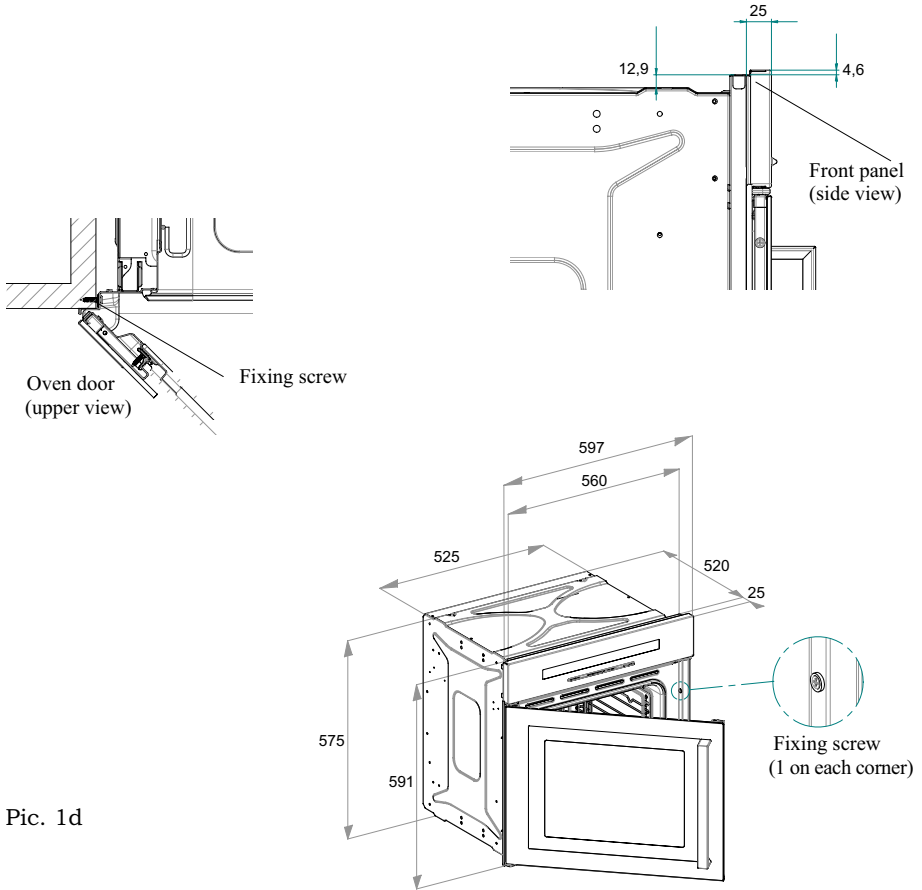

Pic. 1d

Control panel

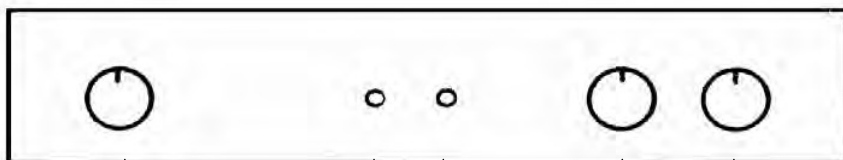

7

5

6

2

1

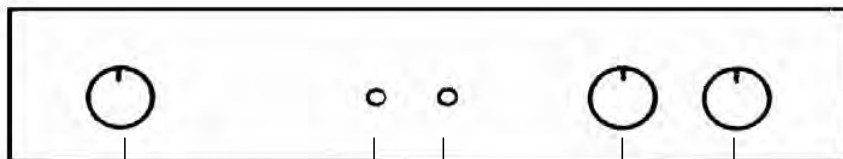

4

5

6

2

1

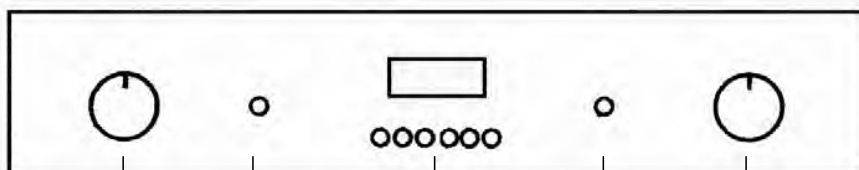

1

5/6

3

6/5

2

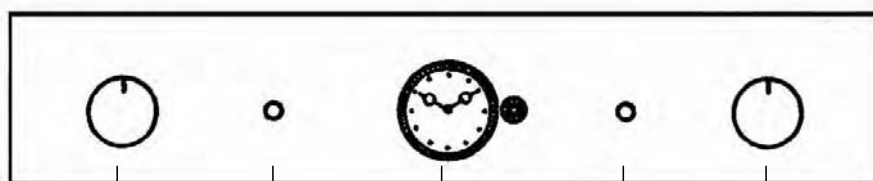

1

6

8

5

2

- | | |
|---------------------|---------------------------------------|
| 1. Thermostat | 5. Green light |
| 2. Selector | 6. Yellow light |
| 3. Electronic timer | 7. Minute minder |
| 4. End of cooking | 8. Analog programmer and Analog timer |

Selector functions:



DEFROSTING

The oven and the green light will stay on during this and all the following functions.

The fan motor comes on, but there is no heat. The oven door should be kept in the close position. Recommended use: for defrosting frozen foods in general, this will help cut down the defrosting time by about on third of the normal time.



TRADITIONAL OVEN COOKING

By turning the thermostat knob, a desired temperature of 50°C to 250°C can be selected. The yellow light will go off when the oven has reached the desired temperature. It is recommended that the oven is pre-heated before introducing the food.



MULTIFUNCTION

The fan and the circular element come on. The heat is diffused by the fan to give an even temperature in the oven by adjusting the thermostat, a desired temperature of 50°C to 250°C can be obtained.

It is necessary to pre-heat the oven before introducing the food.



CENTRAL GRILL ELEMENT

By turning the thermostat knob, a desired temperature of 50°C to 250°C can be selected, keeping the door closed.

Recommended use: for grilling smaller items of food.



DOUBLE GRILL ELEMENT

By turning the thermostat knob, a desired temperature of 50°C to 250°C can be selected, keeping the door half-open or closed. In the latter case the use of the grill deflector is not necessary.

Recommended use: for grilling larger area of food.



SEMI FORCED AIR CONVECTION

The thermostat has to be set at the desired temperature between 50°C and 250°C. The fan and the grill element allow a fast and deep cooking for particular food. It is recommended that the oven be pre-heated for a few minutes.



SEMI FORCED AIR CONVECTION WITH LOWER ELEMENT

The thermostat has to be set to the desired temperature.

It is recommended that you have to pre-heat the oven.

Recommended use: for warming or very slow cooking of food.

Selector functions:



TRADITIONAL COOKING + FAN

By turning the thermostat knob, a desired temperature of 50°C to 250°C can be selected, keeping the door closed. This cooking mode integrates natural convection and ventilation.

Cooking mode suited to bake bread, pizzas and lasagne.

It is recommended that the oven be pre-heated



LIGHT ONLY



BOTTOM ELEMENT ONLY

Select the desired temperature between 50°C and 250°C.

Suitable for very slow cooking and warming up of food.



TOP HEATING ELEMENT

Select the thermostat temperature from 50°C to 250°C.

For keeping cooked food warm or gently reheating.



GRILL + TURNSPIT

By turning the thermostat knob, a desired temperature of 50°C to 250°C can be selected, keeping the door closed.

When the grill is in use the turnspit automatically is on.



SEMI FORCED AIR CONVECTION WITH LOWER HEATING ELEMENT

The fan will come on with the lower heating element.

The thermostat has to be set to the desired temperature.

It is recommended that you pre-heat the oven.

Recommended use: for warming or very slow cooking of food.



PIZZA FUNCTION

This kind of cooking is ideal for pizza and vegetable dishes.

With this function, lower heating element, circular heating element and fan motor work at the same time.



VENTILATED GRILL + TURNSPIT

By turning the thermostat knob, a desired temperature of 50°C to 250°C can be selected, keeping the door closed.

When the grill is in use the turnspit automatically is on.

Cooking table

Type of food	Temp. °C	Insertion* guide	Cooking time in minutes	
			Suggested	Personal
Cake in mould with beaten mixture				
Panettone or focaccia	175	2	55 - 65	
Focaccia	175	3	60 - 70	
Cake	175	3	60 - 70	
Pie in mould (short pastry)				
Pie base	200	3	8 - 10	
Pie base with ricotta cheese	200	3	25 - 35	
Pie base with fruit	200	3	25 - 35	
Cake in mould with raised mixture				
Pie base	180	3	30 - 45	
White bread (2,2 lb of flour)	200	3	25 - 35	
Small pastries				
Puff pastry	200	3	10 - 15	
Choux pastry	200	2	35 - 45	
Biscuit pastry	200	3	15 - 20	
Lasagne	225	2	40 - 50	
Meat (cooking time per cm. of thickness)				
Slowly cooked roast (ex. roast veal)	200	2	120 - 150	
Fast cooked roast (ex. roast beef)	200	2	60 - 90	
Meatloaf	200	2	30 - 40	
Poultry				
Duck 3,3 lb	200	2	120 - 180	
Goose 6,6 lb	200	2	150 - 210	
Roast chicken	200	2	60 - 90	
Turkey 11 lb	175	2	about 240	
Game				
Hare	200	2	60 - 90	
Leg of roe	200	2	90 - 150	
Leg of deer	175	2	90 - 180	
Vegetable				
Baked potatoes	220	2	30 - 40	
Vegetable pudding	200	2	40 - 50	
Fish				
Trout	200	2	40 - 50	
Grey mullet	200	2	40 - 50	
Pizza	240	3	10 - 20	
Grill				
Pork chops		4	8 - 12	
Sausages		4	10 - 12	
Grilled chicken		2	25 - 35	
Roast veal on spit (1,3 lb)			50 - 60	
Chicken on spit			60 - 70	
* The guide number refers to the lowest level (excluding the bottom, since it is not possible to insert the drip-pan)				
THE GIVEN ABOVE DATA ARE INDICATIVE BECAUSE THE COOKING TYPE AND TIME VARIES WITH THE FOOD QUANTITY AND QUALITY				

How to use the grill

Lay the food in the wire shelf or in a tray in case of small pieces.

The rack must be positioned in the highest runner possible and the grease drip pan in the runner below. Close the door and turn on the grill.

CAUTION: WHILE THE GRILL IS OPERATING, THE ACCESSIBLE PARTS ARE VERY HOT.

KEEP CHILDREN WELL AWAY FROM THE OVEN.

Note:

Do not use aluminium foil to cover the grill tray or to wrap the food being cooked, as the reflected heat will damage the grill element and the aluminium foil can catch fire.

Under are few suggestions for cooking with the grill:

Foods to be grilled	Cooking time in minutes	
	Over	Under
Thin meat	6	4
Normal meat	8	5
Fish (e.g. trout, salmon)	15	12
Sausage	12	10
Toast	5	2

How to use the turnspit (where available)

It is possible to use the turnspit and the grill together.

Meat has to be inserted onto the skewers and blocked by the two clamps.

Proceed now as follows:

Fit the tip of the spit in the hollow shaft of the motor on the back of the oven.

Rest the support in the spit groove.

Unscrew and remove the handgrip.

Fit the drip pan in the lowest runner.

Set the selector to the turnspit position to operate the motor.

At the end of cooking, tighten the spit handgrip and take it out of the oven (see pic. 2).

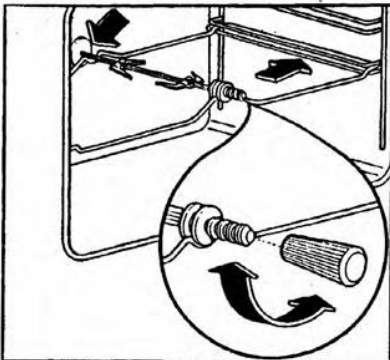

Pic. 2

Programming your oven with mechanical 60 minutes timer - Pic. 3

The regulating knob (pic. 3) must be turned in a clockwise direction until it reaches the 60 minutes position and then turned to the desired time by turning the knob in a counter clockwise direction.

The oven will not be turned off automatically. A minute counter ringing will advise that the cooking time is over.

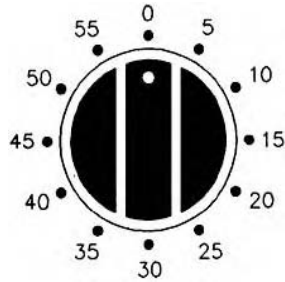

Pic. 3

Programming your oven with electrical 120 minutes cut-off timer - Pic. 4

The function of the programming timer is to turn on the oven for a pre-determined amount of time.

1. OPERATING

After having set the oven switch knob at the desired temperature, turn the timer knob in a clockwise direction to the desired cooking time (maximum 120 minutes).

When the timer will return to position "0", a minute counter ringing will advise that the oven will automatically turn off.

2. MANUAL POSITION

If the cooking time is longer than the 2 hours programme, or if you wish to use the oven manually, to turn it off when you desire, turn the knob to position  (Pic. 4).

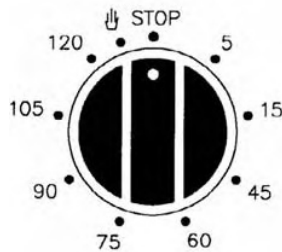

Pic. 4

Analog programmer - Pic. 5

Regulate time by pressing and turning the knob "A" anti-clockwise.

Select the beginning of cooking time by pulling and turning the knob "A" anti-clockwise until the index "B" coincides with the desired time of cooking beginning.

Select the end of cooking time by turning the knob "A" anti-clockwise until the desired time (max 180) coincides with the fixed index (corresponding to XII).

At the end of cooking the oven automatically stops and a bell sounds until the knob "A" is turned to the symbol ☒ .

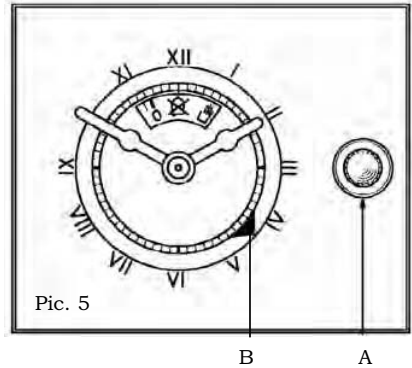

If you want to use the oven excluding the programmer (manual running) turn the knob "A" until the symbol ☞ coincides with the fixed index.

Analog timer - Pic. 6

Setting the clock: to set the clock, press and turn the knob "A" in a clockwise or anticlockwise direction.

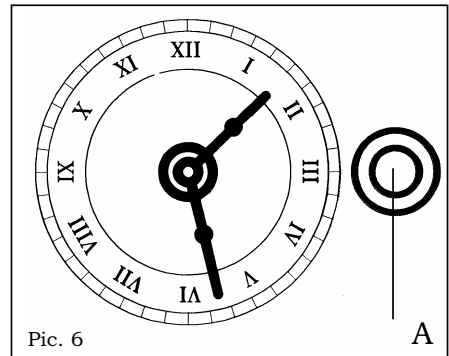

Electronic programmer - Pic. 7

The electronic programmer is a device which groups together the following functions:

- 24 hours clock with illuminated display
- Timer (up to 23 hours and 59 min.)
- Program for automatic beginning and end of cooking
- Program for semi-automatic cooking (either start or finish only).

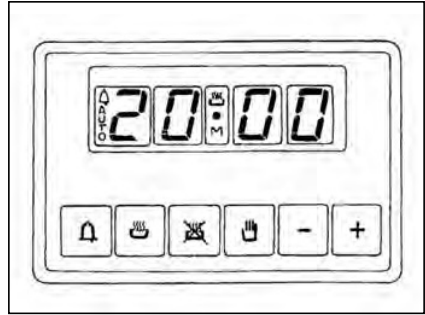

Pic. 7

Description of buttons



“ TIMER ”



“ COOKING TIME ”



“ END OF COOKING TIME ”



“ MANUAL POSITION ”



“ ADVANCEMENT OF THE NUMBERS OF ALL PROGRAMS ”



“ TURNING BACK OF THE NUMBERS OF ALL PROGRAMS ”

Description of lighted symbols

« AUTO » - (flashing) - Programmer in automatic position but not programmed.

« AUTO » - (always lighted) - Programmer in automatic position with inserted program.



Automatic cooking taking place



Timer in operation





and « AUTO » (both flashing) – Program Error.

No lighted symbol except clock numbers:
programmer on manual set.

Digital clock

Clock numbers show hours (0-24) and minutes.

Upon immediate hooking up of the oven or after a blackout, three zeros will flash on the programmer panel.



To set the hour it is necessary to push simultaneously the  +  buttons and AT THE SAME TIME to push the [+] button or [-] until you have set the exact hour. The regulation speed depends on the pressure exercised on the [+] [-] buttons.

Manual cooking without using the programmer

To use manually the oven, that is, without the auxiliary programmer, it is necessary to cancel the flashing «AUTO» by pushing the  button.



If «AUTO» is always flashing (it means a cooking program is still memorized) it is necessary to cancel the inserted cooking program by pushing the  button until setting the clock on zero.

Automatic cooking (start and end)

- 1) Set the length of cooking time by pushing the  button.
- 2) Set the end of cooking time by pushing the  button.
- 3) Set temperature and cooking program by using the thermostat knob and the selector knob.

After this setting the symbol «AUTO» will flash, this means the oven has been programmed.

An example: cooking lasts 45 minutes and is expected to stop at 14.00.

- Push  until having set 0.45.
- Push  until having set 14.00.

After having finished the setting, the clock hour will appear on the panel and «AUTO» symbol will flash permanently. This means the cooking program has been memorized.

At 13.15 h. (14.00 h. minus 45 minutes) the oven turns on automatically. During cooking time the  button and «AUTO» are flashing.

At 14.00 h. the oven turns off automatically, a buzzer goes on until it is stopped by pushing the  button.



Semi-automatic cooking

A. Set the length of cooking time



B. Set the end of cooking time

A) Set the length of cooking time by pushing the  button. The oven will turn on immediately.

«AUTO» and the  symbols will light. When the set cooking time has elapsed, the oven will turn off, a buzzer will ring until it is stopped as above described.

B) Set the end of cooking time by pushing the  button. The oven will turn on immediately. «AUTO» and  will light. At the set time, the oven will turn off and a buzzer will ring until it is stopped as above described.

The cooking program may be seen at any moment by pushing the corresponding button.

The cooking program may be cancelled at any moment by pushing the  until zero appears on the display. Then by pushing the  button the oven can work manually.



Timer = buzzer

The timer program consists only of a buzzer which may be set for a maximum period of 23 hours and 59 min.

To set the timer, push the  button and, at the same time, [+] or [-] until you read the desired time on the display.

After the setting, the clock hour and the  symbol will appear.

The countdown will start immediately and may be seen at any moment on the display by simply pressing the  button.

At the end of the set time, the  symbol will turn off and the buzzer will ring until it is stopped by pressing the  button.

ATTENTION! An energy blackout makes the clock go to zero and cancels the set programs.

After a blackout three zeros will flash on the panel and cooking can be programmed once again.



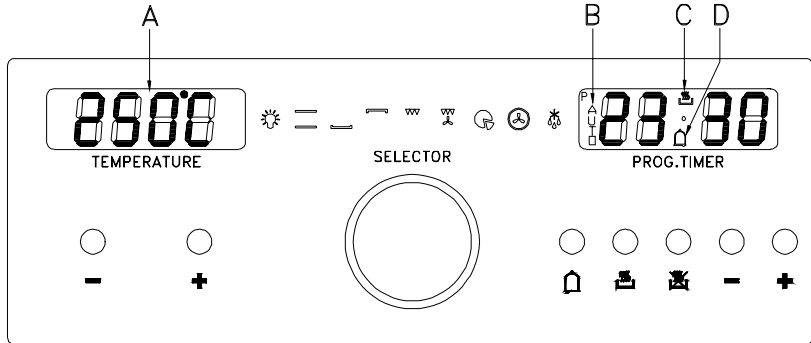

You can also adjust the sound level of the audio signal by pressing the symbol " - " : the audio signal can be adjusted to 3 different levels.

This operation must be performed after the time setting.



USING THE ELECTRONIC PROGRAMMER (pic. 8)





Pic. 8

- A Temperature
 - B Automatic programme
 - C Duration and manual mode
 - D Minute minder
- | | | |
|---|--------------------------------------|-----------------------|
|  | F
U
N
C
T
I
O
N | Timer |
|  | | Cooking duration time |
|  | | Cooking end time |
|  | | Minus setting |
|  | | Plus setting |

Setting the clock

Switch the oven on; 00.00 will appear in blinking mode on the display. To set the clock, simultaneously press the duration  and end of cooking  keys together. Using the +/- keys on the right, select the time of day required. With the key “+” the time increases, with the key “-” the time decreases at a speed directly proportional to the duration of the pressure exerted on the key. When the time is stored, the point between the hours and the minutes will stop blinking approximately 7 seconds after the last operation. To update the time, repeat the operation.

Manual operation

Press duration  and end time button  together. If an automatic program is on the “AUTO” symbol (B) will be erased, the pot symbol (C) is illuminated. Any programme which has been previously set is cancelled.



Semiautomatic operation with cooking duration

Select cooking duration function  and set required duration with the +/- keys on the right. “AUTO” (B) and cookpot (C) symbols appear. If time of day = cooking end time the relay output and the cookpot symbol (C) are switched off. The audible signal sounds. The symbol “AUTO” (B) blinks. The cooking will be finished.

Semiautomatic operation with cooking end time

Select cooking end time function  and set required end time using the +/- keys on the right. The “AUTO” (B) and cookpot (C) symbols appear. Turn the switch knob and the thermostat knob to the cooking function and to the desired temperature. If time of day = cooking end time the oven doesn't heat any longer and the cookpot symbol (C) are switched off. The audible signal sounds and “AUTO” (B) blinks.

Fully automatic operation

- 1) Set the length of cooking time by pushing the  button and the +/- keys on the right.
- 2) Set the end of cooking time by pushing the  button and the +/- keys on the right.
- 3) Set temperature and cooking program by using the thermostat knob and the selector knob.

After this setting the symbol “AUTO” (B) will appear, this means the oven has been programmed. When the time in the display is the same of the cooking start time the cookpot symbol (C) will appear and the oven will start to work.

Cooking Start Time= Cooking End Time – Cooking Duration Time
An example: cooking lasts 45 minutes and is expected to stop at 14.00.

- Push  and “+” key on the right until having set 0.45.



- Push  and “+” key on the right until having set 14.00.

After having finished the setting, the clock hour will appear on the panel and “AUTO” symbol (B) will flash permanently. This means the cooking program has been memorized.



At 13.15 h. (14.00 h. minus 45 minutes) the oven turns on automatically. During cooking time the cookpot button (C) and “AUTO” (B) switch on.

At 14.00 h. the oven turns off automatically, “AUTO” (B) flashes. The cookpot button (C) switches off and a buzzer goes on until it is stopped.

Minute counter



Select the minute counter function . The fixed time is set at 5 min.; to change it, press the keys +/- on the right. When the point between the hours and minutes and the symbol  begin to blink, it means that the countdown has begun. The display shows the hour and the minutes of the countdown; by pressing the symbol  you can choose whether to display the countdown or the time.

Audible signal

The audible signal sounds at the end of a minute counter cycle  or of a cooking programme  for a period of 7 minutes. To turn it off just press any program input key (the first three on the left).

You can also regulate the sound level of the audio signal, selecting a more pleasing level, by pressing the symbol “-” on the right for about 2 seconds when you see the time on the display.



Program start and control

Press the cooking duration key  or the end-of-cooking time key  to know the remaining time period.

Input error signal

When a data input is mistaken the audio signal sounds and the symbol “AUTO” (B) flashes.

Cancelling a program

A program can be cancelled pushing at the same time the button  and .

Switch functions

The following functions can be set by turning the switch knob.

The following will be shown on the display:



Light



190°C



50°C



190°C



250°C



165°C



165°C



165°C



Defrost



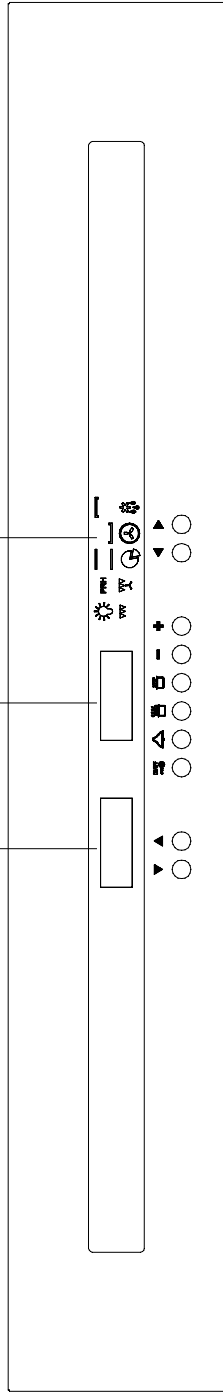

The temperature shown on the display can be changed via the keys +/- on the left. Increase or decrease is in 5°C steps, from a minimum of 40°C to a maximum of 250°C. The symbol °C will blink until the required temperature is reached.

ELECTRONIC PROGRAMMER

TEMPERATURE
DISPLAY TIMER
DISPLAY COOKING FUNCTIONS
DISPLAY





FUNCTION BUTTONS

- ▼ Decreases temperature
- ▲ Increases temperature
-  ON/OFF and Controls Lock Function
-  Minute minder
-  Cooking time
-  End time
- Time setting
- + Time setting
- ◀ Program setting
- ▶ Program setting

OPERATION

The timer flashes on the display when switched on for the first time or after a power cut, and the oven cannot be operated; follow the “Setting the time” procedure to start it.

SETTING THE TIME

Press buttons  and  simultaneously and then release them.
Use buttons — and + to set the exact time.

Note: this operation must be completed in 3 sec. time, while the 2 dots on the timer display keep flashing.
Once you have completed the time setting, wait for the 2 dots stop flashing.

SOUND SIGNAL

The oven performs sound signals to show different functions, as for example the end of cooking.

There are 3 different sound levels, which can be modified:

When the oven is switched off, press the — key, and with each pressure the oven performs the sound to a different level; the last one performed will be automatically set.

SWITCHING ON THE OVEN



Press and release the  key, then you will hear a sound signal.

The timer display will show ON, the bulb symbol  lights on and the internal oven light turns on. Now you can proceed to set a cooking function.

MINUTE MINDER





The minute minder is only a counter of time and it is totally independent from any cooking function.

It can be useful, for example, when set to remember to stop a cooking operation. It can be used also when the oven is switched off.



To set the minute minder, switch on the oven by pressing and releasing the  key, then press the  key:



The display reset to zero and the 2 dots start flashing. Now you have 3 seconds to set the desired time by using the keys — and + up to 23h59m.

Once the set time has elapsed, you will hear a sound signal and the  symbol flashes.

To stop the sound and the flashing symbol just press one of the following keys     — +

MANUAL OPERATION FOR AN INDEFINITE PERIOD OF TIME

Switch on the oven and select an available cooking function using the keys  and  :



The oven will suggest a preset temperature, which can be changed by using the keys  and  . The oven will start working up to the preset temperature and the centigrade degree symbol ° starts blinking, which means the preheating of the oven.



When the requested temperature is reached this symbol stops blinking and the oven beeps.

To switch off the oven, just press and release the  key.





COOKING TIME SEMIAUTOMATIC OPERATION



It is recommended to set the duration of cooking

Switch on the oven by pressing and releasing the , then press and release the  key. On the timer display the symbol  appears. Set the desired time of cooking with the keys - and + up to 10h and 00m.

Then you will hear a sound signal and the timer will show the current hour: you can select an available cooking function with the keys  and .

On the timer display the symbol  appears.

The oven suggests a preset temperature for each function, which can be changed with the keys  and . The oven starts working for the set time; when this time has elapsed the oven automatically stops cooking. You will hear a sound signal, while the temperature display and the cooking function display turn off, the timer display shows the current hour and the symbols  and  blink.



To stop the sound and exit to the program, just press one of the following keys    - +



The symbol  appears on the function display and then the oven light turns on.

Now the oven is ready to be programmed again; you can select a new cooking function or switch the oven off by pressing and releasing the key .



END OF COOKING SEMIAUTOMATIC OPERATION

It is recommended to set the end of cooking time



Switch on the oven by pressing and releasing the , then press and release the  key. On the timer display the symbol  appears. Set the desired end of cooking time with the keys - and + up to 23h and 59m.

Then you will hear a sound signal and the timer will show the current hour: you can select an available cooking function with the keys  and .

On the timer display the symbol  appears.

The oven suggests a preset temperature for each function, which can be changed by using the keys  and .

The oven starts cooking and when fixed time has elapsed, it will automatically turn off.

At the end of the fixed cooking time, the oven beeps, the temperature display and the cooking function display turn off, the timer display shows the current hour and the 2 symbols  and  blink.

To stop the oven beep or to cancel the program just push one of the following keys:



   - +

The symbol  appears on the function display and then the oven light turns on.

Now the oven is ready to be programmed again; you can select a new cooking function or switch the oven off by pressing and releasing the .

AUTOMATIC OPERATION

It is recommended to set the duration and the end of cooking

Switch on the oven by pressing and releasing the , then press and release the  key and set the duration of cooking with the - and + keys.

Then you will hear a sound signal and the timer will show the current hour. Press the  key and set the end of cooking with the - and + key.

Another sound signal will be heard and the 2 dots stop blinking: this means the time has been set.

On the display you will see the set time, the temperature and function.

The oven light turns off.



Now select an available cooking function with the ◀ and ▶ keys.

The oven suggests a preset temperature for each function, which can be changed by using the keys ▼ and ▲ .

Once the 2 dots have stopped blinking, the oven begins the delayed start mode: it will automatically start for the requested duration and stop at the requested time.

When the oven is cooking, you see the selected temperature, the current hour and the selected function on the corresponding displays. The internal oven light turns off.

However, both the temperature and the function can be changed by repeating the above mentioned instructions.

At the end of the program, the oven beeps, the temperature display and the cooking function display turn off, the timer display shows the current hour and the 2 symbols  and  blink.

To stop the sound signal or to cancel the program just push one of the following keys:



The symbol  appears on the function display and then the oven light turns on.

Now the oven is ready to be programmed again; you can select a new cooking function or switch the oven off by pressing and releasing the  key .

AUTOMATIC AND SEMIAUTOMATIC COOKING RESTRICTIONS

The preheating (PRH) and defrosting functions are not compatible with the above mentioned automatic and semiautomatic operation.

-After setting the preheating or the defrosting function, it is not possible to set either the duration or the end of cooking.

-When programming the oven with the automatic operation, you cannot choose the preheating or the defrosting function.

DISPLAY SYMBOLS



Pot: when it lights up, it shows that a cooking function is on.

The pot does not light up when the oven light, preheating or defrosting function is activated.

When the pot is flashing, it shows the end of a cooking time. During the delayed start phase, the symbol is off and lights up when the oven starts cooking.

A (automatic): when it lights up, it shows that a cooking time has been set; when flashing, it means the end of a cooking program.



Bell: when it lights up, it means that the minute minder is on.

When flashing, it means the end of the minute count.

SELECTING THE COOKING TEMPERATURE

With the oven switched on, the cooking temperature can be selected by using the ▼ and ▲

keys : the temperatures increases between the low and high setting with 5 degrees increases, which are shown on the temperature display.

Note: each cooking function has a preset temperature, which can be changed as described above.

SELECTING THE COOKING FUNCTION

With the oven switched on, the cooking functions can be selected by using the ◀ and ▶ keys:

the cooking function icons sequentially light up.

COOKING FUNCTIONS



OVEN LIGHT

The internal oven light turns on by pressing and releasing the  key. To turn it off press and release again the same key.

When selecting a cooking function, the oven light turns on, and once the selected temperature is achieved, the light remains on for another 3 minutes.

During a cooking operation or defrosting it is possible to turn on the oven light by pressing one of the following keys

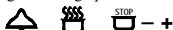

The light remains on for 1 minute.

The light can also be turned on when the Controls Lock function is active by pressing

one of the following keys

PRH PREHEATING

This function allows to preheat faster the oven, before choosing a cooking function.

When this function is operating, a moving symbol appears on the temperature display.

The preheating ends when its preset temperature is achieved by the oven; this temperature cannot be changed. At this point, the oven beeps, the light symbol and the oven light turn on. Now you can choose an available cooking function with the ◀ and ▶ keys.



TRADITIONAL COOKING



This provides traditional cooking with heat from the top and bottom elements.



LOWER ELEMENT MODE

This is for slow cooking or for warming up meals.



TOP ELEMENT MODE

This is for gentle cooking, browning or keeping cooked dishes warm.



GRILL HEATING ELEMENT

It is suggested for grilling food.



GRILL HEATING ELEMENT WITH FAN

This function is suggested for a gently grilling of food.



PIZZA FUNCTION

This kind of cooking is ideal for pizza and vegetable dishes.



FAN OVEN MODE

This provides even heating with the fan and allows different dishes to be cooked at the same time on different levels.



DEFROST MODE

This function allows to reduce the defrost time for frozen food.

The fan runs without any heating of the oven.

On the temperature display appears the message **dEF**, which means this function is active.

OTHER FUNCTIONS

OVEN OFF MODE

When the oven is switched off, the temperature and program displays are off and the timer shows the current hour.

“CHILDREN CARE” - CONTROLS LOCK FUNCTION

This function can be activated in any moment to prevent children to play with the oven.

In particular, if this function is activated with the oven turned off, it will not be possible to switch the oven on: to operate with the oven it is necessary to remove the lock.

To activate the locking function, hold down the key  until the display shows the symbol **h--0** (about 5 sec.) followed by **ON**, then the display shows again the current hour.

Note: once you have done this operation, it cannot be set any program or cooking function, except for the setting of the minute minder.

If the lock is activated after any program or cooking function, it will only be possible to set the minute minder or switch off the oven by pressing and releasing the  key.



By pressing any other key, the **h--0** display  will remember you that the locking function is activated.

The automatic or manual switching off of the oven will not disable the locking function.

To disable the locking function hold down the  key until the **h--0** display (about 5 sec.) followed by **OFF**, then the display shows again the current hour.

When the locking function is activated it is not possible to switch it on with the  key, but only to switch it off.

ON / OFF BUTTON

When the oven is switched on, the  key lets you to switch off the oven whatever function is selected and in any moment. To switch off the oven, just press and release the  key.

When switching off the oven, any cooking function or program is cancelled. To set a new cooking program, follow the corresponding instructions from the beginning.

When the oven is switched on and the locking function is activated, you can switch off the oven just pressing and releasing the  key, but the locking function keeps active.

To disable the lock hold on the  key for about 5 seconds until the **h--0** display followed by **OFF**, then the display will show the current hour.



“ ° ” SYMBOL

This symbol appears on the temperature display and represents the centigrade degrees.

If the symbol is blinking it means the oven is heating up to reach the temperature that has been set.

If the symbol is permanently on it means that the set temperature has been reached.

TIMER RESET

With the oven switched on, it is possible to reset the settings of the timer by pushing together the  and  keys.

Attention: the oven keeps switched on with the set function, and in manual operation.

It is possible to set again a cooking program, or also switch off the oven by pressing and releasing the  key.

The turning plate (pics. 10-13)

The turning plate works combined with the radial fan, as it can be found in the oven functions descriptions.

On the bottom of the oven cavity is fixed the flange with the motor of the turning plate (pic. 10);

The appliance is equipped with the following parts:

- a support for the turning plate (pic. 12), which has to be fitted on the flange (pic. 11);
- a round external support for the turning plate (pic. 12), to be placed on the corresponding guide on the oven bottom (pic. 10).
- a glass turning plate (pic. 13), to be placed upon the round support;
- a round shelf (pic. 13), to be placed upon the glass turning plate.

Notes:

Always put the food container in the middle of the round shelf.

Always use oven gloves when moving the internal oven parts and baking pans:

there is a risk of burns and scalds.

Before cleaning the turning plate, wait until it has cooled down.

The plate direction of rotation can be both clockwise and counter-clockwise, as the rotating motor does not have a set rotation direction.

Use baking pans with a low edge and having proper dimensions for the oven cavity.

Handle with care the glass plate, to avoid the risk of cracks.



Pic. 10

flange with motor
(fixed on the bottom of the oven)

guide for the round external
support of the turning plate

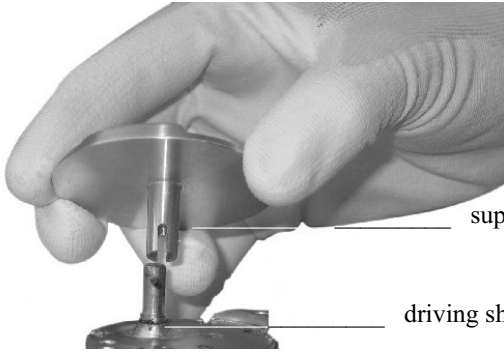

Pic. 11

support for turning plate

driving shaft (not visible)

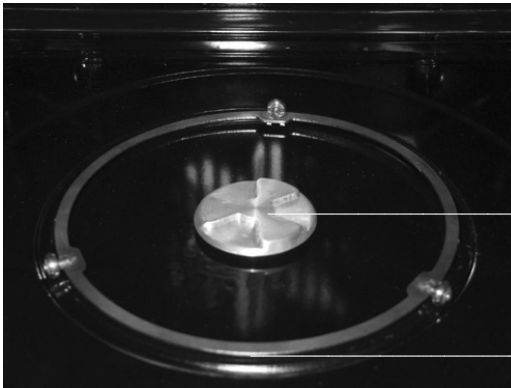

Pic. 12

support for turning plate

round external support
for turning plate



Pic. 13

shelf

glass turning plate

Replacing the oven light - Pic. 14

The oven is equipped with a lamp having the following features:

25W

screw cap E-14

T 300° C

WARNING: disconnect the appliance from the power supply.

If the oven light needs to be replaced, the protective cover «A» must be removed by turning it anticlockwise. After the light has been replaced, refit the protective cover «A». (Pic. 14).

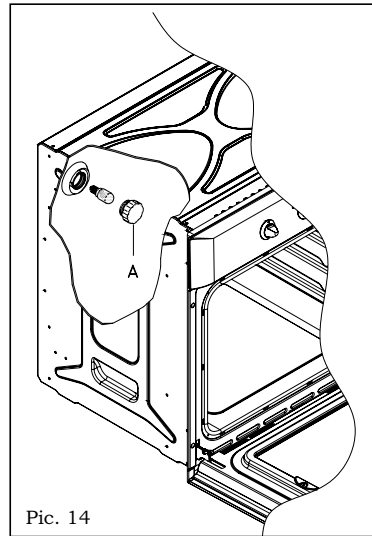

Pic. 14

Removing the oven door -Pic. 15

To aid cleaning and make access to the oven interior easier, the oven door can be simply removed.

To facilitate cleaning of the oven, the door can be removed via the hinges as follows:

hinges with movable bolt

We recommend to take the handle in the middle when opening the oven door.

With the door open, you can see the 2 hinges A which are provided with 2 movable bolts B. When the bolt B is raised, the hinge is released from its housing.

Having done this, the door must be lifted upwards and removed, sliding it towards the outside;

grip the sides of the door near the hinges when performing these operations.

To refit the door, firstly slide the hinges into their slots.

Before closing the door, **remember to rotate the two movable bolts B** used to hook the two hinges.

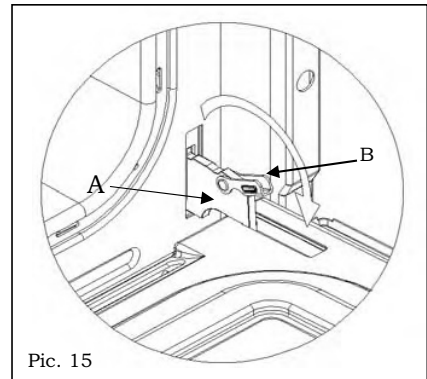

Pic. 15

REMOVING THE OVEN DOOR INNER GLASS PANEL (fig. 1-2)

Do not use any abrasive medium that could cause damage.

Remember that if the surface of the glass panel becomes scratched, this could lead to a dangerous failure.

To remove the oven door inner glass panel, use a coin to perform a levering action in the two grooves (A) until the two pins (B) are released from their housing (fig. 1).

Then raise the glass as shown in fig. 2 and take it out from the top.

To refit the door, repeat the two previous operations in reverse.

Reinsert the glass by resting it on the inner door and pushing it in. Press on the glass until the pins slot back into their initial position (fig. 2).

REMOVING THE OVEN DOOR INNER GLASS PANEL (pics. 16-17)

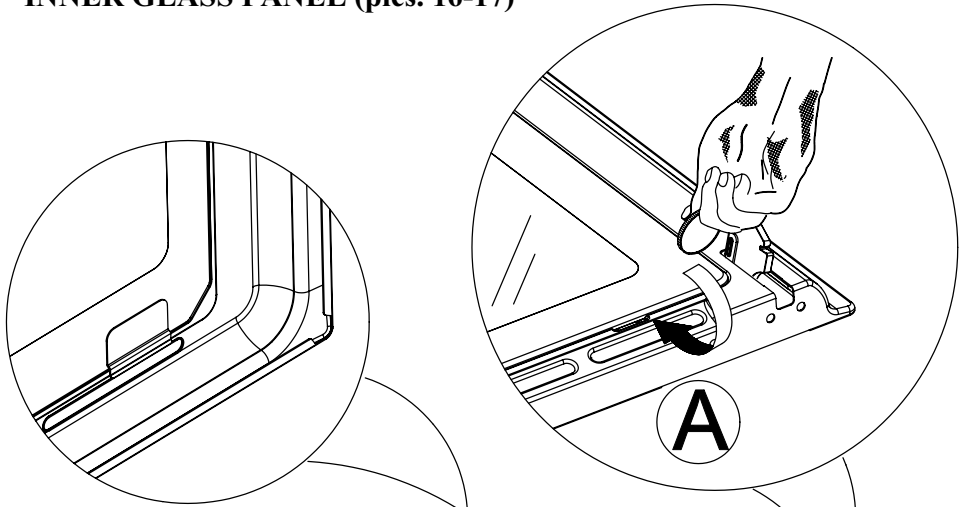

Pic. 16

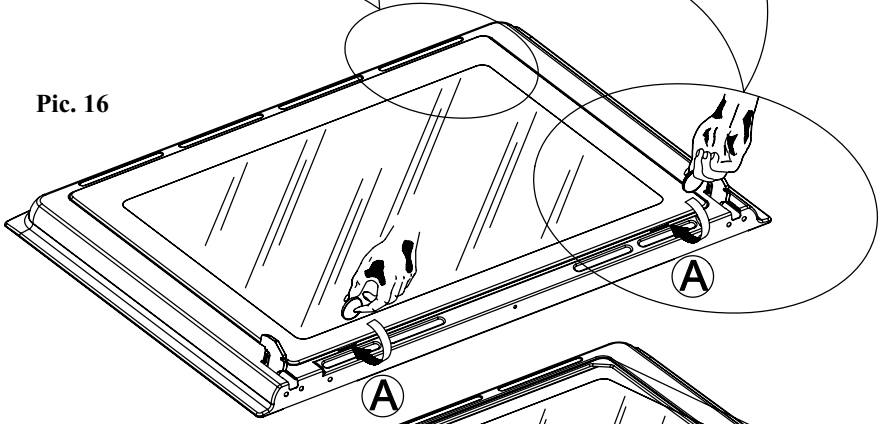

Pic. 17

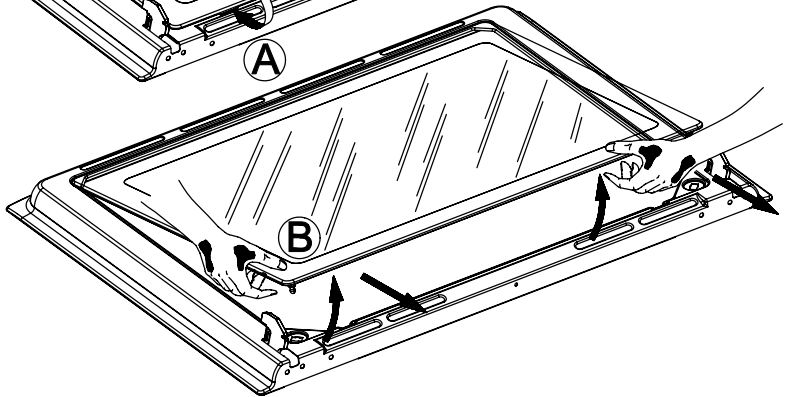

REMOVING AND REFITTING THE OVEN DOOR (pics. 18-23)

The door can be hooked on both sides

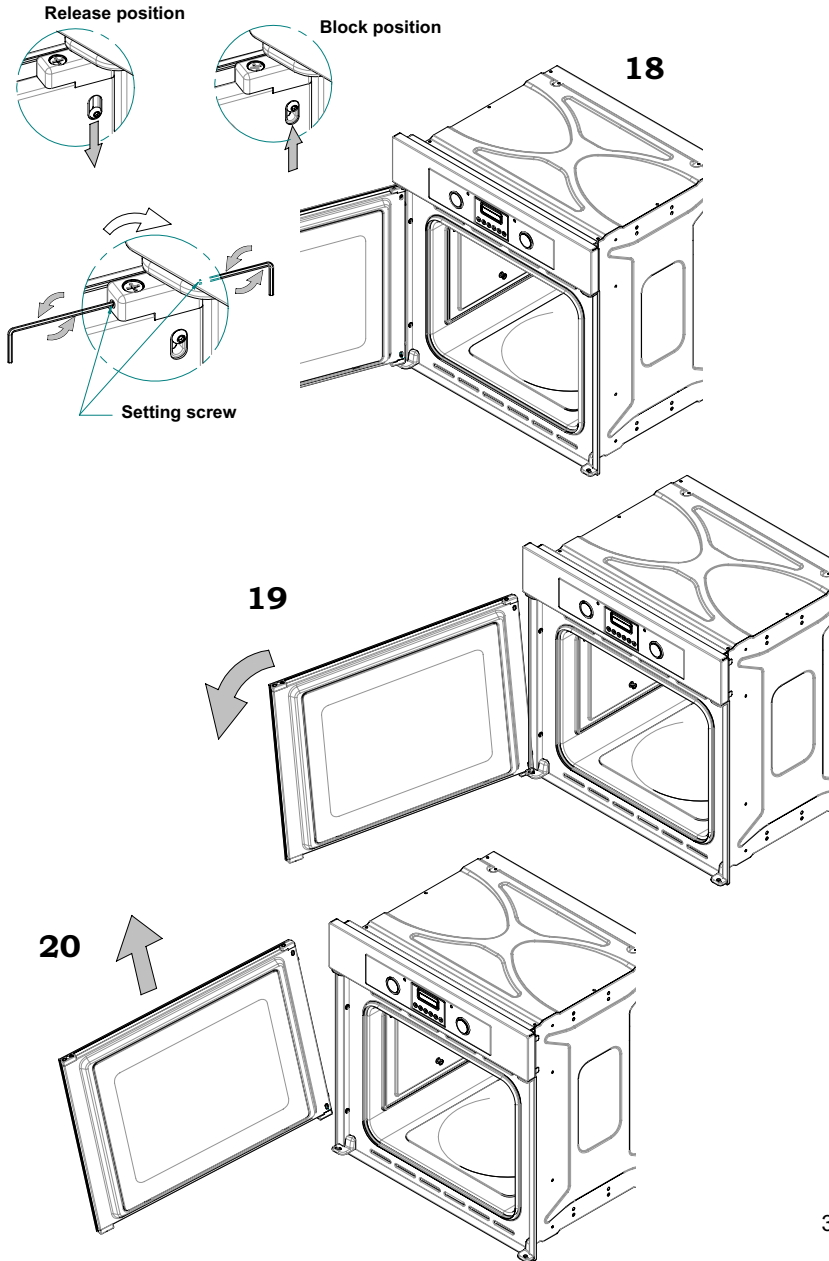

21

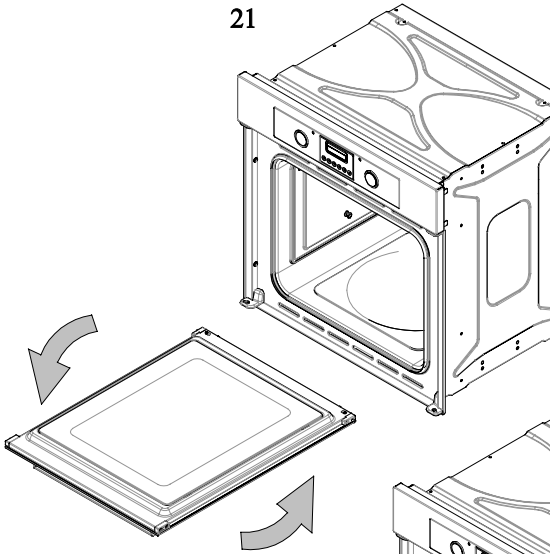

22

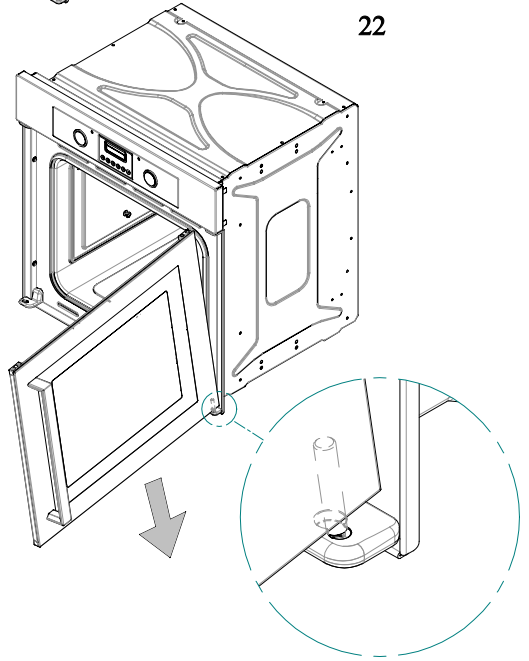

23

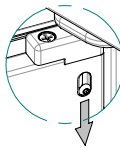
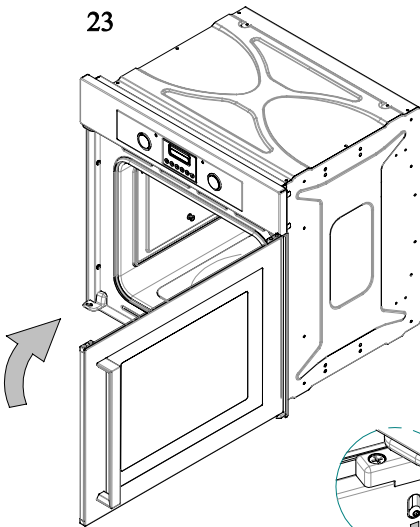

Release
position

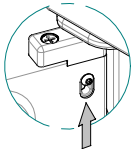

Block
position

Warning: once completed the operation, check the door is correctly hooked.

NOTE: Do not place heavy objects on (max 20 Kg) or lean on the oven door when open as this can cause damage to the hinges.

Installation of the self-cleaning liners (optional)
- Pic. 24

- 1) Fix the wall (A) with four auto-tapping screws.
- 2) Lean the walls (C) against the side of the oven and refasten the guides which were earlier taken away.
- 3) Replace the accessories into the oven.

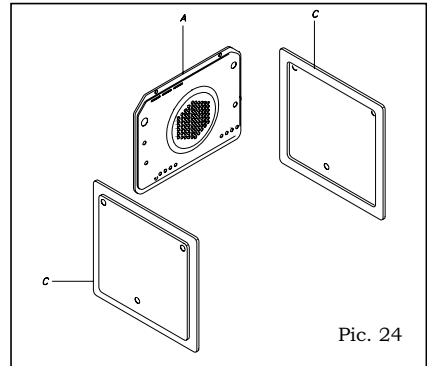

Oven accessories - Pic. 25

The appliance can be equipped with lateral guides which have to be fixed on the oven side. Slide oven shelves and trays on lateral guides. Lateral guides can be removed by a light downwards pressure on device A.

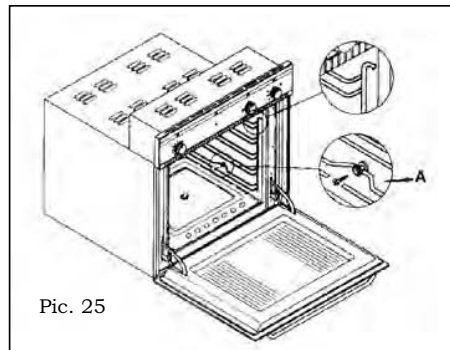

Cleaning and maintenance

Important: before carrying out maintenance on the oven, it must always be unplugged from the power supply or disconnected from the mains via the electrical system master switch.

Wait the appliance to cool down before proceeding with any cleaning operation.

Do not use abrasives, bleach or coarse cleaning material.

Do not use a steam cleaner with this appliance

Wipe the inside of the oven by using a damp cloth with a diluted ammonia product; rinse and dry the oven carefully.

When cleaning the lower part of the oven, you are advised to remove any stains while the oven is still warm, but not hot – the longer you wait, the more difficult it will be to remove them.

For external parts cleaning, use a soft cloth and soapy water, rinse and dry carefully.

If necessary, the inner door glass can be removed by unscrewing the 2 lateral fixing screws. Make sure that the glass is dried thoroughly before re-fitting. Take care not to over tighten the fixing screws when re-fitting.