

# BOSCH

Use and Care Manual  
For Household Use Only  
Notice d'utilisation et d'entretien  
Usage domestique uniquement  
Manual de instrucciones y cuidado  
Solo para uso domestico



Automatic Coffee Center  
TCA 6001 UC



---

**Use and Care Manual** ..... 3

**READ THIS MANUAL** thoroughly for important safety and operating instructions before using this appliance.

---

**Notice d'utilisation et d'entretien** ..... 29

Avant tout utilisation, **LISEZ ATTENTIVEMENT** ce manuel, vous y trouverez des consignes importantes portant sur la sécurité et le fonctionnement de votre appareil.

---

**Manual de instrucciones y cuidado** ..... 58

**LEA ESTAS INSTRUCCIONES** cuidadosamente por las instrucciones importantes de seguridad y funcionamiento antes de utilizar el electrodoméstico.

---

---

# Contents

<b>IMPORTANT SAFEGUARDS</b> .....	4
<b>Overview</b> .....	6
<b>Before using your appliance for the first time</b> ..	8
General .....	8
Switching on the appliance .....	8
Filling up the pipe system .....	8
<b>Controls</b> .....	9
<b>Preparation</b> .....	12
General .....	12
Using espresso/coffee beans .....	12
Adjusting the grinding unit .....	12
Using ground espresso/coffee powder .....	13
Steam for frothing milk .....	14
Steam for heating drinks .....	14
Preparing hot water .....	15
Selecting the water hardness and inserting the filter .....	15
<b>System messages</b> .....	19
<b>Cleaning the appliance</b> .....	20
Daily cleaning .....	20
Cleaning program .....	21
Cleaning the nozzle .....	22
<b>Descaling the appliance</b> .....	23
<b>Eliminating minor malfunctions yourself</b> .....	26
<b>BOSCH Small Appliance Warranty</b> .....	28

---

## **IMPORTANT SAFEGUARDS**

**WARNING:** A risk of fire and electric shock exists in all electrical appliances and may cause personal injury or death.

When using electrical appliances, basic safety precautions should always be followed, including the following:

1. Read all instructions.
2. Do not touch hot surfaces. Use handles or knobs.
3. To protect against fire, electric shock and personal injury, do not immerse cord, plug or appliance in water or other liquids.
4. Close supervision is necessary when any appliance is used by or near children.
5. Unplug from outlet when not in use and before cleaning. Allow the appliance to cool before putting on or taking off parts, and before cleaning the appliance.
6. Do not operate any appliance with a damaged cord or plug or after the appliance malfunctions, or has been damaged in any way. Return appliance to the nearest authorized service facility for examination, repair or adjustment.
7. The use of accessory attachments not recommended by the appliance manufacturer may result in fire, electric shock, or personal injury.
8. Do not use outdoors.
9. Do not let the cord hang over the edge of a table or counter, or touch hot surfaces.
10. Do not place on or near a hot gas or electric burner, or in a heated oven.
11. To disconnect, turn any control to "off" then remove plug from wall outlet.
12. Do not use appliance for other than intended use.
13. Use extreme caution when disposing hot steam.

**SAVE THESE INSTRUCTIONS**  
**HOUSEHOLD USE ONLY**

## CAUTION

This appliance is designed for domestic use and for processing normal quantities of food and not for industrial use. Any servicing other than cleaning and user maintenance should be performed by an authorized service representative.

- Do not immerse base in water or try to disassemble.
- To reduce the risk of fire or electric shock, do not open the enclosure. No user serviceable parts inside. Repair should be done by authorized service personnel only.
- Check voltage to be sure that the voltage indicated on the name plate agrees with your voltage.
- Never use warm or hot water to fill the water container! Use cold water only.
- Keep your hands and the cord away from hot parts of the appliance during operation.
- Never clean with scouring powders or hard implements.
- Never use a steam cleaner.
- Carefully read the operating instructions and keep in the document holder **10!**
- Do not touch the grinder!

A short power supply cord is provided to reduce the risk resulting from becoming entangled in or tripping over a longer cord.

Extension cords are available and may be used if care is exercised in their use.

If an extension cord is used,

1. the marked electrical rating of the extension cord should be at least as great as the electrical rating of the appliance, and
2. the longer cord should be arranged so that it will not drape over the counter of a table top where it could be pulled on by children or tripped over unintentionally.

This appliance has a polarized plug (one prong is wider than the other). As a safety feature, this plug will fit into a polarized outlet only one way. If the plug does not fill fully into the outlet, reverse the plug. If it still does not fit, contact a qualified electrician. Do not modify the plug in any way.

# Overview

## Controls

- 1 Power switch
- 2 Function selector  
coffee/steam/hot water
- 3 Display with symbols
- 4  $\text{⏻}$  button
- 5 **cafe** button
- 6 Rotary knob for adjusting  
the filling quantity  
 $\text{☐} - \text{☐} / \text{☐} - \text{☐}$
- 7 Rotary knob for adjusting  
the coffee strength  
 $\text{○} - \text{○}$
- 8 **clean** button
- 9 **calc** descaling button

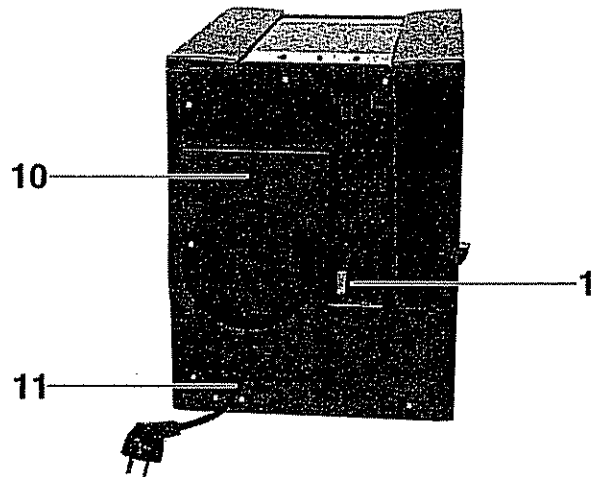
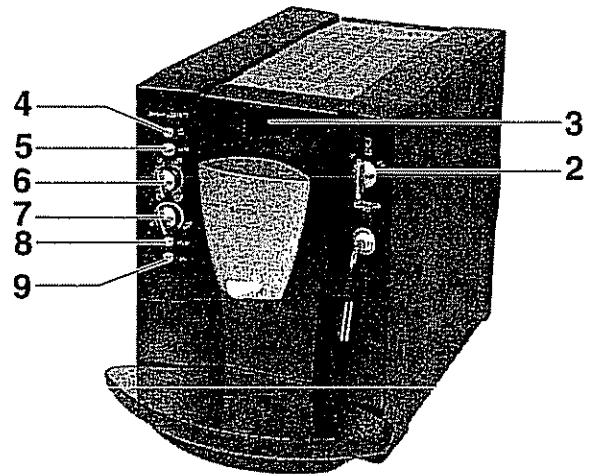

## Appliance components

- 10 Document holder
- 11 Cord storage
- 12 Height-adjustable  
coffee outlet
- 13 Hinged nozzle  
(frothing milk/steam/  
hot water)
  - a Sleeve
  - b Nozzle

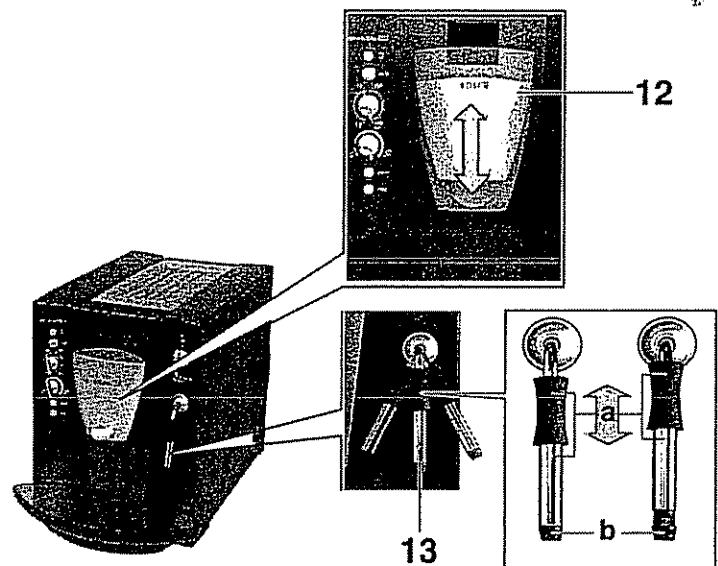

## Appliance components

- 14 Right cover of the appliance
- 15 Door for brewing unit
- 16 Ground coffee duct with cover = cleaning tablet duct
- 17 Rotary knob for degree of ground coffee
- 18 Bean container with aroma cover

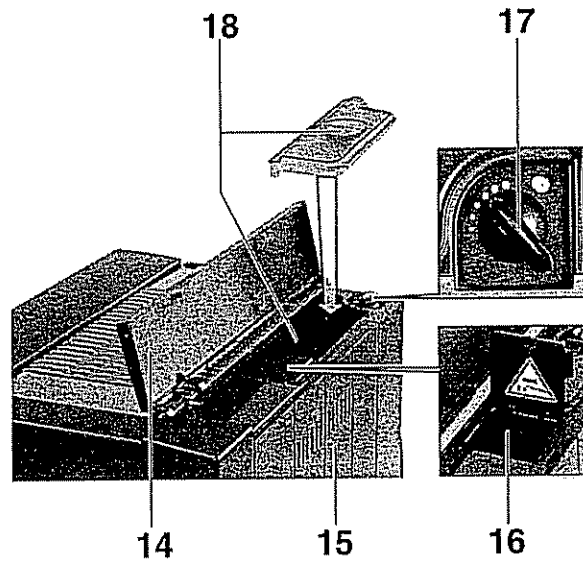

- 19 Cup shelf (pre-warming function)
- 20 Left cover of the appliance
- 21 Detachable water tank
- 22 Filter

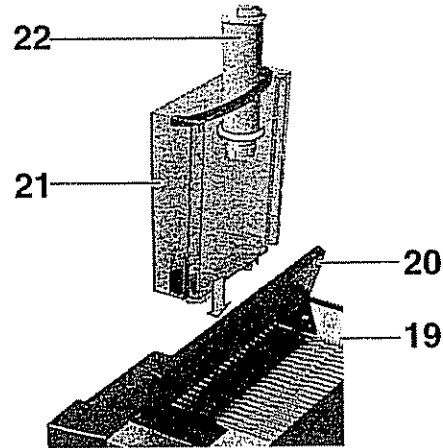

- 23 Coffee dregs tray (dishwasher-proof)
- 24 Tray (for residual water)
- 25 Grille
- 26 Contacts

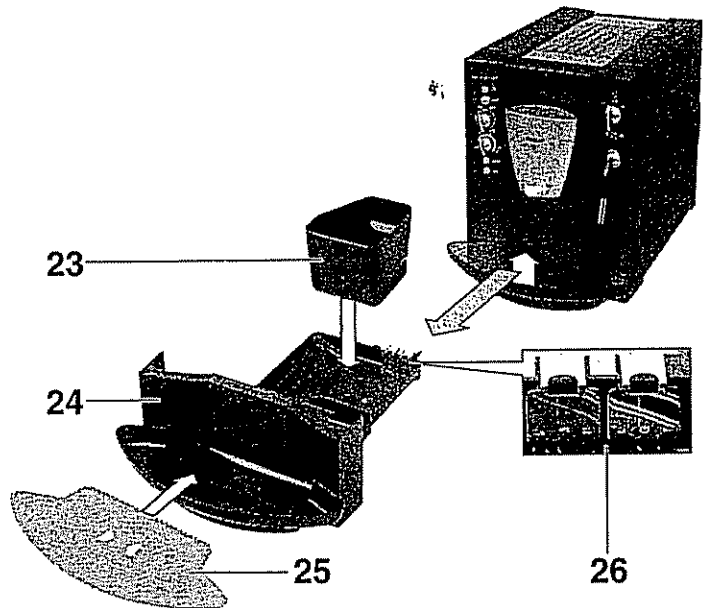

---

# Before using your appliance for the first time

---

## General

Fill the respective containers with pure water and preferably espresso or coffee beans for fully automatic machines only. Do not use coffee beans which have been glazed, caramelised or treated with other additives containing sugar. These will block the grinding unit.

Check the water hardness with the enclosed test strip. If a value other than 3 is displayed, program the appliance accordingly (see page 15).

---

## Switching on the appliance

- Pull the power cord out of the cord store and connect.
- Fill the water tank **21** with cold fresh water. Note the "max." mark.
- Fill the bean container **18** with coffee beans.
- Set power switch **1** to I.
- Set function selector **2** to ☉.
- Press button ☉ **4**.
- i** The appliance is **ready for use** when the illuminated rings on button ☉ **4** and on the **cafe** button **5** are lit green and ☉ lights up on display **3**.

**Note:** If the appliance is being used for the first time or has not been operated for a prolonged period, the first cup of coffee will not have the full aroma and should not be drunk.

---

## Filling up the pipe system

For production reasons when switched on for the first time, the water pipe system in the appliance may occasionally have to be refilled: ☉ is lit

- Press the **cafe** button **5**.



# Controls

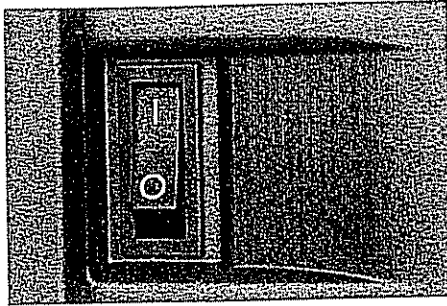

## Power switch 1

The power switch **1** on the rear of the appliance switches the power supply on or off.

When the power switch **1** has been switched on, the illuminated ring on button **4** is lit green. The appliance is in "stand by" mode.



## CAUTION



Do not press the power switch while the appliance is operating. Do not switch off the appliance until it is in stand by mode.

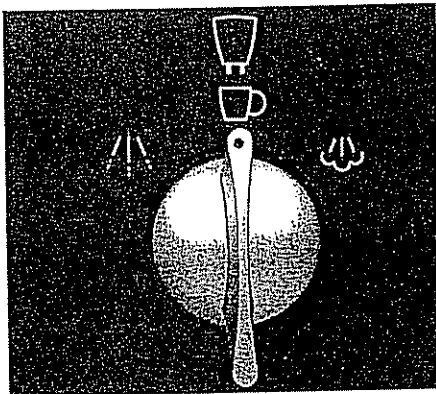

## Function selector 2

☕ coffee, 🌡️ hot water or ☁️ steam can be selected by rotating function selector **2**.



## WARNING



### Risk of scalding!

When the function selector is set to 🌡️ or ☁️, the nozzle may spurt slightly. Escaping water or steam is very hot. Do not touch nozzle **13** or direct at people!

## Display 3

Display **3** uses symbols to indicate the appliance settings and messages. See page 19.



Rinse



Ground coffee



Coffee ready



Steam



Fill water tank



Empty/no trays

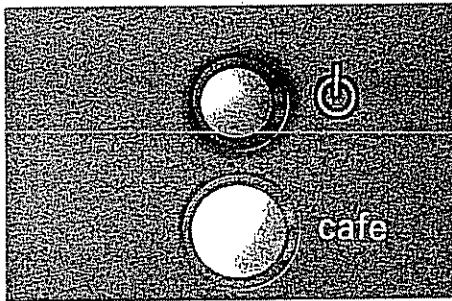

-  Turn to coffee
-  Turn to water
-  Brewing unit
-  Change filter
-  Descale appliance
-  Clean appliance

The appliance has been programmed ex works with standard settings for optimum operation.



#### Button 4



Button  4 switches on the appliance or switches it to "stand by" mode.

When button  4 is pressed, the appliance heats up, the illuminated ring on button  4 and the  symbol on display 3 flash.

Then the appliance is rinsed and the illuminated ring on button  4 flashes and  lights up on display 3.

The appliance is not rinsed if:

- the appliance was still warm when switched on or
- coffee was not discharged before the appliance was switched to "stand by" mode.

While coffee is being brewed, button  4 is assigned a **Stop** function. If button  4 is pressed, the process is terminated.

**i** 3 hours after the last coffee was brewed, a rinsing process is automatically actuated and the appliance switches to "stand by" mode.

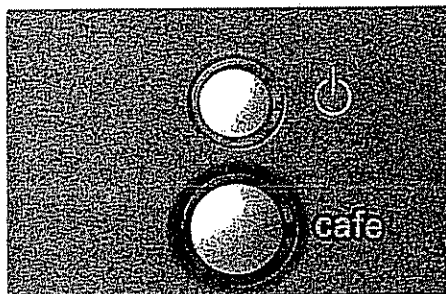

#### cafe button 5

Espresso or coffee can be brewed by pressing the **cafe** button 5. The green illuminated ring flashes while espresso or coffee is being brewed.

If the **cafe** button 5 is pressed again, the coffee brewing process is terminated.

**Rotary knob for adjusting the filling quantity**

☐ - ☐ / ☐ - ☐ 6

The amount of liquid is adjusted with rotary knob

☐ - ☐ / ☐ - ☐ 6

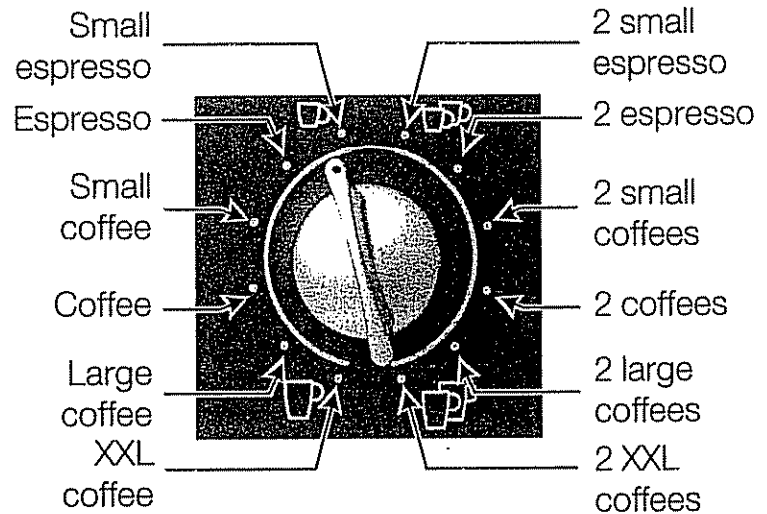

**i** Outlet 12 has two nozzles for filling 2 cups.

**Rotary knob for adjusting the coffee strength**

○ - ☉ 7

The amount of ground coffee is selected with rotary knob ○ - ☉ 7 from very mild (○) to extra strong (☉).

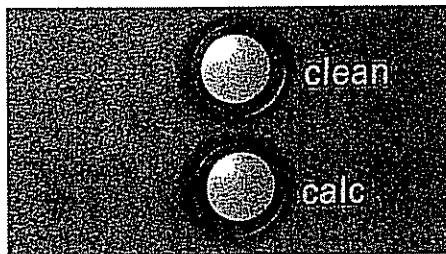
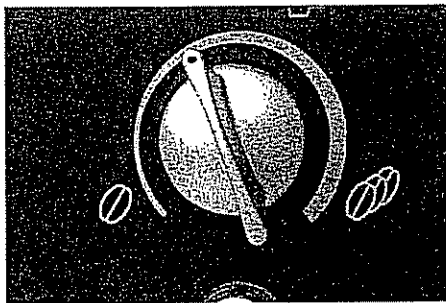

**clean button 8**

**calc descaling button 9**

When the appliance has to be cleaned or descaled, the illuminated ring on the **clean** button 8 or **calc** descaling button 9 is lit red. At the same time the cleaning symbol ☒ or the descaling symbol ☒ lights up on display 3.

See chapter "Cleaning the appliance" or "Descaling the appliance".

# Preparation

## General

This fully automatic espresso/coffee machine grinds fresh coffee for each brewing process.

Preferably use espresso or coffee beans for fully automatic machines. Store or deep-freeze in cool, air-tight and sealed containers. Deep-frozen coffee beans can also be ground.

Do **NOT** use very oily or very dark-roasted coffee beans – Risk of malfunction.

When using very oily beans, pour the beans onto a plate and let some of the sticky oils evaporate (this will not harm the aroma of the coffee).

**Tip:** Prewarm cup(s), especially thick-walled espresso cups, on the cup shelf **19** or rinse out with hot water.

## Using espresso/coffee beans

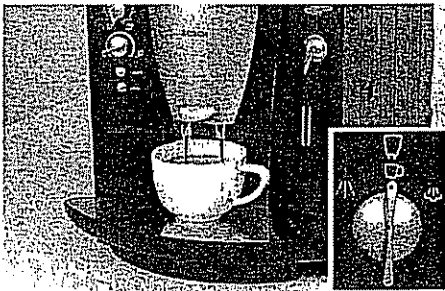

- Set function selector **2** to ☉.
- Select the desired amount of coffee and number of cups with rotary knob ☐ – ☐ / ☐☐ – ☐☐ **6**.
- Select the preferred coffee strength with rotary knob ☉ – ☉☉ **7**.
- Place cup(s) under the outlet **12**. If required, adjust the height of the outlet **12**.
- Press the **cafe** button **5**. The brewing process now runs automatically.

**Tip:** If brewing coffee simultaneously for 2 cups, simultaneously set the rotary knob ☉ – ☉☉ **7** to ☉☉.

- i** The brewing process can be terminated by pressing the **cafe** button **5** or button ☐ **4** again.
- The desired degree of ground coffee **17** can be selected with the rotary knob for degree of ground coffee.

## Adjusting the grinding unit



## CAUTION





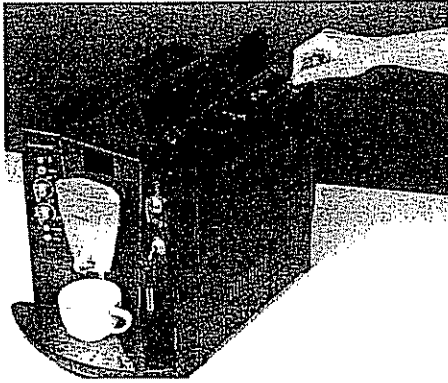

Adjust the degree of grinding only while the grinding unit is running! Otherwise the appliance may be damaged.



## Using ground espresso/coffee powder



- Open the right cover of the appliance **14**.
- Press the **cafe** button **5**.
- While the grinding unit is running, turn the knob to select the degree of grinding; the smaller the dots the finer the ground coffee.
- i** The new setting will not become apparent until the second or third cup is brewed.
  
- Select the desired filling quantity with rotary knob  -  /  -  **6**.
- Place cup(s) under the outlet **12**. If required, adjust the height of the outlet **12**.
- Open the right cover of the appliance **14** and the cover on the ground coffee duct **16**.  flashes on display **3**.
- Add **one to two** level scoops of medium-fine ground coffee to the ground coffee duct **16**.



## CAUTION



Do not add whole beans or instant coffee! Add a maximum two level scoops of coffee.

- Close the cover on the ground coffee duct **16** and the right cover of the appliance **14**.
- Press the **cafe** button **5**.
- i** Repeat the process for another cup of preground coffee.

**Note:** If coffee is not brewed within 90 seconds, the brewing chamber is emptied automatically in order to prevent overfilling. The appliance is rinsed.

## Steam for frothing milk

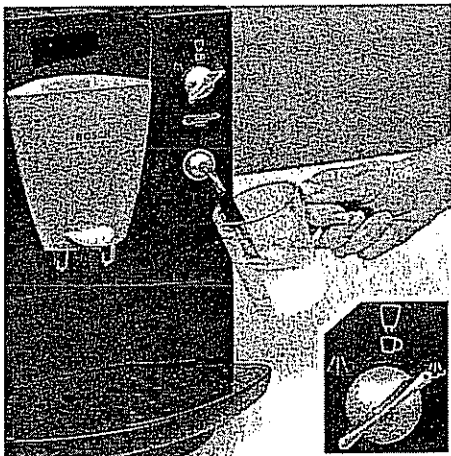

- Push **down** sleeve **a** on nozzle **13**.
- Fill the cup approx.  $\frac{1}{3}$  full of milk.
- Immerse nozzle **13** approx. 1 cm into the milk.
- Slowly** rotate function selector **2** to ☁.
- i** The appliance now heats up for approx. 20 seconds. ☁ flashes on display **3**. Then the milk is frothed. The ☁ symbol is lit on display **3**.



## WARNING



### Risk of scalding!

When the function selector is set to ☁, the nozzle may spurt slightly. Escaping steam is very hot. Do not touch nozzle or direct at people!

- Slowly rotate the cup.
- End the process by rotating the function selector **2** back to ☉.

**Note:** When nozzle **13** has cooled down, clean immediately. Dried residue is difficult to remove.

**Tip:** Preferably use semi-skimmed milk.

- Push **up** sleeve **a** on nozzle **13**.
- Immerse nozzle **13** deep into the liquid which is to be heated.
- Slowly rotate function selector **2** to ☁.
- i** The appliance now heats up for approx. 20 seconds. ☁ flashes on display **3**. Then the liquid is heated. The ☁ symbol is lit on display **3**.

## Steam for heating drinks

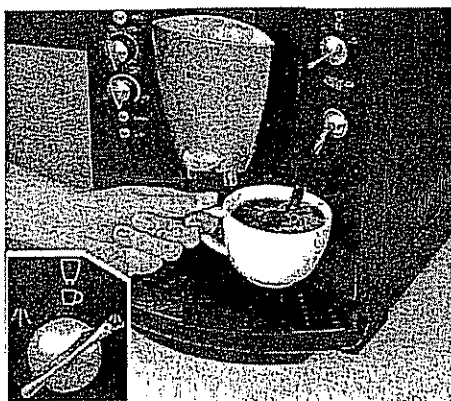

## WARNING



### Risk of scalding!

When the function selector is set to ☁, the nozzle may spurt slightly. Escaping steam is very hot. Do not touch nozzle or direct at people!

- End the process by rotating the function selector **2** back to ☉.

**Note:** When nozzle **13** has cooled down, clean immediately. Dried residue is difficult to remove.

## Preparing hot water

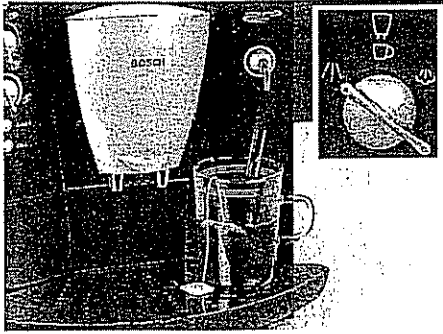

- Place an appropriate cup under the nozzle **13**.
- Push **down** sleeve **a** on nozzle **13**.
- Rotate function selector **2** to  and fill the cup.



## WARNING



### Risk of scalding!

When the function selector is set to , the nozzle may spurt slightly. Escaping water is very hot. Do not touch nozzle or direct at people!

- End the process by rotating the function selector **2** back to .

## Selecting the water hardness and inserting the filter

It is important for the descaling program that the water hardness is set correctly.

If external water softeners are used in the domestic water system or if filtered water is used, select water hardness 1.

- Ascertain the water hardness with the enclosed test strip.
- The appliance must be in standby mode, only the illuminated ring on the button  **4** is lit.

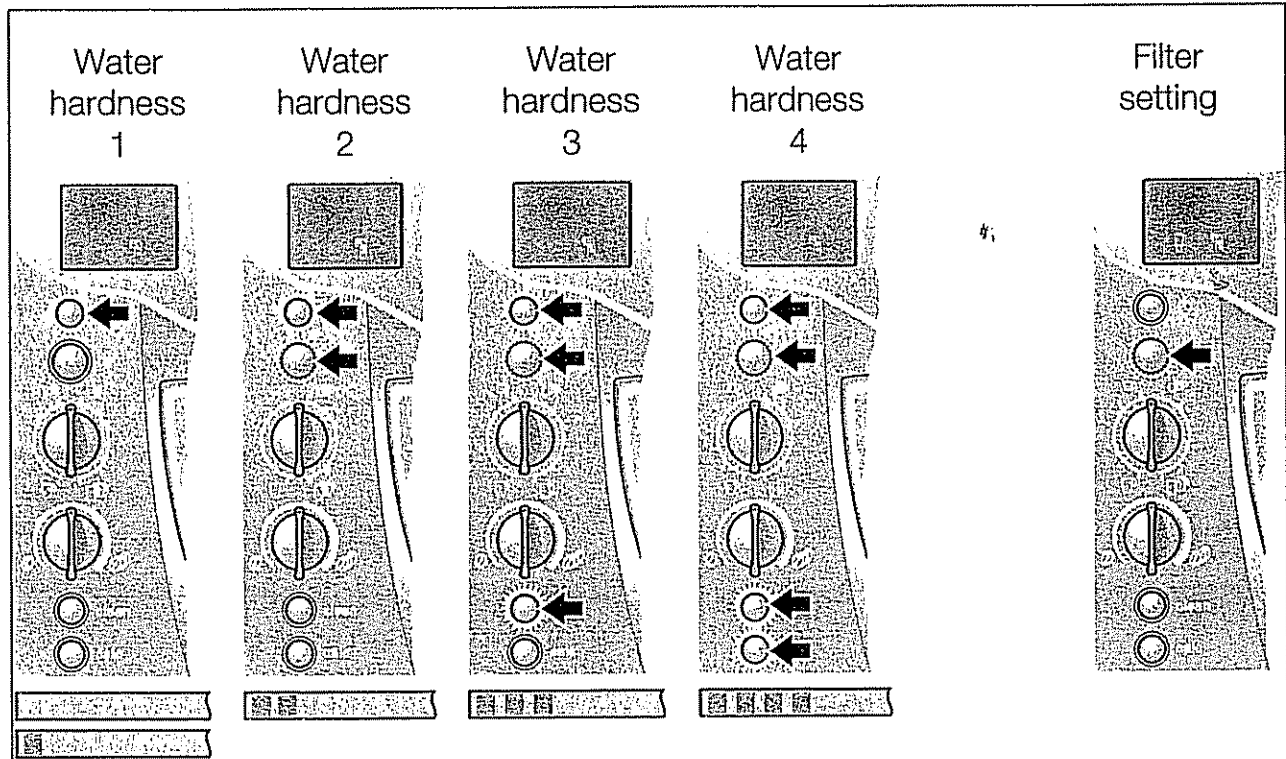



- Simultaneously hold down **clean 8** button and **calc 9** descaling button for at least 3 seconds until  is indicated on the display. The number of illuminated rings around control buttons **4**, **5**, **8** and **9** symbolise the selected water hardness (see diagram).
- Press **calc 9** descaling button until the illuminated rings for the desired water hardness light up. If the illuminated ring for the **cafe** button **5** flashes, the filter can be set.
- Press **cafe** button **5** once. The selected water hardness is saved.

	<b>CAUTION</b>	
<p>The appliance now switches on automatically. As soon as the illuminated rings on buttons  <b>4</b> and <b>cafe 5</b> as well as the  symbol on display <b>3</b> are lit, the appliance is ready to brew coffee again.</p>		

- i** If the **calc 9** descaling button is not pressed for longer than 90 seconds, the appliance switches to standby mode without saving the settings. The previously saved water hardness is retained.



The filter **22** reduces calcification, protects the appliance and extends the service life of the appliance.

#### Inserting the filter

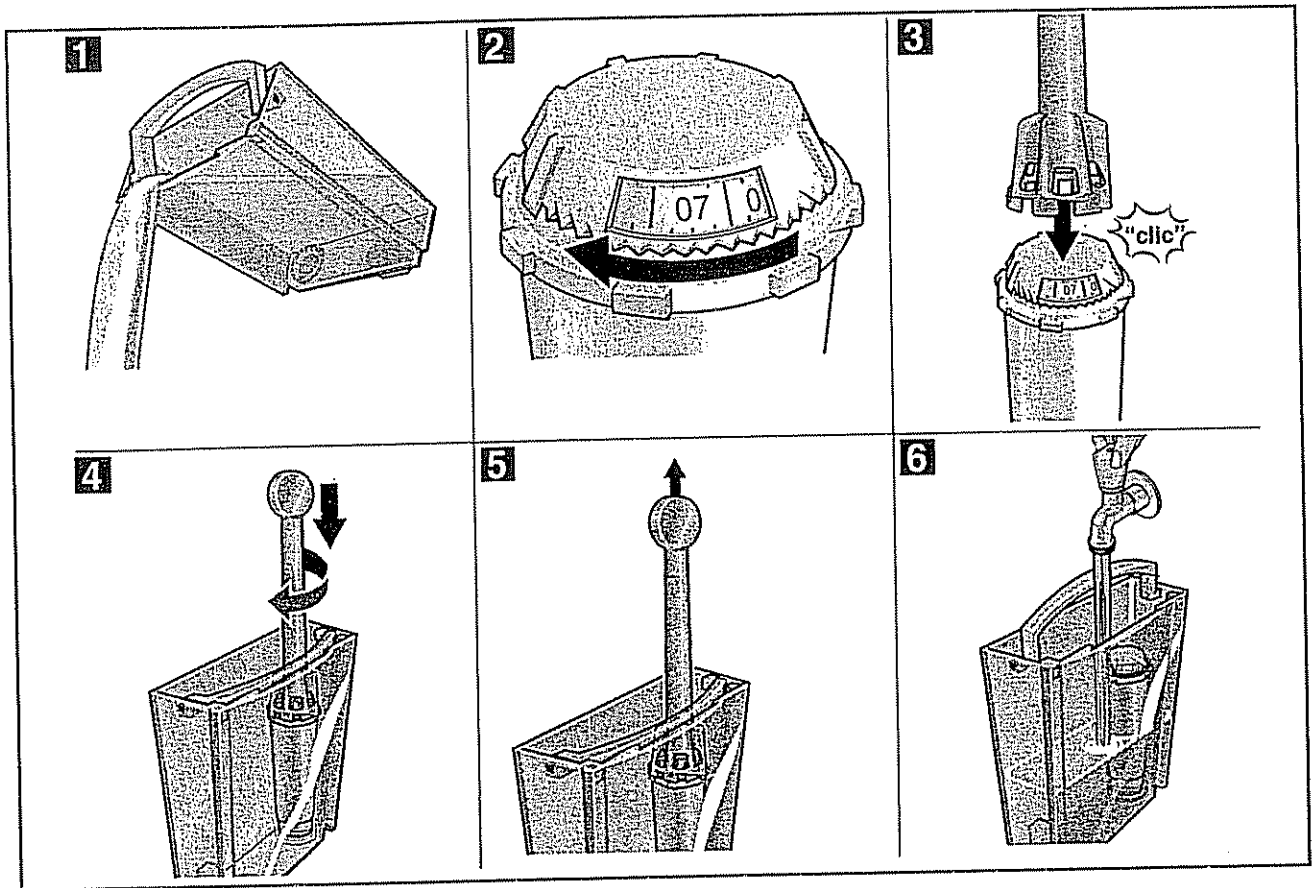

- Appliance must be in "Standby".
- Place a receptacle with at least 17 oz. capacity under the nozzle **13**.
- Insert the filter according to the diagram.
- Simultaneously hold down the **clean** button **8** and **calc** button **9** for at least 3 sec. until  lights up.
- Keep pressing the **calc** button **9** until  lights up.
- Acknowledge by pressing the **cafe** button **5**.
- Rotate function selector **2** to .





- i** Appliance rinses automatically (approx. 2 min.), water runs into the receptacle and may be slightly discolored, do not drink.
- As soon as  lights up, rotate function selector 2 back to .

#### Changing the filter



-  and  illuminate – switch appliance to "Standby".
- Place a receptacle with at least 17 oz. capacity under the nozzle **13**.
- Unscrew the filter with the screw-in aid in a counter-clockwise direction.
- Insert new filter.
- Simultaneously hold down the **clean** button **8** and **calc** button **9** for at least 3 sec.
- Continue with points 6 to 9 under "Inserting the filter".

### Removing the filter

- Switch appliance to "Standby".
- Unscrew the filter with the screw-in aid in an anti-clockwise direction.
- Simultaneously hold down the **clean** button **8** and **calc** button **9** for at least 3 sec.
- Select the desired water hardness by pressing the **calc** button **9** (e.g.  button illuminates, denotes water hardness 1).
- Acknowledge by pressing the **cafe** button **5**.













Re-order the filter under mat. no.: 461732.











### Important

- After approx. 13.2 gallons (  is displayed) or after 2 months at the latest the filter is exhausted and must be replaced.
- Do not insert the filter if the  message lights up. First descale the appliance.
- Before descaling the appliance, take the filter out of the water tank.
- When the filter has been inserted, it must be rinsed. To do this, comply with the following points.
- If the appliance is always operated with an inserted filter, it should be descaled once or twice a year, even if the descale message is not displayed.
- If softened water from a domestic descaling unit is used, a filter should not be inserted.

# System messages

The appliance indicates messages on display 3.

	Meaning	Remedial action
 is lit	No water.	Pour fresh, cold water into the water tank <b>21</b> .
	<b>Note:</b> There is always a small amount of water left in the water tank <b>21</b> .	
	Water tank <b>21</b> is missing or not inserted correctly.	Insert water tank <b>21</b> .
  flash	Bean container <b>18</b> is empty.	Fill bean container <b>18</b> .
	<b>Note:</b> Both symbols flash until coffee is brewed again.	
 is lit	Illuminated ring of the <b>cafe</b> button <b>5</b> flashes. Water pipe system in the appliance is empty.	Press <b>cafe</b> button <b>5</b> .
 flashes 5x	System heated up by Steam on.	Allow system to cool down by letting out some hot water  .
 is lit	Tray <b>24</b> and coffee dregs tray <b>23</b> are full, or contacts <b>26</b> soiled.	Remove, empty, and re-insert tray <b>24</b> and coffee dregs tray <b>23</b> . Clean and dry contacts <b>26</b> .
 flashes	Tray <b>24</b> and coffee dregs tray <b>23</b> are missing.	Insert tray <b>24</b> and coffee dregs tray <b>23</b> .
 is lit	The illuminated ring on the <b>clean</b> button <b>8</b> is lit red.	Run cleaning program – see page 20.
 is lit	The illuminated ring on the <b>calc</b> descaling button <b>9</b> is lit red.	Run descaling program – see page 23.
 flashes	Cover on the duct for ground coffee <b>16</b> is open.	Close the cover on the duct for ground coffee <b>16</b> .
 is lit	The filter <b>22</b> is no longer effective after 13.2 gallons or approx. 2 months.	Change filter <b>22</b> (order no. 46 1732) or continue operating the appliance without filter <b>22</b> . If a new filter is not inserted, select water hardness – see page 15.

	Meaning	Remedial action
 is lit	Door for brewing unit <b>15</b> is not closed.	Close door for brewing unit <b>15</b> .
 is lit	Coffee cannot be brewed.	Set function selector <b>2</b> to ☉.
    flash	Fault.	See chapter "Eliminating minor faults yourself".
<b>Note:</b> Coffee cannot be brewed while the  ,  symbols are lit on display <b>3</b> or  ,  flash on display <b>3</b> .		

## Cleaning the appliance

### Daily cleaning



### WARNING



#### Risk of electric shock!

Pull out the mains plug before cleaning the appliance.



### CAUTION



Do not use scouring agents!

Never immerse the appliance in water!

Do not use a steam cleaner!

- Wipe the outside of the appliance with a damp cloth.
- Rinse out the water tank **21** and fill with fresh water.
- Remove and empty tray **24** and coffee dregs tray **23**.  
Only the coffee dregs tray **23** may be cleaned in the dishwasher!  
Clean and dry contacts **26**.
- Wipe out or vacuum the inside of the appliance (trays).

---



## Cleaning program

**Note:** If the appliance is switched on in a cold state with button  4 or is set to "stand by" after brewing coffee, the appliance is automatically rinsed. The system therefore cleans itself.



If the illuminated ring on the **clean 8** button is lit red and the  is indicated on display 3 when the appliance is switched on, the appliance must be cleaned as quickly as possible.



Clean the appliance with the enclosed cleaning tablet.

**Do not drop in the cleaning tablet until you are prompted to do so.**

	<b>WARNING</b>	
<p><b>Risk of injury!</b> Do not place the tablet in mouth. Keep under lock and key and out of the reach of children. Avoid contact with skin and eyes. Do not drink liquid.</p> <p>If tablet comes into contact with eyes, immediately wash eyes with plenty of water and consult a doctor. If a tablet is swallowed, seek medical advice immediately and produce packaging or label.</p>		



These tablets have been specially developed for this appliance and are available from customer service (order no. 31 0655).

	<b>CAUTION</b>	
<p>Never interrupt the cleaning program! Never use descaling tablets or other descaling agents.</p>		



-  While the cleaning program is running – approx. 15 minutes – processes and instructions are indicated on display 3.
-  The illuminated ring on the button **clean 8** flashes while the cleaning program **is running**.

### Start cleaning program

- Completely fill water tank 21.
- Hold down button **clean 8** for at least 3 seconds. If  flashes occasionally on display 3, see "Eliminating minor faults yourself".
- Empty and re-insert tray 24 and coffee dregs tray 23.

**Note:** The appliance is automatically cleaned,  lights up on display 3. Wait for the next symbols  and  on display 3 (approx. 1 minute).

- Open the right cover of the appliance 14 and duct cover for ground coffee 16.
- Insert a cleaning tablet into duct 16.
- Close the cover on the ground coffee duct 16 and the right cover of the appliance 14.
- Press the **cafe** button 5.



**Note:** The appliance is automatically cleaned,  lights up on display 3. Wait for the next symbol  on display 3 (approx. 10 minutes).

- Empty and re-insert tray 24 and coffee dregs tray 23.
- i** The cleaning process is complete. The illuminated ring on button **clean 8** goes out. The appliance is ready for use again.

### Cleaning the nozzle

	<b>CAUTION</b>	
Clean the nozzle after each use.		

- Place a suitable receptacle under the nozzle.
- Briefly set function selector to .

	<b>WARNING</b>	
<b>Risk of scalding!</b> When the function selector is set to  , the nozzle may spurt slightly. Escaping water is very hot. Do not touch nozzle or direct at people!		

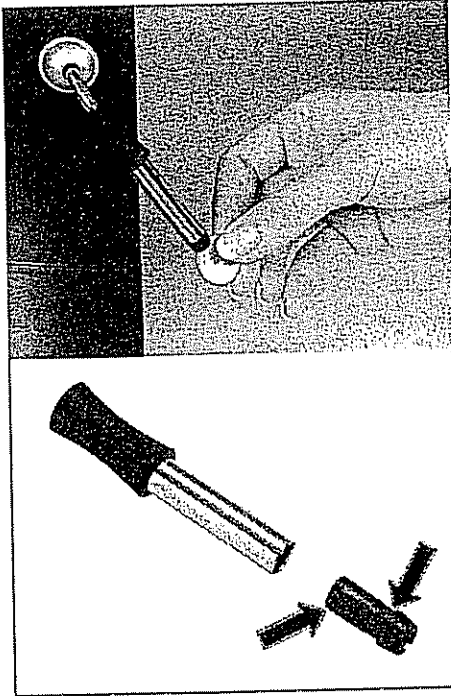

- ❑ Set function selector to .
  - ❑ Wipe the outside of the nozzle after it has cooled down.
  - ❑ Dismantle the nozzle to clean thoroughly.
- Proceed as follows:
- ❑ Unscrew the nozzle with a coin.
  - ❑ In particular, clean the tip of the nozzle with a brush and pointed implement.
  - ❑ Clean all parts with hot water and detergent, rinse and dry (dishwasher-proof).

---

## Descaling the appliance

If the illuminated ring on the descaling button **calc 9** is lit red and  is indicated on display **3** when the appliance is switched on, the appliance must be descaled immediately. If the appliance is not descaled as instructed, it may be damaged.

### Note:

If you use a filter **22** and the message  is displayed, the filter is **NOT** activated in the settings. Follow the instructions "Change settings/programming – Filter".

If the appliance is always operated with an inserted filter, it should be descaled once or twice a year, even if the descale message is not displayed.



## WARNING



### Risk of injury!

Do not place the descaling agent in mouth. Keep under lock and key and out of the reach of children. Avoid contact with skin and eyes. Do not drink liquid.

If a descaling agent comes into contact with eyes, immediately wash eyes with plenty of water and consult a doctor. If a descaling agent is swallowed, seek medical advice immediately and produce packaging or label.



## CAUTION



Never descale the appliance with vinegar or vinegar-based agents! Do not use cleaning tablets.  
Never interrupt the descaling program!  
Do not drink liquid!

- i** A descaling agent is enclosed with the appliance. Specially developed and suitable agents are available from customer service (order no.: 31 0451).
- i** While the descaling program is running – approx. 35 minutes – processes and instructions are indicated on display **3**. The specified times may differ.
- i** The illuminated ring on the descaling button **calc 9** flashes during the descaling program.



### Start descaling program

- Hold down the descaling button **calc 9** for at least 3 seconds. If  flashes occasionally on display **3**, see “Eliminating minor faults yourself”.
  - Empty and re-insert tray **24** and coffee dregs tray **23**.
  - Fill water tank **21** with water and add descaling agent – total volume of liquid 17 oz..
- or
- Pour ready-prepared descaling mixture into the water tank **21** – total volume of liquid 17 oz..





Place an appropriately large receptacle under nozzle **13**.

Set function selector **2** to .

**Note:** The appliance is automatically descaled,  lights up on display **3**. Descaling solution flows at intervals into the receptacle. Wait for the next symbol  on display **3** (approx. 10 minutes).

Set function selector **2** to .

**Note:** The appliance is automatically descaled,  lights up on display **3**. Descaling solution flows at intervals into the tray **24**. Wait for the next symbol  on display **3** (approx. 10 minutes).

Empty and re-insert tray **24** and coffee dregs tray **23**.

Rinse out the water tank **21**, fill with fresh water up to **max** and re-insert.

Empty the receptacle and place back under the nozzle **13**.

Set function selector **2** to .

**Note:** The appliance is automatically descaled,  lights up on display **3**. Water flows at intervals into the receptacle.

Wait for the next symbol  on display **3** (approx. 4 minutes).

Set function selector **2** to .

**Note:** The appliance is automatically descaled,  lights up on display **3**. Water flows at intervals into the tray **24**.

Wait for the next symbol  on display **3** (approx. 4 minutes).

Empty tray **24** and coffee dregs tray **23**.

Clean and dry contacts **26**.

Re-insert tray **24** and coffee dregs tray **23**.

**Note:** The appliance is automatically rinsed.





Wipe splashes off the nozzle **13** and appliance.













**i** The descaling process is complete.

The illuminated ring on descaling button **calc 9** goes out.

The appliance is ready for use again.

# Eliminating minor malfunctions yourself

Fault	Cause	Remedial action
Grind unit is not grinding coffee beans.  and  light up.	Grinder has still not been filled automatically.	Press the <b>cafe 5</b> button.
	The beans are too big or too oily – they do not slide into the grinding unit.	Use less oily or smaller beans. To remove big beans use a vacuum cleaner.
No hot water or steam discharge.	Nozzle <b>13</b> is blocked.	Thoroughly clean nozzle <b>13</b> .
Froth insufficient or too runny.	Sleeve <b>a</b> on nozzle <b>13</b> not in correct position.	Push <b>down</b> sleeve <b>a</b> on nozzle <b>13</b> .
	Unsuitable milk.	Use cold semi-skimmed milk.
Coffee is running a drop at a time.	Degree of grinding too fine.	Select a coarser degree of grinding.
	The beans are too oily.	Use less oily beans.
	Preground coffee too fine.	Use a coarser ground coffee. To rinse the appliance, follow the instructions "Using ground espresso/coffee powder" on page 14, but do <b>not</b> add coffee powder in the duct.
Coffee has no "crema" (layer of froth).	Unsuitable type of coffee.	Change the type of coffee.
	Beans no longer fresh.	Use fresh beans.
	Degree of grinding not appropriate for coffee beans.	Optimise degree of grinding.
Grind unit is not grinding coffee beans.	Beans are not falling into the grinding unit (too oily).	Gently tap the bean container.
Descaling programme or cleaning program is not starting.  flashes 5x on display <b>3</b> .	System too hot.	Set function selector <b>2</b> to  and drain approx. one cup of hot water.
Descaling program does not start	Filter active	Remove filter and set water hardness. Never descale the appliance with the filter inserted.

Fault	Cause	Remedial action
Grinding unit is making loud noise.	Foreign objects in the grinding unit (e.g. grit which also occurs in superior types of coffee).	Contact Hotline. <b>Note:</b> Preground coffee can still be prepared.
 lits     flashing	Illuminated ring on the  button 4 flashes. Appliance too cold.	Wait until the appliance has warmed up to room temperature.
 or  light up     flash	Illuminated ring on the  button 4 flashes. Technical fault.	Switch OFF the device at the power switch <b>1</b> for at least ten seconds.
<b>If faults cannot be eliminated, always call the Hotline!</b>		

---

## BOSCH Small Appliance Warranty

BSH Home Appliances ("BOSCH") warrants all new small appliances to be free from original defects in design, materials and workmanship for one (1) year after the sale to the original owner.

Within the stated warranty period, BOSCH will repair or replace, at its sole option, any small appliance or parts thereof which prove defective under the conditions of normal use and service at no charge to you. It is the owner's responsibility to return the appliance for repair. Repaired and replacement small appliances and parts shall be the same or as close in appearance as possible to the original for the purposes of this warranty.

Should you require service of your BOSCH small appliance, please contact customer service at 1-866-44-BOSCH. Repair of BOSCH appliances should only be performed by qualified technicians. This warranty is limited to the original consumer purchase and is not transferable. Specifically excluded from this warranty are failures caused by accident, misuse, neglect, abuse, including tampering, use of frequency or voltage other than marked on the product, and use for commercial purposes.

To the extent allowed by law, this warranty sets out your exclusive remedies, whether for negligence or otherwise. BOSCH will not be liable for any consequential or incidental damages, losses or expenses. THIS WARRANTY IS IN LIEU OF ALL OTHER EXPRESSED WARRANTIES. ANY WARRANTY IMPLIED BY LAW, WHETHER FOR MERCHANTABILITY OR FITNESS FOR A PARTICULAR PURPOSE OR OTHERWISE, SHALL BE EFFECTIVE ONLY FOR THE PERIOD THAT THIS EXPRESSED WARRANTY IS EFFECTIVE. BOSCH DOES NOT ASSUME ANY RESPONSIBILITY FOR INCIDENTAL OR CONSEQUENTIAL DAMAGES.

No attempt to alter, modify or amend this warranty shall be effective unless authorized in writing by an officer of BOSCH. Some states do not allow limitations on how long implied warranties last or the exclusion or limitation of incidental or consequential damages, so the foregoing limitations and exclusions may not apply to you. This warranty gives you specific legal rights and you may also have other rights which vary from state to state.

Looking for more information about BOSCH products?

Visit our Web site: [www.boschsmallappliances.com](http://www.boschsmallappliances.com)

Subject to alterations

BSH Home Appliances Corporation  
5551 McFadden Avenue  
Huntington Beach, CA 92649  
USA

Web site: [www.boschsmallappliances.com](http://www.boschsmallappliances.com)

Customer Service (toll free): 1-866-44BOSCH (1-866-442-6724)

Appelez le service-client (gratuit) : 1-866-44BOSCH (1-866-442-6724)

Servicio al cliente (libre de cargo): 1-866-44BOSCH (1-866-442-6724)

0041682/9/12.04/1000

0411  
TCA6001UC

