

COMPETENCE B1180-4

Built-In Electric Oven

User information

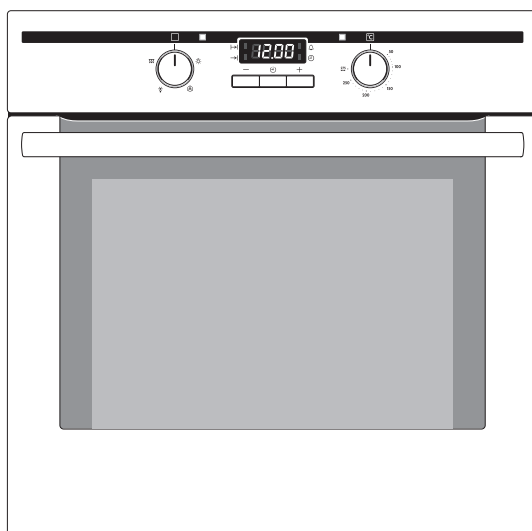

Dear Customer,

Please read this user information carefully and keep it to refer to later. Please pass the user information on to any future owner of the appliance.

The following symbols are used in the text:



Safety instructions

Warning! Information that affects your personal safety.

Important! Information that prevents damage to the appliance.



Useful tips and hints



Environmental information

Contents

Operating Instructions	5
Safety instructions	5
Disposal	6
Description of the Appliance	7
General Overview.....	7
Control Panel	7
Oven Features.....	8
Oven Accessories	8
Before using for the first time	9
Setting and changing the current time.....	9
Initial Cleaning.....	10
Operating the Oven	11
Switching the Oven On and Off.....	11
Oven Functions.....	12
Attaching/Removing the Grill Pan Handle	12
Clock Functions	13
Switching Off the Time Display	14
Usage, Tables and Tips	19
Baking.....	19
Baking Tables	21
Table: Desserts	24
Roasting	25
Table: Meat, roasting, casseroles.....	26
Table: Roasting, casseroles, au gratin.....	27
Defrosting.....	28
Defrosting table	28
Grill sizes.....	29
Grilling table.....	29
Cleaning and care	30
Outside of the appliance.....	30
Oven interior	30
Accessories	30
Shelf Support Rails	31
Oven Lighting.....	32
Oven Roof.....	33
Oven Door.....	34
Oven Door Glass.....	35

What to do if	36
Electrical Connection	37
Installation Instructions	38
Safety information for the installer.....	38
Warranty conditions	42
Service and Spare Parts	43

Operating Instructions



Safety instructions



- This appliance conforms with the following EU Directives:
- 73/23/EEC dated 19.02.1973 Low Voltage Directive
 - 89/336/EEC dated 03.05.1989 EMC Directive inclusive of Amending Directive 92/31/EEC
 - 93/68/EEC dated 22.07.1993 CE Marking Directive

Electrical safety

- This appliance must be connected by a **qualified electrician** only.
- In the event of a fault or damage to the appliance: take the fuses out or switch off.
- **Repairs** to the appliance must **only be carried out by qualified service engineers**. Considerable danger may result from improper repairs. If repairs become necessary, please contact your local Service Force Centre.

Child Safety

- Never leave children unsupervised when the appliance is in use.

Safety whilst Using

- This appliance is intended to be used for cooking, roasting and baking food in the home.
- Take care when connecting electric appliances to sockets nearby. Do **not** allow connecting leads to come into contact with or to catch beneath the hot oven door.
- **Warning: Risk of burns!** The interior of the oven becomes hot during use.
- Using ingredients containing alcohol in the oven may create an alcohol-air mixture that is easily ignited. In this case, open the door carefully. Do not have embers, sparks or naked flames in the vicinity when opening the door.

How to avoid damage to the appliance

- Do not line the oven with aluminium foil and do not place baking trays, pots, etc. on the oven floor, as the heat that builds up will damage the oven enamel.
- Fruit juices dripping from the baking tray will leave stains, which you will not be able to remove. For very moist cakes, use a deep tray.
- Do not put any strain on the oven door when open.
- Never pour water directly into the oven when it is hot. This could cause damage to the enamel and discoloration.
- Rough handling, especially around the edges of the front panel, can cause the glass to break.
- Do not store any flammable materials inside the oven. These could ignite when the oven is switched on.
- Do not store any moist foods inside the oven. This could damage the oven enamel.

Disposal



Packaging material

The packaging materials are environmentally friendly and can be recycled. The plastic components are identified by markings, e.g. >PE<, >PS<, etc. Please dispose of the packaging materials in the appropriate container at your local waste disposal facilities.



Old appliance

The symbol  on the product or on its packaging indicates that this product may not be treated as household waste. Instead it shall be handed over to the applicable collection point for the recycling of electrical and electronic equipment. By ensuring this product is disposed of correctly, you will help prevent potential negative consequences for the environment and human health, which could otherwise be caused by inappropriate waste handling of this product. For more detailed information about recycling of this product, please contact your local city office, your household waste disposal service or the shop where you purchased the product.



Warning: Before disposing of old appliances please make them inoperable so that they cannot be a source of danger.

To do this, disconnect the appliance from the mains supply and remove the mains cable from the appliance.

Description of the Appliance

General Overview

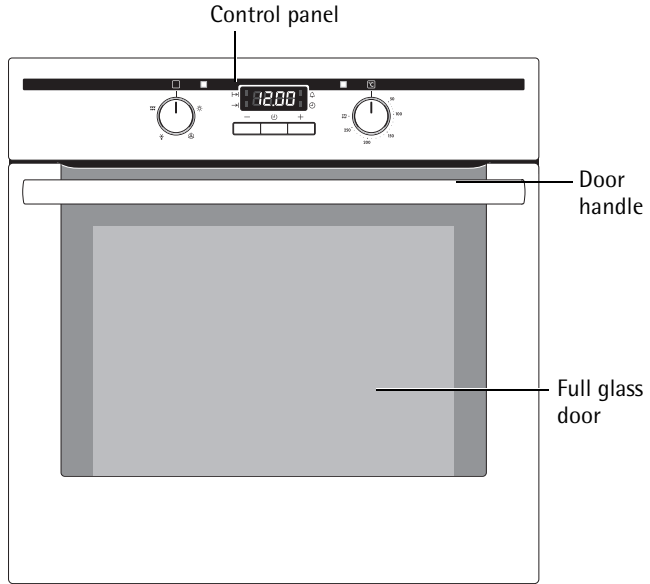

Control Panel

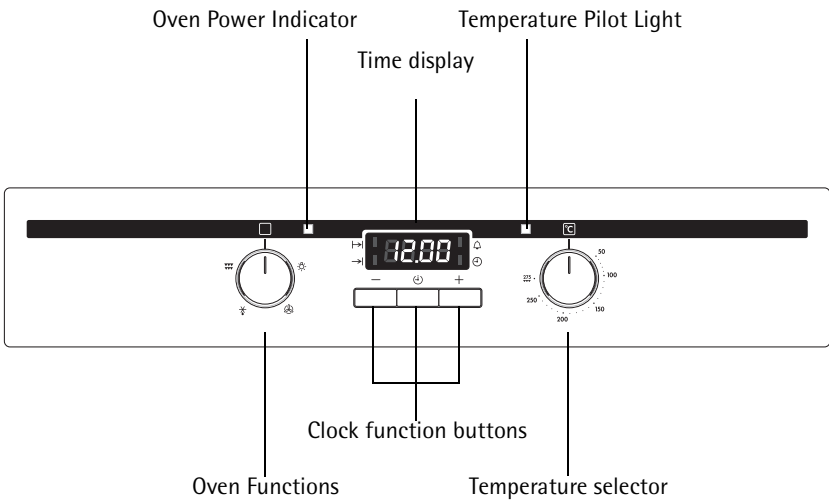

Oven Features

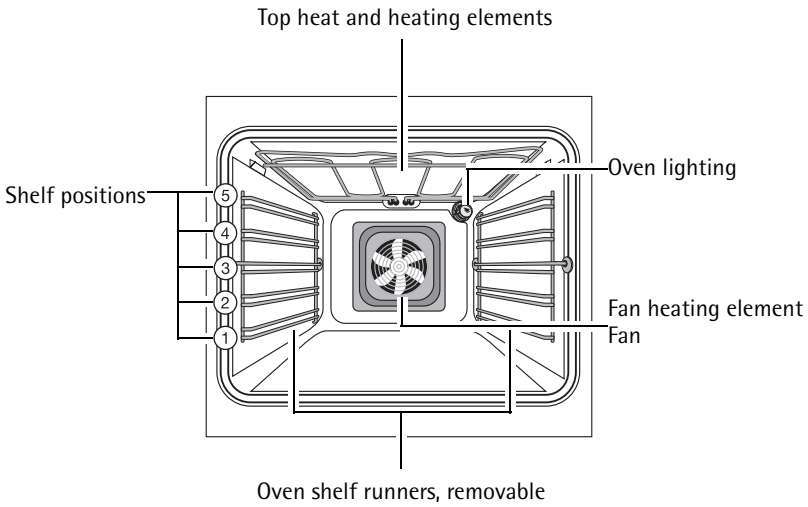

Oven Accessories

Shelf

For dishes, cake tins, items for roasting and grilling.

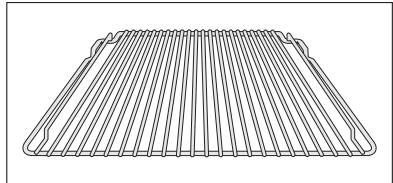

Grill pan with handle

Support for the grill tray as a collecting vessel for fat

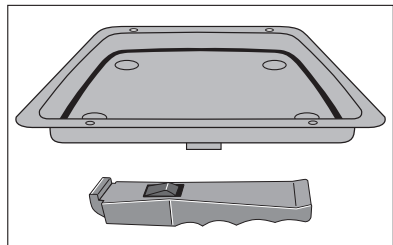

Grill tray

Insert for the grill pan for grilling smaller amounts of food

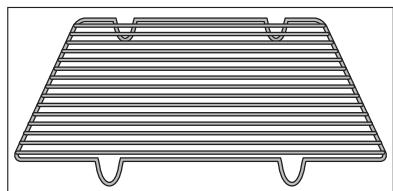



Before using for the first time

Setting and changing the current time

i The oven only operates when the time has been set.

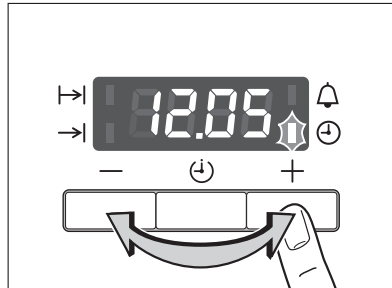
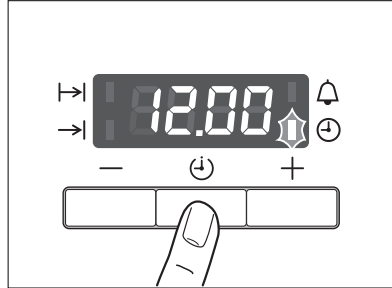

When the appliance has been connected to the electrical supply or when there has been a power cut, the function indicator Time  flashes automatically.

1. To change the time that has already been set, press the Selection  button repeatedly, until the function indicator Time  flashes.
2. Set the current time using the + or - button.



After approx. 5 seconds, the flashing stops and the clock displays the time of day set.

The appliance is now ready to use.

i The time can only be changed if neither of the automatic functions (Cook time  or End time ) have been set.

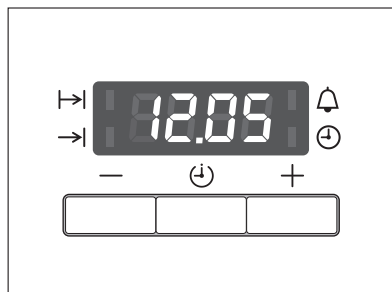

Initial Cleaning

Before using the oven for the first time you should clean it thoroughly.



Caution: Do not use any caustic, abrasive cleaners! The surface could be damaged.



To clean any metal front panels use commercially available cleaning agents.

1. Turn the oven function switch to oven lighting .
2. Remove all accessories and the shelf support rails and wash them with warm water and washing up liquid.
3. Then wash out the oven with warm water and washing-up liquid and dry.
4. Wipe the front of the appliance with a damp cloth.

Operating the Oven

Switching the Oven On and Off

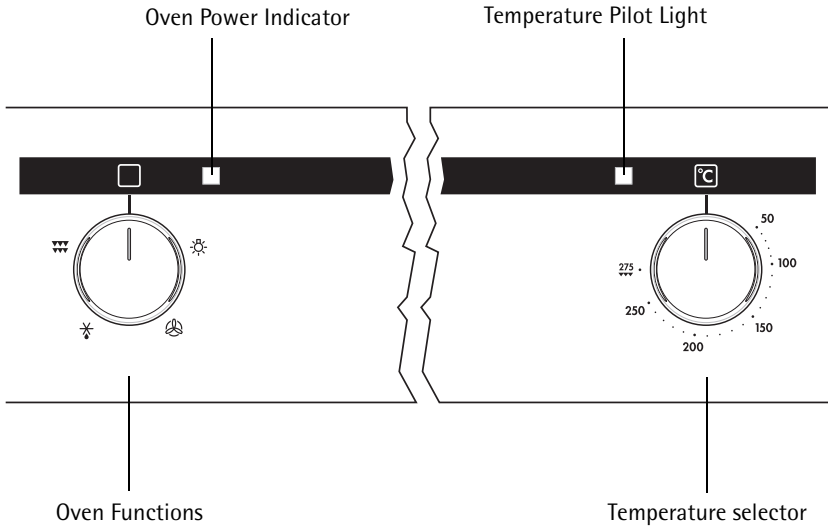

1. Turn the oven functions control knob to the desired function.
2. Turn the temperature control knob to the desired temperature.
The power indicator is lit while the oven is on.
The temperature power indicator is lit while the oven is heating up.
3. To turn the oven off, turn the oven functions and temperature control knob back to the OFF position.







Cooling fan

The fan switches on automatically in order to keep the appliance's surfaces cool. When the oven is switched off, the fan continues to run to cool the appliance down, then switches itself off automatically.

Oven Functions

The oven has the following functions:

	Oven function	Use	Heating element/ fan
	Oven Light	With this function you can light up the oven interior, e.g. for cleaning.	---
	Ventitherm® Fan Operated Cooking	For baking on up to three oven shelves at the same time. Set the oven temperatures 20-40 °C lower than when using Conventional.	Ring element, fan
	Fan Controlled Defrosting	For defrosting e. g. gateaux and flans, butter, bread, fruit or other frozen foods .	Fan
	Full Width Dual Grill	For grilling flat food items in large quantities and for toasting .	Grill, top heat

Attaching/Removing the Grill Pan Handle

The handle is particularly useful for removing the grill pan and tray more easily from the hot oven.

Attaching the handle

Insert **the handle** at an angle from above into the recess in the side of the grill pan (1) press and hold the release button, lift the handle gently and then lower it (2) let go of the release button.



Warning: Risk of burning!
Important: Check that the handle is securely attached!

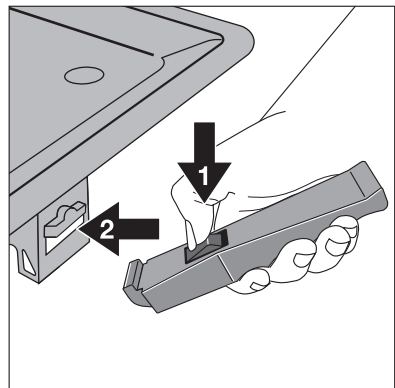

Removing the handle

Press the release button on the top of the handle (1) and lift up the handle (2) to remove it.



Important: Never leave the handle in the heated oven! Overheating can cause the handle to deform or break, and may cause an injury.

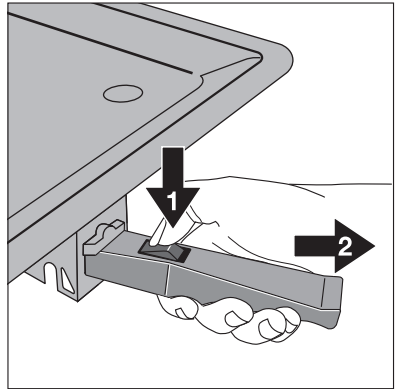

Clock Functions

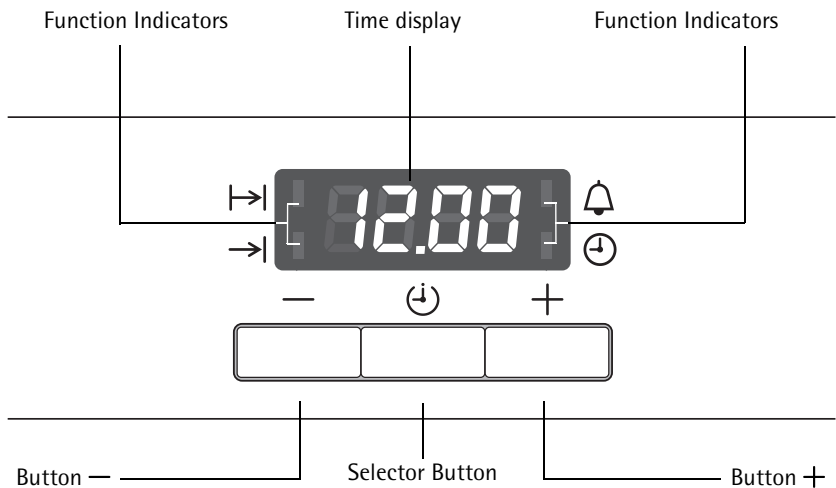

Countdown

To set a countdown. A signal sounds after the time has elapsed. This function does not affect the operation of the oven.

Cook time

To set how long the oven is to be in use.

End time

To set when the oven is to switch off again.

Time

To set, change or check the time (See also section "Before Using for the First Time").



How to use the clock functions

- When a function has been selected, the corresponding function indicator flashes for approx. 5 seconds. During this time the desired times can be set using the + or - button.
- When the desired time has been set, the function indicator flashes for approx. another 5 seconds. After that the function indicator is then lit. The set time begins to run.
- Press any of the buttons to stop the acoustic signal.
- The desired oven function and temperature can be selected before or after the clock functions Cook time (👉) and End time (👉) are set.
- When the cooking time has ended, turn the oven function and temperature dial back to the OFF position.



Switching Off the Time Display

By switching off the time display you can save energy.

Switching off the time display

Hold down any two buttons until the display becomes dark (approx. 10 seconds).



Switching on the time display

Hold down any two buttons until the time reappears in the display (approx. 10 seconds).



The display can only be switched off if none of the clock functions Cook time (👉) End time (👉) or Countdown (⏰) are in use.

Countdown

1. Press Selection  button repeatedly, until the function indicator Countdown  flashes.

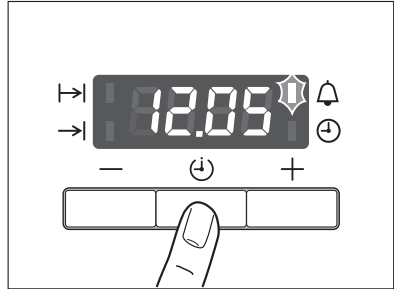

2. Using the $+$ or $-$ button, set the required Countdown (max. 2 hours 30 minutes).

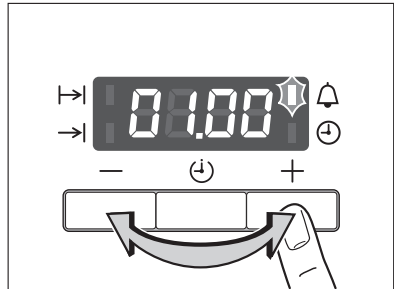

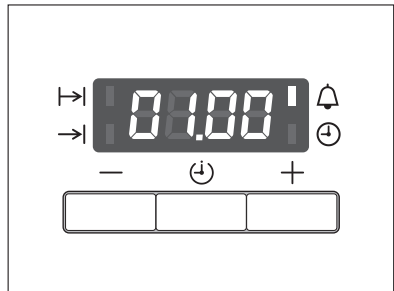

After approx. 5 seconds, the display shows the remaining time. The function indicator Countdown  will light up.

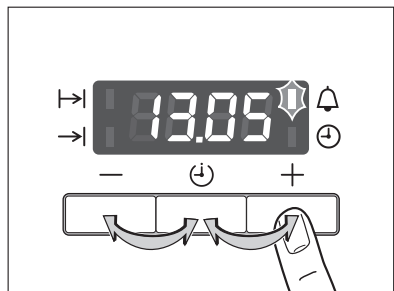

When the time has elapsed, the function indicator flashes and an acoustic signal sounds for 2 minutes. Press any button to switch off the signal.



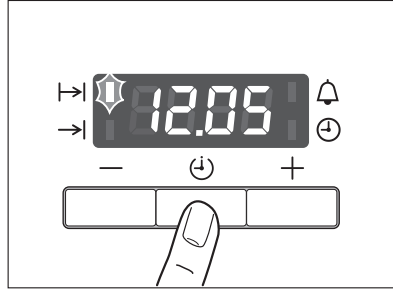

Cook time

1. Press Selection  button repeatedly, until the function indicator Cook time  flashes.

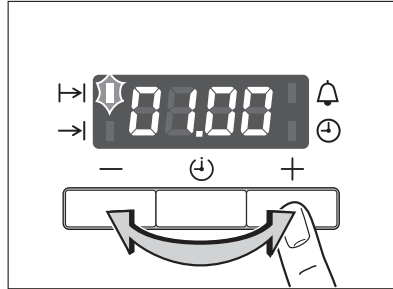

2. Using the $+$ or $-$ button, set the required cooking time.



After approx. 5 seconds, the display returns to the current time. The function indicator Cook time  will light up.

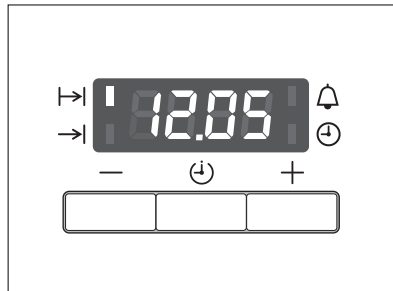

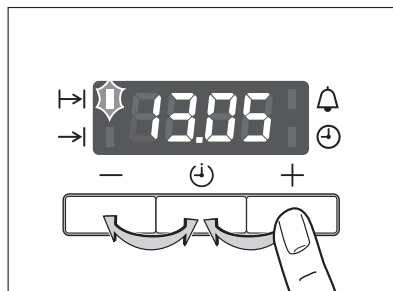

When the time has elapsed, the function indicator will flash, an acoustic signal will sound for 2 minutes and the oven will switch itself off.

3. Press any button to switch off the signal and the programme.



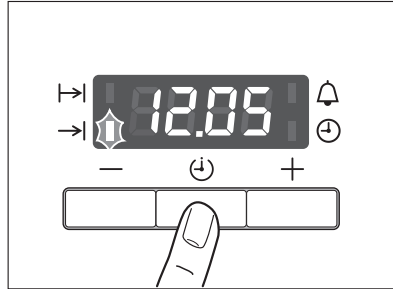

End time

1. Press Selection  button repeatedly, until the function indicator End time  flashes.

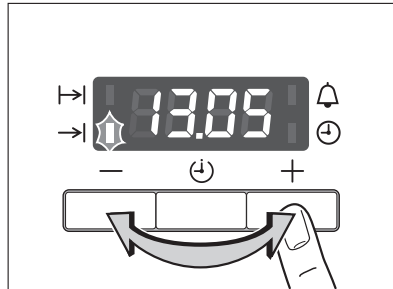

2. Using the + or - button, set the required switch-off time.



After approx. 5 seconds, the display returns to the current time. The function indicator End time  will light up.

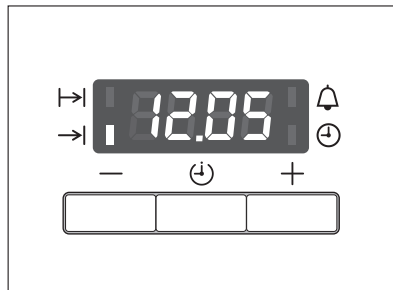

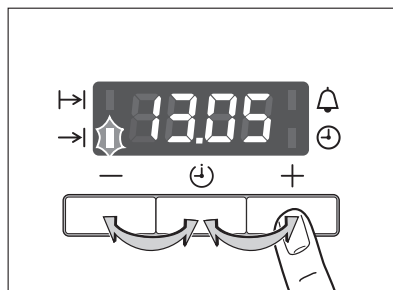

When the time has lapsed, the function indicator will flash, an acoustic signal will sound for 2 minutes and the oven will switch itself off.

3. Press any button to switch off the signal and the programme.



Cook time and End time combined



Cook time  and End time  can be used simultaneously, if the oven is to be automatically switched on and off **at a later time**.

1. Using the function Cook time  set the period of time that the dish requires to cook.

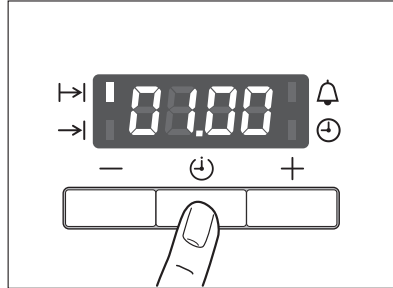

In this example, 1 hour.

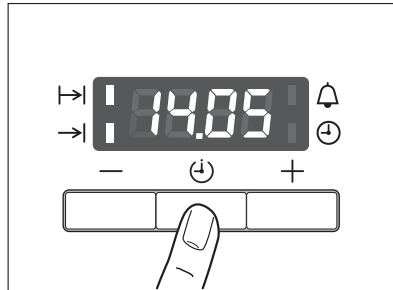

2. Using the function End time , set the time at which the dish is to be ready.

In this example, 14:05.



The function indicators Cook time  and End time  light up and the time is shown in the display. In this example, 12:05.

The oven will automatically switch itself on at the appropriate time as calculated.

In this example, at 13:05.

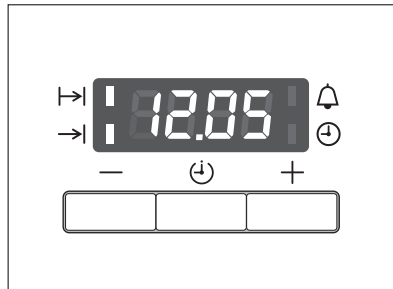

And will switch itself off when the cooking time set has elapsed.

In this example, at 14:05.

Usage, Tables and Tips

Baking

Oven function: Ventitherm® Fan Operated Cooking 

Baking tins

- For Ventitherm® Fan Operated Cooking  bright metal tins are suitable.

Oven levels

- With Ventitherm® Fan Operated Cooking  you can bake on up to 3 baking trays at the same time:

1 baking tray:
for example, oven level 3

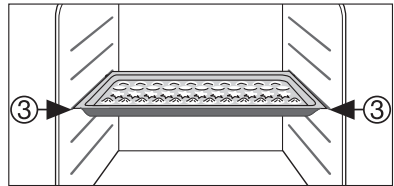

1 baking tin:
for example, oven level 1

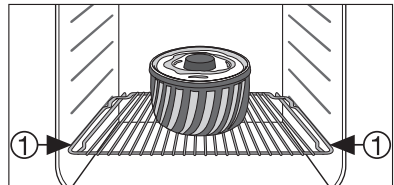

2 baking trays:
for example, oven level 1 and 3

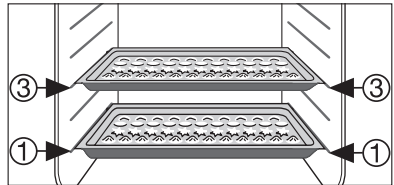

3 baking trays:
oven level 1, 3 and 5

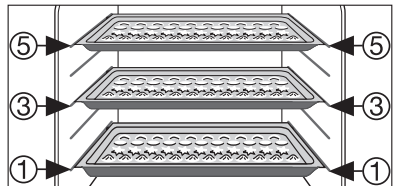

General instructions

With Ventitherm® Fan Operated Cooking  you can also bake two cakes at the same time in tins placed next to each other on the shelf. This does not significantly increase baking time.



When frozen foods are used the trays inserted may distort during cooking. This is due to the large difference in temperature between the freezing temperature and the temperature in the oven. Once the trays have cooled the distortion will disappear again.

How to use the Baking Tables

The tables give the required temperature settings, baking times and oven shelf levels for a selection of typical dishes.

- Temperatures and baking times are for guidance only, as these will depend on the consistency of pastry, mixture or dough, the number and the type of baking tin.
- We recommend setting the lower temperature when baking for the first time, and if required, e.g. if a darker browning is desired or if the baking time is too long, select a higher temperature.
- If you cannot find the settings for a particular recipe, look for the one that is most similar.
- If baking cakes on baking trays or tins on more than one level, baking time can be extended by 10-15 minutes.
- Moist recipes (for example, pizzas, fruit flans, etc.) are baked on one level.
- Cakes and pastries at different heights may brown at an uneven rate at first. If this occurs, **please do not change the temperature setting**. Different rates of browning even out as baking progresses.



With longer baking times, you can switch the oven off about 10 minutes before the end of the baking time, in order to utilise the residual heat.



Unless otherwise stated, the values given in the tables assume that cooking is started with the oven cold.

Baking Tables

Cakes, Biscuits, Bread, Pies	Ventitherm® Fan Operated Cooking 		Time
	Shelf- position	Temperature °C	Hr. : Min.
Using cake tins			
Cakes in Pound Cake tins	1	160-170	1:00-1:10
Sandcakes/Cakes in loaf tins	1	150-160	1:15-1:30
Madeira cake	1	150-160	1:00-1:10
Dundee cake	1	130-140	2:30-3:00
Large Christmas cake (10")	1	130	4:30-5:00
Victoria Sandwich	1 / 4	160	0:25-0:35
Pastry cases	1 / 4	170-190	0:10-0:25
Bakewell tart	3	160-170	0:45-0:55
Swiss roll	3	150-170 ¹⁾	0:10-0:20
Flans & quiches	3	170-180	0:30-0:50
Using baking sheets			
Short bread	1 / 4	140-150	0:40-0:50
Biscuits	1 / 4	150-170	0:15-0:25
Macaroons	1 / 4	140-150	0:25-0:35
Apple strudel	3	170-180 ¹⁾	0:30-0:50
Choux pastry buns	1 / 4	160-170 ¹⁾	0:20-0:35
Buns / cup cakes	1 / 4	150-160 ¹⁾	0:25-0:35
Scones	1 / 4	190-200 ¹⁾	0:10-0:15
Meringues	3	75	3:30-4:30
Sausage rolls	1 / 4	170-180 ¹⁾	0:20-0:35
Pizza	1	180-200	0:30-0:50
Bread			
Wholemeal bread	1	180-200 ¹⁾	0:40-0:45
White bread	1	180-200 ¹⁾	0:40-0:45

1) Pre-heat oven

Baking on more than one oven level

Type of baking	Ventitherm ® Fan Operated Cooking 	Ventitherm ® Fan Operated Cooking 	Tempe- rature in °C	Time Hours: Mins.
	Shelf positions from bottom			
	2 levels	3 levels		
Cakes/pastries/biscuits on baking trays				
Cream puffs/Eclairs	1 / 4	---	160-180 ¹⁾	0:35-0:60
Dry streusel cake	1 / 3	---	140-160	0:30-0:60
Biscuits				
Short pastry biscuits	1 / 3	1 / 3 / 5	150-160	0:15-0:35
Viennese whirls	1 / 3	1 / 3 / 5	140	0:20-0:60
Biscuits made with sponge mixture	1 / 3	---	160-170	0:25-0:40
Pastries made with egg white, meringues	1 / 3	---	80-100	2:10-2:50
Macaroons	1 / 3	---	100-120	0:40-1:20
Biscuits made with yeast dough	1 / 3	---	160-170	0:30-0:60
Puff pastries	1 / 3	---	170-180 ¹⁾	0:30-0:50
Rolls	1 / 4	---	160	0:30-0:45
Small cakes (20 per tray)	1 / 4	---	140 ¹⁾	0:25-0:40

1) Pre-heat the oven!

Tips on Baking

Baking results	Possible cause	Remedy
The cake is not browned enough at the bottom	Wrong shelf level	Place cake on a lower shelf
The cake sinks (becomes soggy, lumpy, streaky)	Oven temperature too high	Use a slightly lower temperature setting
	Baking time too short	Increase baking time Baking times cannot be reduced by setting higher temperatures
	Too much liquid in the dough/mixture	Use less liquid Pay attention to mixing times, especially if using mixing machines
Cake is too dry	Oven temperature too low	Increase oven temperature
	Baking time too long	Shorten baking time
Cake browns unevenly	Oven temperature too high and baking time too short	Set a lower temperature and increase baking time
	Dough/mixture is unevenly distributed	Spread the dough/mixture evenly on the baking tray
Cake is not cooked within the baking time set	Temperature too low	Use a slightly higher temperature setting

Table: Desserts

Desserts	Ventitherm® Fan Operated Cooking 		Time
	Shelf position	Temperature °C	Hr. : Min.
Apple pie	3	180-190	0:45-0:50
Rice pudding	3	130-140	2:00-2:30
Fruit crumble	3	160	0:50-1:10
Pineapple upside down cake	3	160	0:35-0:45
Pavlova	3	130	1:00-1:10
Baked custard	3	150-160	0:45-1:00
Baked apples	3	160-170	0:40-1:00
Bread and butter pudding	3	170-180	0:40-0:55
Apple charlotte	3	180-190	0:40-0:55
Soufflé - sweet/savoury	3	170-190 ¹⁾	0:30-0:45

1) Pre-heat oven

Roasting

Oven function: Ventitherm[®] Fan Operated Cooking 

Roasting dishes

- Any heat-resistant ovenware is suitable for roasting. (Please read the manufacturer's instructions.)
- Large roasting joints can be cooked **directly in the tray or on the shelf with the tray placed below**
- For all lean meat, we recommend **roasting these in a roasting tray with a lid**. This makes the meat more succulent.
- All types of meat, that can be browned or have crackling, can be roasted in the **roasting tin without the lid**.



Tips on using the roasting chart

The figures in the following table are for guidance only.

- We recommend cooking meat and fish **over 1 kg in weight** in the oven.
- To prevent escaping meat juices or fat from burning on to the pan, we recommend placing some water in the roasting pan.
- Turn the meat as required (after about 1/2 - 2/3 of cooking time).
- Baste large roasting joints and poultry several times during the cooking time. This will give better roasting results.
- Switch off the oven approx. 10 minutes prior to the end of the cooking time in order to use the residual heat.

Table: Meat, roasting, casseroles

Meat	Ventitherm® Fan Operated Cooking 		Time
	Shelf position	Temperature °C	Hrs. : Min.
Pork			
Shoulder; leg; rolled; boned spare rib; loin of pork	1	170-180	0:30-0:35 per 450 g/1 lb plus 30-35 mins
Beef			
Inexpensive cuts	1	160-170	0:35-0:40 per 450 g/1 lb plus 15-20 mins
Prime cuts			
-rare	1	170-180 ¹⁾	0:15-0:20 per 450 g/1 lb plus 15-20 mins
-medium	1	170-180	0:20-0:25 per 450 g/1 lb plus 25-25 mins
-well done	1	170-180	0:30-0:35 per 450 g/1 lb plus 25-30 mins
Yorkshire pudding			
- small	3	200 ¹⁾	0:10-0:15
- large	1	180-190 ¹⁾	0:30-0:40
Lamb	1	170-180	0:30-0:35 per 450 g/1 lb plus 30-35 mins
Veal	1	170-180	0:30-0:35 per 450 g/1 lb plus 30-35 mins

1) Pre-Heat oven

Table: Roasting, casseroles, au gratin

Poultry, Game, Fish, Vegetables	Quantity approx.	Ventitherm® Fan Operated Cooking 		Time
		Shelf position	Tempera- ture °C	Hrs. : Min.
Casseroles, miscellaneous				
Casseroles	1 kg/2 lbs	1	150	2:30-3:00
Lancashire, Hot Pot	1 kg/2 lbs	1	150-160	2:15-2:30
Moussaka	1 kg/2 lbs	1	170-180	0:40-0:50
Meat Loaf	675 g/1.5 lbs	1	170-180	1:00-1:10
Poultry / Game				
Chicken	1 kg/2 lbs	1	170-180	0:50-1:10
Chicken	1.5 kg/3 lbs	1	170-180	1:15-1:30
Duck	1.5-2 kg/3.5-4 lbs	1	180-190	1:15-1:45
Goose	3.5-5 kg/ 8-10 lbs	1	170-180	2:30-3:00
Turkey	2.5-3.5 kg/5-7 lbs	1	160	1:30-2:00
Turkey	4-6 kg/8-13 lbs	1	150-160	2:30-4:00
Pheasant, Wild Duck, Rabbit	1 kg/2 lbs	3	210	0:30-1:00
Partridge/Pigeon	per 300-500g	3	190-200	0:30-0:50
Fish (baked, steamed)				
Whole fish	1-1.5 kg/2-3 lbs	1	160-170	0:45-1:15
Fish pies, bakes	750 g-1 kg/ 1.5-2 lbs	3	170-190	0:30-1:00
Vegetables				
Stuffed pepper/aubergines		1	180-190	0:30-1:00
Au gratin dishes		3	180-200	0:15-0:45

Defrosting

Oven function: Fan Controlled Defrosting  (no temperature setting)

- Unpack the food and place it on a plate on the oven shelf.
- Do not cover with a plate or bowl, as these can substantially lengthen the defrosting time.
- For defrosting, place the shelf on the **1st oven level from the bottom**.

Defrosting table

Food	Defrosting time Min.	Further defrosting time (mins.)	Comments
Chicken, 1000 g	100-140	20-30	Place the chicken on an upturned saucer placed on a large plate. Halfway through the time, turn it over
Meat, 1000 g	100-140	20-30	Halfway through the time, turn it over
Meat, 500 g	90-120	20-30	Halfway through the time, turn it over
Trout, 150g	25-35	10-15	---
Strawberries, 300g	30-40	10-20	---
Butter, 250g	30-40	10-15	---
Cream, 2 x 200g	80-100	10-15	Cream that is still slightly frozen in part can still be whipped
Flan/gateau, 1400g	60	60	---

Grill sizes

Oven function: Full Width Dual Grill  with maximum temperature setting



Important: Always grill with the oven door closed.



The empty oven should **always be pre-heated with the grill functions for 5 minutes.**

- When grilling, use the oven shelf and drip pan together.
- The grilling times are for guidance only.
- Grilling is particularly suitable for flat pieces of meat or fish.

Grilling table

Food to be grilled	Oven level	Grilling time	
		1st side	2nd side
Burgers	4	8-10 mins.	6-8 mins.
Pork fillet	4	10-12 mins.	6-10 mins.
Sausages	4	8-10 mins.	6-8 mins.
Fillet steaks, veal steaks	4	6-7 mins.	5-6 mins.
Fillet of beef, roast beef (approx. 1 kg)	3	10-12 mins.	10-12 mins.
Toast ¹⁾	3	4-6 mins.	3-5 mins.
Toast with topping	3	6-8 mins.	---

1) Use the grill without the roasting tray, do not pre-heat

Cleaning and care



Warning: For cleaning, the appliance must be switched off and cooled down.

Warning: For safety reasons, **do not** clean the appliance with steam jet or high-pressure cleaning equipment.

Important: **Do not use any abrasive cleaners, sharp scrapers or abrasive items.**

Outside of the appliance

- Wipe the front of the appliance with a soft cloth and a solution of washing-up liquid and warm water.
- With metal fronts use the cleaners that are commercially available.

Oven interior

Clean the appliance after each use. In this way, residues are easier to clean off and are not allowed to burn on.

1. To clean the oven, switch the oven light on.
2. After every use, wipe the oven with a solution of washing-up liquid and allow to dry.



Remove stubborn residues with a special oven cleaner.



Warning: If using an oven spray, please follow the manufacturer's instructions exactly.

Accessories

Wash all slide-in units (shelf unit, baking tray, shelf support rails etc.) after each use and dry well. Soak briefly to make them easier to clean.

Shelf Support Rails

The shelf support rails on the left and right hand sides of the oven can be removed for cleaning the side walls.

Removing the shelf support rails

First pull the front of the rail away from the oven wall (1) and then unhook at the back (2).

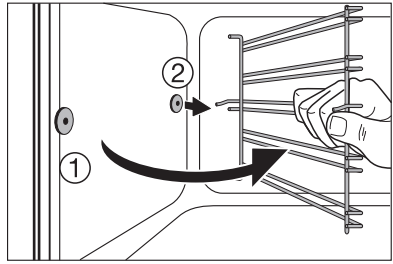
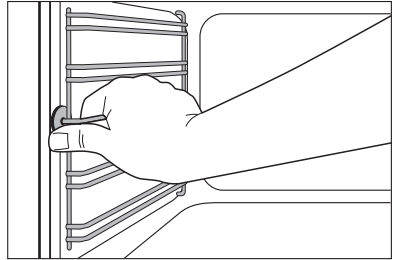

Fitting the shelf support rails



Important! The rounded ends of the guide rails must be pointing forwards!

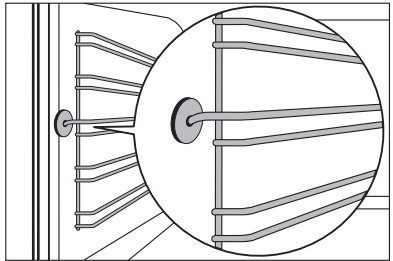

To re-insert, first hook the rail into place at the back (1) and then insert the front and press into place (2).

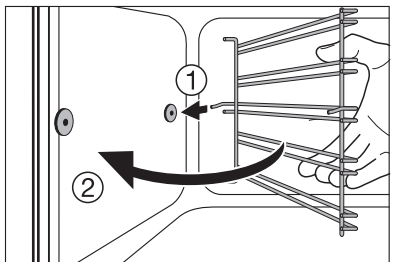

Oven Lighting



Warning: Risk of electric shock! Prior to changing the oven light bulb:
– Switch off the oven!
– Disconnect from the electricity supply.



Place a cloth on the oven floor to protect the oven light and glass cover.

Changing the oven light bulb/ cleaning the glass cover

1. Remove the glass cover by turning it anti-clockwise and then clean it.
2. If necessary: replace with **25 watt, 230 V, 300 °C heat-resistant oven lighting.**
3. Refit the glass cover.

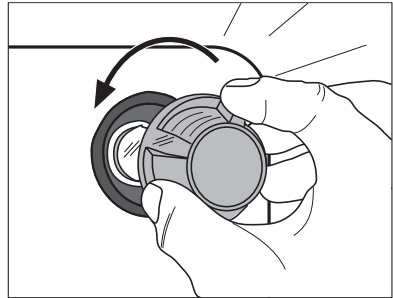

Oven Roof

The upper heating element can be folded down to make it easier to clean the oven roof.

Folding down the heating element

 **Warning:** Only fold down the heating element when the oven is switched off and there is no risk of being burnt!

1. Remove the side shelf support rails.
2. Grip the heating element at the front and pull it forwards and out over the support lug on the inner wall of the oven.
3. The heating element will now fold down.

 **Caution:** Do not use force to press the heating element down! The heating element might break.

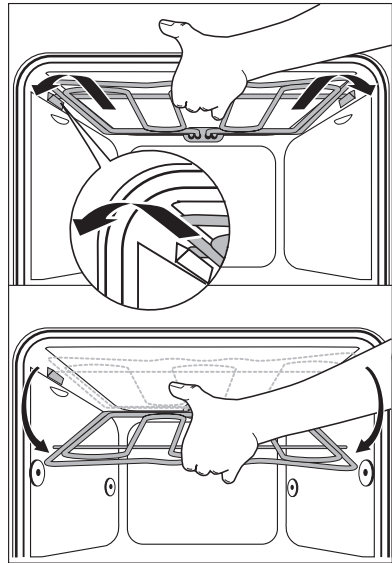

Clean the oven roof

Repositioning the heating element

1. Move the heating element back up towards the oven roof.
2. Pull the heating element forwards against the spring pressure and guide it over the oven support lug.
3. Settle it onto the support.
4. Insert shelf support rail.

 **Important:** The heating element must be positioned correctly and securely on both sides above the support lug on the inner wall of the oven.

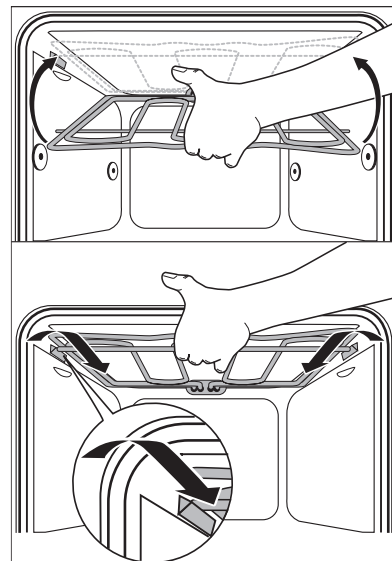

Oven Door

The door of your appliance may be removed for cleaning.

Removing the oven door

1. Open the oven door completely.
2. **Completely** fold back the **clamping levers** on both door hinges.
3. Grip the oven door with both hands and close it about 3/4 **going past the point of resistance**.
4. Pull the door away from the oven (**Caution:** the door is heavy!)
5. Place the door, with the outer surface downwards, on a soft, flat surface, (for example on a blanket) to avoid scratches.

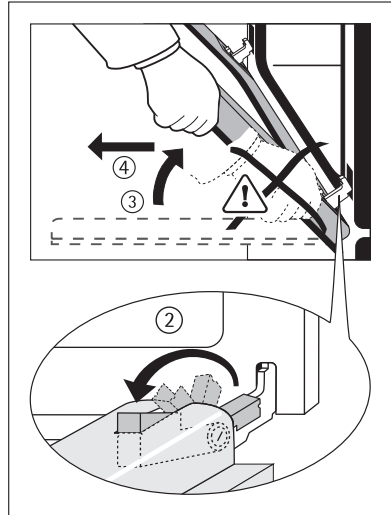

Hanging the oven door

1. From the side of the door on which the handle is positioned, take hold of the sides of the door with both hands.
2. Hold the door at an angle of approx. 60°.
3. Insert the door hinges as far as possible into the two slots on the right and left at the bottom of the oven **at the same time**.
4. Lift the door up until resistance is met and then open it fully.
5. Fold the clamping levers on both door hinges back into their original position.
6. Close the oven door

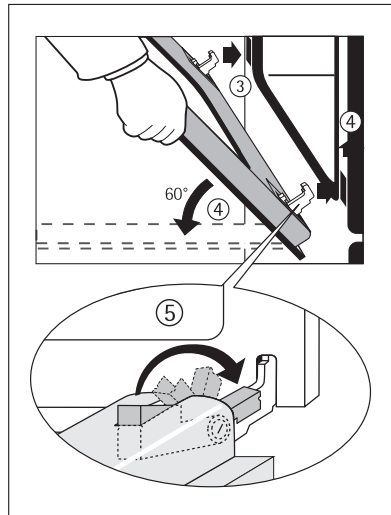

Oven Door Glass

The oven door is fitted with two glass panels mounted one behind the other. The inner panel can be removed for cleaning.



Caution: the following steps must be performed only with the oven door removed! If the glass is removed while the door is attached, the lighter weight may cause it to spring up and cause injury.



Important! Rough handling of the glass, especially at the edges of the front panel, may cause it to break.

Removing the glass from the door

1. Detach the door and, with the handle downwards, place it on a soft, even surface.
2. Grasp the top glass panel underneath, and push it towards the door handle against the pressure spring, until it comes free (①).
3. Hold the panel **gently** underneath, and slide it out (②).

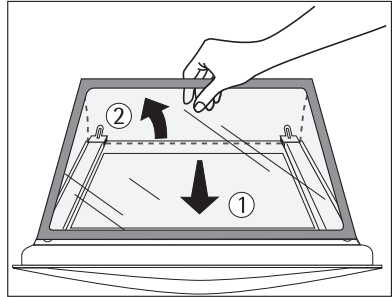

Clean the glass panel

Inserting the glass to the door

1. Insert the panel at an angle from above into the section of the door in which the handle is located (①).
2. Lower the panel. Place the glass against the pressure spring at the handle end, and in front of the retaining frame at the bottom of the door, then push it **into the frame** (②).

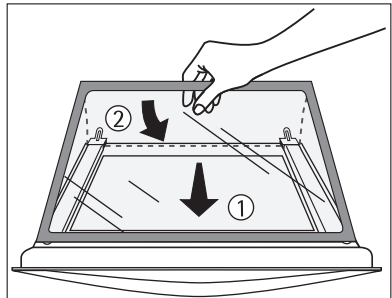

The glass panel must be firmly attached!

Re-hang the door to the oven.

What to do if ...

Problem	Possible cause	Remedy
The oven does not heat up	The oven is not switched on	Switch the oven on
	The clock is not set	Set the current time on the clock
	The necessary settings have not been carried out	Check the settings
	A fuse in the house's wiring system (in the fuse box) has tripped	Check fuses If the fuses trip several times, please call a qualified electrician
The oven lighting is not operating	The oven bulb is faulty.	Replace oven bulb

If you are unable to remedy the problem by following the above suggestions, please contact your local Service Force Centre.



Warning! Repairs to the appliance are only to be carried out by qualified service engineers. Considerable danger to the user may result from improper repairs.



If the appliance has been wrongly operated, the visit from the service technician or dealer may not take place free of charge, even during the warranty period.



Advice on cookers with metal fronts:

Because of the cooler surface at the front of the cooker, opening the oven door during (or just after) baking or roasting may cause the glass to steam up.

Electrical Connection

The oven is designed to be connected to 230-240V~(50Hz) electricity supply.

The oven has an easily accessible terminal block which is marked as follows:

- Letter L - Live terminal
- Letter N - Neutral terminal
- ⊕ - Earth terminal



This oven must be earthed!

The cable used to connect the oven to the electrical supply must comply to the specifications given below.

For UK use only

Connection via	Min. size Cable/flux	Cable/flux type	Fuse
Cooker Control Circuit	2,5 mm ²	PVC/PVC twin and earth	min: 15A max: 20A

It is necessary that you install a double pole switch between the oven and the electricity supply (mains), with a minimum gap of 3mm between the switch contacts and of a type suitable for the required load in compliance with the current regulations.

The switch must not break the yellow and green earth cable at any point.

Important

After installation and connecting, the cable must be placed so that it cannot at any point reach a temperature of more than 50°C above the ambient temperature.

Before the oven is connected, check that the main fuse and the domestic installation can support the load; and that the power supply is properly earthed.

The manufacturer declines any responsibility should these safety measures not be carried out.

Installation Instructions



Attention: The new appliance may only be installed and connected by a **registered expert**.

Please comply with this. If you do not, any damage resulting is not covered by the warranty.



Safety information for the installer

- The electrical installation is to be set up so that the appliance can be isolated from the mains with a minimum 3mm all-pole contact separation.
Suitable separation devices include e.g. cut-outs, fuses (screw fuses are to be taken out of the holder), RCD's and contactors.
- Anti-shock protection must be provided by the installation.
- The built-in unit must meet the stability requirements of DIN 68930.
- Built-in ovens and built-in cooking surfaces are fitted with special connection systems. For safety reasons, they must only be combined with appliances from the same manufacturer.

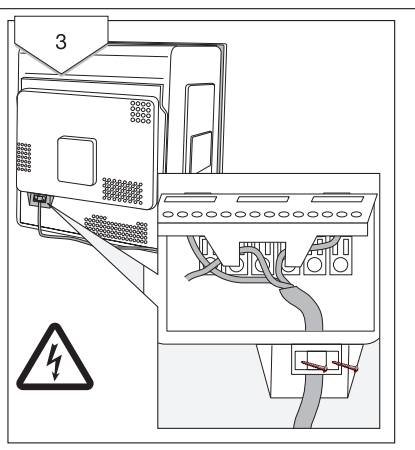
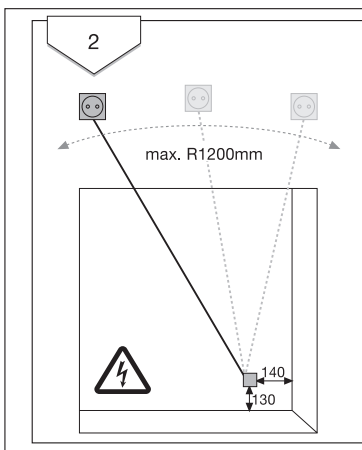
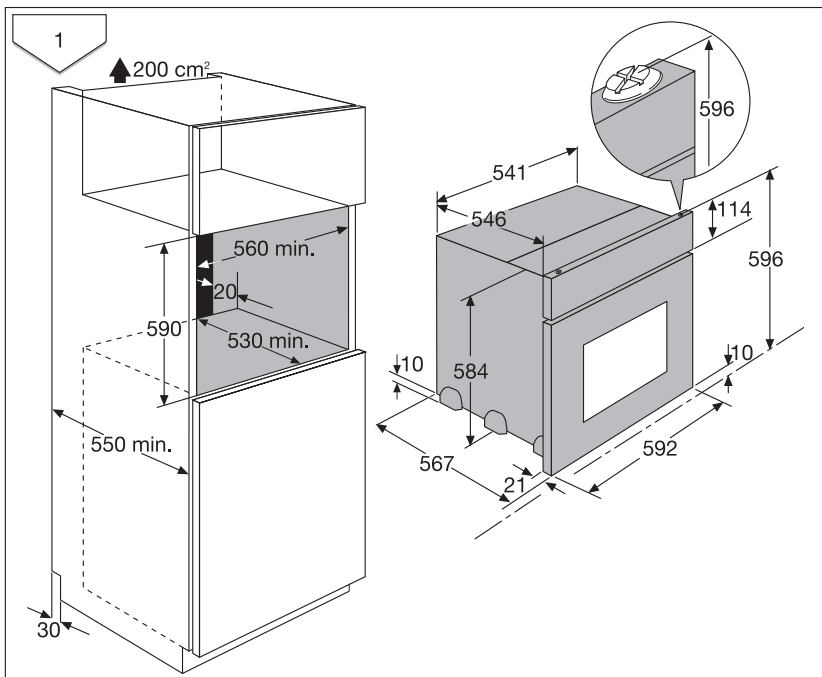

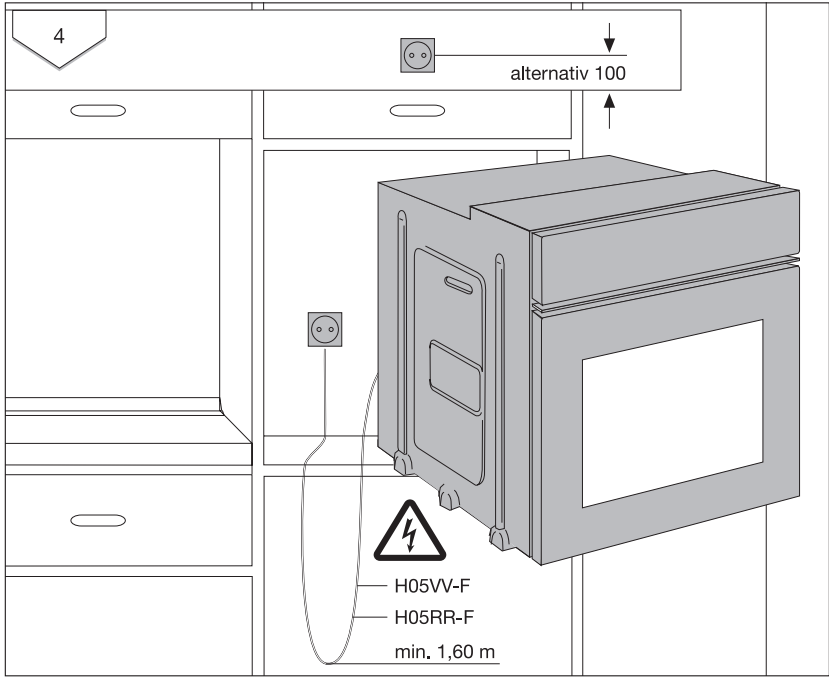

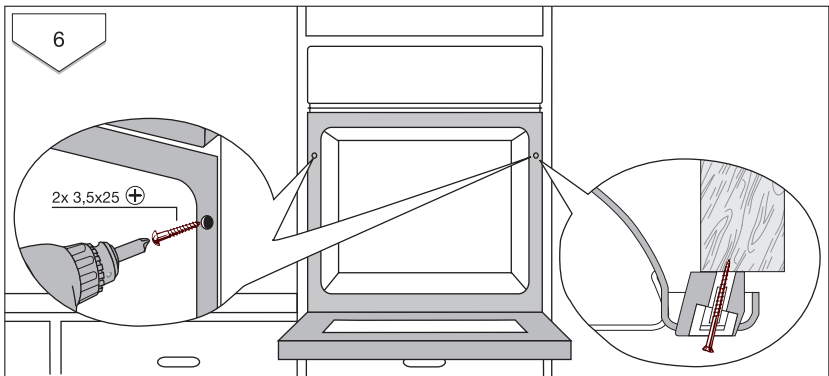
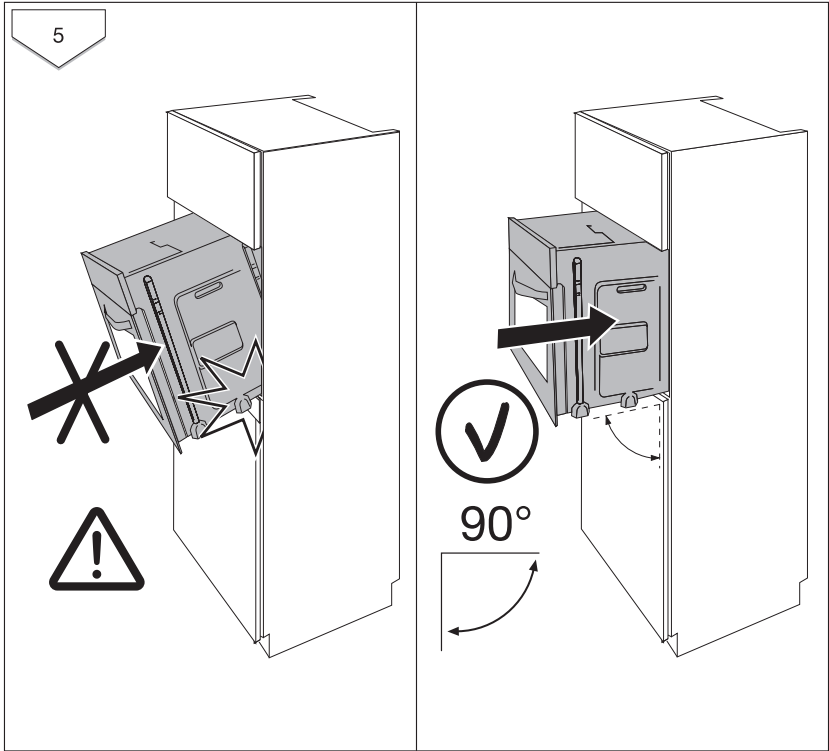

Warranty conditions

Great Britain

Standard guarantee conditions

We, AEG, undertake that if within 12 months of the date of the purchase this AEG appliance or any part thereof is proved to be defective by reason only of faulty workmanship or materials, we will, at our discretion repair or replace the same FREE OF CHARGE for labour, materials or carriage on condition that:

- The appliance has been correctly installed and used only on the electricity or gas supply stated on the rating plate.
- The appliance has been used for normal domestic purposes only, and in accordance with the manufacturer's operating and maintenance instructions.
- The appliance has not been serviced, maintained, repaired, taken apart or tampered with by any person not authorised by us.
- All service work under this guarantee must be undertaken by a Service Force Centre. Any appliance or defective part replaced shall become the Company's property.
- This guarantee is in addition to your statutory and other legal rights.
- Home visits are made between 8.30am and 5.30pm Monday to Friday. Visits may be available outside these hours in which case a premium will be charged.

Exclusions

This guarantee does not cover:

- Damage or calls resulting from transportation, improper use or neglect, the replacement of any light bulbs or removable parts of glass or plastic.
- Costs incurred for calls to put right an appliance which is improperly installed or calls to appliances outside the United Kingdom.
- Appliances found to be in use within a commercial environment, plus those which are subject to rental agreements.
- Products of AEG manufacture which are not marketed by AEG.

European Guarantee

If you should move to another country within Europe then your guarantee moves with you to your new home subject to the following qualifications:

- The guarantee starts from the date you first purchased your product.
- The guarantee is for the same period and to the same extent for labour and parts as exists in the new country of use for this brand or range of products.
- This guarantee relates to you and cannot be transferred to another user.
- Your new home is within the European Community (EC) or European Free Trade Area.
- The product is installed and used in accordance with our instructions and is only used domestically, i.e. a normal household.
- The product is installed taking into account regulations in your new country.

Before you move please contact your nearest Customer Care centre, listed below, to give them details of your new home. They will then ensure that the local Service Organisation is aware of your move and able to look after you and your appliances.

France	Senlis	+33 (0) 3 44 62 29 29
Germany	Nürnberg	+49 (0) 800 234 7378
Italy	Pordenone	+39 (0) 800 117511
Sweden	Stockholm	+46 (0) 8 672 5360
UK	Luton	+44 (0) 8705 350 350

Service and Spare Parts

If the event of your appliance requiring service, or if you wish to purchase spare parts, please contact Service Force by telephoning:

0870 5 929 929

Your telephone call will be automatically routed to the Service Force Centre covering your post code area.

For the address of your local Service Force Centre and further information about Service Force, please visit the website at

www.serviceforce.co.uk

Before calling out an engineer, please ensure you have read the details under the heading „What to do if...“

When you contact the Service Force Centre you will need to give the following details:

1. Your name, address and post code.
2. Your telephone number.
3. Clear and concise details of the fault.
4. The model and serial number of the appliance (found on the rating plate)
5. The purchase date.

Please note that a valid purchase receipt or guarantee documentation is required for in-guarantee service calls.

Customer Care

For general enquiries concerning your AEG appliance, or for further information on AEG products please contact our Customer Care Department by letter or telephone at the address below or visit our website at **www.aeg.co.uk**.

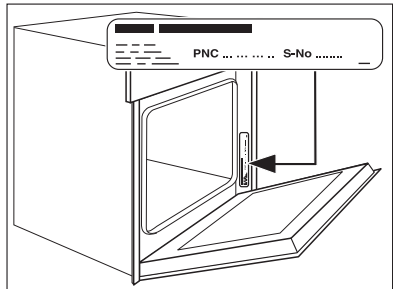

Customer Care Department
Major Appliances
AEG Domestic Appliances
Addington Way
Luton
Bedfordshire, LU4 9QQ
Tel: 08705 350350 (*)

For Customer Service in the Republic of Ireland please contact us at the address below:

AEG/ Electrolux Group (Ire) Ltd
Long Mile Road/ Dublin 12
Republic of Ireland
Tel: +353 (0) 1 4090754
Email: service.eid@electrolux.ie

(*) Calls may be recorded for training purposes

 **From the Electrolux Group. The world's No. 1 choice.**

The Electrolux Group is the world's largest producer of powered appliances for kitchen, cleaning and outdoor use. More than 55 million Electrolux Group products (such as refrigerators, cookers, washing machines, vacuum cleaners, chain saws and lawn mowers) are sold each year to a value of approx. USD 14 billion in more than 150 countries around the world.

AEG Hausgeräte GmbH
Postfach 1036
D-90327 Nürnberg

<http://www.aeg-electrolux.de>

© Copyright by AEG

822 926 246-A-290805-02

Subject to change without notice