

ZANUSSI

BUILT-IN OVEN

ZOB 1060

INSTRUCTION BOOKLET

Please read this instruction booklet before using the appliance

GB

Important Safety Information



You **MUST** read these warnings carefully before installing or using the oven. If you need assistance, contact our Customer Care Department on 08705 727727

Installation

- This oven must be installed by qualified personnel to the relevant British Standards.
- This oven is heavy. Take care when moving it.
- Remove all packaging, both inside and outside the oven, before using the oven.
- Do not attempt to modify the oven in any way.

Child Safety

- This oven is designed to be operated by adults. Do not allow children to play near or with the oven.
- The oven gets hot when it is in use. Children should be kept away until it has cooled.

During Use

- This oven is intended for domestic cooking only. It is not designed for commercial or industrial purposes.
- Appliances become very hot with use, and retain their heat for long periods after use. Care should be taken to avoid touching heating elements inside the oven.
- **Always stand back from the oven when opening the oven door during cooking or at the end of it to allow any build up of steam or heat to release.**
- Never line any part of the oven with aluminium foil.
- Do not allow heatproof cooking material, e.g. roasting bags, to come into contact with oven elements.
- Never place plastic or any other material which may melt in or on the oven.
- Do not place sealed cans or aerosols inside the oven. They may explode if they are heated.
- Do not hang towels, dishcloths or clothes from the oven or its handle.
- Do not use this oven if it is in contact with water and never operate it with wet hands.
- Take great care when heating fats and oils as they will ignite if they become too hot.
- Always use oven gloves to remove and replace food in the oven.
- Ensure that all control knobs are in the OFF position when not in use.
- Do not leave cookware containing foodstuffs, e.g. fat or oil in or on the oven in case it is inadvertently switched ON.
- When using other electrical appliances, ensure the cable does not come into contact with the hot surfaces of the oven.

Maintenance and Cleaning

- Only clean this oven in accordance with the instructions.
- The oven should be kept clean at all times. A build-up of fats or other foodstuffs could result in a fire, especially in the grill pan.
- Never use steam or high pressure steam cleaners to clean the appliance.
- Always allow the oven to cool down and switch off the electrical supply before carrying out any cleaning or maintenance work.

Service

- This oven should only be repaired or serviced by an authorised Service Engineer and only genuine approved spare parts should be used.

Environmental Information

- After installation, please dispose of the packaging with due regard to safety and the environment.
- When disposing of an old appliance, make it unusable, by cutting off the cable. Remove any door catches, to prevent small children being trapped inside.

Keep this instruction book for future reference and ensure it is passed on to any new owner.

Guide to use the instructions

The following symbols will be found in the text to guide you throughout the Instructions:

 Safety Instructions

 Step by step instructions for an operation

 Hints and Tips

 Environmental Information

 This appliance complies with the following **E.E.C. Directives:**

- * **73/23 - 90/683** (Low Voltage Directive);
- * **93/68** (General Directives);
- * **89/336** (Electromagnetical Compatibility Directive).

and subsequent modifications

Contents

For the User

Important Safety Information	2
Description of the Oven	3
Control Panel	4
When the oven is first installed	5
Hints and Tips	8
Programming the Oven	9
Safety and Energy Saving Functions	10
The Fan Oven	12
The Conventional Oven	13
Cooking chart - Fan and Conventional Oven	14
Grilling	15
Cooking chart - Grilling	16
Pizza Oven	17
Defrosting	17
Cleaning the Oven	18
Care of catalytic liners	19
Cleaning the hinged grill	19
Something not working	20
Service and Spare Parts	20
Customer Care	21
Guarantee conditions	21

For the Installer

Installation	22
Electrical Connection	22
Building In	23

Description of the Oven

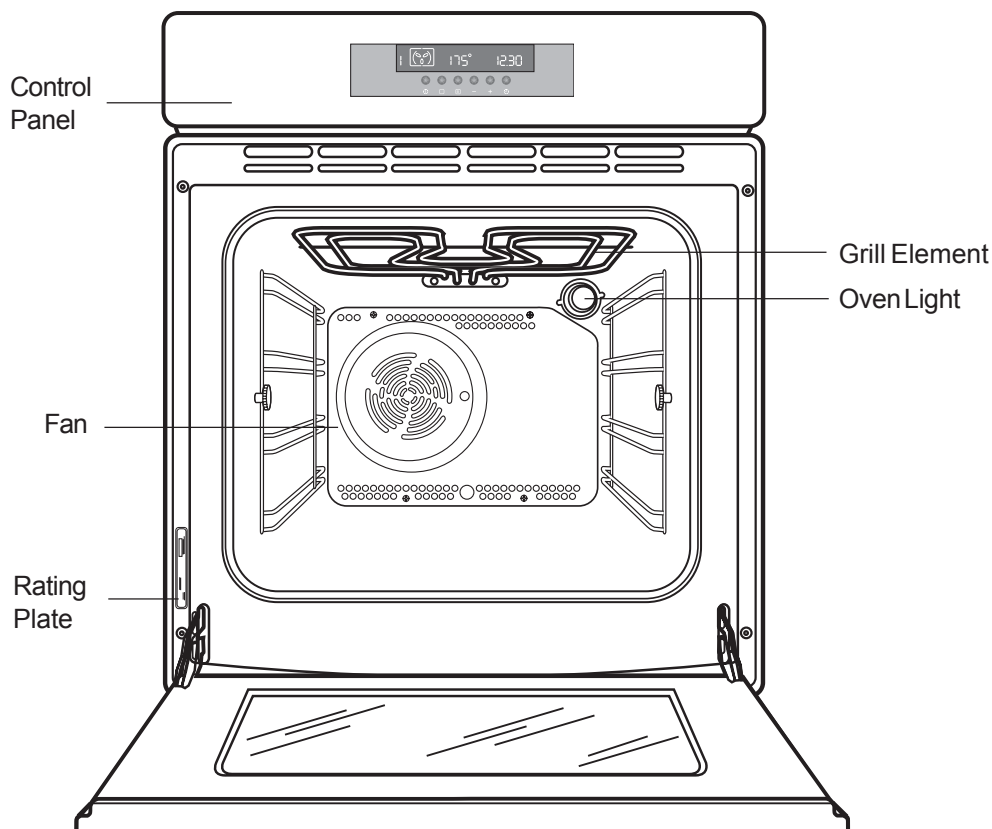

Control Panel

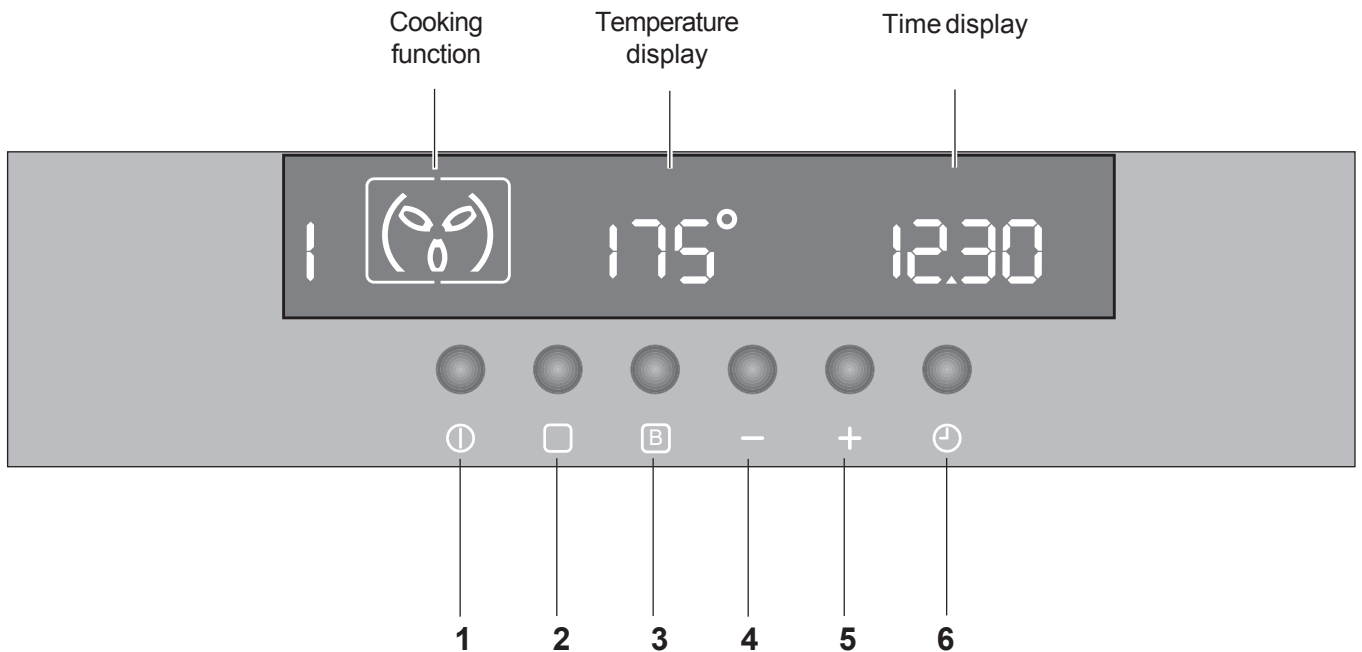

Push buttons

1. ON / OFF
2. Oven Function Control
3. Fast Heat Up Function
4. Decreasing Control “-“ (Time or Temperature)
5. Increasing Control “+“ (Time or Temperature)
6. Minute minder / Cooking duration function / End of cooking function

All the oven functions are controlled by an electronic programmer.



You can select any combination of cooking function, cooking temperature and automatic timing.

NOTE

In the event of a power failure, the programmer will keep all the settings (time of day, programme setting or programme in operation) for about 3 minutes. If power fails for a longer time, all the settings will be cancelled. When the power is restored, the numbers in the display will flash, and the clock/timer has to be reset.

Special functions

The following functions can be activated by pressing two buttons at the same time:

- Child lock: press button  and button “-“;
- Beep on touch: press button  and button “+“;
- Demo mode: press button  and button “+“.



When the oven is first installed

 Remove **all packaging**, both inside and outside the oven, before using the oven.



When the oven is first connected to the electrical supply, the display will automatically show 12:00 and the symbol  will flash.

Ensure the correct time of day is set before using the oven.

To set the correct time of day :

a) press button  and, while the symbol  is flashing (Fig. 1), set the correct time of day by pressing buttons “-” or “+” (Fig. 2).

The time arrow symbol  will disappear about 5 seconds after the correct time is displayed (Fig. 3).



b) if the symbol  is not flashing anymore, press button  twice.



Then, proceed as described in point a).

Before first use

The oven should be heated without food.

To do that, proceed as follows:

- press button  to switch on the oven.
- press button  twice and select the "Conventional Cooking" function  (Fig. 4).
- set the temperature to 250 °C using the increasing push button “+”.
- Allow the oven to run **empty** for approximately 45 minutes.
- open a window for ventilation.

This procedure should be repeated with the "Fan Cooking"  and "Full Grill"  function for approximately 5-10 minutes.

 During this time, an unpleasant odour may be emitted. This is absolutely **normal**, and is caused by residues of manufacturing. Once this operation is carried out, let the oven cool down, then clean the oven cavity with a soft cloth soaked in warm water to which a little mild washing-up liquid has been added.

 Before cooking for the first time, carefully wash the **shelves** and the **baking tray**.

 To open the oven door, always hold the handle in the centre (Fig. 5).

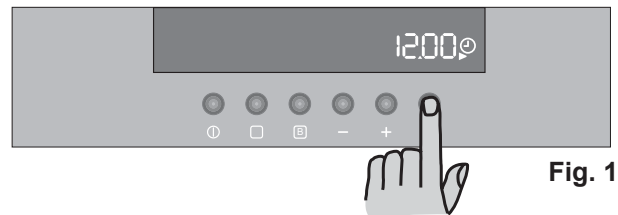

Fig. 1

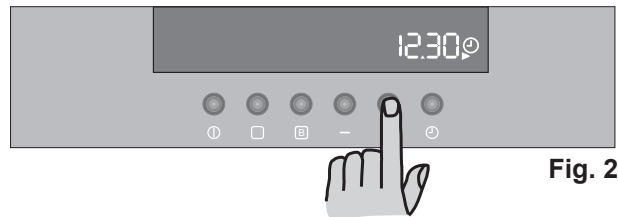

Fig. 2



Fig. 3

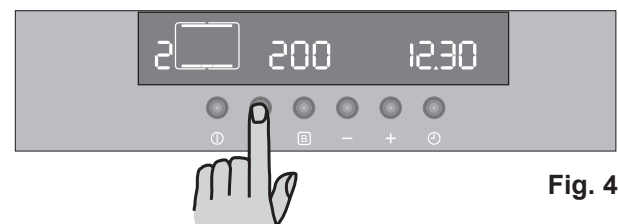

Fig. 4

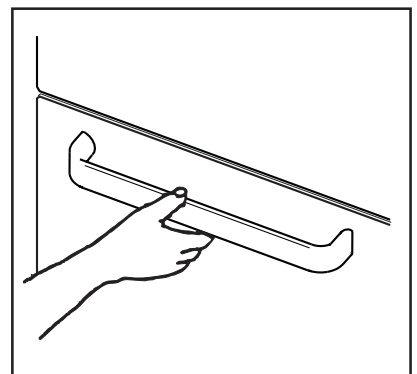

Fig. 5

"On/Off" Push Button

The oven must be switched on before setting any cooking function or programme. When button ① is pressed, the oven symbol will appear in the display, and the oven light will switch on.

To switch off the oven, you can press button ① at any time. Any cooking function or programme will stop, the oven light will switch off and the time display will show the time of day only.

It is possible to switch off the oven at any time.

How to select a Cooking Function

1) Switch on the oven by pressing the ① button.
2) Press button □ to select the required oven function. Each time button □ is pressed, a cooking symbol will appear in the display and the corresponding cooking function number will appear to the left of the currently selected cooking function symbol (Fig. 6).

3) If the pre-set temperature is not suitable, press button "—" or "+" to adjust the temperature in 5 degree steps.

- as soon as the oven heats up, the thermometer symbol

rises slowly 🌡️, indicating the degree to which the oven is currently heated;

When the required temperature is reached, an acoustic alarm will sound for a short time and the thermometer symbol 🌡️ will illuminate permanently.

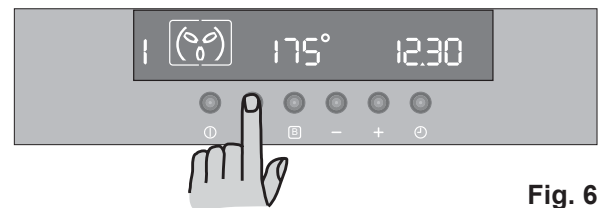

Fig. 6

How to set the temperature and cooking time

Press button "—" and "+" to increase or decrease the pre-set temperature while the "o" symbol is flashing (Fig. 7). The maximum temperature is 250°C.

Press button "—" and "+" to increase or decrease the pre-set cooking time while the symbol ▶ is flashing (Fig. 7).

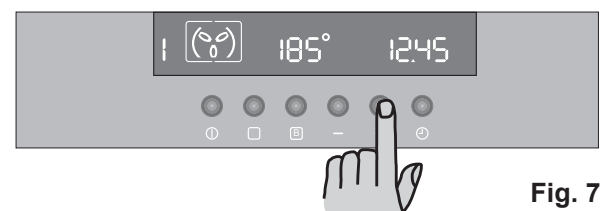











Fig. 7

Function Symbols

- 1  **Fan cooking** - This setting allows you to roast or roast and bake simultaneously using any shelf, without flavour transference. Pre-set temperature: 175 °C
- 2  **Conventional cooking** - The heat comes from both the top and bottom element, ensuring even heating inside the oven. Pre-set temperature: 200 °C
- 3  **Inner Grill** - can be used for grilling small quantities. Pre-set temperature: 250 °C
- 4  **Thermal Grilling** - This function offers an alternative method of cooking food items, normally associated with conventional grilling. The grill element and the oven fan operate together, circulating hot air around the food. Pre-set temperature: 180 °C
Select a maximum temperature of 200°C.
- 5  **Pizza Oven** - The bottom element provides direct heat to the base of pizzas, quiches or pies, while the fan ensures air is circulated to cook the pizza toppings or pie fillings. Pre-set temperature: 175 °C
- 6  **Full Grill** - The full grill element will be on. Recommended for large quantities. Pre-set temperature: 250 °C
- 7  **Bottom heating element** - The heat comes from the bottom of the oven only, to allow you to finish your dishes. Pre-set temperature: 250 °C
- 8  **Top heating element** - The heat comes from the top of the oven only, to allow you to finish your dishes. Pre-set temperature: 250 °C
- 9  **Defrosting** - The oven fan operates without heat and circulates the air, at room temperature, inside the oven. This function is particularly suitable for defrosting delicate food which could be damaged by heat, e.g. cream filled gateaux, iced cakes, pastries, bread and other yeast products.

Using the Oven



Always cook with the oven door closed.

Stand clear when opening the oven door.



The oven has four shelf levels, counted from the bottom, as shown in the diagram. Your oven is supplied with two anti-tip shelves.

It is important that these shelves are correctly positioned as shown in the diagram.

Do not place cookware directly on the oven base.

Attention! - Do not place objects on the oven base and do not cover any part of the oven with aluminium foil while cooking, as this could cause a heat build-up which would affect the baking results and damage the oven enamel. Always place pans, heat-resisting pans and aluminium trays on the shelf which has been inserted in the shelf runners.

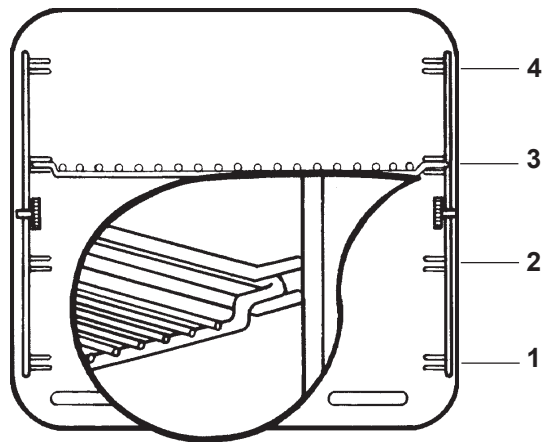

Oven accessories

Removable handle

Grill Pan Grid

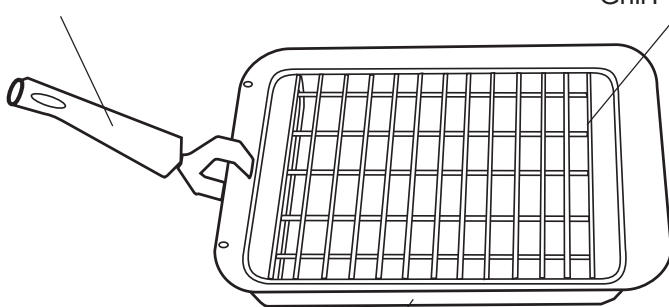

Grill / Roasting pan

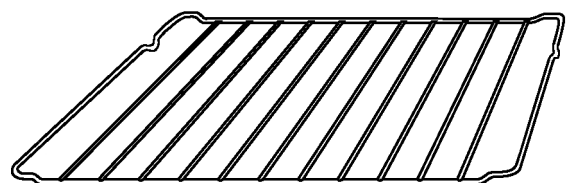

Anti-tip shelf (x 2)

Hints and Tips

Condensation and steam

The oven is supplied with an exclusive system which produces a natural circulation of air and the constant recycling of steam. This system makes it possible to cook in a steamy environment and keep the dishes soft inside and crusty outside. Moreover, the cooking time and energy consumption are reduced to a minimum. During cooking steam may be produced which can be released when opening the oven door. This is absolutely normal.

However, always stand back from the oven when opening the oven door during cooking or at the end of it to allow any build up of steam or heat to release.

If the steam comes into contact with a cool surface on the outside of the oven, e.g. a trim, it will condense and produce water droplets. This is quite normal and is not a fault with the oven.

To prevent discolouration, regularly wipe away condensation and also soilage from surfaces.

Cookware

- Use any oven proof cookware which will withstand temperatures of 250 °C.
- Baking trays, oven dishes, etc. should not be placed directly against the grid covering the fan at the back of the oven, or placed on the oven base.
- Do not use baking trays larger than 30 cm x 35 cm (12 in x 14 in) as they will restrict the circulation of heat and may affect performance.

The effects of dishes on cooking results

Dishes and tins vary in their thickness, conductivity, colour, etc. which affects the way they transmit heat to the food inside them.

A Aluminium, earthenware, oven glassware and bright shiny utensils reduce cooking and base browning.

B Enamelled cast iron, anodised aluminium, aluminium with non-stick interior and coloured exterior and dark, heavy utensils increase cooking and base browning.

Cooling fan

The cooling fan operates during cooking. Air is expelled through vents between the oven door and the control panel, as shown in the diagram.

The cooling fan may run on after the oven is switched off to keep the controls cool. This is quite normal.

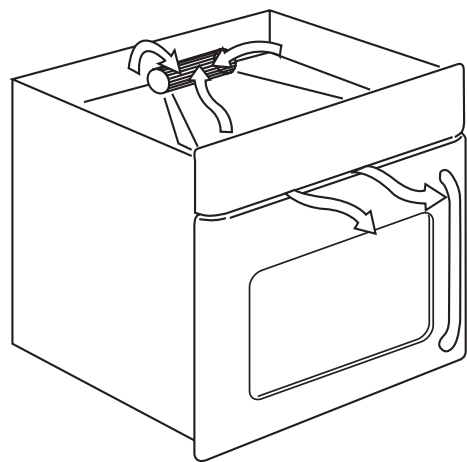

The Safety Thermostat

This oven is provided with a safety thermostat. In case of malfunctioning of the main thermostat, and consequent over-heating, the safety device will stop the power supply to the appliance. If this happens, call your local Service Force Centre. Under no circumstances should you attempt to repair the appliance yourself.





Programming the Oven

How to set the minute minder



- 1) Press button  to select the Minute Minder function (Fig. 8). The relevant  symbol will flash and the control panel will display "0.00".
- 2) Press button "+" to select the required time. Maximum time is 23 hours 59 minutes. After it has been set, the Minute Minder will wait 3 seconds and then start running (Fig. 9).
- 3) When the programmed time has elapsed, an acoustic alarm will be heard.
- 4) To switch off the acoustic alarm, press any button.

i The oven will NOT switch off if in use. The Minute Minder function can also be used as well when the oven is off.

To use or to change the Minute Minder setting:

press button  until the symbols  and  flash. It is now possible to change the Minute Minder setting by pressing button "-" or "+".

To cancel the Minute Minder:

press button  until the symbols  and  flash. Press button "-" to decrease the time until "0.00" is displayed (Fig. 10).

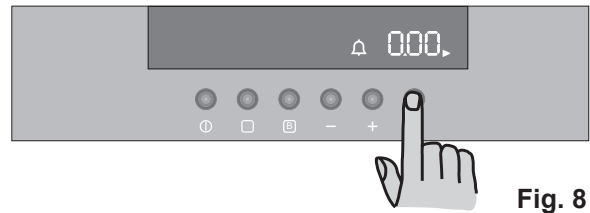

Fig. 8



Fig. 9

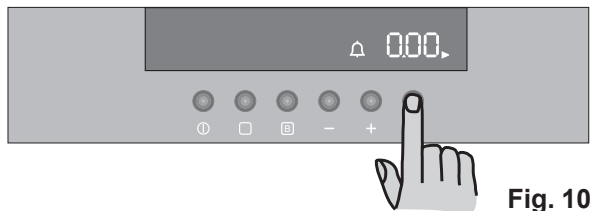







Fig. 10

To programme the Oven to switch off

- 1) Place food in the oven, switch on the oven, select a cooking function and adjust the cooking temperature, if required (Fig. 11).
- 2) Press button  to select the "Cooking Duration" function (Fig. 12). The "Cooking Duration" symbol  will flash and the control panel will display "0.00".
- 3) While the symbol  is flashing, press button "+" to select the required time. Maximum time is 23 hours 59 minutes. The programmer will wait 3 seconds and then start running.
- 4) When cooking time is over, the oven will be switched off automatically and an acoustic alarm will be heard while the control panel will display "0.00".
- 6) To switch off the acoustic alarm, press any button.

To cancel the Cooking Duration Time:

- press button  until the symbol  will flash.
- press button "-" to decrease the time until "0.00" is displayed (Fig. 13).

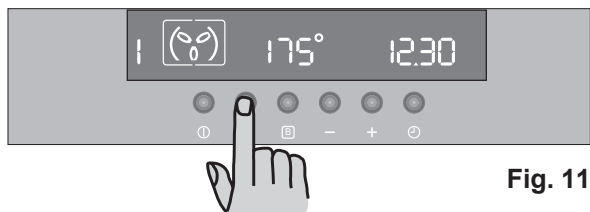

Fig. 11

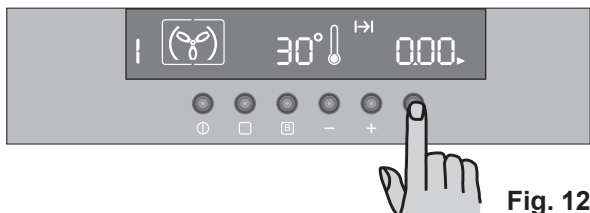

Fig. 12

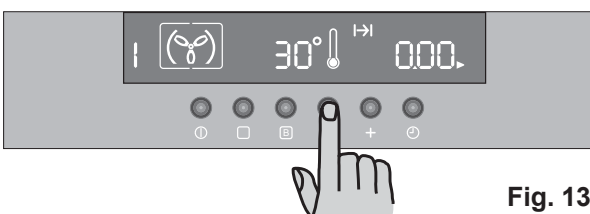



Fig. 13

To Programme the Oven to Switch On and Off

- 1) Carry out the "Cooking Duration" setting as described in the relevant chapter.
- 2) Press button  until the "End of Cooking" function  is selected and the relevant symbol flashes. The control panel will display the end of cooking time (that is, the actual time + cooking duration time - Fig. 14).
- 3) Press button "+" to select the required end of cooking time.
- 4) After this is set, the programmer will wait 3 seconds and then start running.
- 5) The oven will switch on and off automatically. The end of cooking will be marked by an acoustic alarm.
- 6) To switch off the acoustic alarm, press any button.

To cancel the programme, simply cancel the Duration Time.

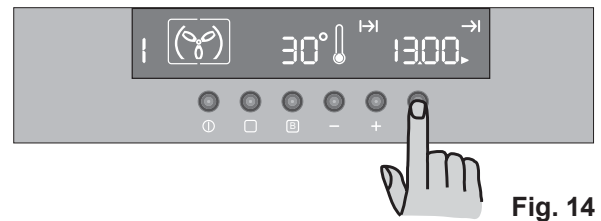

Fig. 14

Safety and Energy Saving Functions

Safety Cut-Off Function

The oven will switch off automatically if any change of setting is made, according to the table below (Fig. 15).

If temperature setting is:	the oven will switch off:
250°C	after 1 1/2 hours
from 200 up to 245°C	after 5,5 hours
from 120 up to 195°C	after 8,5 hours
less than 120°C	after 12 hours

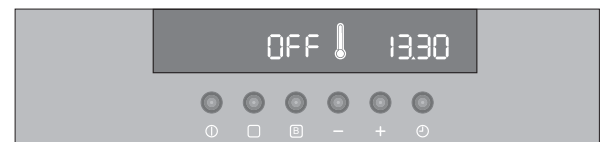



Fig. 15

Residual Heat Function

When a Cooking Duration time is set, the oven will automatically switch off a few minutes before the end of the programmed time, and use the residual heat to finish your dishes without energy consumption. All current settings will be displayed until the Cooking Duration time is over. This function will not operate when the Cooking Duration time is less than 15 minutes.

Child Safety Function

To avoid children switching on the oven, it is possible to lock the oven controls.

- 1) Turn off the oven by pressing button .
- 2) Press buttons  and "-" at the same time and keep them pressed for about 3 seconds. An acoustic signal will be emitted and the indication 'SAFE' will appear on the display (Fig. 16).
- 3) The oven is now locked. Neither oven functions nor temperatures can be selected.

To unlock the oven:

Press buttons  and "-" at the same time and keep them pressed for about 3 seconds. An acoustic signal will be emitted and the indication 'SAFE' will go off. The oven can now be operated (Fig. 17).

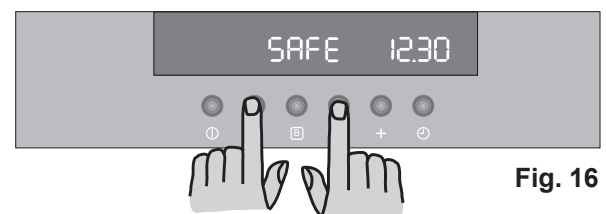

Fig. 16

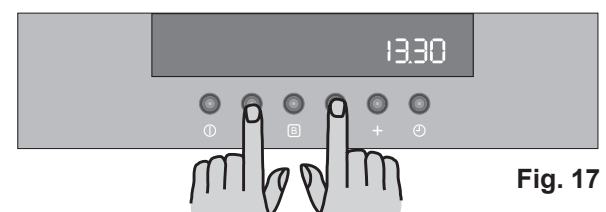

Fig. 17

"Fast Heat Up" function

After a cooking function has been selected and the temperature has been adjusted, the cavity will gradually heat up until the selected temperature is reached. This will take from 10 to 15 minutes, depending on selected function and temperature.

If it is necessary to reach the required temperature in a shorter time, the "Fast Heat Up" Function can be used.

- 1) Switch the oven on by pressing button **ⓘ**.
- 2) Set the required cooking function and temperature as explained in the previous pages.
- 3) Set the temperature by pressing button "**-**" or "**+**". The temperature will appear on the display.
- 4) Press button **B**. The temperature display will show "FHU" (Fig. 18).
- 5) press button **□** and the symbol "°" will flash for approximately 10 seconds. Now it is possible to select the required temperature by pressing button "**-**" or "**+**".
- 4) When the required temperature is reached, an acoustic alarm will sound for a short time, and the temperature display will revert to the set temperature.

This function can be used with any cooking function or temperature.

Demo mode

This mode is intended to be used in the shops to demonstrate the oven functionality without any power consumption except the oven lamp. To activate this function the appliance should be in stand-by mode.

- Press button **B** and "**+**" for approximately 2 seconds (Fig. 19). An acoustic alarm will sound for a short time.
- Press button **ⓘ** and the "id" indication will appear in the display.

All oven functions can be selected.

The thermometer symbol **🌡** will not flash anymore and "id" indication will be replaced by number digits.

Follow the above described procedure to disable the demo mode.

Error code

The electronic programmer does a continuous diagnostic check of the system. If some parameters are not correct, the control unit will stop the activated functions and it will show on the display the corresponding error code (Fig. 20).

For further details, refer to chapter "Something not working" on page 20.

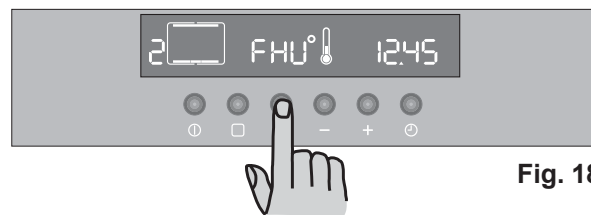

Fig. 18

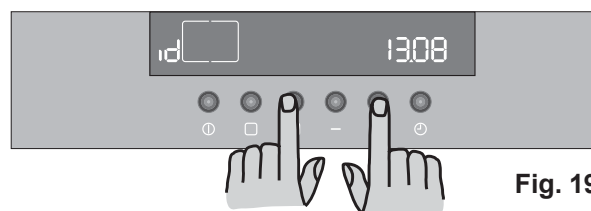

Fig. 19



Fig. 20

The Fan Oven

The air inside the oven is heated by the element around the fan situated behind the back panel. The fan circulates hot air to maintain an even temperature inside the oven.

The advantages of cooking with this function are:

- **Faster Preheating**

As the fan oven quickly reaches temperature, it is not usually necessary to preheat the oven although you may find that you need to allow an extra 5-7 minutes on cooking times. For recipes which require higher temperatures, best results are achieved if the oven is preheated first, e.g. bread, pastries, scones, souffles, etc.

- **Lower Temperatures**

Fan oven cooking generally requires lower temperatures than conventional cooking.

Follow the temperatures recommended in the cooking chart. Remember to reduce temperatures by about 20-25 °C for your own recipes which use conventional cooking.

- **Even Heating for Baking**

The fan oven has uniform heating on all shelf positions. This means that batches of the same food can be cooked in the oven at the same time. However, the top shelf may brown slightly quicker than the lower one.

This is quite usual. There is no mixing of flavours between dishes.



1. Switch the oven on.
2. Press the Oven Function Control button and select the "Fan Cooking" function.
3. If necessary adjust temperature setting using the "+" or "-" buttons.

THINGS TO NOTE

- The oven light will come on when the oven is switched on.
- The cooling fan will operate continually during cooking. It may run on after the oven is switched off to keep the controls cool. This is quite normal.

NOTE

The action of the cooling fan will depend on how long the oven has been used and at what temperature. It may not switch on at all at lower temperature settings nor run on where the oven has only been used for a short time.

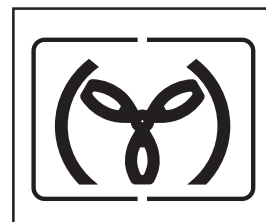

FAN OVEN FUNCTION SYMBOL
PRE-SET TEMPERATURE: 175°C
TEMPERATURE SELECTION: 50°C - 250°C

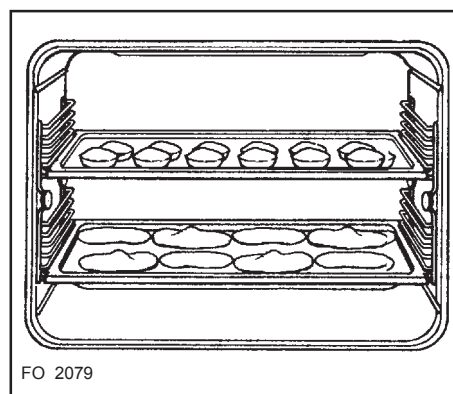

Fig. 21

Hints and Tips

Shelf positions are not critical, but make sure the shelves are evenly spaced.

When cooking more than one dish in the fan oven, place dishes centrally on the shelves rather than several dishes on one shelf.

When the oven is full, you may need to allow a slightly longer cooking time.

A shelf may be placed on the floor of the oven. Place dishes on a shelf in this position rather than on the oven base, to allow air circulation around the food.

When the oven is full of the same food, e.g. equal trays of small cakes or equal size victoria sandwich cakes, then they will be cooked in the same time and removed from the oven together. When different sizes of trays or types of food, e.g. biscuits and cakes are cooked, they will not necessarily be ready together.

The fan oven can be used to heat foods through without thawing first, e.g. fruit tarts, mince pies, sausage rolls, and other small pastry items. Use a temperature of 190-200 °C and allow 20-40 minutes (depending on the quantity of food in the oven).

The use of too high temperatures can cause uneven browning. Check with the recommendations for oven temperatures given in the cooking charts, but be prepared to adjust the temperature by 10 °C if necessary. Remember to reduce temperatures by about 20-25 °C for your own conventional recipes.



The meat tin **should not** be placed on a heated hotplate or burner as this may cause the enamel to crack.

The Conventional Oven

When using this setting, heat comes from both the top and bottom elements. This allows you to cook on a single level and is particularly suitable for dishes which require extra base browning such as quiches and flans.

Gratins, lasagnes and hotpots which require extra top browning also cook well in the conventional oven. This form of cooking gives you the opportunity to cook without the fan in operation.

How to Use the Conventional Oven

1. Switch the oven ON.
2. Select the Conventional Oven Function by pressing the Oven Function control button  until the symbol  appears in the display.

Bottom oven element only

This function is particularly useful when blind-baking pastry. It may also be used to finish off quiches or flans to ensure the base pastry is cooked through.

Pre-set temperature is 250°C.

Top oven element only

This function is particularly useful to finish off quiches or flans to ensure the top pastry is cooked through.

Pre-set temperature is 250°C.

THINGS TO NOTE

During cooking, the cooling fan will operate in the same way as described for the fan oven function.

Hints and Tips

The middle shelf position allows for the best heat distribution. To increase base browning simply lower the shelf position. To increase top browning, raise the shelf position.

The material and finish of the baking trays and dishes used will affect base browning. Enamelware, dark, heavy or non-stick utensils increase base browning, while oven glassware, shiny aluminium or polished steel trays reflect the heat away and give less base browning.

Always place dishes centrally on the shelf to ensure even browning.

Stand dishes on suitably sized baking trays to prevent spillage onto the base of the oven and make cleaning easier.

Do not place dishes, tins or baking trays directly on the oven base as it becomes very hot and damage will occur.

For faster preheating use the Fast Heat-Up Function.

Single level cooking gives best results. If you require more than one level cooking use the fan oven function.

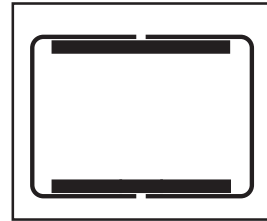

CONVENTIONAL OVEN FUNCTION SYMBOL
PRE-SET TEMPERATURE: 200°C
TEMPERATURE SELECTION: 50°C - 250°C

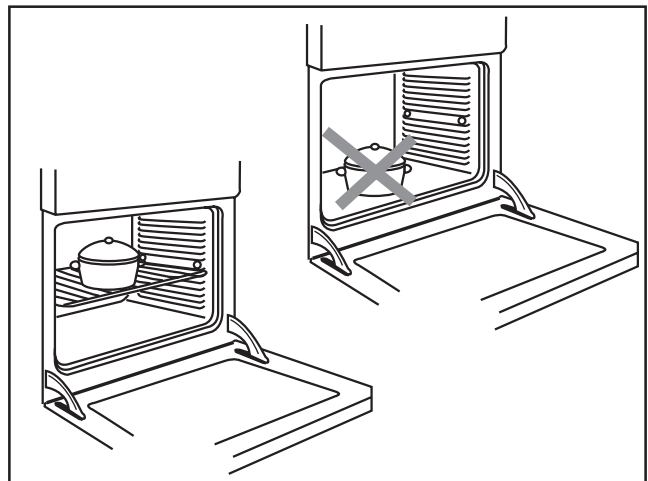



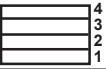
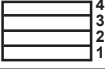

Fig. 22

Cooking Chart- Fan and Conventional Oven

Weight (gr.)	TYPE OF DISH	Traditional Cooking 		Fan Oven 		Cooking time  minutes	NOTES
		Level 	temp. °C	Level 	temp. °C		
	CAKES						
	Whisked recipies	2	170	2 (1 and 3)*	160	45 ~ 60	In cake mould
	Shortbread dough	2	170	2 (1 and 3)*	160	20 ~ 30	In cake mould
	Butter-milk cheese cake	1	160	2	150	60 ~ 80	In cake mould
	Apple cake	1	180	2 (1 and 3)*	170	40 ~ 60	In cake mould
	Strudel	2	175	2	150	60 ~ 80	
	Jam-tart	2	175	2 (1 and 3)*	160	30 ~ 40	
	Fruit cake	1	175	1	160	45 ~ 60	In bread tin
	Sponge cake	1	175	2 (1 and 3)*	160	30 ~ 40	In cake mould
	Christmas cake	1	170	1	160	40 ~ 60	In cake mould
	Plum cake	1	170	1	160	50 ~ 60	In bread tin
	Small cakes	2	175	2 (1 and 3)*	160	25 ~ 35	In baking tray
	Biscuits	2	160	2 (1 and 3)*	150	20 ~ 30	In baking tray
	Meringues	2	100	2 (1 and 3)*	100	90 ~ 120	In baking tray
	Buns	2	190	2 (1 and 3)*	180	12 ~ 20	In baking tray
	Pastry: Choux	2	200	2 (1 and 3)*	190	15 ~ 25	In baking tray
	BREAD AND PIZZA						
1000	White bread	1	190	2	180	40 ~ 60	1-2 pieces
500	Rye bread	1	190	1	180	30 ~ 45	In bread tin
500	Bread rolls	2	200	2 (1 and 3)*	175	20 ~ 35	6-8 rolls
250	Pizza	1	210	2 (1 and 3)*	190	15 ~ 30	on baking tray
	FLANS						
	Pasta flan	2	200	2 (1 and 3)*	175	40 ~ 50	in mould
	Vegetable flan	2	200	2 (1 and 3)*	175	45 ~ 60	in mould
	Quiches	1	200	2 (1 and 3)*	180	35 ~ 45	in mould
	Lasagne	2	180	2	160	45 ~ 60	in mould
	Cannelloni	2	200	2	175	40 ~ 55	in mould
	MEAT						
1000	Beef	2	190	2	175	50 ~ 70	On grid
1200	Pork	2	180	2	175	100 ~ 130	On grid
1000	Veal	2	190	2	175	90 ~ 120	On grid
1500	English roast beef						
1500	rare	2	210	2	200	50 ~ 60	On grid
1500	medium	2	210	2	200	60 ~ 70	On grid
1500	well done	2	210	2	200	70 ~ 80	On grid
2000	Shoulder of pork	2	180	2	170	120 ~ 150	With rind
1200	Shin of pork	2	180	2	160	100 ~ 120	2 pieces
1200	Lamb	2	190	2	175	110 ~ 130	Leg
1000	Chicken	2	190	2	175	60 ~ 80	Whole
4000	Turkey	2	180	2	160	210 ~ 240	Whole
1500	Duck	2	175	2	160	120 ~ 150	Whole
3000	Goose	2	175	2	160	150 ~ 200	Whole
1200	Rabbit	2	190	2	175	60 ~ 80	Cut in pieces
1500	Hare	2	190	2	175	150 ~ 200	Cut in pieces
800	Pheasant	2	190	2	175	90 ~ 120	Whole
	Meat loaf	2	180	2	160	40 ~ 60	in bread pan
	FISH						
1200	Trout/Sea bream	2	190	2 (1 and 3)*	175	30 ~ 40	3-4 fishes
1500	Tuna fish/Salmon	2	190	2 (1 and 3)*	175	25 ~ 35	4-6 fillets

This chart is intended as a guide only. It may be necessary to increase or decrease the temperature to suit your individual requirements. Only experience will enable you to determine the correct setting for your personal requirements.

NOTE: Shelf positions are counted from bottom of the oven.

We recommend to pre-heat the oven for about 10 minutes before cooking.

Grilling





Grilling must be carried out with the oven door closed.

The grill pan handles must be removed from the pan during grilling. Always use oven gloves to remove and replace the grill pan handles.

Ensure that you **support** the grill pan when removing it from the oven.

How to Use the Full Grill

1. Switch the oven ON.
2. Select the Full Grill function by pressing the Oven Function control button  until the symbol  appears in the display.
3. If necessary adjust temperature setting using the “+” or “-” buttons.
4. Adjust the grid and grill pan runner position to allow for different thicknesses of food. Position the food close to the element for faster cooking and further away for more gentle cooking.

Preheat the grill on a full setting for a few minutes before sealing steaks or toasting. Adjust the heat setting and the shelf as necessary, during cooking.

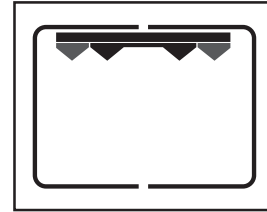

During cooking, the cooling fan and the thermostat control light will operate in the same way as described for the fan oven function.



FULL GRILL FUNCTION SYMBOL
PRE-SET TEMPERATURE: 250°C
TEMPERATURE SELECTION 50°C - 250°C

How to Use the Inner Grill Element

The inner grill provides quick direct heat to the central area of the grill pan. Use the inner grill element for cooking small quantities, it can help to save energy.

1. Switch the oven ON.
2. Select the Inner Grill Element by pressing the Oven Function control button  until the symbol  appears on the display.
3. If necessary adjust temperature setting using the “+” or “-” buttons.
4. Adjust the grid and grill pan runner position to allow for different thicknesses of food and follow the instructions for grilling.

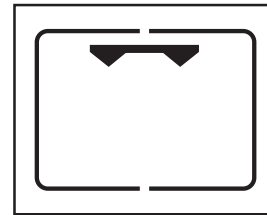

INNER GRILL ELEMENT SYMBOL
PRE-SET TEMPERATURE: 250°C
TEMPERATURE SELECTION 50°C - 250°C

Hints and Tips

- Most foods should be placed on the grid in the grill pan to allow maximum circulation of air to lift the food out of the fats and juices. Food such as fish, liver and kidneys may be placed directly on the grill pan, if preferred.
- Food should be thoroughly dried before grilling to minimise splashing. Brush lean meats and fish lightly with a little oil or melted butter to keep them moist during cooking.
- Accompaniments such as tomatoes and mushrooms may be placed underneath the grid when grilling meats. When toasting bread, we suggest that the top runner position is used. The food should be turned over during cooking, as required.

The grill element is controlled by the thermostat. During cooking, the grill cycles on and off to prevent overheating.

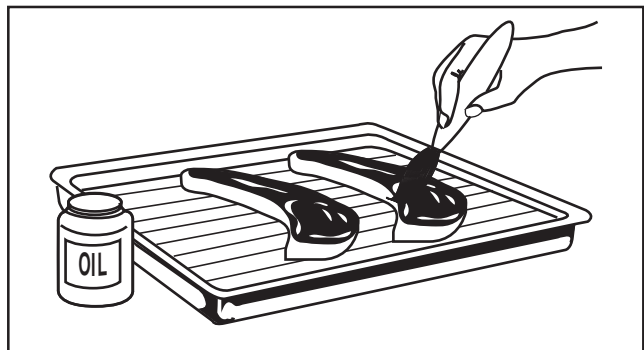



Fig. 23

How to Use the Thermal Grill

Thermal grilling offers an alternative method of cooking food items normally associated with conventional grilling. The grill element and the oven fan operate alternately, circulating hot air around the food. The need to check and turn the food is reduced. Thermal grilling helps to minimise cooking smells in the kitchen.

With the exception of toast and rare steaks, you can thermally grill all the foods you would normally cook under a conventional grill. Cooking is more gentle, therefore food generally takes a little longer to cook with thermal grilling compared with conventional grilling. One of the advantages is that larger quantities can be cooked at the same time.

1. Switch the oven ON.
2. Select the Thermal Grill Oven Function by pressing the Oven Function control button  until the symbol  appears on the display.
3. If necessary, press “+” or “-“ buttons. to adjust the temperature setting.
4. Adjust the grid and grill pan runner position to allow for different thicknesses of food and follow the instructions for grilling.

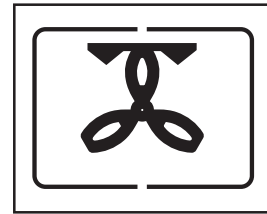

THERMAL GRILLING
PRE-SET TEMPERATURE: 180°C
TEMPERATURE SELECTION 50°C - 200°C
DO NOT EXCEED 200°C



Hints and Tips

Prepare foods in the same way as for conventional grilling. Brush lean meats and fish lightly with a little oil or butter to keep them moist during cooking.

Cooking Chart - Grilling

A general guide to cooking times is given below but these times may vary slightly depending on the thickness and quantity of food being cooked.

Grilling -

TYPE OF DISH	Quantity		Grilling		Cooking time (minutes) 	
	Pieces	Weight	Level 	temp. °C	Upper side	Lower side
Fillet steaks	4	800	3	max	12 ~ 15	12 ~ 14
Beef-steaks	4	600	3	max	10 ~ 12	6 ~ 8
Sausages	8	—	3	max	12 ~ 15	10 ~ 12
Pork chops	4	600	3	max	12 ~ 16	12 ~ 14
Chicken (cut in two)	2	1000	3	max	30 ~ 35	25 ~ 30
Kebabs	4	—	3	max	10 ~ 15	10 ~ 12
Chicken (breast)	4	400	3	max	12 ~ 15	12 ~ 14
Hamburger	6	600	3	max	10 ~ 15	8 ~ 10
Fish (fillets)	4	400	3	max	12 ~ 14	10 ~ 12
Sandwiches	4-6	—	3	max	5 ~ 7	—
Toast	4-6	—	3	max	2 ~ 4	2 ~ 3

Thermal grilling (Select a maximum temperature of 200°C)

TYPE OF DISH	Quantity (gr.)	Shelf level	Temp. °C	Time in minutes	
				lower side	upper side
Rolled joints (turkey)	1000	3	200	30 ~ 40	20 ~ 30
Chicken (cut in two)	1000	3	200	25 ~ 30	20 ~ 30
Chicken legs	—	3	200	15 ~ 20	15 ~ 18
Quail	500	3	200	25 ~ 30	20 ~ 25
Vegetable gratin	—	3	200	20 ~ 25	—
St. Jacques shells	—	3	200	15 ~ 20	—
Mackerel	—	3	200	15 ~ 20	10 ~ 15
Fish slices	800	3	200	12 ~ 15	8 ~ 10

(*) Food should be turned during cooking using these times as a guide.

The times quoted above are given as a guide and should be adjusted to suit personal taste. We recommend to pre-heat the oven for about 10 minutes before cooking.

Pizza Oven

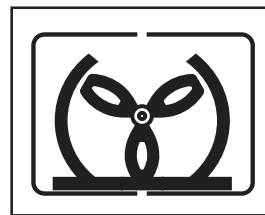

The bottom element provides direct heat to the base of pizzas, quiches or pies, while the fan ensures air is circulated to cook the pizza toppings or pie fillings. To obtain the best results use the lower shelf levels.

1. Switch the oven ON.
2. Select the Pizza Oven Function by pressing the Oven Function control button until the symbol  appears on the display.
3. If necessary, press “+” or “-” buttons to adjust the temperature setting.



PIZZA OVEN FUNCTION SYMBOL
PRE-SET TEMPERATURE: 175°C
TEMPERATURE SELECTION: 50°C - 250°C

Pizza Oven

Weight (gr.)	TYPE OF DISH	Pizza function		Cooking time  minutes	NOTES
		Level 	temp. °C		
700	Pizza, large	1	200	15 ~ 25	on baking tray
500	Pizza, small	1	200	10 ~ 20	on baking tray or on grid
500	Bread rolls	1	200	15 ~ 25	on baking tray

The times quoted above are given as a guide and should be adjusted to suit personal taste. We recommend to pre-heat the oven for about 10 minutes before cooking.

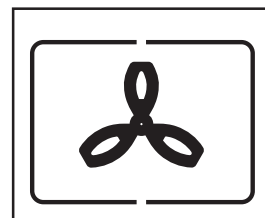

Defrosting

The oven fan operates without heat and circulates the air, at room temperature, inside the oven. This increases the speed of defrosting. However, please note that the temperature of the kitchen will influence the speed of defrosting. This function is particularly suitable for defrosting delicate food which could be damaged by heat, e.g. cream filled gateaux, iced cakes, pastries, bread and other yeast products.



DEFROSTING FUNCTION SYMBOL
TEMPERATURE SETTING CANNOT BE CHANGED

How to Use Defrosting

- 1) Switch the oven on by pressing button .
- 2) Select the Defrosting Oven Function by pressing the Oven Function control button until the symbol  appears in the display.
- 3) The display will show the indication “def”.

Hints and Tips

- Cover food with a lid, aluminium foil or plastic film to prevent drying out during defrosting.
- ALWAYS COOK THOROUGHLY IMMEDIATELY AFTER THAWING.
- Frozen food should be placed in a single layer when ever possible and turned over half way through the defrosting process.
- Only joints of meat and poultry up to 2 kg. (4 lb.) are suitable for defrosting in this way.

Cleaning the Oven



Before cleaning always allow the cooling fan to cool the oven down before switching off at the electricity supply.

This appliance cannot be cleaned with steam or with a steam cleaning machine.

The oven should be kept clean at all times. A build-up of fats or other foodstuffs could result in a fire, especially in the grill pan.

Cleaning materials

Before using any cleaning materials on your oven, check that they are suitable and that their use is recommended by the manufacturer.

Cleaners that contain bleach should NOT be used as they may dull the surface finishes. Harsh abrasives should also be avoided.

External cleaning

Regularly wipe over the control panel, oven door and door seal using a soft cloth well wrung out in warm water to which a little mild washing-up liquid has been added.



To prevent damaging or weakening the door glass panels avoid the use of the following:

- Household detergent and bleaches
- Impregnated pads unsuitable for non-stick saucepans
- Brillo/Ajax pads or steel wool pads
- Chemical oven pads or aerosols
- Rust removers
- Bath/Sink stain removers

Clean the outer and inner door glass using warm soapy water. Should the inner door glass become heavily soiled it is recommended that a cleaning product such as Hob Brite is used. Do not use paint scrapers to remove soilage.



DO NOT clean the oven door while the glass panels are warm. If this precaution is not observed the glass panel may shatter.

If the door glass panel becomes chipped or has deep scratches, the glass will be weakened and must be replaced to prevent the possibility of the panel shattering. Contact your local Service Force Centre who will be pleased to advise further.

Oven Cavity

The enamelled base of the oven cavity is best cleaned whilst the oven is still warm.

Wipe the oven over with a soft cloth soaked in warm soapy water after each use. From time to time it will be necessary to do a more thorough cleaning, using a proprietary oven cleaner.



DO NOT attempt to clean catalytic liners.

Oven Shelves and Shelf Supports

To clean the oven shelves and the shelf supports, soak in warm soapy water and remove stubborn marks with a well wetted soap impregnated pad. Rinse well and dry with a soft cloth. The shelf supports can be removed for easy cleaning (see diagrams 1 and 2).

When carrying out this operation, keep the shelf support in position with the other hand. Then, disengage the rear hook and take off the shelf support.

Please, ensure the retaining nuts are secure when refitting the shelf support.

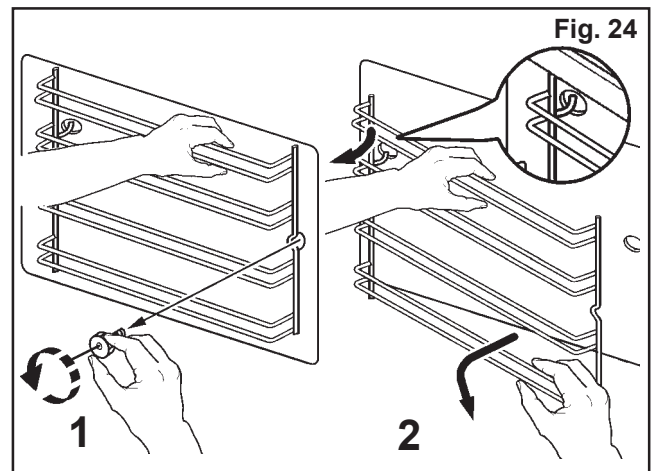

Replacing the Oven Light (Fig. 25)

If the oven bulb needs replacing, it must comply with the following specifications:

- Electric power: 15 W,
- Electric rate: 230-240 V (50 Hz),
- Resistant to temperatures of 300°C,
- Connection type: E14.

These bulbs are available from your local Service Force Centre.

To replace the faulty bulb:

1. Ensure the oven is disconnected from the electrical supply.
2. Turn the glass cover anticlockwise.
3. Remove the faulty bulb and replace with the new one.
4. Refit the glass cover.
5. Reconnect to the electrical supply.

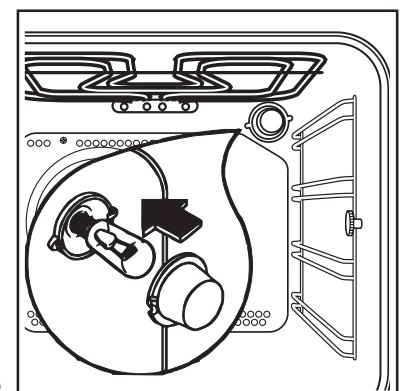

Fig. 25

Care of catalytic liners

Catalytic liners destroy splashes of food and fats when the oven temperature is raised to around 220°C.

To aid this process it is a good idea to run the oven for an hour or two per week, without food, to ensure continued good performance from the Catalytic liners.

i Hints and Tips

- Manual cleaning of the Catalytic liner is not recommended. Damage will occur if soap impregnated steel wool pads, aerosol cleaners and any other abrasives are used.
- Slight discolouration and polishing of the Catalytic surface may occur in time. This does not affect the Catalytic properties in any way.
- Follow the recommendations in “Cooking to reduce soilage”.

Cooking to reduce soilage

Cook at the recommended temperatures. Higher temperatures during roasting will increase soilage. Try cooking at lower temperatures for an increased length of time, you will save energy and often the joint is more tender.

Use minimal, if any, extra oil or fat when roasting meat; potatoes only require brushing with fat before cooking. Extra fat in the oven during roasting will increase splashing and soilage. It is NOT necessary to add water to the meat tin when roasting. The water and the fat juices from the joint create excessive splattering during cooking,

even at normal temperatures, as well as causing condensation.

Covering joints during cooking will also prevent splashing onto the interior surfaces; removing the covering for the last 20-30 minutes will allow extra browning, if required. Some large joints and turkeys especially benefit from this method of cooking, allowing the joint to cook through before the outside is overbrowned.

Do use the roasting tin. During roasting, the fat from the joint will be contained beneath the trivet and therefore prevent it from splattering onto the 'Catalytic' liner.

Cleaning the hinged grill

This model has been fitted with a hinged grill element to enable you to clean the roof of the oven easily.

! *Before proceeding ensure the oven is cool and is disconnected from the electricity supply.*

- 1) Undo the screws which hold the grill in place (see diagram 26). When carrying out this operation for the first time, we recommend using a screwdriver.
- 2) Then gently pull the grill downward to allow access to the oven roof (see diagram).
- 3) Clean the oven roof with a suitable cleaner and wipe dry before replacing the hinged grill element.
- 4) Gently push up the grill element into place and firmly screw into place the holding nuts.

! *Ensure the grill holding nuts are firmly in place to avoid the grill falling down when in use.*

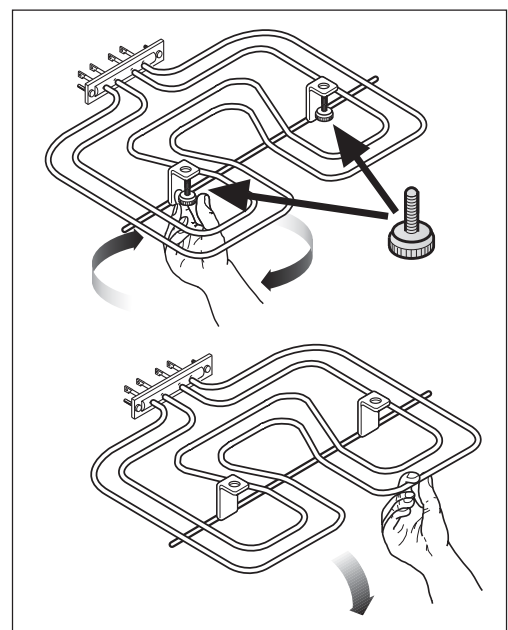

Fig. 26

Something not working

If the oven is not working correctly, please carry out the following checks, before contacting your local Zanussi Service Force Centre.

IMPORTANT: If you call out an engineer to a fault listed below, or to repair a fault caused by incorrect use or installation, a charge will be made even if the appliance is under guarantee.

SYMPTOM	SOLUTION
<ul style="list-style-type: none"> ■ The oven does not come on. 	<ul style="list-style-type: none"> ◆ Press the OVEN ON button, then select a cooking function. ◆ Check the fuse and ensure the socket switch or the switch from the mains supply to the oven are ON.
<ul style="list-style-type: none"> ■ The oven light does not come on. 	<ul style="list-style-type: none"> ◆ Switch on the oven using push button 1. ◆ Check the light bulb, and replace it if necessary (see "Replacing the Oven Light")
<ul style="list-style-type: none"> ■ It takes too long to finish the dishes, or they are cooked too fast. 	<ul style="list-style-type: none"> ◆ The temperature may need adjusting ◆ Refer to the cooking function sections and to any cooking chart provided
<ul style="list-style-type: none"> ■ Steam and condensation settle on the food and the oven cavity. 	<ul style="list-style-type: none"> ◆ Leave dishes inside the oven no longer than 15-20 minutes after the cooking is completed.
<ul style="list-style-type: none"> ■ The timer does not work. 	<ul style="list-style-type: none"> ◆ Check the instructions for the timer.
<ul style="list-style-type: none"> ■ The oven fan is noisy. 	<ul style="list-style-type: none"> ◆ Check that shelves and bakeware are not vibrating in contact with the oven back panel.
<ul style="list-style-type: none"> ■ Error code "E40" appears on the control panel. 	<ul style="list-style-type: none"> ◆ Switch the appliance off and leave it to cool down. Push button ON / OFF to switch on the appliance.
<ul style="list-style-type: none"> ■ An error code other than "E40" appears on the control panel. 	<ul style="list-style-type: none"> ◆ Take note of the error code and contact an authorised Service Centre.
<ul style="list-style-type: none"> ■ The display shows "12.00". 	<ul style="list-style-type: none"> ◆ Set the time of day (see chapter "How the set the time of day").

Service and Spare Parts

SERVICE FORCE

In the event of your appliance requiring service, or if you wish to purchase spare parts, please contact your local Zanussi Service Force Centre by telephoning:

0870 5 929929

Your telephone call will be automatically routed to the Service Force Centre covering your post code area.

For the address of your local Service Force Centre and further information about Service Force, please visit the website at www.serviceforce.co.uk

Before calling out an engineer, please ensure you have read the details under the heading "Something Not Working."

When you contact the Service Force Centre you will need to give the following details:

1. Your name, address and post code
2. Your telephone number
3. Clear and concise details of the fault
4. The model and serial number of the appliance (found on the rating plate)
5. The purchase date

Customer Care Department

For general enquiries concerning your Zanussi appliance or for further information on Zanussi products, please contact our Customer Care Department by letter or telephone at the address below or visit our website at www.zanussi.co.uk

Customer Care Department

Zanussi
55-77 High Street
Slough
Berkshire
SL1 1DZ
08705 727727 (*)

* calls to this number may be recorded for training purposes.

For Customer Service in the Republic of Ireland please contact us at the address below:

ZANUSSI
Electrolux Group (Ire) Ltd.
Long Mile Road
Dublin 12
Republic of Ireland

Tel: + 353 (0) 1 4090751
e-mail: service.eid@electrolux.ie

Guarantee conditions

Zanussi Guarantee conditions

We, Zanussi, undertake that if, within 24 months of the date of the purchase, this Zanussi appliance or any part thereof is proved to be defective by any reason only of faulty workmanship or materials, we will, at our option, repair or replace the same FREE OF ANY CHARGE for labour, materials or carriage on condition that:

- * The appliance has been correctly installed and used only on the gas and electricity supply stated on the rating plate.
- * The appliance has been used for normal domestic purpose only, and in accordance with the manufacturer's instructions.
- * The appliance has not been serviced, maintained, repaired, taken apart or tampered with by any person not authorised by us.
- * All service work under this guarantee must be undertaken by a Zanussi Service Centre.
- * Any appliance or defective part replaced shall become the Company's property.
- * This guarantee is in addition to your statutory and other legal rights.

Home visits are made between **8.30am and 5.30pm** Monday to Friday. Visits may be available outside these hours, in which case a **premium** will be charged.

Exclusions

This guarantee does not cover:

- * Damage or calls resulting from transportation, improper use or neglect, the replacement of any light bulbs or removable parts of glass or plastic.
- * Costs incurred for calls to put right an appliance which is improperly installed or calls to appliance outside the United Kingdom.
- * Appliances found to be in use within a commercial or similar environment, plus those which are the subject to rental agreements.
- * Products of Zanussi manufacture which are not marketed by Zanussi.

European Guarantee

If you should move to another country within Europe then your guarantee moves with you to your new home subject to the following qualifications:

- * The guarantee starts from the date you first purchased your product.
- * The guarantee is for the same period and to the same extent for labour and parts as exist in the new country of use for this brand or range of products.
- * This guarantee relates to you and cannot be transferred to another user.
- * Your new home is within the European Community (EC) or European Free Trade Area.
- * The product is installed and used in accordance with our instructions and is only used domestically, i.e. a normal household
- * The product is installed taking into account regulations in your new country.

Before you move, please contact your nearest Customer Care centre, listed below, to give them details of your new home. They will then ensure that the local Service Organisation is aware of your move and able to look after you and your appliances.

France	Senlis	+33 (0)3 44 62 29 99
Germany	Nürnberg	+49 (0)911 323 2600
Italy	Pordenone	+39 (0)1678 47053
Sweden	Stockholm	+46 (0)8 738 79 50
UK	Slough	+44 (0)1753 219897

Installation



The oven must be installed according to the instructions supplied.



This oven must be installed by **qualified personnel** to the relevant British Standards.

Technical Data

Dimensions of recess

Height	580 mm
Width	560 mm
Depth	550 mm

Dimensions of the oven cavity

Height	335 mm
Width	395 mm
Depth	400 mm
Oven capacity	53 litres

Heating elements rating

Oven element	1,880 W
Top element	835 W
Bottom element	1,045 W
Convection element	2,090 W
Grill element	1,795 W
Double Grill element	2,665 W
Pizza Oven Function	3,135 W
Convection Fan	30 W
Oven Light	15 W
Cooling Fan	25 W
Total Rating	3,200 W
Supply voltage (50 Hz)	230-240 V

Electrical Connection

The oven is designed to be connected to 230-240 V (50 Hz) electricity supply. The oven has an easily accessible terminal block which is marked as follows:

Letter L	-	Live terminal
Letter N	-	Neutral terminal
 or E	-	Earth terminal



THIS OVEN MUST BE EARTHED

The cable used to connect the oven to the electrical supply must comply to the specifications given below.

For Uk use only

Connection via	Min. size Cable/flex	Cable / flex type	Fuse
• Cooker Control Circuit	2.5 mm ²	PVC/PVC twin and earth	20 A

For Europe use only

Min. size Cable/flex	Cable / flex type	Fuse
2.5 mm ²	H07 RN-F, H05 RN-F, H05 RR-F, H05 VV-F, H05 V2V2-F (T90), H05 BB-F	15 A

It is necessary that you install a double pole switch between the oven and the electricity supply (mains), with a minimum gap of 3mm between the switch contacts and of a type suitable for the required load in compliance with the current rules.

The switch must not break the yellow and green earth cable at any point.

Important

After installation and connecting, the cable must be placed so that it cannot at any point reach a temperature of more than 60 °C above the ambient temperature.

Before the oven is connected, check that the main fuse and the domestic installation can support the load; and that the power supply is properly earthed.

The manufacturer disclaims any responsibility should these safety measures not be carried out.

Building In

Please ensure that when the oven is installed it is easily accessible for the engineer in the event of a breakdown.

Building In

The surround or cabinet into which the oven will be built must comply with these specifications:

- the dimensions must be as shown in the relevant diagrams;
- the materials must withstand a temperature increase of at least 60°C above ambient;
- proper arrangements must be made of a continuous supply of air to the oven to prevent the oven overheating.

Dimensions of the oven and recess required are given in the relevant diagrams.

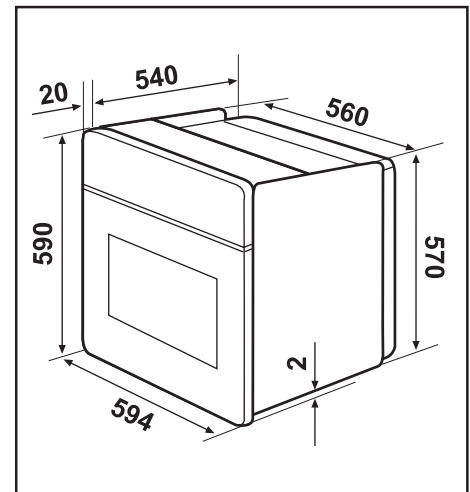

Fig. 27

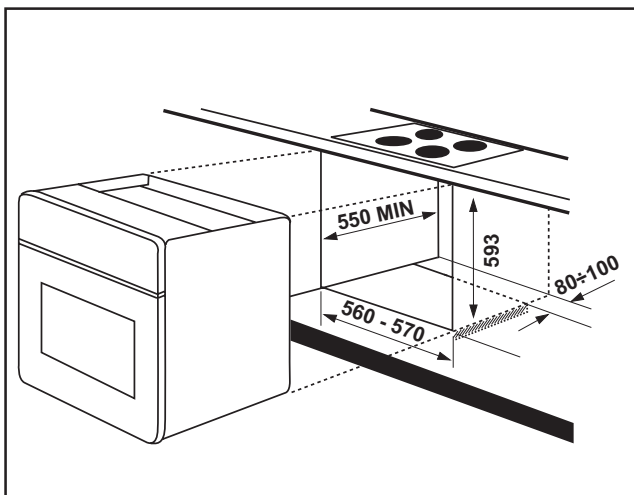

Fig. 28

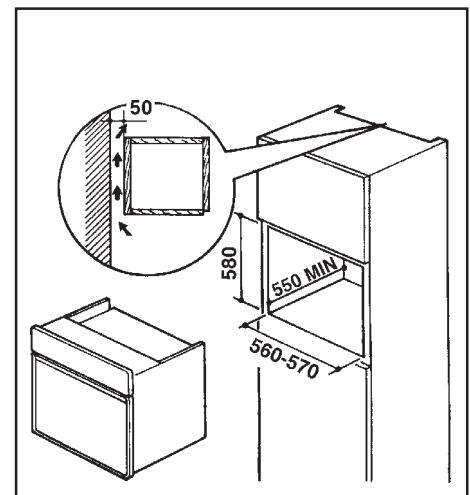

Fig. 29

Securing The Oven To The Cabinet

1. Fit the oven into the cabinet recess,
2. Open the oven door,
3. Secure the oven to the kitchen cabinet with four wood screws, which fit the holes provided in the oven frame.

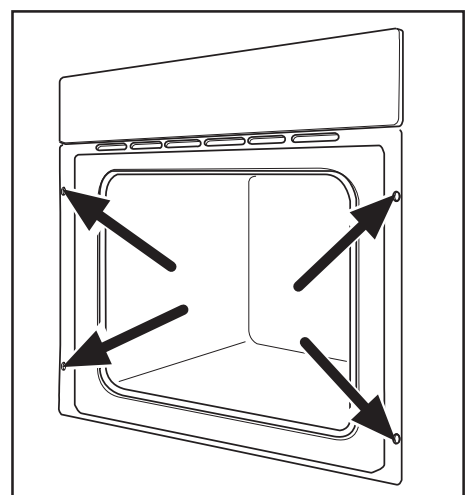

Fig. 30

-	ES	DA	DE	EL	EN	FR	IT	NL	PT	SV	FI	ZANUSSI
1	Fabricante	Mærke	Hersteller	Προμηθευτής	Manufacturer	Fabricant	Costruttore	Fabrikant	Fabricante	Leverantör	Tavarantoimittaja	ZANUSSI
2	Modelo	Model	Modell	Μοντέλο	Model	Modèle	Modello	Model	Modelo	Modell	Malli	ZOB 1060
3	Clase de eficiencia energética	Relativt energiforbrug	Energieeffizienzklasse	Τάξη ενεργειακής απόδοσης	Energy efficiency class	Classement selon énergie	Classe di efficienza energetica	Energie-efficiëntieklasse	Classe de eficiência energética	Energieeffektivitetsklass	Energiatohokkuusluokka	
4	- Calentamiento convencional	- Traditionel opvarmning	- Konventionelle Beheizung	- Συμβατική	- Conventional	- Classique	- Convezione naturale	- Conventioneel	- Conveccional	- Konventionell värmning	- Ylä-alalämpö	
5	- Convección forzada	- Varmluft	- Um/Heißluft	- Με κλιμακοφορία θερμού αέρα	- Forced air convection	- Convection forcée	- Convezione forzata	- Geforceerde luchtconvector	- Conveccão forçada de ar	- Värmning med varmluft	- Kiertoilma	
	Consumo de energía Función de calentamiento:	Energiforbrug Opvarmningsfunktion:	Energieverbrauch Beheizung:	Κατανάλωση ενέργειας Αεριοφορία θερμότητας	Energy consumption Heating function:	Consommation d'énergie Fonction chauffage:	Consumo di energia Funzione di riscaldamento:	Energieverbruik Verhittingsfunctie:	Consumo de energia Função de aquecimento:	Energiförbrukning Värmningsfunktion:	Energiankulutus Kuumentusta pa:	
6	- Calentamiento convencional	- Traditionel opvarmning	- Konventionelle Beheizung	- Συμβατική	- Conventional	- Classique	- Convezione naturale	- Conventioneel	- Conveccional	- Konventionell värmning	- Ylä-alalämpö	0,79 kWh
7	- Convección forzada	- Varmluft	- Um/Heißluft	- Με κλιμακοφορία θερμού αέρα	- Forced air convection	- Convection forcée	- Convezione forzata	- Geforceerde luchtconvector	- Conveccão forçada de ar	- Värmning med varmluft	- Kiertoilma	0,78 kWh
8	- Vapor	- Dampf	- Dampf	- Ατμός	- Steam	- Vapeur	- Vapore	- Stoom	- Vapor	- Ånga	- Höyry	
9	Volumen neto (litros)	Nettovolumen (liter)	Nettovolumen (Liter)	Ωφέλιμος όγκος (λίτρα)	Usable volume (litres)	Volume utile (litres)	Volume utile (litri)	Netto volume (liter)	Volume útil Litros	Användbar volym (liter)	Käyttötilavuus (litraa)	53,0
	••••• •••• ••• •• • •	Tipo: - Pequeño - Medio - Grande	Typ: - Lille - Mellemstort - Stort	Τύπος: - Μικρός - Μεσαίος - Μεγάλος	Size: - Small - Medium - Large	Type: - Faible volume - Volume moyen - Grand volume	Tipo: - Piccolo - Medio - Grande	Type: - Klein - Middelgroot - Groot	Tipo: - pequeno - médio - grande	Storlek: - Liten - Medelstor - Stor	Koko: - Pieni - Keskipokoinen - Suuri	
	Tiempo de cocción con carga normal:	Tilberedningstid ved standardbelastning:	Kochzeit bei Standardbelastung:	Χρόνος για ψήσιμο τυποποιημένου φορτίου:	Time to cook standard load:	Temps de cuisson en charge normale:	Tempo necessario per cottura carico normale:	Bereidings-tijd bij standaardbelasting:	Tempo de cozedura da carga-padrão:	Tillagningstid för en standardlast:	Paistoaika vakiokuormalla:	
10	- Calentamiento convencional	- Traditionel opvarmning	- Konventionelle Beheizung	- Συμβατική	- Conventional	- Classique	- Convezione naturale	- Conventioneel	- Conveccional	- Konventionell värmning	- Ylä-alalämpö	43 min.
11	- Convección forzada	- Varmluft	- Um/Heißluft	- Με κλιμακοφορία θερμού αέρα	- Forced air convection	- Convection forcée	- Convezione forzata	- Geforceerde luchtconvector	- Conveccão forçada de ar	- Värmning med varmluft	- Kiertoilma	41 min.
12	Superficie de la placa de cocción de mayor tamaño	Arealet af den største bageplade	Größe des größten Backblechs	Η μεγαλύτερη επιφάνεια ψησίματος εκραζόμενη	The area of the largest baking sheet	Aire de la surface de la plus grande plaque pour pâtisserie	Superficie del piano di cottura più grande	Oppervlakte van de grootste bakplaat	Área da superfície da maior placa de pastelaria	Ytan för den största bakplaten	Suurimman leivinpellin ala	1130 cm ²
13	Ruido [dB (A) re 1 pW]	Lydeffektniveau dB (A) (Støj)	Geräusch (dB (A) re 1 pW)	Ξόρυβος [dB (A) ανά 1 pW]	Noise (dB (A) re 1 pW)	Bruit [dB (A) re 1 pW]	Rumore [dB (A) re 1 pW]	Getuidsniveau dB (A) re 1 pW	Nível de ruído dB (A) re 1 pW	Bullelnivå dB (A)	Ääni (dB (A) re 1 pW)	
	• Más eficiente • Lower consumption • Efficient • Niedriger Verbrauch • Mais efficace • Πιο αποδοτικό • More efficient • Economie	• Bassi consumi • Efficient • Niedriger Verbrauch • Mais efficace • Πιο αποδοτικό • More efficient • Vähän kuluttava	• ABCDEFG	• Menos eficiente • Høj forbrug • Höher Verbrauch • Αποδοτικότερο • Less efficient • Peu economie	• Alii consumi • Inefficient • Menos eficiente • Hög förbrukning • Pajon kuluttava	• •••• 12 l ≤ Volumen neto/Nettovolumen/Ωφέλιμος όγκος/Usable volume/Volume utile/ Netto volume/Volume útil/Användbar volym/Käyttötilavuus < 35 l	• •••• 35 l ≤ Volumen neto/Nettovolumen/Ωφέλιμος όγκος/Usable volume/Volume utile/ Netto volume/Volume útil/Användbar volym/Käyttötilavuus < 65 l	• •••• 65 l ≤ Volumen neto/Nettovolumen/Ωφέλιμος όγκος/Usable volume/Volume utile/ Netto volume/Volume útil/Användbar volym/Käyttötilavuus	2002/40/EC			

CUSTOMER CARE

Zanussi

55-77 High Street

Slough

Berkshire, SL1 1DZ

Tel: 08705 727727

© Electrolux plc 2003

From the Electrolux Group. The world's No.1 choice.

The Electrolux Group is the world's largest producer of powered appliances for kitchen, cleaning and outdoor use. More than 55 million Electrolux Group products (such as refrigerators, cookers, washing machines, vacuum cleaners, chain saws and lawn mowers) are sold each year to a value of approx. USD 14 billion in more than 150 countries around the world.