

INSTRUCTIONS FOR THE USE AND CARE OF ZANUSSI BUILT - IN OVEN

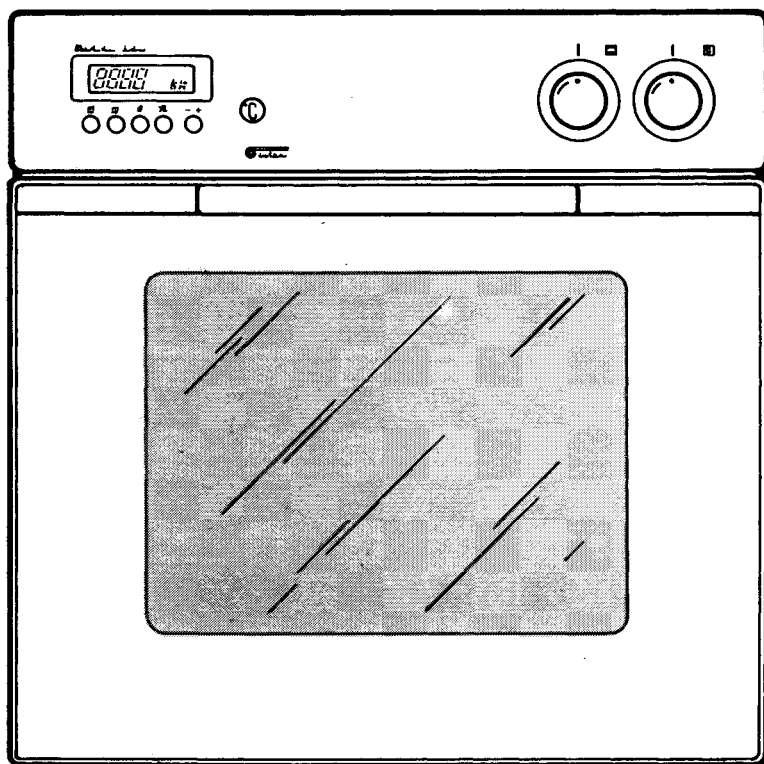

Model No. FBI 523

ZANUSSI
The appliance of science

It is most important that this instruction book should be retained with the appliance for future reference. Should the appliance be sold or transferred to another owner, or should you move house and leave the appliance, always ensure that the book is supplied with the appliance in order that the new owner can be acquainted with the functioning of the appliance and the relevant warnings.

Warnings - Built-in ovens

THESE WARNINGS ARE PROVIDED IN THE INTEREST OF SAFETY. YOU MUST READ THEM CAREFULLY BEFORE INSTALLING OR USING THE APPLIANCE.

This appliance is designed to be operated by adults. Children should not be allowed to tamper with the controls or play with the product.

Any installation work must be undertaken by a qualified electrician or competent person.

It is dangerous to alter the specifications or modify the product in any way.

This appliance should be serviced by an authorised Zanussi Network Service Centre, and only genuine Zanussi spare parts should be used.

Cookers become very hot with use, and retain their heat for a long period after use. Children should be supervised at all times and should not be allowed to touch the hot surfaces or be in the vicinity when in use or until the appliance has cooled after use.

Always ensure that the control knobs are in the «off» position when not in use.

For hygiene and safety reasons, this appliance should be kept clean at all times. A build-up of fats or foodstuffs could result in a fire.

This appliance has been designed for cooking edible foodstuffs only, and must not be used for any other purposes.

Never line any part of the oven with aluminium foil.

Easy clean liners should never be cleaned with any other than soapy water (see cleaning instructions).

Before any maintenance or cleaning work is carried out on the appliance, always turn off the isolator switch at the cooker point, and allow to cool.

Ensure that the anti-tip oven shelves are put in place in the correct way (see instructions).

Under no circumstances should you attempt to repair the appliance yourself. Repairs carried out by inexperienced persons may cause injury or more serious malfunctioning. Refer to your local Zanussi Service Centre. Always insist on genuine Zanussi spare parts.

Contents

Use and care	Page 4
Using the oven	Page 6
The meat probe	Page 12
Cleaning the oven	Page 13
What happens if something goes wrong	Page 19
Peace of mind for twelve months or five years	Page 20 Page 21

Important: The installation of the oven and connecting it to electricity must always be done by competent installers and to standards and regulations currently in force.

Use and care

When the oven is first installed

Once the oven is installed it is important to remove the protective materials which were put on in the factory.

Remove the plastic film from these parts, then wipe with a cloth dipped in methylated spirit.

Then switch the oven control to MAX and leave it to run empty for 30 minutes to burn off any other protective materials. This will also remove any unpleasant new smells.

Assembly of front parts

To assemble the front parts which come in different colour versions, follow instructions provided in the kit.

Cooling fan

The cooling fan is designed to cool the walls of the oven and the components of the oven itself.

The fan switches on automatically when the oven control knob is turned on.

Warm air is blown out through the aperture near the oven door handle.

When the oven is switched off, the fan may remain on for several more minutes in order to cool the oven and kitchen cabinets properly, after which it switches off automatically.

Technical data

Model Number: FBI 523

Recess dimensions

Height	580 mm
Width	560-570 mm
Depth	550 mm
Oven capacity	1.9 cu.ft

Internal oven dimensions

Height	32 cm
Width	42 cm
Depth	39 cm

Oven ratings 2.5 kW

Oven element
Convection fan 25 W
2.0 kW

Grill element
Double grill element 3.0 kW
3 x 15 W
Oven lamp 25 W
Cooling fan 3.070 kW
Total rating

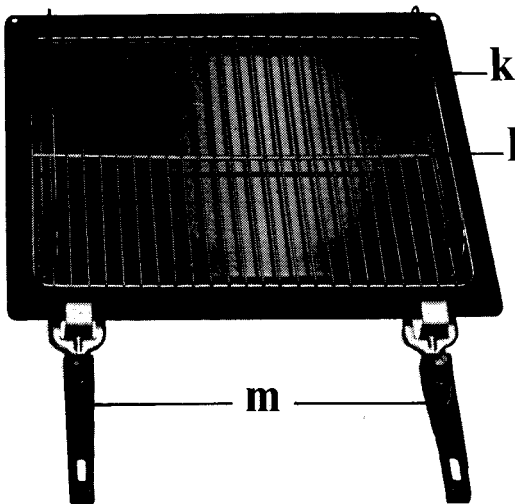
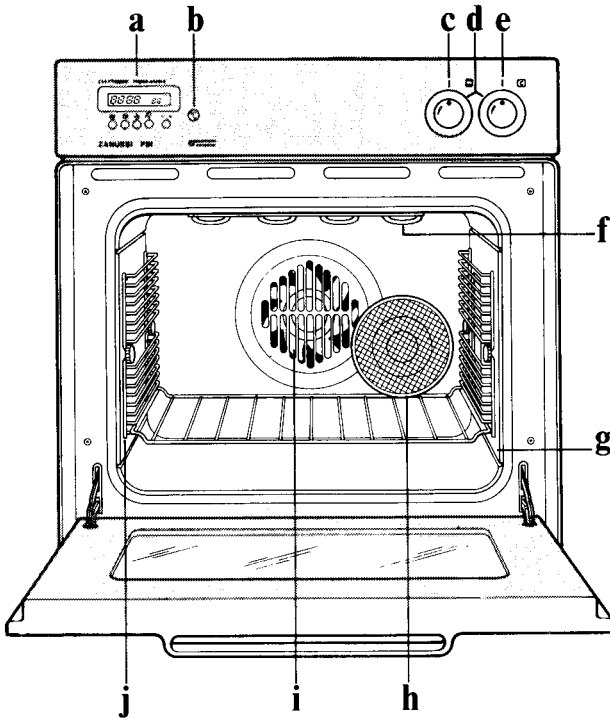

- a Electronic programmer
- b Oven temperature light
- c Oven selector knob
- d Dials
- e Thermostat control knob
- f Removable grill element
- g Removable liner panels
- h Removable grease filter
- i Fan
- j Removable shelf runners
- k Dripping pan - large
- l Removable grill pan insert
- m Removable handles (2 off)

Using the oven (Fan ducted)

This is the Cuisinair system of cooking. The heat source comes from a circular element surrounding the fan behind the back wall of the oven. The fan, which comes on automatically when the oven is turned on, distributes the warm air all around the oven so that the entire cavity is heated up evenly enabling foods to be cooked in the same time regardless of their position within the oven.

Foods of different types may be cooked together provided they require the same cooking temperature and there is a very little flavour transference. The speed of heating up is so fast that it is not necessary to pre-heat the oven.

The oven shelves can be filled to capacity. Most normal types and materials of cooking utensils can be used. During cooking the door should be opened as little as possible to avoid heat loss and so excessive electricity consumption.

The oven light comes on automatically when the oven is turned on as does the on/off pilot light.

Oven control knob (Fan ducted) (Fig. 1)

- ☼ Oven light, this will come on automatically whenever the oven is in use.
- ☑☑ Grill; the grill cannot be used at the same time as the oven. The oven door must be closed when grilling.
- ☒ Cuisinair cooking; this fan ducted system will allow you to roast or bake at the same time with very little flavour transference, and on any shelf.

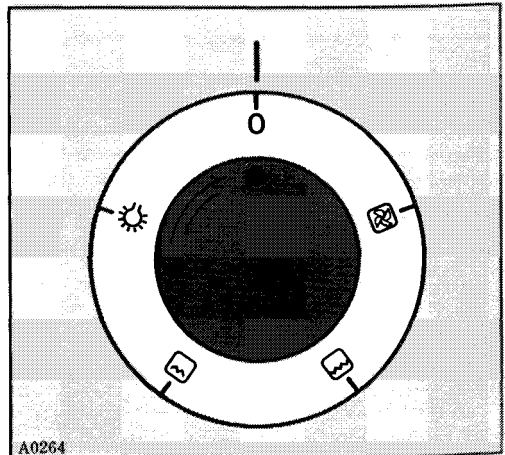

A0264

Fig. 1

Electric grill

To switch on the grill turn the oven control knob to (☐) or (☐) then turn the thermostat knob to the required temperature setting.

On this oven, the grill has two elements. The outer element is fixed and the inner element is removable. In this case turning the oven control knob to (☐) symbol operates the inner element only, when the oven control knob is turned to (☐) symbol both the inner and outer elements operate the result of the latter provides a larger grilling area.

This is known as a dual element.

To remove the inner grill element pull outwards and always remember to insert the ceramic safety plug provided into the grill socket (Fig. 2).

Foods to be grilled should be placed on the wire trivet in the grill pan. The trivet can be positioned either way up to give the required distance from the element.

Note:

The grill element should be removed when the oven is in use and the ceramic safety plug placed into the element socket; as over a period of time the element will expand if subjected to the high temperatures of the oven, and no longer slot onto the fixing screws in the roof of the oven.

Important

Your oven is fitted with hinges, giving two door positions, fully open or fully closed.

When grilling, the oven door must be closed.

Grilling with the door open could cause areas of the oven and surrounding furniture to become excessively hot as well as reducing the performance, efficiency and economy of the grill.

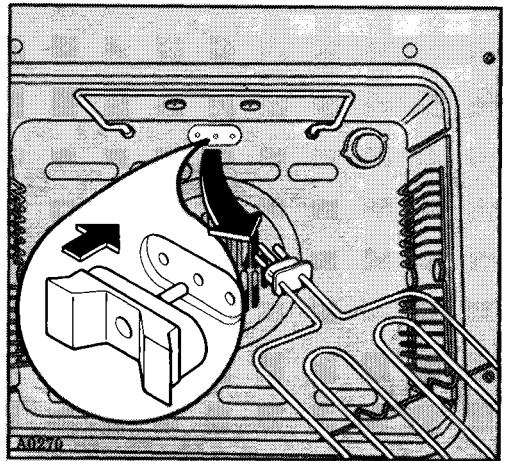

Fig. 2

Thermostat control knob (Fig. 3)

By turning the thermostat control knob clockwise you select the cooking temperature. Temperature selection starts at 50°C and is marked in 25°C increments up to maximum, where the temperature at the centre of the oven will reach approximately 280°C. The thermostat controlling the temperature is totally variable so it is possible to select temperatures between those marked. The MAX setting is particularly suitable for grilling. Once the oven temperature has been selected, the temperature light will come on and remain on until the oven has reached the correct setting; after that it will come on and off with the thermostat showing how the temperature is being maintained.

During cooking the oven door should be opened as little as possible to avoid heat loss and so excessive electricity consumption.

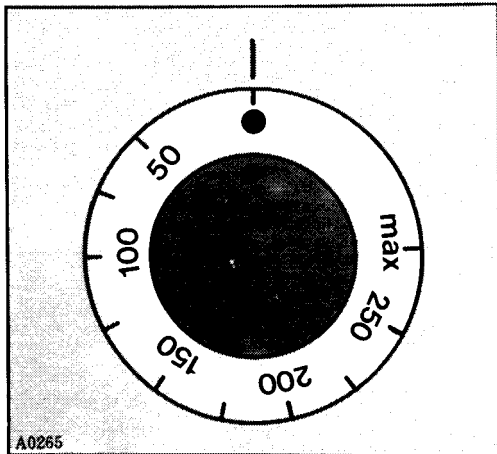

Fig. 3

Safety thermostat

Should the main oven thermostat fail, the oven is protected by a safety thermostat which will operate if the temperature within the oven reaches too high a level. Once the temperature has returned to a safe level the main oven thermostat will function.

In cases where there is a permanent failure it is necessary to contact the Zanussi Network Service Engineer.

Electronic programmer (Fig. 4)

This programmer allows you to pre-set the cooking start time and determine the duration of cooking required, as well as acting as a cooking timer and clock. It also shows the temperature measured by the food probe when cooking automatically.

Most foods cook well automatically, but preference should be given to those which will not be affected by the waiting period before the oven comes on.

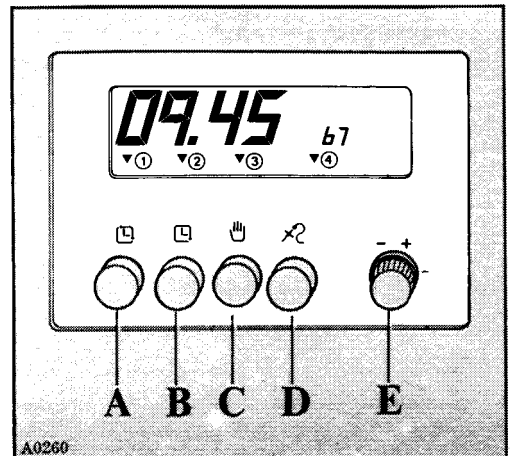







Fig. 4

Controls

Pushbutton

- | | | |
|---|----------|---|
|  | A | To enter and display the cooking duration |
|  | B | To enter and display the end of cooking time |
|  | C | Manual (non-automatic) operation |
|  | D | To enter the temperature for cooking with the probe |
-

Knob



- | | | |
|---|----------|---|
|  | E | To enter the various cooking times & temperatures (turn either clockwise or counter clockwise). |
|---|----------|---|
-

Cursor lights

The triangular cursor lights located on the digital display, light up to indicate that the selected function is being performed. The oven is always set for manual operation unless it is programmed in which case cursor light 3 comes on to indicate that the oven is functioning automatically.

Setting the clock

This 24 hour clock will need to be set/re-set when the appliance is first installed or after a power failure, the digits and cursor lights (triangle 1 & 2) of the display will flash to indicate this. To set the correct time proceed as follows:

Depress simultaneously pushbuttons A and B ( ) and keeping them depressed, turn knob E (-/+) clockwise (to go forwards in time) or anticlockwise (to go backwards in time) until the correct time of day is displayed.

Release pushbuttons A and B to start the clock running. Cursor lights 1 & 2 will go out and cursor light 3 will start flashing. To stop cursor 3 flashing, depress pushbutton C (). The oven is now set for manual operation and reading the correct time of day.

Cooking timer

The cooking timer can only be used when the oven is set for manual operation.

Important

It is possible to set the cooking timer when the oven is on BUT the oven will then operate as if a semi automatic cooking operation had been programmed ie., the oven will automatically turn off when the pre-set cooking time is over.

Therefore, if you are cooking in the oven and then wish to use the timer to time something else whilst the oven is still on, you must remember to re-programme, or turn back on, the oven.

The maximum programmable time which can be set on the minute minder is 23 hours 59 minutes. To set the cooker timer proceed as follows:

Depress button A () and keeping it depressed, turn knob E (-/+) to the required duration of time, release button A. Cursor lights 1 and 3 will now be on, this is telling you that the programmer is performing an automatic function (cursor light 3) and that you have set a duration of time (cursor light 1).

The programmer will count down from the pre-set duration of cooking time, when the time is up, cursor light 1 will go out and the alarm will sound for two minutes then stop automatically. At this point cursor light 3 will be flashing, which tells you that the oven needs to be re-set for manual operation - to do this press button C (), cursor light 3 will go out.

Semi automatic operation of the oven

This enables you to manually turn on the oven and programme the duration of cooking time so that the oven switches off automatically. The maximum duration of cooking time is 23 hours 59 minutes.

To programme this function proceed as follows:

Place the food to be cooked into the oven, then turn the oven control and thermostat control knobs to the required settings.

Depress button A () and keeping it depressed, turn knob E (-/+) to the required duration of time, release button A. Pilot lights 1 and 3 will now be on, this is telling you that the programmer is performing an automatic function (cursor light 3) and that you have set a duration of cooking time (cursor light 1).

The programmer will count down from the pre-set duration of cooking time, when the time is up, cursor light 1 will go out, the oven will automatically switch off, and the alarm will sound. The alarm sounds for two minutes, then stops automatically.

At this point, cursor light 3 will be flashing which tells you that the oven needs to be re-set for manual operation. To do this first turn the oven controls to their off positions then press button C (); cursor light 3 will go out which means the oven has now been re-set for manual operation.

NB: If you do not turn the oven controls to their off positions first, when you press button C (), the oven will return to manual operation and will remain on until you turn the controls to their off positions.

Totally automatic cooking

This function enables you to programme the oven to turn itself on and off at pre-set times without the need for you to be in attendance. Most foods cook well automatically but preference should be given to those which will not be affected by the waiting period before the oven comes on. The maximum programmable cooking duration is 23 hours 59 minutes.

When setting the programmer to carry out totally automatic cooking, you first of all set the duration of cooking, ie., how long you want the oven to be on for, then you set the finished cooking time, ie., the time by which you wish the contents of the oven to be cooked. There is no facility to set a cooking start time as the programmer automatically works out what time it needs to switch the oven on, in order to cook for the pre-set length of time and turn itself off at the programmed finished cooking time.

To programme the oven for totally automatic cooking proceed as follows:

Place the food to be cooked into the oven.



Depress button A () and keeping it depressed turn knob E (-/+) to the required duration of cooking time. Release button A, cursor lights 1 and 3 will come on.

Depress button B () and keeping it depressed turn knob E (-/+) to display the required finished cooking time. Release button B, cursor lights 1, 2 and 3 will be on.

When the cooking programme starts, cursor light 2 will go out.

At the end of the cooking programme the oven switches off automatically, and the alarm will sound for two minutes, then that too will switch off automatically. At this point cursor light 1 goes out and cursor light 3 will start to flash. When you return to the oven, return the oven control and thermostat control knobs to their off positions, and then depress knob C () to re-set the oven to manual operation.

NB: If you do not turn the oven controls to their off positions first, when you press button C () the oven will return to manual operation and will remain on until you turn the controls to their off positions.

To cancel a programme, the displays shown when either button A () or button B () are depressed, should be returned to zero by means of knob E (-/+).

The meat probe

Why?

The meat probe is a luxury feature which will control the exact cooking of meats and eliminate all elements of guesswork or need to weigh and calculate.

How?

The probe consists of a skewer like sensor probe at one end of a heat resistant cable, and a plug at the other. (This device should not be submerged in water, just wiped clean with a damp cloth). Its method of operation is as follows:

1. Remove the existing plug from the probe socket which is located in the top of the left hand side of the oven.
2. Insert the probe sensor into the centre of the joint, taking care to avoid touching bone and pockets of fat as this will give a false temperature reading.
3. Place the joint, in a suitable tin, into the oven cavity, and locate the probe connecting pin into its socket.
4. Select the finished internal meat temperature by means of the electronic programmer and according to the following chart:

Roasting Chart - Internal Temperatures

Pork	Well done	85°C
Lamb	Medium	75°C
	Well done	82°C
Beef	Rare	60°C
	Medium	70°C
	Well done	80°C
Chicken	Well done	82°C

(as poultry is a difficult shape with a great deal of bone it is difficult to register a correct finish temperature).

To do this, depress button D (⌘), and keeping it depressed select the finished internal cooking temperature by turning knob E (-/+), release button D (⌘).

Cursor light 4 will come on to show that the programme has been accepted. This cursor light and the temperature are shown in red on the display.

5. Select the cooking method by means of the oven control knob and the cooking temperature by means of the thermostat control knob.

The probe will register 30°C to start with then continue to register the internal meat temperature throughout the cooking period and convey the information to the programmer. This will give a visual read-out as cooking continues, and switch off the oven when the selected temperature has been reached. At no time it is necessary to weigh the meat, the sensor determines the cooking time. However, the cooking time is obviously influenced by the cooking temperature.

Once the selected temperature has been reached the digits in the display start to flash and the alarm will sound for two minutes.

Turn the oven and thermostat control knobs to their off positions.

Open the oven door and remove the probe from the meat, then remove the probe from the socket and replace the safety plug. When the probe is removed from the display digits and cursor light go out and the oven automatically returns to manual operation.

Cleaning the oven

Grease filter

When roasting meat, be sure to install the special grease filter to protect the fan in the rear wall of the oven from fat splashes. After roasting is completed, remove the grease filter and clean thoroughly with warm soapy water. As it is stainless steel you can safely wash it in the dishwasher.

To remove the grease filter, pull up the protruding tongue and then pull the filter outwards removing it from the rear panel (Fig. 5).

Glass door

This should be cleaned with a soft cloth soaked in warm soapy water. Do not use abrasive scourers or steel wool.

Shelves and shelves supports

To clean the chrome parts of the oven, soak in warm detergent water and remove stubborn marks with a well wetted soap impregnated pad. Rinse well and dry with a soft cloth. Do not use abrasive scourers or steel wool.

Oven cavity

The enamelled oven cavity is best cleaned whilst the oven is still warm. First remove the grill element and put the ceramic safety plug into the grill socket (Fig. 2).

It is preferable/advisable to wipe the oven over with a soft cloth soaked in warm soapy water after each use. However, from time to time it will be necessary to do a more thorough cleaning, using a proprietary oven cleaner, do not use aerosol oven cleaners, abrasive scourers or steel wool.

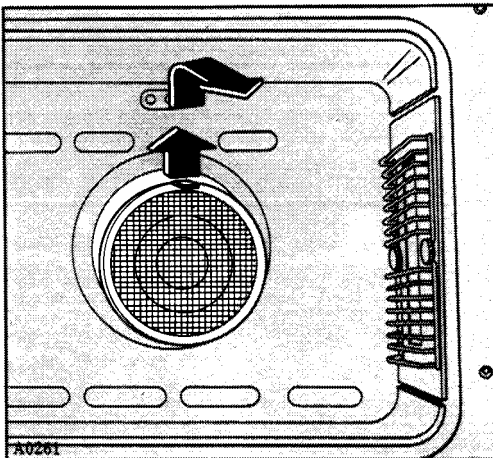

Fig. 5

Special oven linings

This oven is fitted with a set of coated liners. These are known as «stay clean» or «easy care».

To obtain the maximum efficiency from your liners follow the guide lines carefully for their use and care.

The linings are coated with a special substance which helps to clean itself by a process of oxidization. Although the linings will not remain absolutely spotless they will reduce your oven cleaning chores considerably when used in the correct way.

The linings work most effectively if the splashes are kept to a minimum, and the soil is not allowed to build up, as this will retard the cleaning action. If the oven has been used at low temperatures it is advisable to wipe the soiled linings and oven interior with a soapy cloth. The linings should be rinsed with a clean cloth and then the oven should be heated for one hour on 200 °C. Never use abrasive wools or pads or an aerosol oven cleaner on the coated linings.

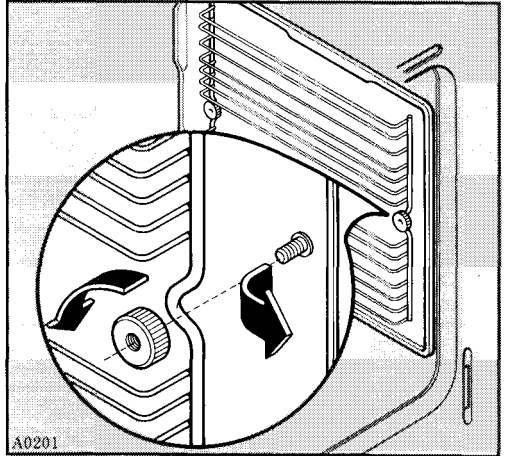
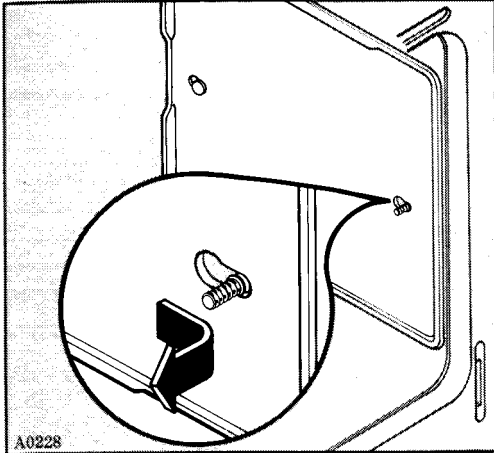

Fig. 6



A0228
Fig. 7

Removing the oven panels

The oven linings can be removed for a more thorough cleaning.

To do this:

Remove the bottom drip tray, unscrew the ring nuts securing the shelf supports (Fig. 6), remove the supports and then remove the side panels after sliding them out of their retaining pins (Fig. 7).

Warning

Before removing the back panel the oven must be disconnected and the safety plug put into the grill socket (Fig. 2).

To remove the back panel use a screwdriver (Fig. 8). This is a good opportunity to clean the back of the rear panel.

Wash the panels with very hot water and a detergent using a soft cloth.

If the shelf supports or the panels become very soiled, use a standard caustic product specially made for cleaning ovens.

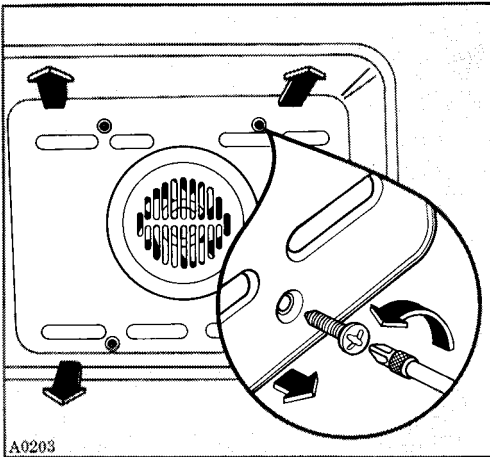

A0203
Fig. 8

Removing/replacing the oven door (Fig. 9 A/B/C)

1. Open the oven door so that it is in the horizontal position.
2. With the aid of a coin move the two retaining discs a quarter turn clockwise, so that the two raised bars are to the left of the hinges.
3. Raise the door halfway.
4. At this stage clasp the two hinges on either side of the door together simultaneously. The door can then be removed by pulling out and downwards, maintaining the angle.

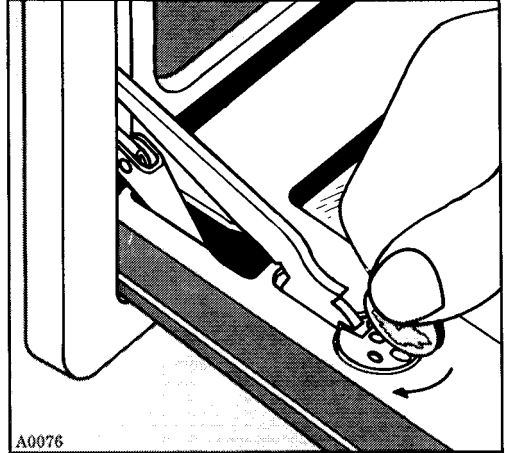

Fig. 9/A

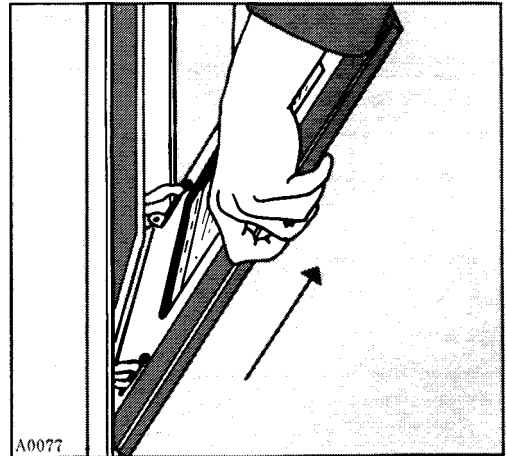
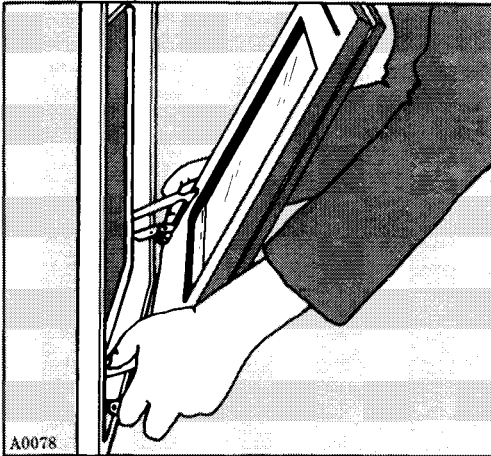
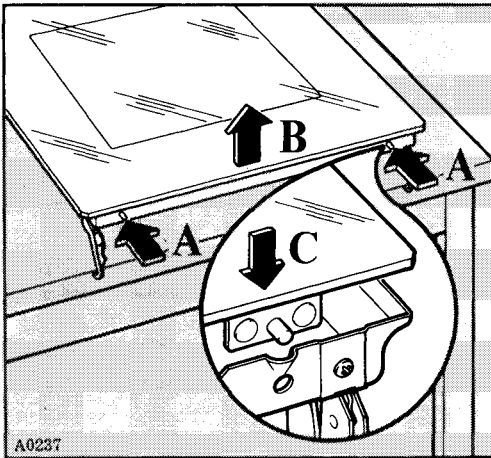

Fig. 9/B



A0078

Fig. 9/C



A0237

Fig. 10

Lay the door down on a flat horizontal surface; press thoroughly down the appropriate spring loaded catches (A - Fig. 10), lift slightly up the glass (B - Fig. 10) and remove it by pulling it forwards. After having cleaned the door reassemble the glass (C - Fig. 10) and replace the door as follows:

1. Clasp the two hinges on either side of the door together simultaneously.
2. Hook the top hinge into the top slot, so that the hook is engaged with the roller.
3. Drop the lower hinge into the lower slot, so that the notch is engaged. Drop the door down so it is in the horizontal position.

Note:

It is important when carrying out this operation that both hinges be located simultaneously.

4. Turn the retaining discs back a quarter turn so that the two raised bars are opposite the hinges.

The door can then be closed.

Removal/replacement of oven lamp (Fig. 11)

Important

Remember to disconnect the electricity supply before undertaking maintenance of any kind.

Unscrew the ring nuts securing the right side shelf supports and then remove the supports. Slide the side panel towards you and then pull away from the side of the oven cavity wall.

Using a screwdriver carefully prise the glass protection panel off as shown (Fig. 11).

Replace the faulty bulb with one that resists to high temperatures (300 °C).
Electric bulb: 3 x 15 W - 240 V (50 Hz)
300 °C E14. These are available from your local service centre.

Important

When replacing the glass protection ensure that the smooth surface is on the outside ie., facing into the oven cavity.

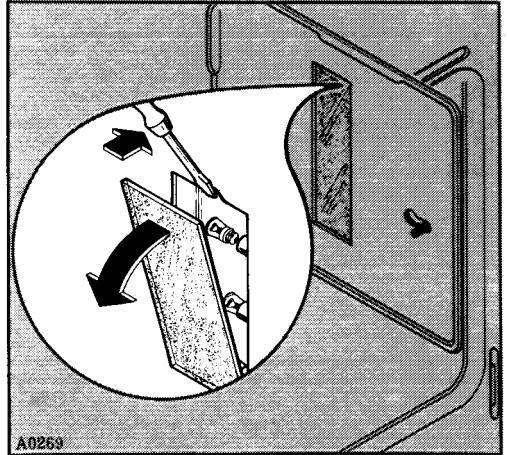

Fig. 11

What happens if something goes wrong

Power cuts

Should the electricity supply fail for any reason remember to reset the electronic clock to the right time when the power is resumed.

If the oven does not come on when cooking manually, first check that the programmer is set for manual (push-button C depressed).

If this is as it should be and the oven still does not come on:

check that it is plugged in properly;

check that the socket switch and/or the switch from the supply to the oven are ON;

replace the fuse in the plug, with another of the appropriate rating and check that this plug has been wired up properly;

check that the socket, when present, is supplying power - do this by plugging in another appliance that is known to be working properly;

check that the fuse in the fuse box is intact.

If, after all these checks, the oven still does not work, send for your local Zanussi network service centre listed in the telephone directory.

It helps to jot down the name and address and telephone number in the space below.

Peace of mind for twelve months

ZANUSSI STANDARD GUARANTEE CONDITIONS

This guarantee is in addition to your statutory and other legal rights which will not be excluded or in any way diminished by the return of this guarantee card.

We, ZANUSSI Ltd, undertake that if, within twelve months of the date of the purchase, this ZANUSSI appliance or any part thereof is proved to be defective by reason only of faulty workmanship or materials, we will, at our option, repair or replace the same **FREE OF ANY CHARGE** for labour, materials or carriage on condition that:

- The appliance has been correctly installed and used only on the electricity supply stated on the rating plate.
- The appliance has been used for normal domestic purposes only, and in accordance with the manufacturer's operating and maintenance instructions.
- The appliance has not been serviced, maintained, repaired, taken apart or tampered with by any person not authorised by us.
- The appliance is still in the possession of the original purchaser.

All service work under this guarantee must be undertaken by a Zanussi Network Service Centre.

Any appliance or defective part replaced shall become our property.

Exclusions

- Damage or calls resulting from transportation, improper use or neglect, the replacement of any light bulbs or removable parts of glass or plastic.
- Costs incurred for calls to put right machines improperly installed or calls to machines outside the UK and the Republic of Ireland.
- Appliances found to be in use within a commercial environment, plus those which are the subject of rental agreements.

or five years

ZANUSSI 5 YEAR COVER CONDITIONS

For a once-only payment you can extend your Standard Guarantee to 5 years. All the conditions and exclusions of the Standard Guarantee apply.

Notes

1. Products supplied as “seconds”, refurbished, damaged or shop-soiled are not eligible for Zanussi 5 Year Cover.

2. The issue of a cover does NOT by virtue of our having done so, nullify the exclusions.

3. The Engineer will need to check the details of your Cover card and may make a charge for his services if it is not presented to him at the time of his call.

4. The date of purchase, or the date of initial payment (deposit) of the appliance will be deemed the date of commencement of cover.

5. Covers issued are not refundable or transferable.

Guarantee Record

Appliance purchased from _____ on _____
Guarantee card no _____ Model no _____
Serial no _____ (These details may be
Your name _____ taken from your
Address _____ Guarantee Record Card

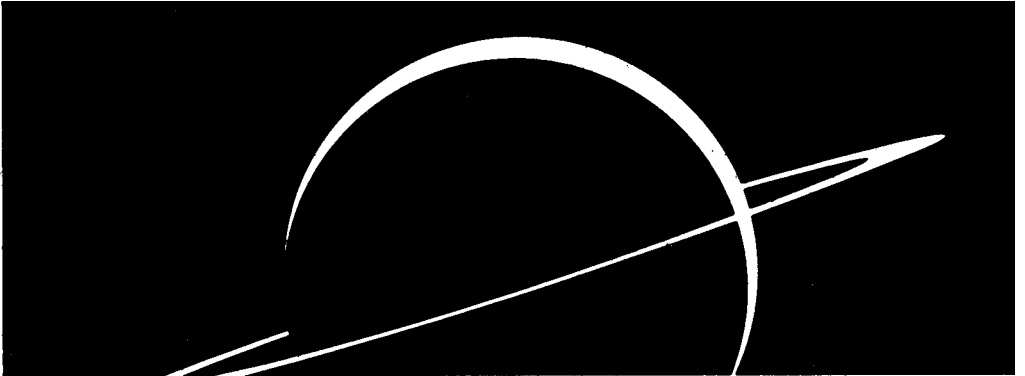

ZANUSSI

The appliance of science

Zanussi Ltd., Zanussi House, Newbury.

The information in this manual is correct at time of going to press.
Zanussi reserve the right to alter specifications without notice.