

ZANUSSI

**Instructions
for the use and care
of FB513M Cuisinair
built-in oven**

Contents

Building-in	Page 3
Connecting to electricity	Page 4
Use and care	Page 5
Using the oven	Page 7
The electronic programmer	Page 9
Using the grill	Page 11
Cleaning	Page 12
What happens if something goes wrong	Page 15

Important: The installation of the oven and connecting it to electricity must always be done by competent installers and to standards and regulations currently in force.

Building-in

It is important that the dimensions and materials of the surround or cabinet into which the oven will be built are correct and that proper arrangements are made for a supply of air to the oven so it does not overheat.

Oven dimensions - fig. 1.

Dimensions of the recess for building into a kitchen unit (mm) fig. 2.

Securing the oven to the cabinet

Fit the appliance into the cabinet recess. Open the oven door and secure the oven to the kitchen cabinet with four wood screws which fit exactly the holes provided in the oven frame (fig. 3).

Cooling fan

The cooling fan is designed to cool the walls and the components of the oven itself.

The fan switches on automatically when the oven control knob is turned on. Warm air is blown out through the aperture near the oven door handle. When the oven is switched off, the fan may remain on for several more minutes in order to cool the oven and kitchen cabinets properly, after which it switches off automatically.

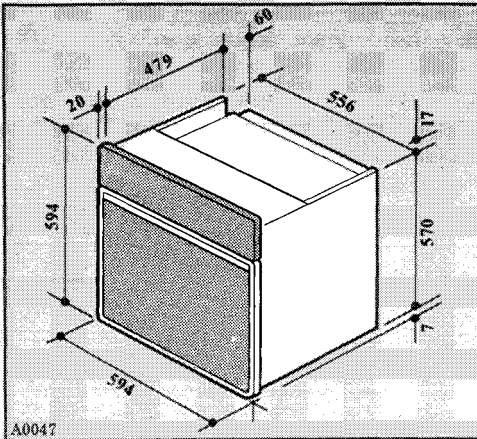

Fig. 1

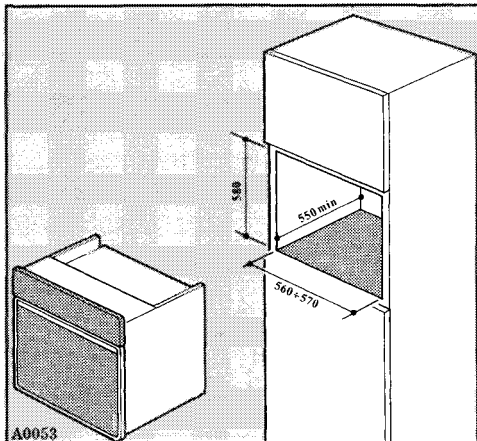

Fig. 2

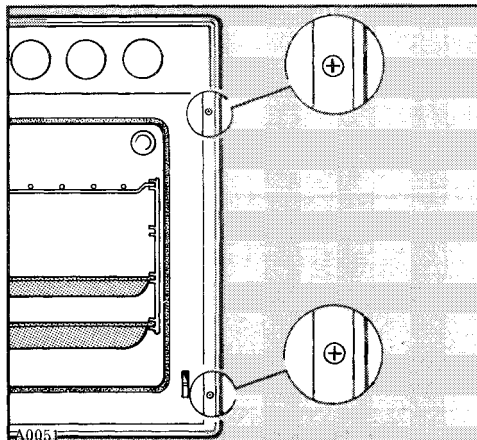

Fig. 3

Connecting to electricity

The oven is designed to be connected to 240V - 50 Hz electricity supply.

Total power absorbed	2575 W
Traditional oven element rating	2500 W
Convection oven element rating	2500 W
Grill element rating	2500 W

The oven has an easily accessible terminal block which is marked as follows:

Letter L	Live terminal
Letter N	Neutral terminal
\perp	Earth

The cable used must have a cross section of at least 1,5 mm².

For direct connection to the mains supply a double pole switch with a minimum rating of 11 A must be fitted between the supply and the appliance. This switch must not break the yellow/green earth cable at any point. For plug and socket connection the plug must have a minimum rating of 11 A.

The appliance must be earthed

Important: After installation and connecting, the cable must be placed so that it cannot at any point reach a temperature more than 50°C above the ambient temperature.

Before the appliance is connected check that:

- the main fuse and the domestic installation can support the load;
- the power supply is properly earthed;
- the double pole switch used to connect the appliance to the supply is easily accessible after installation.

The manufacturers disclaim any responsibility should these safety instructions not be carried out.

This appliance meets the requirements laid down in EEC Directive No 76/889 dated 4/11/1976 relating to the suppression of radio and TV interference.

Use and care

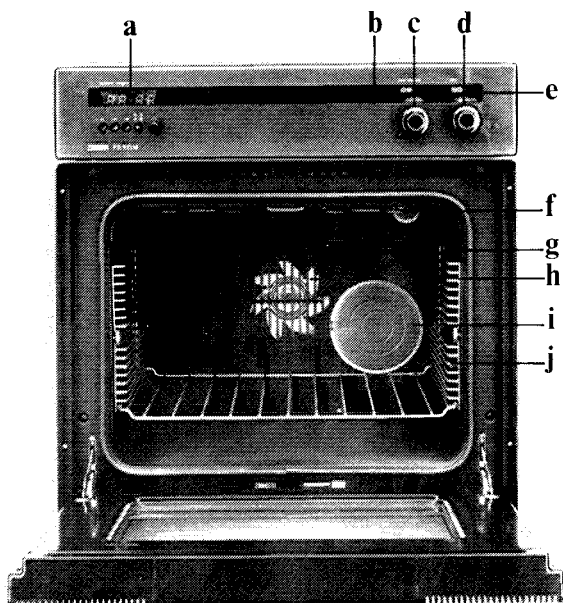

- a - Electronic programmer
- b - Oven temperature light
- c - Oven control knob
- d - Grill-Thermostat control knob
- e - Dials
- f - Removable grill element
- g - Removable oven liner panels
- h - Removable grease filter
- i - Fan
- j - Removable shelf runners

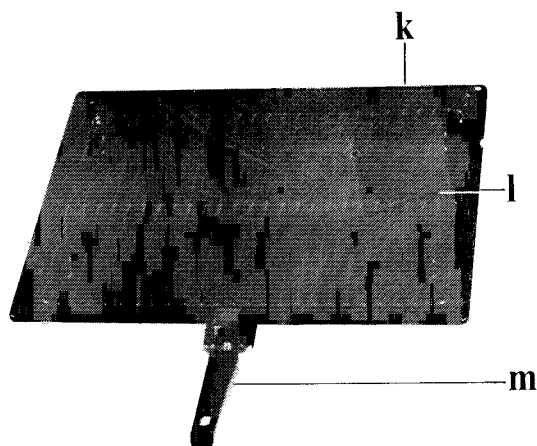

- k - Grill or roasting pan
- l - Reversible grill pan insert
- m - Removable handles (2 off).

When the oven is first installed

The internal dimensions of the oven are:

height	320 mm
width	420 mm
depth	390 mm
volume	53,0 l

Once the oven is installed it is important to remove the protective materials which were put on in the factory.

Remove the plastic from these parts, then wipe a cloth dipped in methylated spirit.

Switch the oven control to MAX and leave it to run empty for 30 minutes to burn off any other protective materials. This will also remove any unpleasant new smells.

The oven is evenly heated throughout. A fan in the back wall distributes heated air round the food during cooking so that everything cooks in the same time regardless of where it is placed in the oven or how much is being cooked.

Foods of different types, provided they require the same cooking temperature, can be cooked together and there is no possibility of any flavours or smells being transmitted from one food to another.

This is the Zanussi cuisinair system.

The oven has a removable grill.

Cooking by either oven or grill can be manual or automatic. The programmer includes a digital clock, a minute minder and controls by which the oven can be set to switch on and switch off unattended.

Indicator lights on the control panel show when the oven is switched on and the behaviour of the thermostat during cooking.

A light comes on inside the oven when it is switched on and remains on until the oven goes off.

The grill cannot be used at the same time as the oven.

The grill control provides a variety of heat settings.

Using the oven

This oven makes it possible to carry out various types of cooking, depending on the nature of the food, its firmness and volume.

All cooking must be done with the oven door closed.

The oven light remains on with all cooking settings.

We are giving hereunder a description of the various types of cooking as well as of the various functions of the oven control knob (fig. 4) and thermostat control knob (fig. 5).

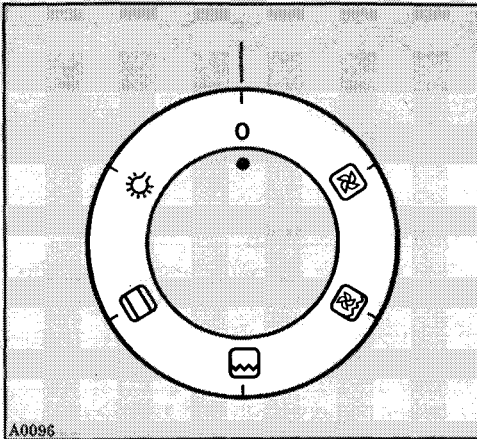

Fig. 4

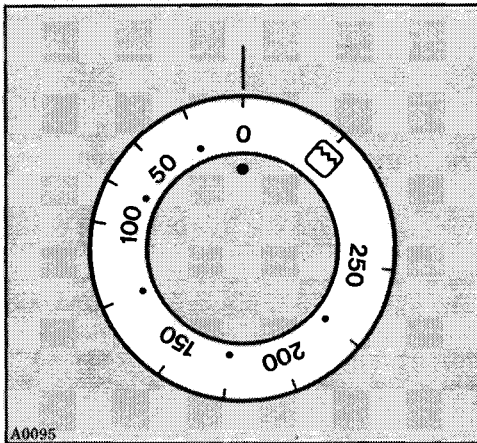







Fig. 5

Oven control knobs

The function selector knob (Fig. 4) permits selection of the most suitable type of heating for the various cooking requirements; the thermostat control knob (Fig. 5) allows you to select the required temperature level.

Function selector knob (Fig. 4)

By turning this control knob, you can select any of the following functions:

-  oven light
-  top & bottom element for traditional cooking
-  grill element
-  grill element & hot air fan operating alternately.
-  hot air convection.

Thermostat control knob (Fig. 5)

By turning the thermostat control knob clockwise, you select the cooking temperature. On position  the temperature at the centre of the oven will reach approx. 280°C. This setting is particularly suitable for grilling.

Useful hints for cooking

Oven operation for traditional cooking

For traditional cooking, utilize the oven as follows:

Turn the function selector knob to position  ;

Turn the thermostat control knob to the required temperature.

Grill operation

To grill food, use the oven as follows:

Turn the selector knob to position  ;

Turn the thermostat knob to position 

Oven operation with grill heater & hot air fan combination

This particular type of cooking is based on the utilisation of both the grill element and the hot air fan located in the rear part of the oven. The grill element and the hot air fan operate alternately; they are controlled by the thermostat depending on the selected temperature as measured at the centre of the oven.

To carry out cooking with the grill element & hot air fan combination, use the oven as follows:

Turn the selector knob to position  ;

Turn the thermostat knob to the required temperature.

Oven operation for cooking with hot air convection

With this type of cooking, heat is transferred to the food by pre-heated air. This is circulated by means of a fan located in the rear wall of the oven.



To cook food with the hot air convection system, use the oven as follows:



Turn the selector knob to position  ;

Turn the thermostat knob to the required temperature.

Cooking manually

When cooking manually ensure that the programmer is not in operation accidentally.

Check that neither the  or  display are on.

If either display is on and you do not want to use the automatic programmer return the control  to the manual position  (see section on the electronic programmer).

Place the food in the oven, close the door, turn the oven control knob (fig. 4) to the required function and then turn the thermostat control knob to the required temperature.

Positions from 50°C to 250°C are cooking positions and give a full range of temperatures.

The oven temperature light will come on until the oven has reached the correct temperature; after that it will come on and off showing how the temperature is being maintained.

Note:

By turning the oven control knob (fig. 4) to position  and the thermostat knob (fig. 5) to position 0, you can speed thawing of frozen food.

Cooking automatically

The oven or grill can cook automatically when the programmer is set to switch it on and off at the times given without the need for anyone to be in attendance.

Most foods cook well automatically but preference should be given to those which will not be affected by the waiting period before the oven comes on.

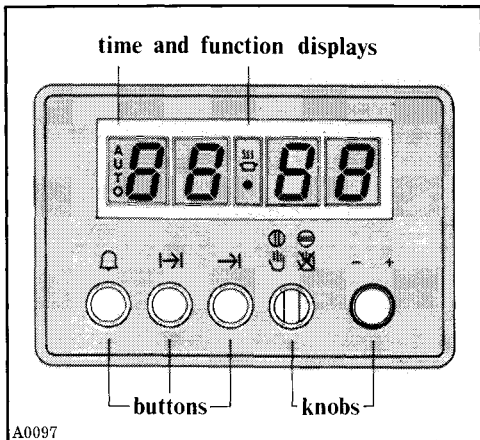

A0097



Fig. 6

The electronic programmer (fig. 6)





Fig. 6 illustrates the control buttons and knobs, and the various electronic displays of the programmer both for time and function.

The following table shows the functions fulfilled by each button and control knob, as well as the information supplied by the electronic display of the programmer.



Buttons Function

-  Setting or resetting the minute minder and to turn off the buzzer alarm.
-  Setting or resetting the duration of the cooking time.
-  Setting or resetting the time at which the cooking period will end.

Knobs Function

-  Setting or adjusting the clock.
-  The position for manual operation of the oven or grill.
-  The position for automatic operation of the oven or grill.
-  Altering the time or setting the programmer.

Function Displays

-  Indicates normal operation.
-  Indicates that the oven is programmed but not yet cooking.
-  Indicates that the oven is cooking by use of the automatic programmer.

Setting or adjusting the clock

The clock is a 24 hour clock and so will show the time in the afternoon and evening on the 24 hour basis i.e.: 12.00, 13.00, 14.00 etc.

When the oven is first connected or after resumption of power after a power failure, the digits of the clock will flash and not read the correct time.

To reset or adjust the clock follow this simple procedure:

Press simultaneously with your fingers the buttons Δ \rightarrow and, keeping them depressed, turn the control knob $+ -$ in either direction until the clock displays the correct time. Remember that it is a 24 hour clock.

By releasing the buttons Δ \rightarrow , the clock will automatically start counting.

Totally automatic cooking

Either the oven or grill can be programmed to switch on and off automatically.

The maximum programmable cooking time is 0 hours and 59 minutes.

Place the food to be cooked in the oven and proceed as follows:

Turn the control knob ☰ ☲ into the automatic position \ominus .

The ☰ display will start flashing to indicate that the programmer is ready to be set.

Push button \rightarrow and, keeping it pressed in, set the time at which the programme is to end by turning control knob $+ -$ either way so the display shows the desired time.

Remember it is a 24 hr clock.

When the desired time is displayed release button \rightarrow and the ☰ display will stop flashing but remain on continuously to indicate that the setting is made.

Now the ☲ display will flash to indicate that you must now set the duration of cooking required.

Push button \rightarrow and, keeping it pressed in, set the duration of cooking that is required by turning the control knob $+ -$ in either direction so the display shows the time required.

The maximum possible time is 9 hrs 59 mins. Then release button \rightarrow and the ☲ display will turn itself off. This indicates that the programme is set and the ☰ display remains on.



Now set the oven or grill control to the desired temperature or heat setting.

When the time is reached for the cooking to commence the ☲ display will come on and remain on during the automatic cooking programme.

As soon as the cooking is finished the oven or grill will switch off and a buzzer alarm will sound.

To turn the alarm off press button Δ .

If you do not push button Δ the alarm will continue for 3 mins and then turn itself off automatically.





When you return to the oven after completion of an automatic cooking programme return the control knob  to the manual position  and return the oven or grill control knob to the off position.



Semi-automatic cooking

It is also possible to start cooking immediately either in the oven or by grilling and programme the duration of cooking so the oven turns itself off automatically.

The maximum programmable cooking time is 9 hours and 59 minutes.

Place the food in the oven, and proceed as follows:



Turn the control knob   into the automatic position . The  display will start flashing to indicate that the programmer is ready to be set. Push button  and keeping it pressed in turn the control knob $+ -$ either way so that the display shows the time at which the cooking is to end.

Now release button  and the  display will indicate that the programme is set. Turn the oven or grill control knob to the desired temperature or heat setting and the cooking will commence.

When the end of the cooking programme is reached the oven or grill will switch off and the buzzer alarm will sound.

To turn off the alarm press button .

If you do not turn it off it will continue for 3 mins and then switch off automatically.

When you return to the oven after the completion of an automatic cooking programme, return the control knob  to the manual position  and return the oven or grill control knob to the off position.

To use the minute minder

This is a simple timer and cannot be used at the same time as the automatic or semiautomatic cooking programme. It can be set for anything up to 9 hrs 59 mins.

To set it push button  and keeping it pressed in turn control knob $+ -$ so that the display shows the required time.

When the time set expires a buzzer alarm will sound.

To turn off the alarm push button .

If you do not turn it off the alarm will continue for 3 mins. and then switch itself off automatically.

Using the grill

As with the oven the grill control (see fig. 5) can be set to a number of different heat settings.

At  the thermostat controlling the heat does not operate and the element stays on continuously to give the highest heat possible.

The grill can be operated by the electronic programmer.

Foods to be grilled are placed on the wire grid in the grill pan, which can be curved either upwards or downwards to give the required distance from the element.

Important

Because the grill element is in the top of the oven, the door must be closed during grilling.

Safety thermostat

Should the main oven thermostat fail the oven is protected by a safety thermostat which will operate if the temperature within the oven reaches too high a level. Once the temperature has returned to a safe level the main oven thermostat will function.

In cases where there is a permanent failure it is necessary to contact the Zanussi Network Service Engineer.

Cleaning

After every meat roasting clean the oven panels as soon as they have cooled so that any fat splashes are removed. After use wipe over the rest of the oven with a cloth wrung out in liquid detergent. Do not use abrasive scourers or steel wool on any stainless steel or painted surfaces.

Always wait until the oven is cool before cleaning - this is particularly important where the glass oven door is concerned. From time to time it will be necessary to do a more thorough cleaning.

When the operations described below are carried out the oven should first be unplugged or switched off from the electricity supply.

Important:

In order to keep the shining and luxurious appearance on the control panel of your appliance we recommend that it is cleaned with a soft cloth soaked in warm soapy water.

Should you accidentally spray an oven cleaner on the control panel.

This should be wiped away using a soft cloth soaked in warm water.

It is also important that a soft cloth only is used for cleaning.

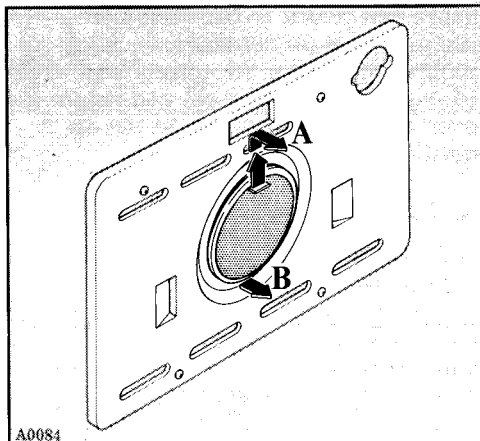

A0084

Fig. 7

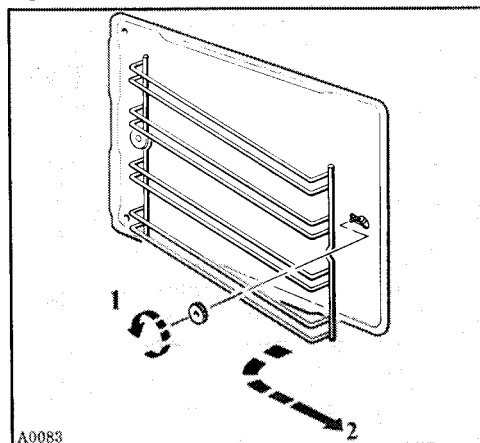

A0083

Fig. 8

Grease filter

When roasting meat, be sure to install the special grease filter (fig. 7) to protect the fan in the rear wall of the oven from fat splashes. After roasting is completed, remove the grease filter and clean it thoroughly. As it is stainless steel you can safely wash it in a dishwasher.

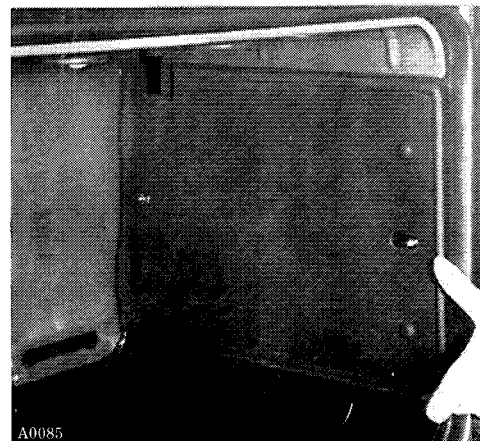

A0085

Fig. 9

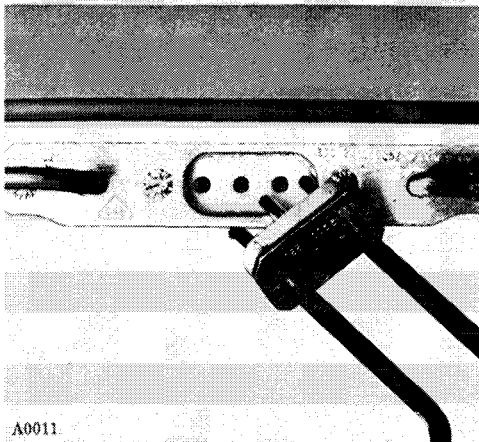

A0011

Fig. 10

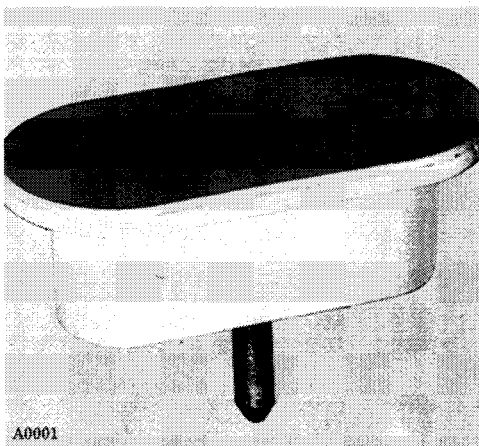

A0001

Fig. 11

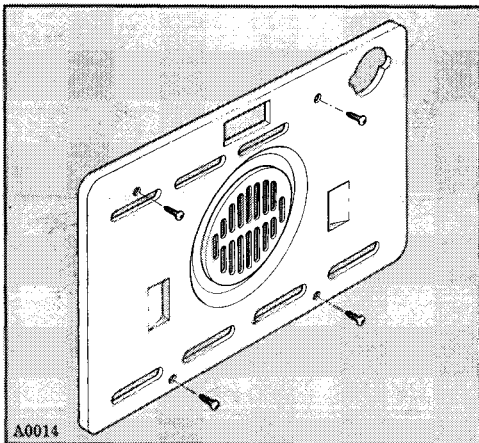

A0014

Fig. 12

Removing the grease filter (Fig. 7)

To remove the filter, proceed as follows:

filter type A: pull up the protruding tongue and then pull the filter outwards, removing it from the rear panel.

filter type B: insert a finger into the special groove of the filter, press down and then pull the filter outwards, removing it from the rear panel.

To remove and clean the oven panels

If any build-up of deposit appears on the oven lining panels they should be removed for a more thorough cleaning.

To do this:

Unscrew the ring nuts securing the side grilles (fig. 8), remove the grilles and then remove the side panels after sliding them out of their retaining pins (fig. 9) pull out the grill heater (fig. 10) and the top panel.

Warning: Before removing the back panel the oven must be disconnected and the safety plug put into the grill plug (fig. 10-11).

To remove the back panel use a screwdriver (fig. 12). This is a good opportunity to clean the back of the back panel. When using an oven aerosol never spray in the direction of the fan or against the thermostat sensor.

Cleaning the handle (Fig. 13)

To make cleaning of the oven handle easier, the built-in component can easily be removed. To do this, simply push it out from the back.

Removing the oven door

(Fig. 14 a-b-c)

To thoroughly clean the oven you should remove the door by proceeding as follows:

1. With the aid of a coin, turn the oven door stops (catches) a quarter of a turn (90°) to the right. See drawing A.
2. Raise the door to the limit stop, press it lightly against the oven and pull it out in a forward direction. See drawing B. Grasp the door on the two sides; don't pull it by the handle. See drawing C.

To re-install the door:

1. Insert the door into the oven with its two brackets.
2. Open the oven door and return the door stops (catches) to their original position.

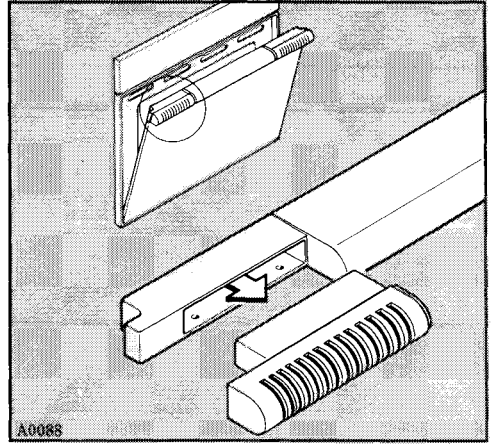

Fig. 13

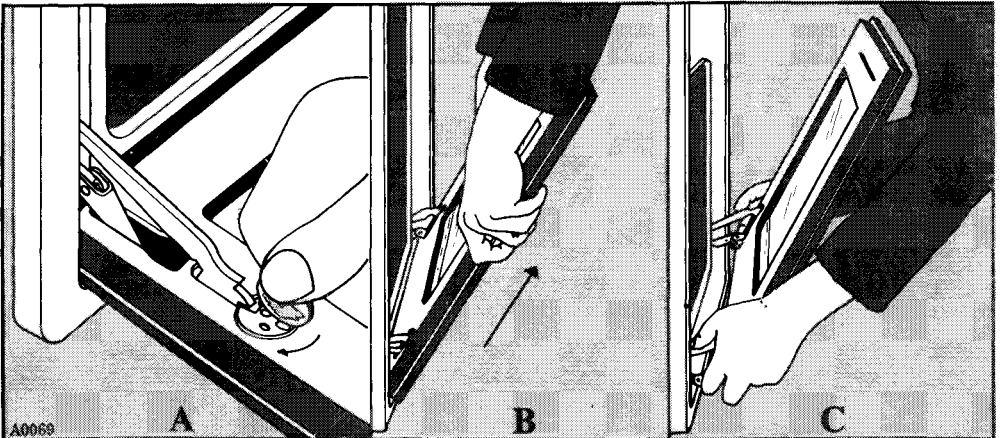





Fig. 14

What happens if something goes wrong

Power cuts

Should the electricity supply fail for any reason remember to reset the electronic clock to the right time when the power is resumed.

If the cooker does not come on when cooking manually, first check that the programmer is set for manual by the control knob   being in the  position.

If this is as it should be and the oven still does not come on:

check that it is plugged in properly;
check that the socket switch and/or the switch from the supply to the oven are ON;

replace the fuse in the plug, with another of the appropriate rating and check that this plug has been wired up properly; check that the socket, when present, is supplying power - do this by plugging in another appliance that is known to be working properly;
check that the fuse in the fuse box is intact.

If, after all these checks, the oven still does not work, send for your local Zanussi network service centre listed in the telephone directory.

It helps to jot down the name and address and telephone number in the space below.



ZANUSSI STANDARD GUARANTEE CONDITIONS

This guarantee is in addition to your statutory and other legal rights which will not be excluded or in any way diminished by the return of the guarantee card.

We, Zanussi Limited, undertake that if, within twelve months (24 months for TV sets) of the date of the purchase, this ZANUSSI appliance or any part thereof is proved to be defective by reason only of faulty workmanship or materials, we will, at our option, repair or replace the same **FREE OF ANY CHARGE** for labour, materials or carriage on condition that:

—The appliance has been correctly installed and used only on the electricity supply stated on the rating plate.

—The appliance has been used for normal domestic purposes only, and in accordance with the manufacturer's operating and maintenance instructions.

—The appliance has not been serviced, maintained, repaired, taken apart or tampered with by any person not authorised by us.

—The appliance is still in the possession of the original purchaser.

All service work under this guarantee must be undertaken by a Zanussi Network Service Centre (or the Zanussi Authorised TV Service Dealer).

Any appliance or defective part replaced shall become our property.

Exclusions

This guarantee does not cover:

—Damage or calls resulting from transportation, improper use or neglect, the replacement of any light bulbs or removable parts of glass or plastic.

—Costs incurred for calls to put right machines improperly installed or calls to machines outside the UK and the Republic of Ireland.

—Appliances found to be in use within a commercial environment, plus those which are the subject of rental agreements.

—Television receivers - routine adjustment, or poor reception resulting from a source outside of the receiver.



ZANUSSI 5 YEAR COVER CONDITIONS

For a once-only payment you can extend your Standard Guarantee to 5 years. All the conditions and exclusions of the Standard Guarantee apply.

Notes

1. Products supplied as "seconds", refurbished, damaged or shop-soiled are not eligible for Zanussi 5 year cover.
2. The issue of a cover does NOT by virtue of our having done so, nullify the exclusions.
3. The Engineer will need to check the details of your Cover card and may make a charge for his services if it is not presented to him at the time of his call.
4. The date of purchase, or the date of initial payment (deposit) of the appliance will be deemed the date of commencement of cover.
5. Covers issued are not refundable or transferable.

ZANUSSI
The appliance of science