

VULCAN

INSTALLATION & OPERATION MANUAL

GAS COMBI CONVECTION & STEAM OVENS

MODEL

<i>VCG10H</i>	<i>ML-126836</i>
<i>VCG10F</i>	<i>ML-126837</i>
<i>VCG20H</i>	<i>ML-126838</i>



For additional information on Vulcan-Hart or to locate an authorized parts and service provider in your area, visit our website at www.vulcanhart.com

IMPORTANT FOR YOUR SAFETY

THIS MANUAL HAS BEEN PREPARED FOR PERSONNEL QUALIFIED TO INSTALL GAS EQUIPMENT, WHO SHOULD PERFORM THE INITIAL FIELD START-UP AND ADJUSTMENTS OF THE EQUIPMENT COVERED BY THIS MANUAL.

POST IN A PROMINENT LOCATION THE INSTRUCTIONS TO BE FOLLOWED IN THE EVENT THE SMELL OF GAS IS DETECTED. THIS INFORMATION CAN BE OBTAINED FROM THE LOCAL GAS SUPPLIER.

IMPORTANT

IN THE EVENT A GAS ODOR IS DETECTED, SHUT DOWN UNITS AT MAIN SHUTOFF VALVE AND CONTACT THE LOCAL GAS COMPANY OR GAS SUPPLIER FOR SERVICE.

FOR YOUR SAFETY

DO NOT STORE OR USE GASOLINE OR OTHER FLAMMABLE VAPORS OR LIQUIDS IN THE VICINITY OF THIS OR ANY OTHER APPLIANCE.

WARNING: IMPROPER INSTALLATION, ADJUSTMENT, ALTERATION, SERVICE OR MAINTENANCE CAN CAUSE PROPERTY DAMAGE, INJURY OR DEATH. READ THE INSTALLATION, OPERATING AND MAINTENANCE INSTRUCTIONS THOROUGHLY BEFORE INSTALLING OR SERVICING THIS EQUIPMENT.

IN THE EVENT OF A POWER FAILURE, DO NOT ATTEMPT TO OPERATE THIS DEVICE.

TABLE OF CONTENTS

GENERAL	5
INSTALLATION.....	5
UNPACKING.....	5
LOCATION	5
LEGS, CASTERS OR STAND.....	5
DRIP TRAY.....	6
LEVELING.....	6
DOOR ADJUSTMENT	6
INSTALLATION CODES AND STANDARDS.....	6
VENT HOOD.....	6
GAS CONNECTION.....	7
TESTING THE GAS SUPPLY PIPING SYSTEM.....	7
PLUMBING CONNECTIONS.....	8
WATER REQUIREMENTS	8
WATER SUPPLY CONNECTIONS.....	8
DRAIN CONNECTION.....	8
ELECTRICAL CONNECTION	9
START-UP PROCEDURE	9
CONFIGURE CONTROLS.....	9
BEFORE FIRST USE.....	9
OPERATION	10
DOOR OPENING AND CLOSING.....	10
GREASE FILTER	10
BUZZER	10
LOADING THE OVEN	11
UNLOADING THE OVEN.....	11
PROGRAMMABLE CONTROLS	12
ON — OFF	13
COOKING MODE.....	13
COOKING TIME OR PROBE TEMPERATURE	13
OVEN TEMPERATURE OR 	13
PROGRAM NUMBER	13
PROBE	14
COOKING WITH THE PROBE	14
USING THE TEMPERATURE PROBE.....	14
TEMPERATURE PROBE APPLICATIONS	15
ENTERING A COOKING PROGRAM.....	15
PROGRAMMING MEMORY	16

RECALLING A PROGRAM FROM MEMORY	17
BAKING (CONVECTION BAKING - HOT AIR)	18
CONVECTION BAKING APPLICATIONS	19
STEAMING	20
STEAMING APPLICATIONS	21
COMBI (CONVECTION BAKING WITH STEAMING)	22
COMBI APPLICATIONS	23
EXAMPLE PROGRAM	24
MENU CARDS	25
DELUXE MANUAL CONTROL	28
ENTERING A MANUAL COOKING OPERATION — Deluxe Control	29
STANDARD MANUAL CONTROL	30
ENTERING A MANUAL COOKING OPERATION — Standard Control	31
CLEANING	32
DAILY CLEANING	32
COMPLETE CLEANING	32
CONFIGURATION MODE — PROGRAMMABLE CONTROL	34
CONFIGURATION MODE — MANUAL CONTROL (Standard or Deluxe)	36
MAINTENANCE	38
CLEAN CYCLE DELIMING PROCEDURE	38
TROUBLESHOOTING	39
SERVICE ADJUSTMENTS	40
SERVICE AND PARTS INFORMATION	40

Installation, Operation and Care of GAS COMBI CONVECTION & STEAM OVENS

KEEP THIS MANUAL FOR FUTURE USE

GENERAL

The **Vulcan Combi Gas** Convection & Steam Ovens are single compartment ovens that provide convection heating, steaming or both. Ovens are sized to accommodate **10** or **20** shelves, **Full** or **Half** depth. The **bold** numbers and letters explain the model number conventions. An atmospheric steam generator is provided for humidification in the oven chamber. Programmable or analog controls are preference options on all size and depth combinations.

The 10 level models can be installed on an optional stand or on a suitable countertop using the legs provided. The 20 level oven can be equipped with legs or casters (optional). Accessory trolleys or landing tables (depending on size of oven) can load or unload all racks in one easy motion. The hose spray accessory can be installed near the oven to facilitate easy cleaning. Stacking kits are available with either legs or casters to stack one 10 level oven on top of another: 10 Half over 10 Full, 10 Full over 10 Full or 10 Half over 10 Half.

INSTALLATION

UNPACKING

Immediately after unpacking the oven, check for possible shipping damage. If the oven is found to be damaged, save the packaging material and contact the carrier within 15 days of delivery.

Prior to installation, verify that the electrical service and type of gas (natural or propane) agree with the specifications on the oven data plate.

LOCATION

Allow space for operating the oven. Do not obstruct the ventilation ports above the oven. Do not install the oven next to a major heat source, such as a griddle or fryer. All models require a minimum clearance of 8" on the right side of the oven and 6" at the rear. Model VCG10F requires an 8" clearance on the left side.

LEGS, CASTERS or STAND

The 10 level gas ovens can be equipped with a leg- or caster-equipped stand. The 20 level gas ovens can be equipped with legs or casters. Assemble legs or casters into the holes provided at the bottom four corners of the oven as necessary. To assemble the oven onto the stand, insert four bolts from underneath at the four corners and tighten until secure.

DRIP TRAY

Verify that the drip tray is assembled to the bottom of the oven. If it is not, loosen screws under front of oven base and assemble drip tray to bottom of oven. The 20 level ovens have a drip tray that has three segments.

LEVELING

Caster equipped ovens must be placed on a level floor. For ovens with legs, use a spirit level or pan of water in the bottom of the oven to make sure the oven is level, both front-to-back and side-to-side. Adjust the leveling feet on the bottom of the legs by turning the feet in or out to level the oven. After the drain is connected, check for level by pouring water onto the floor of the compartment. All water should drain through the drain opening.

DOOR ADJUSTMENT

One door roller is located in the middle of the door on 10 level ovens; two rollers, one at the top and the other at the bottom, are located on the door of the 20 level oven. The rollers can be adjusted by loosening the screws above and below the roller. Adjust the roller to the best vertical position and tighten the screws.

INSTALLATION CODES AND STANDARDS

In the United States, install the oven in accordance with: 1) State and local codes; 2) National Fuel Gas Code, ANSI-Z223.1, latest edition, available from American Gas Association, 1515 Wilson Boulevard, Arlington, VA 22209; 3) National Electrical Code, ANSI/NFPA No. 70, latest edition; and 4) NFPA Standard #96, *Vapor Removal from Cooking Equipment*, latest edition, available from the National Fire Protection Association, Batterymarch Park, Quincy, MA 02269.

In Canada, install the oven in accordance with: 1) Local codes; 2) CAN/CGA-B149.1, Installation for Natural Gas Burning Appliances and Equipment, latest edition; 3) CAN/CGA-B149.2, Installation for Propane Burning Appliances and Equipment, latest edition; and, 4) Canadian Electrical Code, Part 1, CSA Standard C22.1, latest edition.

VENT HOOD

The Combi oven should be located under a suitable exhaust hood to vent steam, smoke, grease laden vapors, etc. Information on the construction and installation of ventilating hoods may be obtained from *Vapor Removal from Cooking Equipment*, NFPA standard No. 96 (latest edition).

GAS INPUT

Model	Gas Type	Burner Input Rating			Gas Pressure	
		Oven	Steam Generator	Total	Convection	Steam
VCG10H	Natural	67,000 BTU/Hr	40,000 BTU/Hr	107,000 BTU/Hr	3.5" W.C.	3.5" W.C.
	Propane	69,000 BTU/Hr	40,000 BTU/Hr	109,000 BTU/Hr	10.0" W.C.	10.0" W.C.
VCG10F	Natural	85,000 BTU/Hr	45,000 BTU/Hr	130,000 BTU/Hr	3.5" W.C.	3.5" W.C.
	Propane	85,000 BTU/Hr	45,000 BTU/Hr	130,000 BTU/Hr	10.0" W.C.	10.0" W.C.
VCG20H	Natural	70,000 BTU/Hr	58,000 BTU/Hr	128,000 BTU/Hr	3.5" W.C.	3.5" W.C.
	Propane	70,000 BTU/Hr	58,000 BTU/Hr	128,000 BTU/Hr	8.0" W.C.	10.0" W.C.

GAS CONNECTION

All gas supply connections and any pipe joint compound must be resistant to the action of propane gases. The machine connection is $\frac{3}{4}$ " external thread. A manual valve (supplied) must be installed in the gas supply line ahead of the appliance. Make sure piping is clean and free of obstructions, dirt or pipe joint compound. Recommended gas supply pressures are 7" W.C. (Water Column) for natural gas and 11" W.C. for propane. The gas line must be capable of delivering gas to the oven without excessive pressure drop at the rate specified on the rating plate.

The oven is equipped with a factory preset pressure regulator. Natural gas pressure regulators are preset for 3.5" W.C. for both ovens and steam generators. Propane gas pressure regulators for 10 level ovens are preset for 10" W.C. for both the oven and steam generator. Propane gas pressure regulators for 20 level half depth ovens are preset for 8" W.C. for the oven burner and 10" W.C. for the steam generator. Gas pressure must be checked for correct operating pressure at start-up.

Caster equipped ovens must be installed with a connector that complies with the *Standard for Connectors for Movable Gas Appliances*, ANSI-Z21.69 (latest edition) [in Canada, CAN/CGA-6.16, latest edition] and a quick-disconnect device that complies with the *Standard for Quick-Disconnect Devices for Use with Gas Fuel*, ANSI-Z21.41 (latest edition) [in Canada, CAN 1-6.9, latest edition]. A gas line strain relief must be provided to limit the movement of the oven without depending on the connector and the quick-disconnect device or its associated piping to limit oven movement. Attach the strain relief to the rear of the oven at the location provided. If it is necessary to disconnect the restraint during service or maintenance, first turn off the gas supply. Reconnect the restraint before returning the oven to its original installed location and turning the gas supply on.

WARNING: PRIOR TO LIGHTING, CHECK ALL JOINTS IN THE GAS SUPPLY LINE FOR LEAKS. USE SOAP AND WATER SOLUTION. DO NOT USE AN OPEN FLAME.

The convection burner and the steam generator burner are ignited automatically by electric igniters; there are no pilot lights. See Start-Up Procedure, page 9.

Keep the appliance area free and clear from all combustible substances. Do not obstruct the flow of combustion and ventilation air. Make sure there is an adequate supply of air in the room to allow for combustion at the burners and exhaust by the vent hood system.

Testing the Gas Supply Piping System

When test pressures exceed $\frac{1}{2}$ psig (3.45 kPa), the oven and its individual shutoff valve must be disconnected from the gas supply piping system.

When test pressures are $\frac{1}{2}$ psig (3.45 kPa) or less, the oven must be isolated from the gas supply piping system by closing its individual shutoff valve.

PLUMBING CONNECTIONS

WARNING: PLUMBING CONNECTIONS MUST COMPLY WITH APPLICABLE SANITARY, SAFETY AND PLUMBING CODES.

WATER REQUIREMENTS

Water Requirements

Proper water quality can improve the taste of the food prepared in the steamer, reduce liming in the steam generator and extend equipment life. Local water conditions vary from one location to another. Ask your municipal water supplier for details about your local water supply prior to installation.

Supply Pressure	20 — 60 psig
Hardness*	less than 3 grains
Silica	less than 13 ppm
Total Chlorine	less than 4.0 ppm
pH range	7 — 8
Undissolved Solids	less than 5 microns
* 17.1 ppm = 1 grain of hardness	

Presence of sediment, silica, excess chlorides or other dissolved solids may lead to a recommendation for alternate form(s) of water treatment. Test the water with the test strip included with the combi oven. Other factors affecting steam generation are iron content, amount of chloridation and dissolved gases. A local water treatment specialist should be consulted before installation of steam generating equipment.

Water Supply Connections (Fig. 2)

A water filter system is recommended for the water supply line going to the treated water inlet of your oven. Follow the recommendations for use and installation instructions shipped with the water filter. If a water filter is not installed, the oven warranty may be limited.

Connect treated potable water (must be cold) to the inlet labeled for treated water to supply the steam generator tank. Untreated water contains scale producing minerals which, if supplied to the steam generator, can precipitate onto the surfaces in the steam generator tank. Due to the temperatures in the tank, the minerals can bake onto the surfaces and components. This can result in early component failure and reduced product life. Sensors in the steam generator tank use ions in the water to detect the water level. Do not use distilled (fully demineralized or de-ionized) water as this could provide a false reading to the sensors. Strainers and filters will NOT remove minerals from the water.

Connect untreated potable water (must be cold) to the inlet labeled for untreated water to supply the condenser which cools the drain water.

Both external-threaded nylon inlets $\frac{3}{4}$ " hose bibb ($\frac{3}{4}$ " NSHT, National Straight Hose Thread) are located at the rear of the oven. The nylon threads should be treated carefully so the connections do not leak. A manual shutoff valve should be provided, convenient to the oven, for each water supply line; both of these valves should be open when the oven is in operation. Water pressure for both incoming water lines should be between 20 and 60 psig.

Refer also to CLEAN CYCLE DELIMING PROCEDURE, page 38.

Drain Connection

CAUTION: In order to avoid any back pressure in the oven, do not connect solidly to any drain connection.

The drain connection, $1\frac{1}{2}$ " NPT threaded fitting, is located underneath the oven at the rear. The drain line must be plumbed to an open gap-type drain. Drain piping must have suitable pitch, have appropriate support along its length and have no connection to other piping. The material used in the drain line should be heat resistant to at least 212°F. The open drain should be located between 3 and 5 feet away from the perimeter of the oven to reduce potential damage from moisture-corrosion. The drain line from the oven must not be combined with any drain line from another device.

Water Supply Inlets . . .
at Bottom Rear Corner of Oven
. . . Model VCG10H Shown.

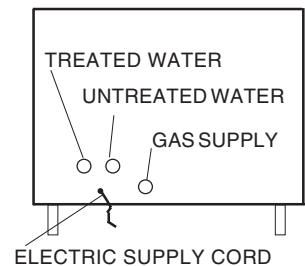

Fig. 2

ELECTRICAL CONNECTION — Cord Connected Ovens

WARNING: ELECTRICAL AND GROUNDING CONNECTIONS MUST COMPLY WITH THE APPLICABLE PORTIONS OF THE NATIONAL ELECTRICAL CODE AND/OR OTHER LOCAL ELECTRICAL CODES.

WARNING: THE SUPPLY CORD ON THIS OVEN IS PROVIDED WITH A GROUNDING PLUG. THE OUTLET TO WHICH THIS PLUG IS CONNECTED MUST BE PROPERLY GROUNDED. IF THE RECEPTACLE IS NOT THE PROPER GROUNDING TYPE, CONTACT AN ELECTRICIAN.



The wiring diagram is located on the inside surface of the right side panel as you face the oven.

START-UP PROCEDURE



The Gas Combi Ovens are equipped with a gas burner for convection heating and a gas steam generator for atmospheric steaming; two independent flues exhaust the burnt gases. Become familiar with the entire manual before continuing with this Start-Up Procedure. Remove the tray rack, grease filter and fan baffle from the oven cavity. Turn gas and water on. Press the ON button.

- Select Combi Mode and adjust the steam time to 50% by pressing four times (four indicator lights are lit).
- Leave oven temp setting at 302°F and the timer display blank, [-]h [-:]min.
- Close the oven door and press the Start Button. The oven convection fan rotates counterclockwise. The oven flue vent should be open.
- After a delay of 50 seconds while the oven adjusts for Combi Mode, the sparker on the left side of the burner should ignite the Convection Burner. Observe blue flame. On some units, the Convection Burner ignites for an instant, goes off and then comes back on (while the flame sensor is tested). On other units without the double ignition sequence, the Convection Burner may ignite and stay on. After an additional 70 seconds, the steam generator flame should ignite. Observe blue flame through window below controls.

If the Convection Burner does not ignite, the NO Convection Burner indicator light, , will be lit.

- Wait 30 seconds until the  light starts to flash and the buzzer sounds.
- Reset the Convection Burner by pressing the Reset Button above the  indicator light.
- This procedure may need to be repeated several times until all of the air in the pipeline is replaced by gas. The longer the pipe, the longer it will take to remove the air from the pipe.

If the Steam Generator Burner does not ignite, the NO Steam Burner indicator light, , will be lit.

- Wait 10 seconds until the  light starts to flash and the buzzer sounds.
- Reset the Steam Generator Burner by pressing the Reset Button above the  indicator light.
- This procedure may need to be repeated several times until all of the air in the pipeline is replaced by gas.

If a make-up air system is part of the vent hood, make sure there is no down-draft pushing hot combustion gases from the flues back into the oven.

Press OFF and observe that the pump drains the steam generator for about one minute. The door will open. After the oven is cool, reinstall fan baffle, grease filter and tray rack.

CONFIGURE CONTROLS

Depending on which control is furnished, perform CONFIGURATION MODE — PROGRAMMABLE CONTROL on pages 34 – 35 or CONFIGURATION MODE — MANUAL CONTROL on pages 36 – 37.

BEFORE FIRST USE

Before using the oven for the first time, it must be "burned in" to release any odors that might result from heating the new surfaces in the oven. Operate the oven at 480°F for 45 minutes in Convection Hot AIR Mode.

OPERATION

WARNING: THE OVEN AND ITS PARTS ARE HOT. USE CARE WHEN OPERATING, CLEANING OR SERVICING THE OVEN. THE COOKING COMPARTMENT CONTAINS LIVE STEAM. STAY CLEAR WHEN OPENING DOOR.

DOOR OPENING AND CLOSING

The oven door is equipped with an electrically powered lock. The oven is delivered with the door latched and slightly open (Fig. 3) and can be opened by firmly pulling the door handle (Fig. 5). Push the door until it connects with the latch but remains slightly open (Fig. 3). This is the position the door should be in when the oven is not in use. The door should also be in this position after cooking to allow steam to escape before fully opening the door. Push the handle until it is in line with the oven door. If power has been connected, the door will now lock automatically, sealing the oven chamber (Fig. 4).

To release the door, rotate (pull) the handle 90 degrees. The door automatically releases to the "latched and slightly open" position. Allow a few seconds for steam to escape before pulling the door open (Fig. 5).

NOTE: On Programmable Controls if the ON button is pushed after the oven is turned on, the door will be latched but slightly open (Fig. 3) for three seconds; the handle can be released by rotating 90 degrees as shown in Fig. 5. If the handle is not released within the three second interval, the door will automatically re-close. A separate Door Open button will perform the same function with Manual Standard or Deluxe Controls. On stacked ovens, the lower oven's handle does not rotate. To open, press the ON button. When the door opens (Fig. 3), pull the metal handle located on the top of the door to fully open the oven door.



Fig. 3

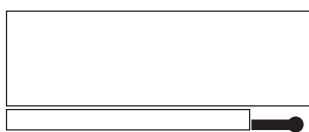

Fig. 4

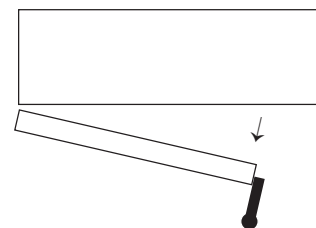



Fig. 5

NOTE: In the event of a power failure, the door may be opened by pulling the handle firmly towards you while firmly pressing against the front of the oven with the other hand (avoid hot air contact).

GREASE FILTER

The grease filter in the rear of the oven chamber should be in place when roasting meat items but may be removed before baking items that do not produce grease-laden vapors. For information on how to remove the grease filter, refer to Cleaning (page 32).

BUZZER

When either the Cooking Time has elapsed or the final internal Probe Temperature has been reached, the buzzer will sound until  is pressed. If done, the product should be removed, portioned and served. The Buzzer can be adjusted two ways: Buzzer loudness can be adjusted by your service technician. Buzzer frequency can be set in Configuration Mode for the type of control furnished with your oven (refer to either page 34 or 36).

LOADING THE OVEN

Open the door. Place the product to be cooked in suitable containers and slide into the racks or place the containers securely on shelves in the oven.

When loading a 10 level oven with the landing table (Fig. 6), the bottom frame of the rack should be secured by the rotary lock. Move the loaded landing table to the front of the open oven; secure the landing table to the oven by actuating the locking clamp (or use your body to hold the landing table against the oven). Rotate the lock-knob to release the pan rack and carefully roll the loaded pan rack into the oven while making sure that the landing table does not separate from the oven during the transfer.

NOTE: When the landing table is not in use on the 10 level oven, make sure the rack retainer (delivered with the oven) is fitted under the fan baffle to prevent the pan rack from tilting when pans are being removed.

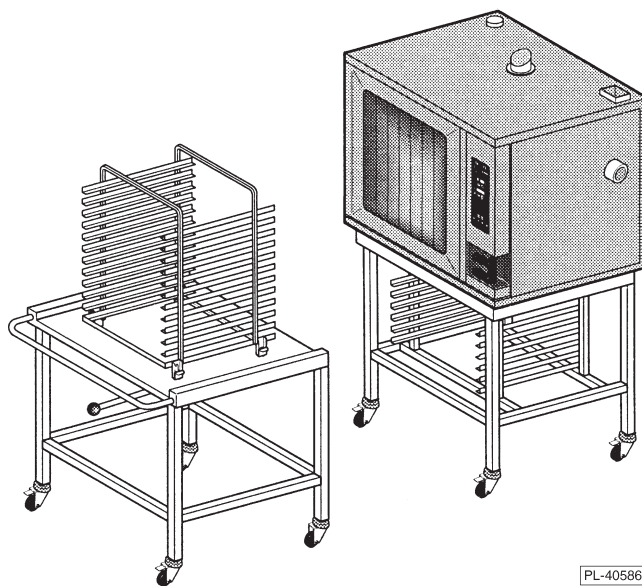

Fig. 6

When loading a 20 level oven with the trolley (Fig. 7), make sure the handle is locked in the down position so the rack is held securely to the trolley with its lifting hooks. Carefully move the loaded trolley completely into the open oven. When the rear frame of the rack is positioned behind the edge of the retainer, raise the handle to lower the rack-frame to the oven door.

UNLOADING THE OVEN

Allow the door to be slightly-opened for a few seconds to allow hot air and steam to escape. Stand behind the door while opening.

When unloading a 10 level oven, move the landing table so the clamp locks the landing table to the front of the oven (or use your body to hold the landing table against the oven). Remove the landing table handles and clamp them to the bottom of the hot oven pan rack. Carefully roll the hot pan rack onto the landing table platform while making sure that the landing table does not separate from the oven during transfer. Rotate the knob to allow the rack to move completely to the front of the landing table; and rotate the knob back to lock the pan rack in place.

When unloading a 20 level oven, move the trolley (Fig. 7) into the oven until the "lift-hooks" are inserted into both sides of the front frame of the rack in the correct "lift" position. Lower the trolley handle until it stops; the loaded rack is lifted from its retainer and held securely to the trolley by the "lift-hooks". The trolley may now be removed from the oven with the loaded rack securely held in place.

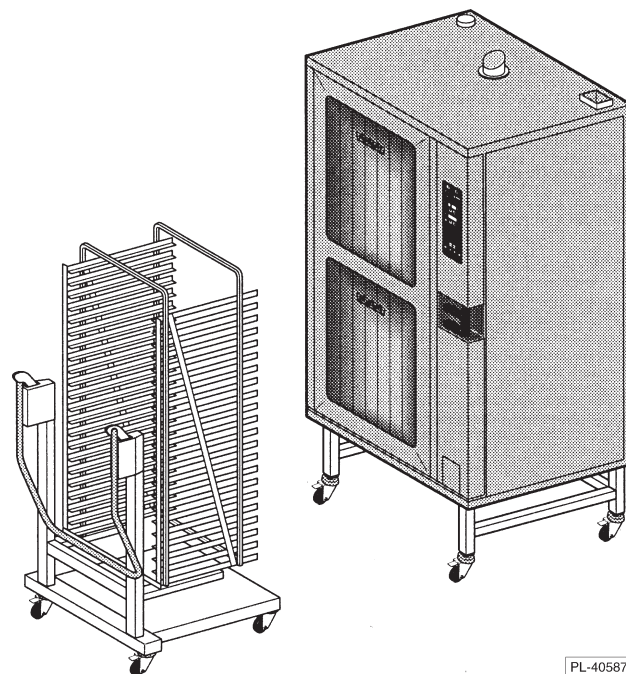
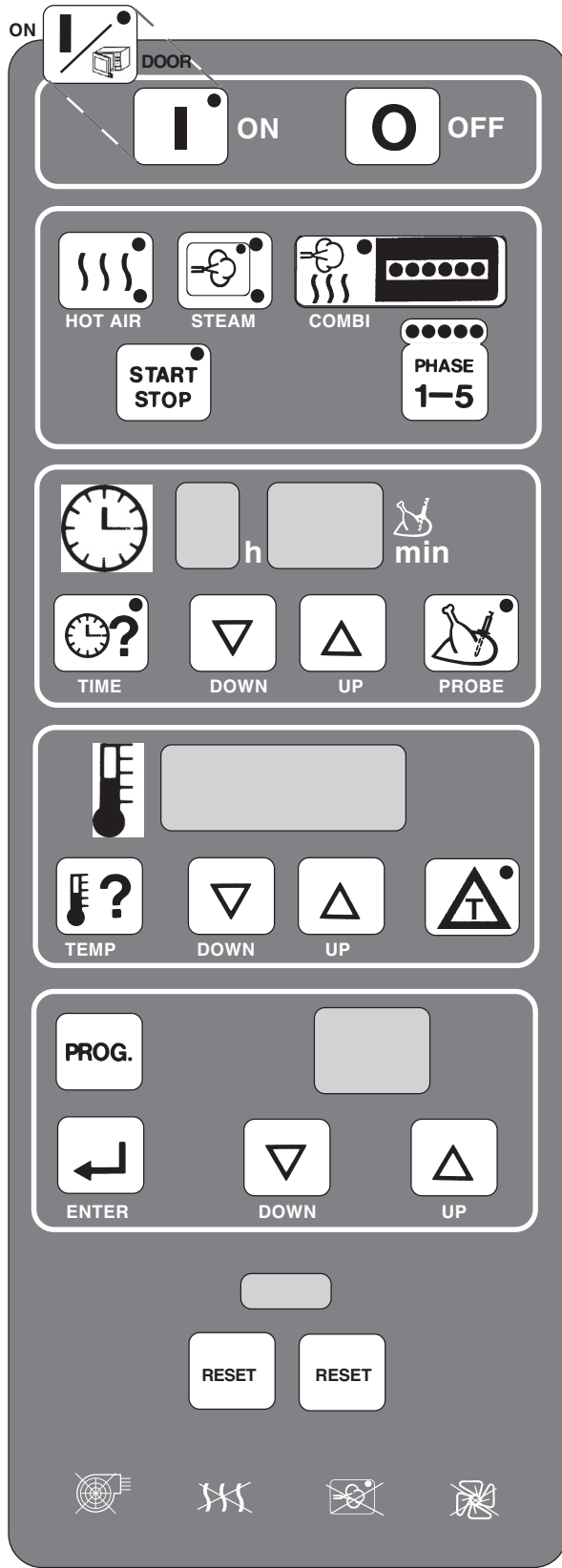

Fig. 7

PROGRAMMABLE CONTROLS



ON OFF See Door Opening and Closing, page 10.

COOKING MODE

- HOT AIR (Convection Baking)^{1 2}
- STEAM^{1 2}
- COMBI (Convection & Steam)^{1 2}

START STOP¹ PHASE 1 – 5

COOKING TIME¹ or PROBE TEMPERATURE¹

- SET Cooking Time
- DISPLAY Cooking Time, remaining
- SET Probe Temperature, final
- DISPLAY Probe Temperature, actual

OVEN TEMPERATURE or ¹

- SET Oven Temperature, desired
- DISPLAY Oven Temperature, actual
- SET  and use with Probe Temperature

PROGRAM NUMBER

- SET Cooking Programs
- RECALL or CHANGE a Cooking Program
- ENTER [] to save the Cooking Program

RESET (Left Button: Air Intake or Convection Burner)

RESET (Right Button: Steam Generator or Fan)

TROUBLE INDICATOR LIGHTS

Air Intake, Heat, Steam, Fan (refer to page 39).

¹ Upper indicator light shows the Mode selected.

² Lower indicator light means the burner is ON.

- ON** — After an initial power-up sequence, the control panel indicator lights and the light inside the oven are lit. The actual oven temperature is shown in the Temperature display, – h – – min is in the Time display, and – – is in the Program Number display. The control will now accept commands. The ON button also cancels a manual cooking operation of up to 5 Phases. (Pressing the ON button while the oven is running will open the door. Refer to page 10.)
- OFF** — Shuts off the oven and oven light, opens the oven vent and drains the steam generator tank (pump takes about a minute).

COOKING MODE

- HOT AIR** — Heat and Fan are ON; steam generator tank fills. Initial temperature setting is 302°F (range is 35 – 518°F).
- STEAM** — Steam and Fan are ON; steam generator tank fills, if not already full. Initial temperature setting is 212°F (range is 35 – 212°F) depending on the configuration setting for your altitude (refer to either page 35 or page 37).
- COMBI** — Heat, Fan and Steam are ON; steam generator tank fills, if not already full. Initial temperature setting is 302°F (range is 35 – 518°F). The amount of steaming is set by the number of times you press the Combi key (1 – 6), indicated by the row of lights.









START STOP— Starts or stops a cooking operation. Temperature flashes if door is not locked.

PHASE 1–5 — Indicates the Phase of a cooking program. Allows you to step through and display the cooking information for each phase of a cooking operation before starting.

COOKING TIME or PROBE TEMPERATURE

- TIME** — Displays the Cooking Time. Time remaining for ALL phases is normally displayed. Press the Time key again to display the time remaining for the current phase. When [– h – – min] displays in the time display, the oven is in manual mode (does not switch oven off at end of cycle).
- DOWN** — Decreases the Cooking Time or Probe Temperature setting.
- UP** — Increases the Cooking Time or Probe Temperature setting.
- PROBE** — Displays the Probe Temperature setting, initially 140°F (range is 70 – 210°F). After 5 seconds, displays the actual Probe Temperature.

OVEN TEMPERATURE or

- TEMP** — Displays the Oven Temp instead of . Normally displays the actual Oven Temp. Press Temp to display the Oven Temperature setting for 5 seconds and adjust it.
- DOWN** — Decreases the Oven Temperature or  setting.
- UP** — Increases the Oven Temperature or  setting.
-  — Displays  instead of Oven Temperature (temperature difference is indicated by __t in the display).  keeps the oven  degrees warmer than the actual Probe Temperature.  must be used with the Probe Temperature.

PROGRAM NUMBER

- PROG.** — Recalls and displays the cooking programs, by number, beginning with 00.
- DOWN** — Decreases the Program Number (range is 00 to 98).
- UP** — Increases the Program Number (range is 00 to 98).
- ENTER** — Stores the cooking parameters (up to 5 Phases) in memory under the Program Number. Cooking parameters will not be lost during power outage or disconnection.

PROBE

The Probe Temperature defines the final temperature of the product for any cooking phase. The cooking cycle stops when the product temperature reaches the probe temperature setting. Total Cooking Time is not known or entered when using the probe.

COOKING WITH THE PROBE

There are two ways to control the oven temperature when using the Probe . . .

- 1) Setting the Oven Temperature at a constant value. The oven climbs to the set point and the product cooks at that temperature. The cooking cycle ends when the product reaches the Probe temperature setting.
- 2) Using ΔT , the Oven temperature gradually increases as the internal temperature of the product increases, always maintaining the oven at ΔT degrees warmer than the product. ΔT can provide a slow cooking process that allows the product's required final internal temperature to be reached without over-browning the outside of the product. The Probe Temperature (not cooking Time) must be used when using ΔT . For Hot Air or Combi Modes, the recommended minimum ΔT is 110 F°; maximum is 240 F°. For Steam Mode, the recommended minimum ΔT is 60 F°; maximum is 180 F°.

The graph, below, shows two ways of controlling the oven temperature when using the Probe. The 150 F° value for ΔT is used to show how the oven works and is not typical of any particular cooking program.

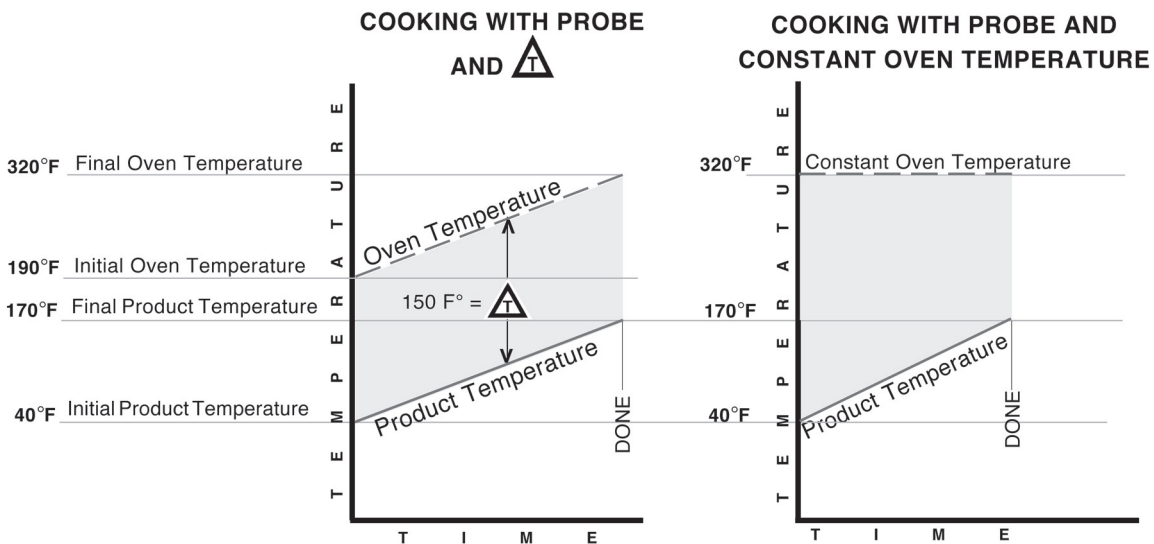

USING THE TEMPERATURE PROBE

The Temperature Probe is kept in a metal holder at the top of the oven when not in use. Remove the probe from its holder; the cable remains permanently connected to the top of the oven. Insert the pointed end of the probe so its tip is approximately in the middle of the product to be cooked. The probe cable is long enough to allow the product to be placed on one of the upper racks in the oven. The probe can be used to define the final temperature for any phase of the cooking process and for any of the three cooking modes: Convection (Hot Air), Steam or Combi.

- To set the Probe Temperature, press  and use the UP and DOWN arrows to adjust the setting. The Cooking Time cannot be used when the Probe Temperature is in use.

NOTE: During Operator training to demonstrate use of the probe, place the probe in a container of water to simulate cooking of actual product.

TEMPERATURE PROBE APPLICATIONS

All Applications are suggested only — prove your own recipes and temperature and time settings.

Product	Recommended Final Probe Temperature °F
Beef Rare Medium Well Done	125 140 180
Lamb	140 – 165
Pork Fresh Smoked	175 140 – 175
Turkey Whole Boneless	185 175
Veal	145 – 165

ENTERING A COOKING PROGRAM

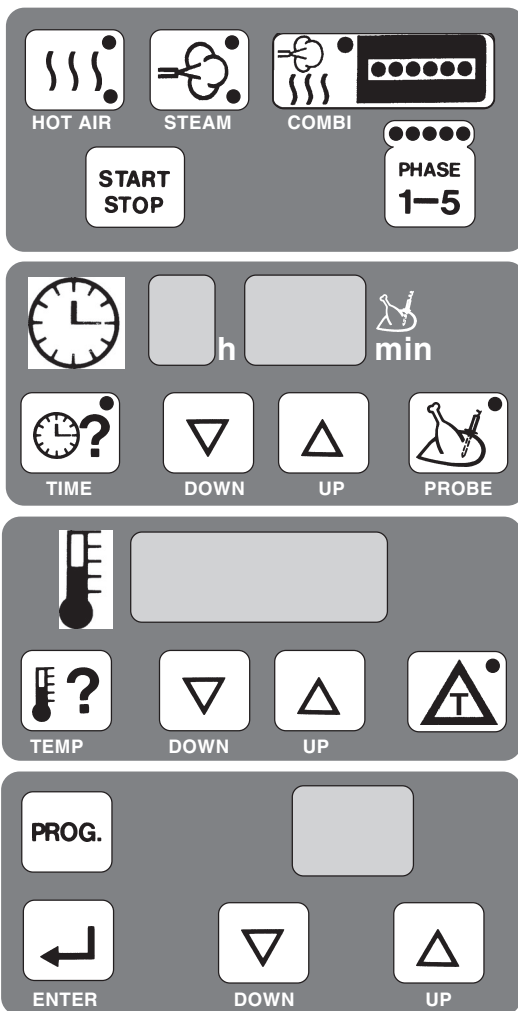

1. When entering cooking parameters, always select the **Mode** as the first element in a cooking phase: HOT AIR, STEAM or COMBI (also select Steam Factor for COMBI mode).
2. Enter the finish parameter for the cooking phase (COOKING TIME or PROBE TEMP) with its value.
3. Enter the oven control parameter for the cooking phase (TEMP or Δ) with its value.
4. Steps 1, 2 and 3 complete the parameters for that phase. For any additional phase (or phases), press the PHASE 1 – 5 key. Repeat steps 1, 2, 3 and 4 for each cooking phase.
5. If programming a repeat cooking process, select a Program Number following the instructions for Programming Memory on the next two pages.
6. Press to start cooking; the indicator light in the Start Stop key indicates the oven is operational.
7. When finished, press again to silence the buzzer.

PROGRAMMING MEMORY

Up to 99 Cooking Programs with up to 5 Phases in each program can be keyed-in and stored in Memory. Each program is accessed by its identifying number. Program numbers range from 00 – 98. A pre-defined Clean Cycle Delimiting program is also available (refer to page 38).

If the numbered Program has not been programmed (or is vacant), the Time displays – h – – min. No Mode or Phase indicator lights are lit. The Temperature displays – – or the current temperature.

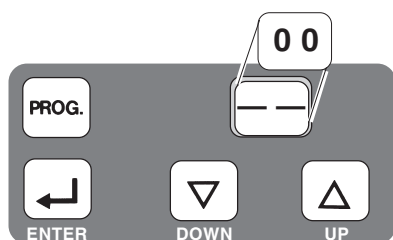

To **CREATE** a new program —



With — — in the program number display, the control is in Non-Program mode.

Press the **PROG.** key. Program Number 00 is displayed and the control is now in Program Mode. Use UP or DOWN arrows to increase or decrease the program number until a vacant program number is found.

ENTER THE COOKING INSTRUCTIONS (FOLLOW STEPS 1 – 6):

- 1) Select the cooking mode: Hot Air, Steam or Combi.
If Combi, set Steam Factor.
- 2) Set either the Time or Probe Temperature.
- 3) Set the Oven Temperature or .
- 4) End of the 1st Phase. Press  to shift to the next phase.
- 5) Repeat steps 1 – 4 for as many of the 5 phases as are needed. Review the program by stepping through the phases. Make any needed changes.
- 6) When the program is set, save it in memory by pressing  until the beep is heard.

NOTE: A cooking program can also be entered in manual mode and saved to a program number by selecting the Program Number and pressing  for about three seconds.

To **DELETE** an existing program —

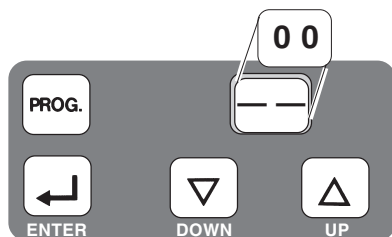

With — — in the program number display, the control is in Non-Program mode.



Press the **PROG.** key. Program Number 00 is displayed and the control is in Program Mode. Use UP or DOWN arrows to increase or decrease the program number until the program number to be deleted is displayed.

Press  and hold it in for about three seconds until the beep sounds, indicating the program has been deleted.

NOTE: If a previous program had been selected and was active in Non-Program mode, it will be copied to the selected program number, replacing the previous program. Verify that the program number is vacant after you delete it.

To **COPY** an existing program to a *NEW* program number —

Recall and display the program number that you wish to copy.

Press  to begin the program. Pause. Press  to stop the program.

Change the program number to the *NEW* number.

Press  until the beep sounds, indicating the program has been copied.

To **CHANGE** a program —

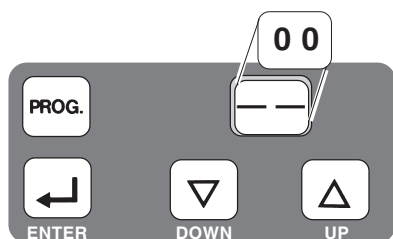

With — — in the program number display, the control is in Non-Program mode.

Press the  key. Program number 00 is displayed. Use the UP or DOWN arrows to increase or decrease until the program number you want to change is displayed.

Step through each phase, making any temperature, time or other changes for the phase; press  to shift to the next phase. The program number begins to blink when one or more changes have been made to the program.

To **SAVE** the changed cooking program, press  and hold it in for about three seconds until the beep sounds.

RECALLING A PROGRAM FROM MEMORY

Once a menu item has been programmed, it can be recalled, reviewed and used to cook food.

If the Program has already been programmed, its values are recalled from memory and displayed. You can view all the programmed information by stepping through the phases using the phase button.

To **RECALL** a program from memory —

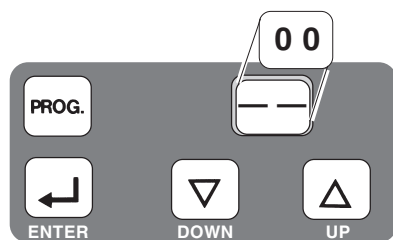



With — — in the program number display, the control is in Non-Program mode.

Press the  key. Program Number 00 is displayed. Use the UP or DOWN arrows to select the program number you want.

Use the Phase 1 – 5 key to step through and verify the cooking parameters for each phase of the cooking program.

Load the oven. If using the probe, place it in the center of the product.





Close the door and press  to begin the cooking program. The blinking indicator light in the Phase 1 – 5 key shows which phase of the cooking program is being performed. If the program is timed, the display shows the total time remaining. When the cooking program is done, the buzzer will sound.

Press  to silence the buzzer. Check the product for doneness.

BAKING (Convection Baking – HOT AIR)

Convection Baking involves baking, browning, roasting, etc. without adding steam or moisture to the process. Hot air is fan-circulated to maintain even temperatures throughout the oven. Preheating the oven before loading the product is recommended.

Automatic Convection Baking can be set up so the buzzer sounds when the Cooking Time has elapsed or when the product's internal temperature has reached the Probe Temperature set point. If using the Probe Temperature, insert the probe near the center of the product. Cooking Time is not used when the Probe Temperature is in use.

If using the Probe Temperature, either the Oven Temperature or  can be used to control the oven during baking. If using the Oven Temperature setting, the oven temperature will remain constant throughout the convection baking operation or phase. If using the Probe Temperature,  can be set to keep the oven temperature  degrees warmer than the Probe. With  cooking, the oven temperature gradually increases at the same rate as the internal temperature of the product, always maintaining a constant difference. The result with  is slow baking or roasting with less brown crusting on the outside of the product.





Turn the oven ON.



Select Convection (HOT AIR) Mode.





For *standard automatic* baking, set the Cooking Time and Oven Temp.

- To set the Cooking Time, press  and use the UP and DOWN arrows to adjust the setting.
- To set the Oven Temperature, press  and use the UP and DOWN arrows.





For *final product temperature* baking, set the Probe Temperature.

- To set the Probe Temperature, press  and use the UP and DOWN arrows. When the Probe Temperature indicator is lit, the numeric value in the time display is the Probe Temperature in °F. Probe Temperature can be used with either  or .



For *slow baking or roasting*, use  with the final Probe Temperature.

- To set , press  and use the UP and DOWN arrows.

When the control is set, load the oven. If using the probe, place it in the center of the product. Close the door and press  to begin.

Upon completion of the baking process, when either the Cooking Time has counted down or the Probe Temperature has been reached, the buzzer will sound.

Press  to silence the buzzer. Check the product for doneness.

CONVECTION BAKING APPLICATIONS – HOT AIR MODE

All Applications are suggested only — prove your own recipes and temperature and time settings.

Product	Preheat Temp °F	Oven Temp °F	Time in Minutes
FISH			
Cod or Mullet, fresh	350	325	10 – 12
Sea-frozen fish fillet	375	325	10 – 12
Sole, fresh	375	325	10 – 12
Trout, fresh	375	325	10 – 12
Trout, frozen	375	325	15 – 22
Trout, breaded, fresh	390	375	15 – 20
PORK			
Pork Chop, fresh, sauteed	400	325	10 – 12
Pork Chop, frozen, sauteed	400	350	15
Pork Cutlet, fresh, 4 - 5 oz	400	350	10 – 12
Pork Cutlet, fresh, breaded	375	325	10 – 12
Pork Loin Cutlet, fresh 4 - 5 oz	400	350	6 – 8
Ham Steak, fresh	400	325	6 – 10
Pork Sausage, fresh	400	350	8 – 10
Pork Steak, fresh	400	375	7
Pork Steak, frozen	400	375	10 – 12

Product	Preheat Temp °F	Oven Temp °F	Time in Minutes
PASTRY			
Puff Pastry	400	350	20
Danish Pastry	350	325	18 – 20
Flaky Pastry	350	325	16 – 18
Cake	350	325	8
Fruit Cake	350	300	55 – 65
Yeast Rolls with milk	350	325	10 – 12
Almond Pastry	350	325	10 – 12
Nut Pastry	350	325	10 – 12
Chocolate Pastry	350	300	10 – 12
Biscuit Pastry	350	325	10 – 12

Recommended setting for  in Convection Baking Mode is a minimum of 110 F° (61 C°).

STEAMING (Steam Mode only)

Steam Mode will not begin if cavity temperature is above 212°F (100°C).

Steam cooking is used for stewing, poaching and gentle cooking of products cooked in water. Steam flows without pressure into the oven. The fan circulates the steam to all parts of the oven. Allow the steam generator to preheat for 4 to 5 minutes if starting from cold.

Automatic Steaming can be set up so the buzzer sounds when the Cooking Time has elapsed or when the product's internal temperature has reached the Probe Temperature set point. If using the Probe Temperature, insert the probe near the center of the product. Cooking Time is not used when the Probe Temperature is in use.

Usually, the Cooking Time and Oven Temperature are used to control the steaming process.

Alternatively, the Probe Temperature can be used to indicate when cooking is done. When using the Probe Temperature, either the Oven Temperature or  can be used to control the oven.





Turn the oven ON.

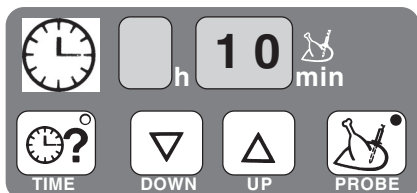

Select Steam Mode.



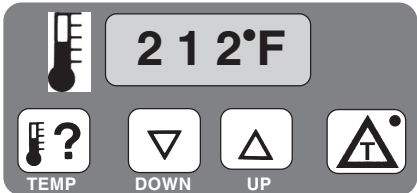

For *standard automatic* steaming, set the Cooking Time and the Oven Temperature.

- To set the Cooking Time, press  and use the UP and DOWN arrows.
- To set the Oven Temperature, press  and use the UP and DOWN arrows to adjust the setting.



For *final product temperature* steaming, set the Probe Temperature.

- To set the Probe Temperature, press  and use the UP and DOWN arrows. When the Probe Temperature indicator is lit, the numeric value in the time display is the Probe Temperature in °F. Probe Temperature can be used with either  or .



When the control is set, load the oven. If using the probe, place it in the center of the product.

Close the door and press  to begin.

Upon completion of the steaming process, when either the Cooking Time has counted down or the Probe Temperature has been reached, the buzzer will sound.

Press  to silence the buzzer. Check the product for doneness.

STEAMING APPLICATIONS

All Applications are suggested only — prove your own recipes and temperature and time settings.

Product	Time in Minutes
VEGETABLES	
Asparagus, fresh	4 – 6
Broccoli, fresh	4 – 6
Brussels Sprouts, fresh or frozen	6 – 8
Cabbage, white, sliced, fresh	6 – 8
Carrots, small, fresh or frozen	6 – 8
Carrots, diced, fresh	6 – 8
Cauliflower, fresh	4 – 6
Cauliflower, head, fresh	4 – 6
Celery, slices or diced	6 – 8
Corn, on-the-cob, fresh	15 – 18
Eggplant	6 – 8
Green Beans, fresh or frozen	4 – 6
Mushrooms, halved, quartered or sliced	4 – 6
Peas, frozen	6 – 8
Potatoes	20 – 35
Spinach, fresh	2
SIDE DISHES	
Dumplings, Meat Balls	10 – 20
Rice	20 – 25
MEAT	
Brisket	90 – 120
Veal, fricassee	40 – 50
FISH & CRUSTACEANS	
Cod, Halibut, fresh	8 – 14
Crayfish Tails, frozen	9 – 14
Mussels	8 – 14
Salmon, fresh	6 – 12

Recommended setting for  in Steam Mode is a minimum of 60 F° (33 C°).

COMBI (Convection Baking with Steam)

Combi baking with steam is used for baking, roasting or braising when steam needs to be added to the oven during a convection baking operation. The Steam Factor can be varied by repeat pressing of the Combi key — see Steam Factor in the table below. It is recommended that you preheat the oven.

Automatic Combi baking with steam can be set up so the buzzer sounds when the Cooking Time has elapsed or when the product's internal temperature has reached the Probe Temperature set point. If using the Probe Temperature, insert the probe near the center of the product. Cooking Time is not used when the Probe Temperature is in use.



Usually, the Cooking Time and Oven Temperature are used to control Combi baking with steam. Alternatively, the Probe Temperature can be used to indicate when cooking is done. When using the Probe Temperature, either the Oven Temperature or  can be used to control the oven.





Turn the oven ON.

Select Combi Mode and set the Steam Factor (see table below).*

For *standard automatic* Combi baking with steaming, set the Oven Temperature and the Cooking Time.

- To set the Cooking Time, press  and use the UP and DOWN arrows.
- To set the Oven Temperature, press  and use the UP and DOWN arrows to adjust the setting.

For *final probe temperature* Combi baking with steaming, set the Probe Temperature.

- To set the Probe Temperature, press  and use the UP and DOWN arrows. When the Probe Temperature indicator is lit, the numeric value in the time display is the Probe Temperature in °F. Probe Temperature can be used with either  or .

When the control is set, load the oven. If using the probe, place it in the center of the product. Close the door and press  to begin.

Upon completion of the Combi baking with steaming process, when either the Cooking Time has counted down or the Probe Temperature has been reached, the buzzer will sound.

Press  to silence the buzzer. Check the product for doneness.

* When selecting Steam Factor, press  1 to 6 times to obtain the desired steaming.

Indicator Lights	Combi Key	Steam Factor
○●●●●●	Pre-selected.	20
○●●●●●	Press one time.	30
○●●●●●	Press two times.	40
○●●●●●	Press three times.	50
○●●●●●	Press four times.	60
○●●●●○	Press five times.	70

COMBI APPLICATIONS

All Applications are suggested only — prove your own recipes and temperature and time settings. Some applications contain a HOT AIR or Convection Mode phase. Combi Mode is seldom performed as a single phase cooking operation.

Product	Phase 1	Phase 2	Phase 3	Final Internal Temperature
Roast Beef	Convection 425°F 10 minutes	Combi 280°F Steam Factor 50 Probe Setting 140°F	–	140°F
Meat Loaf	Combi 260°F Steam Factor 40 Probe Setting 150°F	Convection 350°F Probe Setting 165°F	–	165°F
Pork Loin	Combi 280°F Steam Factor 40 Probe Setting 175°F	–	–	175°F
Whole Chicken	Combi 280°F Steam Factor 40 Probe Setting 160°F	Convection 350°F Probe Setting 185°F	–	185°F
Whole Turkey	Combi 260°F Steam Factor 40 Probe Setting 175°F	Convection 350°F Probe Setting 190°F	–	190°F
Breads	Proofing: Combi 90 —100°F Steam Factor 60 Set Timer	Convection 325°F Set Timer	Combi 375°F Steam Factor 40 Set Timer	

* Always insert a cold probe into the product.

EXAMPLE PROGRAM

This example shows how to program a two-phase process for cooking Roast Beef and store it as program number 20.

The first item in the table on page 23 provides the information: Refer to the menu card example at the bottom of page 25.

Phase 1	Phase 2
Convection 425°F 10 minutes	COMBI 280°F Steam Factor 50 Final Internal Temperature: Probe Setting 140°F

Turn the oven ON.

- Phase 1** Convection HOT AIR Mode by pressing . The first light blinks on the phase button to indicate that you are programming Phase 1.
- Press : The Temperature displays 302°F. Press to increase or to decrease until the Temperature displays 425°F.
- Press and press to increase or to decrease until the Time displays [- h 10 min].
- Press to shift to Phase 2: The second indicator light begins to flash.
- Phase 2** Select Combi Mode - Steam Factor of 50 by pressing 3 times. The first four indicator lights will be lit to indicate the Steam Factor equals 50.
- Press : The Temperature displays 302°F. Press to increase or to decrease until the Temperature displays 280°F.
- Press and press to increase or to decrease until the Probe Temperature displays 140°F.
- Press to shift to Phase 3: The third indicator light begins to flash.
- Save** Press the key and press to increase or to decrease until the Program Number displays . Verify that this program number is vacant, or choose a different program number that is vacant. A vacant program displays the current temperature and blank Time [- h -- min]; no Mode or Phase indicator lights are lit. Then press until the beep is heard and the program is saved in memory.

MENU CARDS

PROGRAM NUMBER _____		Prep.			
Menu Item _____					
	MODE Hot Air Steam Combi (1•, 2•, 3•, 4•, 5•, 6•)	FINISH		OVEN CONTROL	
		TIME Hr. Min.	PROBE °F	TEMP °F	 F°
Phase 1					
Phase 2					
Phase 3					
Phase 4					
Phase 5					

PROGRAM NUMBER _____ 20					
Menu Item _____ Roast Beef					
	MODE Hot Air Steam Combi (1•, 2•, 3•, 4•, 5•, 6•)	FINISH		OVEN CONTROL	
		TIME Hr. Min.	PROBE °F	TEMP °F	 F°
Phase 1	CONVECTION Hot Air	10 Min.		425°F	
Phase 2	COMBI 4• ~ Steam Factor = 50		140°F	280°F	
Phase 3					
Phase 4					
Phase 5					

PROGRAM NUMBER _____					
Menu Item _____					
	MODE Hot Air Steam Combi (1•, 2•, 3•, 4•, 5•, 6•)	FINISH		OVEN CONTROL	
		TIME Hr. Min.	PROBE °F	TEMP °F	
Phase 1					
Phase 2					
Phase 3					
Phase 4					
Phase 5					

PROGRAM NUMBER _____					
Menu Item _____					
	MODE Hot Air Steam Combi (1•, 2•, 3•, 4•, 5•, 6•)	FINISH		OVEN CONTROL	
		TIME Hr. Min.	PROBE °F	TEMP °F	
Phase 1					
Phase 2					
Phase 3					
Phase 4					
Phase 5					

PROGRAM NUMBER _____					
Menu Item _____					
	MODE Hot Air Steam Combi (1•, 2•, 3•, 4•, 5•, 6•)	FINISH		OVEN CONTROL	
		TIME Hr. Min.	PROBE °F	TEMP °F	 F°
Phase 1					
Phase 2					
Phase 3					
Phase 4					
Phase 5					

PROGRAM NUMBER _____					
Menu Item _____					
	MODE Hot Air Steam Combi (1•, 2•, 3•, 4•, 5•, 6•)	FINISH		OVEN CONTROL	
		TIME Hr. Min.	PROBE °F	TEMP °F	 F°
Phase 1					
Phase 2					
Phase 3					
Phase 4					
Phase 5					

DELUXE MANUAL CONTROL

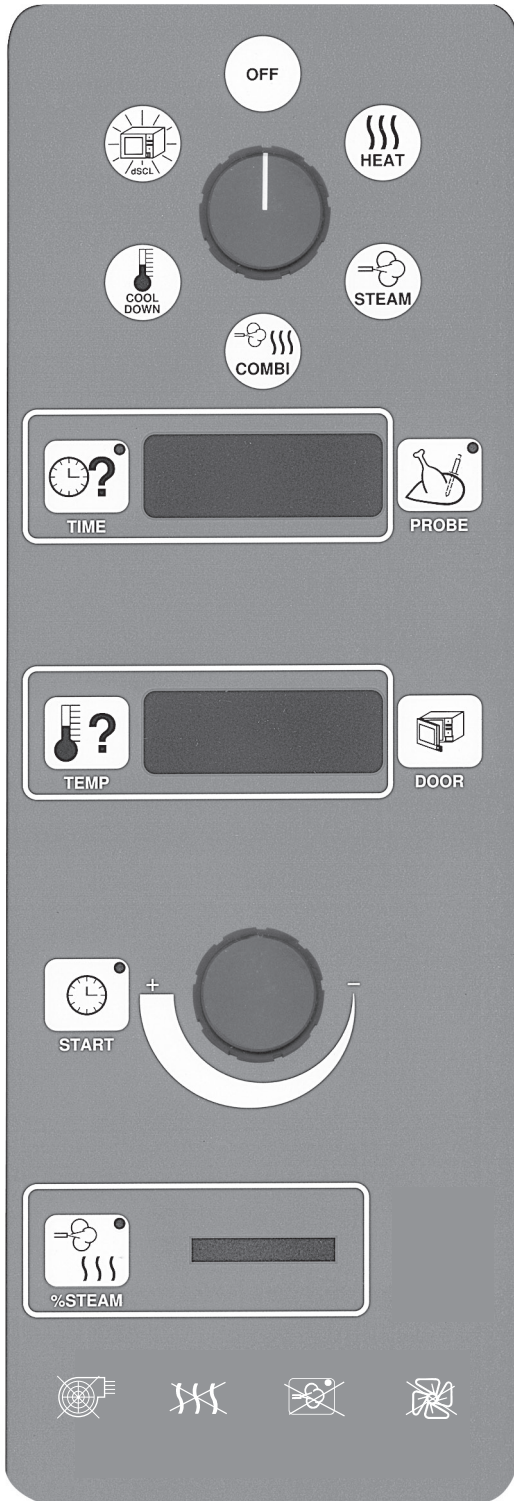

SELECTOR SWITCH

- OFF
- CONVECTION HOT AIR MODE (Temp. Range 35–518°F)
- STEAM MODE (Temp. Range 35 – 212°F)
- COMBI MODE (Temp. Range 35 – 518°F)
- COOL DOWN — Door opens to latched position and fan is on until the set temperature is reached. Fan will come on if thermostat setting is below the actual temperature.
- dSCL, Clean Cycle Delimiting (page 38)

COOKING TIME or PROBE TEMPERATURE

- SELECT Cooking Time
- DISPLAY Cooking Time Remaining. Press TIME for three seconds to momentarily display the original TIME setting.
- SELECT Probe Temperature, final (Temp. Range 70–210°F)
- DISPLAY Probe Temperature setting

OVEN TEMPERATURE

- SELECT Oven Temperature
- DISPLAY Oven Temperature Setting. Press TEMP for three seconds to momentarily display the actual Oven Temperature.

DOOR OPEN

START

- START Timer Countdown
- START Probe Cooking Operation

KNOB

- SET Oven Temperature
- SET Probe Temperature
- SET Timer

STEAM FACTOR 1 – 6 Indicator Lights (page 22)

TROUBLE INDICATOR LIGHTS

Air Intake, Heat, Steam, Fan

ENTERING A MANUAL COOKING OPERATION — Deluxe Control

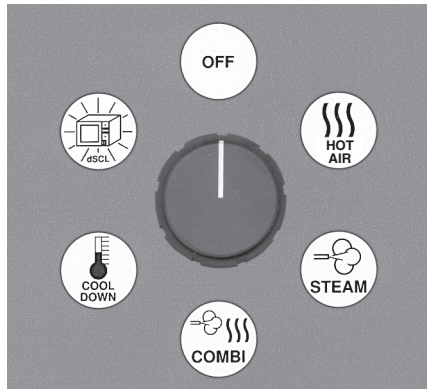

1. When setting cooking parameters, always select the **Mode** as the first element in the cooking operation: HOT AIR, STEAM or COMBI. The previous temperature setting used in that Mode is displayed. For Combi Mode, the previous Steam Factor setting is also displayed. After selecting the Mode, the oven begins to heat and maintains the set temperature unless adjusted.

- In Combi Mode, select the Steam Factor by pressing



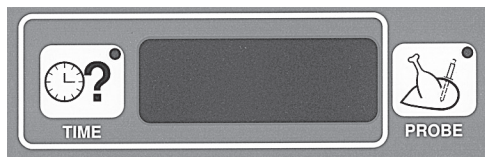

- 1 to 6 times to obtain the desired steaming.

Refer to the table at the bottom of page 22.



2. Enter the finish parameter for the cooking program (COOKING TIME or PROBE TEMP.) with its value.

- Press  and set the Cooking Time using the knob to adjust so the correct value is displayed.

- Or, press  and set the final Probe Temperature for the product being cooked using the knob to adjust so the correct value is displayed. Refer to Temperature Probe Applications on page 15.

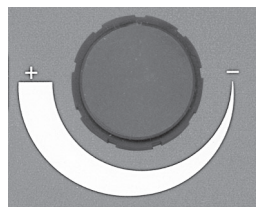

3. Press . The previous Oven Temperature setting displays. Use the Knob to adjust the Oven Temperature setting so the correct value is displayed.

4. Press START to start timer countdown or probe cooking. Colon flashes during countdown.

5. When finished, the buzzer sounds. Press START to silence the buzzer; the Time display will automatically reset to the initial value. The heating elements continue to maintain the Oven Temperature at the set value.

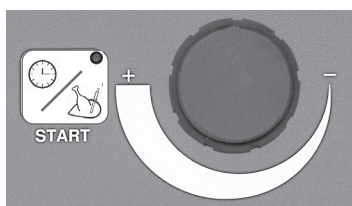

NOTE: After pressing the selection button (TIME or TEMP), the display will start flashing. At end of adjustment, the set value flashes for 5 seconds and then displays without flashing.

6. Press  to open the door to the latched but slightly open position for three seconds. Manually disengage the latch by turning the handle 90 degrees and pulling the door open within the three second interval. If the door is not manually disengaged within the three second interval, the door automatically re-closes.

STANDARD MANUAL CONTROL

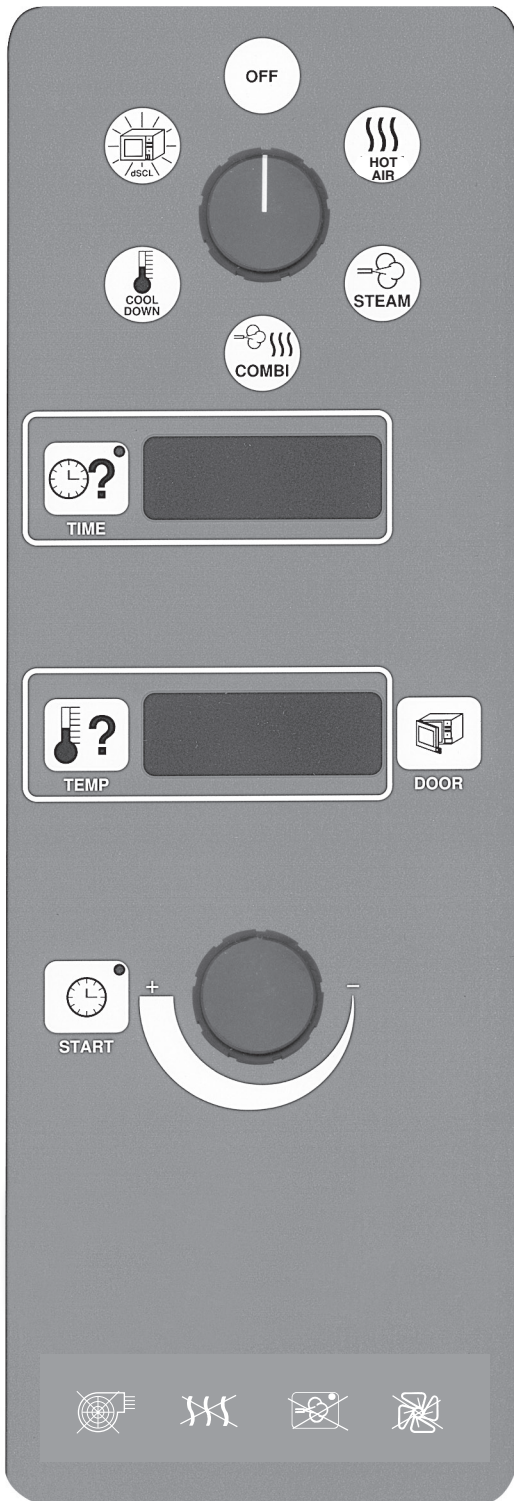

SELECTOR SWITCH

- OFF
- CONVECTION HOT AIR MODE (Temp. Range: 35–518°F)
- STEAM MODE (Temp. Range: 35 – 212°F)
- COMBI MODE (Temp. Range: 35 – 518°F)
- COOL DOWN — Door opens to latched position and fan is on until the set temperature is reached. Fan will come on if thermostat setting is below the actual temperature.
- dSCL, Clean Cycle Delimiting (page 38)

COOKING TIME

- SELECT Cooking Time
- DISPLAY Cooking Time Remaining. Press TIME for three seconds to momentarily display the original TIME setting.

OVEN TEMPERATURE

- SELECT Oven Temperature
- DISPLAY Oven Temperature Setting. Press TEMP for three seconds to momentarily display the actual Oven Temperature.

DOOR OPEN

START

- START Timer Countdown

KNOB

- SET Oven Temperature
- SET Timer

TROUBLE INDICATOR LIGHTS

Air Intake, Heat, Steam, Fan

ENTERING A MANUAL COOKING OPERATION — Standard Control

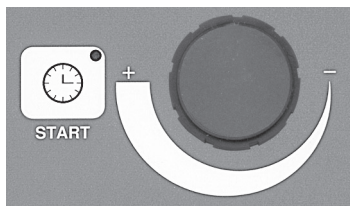
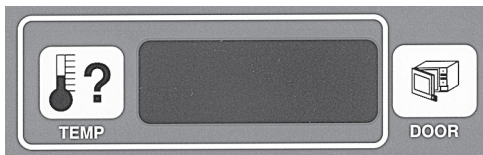
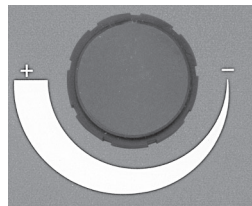
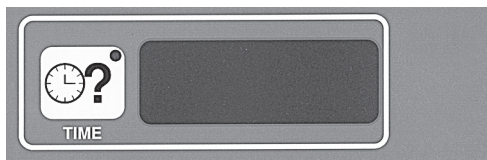
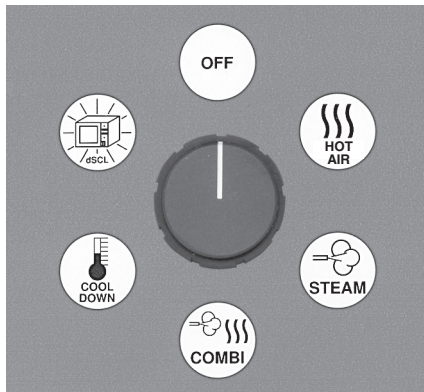

1. When setting cooking parameters, always select the **Mode** as the first element in the program: HOT AIR, STEAM or COMBI. The previous temperature setting used in that Mode is displayed. After selecting the Mode, the oven begins to heat and maintains the set temperature unless adjusted. The Steam Factor in Combi Mode is automatically fixed on 40 and cannot be adjusted (this is the same as if three indicator lights were lit — see table at bottom of page 22).

2. Press  and set the Cooking Time using the knob to adjust so the correct value is displayed.

NOTE: After pressing the selection button (TIME or TEMP), the display will start flashing.

3. Press . The previous Oven Temperature setting displays. Use the Knob to adjust the Oven Temperature setting so the correct value is displayed.

4. Press START to start timer countdown. Colon flashes during countdown.

5. When finished, the buzzer sounds. Press START to silence the buzzer; the Time display will automatically reset to the initial value. The burners continue to maintain the Oven Temperature at the set value.

6. Press  to open the door to the latched but slightly open position for three seconds. Manually disengage the latch by turning the handle 90 degrees and pulling the door open within the three second interval. If the door is not manually disengaged within the three second interval, the door automatically re-closes.

CLEANING

Daily Cleaning

Preheat the oven to 130°F and spray a mild detergent solution that does not contain chlorine on the inside surfaces of the oven. A Spray Bottle is provided. Allow the detergent solution to react for 15 minutes.

Operate the oven on Steam mode for 15 minutes. Allow the oven to cool; wipe the oven interior with a sponge and warm water. Dry the oven interior with a clean soft cloth.

DO NOT use abrasive products.

Clean the exterior with a cloth or sponge and non-aggressive, non-abrasive products.

Complete Cleaning

WARNING: UNPLUG THE ELECTRICAL POWER CORD.

Remove the Rack (Fig. 8). Remove the Grease Filter (Fig. 8) at the rear of the oven chamber by lifting up and out. Remove the Fan Baffle (Fig. 9) by lifting up and out. Remove the Rack Retainer (Fig. 9) normally located under the Grease Filter and Fan Baffle. Wash the removed parts in a sink with warm soapy water, rinse with clear water and dry with a clean dry cloth.

Clean all areas of the oven and all parts. Reinstall the parts in their original positions.

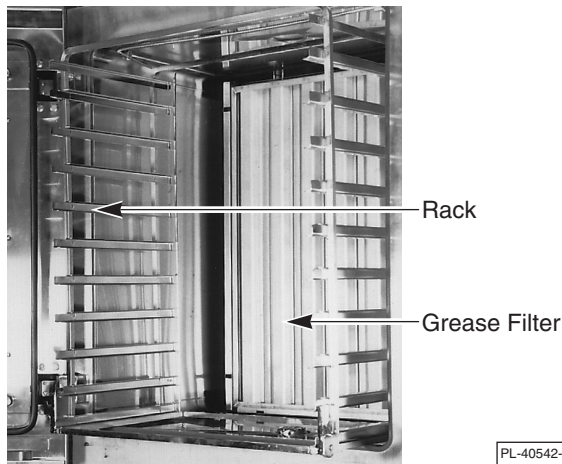

Fig. 8

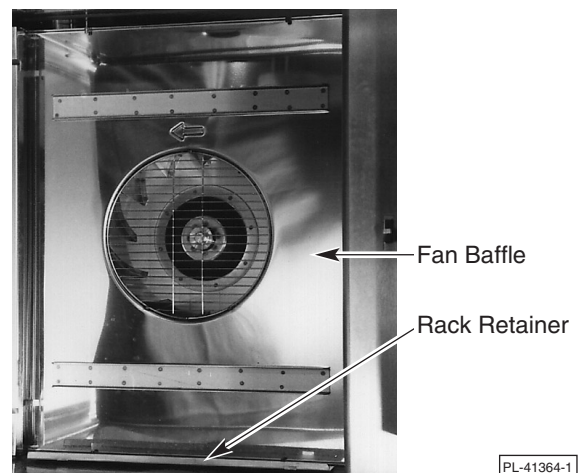

Fig. 9

If using the hose spray accessory to clean the oven interior, DISCONNECT ELECTRICAL POWER and avoid spraying near the controls.

DO NOT use steel wool or abrasive scouring pads as they will scratch and ruin the oven surfaces.

Sanitize the temperature probe. Return it to its home position in the bracket on the ceiling of the oven.

DO NOT spray cleaners, detergents or water directly onto the burner. This may cause mechanical problems.

Complete Cleaning (continued)

The Interior Glass Door (Fig. 10) is independently hinged to allow both sides of the glass doors to be cleaned. With the oven door open, pull the Interior Glass Door away from the exterior oven door. The snap-release fasteners should allow the Interior Glass Door to swing free. All four sides of the glass can be cleaned using a cloth and glass cleaner. Alternatively, clean the glass surfaces with soapy water, rinse with clear water and dry with a clean cloth. The area between, behind and around the surfaces of the upper and lower hinges can be cleaned by holding both ends of a moist soapy cleaning cloth folded in a 3" wide strip and swabbing up and down; rinse and dry with clean wet or dry cloth in the same manner. When glass is clean, push the Interior Glass Door against the exterior oven door: The snap-release fasteners should re-fasten the Interior Glass Door to the exterior glass door so it operates as one door.

Wipe surfaces which touch the Door Gasket with a cloth or sponge and warm soapy water, rinse with clear water and wipe with a dry cloth. **CAUTION: Do not allow the door gasket to come in contact with food oils, petroleum solvents, lubricants or caustic cleaners.**

For 10 level ovens, remove the drip tray (Fig. 10) by removing the two thumbscrews that attach it to the bottom of the oven. For 20 level ovens, the three segment drip tray may be removed for cleaning. Save the screws. Wash and rinse the drip tray in a sink with warm soapy water, rinse with clear water and dry with a clean cloth. To reinstall drip tray: Reverse the removal procedure, align screw holes and tighten screws.

Clean the Condensate Gutter as necessary using a cloth with warm soapy water. Rinse with a clean cloth and fresh water and allow to air dry.

Keep the cooking compartment drain (Fig. 10) working freely. After cooking grease producing foods, operate the oven with the compartment empty for 30 minutes at the end of the day, or slowly pour $\frac{1}{2}$ gallon of warm soapy water down the drain, followed by $\frac{1}{2}$ gallon of warm clear water. The drain grating may be removed for cleaning; replace it in its original position when done.

Leave the door slightly open when the oven is not in use to allow the inside to dry out.

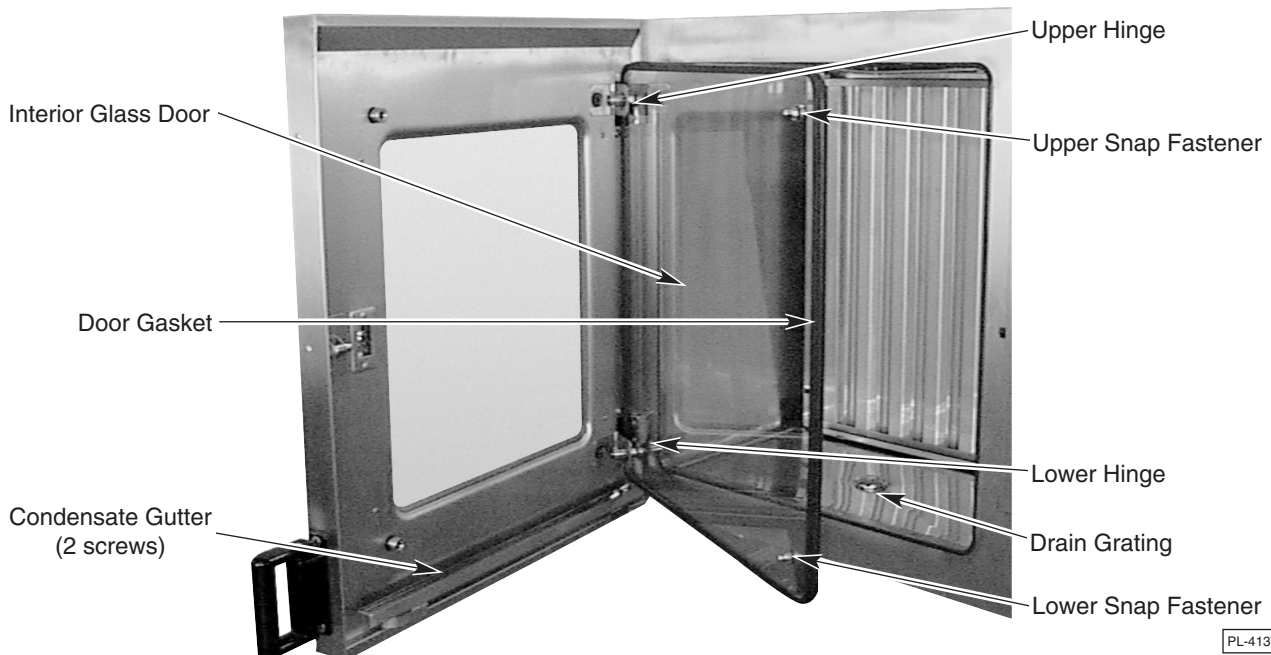

Fig. 10

CONFIGURATION MODE — PROGRAMMABLE CONTROL

This procedure should be performed by a qualified service technician.







WARNING: UNPLUG THE ELECTRICAL POWER CORD.

Identify the manufacturer(s) of the convection fan motor(s) by inspecting the label on the motor(s) after the rear panel is removed. This information is needed for Steps 10 – 12. Replace rear panel and reconnect electrical power.

Some of the procedures in this section are set at the factory and do not need to be re-valued. Only steps 2, 6 and 7 must be completed at time of installation. Other values, if changed improperly, could result in the oven not operating properly and may require a service technician.

Pressing  repeatedly advances from step 1 through step 12 and then repeats from step 2.

After any keystroke where an individual setting is either changed or accepted, the setting will display for three seconds and then automatically advances to the next step.

1. Configuration Mode can be entered only when the oven is OFF. With the oven OFF, press  and the UP and DOWN arrows in the TIME area all at the same time for about three seconds. [Conf] will be displayed in the temperature display to indicate Configuration Mode.
2. [C F] will be displayed in the TIME display to allow selection of the temperature scale. Press the UP arrow key for Fahrenheit. The DOWN arrow key is used for Celsius. A blinking F indicates Fahrenheit is selected while a blinking C would indicate Celsius. After making a selection, the selection displays for three seconds and automatically advances to the next step. Or, press  to advance to the next step.
3. [dSC] is displayed in the TIME display and the number of clean cycles completed is displayed in the TEMPERATURE display. This number cannot be changed or modified. Press  to advance to the next step.
4. The revision level of the control's software is displayed in the time display and cannot be changed. This information is needed by your service technician. Press  to advance to the next step.
5. [5 6] will be displayed in the TIME display to allow selection of voltage frequency. Press the DOWN arrow for 50 hertz; press the UP arrow for 60 hertz. After making a selection, the selection displays for three seconds and automatically advances to the next step. Or, press  to advance to the next step.
6. [HHH] is displayed in the TIME display and the total cooking hours of the oven is displayed in the temperature display. This can be reset. Using the UP arrow key in the temperature display will increase the number of hours; using the DOWN arrow key will decrease the number of hours. Press  to advance to the next step.
7. [bbb] is displayed in the TIME display and the buzzer is sounding to indicate the buzzer's "on-off" frequency selection. The numeric value [000 to 255] in the TEMPERATURE display indicates the type of sound the buzzer will make. [000] makes a continuous sound while [255] beeps at a very slow interval. A good setting to start with is [050]. Press the UP or DOWN arrow keys in the temperature area to increase or decrease the numeric value to obtain the desired sound. Buzzer loudness can be adjusted by your service technician. Press  to advance to the next step.





8. [uuu] is displayed in the TIME display and the maximum steam generator temperature setting is displayed in the TEMPERATURE display. This value can be adjusted depending on the elevation (see Elevation vs. Boiling Temperature Table, below). Press the UP or DOWN arrow keys in the temperature area to increase or decrease the numeric value. Press  to advance to the next step.

ELEVATION	Sea Level to 500 Ft.	500 to 1000 Ft.	1000 to 2000 Ft.	2000 to 3000 Ft.	3000 to 4000 Ft.	4000 to 5000 Ft.	5000 to 6000 Ft.	6000 to 7000 Ft.	7000 to 8000 Ft.	8000 to 9000 Ft.	9000 to 10,000 Ft.	Above 10,000 Ft.
BOILING TEMPERATURE (WATER) °F	212°F	211°F	209°F	207°F	205°F	204°F	202°F	200°F	198°F	196°F	195°F	194°F

9. [CCC] is displayed in the TIME display and the maximum convection oven temperature setting is displayed in the TEMPERATURE display. This value can be adjusted from 482°F to 518°F. It is recommended the [CCC] setting be 518°F. Press the UP or DOWN arrow keys in the temperature area to increase or decrease the numeric value. Press  to advance to the next step.
10. Set the Minimum and Maximum Values in steps 11 and 12 according to the FAN MOTOR COEFFICIENTS TABLE, below, the motor manufacturer's label and the number of convection fan motors in the oven.

FAN MOTOR COEFFICIENTS TABLE

Motor Manufacturer(s)	Number of Convection Fan Motors	Minimum Value 1 - - See step 11.	Maximum Value 2 - - See step 12.
Leroy-Somer (Hanning)	1	08	60
Brook-Crompton	1	08	60
Both motors by Leroy-Somer (Hanning)	2	26	130
Both motors by Brook-Crompton	2	26	130
1 motor by Leroy-Somer (Hanning) and 1 motor by Brook Crompton	2	26	130

11. [1 - -] is displayed in the TIME display and the Minimum Value is displayed in the TEMPERATURE display. Press the UP and DOWN arrow keys in the temperature area to increase or decrease the Minimum Value according to the table above. Press  to advance to the next step.
12. [2 - -] is displayed in the TIME display and the Maximum Value is displayed in the TEMPERATURE display. Press the UP and DOWN arrow keys in the temperature area to increase or decrease the Maximum Value according to the table above. Press  to advance to the next step.
13. To repeat the Configuration Mode process from step 1, press . To exit Configuration Mode and save all settings, press .

CONFIGURATION MODE — MANUAL CONTROL (Standard or Deluxe)

This procedure should be performed by a qualified service technician.









WARNING: UNPLUG THE ELECTRICAL POWER CORD.

Identify the manufacturer(s) of the convection fan motor(s) by inspecting the label on the motor(s) after the rear panel is removed. This information is needed for Steps 9 – 11. Replace rear panel and reconnect electrical power.

Some of the procedures in this section are set at the factory and do not need to be re-valued. Only steps 2, 6 and 7 must be completed at time of installation. Other values, if changed improperly, could result in the oven not operating properly and may require a service technician.

Pressing  TIME repeatedly advances from step 1 through step 12 and then repeats from step 2.

After any keystroke where an individual setting is either changed or accepted, the setting will display for three seconds and then automatically advances to the next step.

1. Configuration Mode can be entered only when the oven is OFF. With the oven OFF, press  and  at the same time for about three seconds. [Conf] will be displayed in the temperature display to indicate Configuration Mode. Press  TIME to begin.
2. [C F] will be displayed in the TIME display to allow selection of the temperature scale. Turn the adjustment knob clockwise for Fahrenheit; turning counterclockwise would select Celsius. A blinking F indicates Fahrenheit is selected while a blinking C would indicate Celsius. After making a selection, the selection displays for three seconds and automatically advances to the next step. Or, press  TIME to advance to the next step.
3. [dSCL] is displayed in the TIME display and the number of clean cycles completed is displayed in the TEMPERATURE display. This number cannot be changed or modified. Press  TIME to advance to the next step.
4. The revision level of the control's software is displayed in the time display and cannot be changed. This information is needed by your service technician. Press  TIME to advance to the next step.
5. [HHHH] is displayed in the TIME display and the total number of cooking hours of the oven is displayed in the temperature display. This can be reset. Rotate the knob counterclockwise to decrease the number of hours; rotate the knob clockwise to increase the number of hours. Press  TIME to advance to the next step.
6. [bbbb] is displayed in the TIME display and the buzzer is sounding to indicate the buzzer's "on-off" frequency selection. The numeric value [000 to 255] in the TEMPERATURE display indicates the type of sound the buzzer will make. [000] makes a continuous sound while [255] beeps at a very slow interval. A good setting to start with is [050]. Rotate the knob counterclockwise to decrease buzzer frequency; rotate the knob clockwise to increase buzzer frequency. Buzzer loudness can be adjusted by your service technician. Press  TIME to advance to the next step.



7. [uuuu] is displayed in the TIME display and the maximum steam generator temperature setting is displayed in the TEMPERATURE display. This value must be adjusted for the elevation (see Elevation vs. Boiling Temperature Table, below). Rotate the adjustment knob clockwise to increase or counterclockwise to decrease the numeric value. Press  TIME to advance to the next step.

ELEVATION	Sea Level to 500 Ft.	500 to 1000 Ft.	1000 to 2000 Ft.	2000 to 3000 Ft.	3000 to 4000 Ft.	4000 to 5000 Ft.	5000 to 6000 Ft.	6000 to 7000 Ft.	7000 to 8000 Ft.	8000 to 9000 Ft.	9000 to 10,000 Ft.	Above 10,000 Ft.
BOILING TEMPERATURE (WATER) °F	212°F	211°F	209°F	207°F	205°F	204°F	202°F	200°F	198°F	196°F	195°F	194°F

8. [CCCC] is displayed in the TIME display and the maximum convection oven temperature setting is displayed in the TEMPERATURE display. This value can be adjusted from 482°F to 518°F. It is recommended the [CCCC] setting be 518°F. Rotate the adjustment knob counterclockwise to decrease or clockwise to increase the numeric value. Press  TIME to advance to the next step.
9. Set the Minimum and Maximum Values in steps 10 and 11 according to the FAN MOTOR COEFFICIENTS TABLE, below, the motor manufacturer's label and the number of convection fan motors in the oven.

FAN MOTOR COEFFICIENTS TABLE



Motor Manufacturer(s)	Number of Convection Fan Motors	Minimum Value 1 - - See step 10.	Maximum Value 2 - - See step 11.
Leroy-Somer (Hanning)	1	08	60
Brook-Crompton	1	08	60
Both motors by Leroy-Somer (Hanning)	2	26	130
Both motors by Brook-Crompton	2	26	130
1 motor by Leroy-Somer (Hanning) and 1 motor by Brook Crompton	2	26	130

10. [1 - -] is displayed in the TIME display and the Minimum Value is displayed in the TEMPERATURE display. Rotate the adjustment knob clockwise to increase or counterclockwise to decrease the Minimum Value according to the table above. Press  TIME to advance to the next step.
11. [2 - -] is displayed in the TIME display and the Maximum Value is displayed in the TEMPERATURE display. Rotate the adjustment knob clockwise to increase or counterclockwise to decrease the Maximum Value according to the table above. Press  TIME to advance to the next step.
12. To repeat the Configuration Mode process from step 2, press . To exit Configuration Mode and save all settings, press the START button.

MAINTENANCE

WARNING: THE OVEN AND ITS PARTS ARE HOT. USE CARE WHEN OPERATING, CLEANING OR SERVICING THE OVEN. THE COOKING COMPARTMENT CONTAINS LIVE STEAM. STAY CLEAR WHEN OPENING DOOR.

CLEAN CYCLE DELIMING PROCEDURE

- With the Programmable Control, select the Clean Cycle [Program Number 00 and  or Program Number 98 and ]. [CC] will display as the Program Number, [dSCL] will display in the Temperature Display. Push Start Stop. The indicator light in the Start Stop key will light. For Manual Controls, turn the Selector Switch to dSCL.

1. The Steam Generator will drain, the oven will beep for 5 seconds, [40] will display in the Time Display and the indicator light in the Start Stop key will turn off.
2. If the filter system is installed in the water line to the steam generator, remove the cartridge from the housing, install the dip tube and add the appropriate amount of ScaleKleen descaling chemicals for the Combi Model as specified in Column D or E of the following table.

If there is no filter system installed in the water line to the steam generator, add the amount of vinegar equal to the Tank Volume as specified in Column B or C of the following table. Add the vinegar to the steam generator tank through the opening inside the oven cavity using the funnel and flexible tube provided with the oven.

CLEAN CYCLE DELIMING — TANK VOLUME AND CHEMICAL REQUIREMENTS

DO NOT EXCEED THE RECOMMENDED CHEMICAL CONCENTRATION

A. MODEL	B. TANK VOLUME (U.S. GALLONS)	C. TANK VOLUME (QUARTS)	D. QUANTITY OF 7 OZ. PACKETS OF SCALEKLEEN TO ACHIEVE 7 oz. / gallon	E. QUANTITY OF 2.2 LB. PACKETS OF SCALEKLEEN TO ACHIEVE 2.2 lb / five gallons
VCG10H	1.6 gal	6.3 qt.	1.5 packets or 10.5 oz.	0.3 packets or 10.5 oz.
VCG10F	1.6 gal	6.3 qt.	1.5 packets or 10.5 oz.	0.3 packets or 10.5 oz.
VCG20H	2.6 gal	10.5 qt.	2.5 packets or 17.5 oz.	0.5 packets or 17.5 oz.

3. Press the START button. The door closes and locks, and the control cannot be interrupted until the Clean Cycle is finished. The oven cannot be turned off. If a power interruption occurs, the Clean Cycle will resume after power is restored. No other operations can be performed until the Clean Cycle is [DONE].

The timer will start counting down. The steam generator will fill with water until the water level controls shut off the fill.

The steam generator will heat and produce steam for 30 minutes. After 30 minutes, the steam generator heat goes off and the tank drains.

The Time Display will show 10 minutes. The timer will not count down.

The Steam Generator will fill and drain two times. The fill time is programmed for each model.





With the Time Display still showing 10 minutes, the time will now begin to count down while the Steam Generator heats and generates steam. At the end of the 10 minute interval, the Steam Generator heat goes off and the tank drains.

[DONE] will display in the Temperature Display indicating that the Clean Cycle is complete.

NOTE: If an error occurs during the Clean Cycle, [FAIL] will display in the Temperature Display instead of [DONE].

Per the instructions in the filter cartridge replacement and preventive maintenance kit: Retest the water, return the response card and replace the filter cartridge.

TROUBLESHOOTING

SYMPTOM	SUGGESTED CORRECTIVE ACTION
Steam button, Combi button and Steam Factor lights are all flashing.	Oven works in Hot Air mode but not in Steam or Combi modes. The treated water supply valve is off. Open the water supply valve. Turn oven off and then back on. Allow the steam generator to preheat.
 The Air Intake Trouble Indicator Light is lit.	The air supply to the convection burner is blocked. Press the left Reset button. If the problem persists, clean the air filter, as follows: To clean the Air Intake Filter, unplug the electrical power cord. Remove two acorn nuts on the Air Filter Panel — this is located on the left side of the oven on a 10 level full depth oven and on the right side of the oven on a 10 or 20 level half depth oven. Remove the metallic grease filter and wash it in warm soapy water in a sink. Rinse the filter and allow it to air dry. Replace all parts. For oven clearance requirements, refer to Location (page 5). If the problem persists, contact service.
 The Heat Trouble Indicator Light is lit.	The Convection Burner has failed to ignite. Make sure the gas valve is on. Press the left Reset button. If the problem persists, contact service.
 The Steam Trouble Indicator Light is lit.	The Steam Generator has failed to ignite. Make sure the gas valve is on. Press the right Reset button. If the problem persists, contact service.
 The Fan Trouble Indicator Light is lit.	The Oven Fan has failed. Press the right Reset button. If the problem persists, contact service.
[OUR] displays in the temperature display.	There is an obstruction in the cavity vent on top of the oven. Unplug the electrical power cord and remove any obstruction from the cavity vent.
[888C], [888F], [999C] or [999F] displays in the temperature display.	One of the temperature sensors is faulty. Contact service.
[00] displays in the time display while the temperature probe is in use.	The temperature probe is faulty. Contact service.
Power failure occurs while food is in the oven.	Open the door manually, as follows: Switch the oven off. Pull the door handle firmly towards you while firmly pressing against the front of the oven with your other hand. This procedure is not to be used during normal operation. If the electric door opener fails to operate, contact service.
The oven cannot be started and the temperature display blinks.	Make sure the door is properly closed with the handle rotated back into the recess at the corner of the door (refer to Fig. 4 on page 10).
Oven controls display is blank and inoperative.	Make sure the electrical power cord is plugged in and that the receptacle has power. If this does not correct the problem, contact service.
Temperature flashes and buzzer sounds while the temperature probe is in use.	Food ready to be cooked in the oven cannot be below 35°F (2°C).
Temperature display flashes the current oven temperature.	Make sure the door is closed and the handle is in the closed position (refer to Fig. 4, page 10).
Controls operate but oven will not work in Hot Air or Steam modes.	Make sure the door is closed and the handle is in the closed position (refer to Fig. 4, page 10). Steaming will not occur if the cavity temperature is above the set point temperature.
Controls operate but oven will not work in Steam mode.	Oven temperature is above the boiling temperature of water (212°F or less at higher elevations). Water supply valve is off. Open the water valve.

SERVICE ADJUSTMENTS

Buzzer loudness can be adjusted by your service technician.

SERVICE AND PARTS INFORMATION

To obtain service and parts information concerning this oven, contact the Vulcan Hart Service Agency in your area (refer to the listing supplied with the oven), or contact the Vulcan-Hart Service Department at the address or phone number shown on the front cover of this manual. Parts and service manuals are also available at WWW.VULCANHART.COM