

1.	INSTRUCTIONS FOR SAFE AND PROPER USE	27
2.	INSTALLATION	29
3.	DESCRIPTION OF CONTROLS	33
4.	USE OF THE OVEN	38
5.	AVAILABLE ACCESSORIES	39
6.	COOKING HINTS	40
7.	CLEANING AND MAINTENANCE	45
8.	ADDITIONAL MAINTENANCE	47



*INSTRUCTIONS FOR THE INSTALLER: these are intended for the **qualified technician** who must install the appliance, set it functioning and carry out an inspection test.*



INSTRUCTIONS FOR THE USER: these contain user advice, description of the controls and the correct procedures for cleaning and maintenance of the appliance.

1. INSTRUCTIONS FOR SAFE AND PROPER USE



THIS MANUAL IS AN INTEGRAL PART OF THE APPLIANCE AND THEREFORE MUST BE KEPT IN ITS ENTIRETY AND IN AN ACCESSIBLE PLACE FOR THE WHOLE WORKING LIFE OF THE OVEN. WE ADVISE CAREFUL READING OF THIS MANUAL AND ALL THE INSTRUCTIONS THEREIN BEFORE USING THE OVEN. INSTALLATION MUST BE CARRIED OUT BY QUALIFIED PERSONNEL IN ACCORDANCE WITH THE REGULATIONS IN FORCE. THIS APPLIANCE IS INTENDED FOR DOMESTIC USES AND CONFORMS TO CURRENT **REGULATIONS IN FORCE**. THE APPLIANCE HAS BEEN BUILT TO CARRY OUT THE FOLLOWING FUNCTIONS: **COOKING AND HEATING-UP OF FOOD**. ALL OTHER USES ARE CONSIDERED IMPROPER.

THE MANUFACTURER DECLINES ALL RESPONSIBILITY FOR IMPROPER USE.



DO NOT LEAVE THE PACKING IN THE HOME ENVIRONMENT. SEPARATE THE VARIOUS WASTE MATERIALS AND TAKE THEM TO THE NEAREST SPECIAL GARBAGE COLLECTION CENTRE.



IT IS OBLIGATORY FOR THE ELECTRICAL SYSTEM TO BE EARTHED ACCORDING TO THE METHODS REQUIRED BY SAFETY RULES.



WHEN LINKING UP TO MAINS BY PLUG AND SOCKET, MAKE SURE THAT BOTH ARE COMPATIBLE AND CONNECT BY MEANS OF A POWER CABLE COMPLYING WITH APPLICABLE REGULATIONS.

THE SOCKET MUST BE ACCESSIBLE AFTER THE APPLIANCE HAS BEEN BUILT IN.

NEVER UNPLUG BY PULLING ON THE CABLE.



DO NOT OBSTRUCT VENTILATION OUTLETS AND HEAT DISPERSAL SLITS.



IMMEDIATELY AFTER INSTALLATION CARRY OUT A BRIEF INSPECTION TEST OF THE OVEN, FOLLOWING THE INSTRUCTIONS BELOW. SHOULD THE APPLIANCE NOT FUNCTION, DISCONNECT IT FROM THE SUPPLY AND CALL THE NEAREST TECHNICAL ASSISTANCE CENTRE.

NEVER ATTEMPT TO REPAIR THE APPLIANCE.



ALWAYS CHECK THAT THE CONTROL KNOBS ARE IN THE "ZERO" (OFF) POSITION WHEN YOU FINISH USING THE OVEN.



NEVER PUT INFLAMMABLE OBJECTS IN THE OVEN: THEY COULD BE ACCIDENTALLY CATCH LIGHT AND CAUSE FIRES.



DURING USE THE APPLIANCE BECOMES VERY HOT. TAKE CARE NOT TO TOUCH THE HEATING ELEMENTS INSIDE THE OVEN.



THE I.D. PLATE WITH TECHNICAL DATA, REGISTRATION NUMBER AND BRAND NAME IS POSITIONED VISIBLY ON THE OVEN DOOR FRAME. **THE PLATE MUST NOT BE REMOVED.**



THE OVEN IS DESIGNED FOR USE BY ADULTS. DO NOT ALLOW CHILDREN TO GO NEAR OR PLAY WITH IT.



THIS APPLIANCE IS MARKED ACCORDING TO THE EUROPEAN DIRECTIVE 2002/96/EC ON WASTE ELECTRICAL AND ELECTRONIC EQUIPMENT (WEEE).

THIS GUIDELINE IS THE FRAME OF A EUROPEAN-WIDE VALIDITY OF RETURN AND RECYCLING ON WASTE ELECTRICAL AND ELECTRONIC EQUIPMENT.



BEFORE THE APPLIANCE IS PUT INTO OPERATION, ALL THE LABELS AND PROTECTIVE FILMS APPLIED INSIDE OR OUTSIDE MUST BE REMOVED.



The manufacturer declines all responsibility for damage to persons or things caused by non-observance of the above guidelines or by interference with any part of the appliance or by the use of non-original spares.



Instructions for the installer

GB-IE

2. INSTALLATION

2.1 Electrical connection



Check that the mains voltage and power cable ratings are as per the information provided on the label attached to the oven door frame.

This label must never be removed.



It is obligatory for the electrical system to be earthed according to the methods required by safety rules.



If a plug and socket connection is being used make sure that the plug and socket are compatible. Avoid use of adapters and shunts as these could cause overheating and risk of burns.



If a fixed connection is being used fit cable line with an omnipolar circuit breaker with a contact opening gap equal to or greater than **3 mm** in an easily accessible position in proximity to the oven.

2.1.1 Ovens with hob controls

In the ovens with hob controls the **power cable is not supplied**. Use a H05RR-F or H05RN-F rubber-sheathed cable making sure that it does not come into contact with any external metal parts of the oven when routing.

Remove rear cover by loosening relevant screws to gain access to the terminal strip. If necessary change jumper configuration as shown in the diagram and then connect wires making sure that the earth wire is at least 20 mm longer than the others. Secure power cable to oven by means of an appropriate fitting.

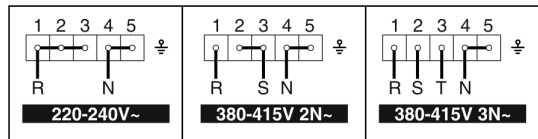
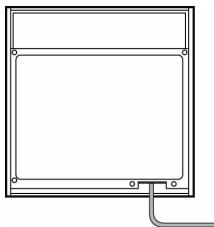

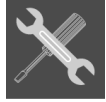

For operation on 230V~: use an H05RR-F / H05RN-F type three-core cable (3 x 4 mm²).

220-240V~

4 mm²

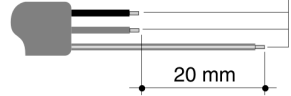

For operation on 380-415V2N~: use an H05RR-F / H05RN-F type four-core cable (4 x 2.5 mm²).

380-415V2N~

2,5 mm²

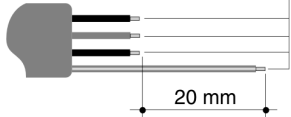

For operation on 380-415V3N~: use an H05RRF / H05RN-F type five-core cable (5 x 1.5 mm²).

380-415V3N~

1,5 mm²

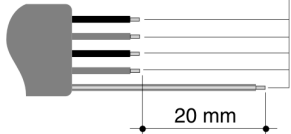

The cable end to be connected to the appliance must be provided with an earth wire (yellow-green) at least 20 mm longer.



The manufacturer declines all responsibility for damage to persons or things caused by non-observance of the above guidelines or by interference with any part of the appliance.



2.2 Installing the oven

The oven is designed for installation into any piece of furniture as long as it is heat-resistant. Proceed according to the dimensions shown in Figures 1, 2 and 3. For installing under a work top, follow the dimensions given in Figure 3. For installing under a work top beneath a hob with controls connected to the oven, ensure a minimum clearance from any side walls of at least 110 mm as shown in Figure 1.

For installing in a column, follow the dimensions given in Figure 2 allowing for a clearance of 80 to 90 mm at the top and sides of the column. Tighten the four screws (ref. **A**) inside the frame to secure (Fig. 1).

For installing beneath a separate hob, allow for a rear and bottom clearance as shown in Figure 1 (ref. **B**). See relevant instructions for fitting and securing the hob.

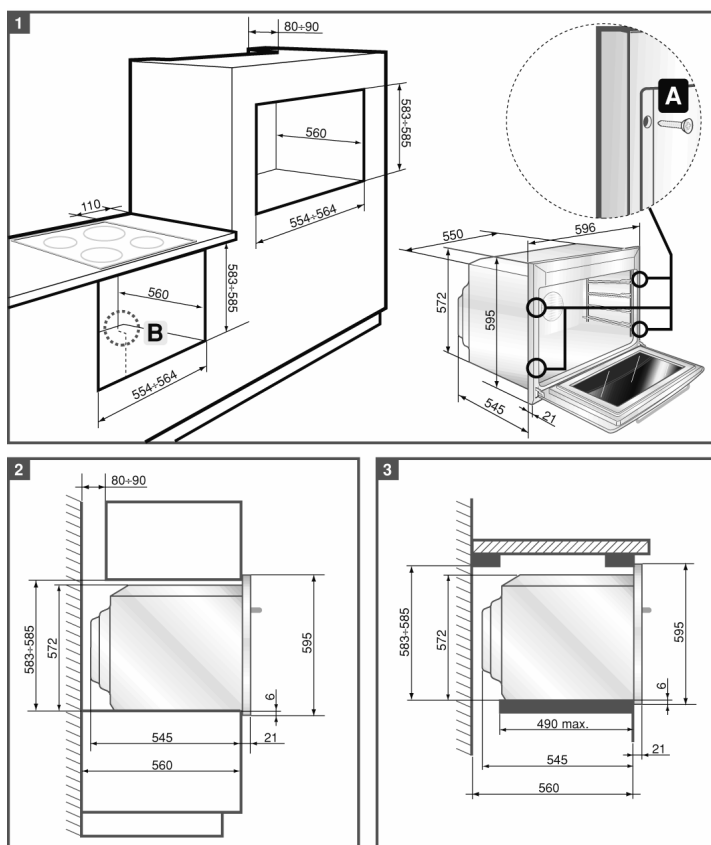

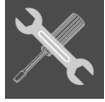

*Never use the oven door to lever the oven into place when fitting.
Avoid exerting too much pressure on the oven door when open.*

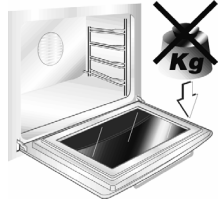

2.3 Connecting the hob to the oven

Once installed, the hob must be connected to the oven. Install the oven allowing enough room for the following operations to take place.

- Connect the earth wire (yellow-green) of the hob to the earth terminal **A** of the oven (see figure).
- Fit the hob connectors into the appropriate sockets in the top cover of the oven. Make sure that the colours and symbols of the connectors match those of the oven sockets.
- If the hob is equipped with a connector for the residual heat indicator, this must be fitted into the free socket on the right handside.

The oven can now be fully mounted into the cabinet; make sure that the power cable is properly routed and does not come into contact with parts which may become hot during operation.

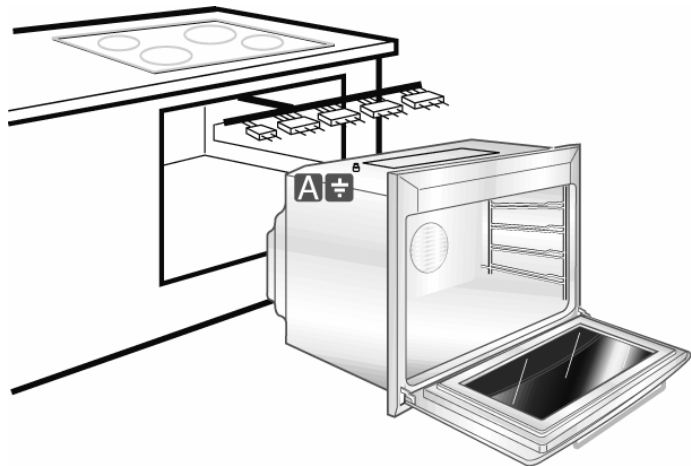



Instructions for the user



3. DESCRIPTION OF CONTROLS

3.1 Front control panel

All the oven controls are grouped together on the front panel.



FUNCTION CONTROL KNOB

Rotate the knob in either direction to select desired function from the following:

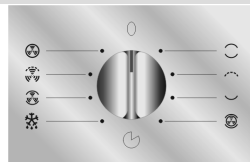

NO FUNCTION SET



UPPER AND LOWER HEATING ELEMENT



GRILL ELEMENT



LOWER HEATING ELEMENT



UPPER AND LOWER HEATING ELEMENT + VENTILATED HEATING ELEMENT



DEFROSTING



UPPER AND LOWER HEATING ELEMENT + VENTILATION



FULL GRILL ELEMENT + VENTILATION



VENTILATED HEATING ELEMENT

THERMOSTAT CONTROL KNOB

Cooking temperature is selected by turning the knob clockwise to the desired setting, between **50°** and **250°**C.

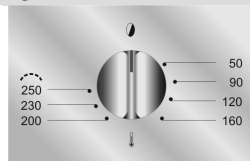

Instructions for the user



THERMOSTAT INDICATOR LIGHT (ORANGE)

When this light comes on, the oven is heating up.
When this light goes out, the preset heating temperature has been reached.
When the light flashes, the temperature inside the oven is steady.

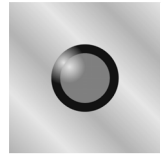

PILOT LIGHT (GREEN)

This light comes on when any of the oven elements is receiving power.

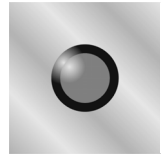









Instructions for the user

GB-IE

3.2 Electronic programmer



LIST OF FUNCTIONS

-  MINUTE-COUNTER KEY
-  COOKING TIME KEY
-  END-OF-COOKING KEY
-  MANUAL OPERATION KEY
-  TIME BACK KEY
-  TIME FORWARD KEY

3.2.1 Clock adjustment

When using the oven for the first time, or after a power failure, the display flashes regularly and indicates **0:00**. To stop flashing, press key  on the display. By pressing keys **+** or **-** each single press changes the time by 1 minute either up or down.

Press one of the two keys until the right time appears.



Before setting the programmer activate the desired function and temperature.

3.2.2 Semiautomatic cooking

Use this setting for automatic oven switch-off at the end of cooking time.

By pressing key , the display lights up, showing **0:00**; keep the key pressed and at the same time, press keys **+** or **-** to set the cooking time.

Instructions for the user



Release key to start the programmed cooking time count. The display will now show the right time together with symbols **A** and .



3.2.3 Automatic cooking

Use this setting to automatically start and stop the oven.

By pressing key , the display lights up showing **0:00**; keep the key pressed and at the same time, press keys **+** or **-** to set the cooking time.

By pressing key the sum of the right time + cooking time will appear; keep the key pressed and at the same time, press keys **+** or **-** to regulate the end of cooking time.

Release key to start the programmed count and the display will show the right time together with symbols **AUTO** and .



After setting, to see how much cooking time is left, press key ; to see end of cooking time, press key .

3.2.4 End of cooking

When cooking is over, the oven will automatically switch off and, at the same time, an intermittent alarm will sound. After switching off the alarm, the display will once again show the right time together with the symbol , indicating that the oven has returned to manual operation mode.

3.2.5 Adjusting alarm volume

The acoustic alarm has three different settings. These can be operated, while the alarm is sounding, by pressing key **-**.



Instructions for the user

GB-IE

3.2.6 Switching off the alarm

The alarm switches off automatically after seven minutes. It can be manually turned off by pressing key .









3.2.7 Minute-counter

The programmer can also be used as a simple minute counter.



The use of the minute-counter will not interrupt oven operation at the end of the set time.

By pressing key , the display shows ; keep the key pressed and at the same time press keys  or . By releasing the key , the programmed count starts and the symbols  and  appear on the monitor.





After programming the minute-counter, the display will show the right time. to display remaining time, press key .





Wrong settings are prevented logically (e.g., any conflict between end of cooking time and a longer time will not be accepted by the programmer).

3.2.8 Cancellation of set data

Once the programme has been set, keep the key of the function to be cancelled pressed, while at the same time  is reached by means of variation keys  or . Time cancellation will be considered as end-of-cooking time by the programmer.

3.2.9 Changing the set data

The cooking data entered can be changed at any time by keeping the function key pressed and at the same time adjusting the keys  or .



4. USE OF THE OVEN



Before using the oven make sure that the electronic programmer displays the  symbol (see "3.2.1 Clock adjustment").

4.1 Warnings and general advice

Before using the oven for the first time, pre-heat it to maximum temperature (250°C) long enough to burn any manufacturing oily residues which could give the food a bad taste.

In the models featuring an electronic programmer, a power failure causes the display to start flashing at regular intervals and the  symbol to appear. To re-adjust, see "3.2 Electronic programmer".



During cooking, do not cover the bottom of the oven with aluminium or tin foil and do not place pans or oven trays on it as this may damage the enamel coating. If you wish to use greaseproof paper, place it so that it will not interfere with the hot air circulation inside the oven.



To prevent any steam in the oven creating problems, open the door in two stages: half open (5 cm approx.) for 4-5 seconds and then fully open. To access food, always leave the door open as short a time as possible to prevent the temperature in the oven from falling and ruining the food.



4.2 Cooling system

The oven features cooling fan which switch on together with the oven.

Fan operation causes a normal flow of air which exits at the bottom part of the oven front which may continue for a brief period of time even after the oven has been turned off.

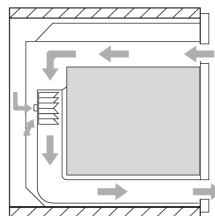

4.3 Oven light

On all models, it is switched on by turning the thermostat knob and the function selector knob to any function. On some models it also switches on when the oven door is opened.



Instructions for the user

GB-IE

5. AVAILABLE ACCESSORIES

The oven features **4 support** positions for shelves and pans of different height.



Some models do not feature all accessories.

Chrome shelf: useful for holding cooking vessels.



Grill mesh: for placing above grill pan to allow juices to drip into pan below .



Roasting/Grill pan: to be used for roasting or grilling.



Enamel tray: for baking cakes, pizza and oven desserts.



Roof liner/Grill guard: removing this simplifies cleaning procedures inside the oven.

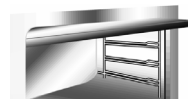

Chromium-plated handle: for removing hot shelves and pans from the oven. Be sure to wear oven gloves when in use.



Accessories available on request

Original accessories may be ordered from any Authorised Service Centre.



6. COOKING HINTS



In fan-assisted mode preheating should be carried out at 30/40°C above the cooking temperature. This considerably shortens cooking times and reduces power consumption, as well as giving better cooking results.



Keep the oven door closed during cooking

6.1 Traditional cooking (multifunction models)



FUNCTION SWITCH



THERMOSTAT SWITCH

50 ÷ 250°C



This traditional cooking method, in which heat comes from above and below, is suitable for cooking food on a single level. You have to pre-heat the oven until the set temperature is reached. Place the food in the oven only after the thermostat indicator light has turned off. very fatty meats may be put in when the oven is still cold. Put frozen meat in immediately, without waiting for it to thaw. The only precaution you need to take is to set the temperature about 20°C lower and cooking time about 1/4 longer than you would for fresh meat.

6.2 Fan cooking (multifunction models)



FUNCTION SWITCH



THERMOSTAT SWITCH

50 ÷ 250°C



This system is suitable for cooking on several levels, including different types of food (fish, meat etc.), without the tastes and smells mingling. Air circulation in the oven ensures a uniform distribution of heat.



Multiple cooking is possible as long as the cooking temperature of the different foods is the same.



Instructions for the user

GB-IE

6.3 Grill cooking

FUNCTION SWITCH	
THERMOSTAT SWITCH	



Permits rapid browning of foods. You are advised to place the pan in the highest position. When cooking small items for a short time the pan should be in the highest position. For larger items requiring longer cooking times, the pan should be lowered to avoid food being burned on top before being thoroughly cooked.

6.4 Fan grilling (multifunction models)

FUNCTION SWITCH	
THERMOSTAT SWITCH	



Ensures uniform heat distribution with greater heat penetration into the food. Food will be lightly browned on the outside and remain soft inside. **Keep the oven door closed during cooking. Heating up time must not exceed 60 minutes.**

Instructions for the user



6.5 Delicate cooking (in some models only)



FUNCTION SWITCH



THERMOSTAT SWITCH

50 ÷ 250°C



Ideal for pastries and cakes with a liquid surface and little sugar and moist desserts in moulds. Excellent results can also be achieved in completing cooking at the base and with dishes requiring heat in the lower area in particular. The pan is best inserted in the lowest position.

6.6 Defrosting (multifunction models)



FUNCTION SWITCH



THERMOSTAT SWITCH IN POSITION

0



The flow of air produced by the fan ensures quicker defrosting. The air circulating inside the oven is at room temperature.



The advantage of defrosting at room temperature is that it does not alter the taste and appearance of the food.



Instructions for the user

GB-IE

6.7 Recommended cooking table

Cooking times, especially meat, vary according to the thickness and quality of the food and to consumer taste.

TRADITIONAL COOKING



	SHELF POSITION (1 IS LOWEST)	TEMPERATURE (°C)	TIME IN MINUTES (*)
FIRST COURSES			
LASAGNE	2 - 3	210 - 230	30
OVEN-BAKED PASTA	2 - 3	210 - 230	40
MEAT			
ROAST VEAL	2	170 - 200	30 - 40 / KG.
ROAST BEEF	2	210 - 240	30 - 40 / KG.
ROAST PORK	2	170 - 200	30 - 40 / KG.
CHICKEN	2	170 - 200	45 - 60
DUCK	2	170 - 200	45 - 60
GOOSE - TURKEY	2	140 - 170	45 - 60
RABBIT	2	170 - 200	50 - 60
LEG OF LAMB	2	170 - 200	40 - 50
FISH	1 - 2	170 - 200	ACCORDING TO SIZE
PIZZA	1 - 2	210 - 240	40 - 45
DESSERTS			
SHORT PASTRY	1 - 2	170 - 200	15 - 20
CIAMBELLA	1 - 2	165	35 - 45
BRIOCHEs	1 - 2	170 - 200	40 - 45
FRUIT CAKE	1 - 2	170 - 200	20 - 30
PARADISE CAKE	1 - 2	170	60
APPLE CAKE	1 - 2	190	60
RICE CAKE	1 - 2	180	60

(*) = WITH PREHEATED OVEN

GRILLING



	SHELF POSITION (1 IS LOWEST)	TIME IN MINUTES	
		FIRST SIDE	SECOND SIDE
PORK CHOPS	4	7 - 9	5 - 7
FILLET OF PORK	3	9 - 11	5 - 9
FILLET OF BEEF	3	9 - 11	9 - 11
LIVER	4	2 - 3	2 - 3
VEAL ESCALOPEs	4	7 - 9	5 - 7
HALF CHICKEN	3	9 - 14	9 - 11
SAUSAGES	4	7 - 9	5 - 6
MEAT-BALLS	4	7 - 9	5 - 6
FISH FILLETS	4	5 - 6	3 - 4
TOAST	4	2 - 4	2 - 3



FAN COOKING



	SHELF POSITION (1 IS LOWEST)	TEMPERATURE (°C)	TIME IN MINUTES
FIRST COURSES			
LASAGNE	2	190 - 210	20 - 25
OVEN-BAKED PASTA	2	190 - 210	25 - 30
CREOLE RICE	2	190 - 220	20 - 25
MEAT			
ROAST VEAL	2	150 - 170	65 - 90
ROAST PORK	2	150 - 160	70 - 100
ROASTED BEEF	2	160 - 170	65 - 90
FILLET OF BEEF	2	160 - 180	35 - 45
ROAST LAMB	2	130 - 150	100 - 130
ROAST BEEF	2	170 - 180	40 - 45
ROAST CHICKEN	2	170	70 - 90
ROAST DUCK	2	160 - 170	100 - 160
ROAST TURKEY	2	150 - 160	160 - 240
ROAST RABBIT	2	150 - 160	80 - 100
ROAST HARE	2	160 - 170	30 - 50
ROAST PIGEON	2	140 - 170	15 - 25
FISH	2 - 3	150 - 170	ACCORDING TO SIZE
PIZZA	2 - 3	210 - 240	30 - 50
BREAD	2 - 3	190 - 210	40
TOAST	1 - 2	220 - 240	7
DESSERTS			
CIAMBELLA	2 - 3	150 - 160	35 - 45
FRUIT CAKE	2 - 3	150 - 160	40 - 50
BRIOCHES	2 - 3	150 - 160	40 - 60
SHORT PASTRY	2 - 3	150 - 160	25
RICE CAKE	2 - 3	150 - 160	65
APPLE CAKE	2 - 3	150 - 160	65
PARADISE CAKE	2 - 3	150 - 160	65



Instructions for the user

GB-IE

7. CLEANING AND MAINTENANCE



Before carrying out any maintenance, switch off the power supply to the machine.

7.1 Cleaning stainless steel



To keep stainless steel in good condition it should be cleaned regularly after use. Let it cool first.

7.1.1 Ordinary Daily Cleaning

To clean and preserve the stainless steel surfaces, always use **only** specific products that do not contain abrasives or chlorine-based acids.

How to use: pour the product on a damp cloth and wipe the surface, rinse thoroughly and dry with a soft cloth or leather.

7.1.2 Food stains or residues

Do not use metallic sponges or sharp scrapers: they will damage the surface.

Use normal non-abrasive products for steel, and a wooden or plastic tool if necessary.

Rinse thoroughly and dry with a soft cloth or leather.

Do not allow residues of sugary foods (such as jam) to set inside the oven. If left to set for too long, they might damage the enamel lining of the oven.



7.2 Cleaning of the oven (without self-cleaning panels)



For best oven upkeep clean regularly after having allowed to cool. Take out all removable parts.



①

②

③

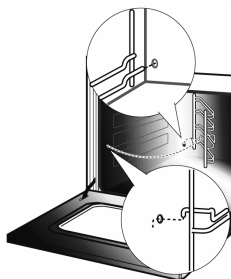



- Clean the oven grill and side guides with hot water and non-abrasive detergent. Rinse and dry.
- The oven should be operated at the maximum temperature for about 15/20 minutes after using specific products, to eliminate the residues deposited inside the oven.
- For easier cleaning, the door can be removed (see P. 8.2)

7.3 Self-cleaning liners (only on some models)

The oven is equipped with continuous self-cleaning enamelled liners. These liners make the oven easier to clean and ensure its efficiency over time.

7.3.1 Using the self-cleaning liners

Periodically, to prevent food residues and unpleasant smells from accumulating inside the oven, the appliance should be operated empty at temperatures of not less than 200°C for a time varying from 30 to 60 minutes, in order to allow the self-cleaning liners to oxidise the residues present; when the oven has cooled, these will then be removed with a damp sponge

7.3.2 Looking after the self-cleaning liners

The liners should not be cleaned with abrasive creams or ordinary detergents. Use a damp sponge only, so as not to damage the special characteristics of the enamel which coats the liners.

7.3.3 Assembling the self-cleaning liners

1. Remove all accessories from the oven;
2. Remove the side supports (fig.1);
3. Extract the side liners "F" and "G"(fig. 2);
4. Remove the back panel "A" after undoing the threaded ring-nut "C" (fig. 2).
5. Reassemble the panels, restoring them to their original position. Incorrect installation of the rear panel can lead to uneven cooking.

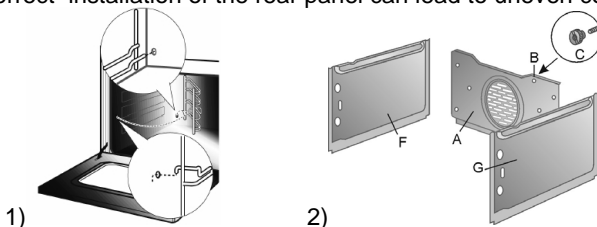

7.4 Door glass

The door glass should always be kept clean. Use absorbent kitchen paper to clean. In case of tough spots, clean with a damp sponge using regular detergent.



Instructions for the user

GB-IE

8. ADDITIONAL MAINTENANCE

The oven may require additional maintenance or replacement of parts subject to wear such as seals, bulbs, and so on. The following instructions describe how to carry out these minor maintenance operations.



Before any intervention, disconnect the power supply.

8.1 Replacement of light bulb

Remove the bulb protector **A** by turning anticlockwise and change bulb **B** (in the 8-function model with front glass panel change the halogen bulb **C**) with a similar one. Re-fit the bulb protector **A**.

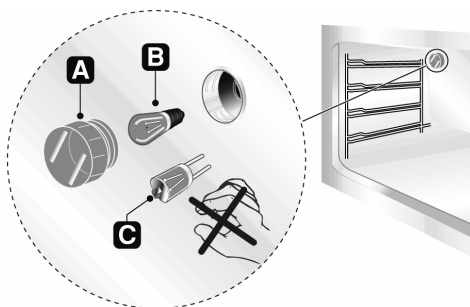

Only use oven bulbs (T 300°C).

8-functions model with glass front panel

The standard bulbs are halogen: **do not touch them directly with your fingers.** Use rubber glove to protect your hand.

Use only bulbs that are available at authorised service centres.



8.2 Removing the door

Raise levers on each hinge **A** to lock the hinges before attempting to remove the door. Hold the door on both sides with both hands near hinges **B**. Lift up the door forming an angle of about 45° and remove. To refit, slide the hinges **A** into slots in oven frame. Locate the grooves (figure C) over frame of oven in hinge cut out, lower the door and release the locking levers (figure B).

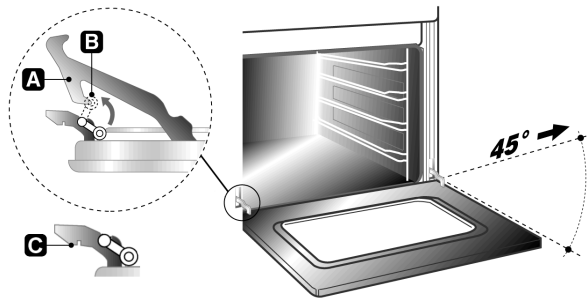

8.3 Oven door seal

To permit thorough cleaning of the oven, the seal may be removed. Before removing the seal, take off the door as described above. Once the door has been taken off, lift the tabs at the corners as shown in the figure.

After cleaning, refit the seal with the longer side horizontal and insert the tabs into the appropriate holes starting from the top ones.

