

# Contents

GB-IE

1. INSTRUCTIONS FOR USE .....	42
2. SAFETY INSTRUCTIONS .....	43
3. INSTRUCTIONS FOR DISPOSAL – OUR ENVIRONMENTAL CARE .....	44
4. GET TO KNOW YOUR OVEN.....	45
5. BEFORE INSTALLATION.....	45
6. AVAILABLE ACCESSORIES .....	46
7. USING THE OVEN .....	47
8. COOKING WITH THE OVEN.....	56
9. CLEANING AND MAINTENANCE .....	65
10. EXTRAORDINARY MAINTENANCE .....	69
11. INSTALLING THE APPLIANCE .....	76



**INSTRUCTIONS FOR THE USER:** these specify usage recommendations, and describe the commands and the correct cleaning and maintenance operations for the appliance.



**INSTRUCTIONS FOR THE INSTALLER:** these are intended for the qualified technician who will carry out the installation, operation and testing of the appliance.

## 1. INSTRUCTIONS FOR USE



THIS MANUAL IS AN INTEGRAL PART OF THE APPLIANCE. IT MUST BE KEPT IN ITS ENTIRETY AND IN AN ACCESSIBLE PLACE FOR THE WHOLE WORKING LIFE OF THE OVEN.

CAREFUL READING OF THIS MANUAL AND ALL THE INSTRUCTIONS THEREIN BEFORE USING THE APPLIANCE IS ESSENTIAL. INSTALLATION MUST BE CARRIED OUT BY QUALIFIED PERSONNEL IN ACCORDANCE WITH THE REGULATIONS IN FORCE. THIS APPLIANCE IS INTENDED FOR HOUSEHOLD USE AND COMPLIES WITH THE EEC DIRECTIVES CURRENTLY IN FORCE. THE APPLIANCE HAS BEEN BUILT TO CARRY OUT THE FOLLOWING FUNCTIONS: COOKING AND HEATING FOODS; ALL OTHER USES ARE TO BE CONSIDERED IMPROPER.

THE MANUFACTURER DECLINES ALL RESPONSIBILITY FOR IMPROPER USE.



DO NOT USE THIS APPLIANCE FOR HEATING ROOMS.



THIS APPLIANCE IS MARKED ACCORDING TO THE EUROPEAN DIRECTIVE 2002/96/CE ON WASTE ELECTRICAL AND ELECTRONIC EQUIPMENT – (WEEE).

THIS GUIDELINE IS THE FRAME OF A EUROPEAN-WIDE VALIDITY OF RETURN AND RECYCLING ON WASTE ELECTRICAL AND ELECTRONIC EQUIPMENT.



DO NOT OBSTRUCT VENTILATION OPENINGS AND HEAT DISPERSAL SLITS.



THE I.D. PLATE WITH TECHNICAL DATA, REGISTRATION NUMBER AND BRAND NAME IS POSITIONED VISIBLY ON THE OVEN DOOR FRAME. THE PLATE MUST NOT BE REMOVED.



DO NOT USE METALLIC SPONGES OR SHARP SCRAPERS: THEY WILL DAMAGE THE SURFACE.

USE ORDINARY NON-ABRASIVE PRODUCTS WITH THE AID OF WOODEN OR PLASTIC UTENSILS IF NECESSARY. RINSE THOROUGHLY AND DRY WITH A SOFT CLOTH OR CHAMOIS LEATHER.

DO NOT ALLOW RESIDUES OF SUGARY FOODS (SUCH AS JAM) TO SET INSIDE THE OVEN. IF LEFT TO SET FOR TOO LONG, THEY MIGHT DAMAGE THE ENAMEL LINING OF THE OVEN.



## 2. SAFETY INSTRUCTIONS



REFER TO THE INSTALLATION INSTRUCTIONS FOR THE SAFETY REGULATIONS FOR ELECTRIC OR GAS APPLIANCES AND VENTILATION FUNCTIONS.

IN YOUR INTERESTS AND FOR YOUR SAFETY IT HAS BEEN ESTABLISHED BY LAW THAT THE INSTALLATION AND SERVICING OF ALL ELECTRICAL APPLIANCES IS TO BE CARRIED OUT BY QUALIFIED PERSONNEL IN ACCORDANCE WITH THE REGULATIONS IN FORCE.

OUR REGULAR INSTALLERS GUARANTEE A SATISFACTORY JOB.

GAS OR ELECTRIC APPLIANCES MUST ALWAYS BE DISCONNECTED BY SUITABLY SKILLED PEOPLE.



THE PLUG TO BE CONNECTED TO THE POWER CORD AND ITS SOCKET MUST BE OF THE SAME TYPE AND CONFORM TO THE REGULATIONS IN FORCE.

THE SOCKET MUST BE ACCESSIBLE AFTER THE APPLIANCE IS BUILT IN. NEVER DISCONNECT THE PLUG BY PULLING ON THE POWER SUPPLY LEAD.



IT IS OBLIGATORY FOR ALL ELECTRICAL SYSTEMS TO BE GROUNDED ACCORDING TO THE METHODS REQUIRED BY SAFETY RULES.



IMMEDIATELY AFTER INSTALLATION CARRY OUT A BRIEF INSPECTION TEST, FOLLOWING THE INSTRUCTIONS BELOW. SHOULD THE APPLIANCE NOT FUNCTION, DISCONNECT IT FROM THE SUPPLY AND CALL THE NEAREST TECHNICAL ASSISTANCE CENTRE.

NEVER ATTEMPT TO REPAIR THE APPLIANCE.



NEVER PUT INFLAMMABLE OBJECTS IN THE OVEN: THEY COULD BE ACCIDENTALLY LIGHTED AND CAUSE FIRES.



DURING USE THE APPLIANCE BECOMES VERY HOT. TAKE CARE NOT TO TOUCH THE HEATING ELEMENTS INSIDE THE OVEN.



THE USE OF THIS APPLIANCE IS NOT PERMITTED TO PEOPLE (INCLUDING CHILDREN) OF REDUCED PHYSICAL AND MENTAL ABILITY, OR LACKING IN EXPERIENCE IN THE USE OF ELECTRICAL APPLIANCES, UNLESS THEY ARE SUPERVISED OR INSTRUCTED BY ADULTS OR PEOPLE RESPONSIBLE FOR THEIR SAFETY.



BEFORE THE APPLIANCE IS PUT INTO OPERATION, ALL THE PROTECTIVE FILMS APPLIED ON THE OUTSIDE MUST BE REMOVED.



**The manufacturer declines all responsibility for damage to persons or things caused by non-observance of the above prescriptions or by interference with any part of the appliance or by the use of non-original spares.**

## Instructions for disposal



### 3. INSTRUCTIONS FOR DISPOSAL – OUR ENVIRONMENTAL CARE

Our product's packing is made of non-polluting materials, therefore compatible with the environment and recyclable. Please help by disposing of the packing correctly. Find the addresses of collection, recycling and disposal centres from your retailer or from the competent local organisations.

Do not throw the packing or any part of it away. They can constitute a suffocation hazard for children, especially the plastic bags.

Your old appliance also needs to be disposed of correctly.

**Important:** hand over your appliance to the local agency authorised for the collection of electrical appliances no longer in use. Correct disposal means intelligent recycling of valuable materials.

Before disposing of your old appliance remove the door and leave the racks in their normal working positions so that children cannot get stuck in the oven compartment whilst playing. It is also necessary to cut the electric power cord and remove it along with the plug.



**DO NOT DISCARD PACKING IN THE HOME ENVIRONMENT. SEPARATE THE VARIOUS WASTE MATERIALS AND TAKE THEM TO THE NEAREST SPECIAL GARBAGE COLLECTION CENTRE.**



## Instructions for the user

GB-IE

### 4. GET TO KNOW YOUR OVEN

MULTIFUNCTION



- 1** Control panel
- 2** Oven light
- 3** Oven fan
- 4** Shelf and tray runners
- 5** Temperature sensor
- 6** Roof liner

PYROLYTIC



### 5. BEFORE INSTALLATION



In order to remove all manufacturing residues, it is recommended to clean the inside of the appliance. For further information on cleaning see paragraph "9. CLEANING AND MAINTENANCE".



Before using the oven for the first time, pre-heat it to maximum temperature long enough to burn any manufacturing oily residues which could give the food a bad taste. The Turbo function is recommended for this purpose .



## 6. AVAILABLE ACCESSORIES

**Grill:** useful for holding cooking containers.



**Tray grid:** for placing on top of a tray for cooking foods which may drip.

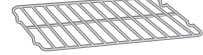

**Oven tray:** useful for collecting fat from foods placed on the grid above.

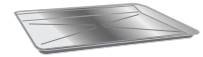

**Baking tray (on some models only):** for baking cakes, pizza and oven desserts.



**Rotisserie frame (on some models only):** supports the rotisserie rod (see page 64 for instructions for use).



**Chromium-plated gripper (on some models only):** useful for removing hot shelves and trays.



**Rotisserie rod (on some models only)** useful for cooking chicken and all foods which require uniform cooking over their entire surface.  
(see page 64 for instructions for use)



**Roof liner:** remove it to simplify cleaning inside the oven.

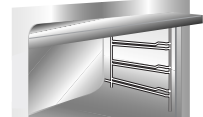

The oven accessories intended to come into contact with food are made of materials that comply with the provisions of Directive 89/109/EEC, dated 21/12/88 and of Decree Law 108, dated 25/01/92.



Accessories available on request:

Original supplied and optional accessories may be ordered from any Authorised Service Centre.



# Instructions for the user

GB-IE

## 7. USING THE OVEN

### 7.1 General Description

#### 7.1.1 Oven racks

The oven features **4 runners** for positioning trays and grills at different heights. The insertions heights are numbered from the bottom upwards (see figure).



#### 7.1.2 Cooling system

The appliance is equipped with a cooling system which comes into operation as soon as a cooking function starts. The fan cause a steady outflow of air from above the door which may continue for a brief period of time even after the oven has been turned off.

#### 7.1.3 Inside light

The oven light comes on when the door is opened or any function is selected, except for **ECO P** and **P** (where present).

### 7.2 Warnings and general advice for usage



All cooking operations must be carried out with the door closed.



During cooking, do not cover the bottom of the oven with aluminium or tin foil and do not place pans or oven trays on it as these may damage the enamel coating. If you wish to use greaseproof paper, place it so that it will not interfere with the hot air circulation inside the oven.

To prevent any steam in the oven creating problems, open the door in two stages: half open (5 cm approx.) for 4-5 seconds and then fully open. To access food, always leave the door open as short a time as possible to prevent the temperature in the oven from falling and ruining the food.



To prevent excessive amounts of condensation from forming on the internal glass, food should not be left inside the oven for too long after cooking.

# Instructions for the user



## 7.3 Description of the controls on the front panel

All the appliance's control and monitoring devices are placed together on the front panel. The symbols used are described in the table below.



### FUNCTIONS AND SYMBOLS SHOWN:



**1**  
PT1

**Functions Thermostat Knob** allows you to set the time, select the cooking temperature and duration and program the cooking start and end times.



**3**  
PT2

**Functions ON-OFF Knob** allows access to the oven's three operating modes, and is also used to select a cooking function or cooking program (see paragraph "7.4 Operating modes").

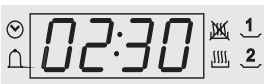

**2** DSP1

**Display current time** This display shows the current time or the cooking duration.  
**programmed cooking procedures**

The following symbols coming on indicate:



*Clock:* adjusting the cooking time



*Bell:* minute minder activated.



*Delayed start:* setting the cooking time with a delayed start.



*Cooking duration:* setting the cooking time.



Selectable functions (pyrolytic mod.)



Selectable functions (multifunction mod.)







## Instructions for the user



(pyrolytic mod.)

**Temperature display** This display shows the preset temperature for the function required, or the temperature set by the user.



(multifunction mod.)

The following symbols coming on indicate:



*Temperature inside the oven:* the oven is heating up.



*Child lock-out function:* Child lock-out function mode ON (see “Secondary menu” on page 55).



*Showroom indicator light* (on multifunction model only): showroom mode ON (see “Secondary menu” on page 55).



*Door interlock indicator light* (on pyrolytic model only): Comes on when the cleaning cycle is used, to indicate the door has been locked.



Symbols not mentioned in these pages but present on the product belong to appliances of a different range.

# Instructions for the user



## 7.4 Operating modes

This appliance is programmed to provide 3 operating settings, which can be modified by pressing PT2.

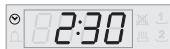

**STAND-BY setting:** with DSP1 on and showing the current time (activated as soon as the current time has been confirmed).



**ON setting:** from the stand-by setting, press PT2 once. All the displays and knobs light up.



**OFF setting:** from the ON position, keep PT2 pressed down until it switches off. Only the  symbol on DSP1 remains on.

## 7.5 First use

At first use, or after a power failure, the oven's left hand-display, DSP1, will show a flashing **00:00** symbol. To start any cooking operation, the current time must be set.

### 7.5.1 Setting the current time

Adjusting the current time:

- turn PT1 to the right and left to increase or decrease the hours. (*If the knob is held in one direction the time changes faster*).
- when PT1 is released, after a few seconds the display will stabilise and only the two dots that separate the hours from the minutes will flash, indicating it is working properly. (*The display will also show the symbol *).



It might become necessary to change the current time, for example at the switch from summer to winter time. Starting from the stand-by setting, (see paragraph "7.4 Operating modes"):

- hold down PT1 for a few seconds until the symbol  stops flashing.
- repeat the operations described in paragraph "7.5.1 Setting the current time".

## 7.6 Selecting a function

In the ON state only, a cooking function can be selected by simply turning PT2 to the right or left. The function selected will change colour to red on the display. After the selection, the preset cooking temperature will be displayed on DSP2.



## Instructions for the user

GB-IE

### 7.6.1 Cooking with preset temperature

After selection of the function required, the oven will start the cooking procedure at the preset temperature and the symbol will come on . Cooking itself is preceded by a preheating stage, which allows the oven to heat to the cooking temperature more quickly. The symbol flashes on DSP2 to indicate that this stage is in progress. When the preheating stage is over, the symbol will remain constantly on and a buzzer will sound to indicate that the food can be placed inside the oven.



On the pyrolytic models, the special defrosting and proving functions are together in the same symbol . Set the temperature to choose the function: thawing (30°C) or proving (40°C). On the multifunction models, it is not possible to vary the temperature in the defrosting and proving functions.

### 7.6.2 Changing the preset temperature

The temperature preset for each function can be changed to suit the user's requirements.

At any time while cooking is in progress, turn PT1 in either direction to increase or decrease the cooking temperature by 5 degrees at a time. (PT1 can also be held in the left or right position to increase or decrease the setting more quickly.)

### 7.6.3 Using the minute minder

Press PT1 once (either in the STAND-BY or ON mode). The display will show the figures (constantly on) and the symbol (flashing). Turn PT1 to set the minutes of cooking (from 00:01 to 04:00:00). A few seconds after the required duration is set, the symbol will stop flashing and stay on constantly; the countdown will start from that moment. Now select the cooking function required and wait for the buzzer to sound, indicating that the cooking time is over.

Press PT1 once to switch off the buzzer; extended cooking time can be set by turning PT1.



If the minute minder was set in STAND-BY mode, when the oven is activated in ON mode (selection of a cooking operation), the counter is reset to zero.



Warning: the minute minder does not stop the cooking process. It only warns the user that the preset number of minutes have passed. To switch the oven off, press PT2.

### Modifying the data set

After setting the countdown, press PT1 once. The symbol starts flashing; turn PT1 to change the set duration. A few seconds after the last change, the symbol will stop flashing, and the countdown will restart from the new value.

## Instructions for the user





### 7.7 Programmed cooking procedures

#### 7.7.1 Semiautomatic cooking



Semiautomatic cooking is the function which allows a cooking operation to be started and then ended after a specific length of time set by the user.

Select a function (see paragraph “7.6 Selecting a function”) and press PT1 twice. The display will show the **00:00** figures and the  symbol (flashing).



Turn PT1 to the right or left to set the minutes of cooking (from 00:01 to 23:59). A few seconds after the required duration is set, the  symbol will stop flashing, and semiautomatic cooking will start from that moment. At the end, the word STOP will appear on DSP1, cooking will stop and a buzzer will sound; press PT1 to deactivate it.



If you wish to continue cooking beyond the set time, press PT1 again. The oven will restart normal operation with the cooking settings selected previously. PT2 has to be pressed to switch the oven off completely.

#### Modifying the data set

Once semiautomatic cooking has started, its duration can be changed.

When the  symbol is steady and cooking is in progress, press PT1 once. The  symbol starts flashing and PT1 can be turned to change the set duration. A few seconds after the last change, the  symbol will stop flashing, and semiautomatic cooking will restart from the new value.

To change the preset temperature, wait for the  symbol to become steady and turn PT1 to the right or left to increase or decrease the cooking temperature.



## Instructions for the user

GB-IE

### 7.7.2 Automatic cooking



Automatic cooking is the function which allows a cooking operation to be started at a set time and then ended after a specific length of time set by the user.

Select a cooking function, set the cooking temperature required or leave the preset temperature (see paragraph “7.6 Selecting a function”) and press PT1 twice. The display will show the **00:00** figures and the  symbol (flashing).

Turn PT1 to the right or left to set the minutes of cooking (from 00:01 to 23:59).





For safety reasons, when setting automatic cooking the user must first program a cooking duration and then set the cooking start time. It is not possible to set the cooking start time only, without setting the cooking duration.

After setting the duration, press PT1 once.

The  symbol and the current time will appear on the display.

Turning PT1 to the right increases the time, allowing the **cooking start time required to be set**.

A few seconds after the required duration is set, the  and  symbols will stop flashing, and the oven will start to wait for the starting time set. At the end, the word STOP will appear on DSP1, cooking will stop and a buzzer will sound; press PT1 once to deactivate it.



## Instructions for the user





If you wish to continue cooking beyond the set time, press PT1 again. The oven will restart normal operation with the temperature settings selected previously. PT2 has to be pressed to switch the oven off completely.



### Modifying the data set

Once automatic cooking has started, its duration can be changed.



When the  and  symbols are steady and cooking is in progress, or the oven is in stand-by status waiting for cooking to start, press PT1 once.

The  symbol starts flashing and PT1 can be turned to change the set duration.

Press PT1 again; the  symbol goes out, the  symbol will start to flash, and the cooking start time will be displayed on DSP1. The cooking start time can be increased or decreased by turning PT1.

A few seconds after the last change, the  and  symbols will appear (in steady mode) on DSP1 and automatic cooking will restart with the new settings.



Once cooking has been programmed, before it starts, the function symbol will remain on, as will the symbols , .



## Instructions for the user

GB-IE

### 7.8 Secondary menu

This appliance also has a concealed "secondary menu" allowing the user to:

- 1 Activate or deactivate the child safety device 
- 2 Activate or deactivate the Showroom mode (which disables all the heating elements so that only the control panel works).
- 3 Activate or deactivate the mode which limits the maximum power absorption to 2300 W.

In OFF status (see "7.4 Operating modes") hold down **PT1** for at least 2 seconds to display the secondary menu. Turning **PT1** to the right or left changes the setting status (**ON** / **OFF**).

Press **PT1** to move on to setting of the next function.



**Child lock-out mode:** activating this mode after two minutes of operation without any intervention from the user the controls will automatically be locked, indicated by the coming on of the symbol . To disconnect the temporary lock during cooking, hold down PT1 for at least 5 seconds. Two minutes after the last setting the lock will become active again.



If a knob is turned, "bloc" appears for 2 seconds.



**Showroom mode:** (only for exhibitors) activating this mode disables all the heating elements so that only the control panel works (some models display the symbol ). To use the oven normally, set this mode to OFF.



**2300W power mode:** activating this mode the maximum power consumption of the oven during cooking will be 2300W.



## 8. COOKING WITH THE OVEN

**ECO:**  
 Using the grill and the bottom heating element plus the fan is particularly suitable for cooking small quantities of food, as it provides low energy consumption.



**STATIC:**  
 As the heat comes from above and below at the same time, this system is particularly suitable for certain types of food. Traditional cooking, also known as static or thermal radiation cooking, is suitable for cooking just one dish at a time. Perfect for all types of roasts, bread, and tarts and in any case particularly suitable for fatty meats such as goose and duck.

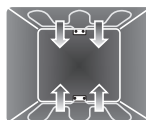

**GRILL:**  
 the heat coming from the grill element gives perfect grilling results above all for thin and medium thickness meat and in combination with the rotisserie (where fitted) allows to give the food an even browning at the end of the cooking. Perfect for sausages, ribs and bacon. This function allows to grill large quantities of food, particularly meat, evenly.

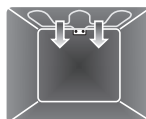

**ROTISSERIE GRILL:**  
 (pyrolytic mod. only)

The rotisserie functions in combination with the grill element, browning food perfectly.

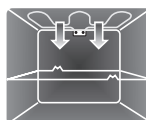

**BOTTOM:**  
 (multifunction mod. only)

the heat coming just from the bottom allows to complete the cooking of foods that require a longer basic cooking time, without affecting their browning. Perfect for cakes, pies, tarts and pizzas.

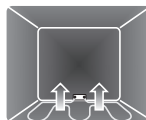





## Instructions for the user

GB-IE



### **BOTTOM + CIRCULAR VENTILATED:** (multifunction mod. only)

Ventilated cooking is combined with the heat coming from the bottom, at the same giving time slight browning. Perfect for any type of food.



### **VENTILATED STATIC:**

The operation of the fan, combined with traditional cooking, ensures uniform cooking even with complex recipes. Perfect for biscuits and cakes, even when simultaneously cooked on several levels.



### **VENTILATED GRILL:**

The air produced by the fan softens the strong heatwave generated by the grill, giving perfect grilling even on very thick foods. Perfect for large cuts of meat (e.g. shin of pork).

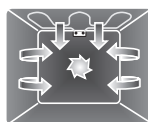

### **VENTILATED BOTTOM:**

The combination of the fan with just the bottom heating element allows cooking to be completed more rapidly. This system is recommended for sterilising or for finishing off the cooking of foods already well-cooked on the surface, but not inside, which therefore need a little more heat. Perfect for any type of food.



### **CIRCULAR:**

The combination of the fan and the circular element (incorporated in the rear of the oven) allows to cook different foods on several levels, as long as they need the same temperatures and cooking time. Air circulation ensures instant and uniform distribution of heat. It will be possible, for instance, to cook fish, vegetables and biscuits simultaneously with any smells and flavours mixing.

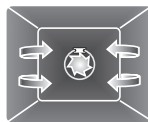

## Instructions for the user



### TURBO

The combination of ventilated cooking and traditional cooking allows to cook different foods on several levels extremely quickly and efficiently. Perfect for large volumes that call for intense cooking.



### THAWING:

Rapid thawing is helped by switching on the fan provided and the top heating element that ensure uniform distribution of low temperature air inside the oven.



In the pyrolytic models this function integrates the proving. The choice to thaw or to prove depends on the temperature selected. Set the temperature to choose the function: thawing (30°C) or proving (40°C).



### PROVING:

(multifunction mod. only)

The proving helped by the heat coming from the top allows all types of dough to be proved, guaranteeing perfect results quickly.

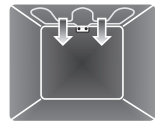



# Instructions for the user



## 8.1 COOKING HINTS AND TIPS



### HINTS ON USING THE ACCESSORIES:

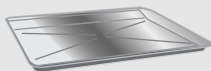

- Use only original SMEG trays.
- When the tray is in the oven, the handle must be facing the oven door.
- Push the trays right inside the oven.

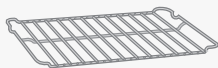

- Use only original SMEG racks.
- When the rack is in the oven, the contoured part must be facing downwards.
- Push the racks right inside the oven.



- Use only original racks.
- Push the racks right inside the oven.

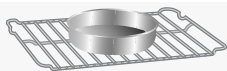

- For best cooking results, we recommend placing kitchenware in the centre of the rack.

### GENERAL HINTS:



- **We recommend preheating the oven before putting the food in.** Do not place the foods inside the oven until the degrees  symbol on the display stops flashing and the beep has sounded to confirm that the set temperature has been reached.

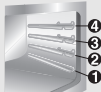

- For cooking on several levels, we recommend using a ventilated function to achieve uniform cooking at all heights.



- In general, it is not possible to shorten the cooking times by increasing the temperature (the food could be well-cooked on the outside and undercooked on the inside).
- During the cooking of desserts and vegetables, dripping from the bottom of the door could occur. This is a natural physical phenomenon which mainly occurs when the food is placed in the oven before preheating. To avoid this, open the door a couple of times during the cooking taking great care.



## COOKING HINTS FOR MEAT:



- Cooking times, especially meat, vary according to the thickness and quality of the food and to consumer taste.
- To save energy when roasting, we recommend putting the food in the cold oven.
- We recommend using a meat thermometer for meat when roasting it. Alternatively, simply press on the roast with a spoon: if it is hard it is ready, if not, it needs another few minutes cooking.

## COOKING HINTS FOR DESSERTS AND BISCUITS:



- Use dark metal moulds for desserts: they help to absorb the heat better.
- The temperature and the cooking duration depend on the quality and consistency of the dough.
- The tables indicate the temperature ranges. Initially, try with the lowest value (the lower temperature gives a more even browning); if the dessert does not come out well, increase the temperature on the following occasions.
- Check whether the dessert is cooked right through: About 10 minutes before the end of cooking, stick a toothpick into the highest point in the dessert. If the dough does not stick to the toothpick, the dessert is cooked.
- If the dessert goes flat when it comes out of the oven, on the next occasion reduce the set temperature by about 10 °C selecting a longer cooking time if necessary.



## Instructions for the user

GB-IE

### HINTS FOR THAWING AND PROVING:



- We recommend positioning frozen foods in a lidless container on the first runner of the oven.
- The food must be thawed without its wrapping.
- Lay out the foodstuffs to be thawed evenly, not overlapping.
- When thawing meat, we recommend using a rack positioned on the second runner with the food on it and a tray positioned on the first runner. In this way, the liquid from the thawing food drains away from the food.
- The most delicate parts can be covered with aluminium foil.
- For successful proving, a container of water should be placed in the bottom of the oven.
- During proving it is recommended to cover the food with a damp canvas.



## 8.2 Cooking tables:



The times indicated in the following tables do not include the preheating times. Always make sure to pre-heat and to load the oven when the  stays steady on.

	FUNCTION	LEVEL FROM BELOW	TEMPERATURE °C	TIME IN MINUTES		
<b>FIRST COURSES</b>						
LASAGNE		Static	1	220 - 230	50 - 60	
OVEN-BAKED PASTA		Static	1	220 - 230	40	
<b>MEAT</b>						
ROAST VEAL		Ventilated static	2	180 - 190	70 - 80	
LOIN OF PORK		Ventilated static	2	180 - 190	70 - 80	
SHOULDER OF PORK		Turbo	2	180 - 190	90 - 100	
ROAST RABBIT		Circular	2	180 - 190	70 - 80	
TURKEY BREAST		Ventilated static	2	180 - 190	110 - 120	
ROAST NECK OF PORK		Turbo	2	180 - 190	190 - 210	
ROAST CHICKEN		Turbo	2	180 - 190	60 - 70	
<b>GRILLED MEATS</b>						
					<b>FIRST SURFACE</b>	<b>SECOND SURFACE</b>
PORK CHOPS		Ventilated grill	4	300	7 - 9	5 - 7
FILLET OF PORK		Grill	3	300	9 - 11	5 - 9
FILLET OF BEEF		Grill	3	300	9 - 11	9 - 11
LIVER		Ventilated grill	4	300	2 - 3	2 - 3
SAUSAGES		Ventilated grill	3	300	7 - 9	5 - 6
MEAT-BALLS		Grill	3	300	7 - 9	5 - 6



# Instructions for the user



<b>ROTISSERIE MEATS</b>					
CHICKEN		Rotisserie grill	On a rotisserie rod	250 - 280	60 - 70
<b>FISH</b>					
SALMON TROUT		Bottom – ventilated circular	2	150 - 160	35 - 40
<b>PIZZA</b>					
		Ventilated static	1	250 - 280	6 - 10
<b>BREAD</b>					
		Circular	2	190 - 200	25 - 30
<b>MUFFINS</b>					
		Turbo	2	180 - 190	15 - 20
<b>DESSERTS</b>					
DOUGHNUT		Ventilated static	2	160	55 - 60
FRUIT TART		Ventilated static	2	160	30 - 35
SHORT PASTRY		Bottom + ventilated circular	2	160 - 170	20 - 25
JAM TARTS		Turbo	2	160	20 - 25
PARADISE CAKE		Ventilated static	2	160	55 - 60
ECLAIR		Turbo	2	150 - 160	40 - 50
LIGHT SPONGE CAKE		Circular	2	150 - 160	45 - 50
RICE PUDDING		Turbo	2	160	40 - 50
CROISSANTS		Circular	2	160	25 - 30



## 8.3 Using other functions



The following tables indicate how to use the functions for thawing, proving and cooking with the rotisserie rod.

FUNCTION	LEVEL FROM BELOW	TEMPERATURE °C	TIME IN MINUTES
	1	30	Depending on the quantity.
	1	40	
<b>ROTISSERIE COOKING (ON PYROLYTIC MODELS ONLY)</b>			

Prepare the rotisserie rod with the food, tightening the screws **A** of the prongs. Fit the frame **B** onto the second runners from the bottom. Remove the handle **D** and position the rotisserie rod so that the pulley **E** is still in the guides on the frame **B**. Push the frame **B** fully in until the tip of the rotisserie rod enters the hole **C** on the rear wall of the oven. Place a basin **F** on the bottom shelf and pour a little water into it to prevent smoke from forming.

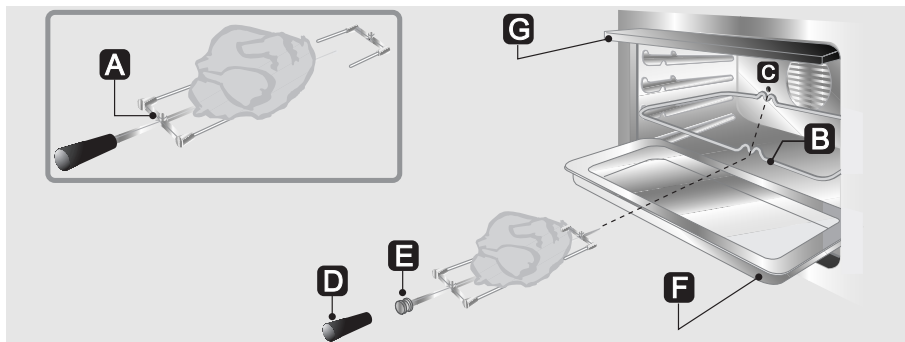





## Instructions for the user

GB-IE

### 9. **CLEANING AND MAINTENANCE**



Before performing any operations requiring access to powered parts, switch off the power supply to the appliance.



Do not use a steam jet for cleaning the inside of the oven.

#### 9.1 **Cleaning stainless steel**

To keep stainless steel in good condition it should be cleaned regularly after use. Let it cool first..

#### 9.2 **Ordinary daily cleaning**

To clean and preserve the stainless steel surfaces, always use **only** specific products that do not contain abrasives or chlorine-based acids.

**How to use:** pour the product on a damp cloth and wipe the surface, rinse thoroughly and dry with a soft cloth or deerskin.

#### 9.3 **Food stains or residues**

Do not use metallic sponges or sharp scrapers: they will damage the surface.

Use normal non-abrasive products and a wooden or plastic tool if necessary. Rinse thoroughly and dry with a soft cloth or deerskin.

Do not allow residues of sugary foods (such as jam) to set inside the oven. If left to set for too long, they might damage the enamel lining of the oven..



## Instructions for the user



### 9.4 Cleaning the inside of the oven

For best oven upkeep clean regularly after having allowed to cool. Take out all removable parts.

- Clean the oven grill and side guides with hot water and non-abrasive detergent. Rinse and dry.
- For easier cleaning, the door can be removed (see paragraph “10.2 Removing the door”).

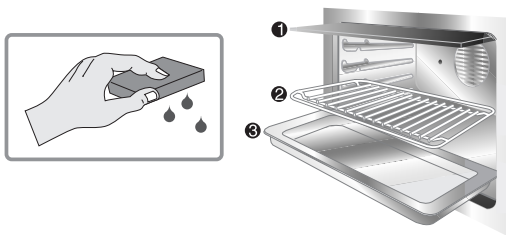

The oven should be operated at the maximum heat setting for 15/20 minutes after use of specific products, to burn off the residues left inside the oven.

### 9.5 Cleaning the door glazing

The glass in the door should always be kept thoroughly clean. Use absorbent kitchen roll; remove stubborn dirt with a damp sponge and ordinary detergent.



Do not use abrasive or corrosive cleaners for cleaning the door glazing. (e.g., powder products, oven-cleaner sprays, stain removers and metal scouring pads).

Do not use rough or abrasive materials or sharp metal scrapers to clean the oven's glass doors since they may scratch the surface and cause the glass to shatter.



## Instructions for the user

GB-IE

### 9.6 Pyrolysis: automatic oven cleaning (on some models only)

P

Pyrolysis is an automatic high-temperature cleaning procedure which causes dirt to dissolve. Thanks to this process, it is possible to clean the inside of the oven with great ease.



During the first automatic cleaning cycle unpleasant smells may occur due to the normal evaporation of oily manufacturing substances. This is an absolutely normal phenomenon which disappears after the first cleaning cycle.



Before starting the automatic cleaning cycle, make sure that the oven does not contain any foods or large spills from previous cooking operations inside.



During the pyrolysis cycle a door interlock device makes it impossible to open the door.



**IF THE OVEN IS INSTALLED UNDERNEATH A HOB, MAKE SURE THAT THE BURNERS OR ELECTRIC PLATES REMAIN OFF DURING THE AUTOMATIC CLEANING CYCLE.**

#### 9.6.1 Before starting the automatic cleaning cycle

Pyrolysis may be carried out at any time of the day or night (if you wish to benefit from the lower cost of electricity overnight).

Before proceeding, check the following:

- **only the baking tray, the oven tray or the roof liner may be left inside the oven** since they will withstand the high temperatures of the pyrolysis process; all the other accessories must be removed from inside the oven.
- make sure that the oven door is firmly closed.

When setting the cleaning cycle duration, refer to the chart below:

CLEANING DURATION	LIGHT DIRT	MEDIUM DIRT	HEAVY DIRT
	90 MIN.	135 MIN.	180 MIN.



During the automatic cleaning cycle the fans make more noise because they are running at higher speed. This is an absolutely normal function, intended to provide more effective heat dispersal. At the end of the pyrolysis process, the fans continue to run automatically for long enough to prevent overheating of the sides of the cabinet and the front of the oven.

## Instructions for the user



### 9.6.2 Setting the cleaning cycle

Use PT2 to select one of the two pyrolysis functions ( **P** and **ECO P** ) with the oven in ON status.

To start the cleaning (Pyrolysis) cycle, press knob PT1 twice to set its duration (  ).

Turn knob PT1 to the right or left to increase or decrease the cycle duration between a minimum of 1h 30m and a maximum of 3h 00m.

(Except for the **ECO P** function where the cycle duration is fixed at 1h 30m).



The message "Pyro" will appear on DSP1 to indicate that the oven is performing the cleaning cycle.



The time remaining to the end of the cleaning cycle will be shown on DSP1.



Two minutes after the cleaning cycle (Pyrolysis) starts an interlock device which prevents opening the door.

The  symbol illuminates on DSP2 to indicate that this interlock device has been activated.

At the end of the cleaning cycle the interlock device will remain active until the temperature inside the oven has reached a safety threshold. When the oven has cooled down, collect the residues from automatic cleaning with a damp micro-fibre cloth.

**To select a cleaning cycle with delayed start**, after setting the duration press PT1 once. The  symbol and the current time will appear on the display.

Turning PT1 to the right increases the time, allowing the cooking start time required to be set.

A few seconds after the required duration is set, the  and  symbols stay on, and the oven will start to wait for the starting time set for the cleaning cycle.



It is not possible to select any functions once the door interlock has been activated. Wait for the  symbol to go out.



## Instructions for the user

GB-IE

### 10. EXTRAORDINARY MAINTENANCE

The oven may require extraordinary maintenance or replacement of parts subject to wear such as seals, bulbs, and so on. The following instructions describe how to carry out these minor maintenance operations.



Before any intervention that requires access to live parts, disconnect the power supply of the appliance.

#### 10.1 Changing the light bulb

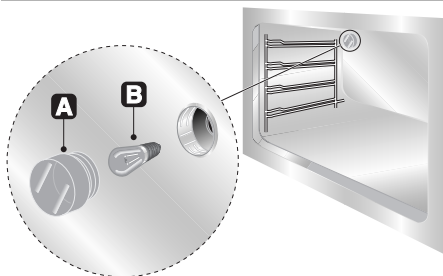

Remove the bulb protector A by turning it anticlockwise and replace bulb B with a similar one (25 W). Re-fit the bulb protector A.



Use only oven bulbs (T 500°C) (only for pyrolytic models).  
Use only oven bulbs (T 300°C) (only for multifunction models).

#### 10.2 Removing the door

##### 10.2.1 With moveable levers

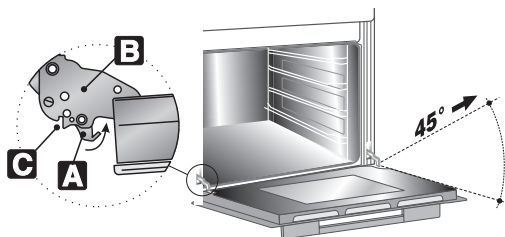

With the door completely open, lift the levers **A** of the two hinges until they touch the hinges **B** and take hold of the two sides of the door with both hands close to the hinges themselves.

Raise the door to an angle of about 45° and remove it. If the hinges have not locked, repeat the operation, raising the levers A and keeping the door slightly raised. To reassemble, fit the hinges **B** into their grooves, then lower the door into place, ensuring that it remains fitted into the grooves **C**, then lower the levers **A**.



## 10.2.2 Removing doors with pins

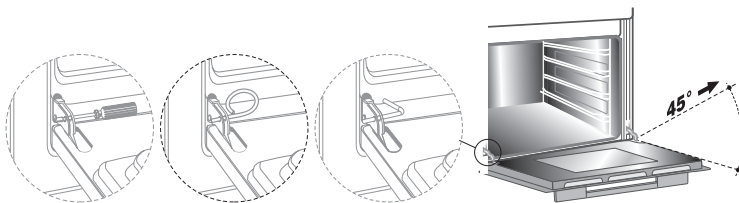

Open the door completely and insert the pins (supplied) into the holes from the inside. Close the door to an angle of about 45° and lift it off. To reassemble, fit the hinges into their grooves, then lower the door into place and extract the pins.

## 10.3 Removing the door seal

To permit thorough cleaning of the oven, the seal may be removed.

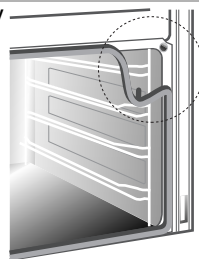



# Instructions for the user

GB-IE

## 10.4 Removing the internal glass panels

The glass in the door should always be kept thoroughly clean. To facilitate cleaning, it is possible to remove the door (see 10.2 Removing the door) and place it on a canvas; or open it and block the hinges in order to extract the glass panes.

The glass panes of the door can be completely removed by following the instructions provided below.



**Warning:** before removing the panes of glass, make sure that at least one of the door's hinges has been locked in open position as described in paragraph "10.2 Removing the door". This operation might have to be repeated during the glass removal process if the door is accidentally freed.

### 10.4.1 Removing door glazing on multifunction models:

#### 1 Removing the internal glass:

- Remove the internal glass pane, holding it in the positions indicated in figure (X).
- Pull it towards you, following the movement indicated by the arrows.

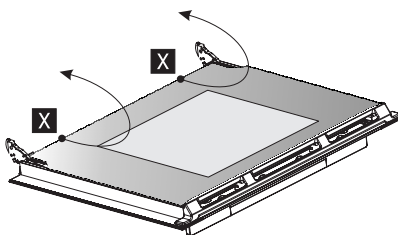

#### 2 Removing the middle glass:

- Remove the middle glass pane, holding it in the positions indicated in figure (X).
- Pull it towards you, following the movement indicated by the arrows.

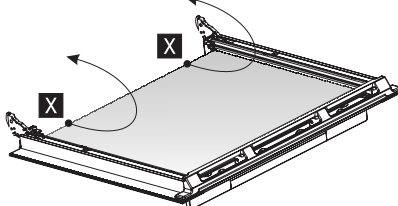

#### 3 Cleaning:

- Now it is possible to clean the external glass and the previously removed panes, using absorbent kitchen roll or, in the case of persistent dirt, washing with a damp sponge and neutral detergent.

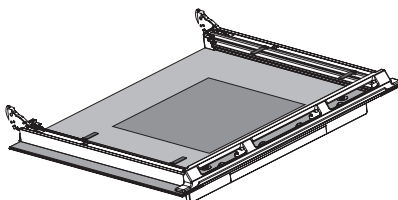



#### 4 Replacing the glass:

- Replace the panes in the opposite order to which they were removed. The middle glass pane must be inserted first on the front part, exactly on the second level (**figure A**), and then inserted on the back, again in the second level (**figure B**).
- Pay careful attention to the four rubber strips on the sides (**figure C**). These must be lowered during the insertion of the middle glass pane, acting as a seal between the frame and the pane of glass.
- Replace the internal glass pane inserting it on the third level in the same way as described for the middle pane. (**figure A, B**).

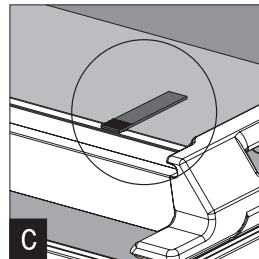
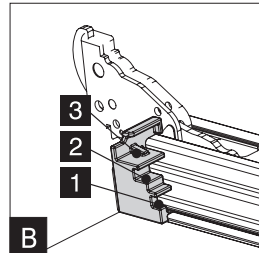
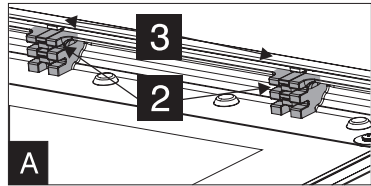

Warning: replace the glass panes in the same order and in the same direction that they were removed. Finally, if the door was not removed, unlock the hinges and close it.





## Instructions for the user

GB-IE

### 10.4.2 Removing door glazing on pyrolytic models:

#### 1 Removing the internal glass:

- Remove the internal glass pane, holding it in the positions indicated in figure (X).
- Pull it towards you, following the movement indicated by the arrows.

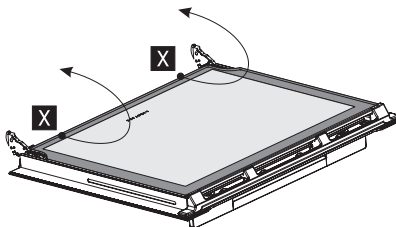

#### 2 Removing the 1st middle glass pane:

- Remove the first middle glass pane, holding it in the positions indicated in figure (X).
- Pull it towards you, following the movement indicated by the arrows.

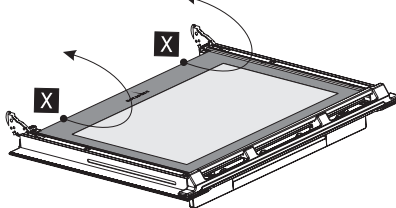

#### 3 Removing the 2nd middle glass pane:

- Remove the second middle glass pane, holding it in the positions indicated in figure (X).
- Pull it towards you, following the movement indicated by the arrows.

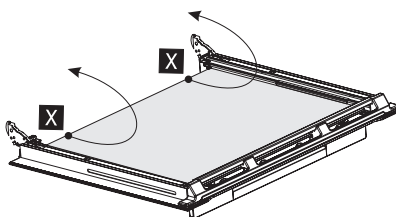

#### 4 Cleaning:

- Now it is possible to clean the external glass and the previously removed panes, using absorbent kitchen roll or, in the case of persistent dirt, washing with a damp sponge and neutral detergent.

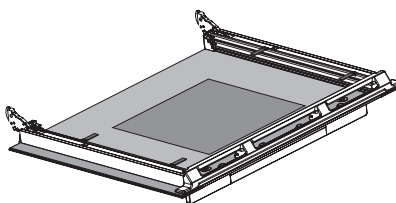



### 5 Replacing the glass:

- Replace the panes in the opposite order to which they were removed. The first middle glass pane must be inserted first on the front part, exactly on the first level (**figure A**), and then inserted on the back, again in the first level (**figure B**).
- Pay careful attention to the four rubber strips on the sides (**figure C**). These must be lowered during the insertion of the first middle glass pane acting as a seal between the frame and the pane of glass.
- The second middle glass pane must be inserted first on the front part, on the second level (**figure A**), and then inserted on the back, again in the second level (**figure B**).
- Replace the internal glass pane inserting it on the third level in the same way as described for the middle panes. (**figure A, B**).

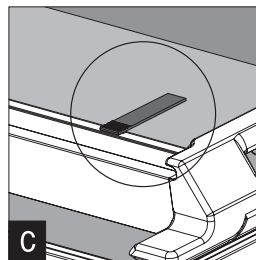
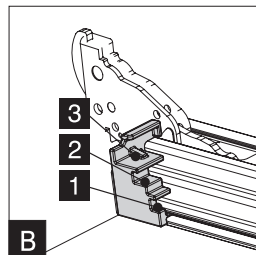
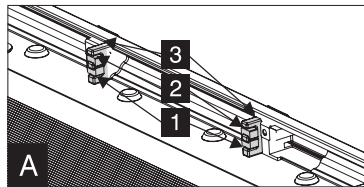

Warning: replace the glass panes in the same order and in the same direction that they were removed. Finally, if the door was not removed, unlock the hinges and close it.



## Instructions for the installer

GB-IE

### 10.5 what to do if...

- The oven display is full off**
- Check the mains power supply.
  - Check whether an omnipolar switch upstream from the oven feed line is in the “ON” position.
- The oven does not heat up**
- Check whether the “showroom” mode has been set, for further details see paragraph “Secondary menu” on page 55.
- The controls do not respond.**
- Check whether the “child lock-out function” mode has been set, for further details see paragraph “Secondary menu” on page 55.
- The cooking times are longer than those indicated in the table.**
- Check whether the “2300 W” mode has been set, for further details see paragraph “Secondary menu” on page 55.
- After the automatic “pyrolysis” cleaning cycle (only on some models) it is not possible to select a function.**
- Verify whether the interlock device has switched off. If it has not, the oven has a protection device that does not allow functions to be selected while the interlock device is active. This is because the temperatures inside the oven are still too high to permit any type of cooking.
- The display shows ERR 4**  
(on pyrolytic models only)
- The interlock device has not hooked up to the door properly. These might be because the door was accidentally opened during its activation. Switch off the oven and switch it on again waiting a few minutes before selecting a new cleaning cycle.
- If the door is opened during a ventilated function, the fans stop.**
- This is not a fault. It is a normal operation of the appliance, useful when cooking foods in order to avoid excessive heat escaping. When the door is closed, the oven will return to normal operation.



If the problem has not been resolved or for other types of faults, contact your local technical assistance centre.



## 11. INSTALLING THE APPLIANCE

### 11.1 Electrical connection



The I.D. plate with technical data, registration number and brand name is positioned visibly on the oven door frame.

The plate must not be removed.



The appliance must be connected to earth in compliance with electrical system safety regulations.



If a fixed connection is being used fit power line with an omnipolar circuit breaker with a contact opening gap equal to or greater than **3 mm**, in an easily accessible position in proximity to the oven.



If a plug and socket connection is being used make sure that the plug and socket are compatible. Avoid use of adapters and shunts as these could cause overheating and risk of burns.



**Operation at 220-240 V~:** use a type H05RR-F (3 x 1.5 mm<sup>2</sup>) or type H05V2V2-F (3 x 1.5 mm<sup>2</sup>) three-wire cable.

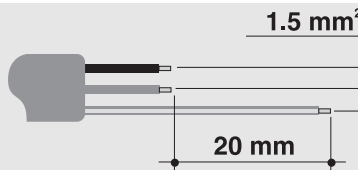

The earth wire (yellow-green) must be at least 20 mm longer than the other wires at the end for connection to the appliance.



**WARNING: THE VALUES INDICATED ABOVE REFER TO THE CROSS-SECTION OF THE INTERNAL CONDUCTOR.**

If the power supply lead has to be replaced, remove the rear casing by undoing the screws as shown below. The cross-section of the power lead must be at least 1.5 mm<sup>2</sup> (3 X 1.5 cable) and it must withstand temperatures up to 90°C (H05V2V2-F). Make sure that the cables follow the best possible route and use band clamps to fix them at the side of the cabinet, to avoid any contact with the oven.

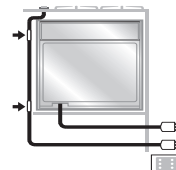
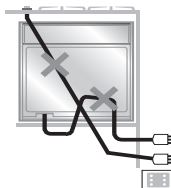
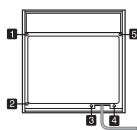



# Instructions for the installer

GB-IE

## 11.2 Positioning the oven

The oven is designed for mounting into any piece of furniture as long as it is heat-resistant. Proceed according to the dimensions shown in Figures 1, 2 and 3. For installing under a work top, follow the dimensions given in Figure 1-3. When installing under worktops incorporating combined hobs, a gap of at least 110 mm must be left from any side wall, as shown in figure 1.

When installing in tall units, comply with the dimensions shown in figure 1-2, bearing in mind that the top/rear of the unit must have an opening 80-90 mm deep. Tighten the 2 screws **A** inside the frame (fig. 1). For installing beneath a non-integrated top, allow for a rear and bottom clearance as shown in Figure 1 (ref. **B**). See relevant instructions for fitting and securing the hob.

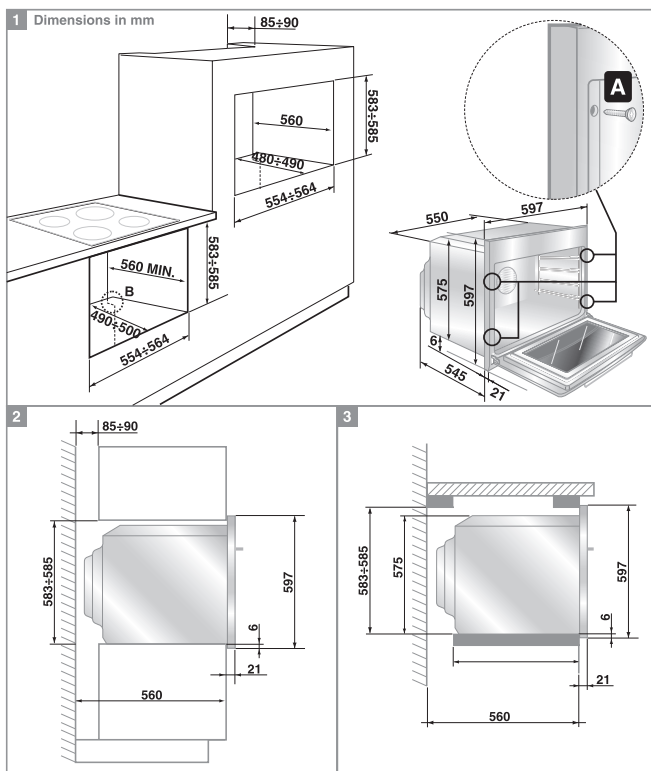

## Instructions for the installer



Never use the oven door to lever the oven into place when fitting. Avoid exerting too much pressure on the oven door when open.

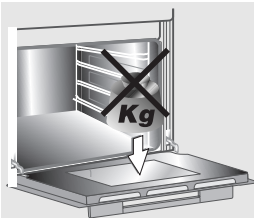

It is recommended to install the oven with the help of a second person.



**WARNING:** When the oven has been extracted from the packing base, avoid resting the product on the ground as this could cause deformation of the drip trays. If necessary during handling, replace the oven in the packing base.