

1.	INSTRUCTIONS FOR SAFE AND PROPER USE	33
2.	INSTALLATION	35
3.	DESCRIPTION OF CONTROLS	38
4.	USE OF THE OVEN	46
5.	USING THE PIZZA FUNCTION	48
6.	AVAILABLE ACCESSORIES	50
7.	COOKING HINTS	51
8.	CLEANING AND MAINTENANCE	55
9.	EXTRAORDINARY MAINTENANCE	60



*INSTRUCTIONS FOR THE INSTALLER: these are intended for the **qualified technician** who must install the appliance, set it functioning and carry out an inspection test.*



INSTRUCTIONS FOR THE USER: these contain user advice, description of the commands and the correct procedures for cleaning and maintenance of the appliance.

1. INSTRUCTIONS FOR SAFE AND PROPER USE



THIS MANUAL IS AN INTEGRAL PART OF THE APPLIANCE AND THEREFORE MUST BE KEPT IN ITS ENTIRETY AND IN AN ACCESSIBLE PLACE FOR THE WHOLE WORKING LIFE OF THE OVEN. WE ADVISE CAREFUL READING OF THIS MANUAL AND ALL THE INSTRUCTIONS THEREIN BEFORE USING THE OVEN. INSTALLATION MUST BE CARRIED OUT BY QUALIFIED PERSONNEL IN ACCORDANCE WITH THE REGULATIONS IN FORCE. THIS APPLIANCE IS INTENDED FOR DOMESTIC USES AND CONFORMS TO CURRENT **REGULATIONS IN FORCE**. THE APPLIANCE HAS BEEN BUILT TO CARRY OUT THE FOLLOWING FUNCTIONS: **COOKING AND HEATING-UP OF FOOD**. ALL OTHER USES ARE CONSIDERED IMPROPER.

THE MANUFACTURER DECLINES ALL RESPONSIBILITY FOR IMPROPER USE.



DO NOT LEAVE THE PACKING IN THE HOME ENVIRONMENT. SEPARATE THE VARIOUS WASTE MATERIALS AND TAKE THEM TO THE NEAREST SPECIAL GARBAGE COLLECTION CENTRE.



IT IS OBLIGATORY FOR THE ELECTRICAL SYSTEM TO BE GROUNDED ACCORDING TO THE METHODS REQUIRED BY SAFETY RULES.



WHEN LINKING UP TO MAINS BY PLUG AND SOCKET, MAKE SURE THAT BOTH ARE COMPATIBLE AND CONNECT BY MEANS OF A POWER CABLE COMPLYING WITH APPLICABLE REGULATIONS.

THE SOCKET MUST BE ACCESSIBLE AFTER THE APPLIANCE HAS BEEN BUILT IN.

NEVER UNPLUG BY PULLING ON THE CABLE.



DO NOT OBSTRUCT VENTILATION OPENINGS AND HEAT DISPERSAL SLITS.



IMMEDIATELY AFTER INSTALLATION CARRY OUT A BRIEF INSPECTION TEST OF THE OVEN, FOLLOWING THE INSTRUCTIONS BELOW. SHOULD THE APPLIANCE NOT FUNCTION, DISCONNECT IT FROM THE SUPPLY AND CALL THE NEAREST TECHNICAL ASSISTANCE CENTRE.

NEVER ATTEMPT TO REPAIR THE APPLIANCE.

Introduction



ALWAYS CHECK THAT THE CONTROL KNOBS ARE IN THE "ZERO" (OFF) POSITION WHEN YOU FINISH USING THE OVEN.



NEVER PUT INFLAMMABLE OBJECTS IN THE OVEN: THEY COULD BE ACCIDENTALLY LIGHTED AND CAUSE FIRES.



DURING USE THE APPLIANCE BECOMES VERY HOT. TAKE CARE NOT TO TOUCH THE HEATING ELEMENTS INSIDE THE OVEN.



THE I.D. PLATE WITH TECHNICAL DATA, REGISTRATION NUMBER AND BRAND NAME IS POSITIONED VISIBLY ON THE OVEN DOOR FRAME. **THE PLATE MUST NOT BE REMOVED.**



THE OVEN IS DESIGNED FOR USE BY ADULTS. DO NOT ALLOW CHILDREN TO GO NEAR OR PLAY WITH IT.



THIS APPLIANCE IS MARKED ACCORDING TO THE EUROPEAN DIRECTIVE 2002/96/EC ON WASTE ELECTRICAL AND ELECTRONIC EQUIPMENT (WEEE).

THIS GUIDELINE IS THE FRAME OF A EUROPEAN-WIDE VALIDITY OF RETURN AND RECYCLING ON WASTE ELECTRICAL AND ELECTRONIC EQUIPMENT.



BEFORE THE APPLIANCE IS PUT INTO OPERATION, ALL THE LABELS AND PROTECTIVE FILMS APPLIED INSIDE OR OUTSIDE MUST BE REMOVED.



The manufacturer declines all responsibility for damage to persons or things caused by non-observance of the above prescriptions or by interference with any part of the appliance or by the use of non-original spares.



Instructions for the installer



2. INSTALLATION

2.1 Electrical connection



Check that mains voltage and power cable ratings are as per the indications provided on the label attached to the oven door frame.

This label must never be removed.



It is obligatory for the electrical system to be grounded according to the methods required by safety rules.



If a plug and socket connection is being used make sure that the plug and socket are compatible. Avoid use of adapters and shunts as these could cause overheating and risk of burns.



If a fixed connection is being used fit power line with an omnipolar circuit breaker with a contact opening gap equal to or greater than **3 mm** in an easily accessible position in proximity to the oven.



For operation on 220-240V~: use an H05RR-F / H05RN-F / H05V2V2-F type three-core cable (3 x 1.5 mm²).

The cable end to be connected to the appliance must be provided with an ground wire (yellow-green) at least 20 mm longer.

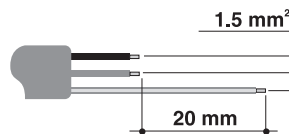

The manufacturer declines all responsibility for damage to persons or things caused by non-observance of the above prescriptions or by interference with any part of the appliance.



2.2 Mounting the oven

The oven is designed for mounting into any piece of furniture as long as heat-resistant. Proceed according to the dimensions shown in Figures 1, 2 and 3. For installing under a work top, follow the dimensions given in Figure 1-3. For installing under a work top with combined heating plates, ensure a minimum clearance from any side walls of at least 110 mm as shown in Figure 1.

For installing in a column, follow the dimensions given in Figure 1-2 allowing for a clearance of 80 to 90 mm at the top and sides of the column. Tighten the four screws **A** inside the frame to secure (Fig. 1).

For installing beneath a non-integrated top, allow for a rear and bottom clearance as shown in Figure 1 (ref. **B**). See relevant instructions for fitting and securing the cook top.

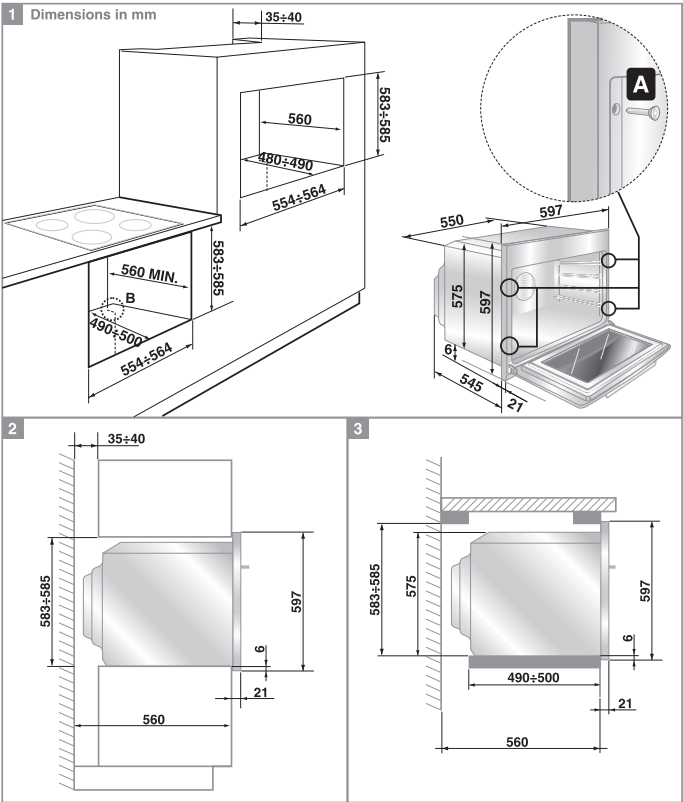



Instructions for the installer

GB-IE



*Never use the oven door to lever the oven into place when fitting.
Avoid exerting too much pressure on the oven door when open.*





3. DESCRIPTION OF CONTROLS

3.1 Front control panel

All the oven controls are grouped together on the front panel.

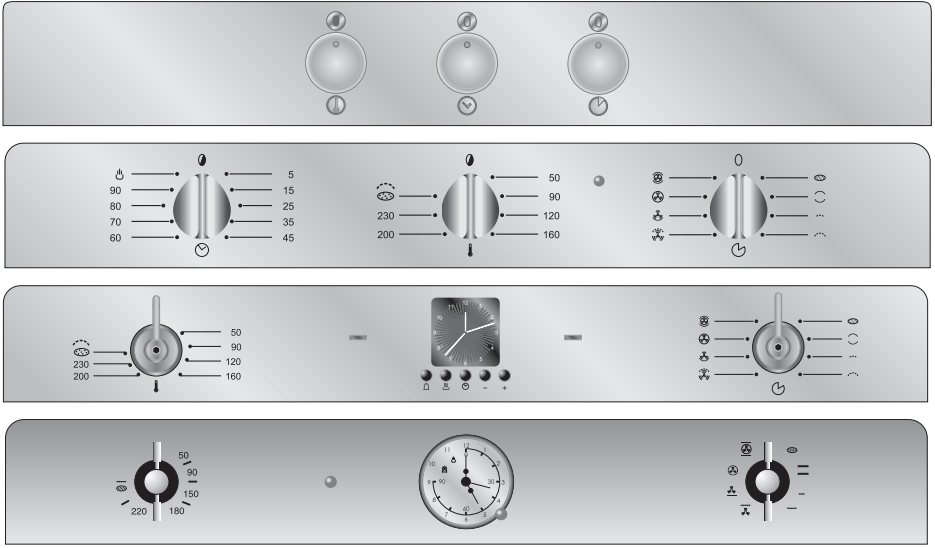

THERMOSTAT KNOB

Cooking temperature is selected by turning the knob clockwise to the desired setting, between 50° and 240°C/°F/°.

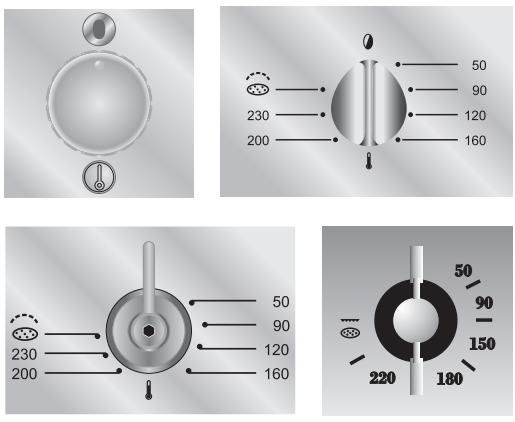



Instructions for the user

GB-IE

FUNCTION SWITCH KNOB

Rotate the knob in either direction to select desired function from the following:

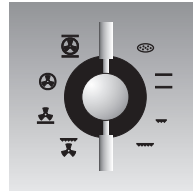
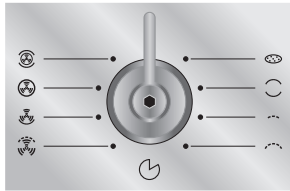
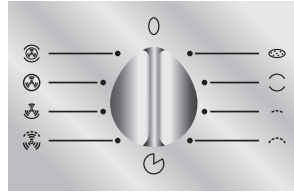
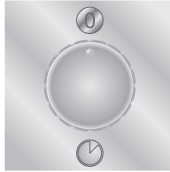

NO FUNCTION SET



PIZZA FUNCTION



UPPER AND LOWER HEATING ELEMENT



GRILL ELEMENT



WIDE GRILL ELEMENT



GRILL ELEMENT + VENTILATION



LOWER HEATING ELEMENT + VENTILATION



VENTILATED HEATING ELEMENT



UPPER AND LOWER HEATING ELEMENT + VENTILATED HEATING ELEMENT

Instructions for the user



TIMER KNOB (CERTAIN MODELS ONLY)

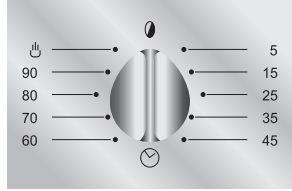
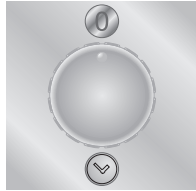

Lets you choose manual cooking or the timer with automatic turn-off of the oven when done.

For manual control of cooking time, turn the knob anticlockwise to the symbol .

Turn clockwise to wind up the alarm and set to the desired time.. The numbers from 5 to 90/120 correspond to minutes. Adjustment is progressive and intermediate positions between the numbers shown may be used.

At the end of programmed cooking, an audible alarm sounds which goes off automatically after 4-5 seconds.

THERMOSTAT INDICATOR LIGHT

When this light comes on, the oven is heating up.

When this light goes out, the preset heating temperature has been reached.

When the light flashes, the temperature inside the oven is steady.

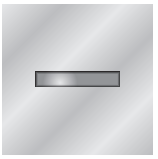

PILOT LIGHT (GREEN)

This light comes on when any of the oven elements is receiving power.

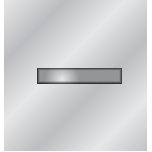



Instructions for the user

GB-IE

3.2 Clock + timer with end of cooking (certain models only)

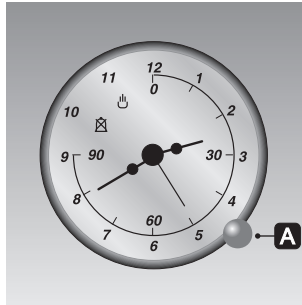

Allows selection of manual cooking or to set timer and cooking time.



Always rotate the small knob **A** **ANTICLOCKWISE**.



Select function and cooking temperature before setting cooking time.

3.2.1 Adjusting the clock

To adjust to correct time, **PRESS** and rotate the small knob **A** anticlockwise.

3.2.2 Manual cooking

For manual cooking, rotate small knob **A** anticlockwise until pointer is aligned with .

3.2.3 Setting cooking time

To set cooking time, rotate small knob **A** anticlockwise to the desired length of time (maximum 90 minutes).

3.2.4 End of cooking

At end of cooking the oven turns off automatically and the alarm starts sounds.

3.2.5 To turn the alarm off





Turn small knob **A** anticlockwise until pointer is aligned with .

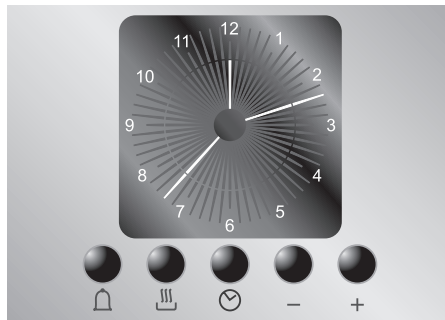

3.3 Electronic Analogue Clock (on some models only)



LIST OF FUNCTIONS

-  MINUTE-MINDER BUTTON
-  AUTOMATIC SWITCH-OFF TIMING BUTTON
-  TIME SETTING AND RESET
-  VALUE DECREASE BUTTON
-  VALUE INCREASE BUTTON

3.3.1 Setting the time

When the oven is used for the first time, or after a power blackout, the display flashes on and off at regular intervals. Press the  key for 1/2 seconds to stop the display flashing and start setting of the current time.

Press the value modification keys  or  to increase or decrease by one minute for each time a key is pressed.

Press one of the two value modification keys until the current time appears. The clock will start from the time set 6/7 seconds after the last key is pressed.



At the end of each programmed cooking operation, the clock gives 8 beeps, repeated 3/4 times at intervals of about 1 and a half minutes. The beeps can be stopped at any moment by pressing any key.







Instructions for the user

GB-IE

3.3.2 Minute-minder

This function does not stop cooking but just triggers the beeps.

- When the  key is pressed the display illuminates, appearing as shown in figure 1;
- Press the  or  keys within 6/7 seconds to set the minute-minder. Whenever a key is pressed, 1 outside segment, representing 1 cooking minute will light up (figure 2 shows 10 cooking minutes).
- The countdown will start 6/7 seconds after the last key is pressed; at the end of it, you will hear the beeps.
- During cooking with countdown, the current time can be displayed by pressing the  key once; press again to return to the minute-minder display.
- **At the end of the countdown, the oven has to be switched off by hand, by turning the thermostat and the function selector to 0.**

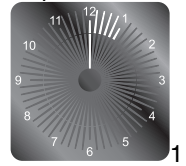







Instructions for the user



3.3.3 Programming

Cooking duration time: the 2nd button  can be used to set the cooking time. Before setting it, turn the thermostat to the cooking temperature of choice and the function selector knob to any setting. To set the cooking time, proceed as follows:

- Press the  key for 1/2 seconds; the pointer will move to position 12 (Fig. 1).
- Use the  and  keys to set the cooking time; whenever the  key is pressed, 1 minute will be added to the cooking time, and every 12 minutes a new inside segment will light up (figure 2 shows a cooking time of 1 hour).
- Once the required time has been set, cooking will start about 6 seconds after the last time the  or  key is pressed.
- Once cooking has started, the display will show the current time, represented by the constantly on segments, and the minutes left until cooking finishes, represented by the flashing segments (every flashing segments indicates 12 minutes of cooking time left).
- When the end of the cooking time is reached, the timer will switch off the oven heating elements, the beeps will start and the numbers on the dial will flash.
- The cooking time can also be reset by deleting the program set; pressing the central key  for 1 or 2 seconds will delete the time set and the oven will have to be switched off by hand.



1



2

Caution: cooking times of more than 6 hours cannot be set.



Instructions for the user

GB-IE

Cooking start: as well as setting a cooking duration time, the user can also set the cooking start time (up to 12 hours after the current time). To set the cooking start/end time, proceed as follows.

- Set the cooking duration time as described in the previous point.
- Within 6/7 seconds after the last time the **-** or **+** keys are pressed, press the **|||** key to set the cooking start time. The display will show the current time with the inside segments indicating the cooking end time illuminated. Use the **-** and **+** keys to set the cooking start time.
- 6/7 seconds after the last time a key is pressed, the display will show the current time and the cooking start and end times, indicated by the illuminated inside segments. The segments on the display will be constantly on until the current time is the same as the cooking start time; as soon as the current time reaches the cooking start time set, all the inside segments will start to flash, indicating that the oven has started cooking.
- When the end of the cooking time is reached, the timer will switch off the oven heating elements, the beeps will start and the numbers on the dial will flash.
- To reset the entire program set, keep the central key  pressed for 1 or 2 seconds: if cooking has already started the oven will have to be switched off by hand.
- The image on the right shows an example of programming: the current time is 7.06 and cooking is programmed to start at 8 o'clock and finish at 9.
- At 8 o'clock, the inside segments between 8 and 9 will start to flash and the hour pointer will remain still.



Caution: for the oven to start cooking after the programming procedure just described, the thermostat and function selector must be properly set on the temperature and function required.

3.3.4 "DEMO" Function

Models with analogue/digital programmer feature a "DEMO" function which deactivates the heating elements while leaving the other functions unchanged. To activate it, simply press the **|||**, **-** and **+** keys for 3/4 seconds. A confirmation beep will inform the user that the function is active. To deactivate it, simply repeat the same procedure.



4. USE OF THE OVEN

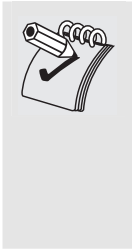

3 operations are required to switch the oven on:
1st: make sure that the timer is turned to ‘0’;
2nd: turn the thermostat;
3rd: turn the function selector to any function (the “lamp” setting does not switch on any heating elements).
In models equipped with analogue digital timer, the user has only to press the central key for 1/2 seconds to enable use of the oven on first use or after a power blackout.

4.1 Warnings and general advice

Before using the oven for the first time, pre-heat it to maximum temperature long enough to burn any manufacturing oily residues which could give the food a bad taste.



During cooking, do not cover the bottom of the oven with aluminium or tin foil and do not place pans or oven trays on it as this may damage the enamel coating. If you wish to use greaseproof paper, place it so that it will not interfere with the hot air circulation inside the oven.



To prevent any steam in the oven creating problems, open the door in two stages: half open (5 cm approx.) for 4-5 seconds and then fully open. To access food, always leave the door open as short a time as possible to prevent the temperature in the oven from falling and ruining the food.





Instructions for the user

GB-IE

4.2 Cooling system (on some models only)

The oven is equipped with a cooling system which automatically comes on upon the oven being turned on.

Fans cause a steady outflow of air from above the door which may continue for a brief period of time even after the oven has been turned off.

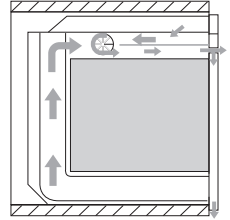

4.3 Oven light

On all models, it is switched on by turning the function selector knob to any function. On some models it also switches on when the oven door is opened.



5. USING THE PIZZA FUNCTION

This appliance is equipped with a function specially developed for cooking pizza. This function is identified by the  symbol on the oven functions knob. To cook a pizza, proceed as described below.

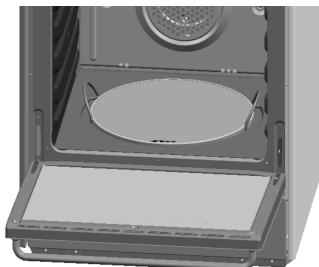

Set the oven functions knob on the  symbol and the thermostat knob on the  /  symbol.

Preheat with these settings until the thermostat light goes out, then place the pizza on the special plate.

It does not normally take more than 3-4 minutes to cook a pizza to perfection, although this time may vary depending on the dough used or individual taste.

5.1.1 Precautions for using the pizza plate

- Always remove the round cover and fit the pizza plate with the **oven off and cold**.
- Never use the pizza plate except as described above (for example, never use it on gas or ceramic hobs, or on ovens not designed to take this accessory).
- During use, the appliance becomes very hot; protective gloves should be worn for all operations.
- If you like oil on your pizza, it is best to add it after removal from the oven since oil stains on the pizza plate are unsightly and may reduce its efficiency.



Instructions for the user

GB-IE

5.2 Warnings



- *Cooking procedures in this mode must never last more than 60 minutes.*
- *In models with electric oven, the door must be close during grilling.*
- *During and after use the accessible parts of the oven may be very hot, and children must always be kept at a distance.*
- *During cooking, do not cover the bottom of the oven with aluminium or tin foil and do not place pans or oven trays on it as this may damage the enamel coating. If you wish to use greaseproof paper, place it so that it will not interfere with the hot air circulation inside the oven.*
- *When using the oven, remove all unused baking sheets and shelves from the interior.*

5.3 Energy saving

The pizza stone acts as a heat reservoir. This allows energy consumption to be reduced, especially in cooking operations requiring pre-heating or medium-long times.

In these cases, simply turn the thermostat to zero 10-12 minutes before the end of the cooking time.

The heat gradually emitted by the refractory stone will ensure that the cooking temperature is maintained.

5.4 Energy saving

The pizza stone acts as a heat reservoir. This allows energy consumption to be reduced, especially in cooking operations requiring pre-heating or medium-long times.

In these cases, simply turn the thermostat to zero 10-12 minutes before the end of the cooking time.

The heat gradually emitted by the refractory stone will ensure that the cooking temperature is maintained.



6. AVAILABLE ACCESSORIES

The oven features **4 support** positions for plates and racks of different height.

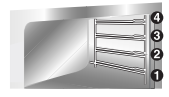

Grill: useful for holding cooking vessels.



Plate grill: for placing above plate for cooking foods that might drip.



Oven plate: useful for catching fat from foods on the grill above.

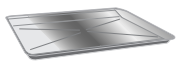

Pastry plate: for baking cakes, pizza and oven desserts.

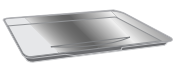

Roof liner/Grill guard: removing this simplifies cleaning procedures inside the oven.

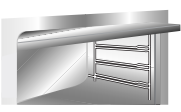

Pizza plate: specially designed for cooking pizza. For use as described in point "5 Using the "pizza" function"



Pizza shovel: a convenient way of putting the pizza on the special plate in the oven.

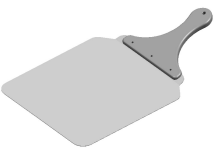

Pizza plate stand: so that the hot pizza plate does not have to be placed directly on a table or other delicate surfaces.

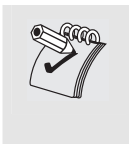
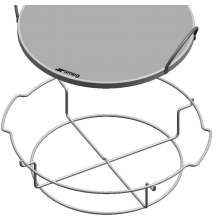

Some models do not feature all accessories.

Accessories available on request

Original accessories may be ordered from any Authorised Service Centre.



Instructions for the user



7. COOKING HINTS



In fan-assisted mode preheating should be carried out at 30/40°C above the cooking temperature. This considerably shortens cooking times and reduces power consumption, as well as giving better cooking results.



Keep the oven door closed during cooking

7.1 Traditional cooking



FUNCTION SWITCH



THERMOSTAT SWITCH



This traditional cooking method, in which heat comes from above and below, is suitable for cooking food on a single level. You have to pre-heat the oven until the set temperature is reached. Place the food in the oven only after the thermostat indicator light has turned off. very fatty meats may be put in when the oven is still cold. Put frozen meat in immediately, without waiting for it to thaw. The only precaution you need to take is to set the temperature about 20°C lower and cooking time about 1/4 longer than you would for fresh meat.

7.2 Hot-air cooking



FUNCTION SWITCH



THERMOSTAT SWITCH

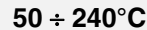

This system is suitable for cooking on several levels, including different types of food (fish, meat etc.), without the tastes and smells mingling. Air circulation in the oven ensures a uniform distribution of heat. Pre-heating is not necessary.

Instructions for the user



Multiple cooking is possible as long as the cooking temperature of the different foods is the same.

7.3 Grill cooking



FUNCTION SWITCH



THERMOSTAT SWITCH



Permits rapid browning of foods. You are advised to place the pan in the highest guide. For short-term cooking of small quantities, place the grid in the fourth guide from the bottom. For long-term cooking and grills, put the grid in the lowest guide in accordance with the size of the pieces.
Keep the oven door closed during cooking.

7.4 Hot-air grilling



FUNCTION SWITCH



THERMOSTAT SWITCH

220



Ensures uniform heat distribution with greater heat penetration into the food. Food will be lightly browned on the outside and remain soft inside.
Keep the oven door closed during cooking. Heating up time must not exceed 60 minutes.



Instructions for the user

GB-IE

7.5 Recommended cooking table

Cooking times, especially meat, vary according to the thickness and quality of the food and to consumer taste.

TRADITIONAL COOKING



	LEVEL FROM BELOW	TEMPERATURE (°C)	TIME IN MINUTES (*)
FIRST COURSES			
LASAGNE	2 - 3	210 - 230	30
OVEN-BAKED PASTA	2 - 3	210 - 230	40
MEAT			
ROAST VEAL	2	170 - 200	30 - 40 / KG.
ROAST BEEF	2	210 - 240	30 - 40 / KG.
ROAST PORK	2	170 - 200	30 - 40 / KG.
CHICKEN	2	170 - 200	45 - 60
DUCK	2	170 - 200	45 - 60
GOOSE - TURKEY	2	140 - 170	45 - 60
RABBIT	2	170 - 200	50 - 60
LEG OF LAMB	2	170 - 200	40 - 50
FISH	1 - 2	170 - 200	ACCORDING TO DIMENSIONS
PIZZA	1 - 2	210 - 240	40 - 45
DESSERTS			
SHORT PASTRY	1 - 2	170 - 200	15 - 20
CIAMBELLA	1 - 2	165	35 - 45
BRIOCHES	1 - 2	170 - 200	40 - 45
FRUIT CAKE	1 - 2	170 - 200	20 - 30
PARADISE CAKE	1 - 2	170	60
APPLE CAKE	1 - 2	190	60
RICE CAKE	1 - 2	180	60

(*) = WITH PREHEATED OVEN

GRILLING



	LEVEL FROM BELOW	TIME IN MINUTES	
		FIRST SURFACE	SECOND SURFACE
PORK CHOPS	4	7 - 9	5 - 7
FILLET OF PORK	3	9 - 11	5 - 9
FILLET OF BEEF	3	9 - 11	9 - 11
LIVER	4	2 - 3	2 - 3
VEAL ESCALOPES	4	7 - 9	5 - 7
HALF CHICKEN	3	9 - 14	9 - 11
SAUSAGES	4	7 - 9	5 - 6
MEAT-BALLS	4	7 - 9	5 - 6
FISH FILLETS	4	5 - 6	3 - 4
TOAST	4	2 - 4	2 - 3



HOT-AIR COOKING



	LEVEL FROM BELOW	TEMPERATURE (°C)	TIME IN MINUTES
FIRST COURSES			
LASAGNE	2	190 - 210	20 - 25
OVEN-BAKED PASTA	2	190 - 210	25 - 30
CREOLE RICE	2	190 - 220	20 - 25
MEAT			
ROAST VEAL	2	150 - 170	65 - 90
ROAST PORK	2	150 - 160	70 - 100
ROASTED BEEF	2	160 - 170	65 - 90
FILLET OF BEEF	2	160 - 180	35 - 45
ROAST LAMB	2	130 - 150	100 - 130
ROAST BEEF	2	170 - 180	40 - 45
ROAST CHICKEN	2	170	70 - 90
ROAST DUCK	2	160 - 170	100 - 160
ROAST TURKEY	2	150 - 160	160 - 240
ROAST RABBIT	2	150 - 160	80 - 100
ROAST HARE	2	160 - 170	30 - 50
ROAST PIGEON	2	140 - 170	15 - 25
FISH	2 - 3	150 - 170	ACCORDING TO DIMENSIONS
PIZZA	2 - 3	210 - 240	30 - 50
BREAD	2 - 3	190 - 210	40
TOAST	1 - 2	220 - 240	7
DESSERTS			
CIAMBELLA	2 - 3	150 - 160	35 - 45
FRUIT CAKE	2 - 3	150 - 160	40 - 50
BRIOCHEs	2 - 3	150 - 160	40 - 60
SHORT PASTRY	2 - 3	150 - 160	25
RICE CAKE	2 - 3	150 - 160	65
APPLE CAKE	2 - 3	150 - 160	65
PARADISE CAKE	2 - 3	150 - 160	65



Instructions for the user

GB-IE

8. CLEANING AND MAINTENANCE



Before performing any operations requiring access to powered parts, switch off the power supply to the machine.

8.1 Cleaning stainless steel



To keep stainless steel in good condition it should be cleaned regularly after use. Let it cool first.

8.1.1 Ordinary Daily Cleaning

To clean and preserve the stainless steel surfaces, always use **only** specific products that do not contain abrasives or chlorine-based acids.

How to use: pour the product on a damp cloth and wipe the surface, rinse thoroughly and dry with a soft cloth or deerskin.

8.1.2 Food stains or residues

Do not use metallic sponges or sharp scrapers: they will damage the surface.

Use normal non-abrasive products for steel, and a wooden or plastic tool if necessary.

Rinse thoroughly and dry with a soft cloth or deerskin.

Do not allow residues of sugary foods (such as jam) to set inside the oven. If left to set for too long, they might damage the enamel lining of the oven.



8.2 Cleaning of the oven (without self-cleaning panels)



For best oven upkeep clean regularly after having allowed to cool. Take out all removable parts.





To clean the bottom of the oven, proceed as follows **with the oven cold**.

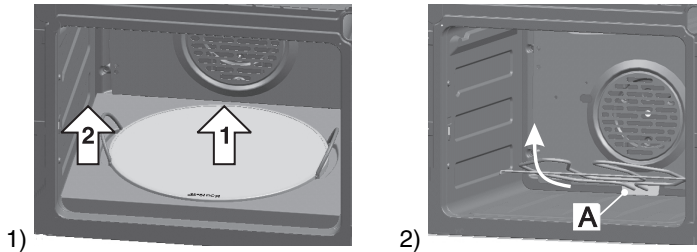

Remove the pizza plate and then the base to which it is fixed (Fig. 1). Lift the base a few mm and then bring it out of the oven.

Now lift the end of the heating element next to the door of the oven and clean the bottom. When the operation is complete, damp parts should be dried thoroughly.

- **DO NOT USE A STEAM JET FOR CLEANING THE INSIDE OF THE OVEN.**
 - Clean the oven grill and side guides with hot water and non-abrasive detergent. Rinse and dry.
 - The oven should be operated at the maximum temperature for about 15/20 minutes after using specific products, to eliminate the residues deposited inside the oven.
 - For easier cleaning, the door can be removed (see P. 8.3)
- The pizza plate must be washed separately;
- Before cleaning, remove any dirt burnt onto the stone with the aid of a metal spatula or a ceramic hob cleaning scraper;
 - For the best results, the stone must be still warm; otherwise, wash it with hot water;
 - Use non-abrasive metal mesh pads or scotch-brite, dipped in lemon or vinegar;
 - Never use detergents;
 - Never wash in the dishwasher;
 - Never leave the stone to soak;
 - The damp stone must not be used for a least 8 hours after the end of the cleaning procedures;
 - Over time, slight cracks may appear on the surface of the stone.
 - This is due to the normal expansion of the stone's finishing glazes at high temperatures.
 - To refit the pizza plate base, push it snugly against the oven floor and down so that it locks with the pizza heating element (detail A, Fig. 2).



Instructions for the user

GB-IE

8.2.1 Self-cleaning liners

The oven is equipped with continuous self-cleaning enamelled liners. These liners make the oven easier to clean and ensure its efficiency over time.

8.2.2 Using the self-cleaning liners

Periodically, to prevent food residues and unpleasant smells from accumulating inside the oven, the appliance should be operated empty at temperatures of not less than 200°C for a time varying from 30 to 60 minutes, in order to allow the self-cleaning liners to oxidise the residues present; when the oven has cooled, these will then be removed with a damp sponge

8.2.3 Looking after the self-cleaning liners

The liners should not be cleaned with abrasive creams or ordinary detergents. Use a damp sponge only, so as not to damage the special characteristics of the enamel which coats the liners.

8.2.4 Assembling the self-cleaning liners

1. Remove all accessories from the oven;
2. Remove the side grilles (fig.1);
3. Extract the side liners "F" and "G"(fig. 2);
4. Remove the back panel "A" after undoing the threaded ring-nut "C" (fig. 2).
5. Reassemble the panels, restoring them to their original position.

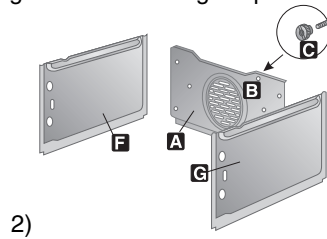
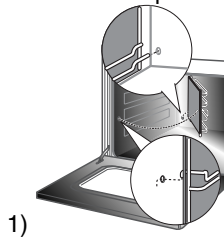



8.3 Removing door

With the door completely open, lift the levers A until they touch the hinges B and take hold of the two sides of the door with both hands close to the hinges. Raise the door to an angle of about 45° and remove it. If the hinges have not locked, repeat the operation, raising the levers and keeping the door slightly raised. To reassemble, fit the hinges B into their grooves, then lower the door into place, ensuring that it remains fitted into the grooves C.

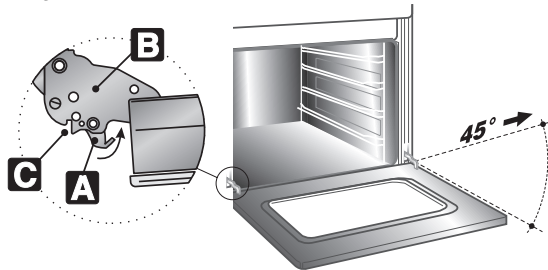

8.4 Removing the door glass

The glass in the door should always be kept thoroughly clean. For easier cleaning, the door glazing can be fully removed by proceeding as described below. After blocking the door in position as described in point "8.3 Removing door", remove the inner glass using leverage as shown in figure 1, and release the 4 pins which fix the glass to the door.

If your oven also has the middle glass (figure 2) this can simply be lifted out.

After cleaning, first fit the middle glass (if featured on your oven) and then replace the inner glass, using the oven door supports as a fulcrum as shown in figure 3 (see detail A in figure 3). Once the glass has been fitted on the door, apply a little pressure against the 4 fixing pins.

If the door should close during these operations, simply relock one of the hinges as described in point "8.3 Removing door". The panes of glass can now be washed separately.



Instructions for the user

GB-IE

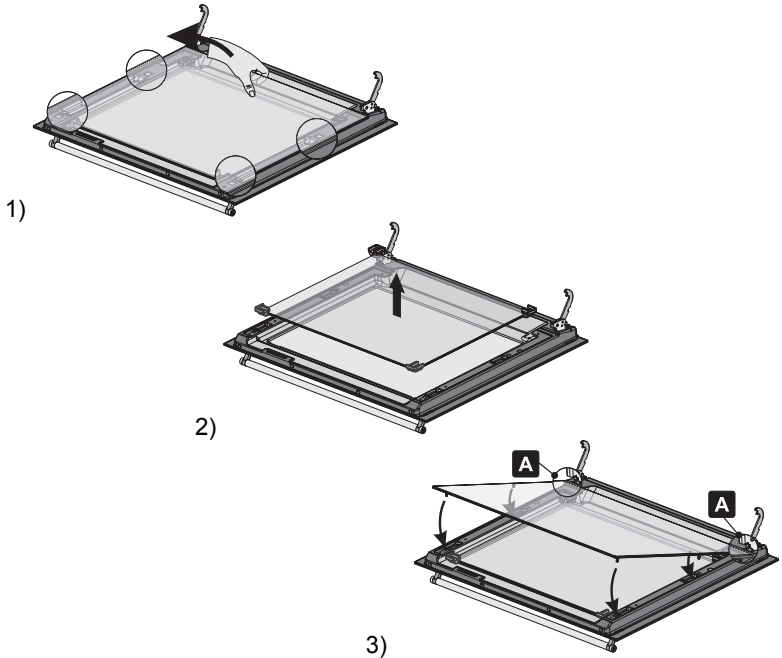

Use absorbent kitchen paper to clean. In case of tough spots, clean with a damp sponge using regular detergent. This oven door is air cooled. Care should be taken not to use excess moisture for cleaning, and avoid spillage through the vents.



Warning: before removing the panes of glass, make sure that the door has been locked in open position as described in point "8.3 Removing door". This operation might have to be repeated during the removal process if the door is accidentally freed.



To replace the panes of glass in the oven door, follow the instructions provided in reverse order.
WARNING. *Never use the oven without the glass fitted: the outside surface of the door overheats*



9. EXTRAORDINARY MAINTENANCE

The oven may require extraordinary maintenance or replacement of parts subject to wear such as seals, bulbs, and so on. The following instructions describe how to carry out these minor maintenance operations.



Before any intervention, disconnect the power supply of the device.

9.1 Replacement of light bulb

Remove the bulb protector **A** by turning anticlockwise and change bulb **B** (in the 8-function model with front glass panel change the halogen bulb **C**) with a similar one. Re-fit the bulb protector **A**.

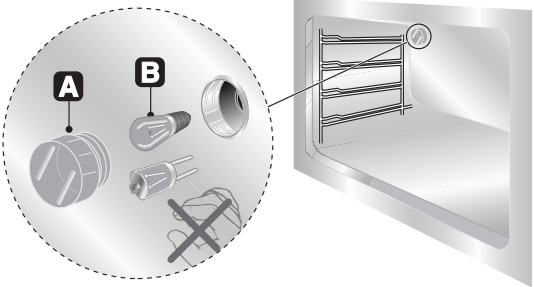

Only use oven bulbs (T 300°C).

9.2 Oven door seal

To permit thorough cleaning of the oven, the seal may be removed. Before removing the seal, take off the door as described above. Once the door has been taken off, lift the tabs at the corners as shown in the figure.

After cleaning, refit the seal with the longer side horizontal and insert the tabs into the appropriate holes starting from the top ones.

