

## Contents

1. INSTRUCTIONS FOR PROPER USE .....	4
2. DISPOSAL INSTRUCTIONS – OUR ENVIRONMENT POLICY .....	4
3. SAFETY PRECAUTION .....	5
4. INTENDED USE OF THE APPLIANCE .....	6
5. BEFORE FIRST USE .....	6
6. USE OF THE HOB .....	7
6.1 Cooking zone .....	7
7. FRONT CONTROL PANEL .....	8
8. USE OF THE OVEN .....	10
8.1 Warnings and general advice .....	10
8.2 Cooling system .....	10
8.3 Use of the electric grill .....	10
8.4 How to use the grill .....	10
9. ELECTRONIC PROGRAMMER .....	11
9.1 Clock adjustment .....	11
9.2 Setting the timer .....	11
9.3 Deactivating the acoustic device .....	11
9.4 Adjusting the volume of the acoustic device .....	11
9.5 Modifying the data set .....	11
10. CLEANING AND MAINTENANCE .....	12
10.1 Cleaning stainless steel .....	12
10.2 Ordinary daily cleaning .....	12
10.3 Food stains or residues .....	12
10.4 Cleaning the glazed ceramic hob .....	12
10.5 Cleaning of oven .....	13
10.6 Door glass .....	13
11. EXTRAORDINARY MAINTENANCE .....	14
11.1 Replacement of light bulb .....	14
11.2 Removing the door .....	14
11.3 Oven door seal .....	14
12. INSTALLATION OF THE APPLIANCE .....	15
12.1 Electrical connection .....	15
12.2 Wall fixing (where applicable) .....	16
12.3 Mounting the rear top skirtboard (where applicable) .....	16



**INSTRUCTIONS FOR THE USER:** these provide recommendations for use, a description of the controls and the correct procedures for cleaning and maintaining the appliance



**INSTRUCTIONS FOR THE INSTALLER:** these are intended for the **qualified engineer** who is to install, commission and test the appliance

## Instructions for proper use

### 1. INSTRUCTIONS FOR PROPER USE



THIS MANUAL IS AN INTEGRAL PART OF THE APPLIANCE AND THEREFORE MUST BE KEPT IN ITS ENTIRETY AND IN AN ACCESSIBLE PLACE FOR THE WHOLE WORKING LIFE OF THE COOKER. WE ADVISE READING THIS MANUAL AND ALL THE INSTRUCTIONS THEREIN BEFORE USING THE COOKER. ALSO KEEP THE SERIES OF NOZZLES SUPPLIED. INSTALLATION MUST BE CARRIED OUT BY QUALIFIED PERSONNEL IN ACCORDANCE WITH THE REGULATIONS IN FORCE. THIS APPLIANCE IS INTENDED FOR DOMESTIC USES AND CONFORMS TO CURRENT **REGULATIONS IN FORCE**. THE APPLIANCE HAS BEEN BUILT TO CARRY OUT THE FOLLOWING FUNCTIONS: **COOKING AND HEATING-UP OF FOOD**. ALL OTHER USES ARE CONSIDERED IMPROPER.

THE MANUFACTURER DECLINES ALL RESPONSIBILITY FOR IMPROPER USE.

NEVER USE THIS APPLIANCE FOR HEATING ROOMS.



DO NOT LEAVE THE PACKING IN THE HOME ENVIRONMENT. SEPARATE THE VARIOUS WASTE MATERIALS AND TAKE THEM TO THE NEAREST SPECIAL GARBAGE COLLECTION CENTRE.



REPLACED APPLIANCES MUST BE TAKEN TO A SPECIAL GARBAGE COLLECTION CENTRE.



DO NOT OBSTRUCT VENTILATION OPENINGS AND HEAT DISPERSAL SLITS.



THIS APPLIANCE IS DESIGNED FOR COOKING FOOD AND IT SHALL NOT BE USED AS A SPACE HEATER.



THE I.D. PLATE WITH TECHNICAL DATA, REGISTRATION NUMBER AND BRAND NAME IS VISIBLY POSITIONED IN THE STORAGE COMPARTMENT.



**THE PLATE MUST NOT BE REMOVED.**

DO NOT USE METALLIC SPONGES OR SHARP SCRAPERS: THEY WILL DAMAGE THE SURFACE.

USE NORMAL NON-ABRASIVE PRODUCTS FOR STEEL, AND A WOODEN OR PLASTIC TOOL IF NECESSARY.

RINSE THOROUGHLY AND DRY WITH A SOFT CLOTH OR DEERSKIN.

DO NOT ALLOW RESIDUES OF SUGARY FOODS (SUCH AS JAM) TO SET INSIDE THE OVEN. IF LEFT TO SET FOR TOO LONG, THEY MIGHT DAMAGE THE ENAMEL LINING OF THE OVEN.



**The manufacturer declines all responsibility** for damage to persons or things caused by non-observance of the above prescriptions or by interference with any part of the appliance or by the use of non-original spares.



### 2. DISPOSAL INSTRUCTIONS – OUR ENVIRONMENT POLICY

Our appliances are only packaged using non-pollutant, environment-friendly, recyclable materials. We urge you to cooperate by disposing of the packaging properly. Contact your local dealer or the competent local organisations for the addresses of collection, recycling and disposal facilities.

Never leave all or part of the packaging lying around. Packaging parts, and especially plastic bags, may represent a suffocation hazard for children.

Your old appliance must also be disposed of properly.

**Important** deliver the appliance to your local organisation authorised to collect scrapped appliances. Proper disposal allows the intelligent recovery of valuable materials. Refrigeration appliances contain gases which may damage the environment; it is important to ensure that the refrigeration circuit pipelines are not damaged until the competent service has taken delivery of the appliance.

Before scrapping your appliances it is important to remove doors and leave shelves in position as for use, to ensure that children cannot accidentally become trapped inside during play. Also, cut the power supply lead and remove it and the plug.

### 3. SAFETY PRECAUTION



ELECTRICAL CONNECTION: PLEASE REFER TO INSTALLATION INSTRUCTION FOR THE GAS & ELECTRICAL SAFETY REGULATIONS AND THE VENTILATION REQUIREMENTS.

IN YOUR OWN INTEREST, AND THAT OF SAFETY, IT IS THE LAW THAT ALL GAS APPLIANCES BE INSTALLED AND SERVICE BY COMPETENT PERSONS, WHO WILL COMPLY WITH THE RELEVANT STANDARDS AND REGULATIONS.

CORGI REGISTERED INSTALLERS UNDERTAKE TO WORK TO SATISFACTORY STANDARDS. DISCONNECTION OF GAS AND ELECTRIC APPLIANCES SHOULD ALWAYS BE CARRIED OUT BY COMPETENT PERSON.

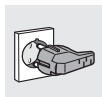

THE PLUG TO BE CONNECTED TO THE POWER CABLE AND THE SOCKET MUST BE THE SAME TYPE AND MUST CONFORM TO CURRENT REGULATIONS.

THE SOCKET MUST BE ACCESSIBLE AFTER THE APPLIANCE HAS BEEN BUILT IN.

**NEVER UNPLUG BY PULLING ON THE CABLE.**



**DO NOT INSTALL THIS APPLIANCE ON A RAISED PLATFORM.**

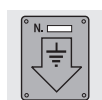

IT IS COMPULSORY THAT THE APPLIANCE BE GROUNDED ACCORDING TO THE METHODS REQUIRED BY SAFETY RULES.



IMMEDIATELY AFTER INSTALLATION CARRY OUT A BRIEF INSPECTION TEST OF THE APPLIANCE, FOLLOWING THE INSTRUCTIONS BELOW. SHOULD THE APPLIANCE NOT FUNCTION, DISCONNECT IT FROM THE SUPPLY AND CALL THE NEAREST TECHNICAL ASSISTANCE CENTRE. **NEVER ATTEMPT TO REPAIR THE APPLIANCE.**



**DO NOT PUT** PANS WITHOUT PERFECTLY SMOOTH AND FLAT BOTTOMS ON THE HOB GRIDS.

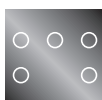

**ATTENTION:** IN CASE OF A CRACK BEING DETECTED IN THE GLAZED CERAMIC HOB, IMMEDIATELY DISCONNECT FROM MAINS AND CONTACT THE NEAREST SERVICING CENTRE.



NEVER PUT INFLAMMABLE OBJECTS IN THE OVEN: THEY COULD BE ACCIDENTALLY LIGHTED AND CAUSE FIRES.



**DURING USE THE APPLIANCE BECOMES VERY HOT.** TAKE CARE NOT TO TOUCH THE HEATING ELEMENTS INSIDE THE OVEN.



**THE APPLIANCE IS DESIGNED FOR USE BY ADULTS.** DO NOT ALLOW CHILDREN TO GO NEAR OR PLAY WITH IT.

WHEN OPERATING THE GRILL ALL ACCESSIBLE PARTS COULD BECOME VERY HOT: **KEEP OUT OF THE WAY OF CHILDREN.**



WHEN NOT IN USE, MAKE SURE THAT THE CONTROL KNOBS ARE IN THE CORRECT (OFF) POSITION 0.



DO NOT SPRAY AEROSOLS IN THE VICINITY OF THIS APPLIANCE WHILE IT IS IN OPERATION.



BEFORE THE APPLIANCE IS PUT INTO OPERATION, ALL THE LABELS AND PROTECTIVE FILMS APPLIED INSIDE OR OUTSIDE MUST BE REMOVED.



WHERE THIS APPLIANCE IS INSTALLED IN MARINE CRAFT OR IN CARAVANS, IT SHALL NOT BE USED AS A SPACE HEATER.



### 4. INTENDED USE OF THE APPLIANCE

THE APPLIANCE HAS BEEN BUILT TO CARRY OUT THE FOLLOWING FUNCTIONS: **COOKING AND HEATING-UP OF FOOD**. ALL OTHER USES ARE CONSIDERED IMPROPER.



*The manufacturer declines all responsibility for damage to persons or things caused by non-observance of the above prescriptions or by interference with any part of the appliance or by the use of non-original spares.*

### 5. BEFORE FIRST USE



Do not leave the packing in the home environment separate the various waste materials and take them to the nearest special garbage collection centre.



The inside of the appliance should be cleaned to remove all manufacturing residues. For further information about cleaning, see section "10. CLEANING AND MAINTENANCE"



Using the oven and the grill for the first time, heat them to the maximum temperature (**260 °C**) for as long as it takes to burn off any production oil residues which could give a nasty flavour to the food. After a power cut, the oven display will flash intermittently and show **0:00**. To adjust refer to paragraph "9. ELECTRONIC PROGRAMMER"





## Instructions for the user

### 6. USE OF THE HOB

#### 6.1 Cooking zone

The appliance features 4/5 cooking zones of different diameter and power. Their position is clearly indicated by circles and the heat given off is defined by the markings on the glass surface. The 5 cooking zones are of the HIGH-LIGHT type and come on after a few seconds of being activated. Heating intensity can be adjusted by means of the knobs located on the front panel from a minimum to a maximum.

The cooking zones marked by two concentric circles  and by a circle + fish-kettle  feature double heating either within the inner circle or both circles.



The 4/5 signal lamps located between the cooking zones come on when the temperature of one or more of the heating zones exceeds 60°C. The lamps go off upon temperature dropping to below approximately 60°C.

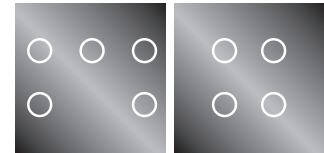

When using for the first time, it is advisable to heat up the cooking hob to its maximum temperature for enough time so as to burn off any possible oily manufacturing residues, the smell of which could otherwise be absorbed by the food.

For best results and energy saving, only use receptacles suitable for electric cooking:

- The bottom of the receptacles must be very thick and perfectly flat; before placing on the cooking hob, make sure that it, as well as the cooking hob itself, are perfectly clean and dry.
- To avoid scratching of the cooking hob, never use cast-iron receptacles or receptacles with a rough bottom.
- To avoid waste of energy, make sure that the diameter of the receptacle bottom is the same as that of the circle marked on the cooking hob.

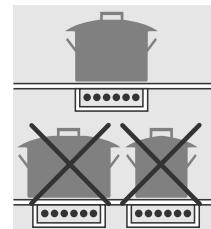

Take care not to spill sugar or sweet mixtures on to the cooking hob when hot. Never place materials or substances which may melt (plastic or aluminium foil) on to the cooking hob. In the event, promptly switch off and remove the molten material with the scraper provided while the top is still warm to prevent it from being damaged. **Failure to instantly clean the** glazed ceramic hob could lead to encrustations which are impossible to remove once the hob has cooled down.

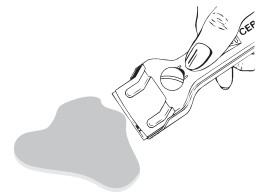

#### **Important.**

*Beware of children in the vicinity as the signal lamps indicating residual heat are out of sight to them. In fact, even after having been turned off, the cooking hob remains hot for a certain period of time.*

**Make sure that children never touch the cooking hob.**





## 7. FRONT CONTROL PANEL

All the cooker controls and commands are on the front panel.

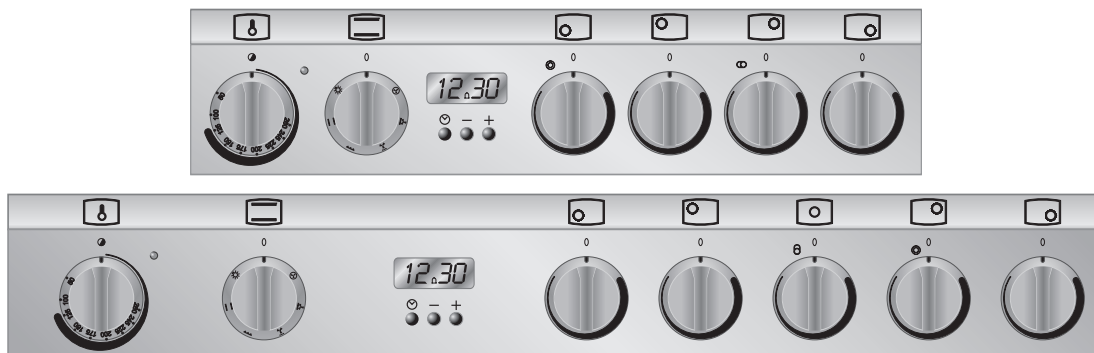

OVEN THERMOSTAT KNOB



OVEN FUNCTION KNOB



FRONT LEFT-HAND COOKING ZONE



REAR LEFT-HAND COOKING ZONE



CENTRAL COOKING ZONE



REAR RIGHT-HAND COOKING ZONE



FRONT RIGHT-HAND COOKING ZONE



Before using the oven make sure that the symbol  appears on the display. See paragraph "9. ELECTRONIC PROGRAMMER".

### COOKING HOB CONTROL KNOB

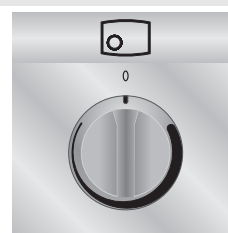

#### Standard heating

The circle next to each knob indicates the cooking zone it controls. To heat, turn the knob to the desired position. Adjustment is continuous so that the appliance also operates at any intermediate value. To turn off, return the knob to 0



#### Double heating

The circle next to each knob indicates the cooking zone it controls. To heat the inner cooking zone, turn the knob to the desired position.

To heat both the inner and outer cooking zones, turn the knob to  /  / ; and then release. The knob will spring back to 11.00 o'clock position.

To adjust the heating intensity, rotate the knob anticlockwise to the desired position back towards the "0" or "off" position.

To return to the heating of the inner cooking zone only, set the knob back to the "off" position and then turn clockwise to the desired position. To turn the heating off, turn the knob anticlockwise to the "0" or "off" position.

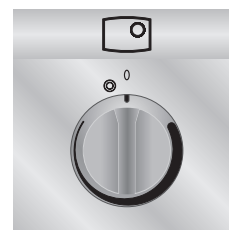
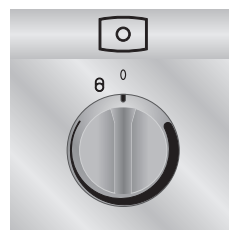



## Instructions for the user

### OVEN THERMOSTAT KNOB

Selection of cooking temperature is carried out by turning the knob clockwise to the required temperature, between **50°** and **260°C**.

If the appliance has an electric oven, the warning light will come on when the oven is heating up. When it goes out it means that the required temperature has been reached. Regular flashing means that oven temperature is being constantly maintained at the programmed level.

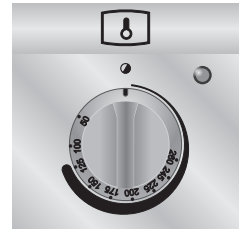

### OVEN CONTROL KNOB

Each of the functions listed below can be used (except the oven light and the small grill) only together with the correct temperature thermostat regulation as described on page 10 of this manual.

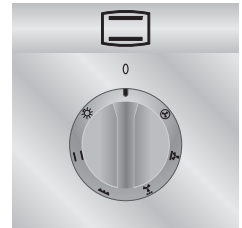

OVEN LIGHT



UPPER AND LOWER HEATING ELEMENT



GRILL ELEMENT



GRILL ELEMENT + VENTILATION



LOWER HEATING ELEMENT +  
VENTILATION



VENTILATED HEATING ELEMENT +  
VENTILATION



## 8. USE OF THE OVEN



For the models with electronic programmer, before using the oven make sure that the display shows the symbol .



**During and after use the accessible parts of the oven may be very hot, and children must always be kept at a distance.**

### 8.1 Warnings and general advice

Using the oven and the grill for the first time, heat them to the maximum temperature (260°C) for as long as it takes to burn off any production oil residues which could give a nasty flavour to the food. After a power cut, the oven display will flash intermittently and show . To adjust refer to paragraph "9. ELECTRONIC PROGRAMMER"



Oven accessories which may come into contact with foods are made from materials complying with the requirements of the current directive.



During cooking, do not cover the bottom of the oven with aluminium or tin foil and do not place pans or oven trays on it as this may damage the enamel coating. If you wish to use greaseproof paper, place it so that it will not interfere with the hot air circulation inside the oven.

To prevent problems caused by steam in the oven, open the door in two stages: half open (5 cm approx.) for 4-5 seconds and then fully open. To access food, always leave the door open as short a time as possible to prevent the temperature in the oven from falling and ruining the food.





### 8.2 Cooling system

The oven is equipped with a cooling system which automatically comes on upon a few minutes after the oven has been turned on.

Fans cause a steady outflow of air from above the door which may continue for a brief period of time even after the oven has been turned off.

### 8.3 Use of the electric grill

For short cooking times, for example for browning already-cooked meat, select the static grill function ; set the thermostat knob to maximum temperature (260°C) and adjust grill intensity by means of the variable grill knob. The ventilated grill function allows actual cooking to be done, thanks to the forced ventilation which lets heat penetrate inside the food. For this type of cooking select the ventilated grill function , set the thermostat knob to the desired cooking temperature (never more than 225°C) and adjust grill intensity by means of the variable grill knob. Cooking time must not exceed 60 minutes.

### 8.4 How to use the grill

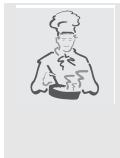

Once the grill is lit, the red warning light will come on. Leave the oven to heat up for five minutes before placing the food inside.

Food should be flavoured and basted with oil or melted butter before cooking. An oven dish should be used to contain the sauces. The food should be placed on the oven shelf which is positioned on one of the guides supplied with the different ovens, following the instructions below:



FOOD	GRILLE ON THE SHELF
Flat or thin meat	3
Rolled roast joints	2 - 3
Poultry	2 - 3







## Instructions for the user

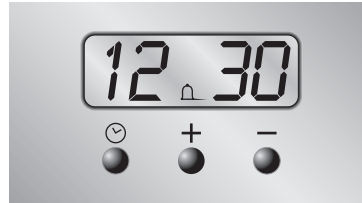



### 9. ELECTRONIC PROGRAMMER





#### LIST OF FUNCTIONS



-  END OF COOKING KEY
-  DECREASE TIME KEY
-  INCREASE TIME KEY

#### 9.1 Clock adjustment

When using the oven for the first time, or after a power failure, the display flashes regularly and indicates . Press the  key and use the keys  or  to set the current time.

#### 9.2 Setting the timer

To set the timer, press the  key and keep it pressed until the required number of minutes is shown. When the  key is released, after 5 seconds the countdown will start; once this finishes, an acoustic device will sound.

During the countdown the display will show the  symbol; pressing the  key displays the current time for 5 seconds.

#### 9.3 Deactivating the acoustic device

The acoustic device stops sounding automatically after seven minutes. It can be deactivated in manual mode by pressing the  key.

#### 9.4 Adjusting the volume of the acoustic device

The volume can be adjusted (3 settings) while it is in operation by pressing the  key.

#### 9.5 Modifying the data set

The timer data set can be modified at any moment by pressing the  or  keys.



## 10. CLEANING AND MAINTENANCE



*Never use a steam jet to clean the appliance.*

### 10.1 Cleaning stainless steel



*To maintain stainless steel in good condition clean it regularly after each use, once it has cooled down.*

### 10.2 Ordinary daily cleaning

To clean and preserve the stainless steel surfaces, always use **only** specific products that do not contain abrasives or chlorine-based acids.

**How to use:** pour the product on a damp cloth and wipe the surface, rinse thoroughly and dry with a soft cloth or deerskin.

### 10.3 Food stains or residues

Do not use metallic sponges or sharp scrapers: they will damage the surface.

Use normal non-abrasive products for steel, and a wooden or plastic tool if necessary.

Rinse thoroughly and dry with a soft cloth or deerskin.

Do not allow residues of sugary foods (such as jam) to set inside the oven. If left to set for too long, they might damage the enamel lining of the oven.



### 10.4 Cleaning the glazed ceramic hob



*Before any intervention, disconnect the power supply of the device*



*The cooking hob should be regularly cleaned; best after every use, once the residual heat signal lamps have gone off.*

Smudges from aluminium-bottom pans can be easily cleaned off with a cloth dampened in vinegar.

Remove any burnt residues after cooking with the scraper provided; rinse with water and wipe dry with a clean cloth. Regular use of the scraper considerably reduces the need for chemical detergents for the daily cleaning of the hob. Never use abrasive or corrosive detergents (e.g. cleaning powders, oven sprays, spot-removers, wire sponges).

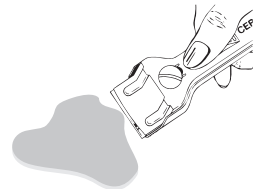



## Instructions for the user

### 10.5 Cleaning of oven



For best oven upkeep clean regularly after having allowed to cool. Take out all removable parts.

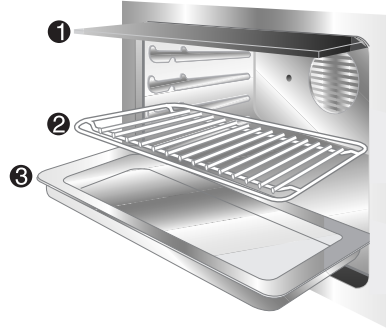
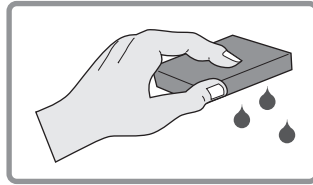

- Clean the oven grill with hot water and non-abrasive detergent. Rinse and dry.
- Do not allow residues of sugary foods (such as jam) to set inside the oven. If left to set for too long, they might damage the enamel lining of the oven.

### 10.6 Door glass

The door glass should always be kept clean. Use absorbent kitchen paper to clean. In case of tough spots, clean with a damp sponge using regular detergent.



*When cleaning, the appliance must be dried thoroughly since detergent and water drips might damage its operation and appearance.*



## 11. EXTRAORDINARY MAINTENANCE

The oven may require extraordinary maintenance or replacement of parts subject to wear such as seals, bulbs, and so on. The following instructions describe how to carry out these minor maintenance operations.

*Before any intervention, disconnect the power supply of the device.*



### 11.1 Replacement of light bulb

Remove cover **A** by twisting anticlockwise, replace bulb **B** with another similar bulb (25 W). Refit the cover **A**.

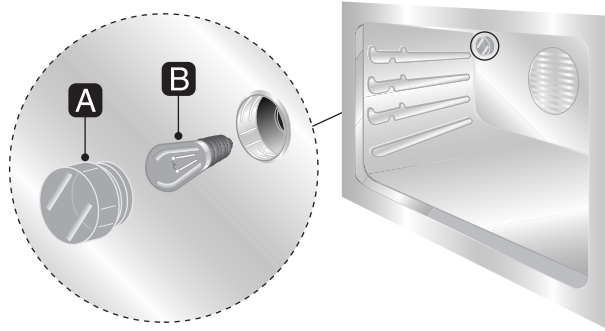

*Only use oven bulbs (T 300°C).*

### 11.2 Removing the door

Hold the door on both sides with both hands near hinges **A** and raise levers **B**. Lift up the door forming an angle of about 45° and remove. To refit, slide the hinges **A** in the grooves, drop the door and release levers **B**.

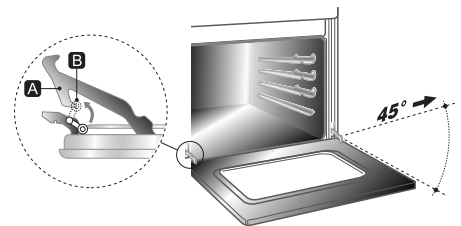

### 11.3 Oven door seal

To permit thorough cleaning of the oven, the seal may be removed. Before removing the seal, take off the door as described above. Once the door has been taken off, lift the tabs at the corners as shown in the figure.

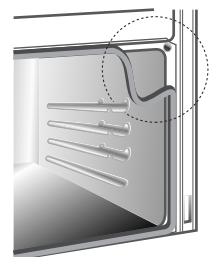



## Instructions for the installer

### 12. INSTALLATION OF THE APPLIANCE



It is the law that all gas appliances are installed by **competent persons**. Corgi gas installers are approved to work to safe and satisfactory standards. All gas installation, servicing and repair work must be in accordance with the gas safety regulations 1984 (installation and use) as amended 1990. This appliance may be installed next to a wall which is higher than the appliance, as shown in the diagram showing the correct installation conditions. Any wall cupboards or shelves must be at a distance of at least **750 mm** above the work surface.

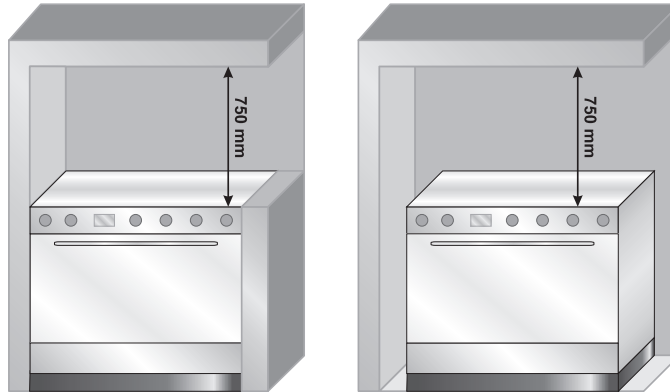

#### 12.1 Electrical connection



The I.D. plate with technical data, registration number and brand name is visibly positioned in the storage compartment.

**The plate must not be removed.**



If the appliance is connected to the supply by means of a fixed connection, install a multipolar cut-out device on the line, with contact opening distance equal to or greater than **3 mm**, located near the appliance and in an easily reachable position.

The connection terminals are located at the rear of the appliance. For electrical connections see following diagram. To access, remove the rear cover.

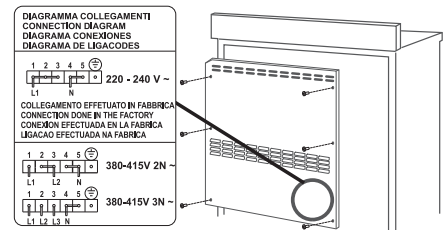

**For operation on 380-415V3N** : use an H05RR-F / H05RN-F / H05V2V2-F type five-core cable (5 x 2.5 mm<sup>2</sup>).

**For operation on 380-415V2N** : use an H05RR-F / H05RN-F / H05V2V2-F type five-core cable (cavo di 4 x 4 mm<sup>2</sup>).

**For operation on 220-240V** : use an H05RR-F / H05RN-F / H05V2V2-F (cavo di 3 x 6 mm<sup>2</sup>).

The cable end to be connected to the appliance must be provided with an ground wire (yellow-green) at least 20 mm longer.

**380-415V 3N** ~ 2,5 mm<sup>2</sup>

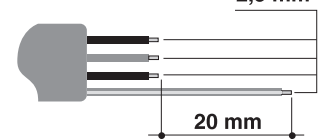

**380-415V 2N** ~ 4 mm<sup>2</sup>

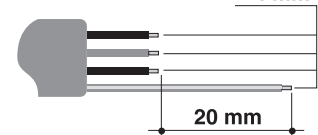

**220-240V** ~ 6 mm<sup>2</sup>

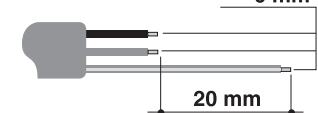



Complete wiring up to power supply with an appropriately rated five-core plug (see data plate) or, in case of operation from a **220-240V** power supply, with a three-core plug. Make sure that plug and wall socket are of the same type and are in conformity with regulations in force. Make sure that the appliance is properly earthed. Before powering, check that the power line is properly earthed. Avoid using adapters or shunters.



**The manufacturer declines all responsibility for damage to persons or things caused by non-observance of the above prescriptions.**

## 12.2 Wall fixing (where applicable)



**In order to prevent accidental tipping of the appliance, for example by a child climbing onto the open oven door, a stabilizing means must be installed. Please refer to instructions for installation.**

- Stretch out the chain attached to the cooker horizontally so that the other end touches the wall.
- Mark the wall in the position where the hole is to be drilled.
- Drill the hole, insert the finned dowels and attach the chain.
- Move the cooker up against the wall.

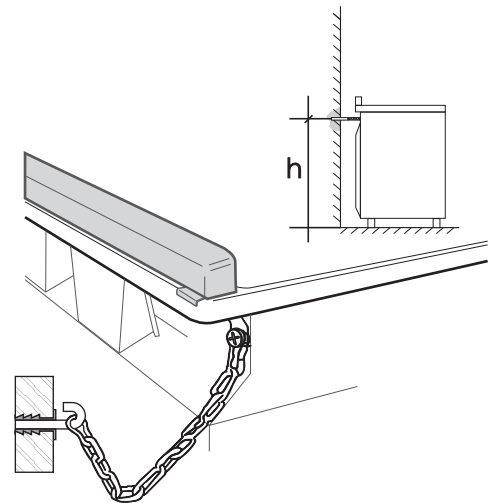

## 12.3 Mounting the rear top skirtboard (where applicable)

- Loosen nuts **B**.
- Position the skirt above the top, taking care to align pins **C** with holes **D**.
- Secure the skirt to the top by tightening screws **A**.

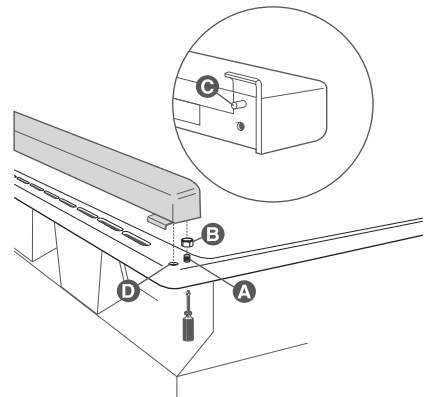





914773157/ C