

1. Instructions for safe and proper use	18
2. Front panel and commands	19
2.1 Front panel	19
2.2 Description of commands	20
3. Use of the oven	22
3.1 Warnings and general advice	22
3.2 Switching on the oven	22
3.3 Inside light bulbs	22
3.4 Cooling ventilation	22
4. Available accessories	23
4.1 Optional accessories	23
5. Cooking hints	24
5.1 Traditional cooking	24
5.2 Hot-air cooking	24
5.3 Grill cooking	24
5.4 Grill cooking with hot air	25
5.5 Delicate cooking	25
5.6 Defrosting	25
5.7 Recommended cooking table	26
6. Cleaning and maintenance	28
6.1 Cleaning stainless steel	28
6.2 Door glass	28
7. Extraordinary maintenance	29
7.1 Replacement of oven light bulbs	29
7.2 Cleaning of hot air fan	29
7.3 Removing the door	30
7.4 Cleaning the inside of the window on the door	30

1. Instructions for safe and proper use



THIS MANUAL IS AN INTEGRAL PART OF THE APPLIANCE AND THEREFORE MUST BE KEPT IN ITS ENTIRETY AND IN AN ACCESSIBLE PLACE FOR THE WHOLE WORKING LIFE OF THE OVEN. WE ADVISE CAREFUL READING OF THIS MANUAL AND ALL THE INSTRUCTIONS THEREIN BEFORE USING THE OVEN. INSTALLATION MUST BE CARRIED OUT BY QUALIFIED PERSONNEL IN ACCORDANCE WITH THE REGULATIONS IN FORCE. THIS APPLIANCE IS INTENDED FOR DOMESTIC USES AND CONFORMS TO CURRENT **REGULATIONS IN FORCE**. THE APPLIANCE HAS BEEN BUILT TO CARRY OUT THE FOLLOWING FUNCTIONS: **COOKING AND HEATING-UP OF FOOD**. ALL OTHER USES ARE CONSIDERED IMPROPER.

THE MANUFACTURER DECLINES ALL RESPONSIBILITY FOR IMPROPER USE.



DO NOT LEAVE THE PACKING IN THE HOME ENVIRONMENT. SEPARATE THE VARIOUS WASTE MATERIALS AND TAKE THEM TO THE NEAREST SPECIAL GARBAGE COLLECTION CENTRE.



IT IS OBLIGATORY FOR THE ELECTRICAL SYSTEM TO BE GROUNDED ACCORDING TO THE METHODS REQUIRED BY SAFETY RULES.



THE PLUG TO BE CONNECTED TO THE POWER CABLE AND THE SOCKET MUST BE THE SAME TYPE AND MUST CONFORM TO CURRENT REGULATIONS.

NEVER UNPLUG BY PULLING ON THE CABLE.



DO NOT OBSTRUCT VENTILATION OPENINGS AND HEAT DISPERSAL SLITS.



IMMEDIATELY AFTER INSTALLATION CARRY OUT A BRIEF INSPECTION TEST OF THE OVEN, FOLLOWING THE INSTRUCTIONS BELOW. SHOULD THE APPLIANCE NOT FUNCTION, DISCONNECT IT FROM THE SUPPLY AND CALL THE NEAREST TECHNICAL ASSISTANCE CENTRE.

NEVER ATTEMPT TO REPAIR THE APPLIANCE.



ALWAYS CHECK THAT THE CONTROL KNOBS ARE IN THE "ZERO" (OFF) POSITION WHEN YOU FINISH USING THE OVEN.



NEVER PUT INFLAMMABLE OBJECTS IN THE OVEN: THEY COULD BE ACCIDENTALLY LIGHTED AND CAUSE FIRES.



THE I.D. PLATE WITH TECHNICAL DATA, REGISTRATION NUMBER AND BRAND NAME IS POSITIONED VISIBLY ON THE UPPER CASING, ATTACHED TO THIS MANUAL AND APPLIED TO THE QUALITY CERTIFICATE.

THE PLATE ON THE CASING MUST NOT BE REMOVED.



THE OVEN IS TO BE USED BY ADULTS ONLY. DO NOT LET UNSUPERVISED CHILDREN PLAY WITH OR IN THE OVEN.



THIS APPLIANCE IS MARKED ACCORDING TO THE EUROPEAN DIRECTIVE 2002/96/EC ON WASTE ELECTRICAL AND ELECTRONIC EQUIPMENT (WEEE).

THIS GUIDELINE IS THE FRAME OF A EUROPEAN-WIDE VALIDITY OF RETURN AND RECYCLING ON WASTE ELECTRICAL AND ELECTRONIC EQUIPMENT.



BEFORE THE APPLIANCE IS PUT INTO OPERATION, ALL THE LABELS AND PROTECTIVE FILMS APPLIED INSIDE OR OUTSIDE MUST BE REMOVED.



The manufacturer declines all responsibility for damage to persons or things caused by non-observance of the above prescriptions or by interference with any part of the appliance or by the use of non-original spares.

2. Front panel and commands

2.1 Front panel

All of the commands and controls for the oven are found on the front panel.

6-FUNCTIONS MODEL



8-FUNCTIONS MODEL

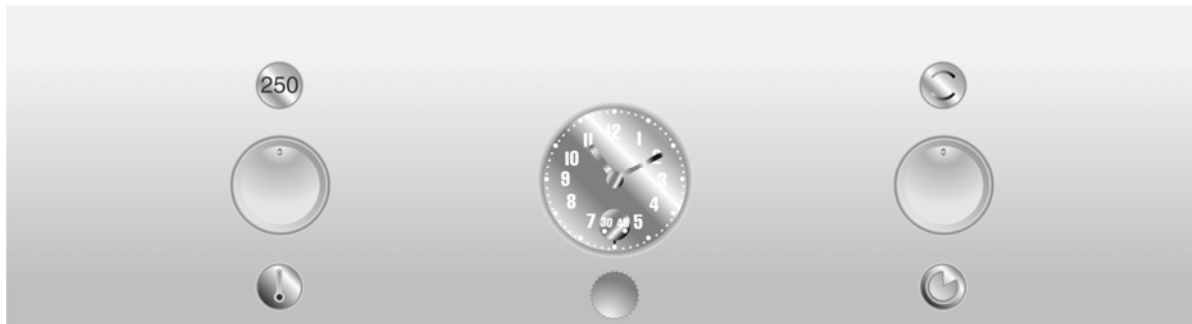









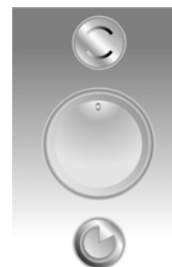



2.2 Description of commands

FUNCTION SWITCH KNOB

Selects the desired cooking functions. The symbols are shown below.

Turning the knob the various function symbols light up, simultaneous with the timer and internal oven light indicators.



- | | | | |
|---|--|---|---|
|  | NO FUNCTION SET |  | GRILL ELEMENT |
|  | UPPER AND LOWER HEATING ELEMENT |  | UPPER AND LOWER HEATING ELEMENT + VENTILATION |
|  | LOWER HEATING ELEMENT |  | WIDE GRILL ELEMENT + VENTILATION |
|  | WIDE GRILL ELEMENT |  | GRILL ELEMENT + VENTILATION |
|  | LOWER HEATING ELEMENT + VENTILATION |  | DEFROSTING |
|  | UPPER AND LOWER HEATING ELEMENT + VENTILATED HEATING ELEMENT |  | VENTILATED HEATING ELEMENT + VENTILATION |

THERMOSTAT KNOB

Selection of cooking temperature.

Turn the knob clockwise to the required temperature, between **50°** and **250°**C. The temperature light indicates that the oven is in heating-up phase.

When this light goes out, the preset heating temperature has been reached.

The light will come on periodically during use to indicate that the oven is being kept at the set temperature by a thermostat.



TIMER KNOB

Lets you choose manual cooking or the timer with automatic turn-off of the oven when done.

For manual control of cooking time, turn the knob anticlockwise to the symbol .

To set cooking time turn the knob clockwise. The numbers from **10** to **120** correspond to minutes. Adjustment is progressive and intermediate positions between the numbers shown may be used.

At the end of programmed cooking an intermittent sound signal is emitted. This can be de-activated by turning the function selector knob to the position .

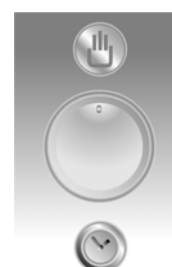

CLOCK WITH END OF COOKING TIME

This permits manual selection of cooking and manual setting of cooking time.

Knob **A** must always be turned **CLOCKWISE**.

Activate the required function and temperature before setting cooking time.

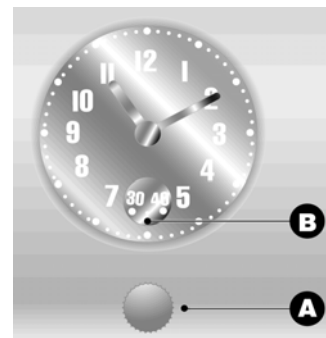

Setting the time

To set the time, **PULL OUT** knob **A** and turn it clockwise.



Manual cooking

To use the cooker in manual cooking mode you must turn knob **A** clockwise until the symbol  appears in window **B**.

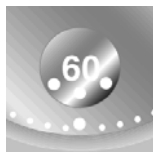

Timed cooking

To set cooking time (window **B**) turn knob **A** clockwise.



Expiration of cooking time

The oven will turn off automatically and a buzzer will sound (.

De-activation of sound signal

This can be done by turning the FUNCTION SELECTOR knob to position **0**.

3. Use of the oven

3.1 Warnings and general advice



Using the oven for the first time, heat it to the maximum (250°C) for sufficient time to burn away any oily residues from manufacture.

The heating elements and the fan are de-activated when the oven door is opened.

If you have to do something with the food in the oven, leave the door open for the shortest possible time so that the internal temperature doesn't drop to the extent of spoiling the cooking.

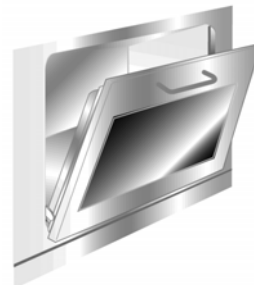

3.2 Switching on the oven

- Select the required function with the function selector knob;
- select manual cooking (or a cooking time as indicated in the paragraph "2.2 Description of commands");
- select the temperature with the thermostat knob.

3.3 Inside light bulbs

Turn on the inside light bulbs by turning the function selector knob to any position or by opening the door with the oven turned off.

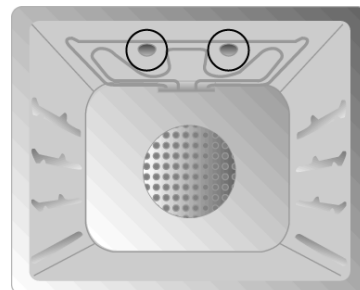

3.4 Cooling ventilation

The appliance is equipped with a cooling system which comes into operation when the oven is switched on.

When the fans are on they cause a normal air flow to come out from the top and bottom of the door, which will continue for a short time after the oven has been switched off.

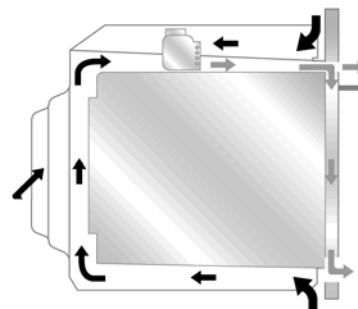

4. Available accessories

The oven features **4 support** positions for plates and grills of different height.

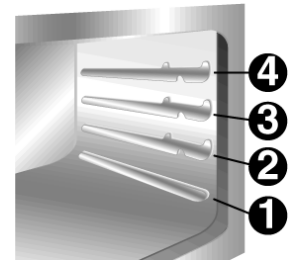

Grill for supporting recipients with food being cooked.

Grill to place above glass plate or above the oven grill for grilling foods.

Glass plate suitable for cooking and also useful for collecting fats from foods placed on the grill.

Chromium-plated tubular gripper for removing hot food from plates or grills, thus avoiding direct contact.



4.1 Optional accessories



Aluminium plate used for cakes, pizzas and oven desserts.
Cod. 050370251

Pyrex dish with glass cover: closed container which stops food and splashes from dirtying the sides of the oven during cooking.

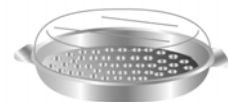

Ask your authorised dealer for original accessories.

5. Cooking hints

5.1 Traditional cooking

FUNCTION SWITCH	
THERMOSTAT SELECTOR SWITCH FROM 50° TO 250°C	

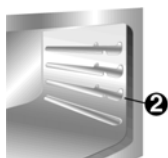

This classic cooking system, with the heat coming from below and above, is suited to cooking foods on one level only. Preheat the oven to the required temperature and put the food in the oven only after the thermostat light has gone out. Deep-frozen meat can be put directly into the oven without defrosting. The only precaution to take is to select lower temperatures, around 20°C, and cooking times about 1/4 longer than fresh meat cooking times. Very fat meat can be put in when the oven is still cold.

5.2 Hot-air cooking

FUNCTION SWITCH	
THERMOSTAT SELECTOR SWITCH FROM 50° TO 250°C	

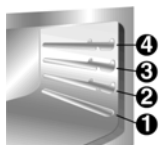

This system is suitable for cooking different foods and on more than one level (fish, meat etc.) without mixing of tastes and smells. The circulation of air in the oven ensures uniform heat. No preheating is required.

5.3 Grill cooking

FUNCTION SWITCH	
THERMOSTAT SWITCH AT MAXIMUM AND DOOR CLOSED	

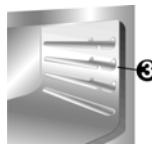

This permits rapid golden-browning of foods. For longer cooking periods and grilling on wide surfaces it is better to insert the grill on a lower guide-slot, depending on the size of the pieces to be cooked.

5.4 Grill cooking with hot air



FUNCTION SWITCH



THERMOSTAT SWITCH AT MAXIMUM AND DOOR CLOSED

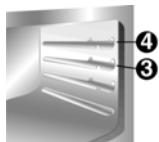

This permits a uniform distribution of heat and a greater penetration in depth. Food is lightly golden-browned on the outside while remaining soft inside.

Maximum cooking time 60 minutes.

5.5 Delicate cooking



FUNCTION SWITCH



THERMOSTAT SELECTOR SWITCH FROM 50° TO 250°C

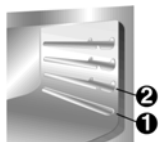

Suitable for pastries, cakes and non-dry sweets in baking tins or moulds. Excellent results are also obtained in cooking requiring above all heat from the bottom. You are advised to put the pan on a low level.

5.6 Defrosting



FUNCTION SWITCH



THERMOSTAT SWITCH IN POSITION 0

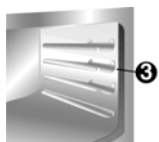

Food can be rapidly defrosted by the movement of air at room temperature.



The advantage of defrosting at room temperature is that it does not alter the taste and appearance of the food.

5.7 Recommended cooking table

Cooking times, especially meat, vary according to the thickness and quality of the food and to consumer taste.

TRADITIONAL COOKING 			
	LEVEL FROM BELOW	TEMPERATURE (°C)	TIME IN MINUTES (*)
FIRST COURSES			
LASAGNE	2 - 3	200 - 210	50 - 60
OVEN-BAKED PASTA	2 - 3	210 - 230	40
MEAT			
ROAST VEAL	2	170 - 200	30 - 40 / KG.
ROAST BEEF	2	210 - 250	30 - 40 / KG.
ROAST PORK	1 - 2	180 - 200	100 - 110
CHICKEN	1 - 2	180 - 200	80 - 90
DUCK	2	180 - 200	110 - 130
GOOSE - TURKEY	2	140 - 170	45 - 60
RABBIT	2	170 - 200	100 - 120
LEG OF LAMB	2	170 - 200	40 - 50
FISH	1	170 - 200	ACCORDING TO DIMENSIONS
PIZZA	1 - 2	220 - 250	20 - 25
DESSERTS			
SHORT PASTRY	1 - 2	170 - 200	15 - 20
CIAMBELLA	1 - 2	170	60 - 70
BRIOCHES	1	180 - 200	30 - 40
FRUIT CAKE	1 - 2	170 - 200	20 - 30
PARADISE CAKE	1 - 2	160	60
APPLE CAKE	1	200	60
RICE CAKE	1	180	60 - 70

(*) = WITH PREHEATED OVEN

GRILLING 			
	LEVEL FROM BELOW	TIME IN MINUTES	
		FIRST SURFACE	SECOND SURFACE
PORK CHOPS	4	7 - 9	5 - 7
FILLET OF PORK	3	9 - 11	5 - 9
FILLET OF BEEF	3	9 - 11	9 - 11
LIVER	4	2 - 3	2 - 3
VEAL ESCALOPES	4	7 - 9	5 - 7
HALF CHICKEN	3	9 - 14	9 - 11
SAUSAGES	3	7 - 9	5 - 6
MEAT-BALLS	3	7 - 9	5 - 6
FISH FILLETS	3	5 - 6	3 - 4
TOAST	3	2 - 4	2 - 3

HOT-AIR COOKING



	LEVEL FROM BELOW	TEMPERATURE (°C)	TIME IN MINUTES (*)
FIRST COURSES			
LASAGNE	2	190 - 210	40 - 50
OVEN-BAKED PASTA	2	190 - 210	25 - 30
MEAT			
ROAST VEAL	1 - 2	150 - 170	65 - 90
ROAST PORK	1 - 2	150 - 160	70 - 100
ROASTED BEEF	1 - 2	160 - 170	65 - 90
FILLET OF BEEF	1 - 2	160 - 180	35 - 45
ROAST LAMB	1 - 2	130 - 150	100 - 130
ROAST BEEF	1 - 2	170 - 180	40 - 45
ROAST CHICKEN	1 - 2	170	70 - 80
ROAST DUCK	1 - 2	170 - 180	100 - 120
ROAST TURKEY RUMP	1 - 2	160 - 170	90
ROAST RABBIT	1 - 2	160 - 170	80 - 100
ROAST HARE	1 - 2	160 - 170	30 - 50
ROAST PIGEON	1 - 2	140 - 170	15 - 25
FISH	2 - 3	150 - 170	ACCORDING TO DIMENSIONS
PIZZA	2 - 3	210 - 230	15 - 20
BREAD	2 - 3	190 - 210	40
TOAST	1 - 2	220 - 250	7
DESSERTS			
CIAMBELLA	2 - 3	150 - 170	35 - 45
FRUIT CAKE - FRUIT FLAN	2 - 3	170 - 190	35 - 40
BRIOCHES	2 - 3	160 - 170	20 - 25
SHORT PASTRY	2 - 3	170 - 180	20
RICE CAKE	2 - 3	170	50 - 60
APPLE CAKE	2 - 3	180	60
PARADISE CAKE	2 - 3	160	60

(*) = WITH PREHEATED OVEN

6. Cleaning and maintenance



Before any intervention, disconnect the power supply of the device.

6.1 Cleaning stainless steel



To keep the oven in good condition, you should clean it at regular intervals (after it has cooled). Take out all removable parts.



6.1.1 Routine cleaning of oven

To clean and preserve the stainless steel surfaces, always use **only** specific products that do not contain abrasives or chlorine-based acids.

How to use: pour the product on a damp cloth and wipe the surface, rinse thoroughly and dry with a soft cloth or deerskin.

6.1.2 Food stains or residues

Do not use metallic sponges or sharp scrapers: they will damage the surface. Use normal, non-abrasive products for steel together with non-scratch sponges and, if necessary, wooden or plastic utensils.

For particularly stubborn stains or burns, use special oven detergents. Rinse thoroughly and dry with a soft cloth or deerskin.



6.2 Door glass

You are advised to keep it very clean, washing with a damp sponge and ordinary detergent.

7. Extraordinary maintenance

The oven will on occasion need minor maintenance or replacement of parts subject to wear. Specific instructions for each of these procedures appears below.



Before any intervention, disconnect the power supply of the device.

7.1 Replacement of oven light bulbs

Remove upper oven protection **A** and ring **B** as well as the glass cover **C**, unscrewing it anticlockwise. Replace light bulb **D**. Reassemble ring **B**, cover **C** and upper protection **A**.

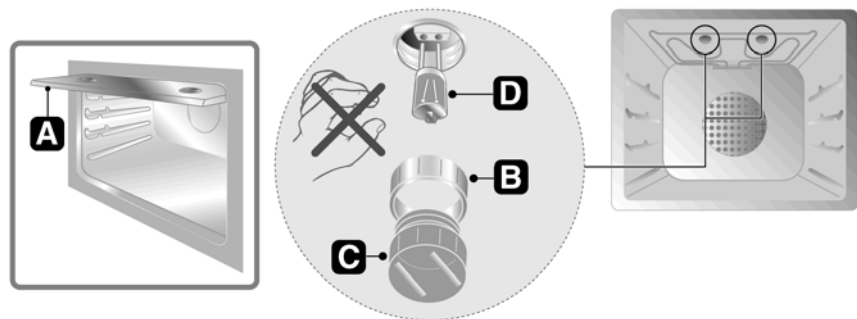

*The standard bulbs are halogen: **do not touch them directly with your fingers.** Use insulation to protect your hand. Use only bulbs that are available at authorised service centres.*

7.2 Cleaning of hot air fan

The fan has to be cleaned at regular intervals. Remove the rear deflector by unscrewing nuts **E**. With your hand keep the blades stopped and, using a coin, loosen the central ring nut **F**, rotating clockwise.

In this way, it is easier to remove any cooking residues, preventing them from burning the next time the oven is used.

After having cleaned the fan, reassemble it and the rear deflector, proceeding in the opposite order with respect to the disassembly instructions.

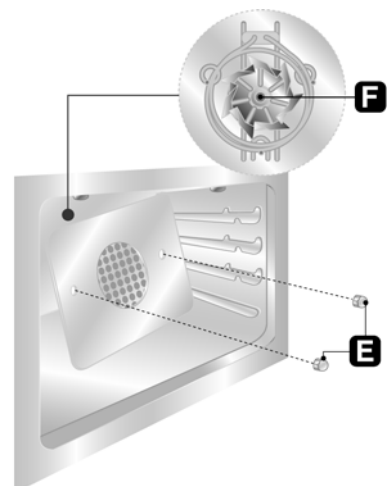

7.3 Removing the door

Use the two splines:

open the door, insert the splines **G** into the slit of the hinges and push them towards the oven. Half-close the door upward to form an angle of approximately 45°, then lift up and slide off. For re-assembly, insert the hinges into its groove then let the door rest downwards and extract splines **G**

or

use two pins:

open the door completely and fit the pins **H** into the holes from the inside. Close the door to an angle of about 45°, lift it and remove it from its seat. To replace, fit the hinges into the grooves provided, then lower the door until it comes to rest and extract the pins. If the pins are lost, two screwdrivers can also be used.

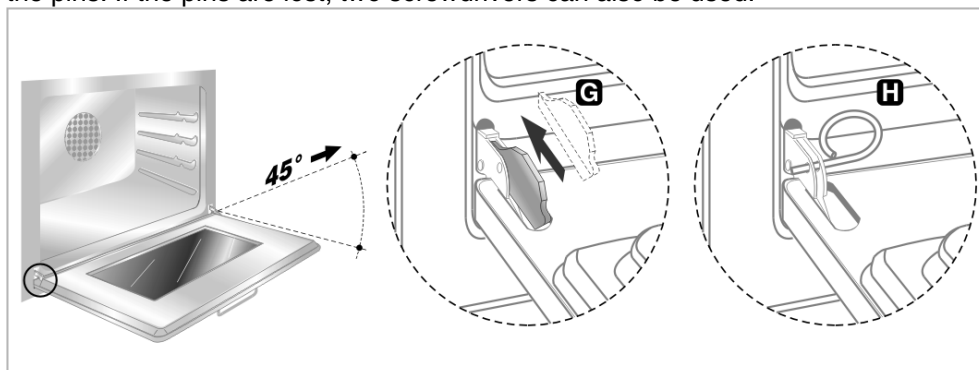

7.4 Cleaning the inside of the window on the door

The internal surfaces of the door glass can be cleaned by disassembling the components of the door itself. Proceed as described in paragraph "7.3 Removing the door"; loosen the 3 fastening screws and, by means of a screw-driver, lever upwards. Once the two door components have been separated, it is possible to carry out the cleaning of the internal surfaces of the glass. To reassemble the door, follow these instructions in reversed order.

