

MOFFAT 

M 1 0 0 , M 2 0 0 & M 3 0 0
BUILT-IN OVEN & GRILL UNITS

INSTRUCTION BOOK

YOU AND YOUR NEW COOKER – A GREAT TEAM

You'd be amazed how many good cooks use gas – research has shown that it's the preferred fuel for cooking by both professionals and home cooks.

If you've never cooked with gas before, you'll be pleasantly surprised by the speed and economy and how easy it is to use.

You'll also find that food actually tastes better, because gas is a moist heat which means whatever you're cooking in the oven has less chance to dry out.

Now your new cooker's here, you probably can't wait to get cooking, but before you do, take time out to read through this booklet which is designed to help you make the most of all the features of your new cooker. In particular it is important that you read and understand the advice highlighted in ***bold italics***. ***This has been included for you and your family's safety. A cooker becomes hot with use and retains its heat for a long period of time after use. Whilst it has been designed and manufactured to the relevant British Standards care should be taken when either using or cleaning it.***

The cooker is designed to be used by adults to cook edible foodstuffs and must not be used for any other purposes. Children, babies and toddlers should be kept away from the cooker at all times.

Please ensure that you retain this instruction book and make it available to guests etc. who may want to use the cooker. Also pass it on with the cooker if you give or sell it to another user.

The Installation Instructions provided with your cooker give instructions on how and where it can be fitted. If already installed you should satisfy yourself that all requirements have been met, if in doubt check with a competent person. More details on installation are given on page 24.

CONTENTS	Page
Ignition	2
The grill	3
The oven	4
Oven temperature chart	6
Cooking charts	7
The oven programmer	
300 model	10
200 model	13
Slow cooking	17
Care and Cleaning	21
Installation	24
General information	25
Servicing	29

IGNITION

It is not possible to use the grill and oven at the same time. If the oven is alight, the door opened and the grill control turned on, the oven burner will go out and the grill burner will light. ***This is a safety feature and should not be used as a method of igniting the grill.***

To light the grill, open the door, push then turn the appropriate control knob in an anti-clockwise direction until full on (large flame ) is reached.

To light the oven, when set for manual operation, push in and turn the oven control to gas mark 9, the oven will light automatically then turn the control back to the gas mark required. For automatic control see page 11.

To turn off any burner, push in and turn the appropriate control in a clockwise direction to the 'OFF' position marked . ***Do not leave the cooker until the flame has gone out.***

In the event of an electric power failure, the grill burner may be lit with a match. It is not possible to use the oven.

THE GRILL

Grilling is becoming a very popular method of cooking in our 'health conscious' society as the fat content of foods such as meat is reduced. Often the addition of fat or oil can be omitted.

Most foods that are to be grilled benefit from being seared quickly on the outside and then the heat adjusted in order to achieve the desired results.

Before using the grill open the door and leave it in the open or partially open position. Should the door be closed the grill burner will go out and there will be a continuous sparking. ***The vitreous enamelled oven roof must be removed before lighting the grill.***

The grill pan should be positioned on the servery shelf which can be positioned on any of the runner positions. You can reverse the grid to suit different types of food. The servery and pan will remain in position if pulled out using either oven gloves or the wire attachment provided. ***The wire attachment must not be left on the servery shelf when grilling.*** Hook over only when pushing in or pulling out the servery. ***Never attempt to lift the grill pan/meat tin using the wire attachment.***

It is usually unnecessary to pre-heat your gas grill, this saves time and energy. You may wish to pre-heat for just a couple of minutes when cooking meat such as steak.

Foods such as toast, teacakes and muffins are best if positioned towards the centre of the grid. Those foods requiring less heat e.g. tomatoes and mushrooms can be spaced towards the edge. Arrange meat, meat products and fish to suit their thickness and how you like them cooked.

When cleaning never use caustic or spray cleaners and never place combustible materials near the grill.

THE OVEN

The oven is probably the most versatile part of your appliance as it can be used to cook such a wide range of items including stews, custards, cakes and pastries.

Heat Zones

The unique design of your gas oven creates zones of heat within the oven. The temperature on the middle shelf corresponds to the gas mark setting you have chosen, the top of the oven is slightly hotter and the lower shelf slightly cooler. The base of the oven is quite a lot cooler. You can utilise these heat zones by cooking foods requiring different heat settings all at the same time.

If more than one tray of similar items e.g. biscuits or sponges are baked together, the trays should be interchanged during cooking, or the top tray should be removed when cooked and the lower tray moved to the higher shelf to finish cooking.

Pre-heating

Pre-heating is unnecessary, this of course makes cooking in a gas oven very economical. The exception to the 'no pre-heat' rule is when cooking sensitive foods such as souffles, Yorkshire pudding and yeast mixtures when a 20 minute pre-heat is adequate.

Oven Roof

The oven roof must be positioned on the top runner position when using the oven. To remove the roof, for cleaning or grilling, slide forward. ***When replacing ensure that the roof is replaced correctly as indicated by the words 'top front'. Make sure the roof is pushed back as far as it will go.***

Please note – incorrect positioning of the roof will affect the cooking performance.

Oven Shelves

The two oven shelves can be slotted into place in any of 4 positions – simply pull the shelf forward as far as it will go, raise the front edge and lift. To replace in a new position keep the front edge raised, slot the shelf into the runner, lower front edge and slide in.

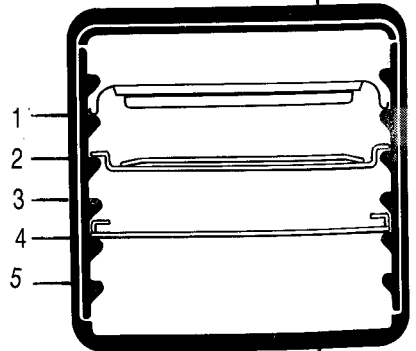

The diagram shows the oven roof positioned on runner one.

Ensure that shelves are put in place in the correct way.

The shelf positions are counted from the top downwards and directions for using the various shelf positions are given on the cooking charts on pages 7, 8 and 9. When cooking always try to leave at least one runner position between shelves to allow the heat to circulate properly.

Baking Trays and Dishes

To allow heat to circulate around the oven it is advisable to leave a 13mm (½") space between all dishes and the sides of the oven.

Cooking dishes, trays etc must never be placed over the burner.

Dishes, especially those with tapered sides, should not be pushed too far back as food might burn because it overhangs the burner flames.

The baking tray we supplied with your cooker has been specially designed and tested to suit the size of your oven. Small items may be cooked on this tray and large tins and dishes should not exceed this size.

Position single dishes, cake tins etc. on the centre of the shelf, large items may benefit from being turned during the cooking time.

To help pastry to brown on the underside, cook on a dull flat tinned plate, or providing the plates are flat and have no rim underneath, place on a baking tray to cook.

Plates can be warmed in the oven which should be set to 'S'.

Notes

Under certain conditions condensation may form on the cooker. Condensation is quite normal and forms when moisture and heat is present, e.g. during cooking. A boiling kettle produces steam and similarly when food gets to cooking temperature steam is also produced which condenses on to the cooler surfaces. It is not necessarily caused by extremes of temperature but as a result of one or more of the following:-

1. The cooking temperatures.
2. Temperature of the food when placed in the oven.
3. Moisture present in the food.
4. Quantity of food.
5. The temperature and ventilation in the kitchen.

Ideal cooking conditions are not always available but where possible ensure foods which contain a lot of moisture, e.g. casseroles are covered.

Try to wipe up condensation as it occurs.

OVEN TEMPERATURE CHART

The following chart is intended to be helpful if using a gas oven for the first time or when using a recipe which says 'cook at 350°F' or 'use a moderately hot oven' etc. The temperatures quoted are only a guide they are not actual temperatures in the oven.

The gas marks given are intended as a guide only and it may be necessary to increase or decrease the gas mark to suit individual preferences or requirements.

Please note that whilst the descriptions below may be 'Cool', 'Warm' or 'Moderate', the shelves and cooking dishes will be hot to the touch.

Gas Mark	Approximate Equivalent Electric Oven Setting	Temperature Description
1	275°F - 300°F 140°C	Cool
2	300°F 150°C	Cool
3	325°F 160°C	Warm
4	350°F 180°C	Moderate
5	375°F 190°C	Fairly Hot
6	400°F 200°C	Hot
7	425°F 220°C	Hot
8	450°F 230°C	Very Hot
9	500°F 260°C	Very Hot

COOKING CHARTS

The following charts give guidance for when cooking a number of foods.

However for convenience (to accommodate an extra deep dish for instance) or to brown and cook food to your liking you may alter the shelf position or the gas mark.

Always leave at least one runner position between shelves to allow the heat to circulate properly.

The word 'cranked' refers to the shelf fitted with the servery, i.e. the one used for grilling.

Meat Roasting

Food	Gas Mark	Shelf Position	Cooking Time and Remarks
ROAST MEAT	5	4	20 mins. per ½ kg (lb), 20 mins. over
	5	4	25 mins. per ½ kg (lb), 25 mins. over
	5	4	30 mins. per ½ kg (lb), 30 mins. over
			All joints of meat may be roasted at gas mark 7, and the cooking time adjusted accordingly.
ROAST POULTRY	5 or 6	4 or 5	20 mins. per ½ kg (lb), 20 mins. over

For poultry weighing more than 3.5 kg (7 lb); – place in a suitably sized roasting tin – time allowed per kg should be decreased – extra care should be taken to ensure the poultry is thoroughly cooked – during cooking it may be necessary to drain off some of the juices to prevent spillage – poultry should be positioned in such a way that it does not overhang the burner flame or touch the sides of the oven. If diagonal positioning is necessary ensure that the 'neck end' is towards the front of the oven.

Oven Cooking

Food	Gas Mark	Shelf Position	Cooking Time and Remarks
PUDDINGS			
Baked Sponge Puddings	4	3	According to recipe.
Baked Custards	3	3	45-60 mins. Custards should be stood in a water bath whilst cooking.
Milk Puddings	2	3	2-3 hours
Yorkshire Puddings – large	7	2	30-35 mins.
– individual	7		10-15 mins.
PASTRY			
Short Crust:			
Fruit Pie in dish	6	3	According to recipe.
Plate Tarts –			
Single	6	3	35-40 mins. To help pastry brown on underside,
2 together in the oven.	6	2 cranked and 5	50-55 mins. cook on a dull flat tinned plate, or (Interchange providing plates are flat and have after 35 mins.) no rim underneath, place on baking tray to cook.
Jam Tart – large	6	3	25-30 mins.
Jam Tartlets	6	3	15-20 mins.
Rough Puff or Flaky Pastry:			
Meat Pies – cooked filling	7	2 or 3	According to recipe.

Oven Cooking

Food	Gas Mark	Shelf Position	Cooking Time and Remarks
YEAST MIXTURES			
Bread - 0.45 kg (1 lb loaves)	7	2 cranked and 5	According to recipe. Interchange during cooking.
Bread - 0.90 kg (2 lb loaves)	7	2 cranked and 5	
Rolls or Buns	7	3 or 4	
BISCUITS			
Brandy Snaps	4	2 cranked and 4	According to recipe. Interchange during cooking. If cooking single trays cook near the centre of the oven.
Flapjacks	3	4	
Shortbread Biscuits	3 or 4	2 cranked and 4	
Shortbread	3	3	
CAKES			
Very Rich Fruit Cake	A c c o r d i n g t o r e c i p e .		
Rich Fruit Cake	2	4	According to recipe.
Plain Fruit Cake	4	3 cranked	
Madeira Cake	3	3 cranked	20-35 mins. According to recipe.
Victoria Sandwich	4	2 and 4 cranked	
Fatless Sponge	4	2 and 4 cranked	See Notes above on Biscuits.
Small Cakes	5	2 and 4 cranked	
SCONES			
Sweet or Savoury	7	2 and 4 cranked	8-15 mins. See Notes above on Biscuits.

THE OVEN PROGRAMMER – 300 model

Please note that this is a 24 hour clock, for example 2.00 p.m. is shown as 1400.

Under certain lighting conditions the digital display may flicker, this does not indicate a fault.

In the following paragraphs we explain how to set the controls. Read through them a few times until you're familiar with how easy it is. A plastic card has been supplied as a quick reference for setting the programmer.

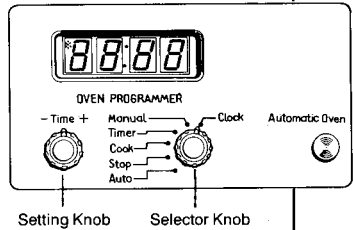

If the cooker is switched off at the socket outlet the clock will stop. When the electricity supply is first switched on, a series of dashes will appear in the display.

To Set the Time

Turn the selector knob to clock.

Set the correct time by turning the setting knob clockwise. Adjust the time by turning the setting knob in either direction.

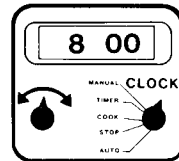

Return the selector knob to 'manual'.

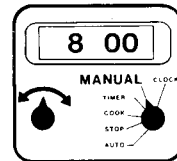

To Use the Minute Minder

Turn the selector knob to 'timer'. Turn the setting knob clockwise until the display shows the interval you want to time. The asterisk (*) will be illuminated and this will remain lit up during the timed interval. Our diagram shows the timer set to 5 minutes.

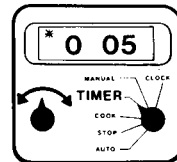

Whilst using the minute minder the clock can be returned to show the time of day by turning the selector knob to manual. The asterisk will remain alight to remind you that the minute minder is set. At the end of the timed period an audible signal will be heard and the asterisk will go out.

Switch off the signal by turning the selector knob.

Note.

You can use the minute minder when an automatic sequence has been set, providing you note the following points.

1. Turn the selector knob to 'Auto' as soon as the timed interval has been entered in the display.
2. When you set the timer during the delay period, the oven burner may spark and light, once the selector knob is returned to 'Auto' the burner will go out.

The delay period is simply the period of time before cooking begins in an auto-cook sequence.

Automatic Control

When you use the automatic controls for the first time it's probably best to choose a time when you are at home. That way you can check to make sure you've set everything correctly and you'll feel much more confident when you are away from home in the future.

Setting the Controls for Automatic Use

This is very easy, all you have to do is work through the steps below. The clock will work out the rest for itself.

-
1. Is the electricity supply on?
-

2. Is the clock showing the correct time?

To adjust turn to 'clock' and turn the setting knob in either direction.

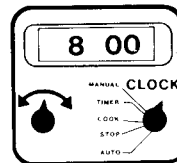

-
3. How long will the food take to cook?

Turn to 'cook'. Then turn the setting knob until the length of time you want the food to cook shows in the display.

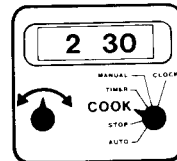

The maximum cooking time is 23 hours 59 minutes.

4. What time do you want the food to be cooked by? Turn to 'stop'. Turn the setting knob until the time the oven is to switch off shows in the display.

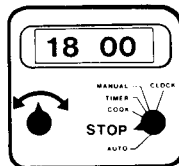

The 'stop' time must not be more than 23 hours 59 minutes from the time of day. For example if the time of day is 8.00 a.m. the latest 'stop' time will be 7.59 a.m. the next day.

5. Set to automatic. Turn to 'auto'.

6. Turn on the oven control. Turn to mark 9 then back to the gas mark required. The auto neon will now glow.

The times shown on the chart gives an example of setting the automatic controls when the time is 8.00 a.m., the length of time the food is to be cooked is 2½ hours and the food is needed at 6.00 p.m. (1800 hours).

The clock will calculate what time the oven must switch itself on and it will turn the oven off at the end, the oven-on neon will glow whilst the oven burner is alight and the auto neon will go out. Once the automatic sequence is completed there will be an audible signal to remind you that the oven must be re-set for manual operation. To re-set turn to 'manual'. Turn off the oven control.

If you change your mind and want to cancel a programme that you have set simply turn to 'manual'.

Please note — before using the automatic control to cook anything in the oven, refer to the food preparation hints on page 16.

THE OVEN PROGRAMMER – 200 model

This is a twelve hour clock.

1. Minute Minder Symbol.
2. (inner) Clock-Setting Knob.
3. (outer) Automatic Time Knob.

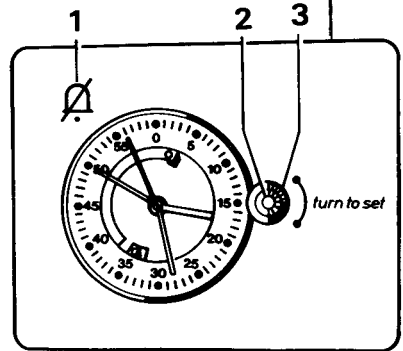

In the following paragraphs we explain how to set the controls. Read through them a few times until you're familiar with how easy it is. A plastic card has been supplied as a quick reference for setting the programmer.

To Set the Time

1. Push in and turn the inner knob (2) in either direction until the correct time is displayed.

To Use the Minute Minder

1. The minute minder gives an audible reminder for any period of cooking up to 55 minutes.
2. To set, turn the inner knob (2) anti-clockwise until the pointer is pointing to the desired time interval (Maximum 55 minutes ahead of the minute hand).
3. At the end of the time period, the pinger will sound. To cancel, turn the inner knob (2) until the pointer is pointing to the bell symbol (1).

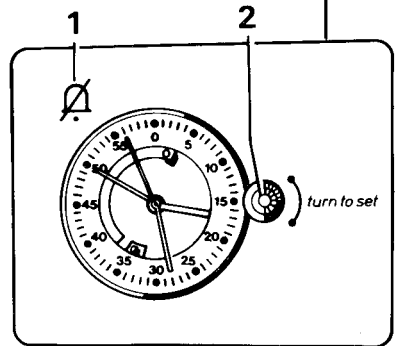

Automatic Control

When you use the automatic controls for the first time it's probably best to choose a time when you are at home. That way you can check to make sure you've set everything correctly and you'll feel much more confident when you are away from home in the future.

Although the automatic controls operate within limits which ensure excellent cooking results, their accuracy is subject to a small variation in the set cooking period. The electric clock keeps accurate time.

Setting the Controls for Automatic Use

This is very easy, all you have to do is work through the steps below. The clock will work out the rest for itself.

1. Is the electricity supply on?

2. Is the clock showing the correct time? To adjust push in and turn the inner knob in either direction until the correct time is displayed.

3. What time do you want the food to be cooked by? Turn the outer knob (3) clockwise until the arrow (4) is pointing to the time the oven is to switch off.

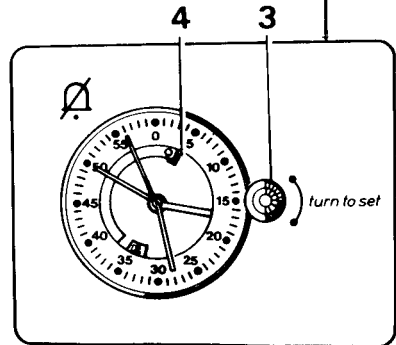

The 'stop' time must not be more than 11 hours 59 minutes from the time of day. For example if the time of day is 8.00 a.m. the latest 'stop' time will be 7.59 p.m.

4. What time do you want the food to start cooking?

Turn to outer knob (3) anti-clockwise until the front of the orange section (5) is adjacent to the time the oven is to switch on.

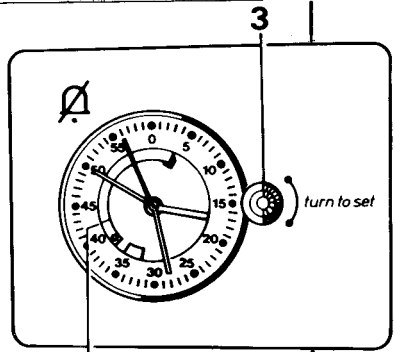

5

The 'cooking' time cannot exceed 3 hours 59 minutes.

5. Turn on the oven control.

Turn to gas mark 9 then back to the gas mark required. The 'auto' neon will glow.

The times shown on the chart gives an example of setting the automatic controls when the time is 8.00 a.m., the length of time the food is to be cooked is 2½ hours and the food is needed at 6.00 p.m.

When the automatic timed period starts, the auto neon will switch 'off'. Once the automatic sequence is completed the auto neon will glow and an '0' (6) will appear in the window to remind you that the oven must be re-set for manual operation. To re-set turn the outer knob (3) clockwise so that the hand appears in the window. Turn off the oven control.

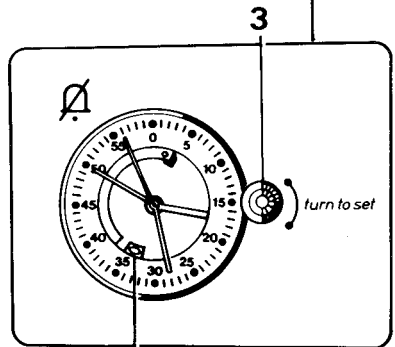

6

Please note — before using the automatic control to cook anything in the oven, refer to the food preparation hints on page 16.

Food Preparation – Automatic Cooking

As food may sit in the oven for a while before the oven switches itself on there are some special rules to remember:-

1. Check the instructions for setting the automatic controls until you are familiar with its operation.
2. If the oven has been used, allow it to cool completely before using for automatic cooking.
3. Choose perishable foods carefully, especially during warm weather.
4. Food should be fresh and preferably straight from the refrigerator.
5. Joints of meat and poultry must be completely thawed.
6. Dishes containing left over cooked meat or poultry should not be cooked automatically if there is a delay period.
7. Choose dishes which require approximately the same cooking time. Slight variations may be allowed for by:
 - (i) placing foods in larger or smaller containers
 - (ii) using more or less liquid
 - (iii) cutting fruit or vegetables into larger or smaller pieces.These will give longer or shorter cooking times respectively. Further temperature adjustments can be made by placing foods higher or lower in the oven as the top of the oven is hotter than the bottom.
8. Arrange shelf positions to suit dishes and choose dishes which will fit into the oven together.
9. As food may be standing for some time in the oven, cover dishes with foil or a lid where possible, and in the case of roast potatoes and joints of meat, brush with a little fat or oil. Lemon juice may be added to fruit to prevent browning.
10. Cream should be added just before serving.
11. If alcohol is used fermentation can occur.
12. Green leaf vegetables which take only a short time to cook, should not be placed into the oven with the automatic meal. It is far better to cook them in a pan on the hotplate whilst dishing up the rest of the meal.

SLOW COOKING

The slowset feature enables a variety of foods to be cooked such as soups, stews and casseroles where cheaper, tougher cuts of meat can be made tender, succulent and flavoursome. In addition, delicate food items such as fish, fruits and vegetables also yoghurt and Christmas puddings can be cooked by this long, slow cooking method. Food may be prepared the evening before then left to cook unattended overnight or during the day. There is no topping up of steamers, steam-filled kitchens or checking to see if casseroles have dried-out.

This feature combined with the unique 'heat zoning' in a gas oven allows you to cook a complete meal in the oven using the 'slowset' control. Many foods normally cooked on the hotplate may be cooked in the oven instead. Steamed sponge puddings for example, can be prepared and cooked with a family meal.

There are two methods of using the oven for 'slowset' cooking. These are referred to as method 'A' and method 'B'.

Initial High Temperature Start (Method 'A')

Most foods need to be cooked at gas mark 6 for 30 minutes to begin the cooking process. The oven temperature is then reduced to 'S' and a low gentle heat is used for the rest of the cooking time. (Place food in the oven, cook at gas mark 6 for 30 minutes, reduce to 'S' for remaining time).

Low Temperature Throughout (Method 'B')

Some more delicate foods such as custards require only the very low heat throughout. (Place food in oven, cook on 'S' throughout cooking time).

If cooking dishes together which require both method 'A' and 'B' those requiring method 'B' can be put into the oven after the first 30 minutes of the cooking time has elapsed.

Recipe and Menu Planning

1. Some foods are not suitable for slow cooking, e.g. shortcrust pastry, flaky pastry and biscuits, because the temperature is too low.
2. When planning a complete meal choose dishes compatible in cooking time if the cooker is to be left unattended. Do not open the oven door unless adding or removing dishes during the cooking period.
3. The ingredients may be prepared the evening before and refrigerated overnight. In the morning transfer the ingredients into the cooking dish. By not using a cold dish to cook in, which must be heated through, you will ensure that meat is thoroughly cooked.
4. Cooking times will vary according to personal preference, size and position of dish in oven, quality, size and quantity of food.

Utensils

1. Any oven proof dishes are suitable. The size and shape of the container may affect the cooking time.
2. Cover all food during cooking with a close fitting lid, or aluminium foil to prevent food from drying out. Those foods normally served golden brown can have the cover removed for about the last half hour of the cooking time.

Food Preparation – Slow Cooking

Joints of Meat and Poultry

1. Do not cook meat joints over 2.7 kg (6 lb).
2. Do not cook poultry over 2 kg (4 lb 8 oz).
3. Cook in the middle of the oven or above.
4. Cook stuffing separately.
5. Cook for a minimum of 6 hours.
6. Joints of Pork must only be cooked if you can ensure, by using a meat thermometer, that it has reached an internal temperature of at least 88°C.
7. For good air circulation always stand joints on a rack in the roasting tin or casserole.
8. Frozen meat and poultry must always be thawed before cooking.
9. Prime cuts of Beef and Pork do not benefit from slow cooking.
10. Remove excess fat and skin unless browned first.
11. Cook using method 'A'.

Soups, Casseroles and Stews

1. Brown meat and vegetables first (immediately prior to cooking) or place all ingredients in together.
2. Bring to the boil on the hotplate then cook using method 'B'; or use method 'A'.
3. Do not cook casseroles over 3 kg (6 lb).
4. Foods which require less cooking can be added towards the end of the cooking time.

Vegetables

1. Cut root vegetables into small pieces unless cooking whole e.g. baked potatoes.
2. All dried beans should be soaked overnight, rinsed and covered with fresh water. Bring to the boil on the hotplate and boil uncovered for 15 minutes before draining and adding to dish.
3. Place vegetables under meat in casseroles.
4. Add a few drops of lemon juice or vinegar to prevent potatoes turning black.
5. Cook using method 'A'.

Preserves

1. Only soften the fruit for jam or marmalade and then boil on the hotplate.
2. Chutney may require boiling on the hotplate after cooking to thicken.

Steamed Sponge Puddings

1. Cover the pudding with a circle of greased, greaseproof paper then with foil. Stand the prepared pudding in a pyrex basin containing enough water to come half way up the sides of the pudding. Wrap the basin and the pudding in foil, sealing the edges well so that no steam can escape.
2. Cook using method 'B'.

Milk Puddings

Just cover the cereal with boiling water, allow to stand for 30 minutes. Drain, make the pudding in the normal way, cook uncovered using method 'A'.

Meringues

1. Cook towards the bottom of the oven i.e. shelf 5 or the base.
2. Cook using method 'B'.

Fruit

1. All fruit dishes should be cooked on shelf position 5 or on the base of the oven.
2. Cook using method 'B'.

General Points

Frozen Food

- all food must be COMPLETELY THAWED before preparing for slow cooking.

Thickening

- toss meat in flour for casseroles
- blend cornflour or flour with water and add to dishes at the end of cooking.

Flavouring

- experiment with flavourings and seasonings because there is little evaporation so flavours are retained, if necessary adjust at the end of the cooking time.

Liquid

- reduce normal liquid quantities slightly as there is little evaporation during cooking.

Milk and Milk Products e.g. Cream

- add towards the end of cooking.

Reheating

- left over food should be cooled quickly and refrigerated.
Food should not be reheated using the slow cook feature.
- food must only be reheated once.

CARE AND CLEANING

Please remember that for hygiene and safety reasons, this appliance should be kept clean. A build up of fats or other foodstuffs could result in a fire.

Try and mop up any spills and splashes as soon as they happen ***but take care as the appliance may be hot.*** If your cooker needs a really good clean from hardened spills let it cool down.

Do not use any polishes, caustic cleaners, abrasives, washing soda or soap powder, except as recommended in this booklet. If you own a dishwasher please refer to the operating instructions for the machine before washing any part of your cooker.

Clean your cooker regularly using hot soapy water, then rinse it and polish dry using a soft cloth.

If you remove parts of the cooker for cleaning don't subject them to 'thermal shock' that is, don't plunge them into water, before they're cooled.

The Grill

The grill pan can be cleaned using mild abrasives.

The Oven

The inside of the oven and the shelves can be cleaned using mild abrasives.

You can help avoid spills by standing pies, casseroles etc., on a baking tray during cooking.

The vitreous enamelled roof can be removed by sliding it forward. ***After cleaning ensure that the roof is replaced correctly as indicated by the words 'top front'. Make sure that the roof is pushed back as far as it will go.***

Please note — incorrect positioning of the oven roof will affect the cooking performance.

Special Oven Linings

Your oven is fitted with special linings to help keep it clean. The finish is porous, so it soaks up and spreads fat splashes. These stains are oxidised by the air helped by the heat of the oven, and they disappear gradually. Special oven linings must only be cleaned as recommended in this booklet.

Follow the Clean Oven Code

Don't overfill dishes. Stand pies and casseroles on a baking tray. Place dishes in the centre of the shelf. Take care when putting food on a high shelf, that it does not stick to the oven roof. Use a tin which is just large enough for the meat or meat plus potatoes. Dry off excess water from vegetables which are to be roasted. Use a covered roaster or foil, then remove during the last stages of cooking to brown.

Oven Cleaning

If you follow the instructions carefully, there will be hardly any cleaning to be done other than by heating the oven regularly to gas mark 7 to help speed up the cleaning process. Obviously if you use the oven most often at low temperatures for long periods, then you will need to heat clean about every 2 to 3 weeks. If you do a lot of roasting and very little other baking, we recommend that the oven is heated to mark 7 once a week.

For the best results, set the oven to mark 5 for at least 30 minutes, then turn up to 7 for 2 hours or until the oven is presentably clean. Remove the shelves before carrying out the heat cleaning. Do not immerse the oven linings in water as this will damage the finish.

If the recommendations are not followed and the surface becomes marked, you can buy a new set of linings. Contact your supplier for details.

Removing Linings

Ensure that the oven is cool.

1. Open the oven door fully, take out the shelves and vitreous enamelled roof.
2. Lift out the side panels.
3. To remove the back panel, rotate right hand or left hand edge outwards and pull out.

Replacing Linings

Refer to the diagrams to ensure correct positioning.

1. Replace the back panel, sliding it back into position behind the oven burner, ensuring that the oven light cut-out is positioned over the oven light.

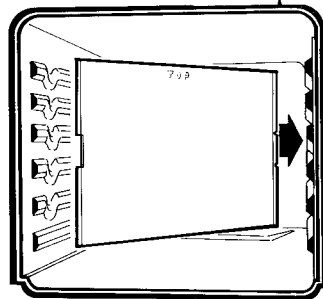

2. Replace the side panels by sliding them behind the flaps on the back panel.

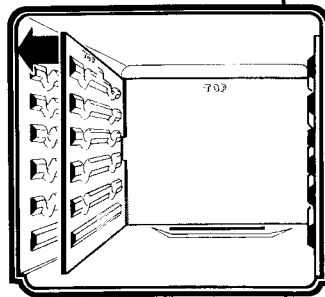

Oven Door

To make cleaning easier, the inner glass panel on the oven door can be removed. To do this follow the instructions below.

Removing the Glass Panel

1. Fully open the door.
2. Turn the two fixing screws in an anti-clockwise direction, using a small coin or flat bladed screw driver.
3. Lift off the enamel frame.
4. Remove the glass.

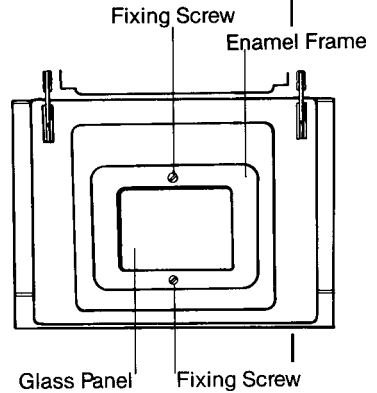

Replacing the Panel

1. Make sure that the rubber seal is correctly in position.
2. Reposition the glass and enamel frame.
3. Replace the screws and tighten. Do not over tighten the screws.

INSTALLATION

In the interest of safety this appliance must be installed and/or serviced by a competent person as stated in the Gas Safety (Installation and Use) regulations 1984.

It is important that the appliance is suitable for your gas supply. Your installer should check the data badge.

Cabinet Dimensions

This appliance must be fitted into a cabinet with a suitable sized aperture.

Minimum aperture height	585mm (23")
Minimum aperture width	560mm (22")
Minimum aperture depth	550mm (21½")

Location

All gas appliances require adequate ventilation. Your installer will advise if in doubt.

The appliance may be located in kitchen, kitchen/diner or bedsit but not in a room containing a bath or shower. It should be installed in a room of volume not less than 6m³ or a bedsit of volume not less than 21m³.

GENERAL INFORMATION

A gas cooker relies on the movement of air for heating. **Under no circumstances must any of the appliance vents be obstructed. Never line any part of the appliance with aluminium foil.**

Combustible materials or electric mains leads should not be allowed to trail over any part of the cooker.

Oven housing units vary widely in construction and finish. To avoid possible damage to the housing unit, it is essential that cabinet doors or flaps situated above the appliance are not left in the open or partially open position when the appliance is in use.

If installed in a tall oven housing, the storage area above the appliance will become warm when the appliance is in use, do not store perishable items in it.

Wiring A Plug

Warning: This appliance must be earthed and protected by a 3 amp fuse.

Fit a 3 pin 13 amp socket plug to cable. **Use 3 amp fuse.**

Important: The wires in the mains lead are coloured in accordance with the following code:

Green & Yellow – Earth

Blue – Neutral

Brown – Live

As the colours of the wires in the mains lead of this appliance may not correspond with the coloured markings identifying the terminals in your plug, proceed as follows –

The wire which is coloured **Green & Yellow** must be connected to the terminal in the plug which is marked with the letter E or by the earth symbol \perp or coloured **Green** (Earth terminal).

The wire which is coloured **Blue** must be connected to the terminal which is marked with the letter N or colour **Black** (Neutral terminal).

The wire which is coloured **Brown** must be connected to the terminal which is marked with the letter L or coloured **Red** (Live terminal).

Should the ignition system fail to work there may be a fault with the electrical supply. First, check the socket by trying out another electrical appliance in it, if that works correctly renew the fuse in the plug of the appliance.

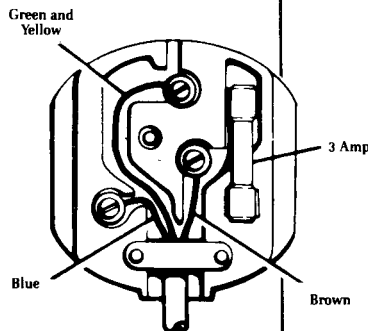

Repetitive failure of the fuse indicates that there is a fault on the appliance which must be rectified. ***Do not replace with a fuse of a higher rating than 3 amps.*** Do not attempt further electrical operation. Isolate from the electrical supply and inform the installer of the fault on the appliance.

Oven Light

The oven light operates whenever the oven control is turned on.

Replacing the oven light bulb

The type of bulb required is a 15 Watt small Edison Screw with a temperature rating of T300.

Ensure that the oven is cool.

1. Disconnect from the electricity supply.
2. Open the oven door, remove the oven shelves.
3. Unscrew the bulb cover and then the bulb in an anti-clockwise direction.
4. Fit the new bulb then the glass and seal by screwing in a clockwise direction.
5. Replace the oven shelves.
6. Restore the electricity supply and adjust the clock as necessary.

1 0 0 , 2 0 0 & 3 0 0

1 0 0 , 2 0 0 & 3 0 0

SERVICING

If your appliance fails to operate correctly, according to the instructions given in this book, contact the retailer from whom it was purchased. They will arrange for it to be serviced by a competent person.

Under no circumstances should you attempt to repair the appliance yourself. Repairs carried out by unauthorised or inexperienced persons may cause injury or more serious malfunctioning. Maintenance work must not be carried out by any other than a competent person. It is dangerous to alter the specification or modify the product in any way.

Service and spares are provided by your supplier and not direct from our factory. Failure to use manufacturer's original spares could invalidate normal B.S.I. certification of the cooker. As far as possible, try and describe the nature of the fault when reporting it to your supplier, and always give your cooker's full name, serial number and G.C. number which can be found on the reference badge which can be seen when the oven door is opened.

Make a note of this information in the space provided:-

Name:

Serial Number:

G.C. Number:

This handbook is accurate at the date of printing, but will be superseded and should be disregarded if specification or appearance are changed in the interests of continual improvements.

Parkinson Cowan Limited, Flaxley Road, Stechford, Birmingham. B33 9AD

E1710A0/01

WL15412

Printed by W. LAKE (Birmingham) Ltd.