

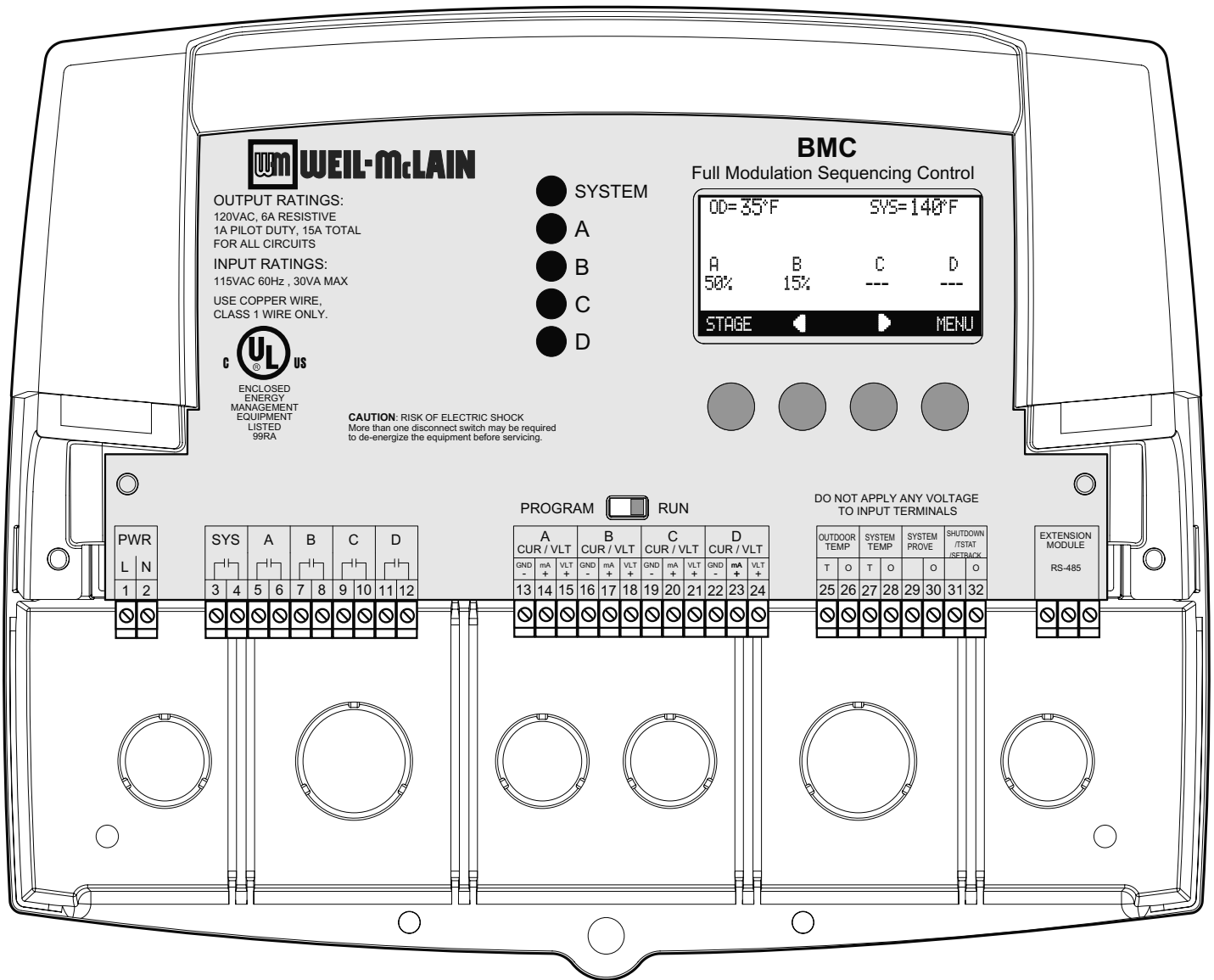

# BMC AND BMC-6X

HYDRONIC MODULATING BOILER CONTROL AND EXTENSION

• INSTALLATION AND OPERATION INSTRUCTIONS MANUAL



**! WARNING**

This Weil McLain control is strictly an operating control; it should never be used as a primary limit or safety control. All equipment must have its own certified limit and safety controls required by local codes. The installer must verify proper operation and correct any safety problems prior to the installation of this Weil McLain control.

## Contents

<b>BMC LAYOUT</b> . . . . .	<b>3</b>	Outdoor Cutoff Temperature . . . . .	18
<b>BMC OVERVIEW</b> . . . . .	<b>4</b>	Offset . . . . .	18
Reset Ratio/Outdoor Reset . . . . .	5	Minimum Water Temp . . . . .	18
Make Sure You Have the Right Control . . . . .	6	Maximum Water Temp . . . . .	18
<b>INITIAL SETUP</b> . . . . .	<b>6</b>	System Settings . . . . .	19
Selecting the System Features. . . . .	6	Gain . . . . .	19
<b>INSTALLATION</b> . . . . .	<b>7</b>	Lead Boiler Rotation . . . . .	19
Mounting the Enclosure . . . . .	7	Purge Delay . . . . .	19
Install the Sensors . . . . .	8	Lag Delay . . . . .	20
Heating System Sensor (HSS) Installation. . . . .	8	Standby Delay . . . . .	20
Outdoor Sensor Installation . . . . .	8	System Run-On . . . . .	20
Wiring. . . . .	9	Setback. . . . .	20
Wiring the Power (Terminals 1, 2) . . . . .	9	Last Stage Hold . . . . .	21
Wiring the Sensors . . . . .	9	Day/Night Schedules. . . . .	21
Wiring the Shutdown, Tstat, or Setback (Terminals 31, 32) . . . . .	9	Set Time . . . . .	22
Wiring the Prove (Terminals 29, 30) . . . . .	10	History . . . . .	22
Wiring the Domestic Hot Water Call DHW (Terminals 29, 30) . . . . .	10	Maintenance . . . . .	23
Wiring the System Output (Terminals 3, 4). . . . .	10	System & Outdoor Sensor Trim . . . . .	23
Wiring the Boilers . . . . .	10	Soft-Off Delay . . . . .	23
Wiring to Modulating Motors . . . . .	11	Output Trim. . . . .	23
Connecting to the BMC-6X Panels. . . . .	11	Configuration . . . . .	24
<b>MENU SEQUENCE</b> . . . . .	<b>12</b>	Display . . . . .	24
Startup Settings . . . . .	14	<b>TROUBLESHOOTING</b> . . . . .	<b>27</b>
Program Change Settings . . . . .	14	<b>DIRECT HEATING PIPING DIAGRAM</b> . . . . .	<b>29</b>
Startup Sequence . . . . .	14	<b>DIRECT HEATING WIRING DIAGRAM</b> . . . . .	<b>30</b>
Sensor Type . . . . .	14	<b>EXTERNAL 4-20MA SET POINT</b> . . . . .	<b>31</b>
EMS Input Mode (Available In Set point Only) . . . . .	14	<b>USING 4-20MA EMS INTERFACE</b> . . . . .	<b>31</b>
Selecting the Output Type . . . . .	14	<b>SPECIFICATIONS</b> . . . . .	<b>32</b>
Selecting the Modulating Mode . . . . .	15	BMC Specifications. . . . .	32
Prove/Domestic Hot Water (DHW). . . . .	15	BMC-6X Specifications. . . . .	32
Shutdown/Tstat/Setback Mode. . . . .	15		
Boost Mode (Not Available with Setback) . . . . .	15		
Sensor Fault . . . . .	16		
Setting the Control to Factory Defaults. . . . .	16		
Operating Settings . . . . .	17		
Program Change Settings . . . . .	17		
Season . . . . .	17		
Set Point (Not Adjustable in EMS Mode). . . . .	17		
Reset Ratio. . . . .	17		

## BMC LAYOUT

Program Switch to restrict access to function changes. This switch is covered with Wiring Enclosure.

The digital display shows the system status, set point, lead stage <in brackets>, and status of each stage. To view and adjust settings, press the appropriate buttons.

LED indicates the associated relay status.

Buttons function is presented on Bottom Row of display.

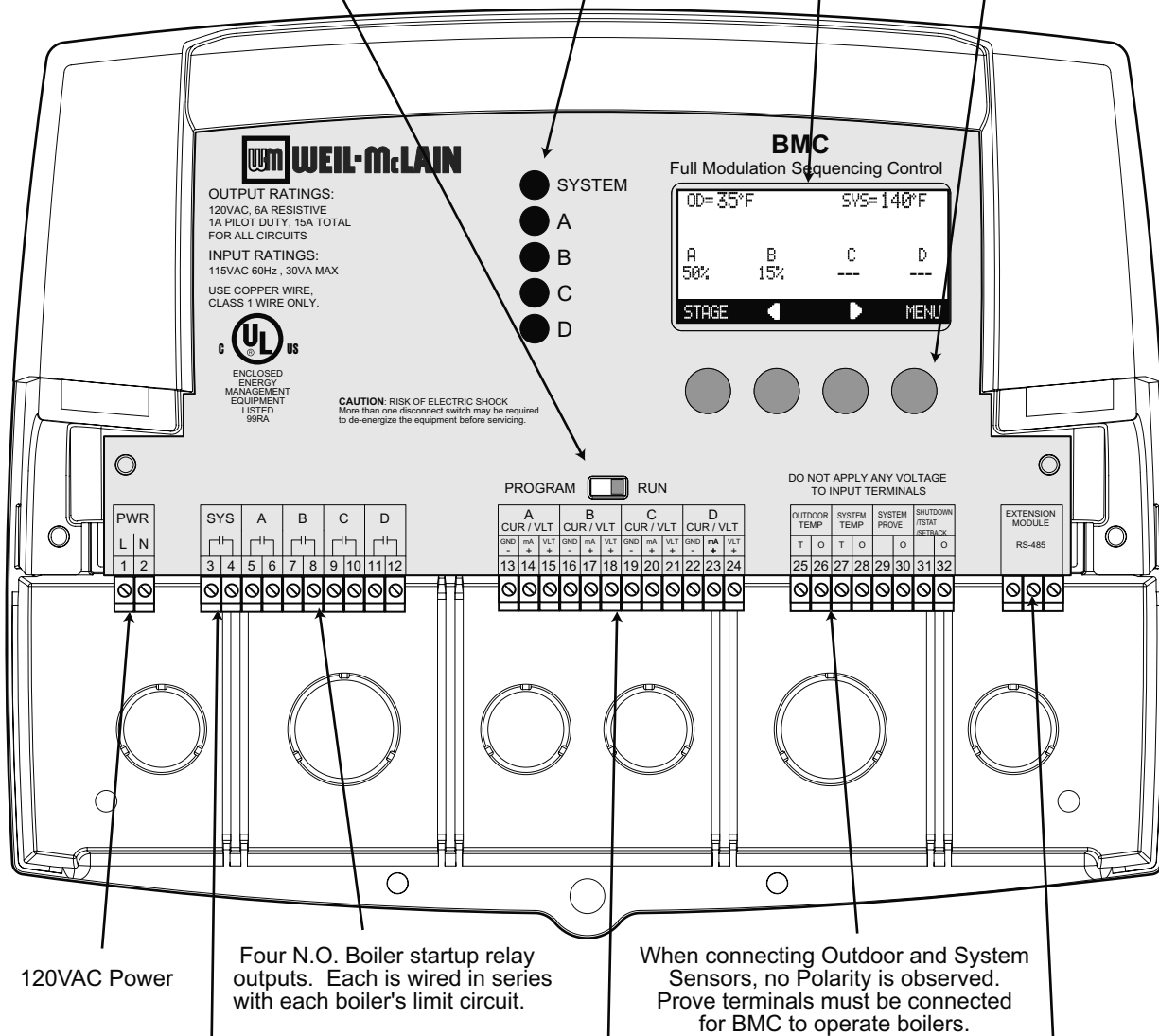

120VAC Power

Four N.O. Boiler startup relay outputs. Each is wired in series with each boiler's limit circuit.

When connecting Outdoor and System Sensors, no Polarity is observed. Prove terminals must be connected for BMC to operate boilers.

System Output controls pumps, valves, or other system components.

Four modulation outputs can be 0-5V, 0-10V, 1-5V, 2-10V, or 4-20ma. Go to Startup Menu to determine the type of output for each stage.

Connect Extension panels to add additional stages using a 6 pin phone line only (cable provided with BMC-6X).

## BMC OVERVIEW

### **SEQUENCES UP TO 4 FULLY MODULATING STAGES.**

The BMC is the perfect control whenever multiple fully modulating stages are required for hydronic heating applications. The BMC controls the on/off and the modulation of each stage to maintain precise system set point control.

### **PID TYPE LOGIC**

The BMC's control algorithms allow it to look at the rate of change in the system. If the system temperature is changing quickly, the BMC will react quickly to adjust the modulating stages' output. If the system temperature changes slowly, the BMC will make slow and gradual output adjustments. Therefore, the BMC adapts to specific system requirements and minimizes fluctuations around the set point.

### **CONTROLS 0-5 V, 0-10 V, 1-5V, 2-10V, OR 4-20 MA MODULATING MOTORS**

The BMC is designed to accurately control the output from 0 to 100% of modulation for each of these different types of motors. One BMC can even control a variety of the above different motors.

### **ONLY ONE SENSOR**

When Set Point sensor type is selected, the BMC requires only one sensor located in the common output header of all stages. However, when Reset is selected, an additional Outdoor Sensor is required for Outdoor Reset Ratio input.

### **DIGITAL DISPLAY OF ALL SYSTEM SETTINGS**

The BMC's alphanumeric digital display names each system parameter in simple English and shows its precise value. The easy to follow menu system allows users to quickly make changes to any system setting without having to learn any specialized codes or keyboard commands.

### **AUTOMATIC ROTATION AMONG STAGES**

Rotating the first stage to be activated on a call for output promotes even wear on each stage. The BMC has three modes of rotation: Manual, Last On, or Time. The Time rotates the lead stage every selected time period from every hour to every 60 days.

### **OUTDOOR RESET**

The BMC has a hydronic outdoor temperature reset function. This allows the BMC to change the set point based on outdoor temperature. Furthermore, additional settings have been added to fine tune this operation, like Offset, Minimum, and Maximum Water Temperature and night setback schedule.

### **STANDBY BOILERS**

Each of the BMC stages can be configured as a Standby boiler with an adjustable Standby delay. A boiler can be used as a backup during extended large demand periods.

### **SYSTEM OUTPUT**

In Set Point mode, this output can be used to activate a system pump, combustion air damper, or perform any other function that is required when any stage is active. In Outdoor Reset mode, the System Output will activate whenever the outdoor temperature is below the Outdoor Cutoff setting. A System Prove input checks the status of components activated by the System output before stages can be activated.

### **STAGING (NORMAL) OR PARALLEL MODULATION**

The BMC can stage boilers as needed. That will allow it to increase the modulation on the lead boiler. When the lead boiler reaches its modulation start point adjustment and does not satisfy the load, the BMC will start the next boiler and so on... Moreover, the BMC allows for a parallel mode that can modulate several boilers together as a one large boiler. This mode is useful for boilers with lower water content, which are usually more efficient at lower firing points.

### **ADD UP TO 16 BOILER STAGE (OPTIONAL)**

As a stand-alone, the BMC is designed to control four modulating boilers. However, it has the capability of expanding its control to two extension panels each with six boiler stages. Thus, the BMC can control a total of up to 16 boiler stages.

## UNDERSTANDING OPERATION CONCEPT

The BMC has multiple operating modes that satisfy most hydronic systems. It can change the System Set Point based on outdoor temperature (Outdoor Reset) or it can modulate its stages to achieve an adjustable fixed Set Point.

In Outdoor Reset, the BMC controls a hot water heating system to provide a building with comfortable and even heat levels. The BMC varies the temperature of the circulating heating water in response to changes in the outdoor temperature. The heating water temperature is controlled through the modulation of stages.

The BMC also controls the system circulating pump with an adjustable Outdoor Cutoff. When the outdoor temperature is above Outdoor Cutoff, the pump is off and no heating water is circulated through the system. When the outdoor temperature drops below the Outdoor Cutoff, the system pump relay is activated and the heating water circulates through the system. The temperature of the heating water is controlled by the Reset Ratio, Water Offset, and changes with Outdoor temperature.

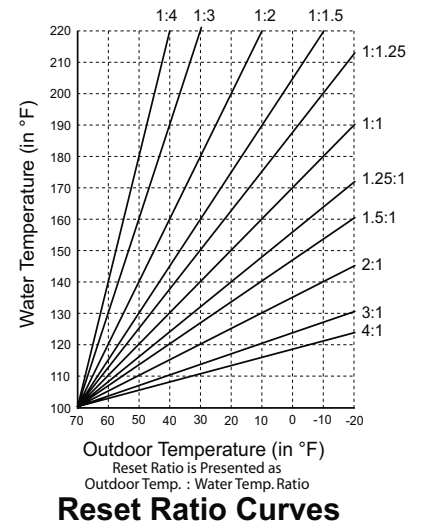

### RESET RATIO/OUTDOOR RESET

When a building is being heated, heat escapes through the walls, doors, and windows to the colder outside air. The colder the outside temperature, the more heat escapes. If you can input heat into the building at the same rate that it is lost out of the building, then the building temperatures will remain constant. The Reset Ratio is an adjustment that lets you achieve this equilibrium between heat input and heat loss.

The starting point for most systems is the 1.00 (OD):1.00 (SYS) (Outdoor Temperature : Heating Water Temperature) ratio. This means that for every degree the outdoor temperature drops, the temperature of the heating water will increase one degree. The starting point of the curves is adjustable, but comes factory selected at 70°F Outdoor Temp. and 100°F Water Temp. For example with a 1.00 (OD):1.00 (SYS) ratio, if the outdoor temperature is 50°F, this means the temperature has fallen 20° from the starting point of 70°F. Therefore, the heating water temperature will increase 20° to 120°F.

Each building has different heat loss characteristics. A very well insulated building will not lose much heat to the outside air, and may need a Reset Ratio of 2.00 (OD):1.00 (SYS) (Outdoor:Water). This means the outdoor temperature would have to drop 2 degrees to increase the water temperature 1 degree. On the other hand, a poorly insulated building with insufficient radiation may need a Reset Ratio of 1.00 (OD):2.00 (SYS). This means that for each degree the outdoor temperature dropped the water temperature will increase 2 degrees. The BMC has a full range of Reset Ratios to match any buildings heat loss characteristics.

A heating curve that relies not only on Outdoor temperature but also on type of radiation will improve heat comfort. The following are suggested initial settings for different types of radiation based on average building insulation and heat loss. The contractor can fine tune these adjustments based on the specific building need.

Type of Radiation in Building	Reset Ratio	Offset
Radiators (Steel & Cast Iron)	1.00 (OD) : 1.00 (SYS)	0°F
Baseboard (Finned copper tube & Cast Iron)	1.00 (OD) : 1.00 (SYS)	0°F
Radiant (High Mass/Concrete)	4.00 (OD) : 1.00 (SYS)	-10°F
Radiant (Low Mass/Joists)	2.00 (OD) : 1.00 (SYS)	-10°F
Fan Coils & Air Handlers	1.00 (OD) : 1.00 (SYS)	20°F

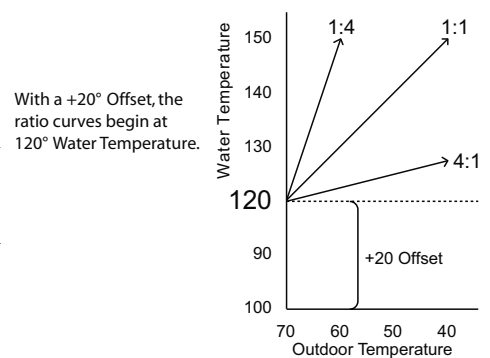
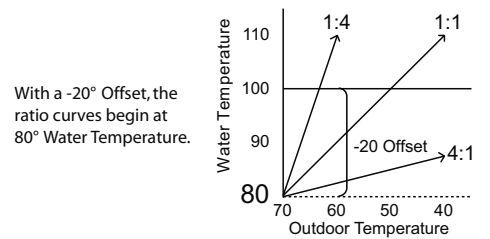
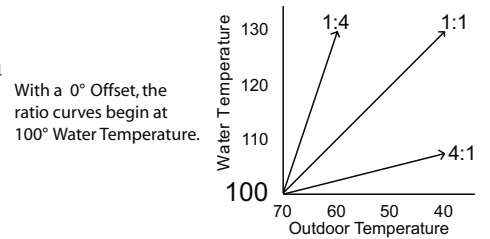

**⚠ WARNING**

**When controlling a non condensing boiler directly without the use of a mixing valve, minimum boiler water temperature must be set to boiler manufacturer specifications. In that case, system temperature must not go below such temperature.**

## MAKE SURE YOU HAVE THE RIGHT CONTROL

If you need the BCP-8W to do additional tasks that either are not listed or do not know how to set them, contact Weil McLain.

## INITIAL SETUP

Setting an Initial Program will ease the configuration of the BMC and will give the opportunity to utilize many of the energy saving features and give more comfortable heat when needed.

The program should consist of the following:

- Selecting the features that your system can utilize,
- Installation: Install the Control, switches and sensors,
- Setting the System Startup,
- Setting the System Settings,
- Setting the Stages
- Adjusting Reset Ratio and Water Offset (In Reset Mode Only)

## SELECTING THE SYSTEM FEATURES

The BMC has been designed with Hydronic building heating as the primary purpose. With this in mind, many of the BMC features can be utilized to ease, enhance and improve your system performance. Some of these features are listed in this section.

### OUTDOOR RESET OR SET POINT

- The BMC can control the System Temperature either by adjusting the calculated temperature according to the Outdoor Temperature (Outdoor Reset) or by maintaining an adjustable Set Point. The earlier relies on an Outdoor Sensor (supplied with the control) and achieves better fuel savings in addition to better comfort.

### NUMBER OF STAGES

- The BMC can be configured to control up to 4 modulating boilers. It can control up to 16 boiler stages using a maximum of two BMC-6X Panels

### MODULATION MODE

- The BMC can stage boilers using one of two methods. Normal Modulation Mode, allows it to increase the modulation of the lead boiler. When the lead boiler reaches its modulation start point adjustment and does not satisfy the load, the BMC will start the next boiler and so on. This mode targets boilers that can run more efficient at higher modulation rates.
- The Parallel Modulation Mode can modulate several boilers together as a one large boiler. This mode is useful for boilers that are more efficient at lower firing points.

### MODULATING SIGNAL

- The BMC is designed to accurately control the output from 0 to 100% of modulation for each of these different types of motors. One BMC can even control a variety of the above different modulation motors.

### AUTOMATIC ROTATION AMONG BOILERS

- Rotating the first burner to be activated on a call for output promotes even wear on all burners. The BMC has three modes of rotation: Manual, Last-ON, or Time automatically rotating every selected time period from every hour to every 60 days.

### STANDBY BOILER

- Any boiler can be configured as a Standby boiler. It withholds a specific boiler from being included in the Lead Rotation. However, the Standby boiler will be fired only as a backup when all other stages combined cannot satisfy the demand and after an adjustable delay period.

### SETBACK OR DAY/NIGHT SCHEDULING

Two Setback modes are available for the BMC:

- The Day/Night Scheduling provides an adjustable time-based schedule for the Setback.
- The Setback mode uses an external signal to switch the operation of the BMC in and out of setback mode.

## System Run-On

- This feature lets the BMC run the SYS relay for a longer period after the boilers have been turned off. When this relay is used to control a pump, it helps in dissipating the excess heat from the boilers combustion chamber.

# INSTALLATION

Each of the BMC or BMC-6X consists of three primary enclosure components.

- **The Enclosure Display Module:** contains the display, buttons, LEDs and electric wiring terminals. It has two screws to hold it to the base. A program configuration switch, used to adjust BMC settings, is placed above the terminals. This switch is enclosed with the enclosure wiring cover for security. Wiring terminals are of the plug-in type to ease installation and removal.
- **The Enclosure Base:** contains the holes to mount and hold the control against the wall or any flat surface. All other enclosure components mount on the base. The bottom section of the Enclosure Base contains the wiring chamber with knockouts on the bottom to easy installation.
- **The Enclosure Wiring Cover:** seals the wires from the external environment. It has two screws to hold it the base and a hole to secure a lock on the wiring enclosure. A plastic web that separates the wiring chamber into high and low volt sections has been provided.

## MOUNTING THE ENCLOSURE

- Select a location near the equipment to be controlled.
- The surface should be flat and sufficiently wide and strong to hold the BMC or BMC-6X.
- Keep the control away from extreme heat, cold, or humidity. Ambient operating temperature is from 20 to 120°F.
- Remove the Enclosure Wiring Cover from the control enclosure by removing the two bottom screws.
- Remove the Enclosure Display Module by removing the middle screws.
- Screw the Enclosure Base to the surface through the upper and lower mounting holes on the back of the enclosure.
- Replace the Enclosure Display Module and replace the middle screws.
- Do not replace the enclosure wiring cover until all wiring is done.
- When purchasing a padlock for the enclosure, the maximum shank diameter should not exceed 1/4"

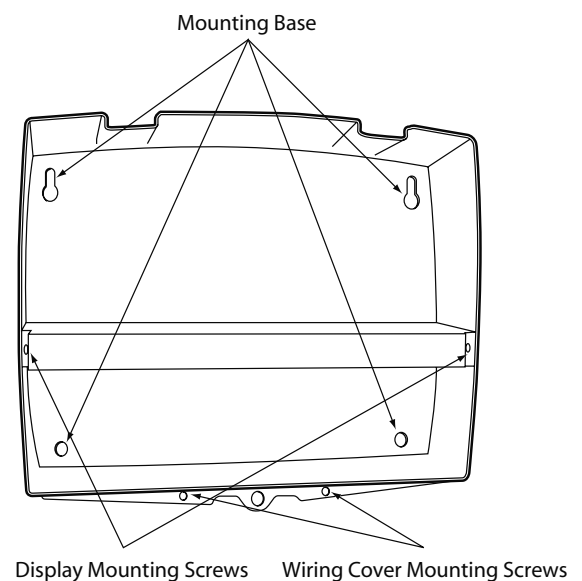
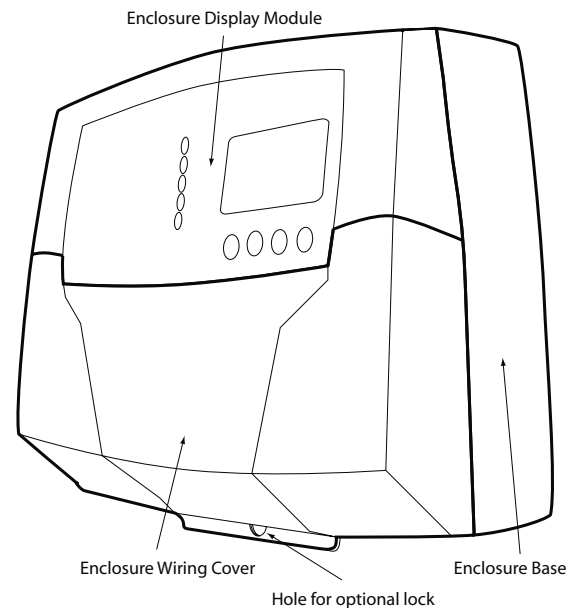

## INSTALL THE SENSORS

### HEATING SYSTEM SENSOR (HSS) INSTALLATION

#### LOCATING HSS

- Put the Heating System sensor approximately 10' feet past the last boiler on the common supply header but before any major takeoffs.
- The sensor must be located where it sees the output of all the boiler stages. If a boiler is piped so that the sensor does not see its output, the BMC will not sequence the boilers correctly.
- Only use a Standard Brass Tube sensor (389-900-230).
- The sensor wires can be extended up to 500' using a shielded 2-conductor cable (Belden #8760 or equivalent). Do not ground the shield at the sensor but at the panel using one of the terminals marked with an "O".
- Do not run sensor wires in conduit with line voltage wiring.

#### IMMERSION HEATING SYSTEM SENSOR (HSS) INSTALLATION

- Install a 3/8" ID 1/2" NPT immersion well (592-300-023 or equivalent).
- Insert the sensor probe of the supplied sensor into the well.

#### STRAP-ON HEATING SYSTEM SENSOR (HSS) INSTALLATION

- Strap the sensor to the pipe using metal clamps. Do not over tighten the clamp.
- Strap pipe insulation around the sensor and pipe.

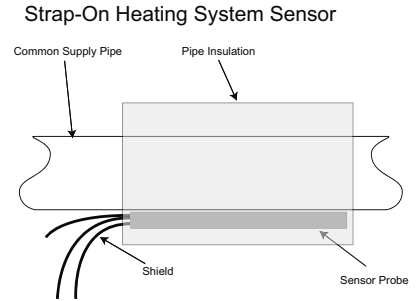
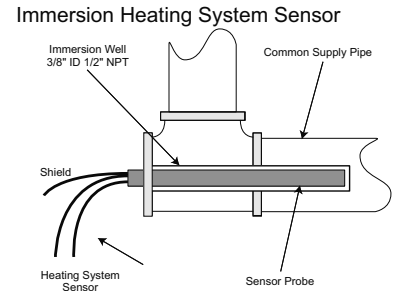

**⚠ ALERT**  
 If the HSS can not sense the correct heating system water temperature being supplied to the building, the BMC will not provide comfortable heat levels. Be sure the HSS is located on a main supply pipe which can not easily be isolated from the system.

### OUTDOOR SENSOR INSTALLATION

- Only use the Weil McLain sensor included with the unit (389-900-229).
- Locate the sensor in the shade on the north side of the building. The sensor should never be in direct sunlight.
- Be sure the location is away from doors, windows, exhaust fans, vents, or other possible heat sources.
- The sensor should be mounted approximately 10' feet above ground level.
- Adhere the Outdoor Label provided to the back of the sensor base.
- Use the Enclosure Base bottom knockout for the conduit. Use the locknut to hold the conduit and enclosure base together. Screw the cover to the base.
- If screws are used to affix the enclosure to the wall, make sure to seal around the sensor and wall except from the bottom.
- The sensor wires can be extended up to 500' using shielded 2-conductor cable (#18/2). Do not ground the shield at the sensor but at the control using the terminal marked with an "O".
- Do not run sensor wires in conduit with line voltage wiring.

### Outdoor Sensor

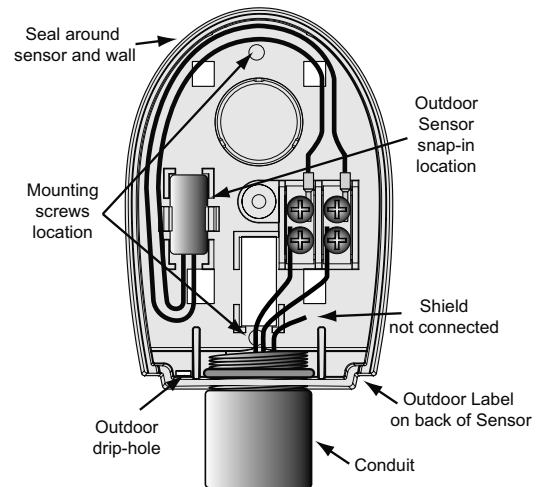

**⚠ WARNING**  
 The BMC is an operating control only. All boilers must have all safety and limit controls required by code. It is the responsibility of the installer to verify that all the safety and limits are working properly before the BMC is installed.

**⚠ ALERT**  
 Determining the proper location for the Outdoor Sensor is very important. The BMC will base the heat on the outdoor temperature information it receives from this location. If the sensor is in the sun, or covered with ice, its reading will be different from the actual Outdoor temperature (OD).



## WIRING

### WIRING THE POWER (TERMINALS 1, 2)

- Bring the 120VAC 60Hz power wires through the bottom Knockout of the enclosure.
- Class 1 voltages must enter the enclosure through a different opening from any Class 2 voltage wiring.
- Connect the hot line to terminal marked L.
- Connect the neutral line to the terminal marked N.
- Weil McLain recommends installing a surge suppressor on the power source to the BMC.

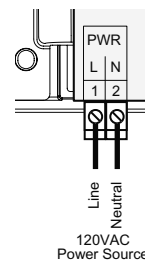

### ⚠ WARNING

**Class 1 voltages must enter the enclosure through a different opening from any Class 2 voltage wiring. Weil McLain recommends installing a surge suppressor on the power source to the BMC.**

### ⚠ WARNING

**Connect the shield at the control terminal end and cut the shield wire at the sensor end.**

### WIRING THE SENSORS

#### SYSTEM SENSOR WIRING (TERMINALS 27, 28)

- A BMC must be connected to a temperature sensor located in the common header.
- The BMC is designed to be connected to a 389-900-230 temperature sensor for immersion in a 3/8ID well (592-300-023 or equivalent). Contact the factory for additional temperature sensor options.
- Temperature sensor wires can be extended up to 500' by splicing shielded 2-conductor cable (Belden #8760 or equivalent (#18/2)).
- Temperature sensors have no polarity. Connect the two wires from the sensor to the BMC terminals marked *SYSTEM TEMP* 27, 28.
- Connect the sensor shield to the circled terminal 28 with one of the sensor wires.

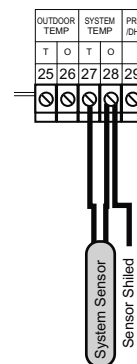

#### OUTDOOR SENSOR WIRING (TERMINALS 25, 26)

- When Outdoor Reset is selected, the BMC will vary the system Set Point based on outdoor temperature.
- Whether in Set Point or Outdoor Reset modes, the outdoor sensor can be used as an Outdoor Cutoff. The BMC will disable all boilers when the outdoor temperature is above the adjustable Outdoor Cutoff temperature. This feature will automatically be activated when an outdoor sensor is connected.
- For an outdoor sensor use a Weil McLain outdoor sensor (389-900-229).
- The sensor wires can be extended up to 500' using shielded 2-conductor cable (Belden #8760 or equivalent (#18/2)).
- Temperature sensors have no polarity. Connect the wires from the outdoor sensor to the BMC terminals marked *OUTDOOR TEMP* - 25, 26.
- Connect the shield to the circled terminal 26 with one of the sensor wires.

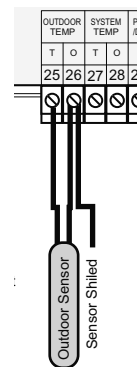

#### WIRING THE SHUTDOWN, TSTAT, OR SETBACK (TERMINALS 31, 32)

- The Shutdown will be available when selected as the Shutdown/Tstat/Setback mode from the Startup menu. See page 15. This will provide the user with a customizable Day/Night Schedule. See page 21.
- The Shutdown feature can be used whenever it is desirable to turn off the BMC stage outputs from a remote location or another controller (i.e. EMS input).
- The Tstat option, when selected from the Shutdown/Tstat/Setback startup menu, provide the capability of controlling the operation of the BMC based on a thermostat input.
- The thermostat will provide the BMC with a call for heat by shorting terminals 31 and 32.
- When the Shutdown input is enabled by closing the dry contact, or when the Tstat input is disabled by opening the dry-contact, all active boilers will immediately modulate down to low for the Soft-Off period, then turn off.
- The System Output relay will remain active until the System Delay is over and then it will turn off.
- When Setback is selected in the Startup, a BMS/EMS or external clock can provide a Setback signal using these input terminals.
- The signal must be a dry contact only. No voltage can be placed across the *SHUTDOWN/TSTAT/SETBACK* terminals.
- Bring the two wires from the dry contact to the terminals marked *SHUTDOWN/TSTAT/SETBACK*- 31,32.

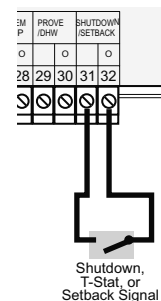

# BMC and BMC-6X Installation and Operation Manual

## WIRING THE PROVE (TERMINALS 29, 30)

- The Prove feature is provided to check system component operation and must be selected in the Startup Menu. See page 15.
- A typical use of this feature is to check for pump flow before firing any boiler.
- If the PROVE input is open on a call, the BMC will enable only the System Output. All boiler outputs will be off when the *PROVE* input is open.
- A factory-installed jumper provides the System Prove signal. Do not remove the jumper unless it will be replaced by a System Prove signal or use the terminals for DHW call.
- Bring the two wires from the dry contact to the terminals marked *PROVE - 29, 30*. No voltage can be placed across the *PROVE* terminals

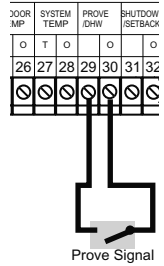

**⚠ WARNING**

The PROVE input cannot be used as a safety limit. All equipment must have its own certified limit and safety controls as required by local codes. If Prove is selected in the startup menu, no boiler stage will start unless Prove terminals are shorted. **DO NOT** remove the PROVE jumper supplied unless replacing it with a Prove signal.

## WIRING THE DOMESTIC HOT WATER CALL DHW (TERMINALS 29, 30)

- DHW can be used to raise system Set Point to 200°F or Maximum Water temperature, whichever is lower. DHW with or without Priority must be selected in the Startup Menu. See page 15.
- DHW Call terminals are dry contact N.O. terminals.
- Wire an aquastat or other controls to provide closure on the *DHW Call* terminals.
- Remove the jumper on the *DHW* terminals for proper operation.

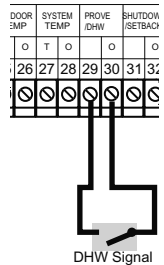

## WIRING THE SYSTEM OUTPUT (TERMINALS 3, 4)

### System Output Operation in Set Point Mode

- The SYS output relay will energize when the outdoor temperature drops below the Outdoor Cutoff or whenever a boiler output is active. If no outdoor sensor is connected and the last boiler relay has de-energized, the SYS relay will remain energized for a period set by the System Run-On. See page 20.
- No boilers will be activated until the prove input is shorted. If a Prove is not required, the factory-installed jumper should remain connected.
- A typical use of the SYS output is to activate a system pump starter. The pump can run whenever there is a call for heat. When heat is no longer required, the pump will stay active for an adjustable Pump Run-On delay.

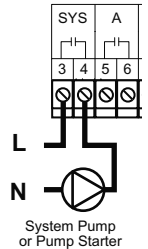

### System Output Operation in Reset Mode

- The SYS output relay will energize whenever the outdoor temperature is below the Outdoor Cutoff.
- The SYS will remain constantly energized while the outdoor temperature is below the Outdoor Cutoff.
- When the outdoor temperature rises 2°F above the Outdoor Cutoff, the SYS output will remain energized for the period set by the System Run-On. See page 20.
- The SYS output has one Normally Open (N.O.) relay contact rated for (1/8HP).
- The N.O. contacts are dry contacts only. They do not source any voltage.
- Class 1 voltages must enter the enclosure through a different opening from any Class 2 voltage wiring.
- Each N.O. contact is capable of switching 6A resistive at 120VAC.

## WIRING THE BOILERS

### WIRING THE BOILER OUTPUTS (A TERMINALS 5, 6), (B TERMINALS 7, 8), ...

- Each boiler output (A through D) has one Normally Open (N.O.) relay contact.
- The N.O. contacts are dry contacts only. They do not source any voltage.
- Each N.O. contact is capable of switching 1Amp inductive (1/8HP), or 6A resistive at 120VAC.
- Total output of all boilers, including the SYS, must not exceed 15A.
- Wire the N.O. relay contacts in series with the unit's limit circuit.
- Class 1 voltages must enter the enclosure through a different opening from any Class 2 voltage wiring.
- Note that some boilers may not require the use of these outputs.

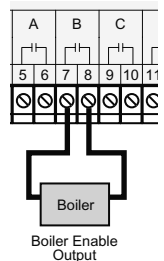

## WIRING TO MODULATING MOTORS

The BMC can modulate any combination of the following motors. The Output Type must be selected properly before connecting any output wires to avoid damage components. See Output Type on page 11.

### WIRING THE 4-20mA MODULATING MOTORS (A TERMINALS 13, 14), (B TERMINALS 16, 17),...

- The BMC can operate up to four 4-20 mA modulating motors.
- The BMC-6X can operate up to six 4-20 mA modulating motors.
- The BMC and the BMC-6X sources 24VDC excitation voltage for the 4-20mA signal.
- Wire the (-) from the modulating motor to the boiler terminal on the BMC marked (GND). That is for boiler A, the modulating (-) terminal will be 13.
- Wire the (+) from the modulating motor to the boiler terminal on the BMC marked (mA). That is for boiler A, the modulating (-) terminal will be 14.

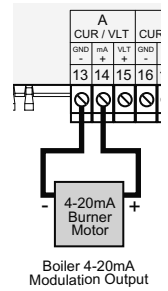

### WIRING THE VOLTAGE MODULATING MOTORS (A TERMINALS 13, 15), (B TERMINALS 16, 18),...

- The BMC can operate up to four 0-5V, 0-10V, 1-5V, or 2-10V modulating motors.
- The BMC-6X can operate up to six 0-5V, 0-10V, 1-5V, or 2-10V modulating motors.
- Wire the (GND) from the modulating motor to the boiler terminal on the BMC marked (GND). That is for boiler D, the modulating (GND) terminal will be 22.
- Wire the (V+) from the modulating motor to the boiler terminal on the BMC marked (VLT+). That is for boiler D, the modulating (V+) terminal will be 23.

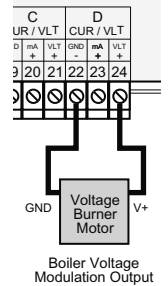

## CONNECTING TO THE BMC-6X PANELS

- The BMC is equipped with a 6-pin phone socket (RS485) to connect to extension panels. The BMC-6X is equipped with two 6-pin phone sockets to connect to BMC and an additional BMC-6X.
- Configure the Output Types (see page 11) after connecting the Extension panels to be able to configure their outputs.
- Only 6-wire phone cable must be used for proper operation.
- Connection cable is provided as part of the BMC-6X package.
- Phone cables must be of a 6-wire with 6-pin terminals. Phone cables can extend up to 100'.

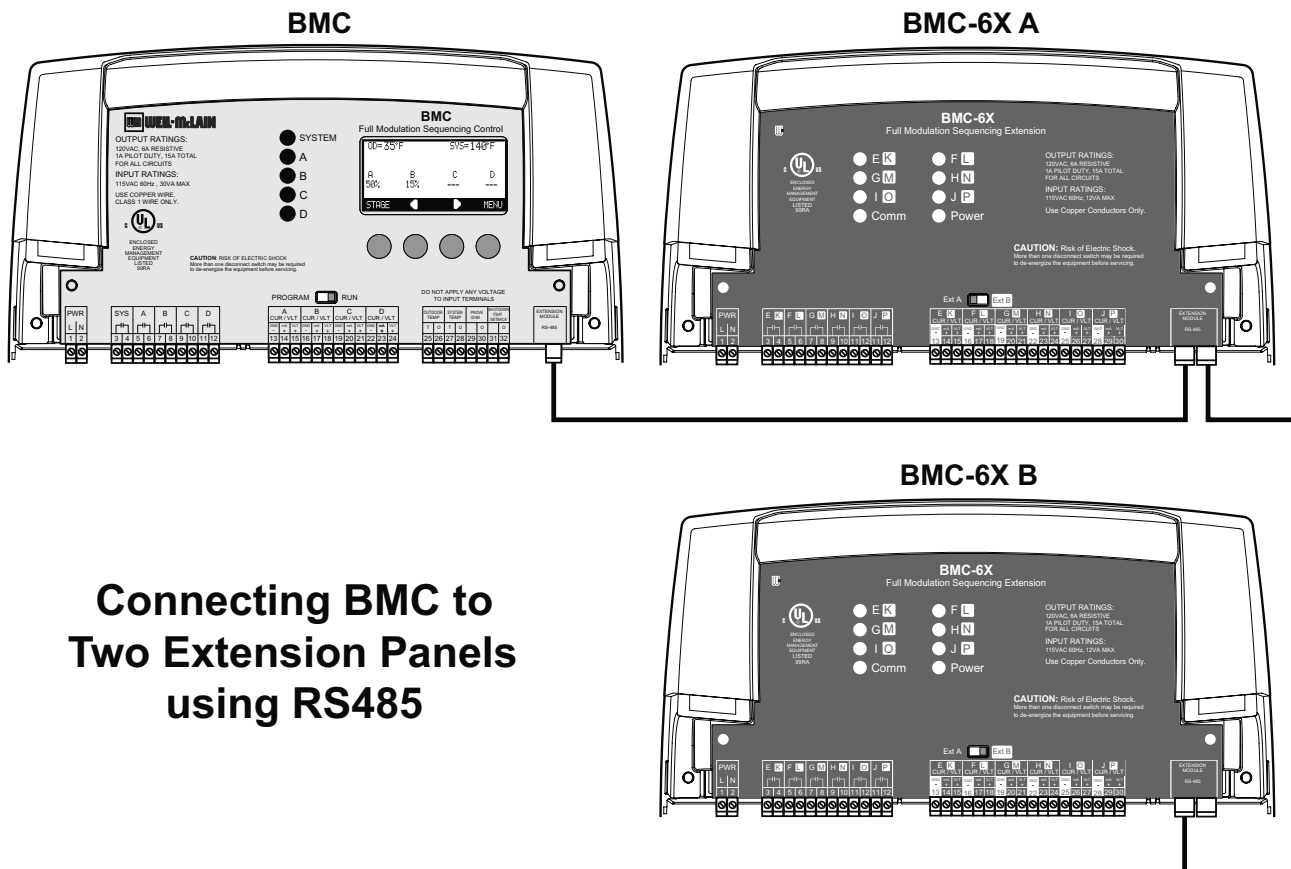

**Connecting BMC to Two Extension Panels using RS485**

# MENU SEQUENCE

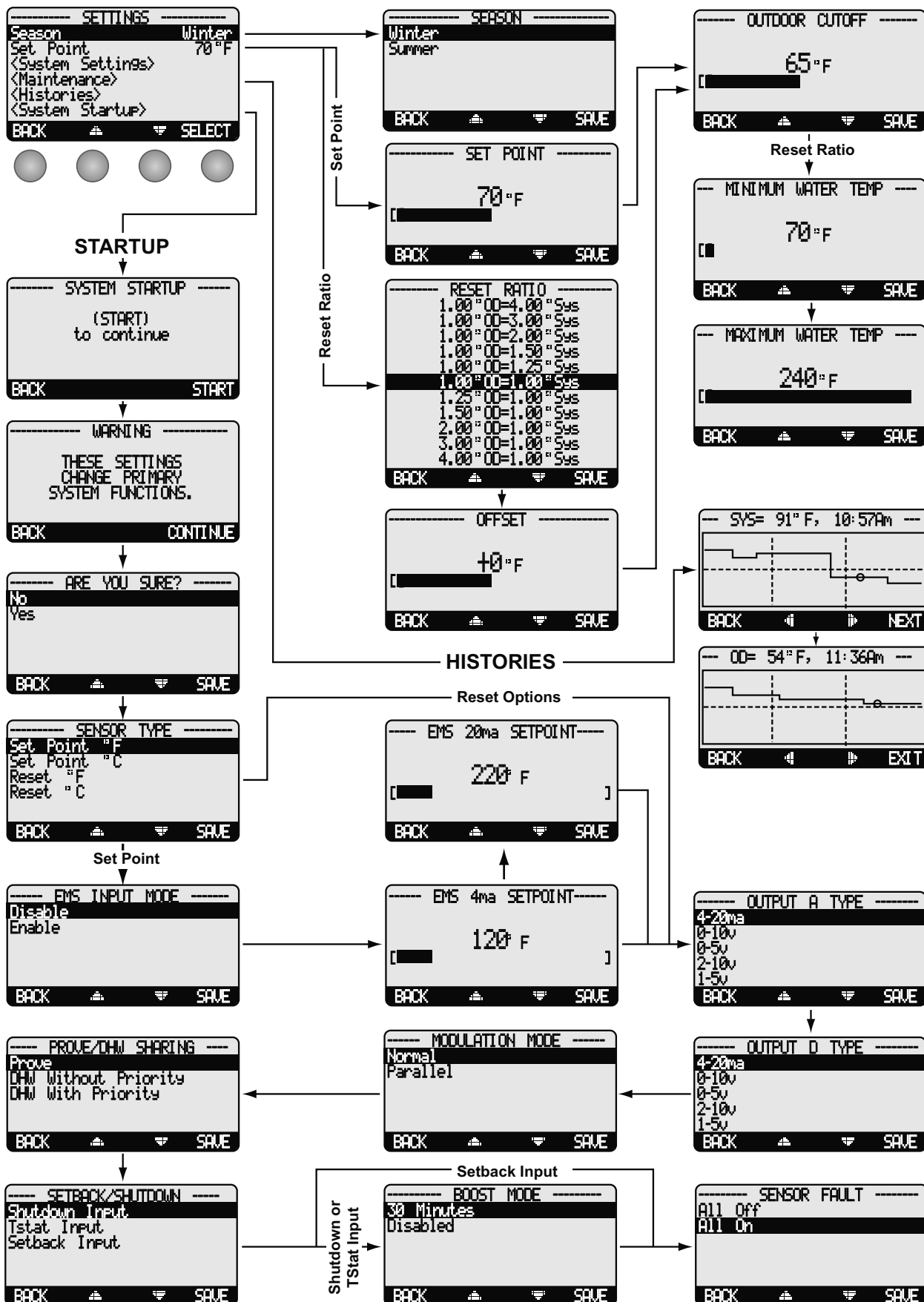

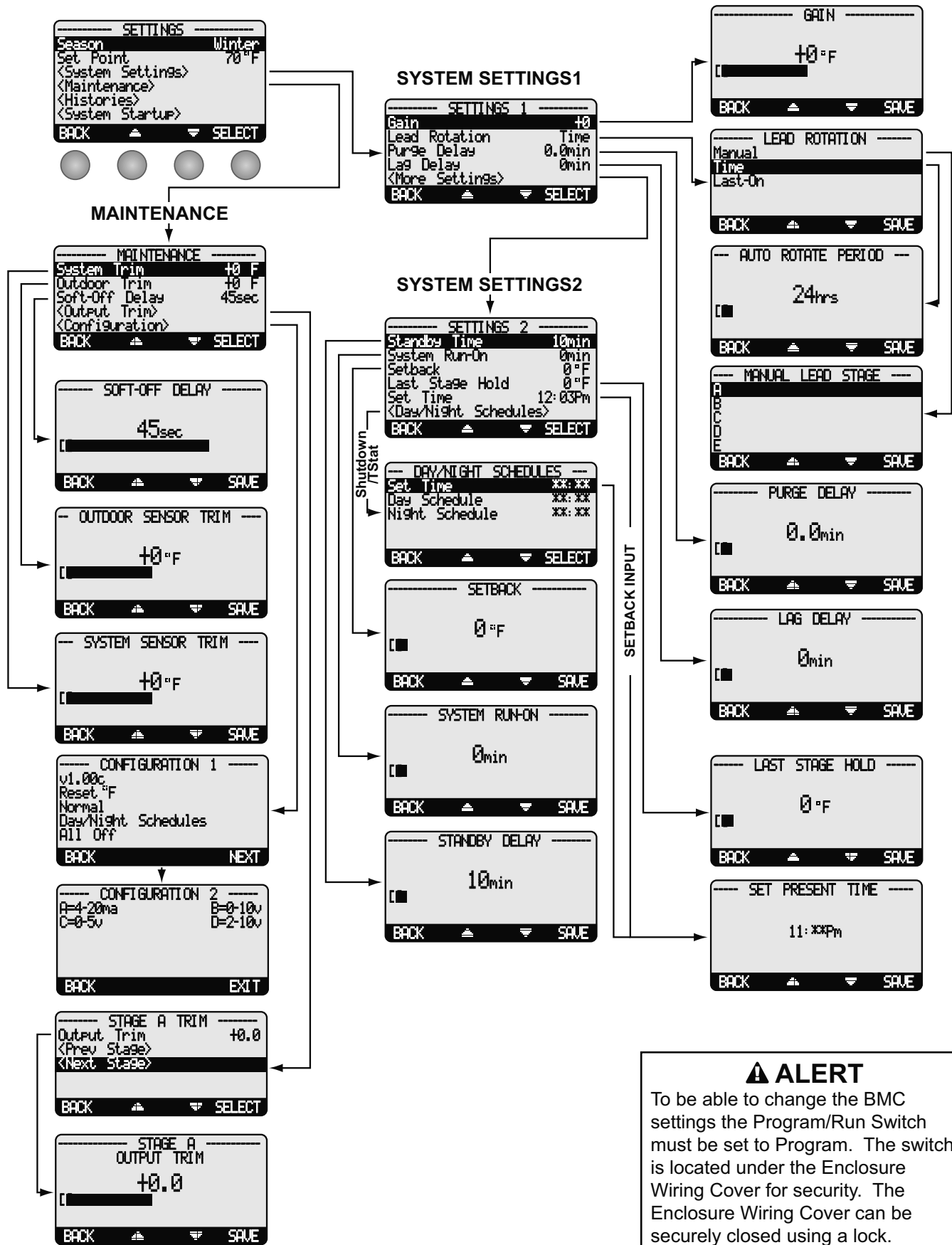

**⚠ ALERT**  
 To be able to change the BMC settings the Program/Run Switch must be set to Program. The switch is located under the Enclosure Wiring Cover for security. The Enclosure Wiring Cover can be securely closed using a lock.

## STARTUP SETTINGS

### ⚠ ALERT

A good practice after performing any Startup menu modifications is to check all operating settings and adjustments to match the new settings.

### PROGRAM CHANGE SETTINGS

To be able to change the BMC settings the Program/Run Switch must be set to Program. The switch is located under the Enclosure Wiring Cover for security. The Enclosure Wiring Cover can be securely closed using a lock.

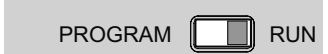

### STARTUP SEQUENCE

**Button:** MENU/<System Startup>

- When powered, the BMC performs a self diagnostics-test on its components.
- On the first power up, the System Startup screen will appear after the initialization is complete. If it doesn't, the BMC has already been configured.
- The System Startup menu sets the main parameters like the type of sensor, the type of output, and the modulating mode.



### SENSOR TYPE

Set Point °F, Set Point °C, Reset °F, Reset °C

Default: Set Point °F

**Button:** MENU/<System Startup>/.../Sensor type

- Reset mode is only available if an outdoor sensor is connected to terminals 25 and 26. DO NOT select Reset without an outdoor sensor.
- The same Weil McLain temperature sensor can display in either °F or °C.
- If °F is selected, all temperatures and settings will be displayed in degrees Fahrenheit and the BMC will operate as a Set Point Control in degrees Fahrenheit.
- If °C is selected, all temperatures and settings will be displayed in degrees Celsius and the BMC will operate as a Set Point Control in degrees Celsius.
- Set point mode does not require an outdoor sensor. If an outdoor sensor is connected in Set Point mode it will be used only as an outdoor cutoff point. That is, to turn the boilers and system pump off.

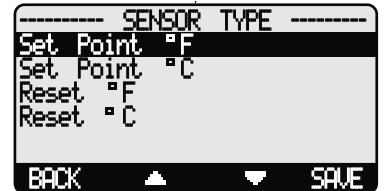

### EMS INPUT MODE (AVAILABLE IN SET POINT ONLY)

Disable, Enable

Default: Disable

4mA Adjustable from 70°F/21°C to 200°F/93°C

Default: 140°F/ 60°C

20mA Adjustable from 90°F/32°C to 240°F/116°C

Default: 200°F/ 93°C

**Button:** MENU/<System Startup>/.../EMS Input Mode

- This allows the BMC to receive an external set point from an EMS/BMS system.
- You must select the 4mA (min) and 20 mA (max) Set Points in the following screen.
- The 4mA can be set to any temperature between 70°F to 200°F.
- The 20mA can be set to any temperature between 90°F to 240°F. However, the minimum must be 20°F higher than the 4mA setting.
- Connect the 4-20mA EMS Control Interface to the BMC RS485 connection.



### SELECTING THE OUTPUT TYPE

4-20mA, 0-5V, 0-10V, 1-5V, or 2-10V Outputs

Default: 0-10V

**Button:** MENU/<System Startup>/.../Output A type/Output B type

- Outputs can be configured for 4-20mA operation (current) or the voltage range can be selected (0-5V, 0-10V, 1-5V, 2-10V).
- Check the modulating motor to determine its control requirements.
- When using Extension panels, connect them prior to configuring the Output Type. Otherwise, the BMC will not configure them properly.
- Select the appropriate Output Type for each of the boilers. The BMC can have a different Output type for each boiler.

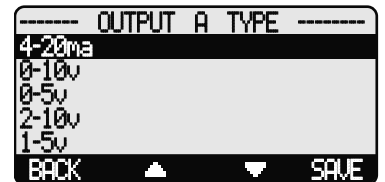

## SELECTING THE MODULATING MODE

**Normal, Parallel**

**Default: Normal**

**Button:** MENU/<System Startup>/.../Modulating Mode

- Some modulating boilers perform better as their modulation increases. For these units, it is advantageous to run one unit at high modulation than several units at lower modulation. If the units used are of this type, select Normal. This is the recommended setting for typical steel and cast iron boilers or boilers with low turndown ratios.
- There are many condensing boilers that run more efficiently at lower modulation. If it is more energy efficient to run several units at lower modulation than one at high, select Parallel. This is typically used on water-tube boilers, low mass boilers, or burners with high turndown ratios.



## PROVE/DOMESTIC HOT WATER (DHW)

**Prove, DHW Without Priority, DHW With Priority**

**Default: Prove**

**Button:** MENU/<System Startup>/.../Prove-DHW Sharing

- Input Terminals 29 and 30 can be used with either of the above features.
- When Prove is selected, the BMC will not start any boiler stage unless Prove terminals are connected.
- Using those terminals to connect to an aquastat for a Domestic Hot Water call and selecting either of the DHW options will raise the calculated water temperature to the lower of 200°F or Max Water Temperature.
- Domestic Hot Water Without Priority allows the SYS relay, mostly controlling a primary system pump, to remain energized during a domestic hot water call (aquastat call on terminals 29 and 30). In Summer, Shutdown, No Tstat call for heat, or when outdoor temperature is above Outdoor Cutoff, a DHW call will energize the SYS relay. After the DHW call termination, the SYS relay will continue to run for the System Run-On period before turning off.
- However, Domestic Hot Water With Priority de-energizes the SYS relay during a domestic hot water call (aquastat call on terminals 29 and 30) for a period of one hour. If after the hour period the DHW call still exist, the SYS relay will energize and the BMC will continue in the higher temperature setting until the domestic hot water call has terminated.

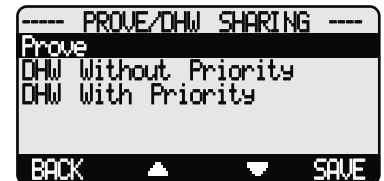

## SHUTDOWN/TSTAT/SETBACK MODE

**Shutdown Input, Tstate Input, Setback Input**

**Default: Shutdown Input**

**Button:** MENU/<System Startup>/.../Setback/Shutdown

- The BMC has two levels of heat, a Normal/Day and a Setback/Night. The Normal is good for when buildings are occupied and people are active. The Setback/Night holds a lower system temperature and is for when buildings are unoccupied or inactive.
- When Shutdown or Tstat are selected, the Day/Night Schedules (see page 21) will be available in the operating menu. Terminals 31 and 32 will function as a Shutdown (Turn off boilers when shorted) or Tstat (Turn off boilers when opened) of the heat functions. However, a call for DHW will bring the boilers on.
- When Setback is selected, the External Signal option will switch the BMC to Setback mode when shorted on terminals 31 and 32. This allows the BMC to be managed by an external device or control to provide setback. No scheduling or boost menu options will be available with Setback.

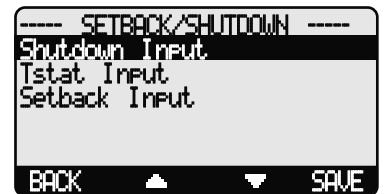

## BOOST MODE (NOT AVAILABLE WITH SETBACK)

**30 Minutes, Disabled**

**Default: 30 Minutes**

**Button:** MENU/<System Startup>/.../Boost Mode

- If you do not want a Boost simply select Disabled from the Boost Menu.
- Boost is only available if Shutdown or Tstat is selected as a previous option.
- The morning Boost is designed to return the building to comfortable ambient temperatures after the cooler Night (Setback) period. The BMC will accomplish this by running elevated water temperatures (will add Setback setting to calculated water temperature) for 30 minutes before the start of the Day schedule setting. That is, if the normal day set point at a specific outdoor was 145°F and the Setback setting was 20°F, the boost will raise the system calculated temperature to 165°F for 30 minutes before the start of the Day Schedule setting.



## SENSOR FAULT

All Off, All On

Default: All On

**Button:** MENU/<System Startup>/.../Sensor Fault

The Sensor Fault will determine the operating status of all output stages that are set to Auto when a sensor reads Short or Open.

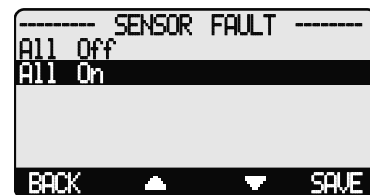

## RESET MODE

- When All-On is selected, the BMC will turn all boilers On to a 100% when System reads Short or Open and Outdoor is below Outdoor Cutoff. When Outdoor reads Short or Open, the BMC will turn all boilers On to a 100%.
- When All-Off is selected, the BMC will turn all boilers Off when either System or Outdoor sensor reads Short or Open.

## SET POINT MODE

- When All-On is selected, the BMC will turn all boilers On to a 100% when the System sensor reads Short or Open.
- When All-Off is selected, the BMC will turn all boilers Off when the System sensor reads Short or Open.
- The Outdoor Sensor Short or Open status will not affect the control operation in Set Point mode.

## SETTING THE CONTROL TO FACTORY DEFAULTS

To Reset the BMC control to its original factory defaults, power down the control. Hold down the two right most buttons while powering the control back up until the Total Clear Started screen appears. The Display will direct you to the Startup menu to program the control after the defaults are loaded.

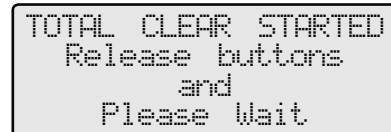

NOTE: When resetting the control to original factory defaults all control settings will be overwritten and will no longer exist.

### **⚠ ALERT**

Do not turn off power to control until all Startup settings have been made. Otherwise, the next power-up will be set to many Startup factory settings that might not fit your application.



## OPERATING SETTINGS

### PROGRAM CHANGE SETTINGS

To be able to change the BMC settings the Program/Run Switch must be set to Program. The switch is located under the Enclosure Wiring Cover for security. The Enclosure Wiring Cover can be securely closed using a lock.



### SEASON

Winter, Summer

Default: Winter

Button: MENU/Season

- The BMC will turn all boiler relays off when it is in Summer setting. However, a DHW call will bring boilers back on if needed. The Message Display Line will display *Summer* to show status.
- When in Winter, the BMC will activate the Sys relay whenever the Outdoor temperature (OD) falls to or below the Outdoor Cutoff setting. In addition, it will begin heating whenever the System temperature (SYS) falls below the Set Point Temperature. The Message Display Line will not display any season information when in Winter.
- When the heating season is over, it is a good practice to switch the BMC to Summer setting. This will allow DHW calls to operate the boilers when needed.



**ALERT**  
 DO NOT turn power off to the BMC when heating season is over. If you do so, the battery will run down and will have to be replaced. Instead, switch to Summer.

### SET POINT (NOT ADJUSTABLE IN EMS MODE)

Adjustable from 70°F/ 21°C to 250°F/ 121°C

Default: 140°F/ 60°C

Button: MENU/Set Point

- The Set point is the temperature value the BMC will use to control the system.
- It only be available when Set Point is selected as the Sensor Type. See page 14.
- The BMC will increase, decrease or hold the modulation of the boilers to maintain the system temperature around the Set point. The amount of fluctuate around the set point depends on the Modulation Mode, System Settings, and Stage Settings.
- If the EMS Mode was Enabled, the Set Point will be set by the EMS/BMS system and will be available to be read but not changed on the display.

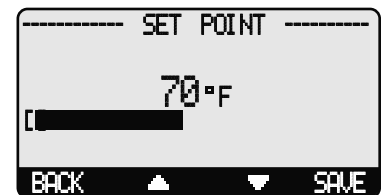

### RESET RATIO

Adjustable 1.00°OD : 4.00°Sys to 4.00°OD : 1.00°Sys Default: 1.00°OD : 1.00°Sys

Button: MENU/Set Point

- It's only be available when Reset is selected as the Sensor Type. See page 14.
- The Reset Ratio determines how the System water temperature (SYS) will vary with Outside temperature (OD). With any of the ratios, the colder it becomes outside, the hotter the temperature of the system water. The ratios are adjustable from 1.00 (OD):4.00 (SYS) to 4.00 (OD):1.00 (SYS). (See Understanding Operation Concept on page 5)
- With a 1.00 (OD):4.00 (SYS) ratio, the System water temperature (SYS) will increase rapidly as the outside temperature falls, hitting the maximum of 240°F at 24°F outside temperature. With a 4.00 (OD):1.00 (SYS) ratio, the System water temperature (SYS) will increase slowly as the outside temperature falls. Even at -30°F, the system water will only be 125°F, and at 24°F outside, the system water will be 112°F. Such a low Reset Ratio might be used with radiant floor heating applications.
- With most baseboard heating applications, a 1.00 (OD):1.00 (SYS) setting is a good place to start. With a 1.00 (OD):1.00 (SYS) ratio, for every degree the outside temperature falls, the system water temperature is increased one degree.
- If required: **Adjust the RESET RATIO in cold weather.** If the ambient building temperatures are too cold in cold weather, move the ratio to a higher selection. That is, if 1.00 (OD):1.00 (SYS) was initially selected, change the selection to 1.00 (OD):1.25 (SYS). If the building temperatures are too warm in cold weather, move the ratio to a lower selection. That is, if 1.00 (OD):1.00 (SYS) was initially selected, change the selection to 1.25 (OD):1.00 (SYS).

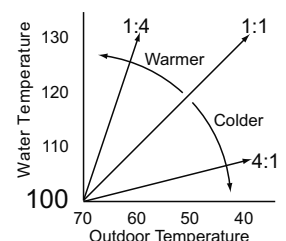
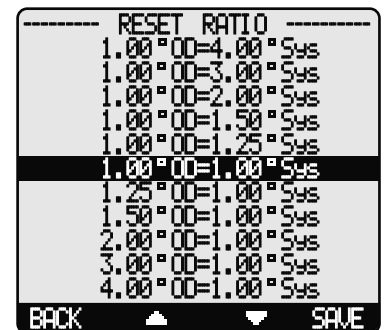

## OUTDOOR CUTOFF TEMPERATURE

Adjustable Off, from 20°F/ to70°C - 100°F, On

Default: 60°F/ 16°C

Button: MENU/Set Point/Outdoor Cutoff

in Set Point

Button: MENU/Set Point/Offset/Outdoor Cutoff

in Reset

- If the outdoor sensor is installed, the Outdoor Cutoff screen will automatically appear after the temperature Set Point has been selected.
- When the outdoor temperature falls to the adjustable Outdoor Cutoff temperature, the BMC will control and modulate boilers to hold the calculated temperature.
- When the outdoor temperature rises to the Outdoor Cutoff plus a 2°F differential, the BMC will turn all boilers off. The System relay will remain energized for the Run-On delay then de-energize.
- The Outdoor Cutoff can be set from 20°F to 100°F. In addition, the Setting can be set to ON or OFF. In the ON position, the System Relay will run regardless of the Outdoor temperature (OD) and the burner stages will be active to hold the calculated water temperature. (Note: The lowest water temperature the BMC will circulate is 70°F. If the Outdoor Cutoff is turned ON and the Season is set to Winter, the BMC will circulate at least 70°F water even in the hottest of weather.) In the OFF position, the system pump will always be off and all burner stages will be off.



## OFFSET

Adjustable from 50F°/28C° to (-50F°/-28C°)

Default: 0F°/0C°

Button: MENU/Set Point/Offset

in Reset only

- The Offset setting lets you adjust the starting points of the Reset Ratio curves. This means that, regardless of the Outdoor temperature (OD), or the Reset Ratio that has been selected, when the Offset setting is changed, that change is directly added to or subtracted from the calculated temperature. For example, if the Set Point temperature was 130°F and the Offset was changed from 0° to 10° (an increase of 10°), then the Set Point temperature would increase to 140°F
- The Offset setting does not change the ratio selection. For instance, with 1.00 (OD):1.00 (SYS) Reset Ratio, the System water temperature (SYS) will always increase one degree for each degree change in the Outdoor temperature (OD). What the Offset does is add or subtract a constant temperature value. (See Understanding Operation Concept on page 5)
- If required: **Adjust the Water Offset in mild weather.** If the ambient building temperatures are too warm in the mild weather, decrease the Water Offset. If the ambient building temperatures are too cold in the mild weather, increase the Water Offset. The rule of thumb for baseboard radiation is to change the Offset 4°F for every 1°F you wish to change the building temperatures. In radiant heat applications, change the Offset 1°F or 2°F for every 1°F you wish to change the building temperature.



## MINIMUM WATER TEMP

Adjustable from 70°F/21°C to 180°F/82°C

Default: 140°F/ 60°C

Button: MENU/Set Point/Offset/Outdoor Cutoff/Minimum Water Temp

in Reset only

- The Minimum Water Temperature must be set to the boiler manufacturer's specification. The BMC will calculate the Set Point based on the Outdoor temperature (OD), the Reset Ratio, and the Offset value. The BMC will control all boilers modulation to hold either the Set Point temperature, or the Minimum Water Temperature, whichever is higher.
- The Minimum Water Temperature must be at least 20°F lower than the Maximum Temperature (See next setting).

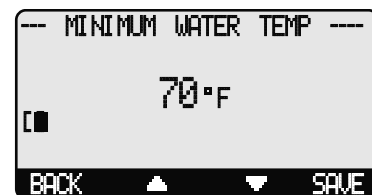

## MAXIMUM WATER TEMP

Adjustable 90°F/21°C - 240°F/116°C

Default: 200°F/93°C

Button: MENU/Set Point/Offset/.../Maximum Water Temperature

in Reset only

- This is the highest temperature heating water the BMC will circulate through the heating system. It is available in Reset mode only.
- When using a radiation system, it should be set according to the tubing or floor manufacturer's specification.
- The Maximum Temperature must be at least 20°F higher than the Minimum Temperature (See previous setting).



## SYSTEM SETTINGS

**Button:** MENU/<System Settings>

The Settings 1 and Settings 2 menus provide access to adjusting and fine-tuning the system for enhanced comfort and more fuel savings. The BMC behaves differently based on the selected Control Modes (see Startup Settings).

- Gain
- Lead Rotation
- Purge Delay
- Lag Delay
- Standby Time
- System Run-On
- Setback
- Last Stage Hold
- Day/Night Schedules

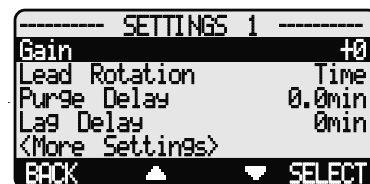

### ⚠ ALERT

To be able to change the BMC settings the Program/Run Switch must be set to Program. The switch is located under the Enclosure Wiring Cover for security. The Enclosure Wiring Cover can be securely closed using a lock.

## GAIN

Adjustable from -10 to +10

Default: 0

**Button:** MENU/<System Settings>/Gain

- The Gain adjusts the aggressiveness of the BMC PID logic to control how much modulation is changed when the system temperature is different from the Set Point.
- A Gain of 0 is a good starting point for all systems.
- If during normal load conditions, the system temperature tends to oscillate significantly, decrease the Gain by two numbers (for example, from 0 to -2). Wait for at least 15 minutes before evaluating how the change has affected the system.
- If during normal load conditions the system temperature tends to remain consistently below the Set Point (or consistently above the Set Point), increase the Gain by two numbers (for example, from 0 to 2). Wait for at least 15 minutes before evaluating how the change has affected the system.



## LEAD BOILER ROTATION

Adjustable Manual, Time (1 hr to 60 Days), Last-On

Default: Time (24Hours)

**Button:** MENU/<System Settings>/Lead Rotation

- The Lead Boiler is the first boiler brought on when output is required.
- The Lead Boiler can be rotated automatically, manually or based on Last-On. The automatic rotation is recommended.
- The current Lead Boiler is shown in brackets on the main display.
- Only boilers which are set to Auto Mode can be Lead. Therefore, not all the boilers may be available when manually selecting a new Lead Boiler.



## PURGE DELAY

Adjustable from 0.0min to 10.0min

Default: 1.0min

**Button:** MENU/<System Settings>/Purge Delay

- Many boilers go through a purge cycle before they are brought on line.
- When the BMC activates a boiler, it does not start to calculate its output until the Purge Delay is over. This allows the boiler to fully come online and begin producing output.
- The Purge Delay helps prevent short cycling of a newly activated burner. Once the burner is activated, it **MUST** run through the entire Purge Delay period.
- The minimum Purge Delay setting **MUST** be set to the time required by the boiler manufacturer. Time entry is in 0.1 of a minute (i.e. 1.5min will equal 90 seconds.)
- The Message Display Line will display *Purge Delay* and the amount of time remaining in the purge.



### ⚠ ALERT

Set Purge Delay as per boiler manufacturer recommendation.

## LAG DELAY

Adjustable from 0min to 60min

Default: 0min

**Button:** MENU/<System Settings>/Lag Delay

- The Lag Delay requires the previous stage to remain at 100% modulation for the full period of the Lag Delay before another Stage can be activated. For example, if the Lag Delay was set to 10 minutes, the Lead Stage would need to remain at 100% modulation for a full ten minutes (never backing down to even 99%) before a lag stage could be activated. The Message Display Line will display *Lag Delay* and the remaining time.
- Set the Lag Delay to 0 min when two or more Stages will generally be needed to hold the load.
- The Lag Delay is useful in installations where one unit should usually have enough output to hold the load unless it fails or load conditions become extreme.
- The Lag Delay overrides the value of the Modulation Start % selected for each stage. Regardless of that setting, the previous stage must reach 100% and stay there before the lag stage can be activated.
- The full Lag Delay must always elapse regardless of what happens to system temperature. Therefore, set the Lag Delay to 0 min if you want smooth set point control using multiple units.



## STANDBY DELAY

Adjustable from 1min to 60min

Default: 10min

**Button:** MENU/<System Settings>/<More Settings>/Standby Time

- The Standby Delay only applies to boilers in Standby Mode. See Mode on page 25.
- A boiler can be set to be a Standby boiler using the Stage Menu.
- A Standby boiler can only be activated after all the boilers in Auto Mode have run at 100% modulation for the full Standby Time.
- Standby boilers are used for backup or extreme load conditions only. A Standby boiler can never be a Lead Stage
- The full Standby Delay must always elapse regardless of what happens to system temperature. Therefore, shorter Standby Times will result in smoother set point operation in extreme conditions. Longer Standby Times may prevent a Standby boiler from firing if the other boilers can eventually meet the load, or if the load decreases.



## SYSTEM RUN-ON

Adjustable from 0min to 360min

Default: 0min

**Button:** MENU/<System Settings>/<More Settings>/System run-On

- The SYS relay will energize whenever the Outdoor temperature (OD) is below the Outdoor Cutoff and the Shutdown is Open or the Tstat is closed. When the Outdoor temperature increases 2°F above the Outdoor Cutoff after the last burner relay has de-energized, the SYS relay will stay on for a period set by the System Run-On.
- A common use for the System Run-On is to control a system pump in a heating system. The extra time helps transfer the heat from the boilers to the heating system.
- The System Run-On time should be set based on the size and type of the boilers and pumps. In general, a boiler with low water content and high horsepower will need a longer System Run-On than a boiler with the same horsepower and more water content. (Refer to boiler manufacturer recommendation)



## SETBACK

Adjustable from 0F°/0C° to 75F°/42C°

Default: 0F°/0C°

**Button:** MENU/<System Settings>/<More Settings>/Setback

- The Setback feature can be used to provide the BMC with a lower temperature Set Point when less load is required.
- The lower Set Point will appear on the main display indicating this condition.
- For example, if the calculated temperature is 180°F and the Setback is 20°F, then when in Setback, the BMC will hold a Set Point of 160°F.
- A typical use for Setback is to provide less system temperature to a building during the night or on the weekends when building is not occupied, but heat is still required.
- The amount of Setback selected is subtracted from the Set Point when a Setback Input Signal is received or the Night Time schedule setting started.



- If Setback Input is selected as a Shutdown/Tstat/Setback Mode (See page 15), the Setback will not be activated unless a Short dry contact signal is received on the Shutdown/Tstat/Setback terminals (31 and 32) as a signal.
- If Shutdown Input or Tstat Input is selected as a Shutdown/Tstat/Setback Mode (See page 15), the Setback will be activated only when Night Schedule time has started.

## ⚠ ALERT

When using Soft-Off and Last Stage Hold, the last boiler stage will not turn off until both parameters have elapsed. In this case, Soft-Off will start after the Last Stage Hold.

## LAST STAGE HOLD

Adjustable from 0F°/0C° to 30F°/17C°

Default: 0F°/0C°

Button: MENU/<System Settings>/<More Settings>/Last Stg Hold

- The Last Stage Hold prevents short cycling of the Lead Stage during low load periods.
- In low load conditions, the system might require less output than the lowest fire on one Stage. When the BMC brings on the Lead Stage, the Set Point is quickly exceeded, and the BMC turns the Lead Stage off.
- To prolong the run time during this type of condition, use the Last Stage Hold setting to let the system temperature exceed the Set Point by the number of degrees selected.
- For example, with a Set Point of 160°F and a Last Stage Hold setting of 10°F, the Lead Stage boiler will remain on, at low modulation, until the Set Point reaches 170°F.
- In many cases, it is better to overshoot slightly than to short cycle a boiler.
- When Soft-Off is set to other than 0 seconds, the Lead Boiler will need to remain at or exceed the Last Stage Hold for the Soft-Off period before turning off.

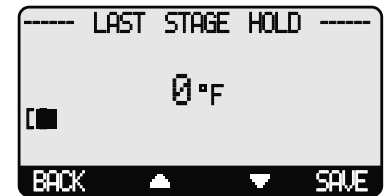

## AVOIDING CONFLICTING BOILER LIMITS

- The temperature limits set on the boilers MUST be set considerably higher than the BMC's Set Point for the reasons detailed below.
- The BMC sensor is located in a common header some distance from the boilers.
- As the temperature rises in the header and before reaching the sensor location, energy is dissipated. Therefore, the temperature in the header could be lower than that registered by boiler sensors.
- In addition to the normal drop experienced between the boiler's temperature and that read by the BMC sensor, the Last Stage Hold setting must be accounted for. The boiler limit must be set above the Set Point PLUS the Last Stage Hold PLUS the normal drop experienced in the piping.
- Using the previous example of a 10°F Last Stage Hold with a 160°F Set Point, the boilers' limits must be set enough over 170°F to prevent the boilers' internal limits being reached. In this situation, the boiler high limit should be set at approximately 180°F or higher to prevent the difference in boiler temperature vs. header temperature causing erratic operation.

## ⚠ WARNING

The temperature limits set on the boilers must be higher than the BMC Set Point. Read the section at left for details that will prevent erratic system operation.

## DAY/NIGHT SCHEDULES

(Available when "Shutdown or Tstat" is selected from the Shutdown/Tstat Setback Startup menu option only)

Button: MENU/<System Settings>/<More Settings>/Day/Night Schedules

- The BMC has two levels of heat. The Day level is used when a building is occupied and people are active.
- The Night (Setback) level is used when a building is not occupied, or when people are sleeping. This setting reduces the calculated temperature by the Setback setting (See page 20). If the Day calculated water temperature was 150°F and the Setback was 20°F, the Night Schedule will run at (150°F - 20°F) = 130°F.
- If the Boost feature is being used, it uses the Day Schedule as a Boost ending point. That is, if the Day Schedule is set to start at 6:00AM, the Boost will start 30 minutes prior to the Day setting at 5:30AM. The BMC will then raise the calculated water temperature by the Setback amount. Using the previous example, at 5:30AM the BMC will raise the calculated water to 170°F (150°F + 20°F) until 6:00AM.

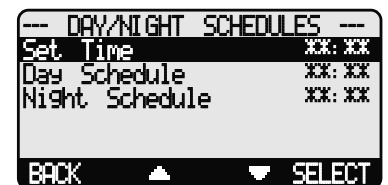

## SET TIME

**Button:** MENU/<System Settings>/<More Settings>/Set Time

**Button:** MENU/<System Settings>/<More Settings>/<Day/Night Schedules>/Set Time

- Adjust the time by selecting Time from the menu and then scrolling through the hours then select Save. Then, scroll through the minutes then select Save. If the hours are to be set to PM, scroll through the AM hours to reach the PM hours.



### **⚠ ALERT**

Remember that the battery is the backup for the Time. If no power is supplied to the BMC and there was no battery or battery had no power, time values will be lost and will need to be reset.

## HISTORY

**Button:** MENU/<Histories>

The BMC provides users with a graphical history of the System and Outdoor temperatures for the previous 24 hours. The temperatures are sampled every 12 minutes. That is, readings of both System and Outdoor temperatures are recorded and stored every 12 minutes for the last 24 hours.

- To view the values of specific time period, use the two middle buttons to scroll to that time and read the upper left temperature.
- The first screen will be the System Temperature History. By clicking on the Next button, you'll be able to view the Outdoor Temperature History.

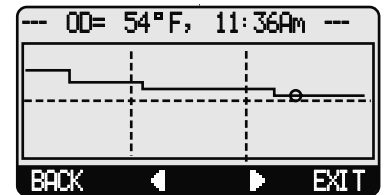
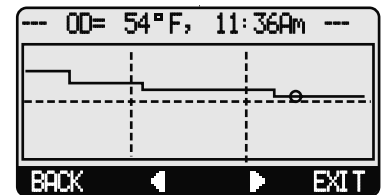

## MAINTENANCE

**Button:** MENU/<Maintenance>

The Maintenance menu gives access to sensor and outputs trimming and Soft-Off. In addition, you'll have access to view the Startup configuration settings.

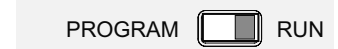
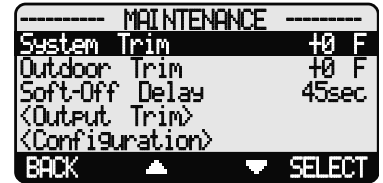

### ⚠ ALERT

To be able to change the BMC settings the Program/Run Switch must be set to Program. The switch is located under the Enclosure Wiring Cover for security. The Enclosure Wiring Cover can be securely closed using a lock.

## SYSTEM & OUTDOOR SENSOR TRIM

Adjustable from  $-5^{\circ}\text{F}/-3^{\circ}\text{C}$  to  $+5^{\circ}\text{F}/+3^{\circ}\text{C}$

Default:  $0^{\circ}\text{F}$

**Button:** MENU/<Maintenance>/System Trim

**Button:** MENU/<Maintenance>/Outdoor Trim

- The Weil McLain thermistor type sensors are very accurate, and normally require no calibration. Sometimes it may be desirable to make small adjustments to the displayed value for either the Outdoor temperature (OD) or the System temperature (SYS). The Trim setting can adjust the displayed value by  $\pm 5^{\circ}\text{F}$ .
- Do not use the Trim setting to make the Outdoor temperature sensor match that reported on the radio or TV. Outdoor temperature can vary widely over a broadcast range. Only trim the outdoor sensor based on an accurate thermometer reading taken where the sensor is located.

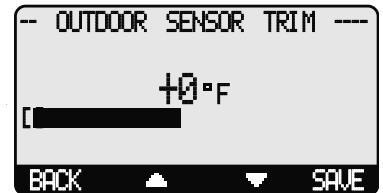
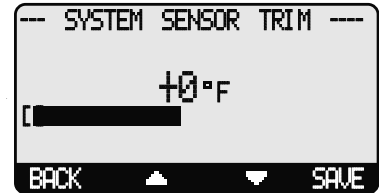

## SOFT-OFF DELAY

Adjustable from 0sec to 60sec

Default: 45sec

**Button:** MENU/<Maintenance>/Soft-Off Delay

- When a stage is no longer needed, the Soft-Off keeps that stage burner in Low Fire prior to turning it off.
- The display will show a percent that is equal to the Ignition % for the stage in Soft-Off delay. That number will blink for the Soft-Off delay period.
- If during the Soft-Off delay period the BMC needed that stage to turn back on, the stage will be released from the Soft-Off delay and resume normal operation.
- On a Shutdown initiation or Tstat termination any stage that was on will go into Soft-Off delay before fully turning off.



### ⚠ ALERT

When using Soft-Off and Last Stage Hold, the last boiler stage will not turn off until both parameters have elapsed. In this case, Soft-Off will start after the Last Stage Hold has been reached or exceeded.

## OUTPUT TRIM

Adjustable from -5 to +5

Default: 0

**Button:** MENU/<Maintenance>/Output Trim

- Each of the stages controlled by the BMC has a separate Output Trim setting.
- Output Trim acts as an adjustment to a stage output percent to match the burner motor.
- After adjusting the Output Trim, test the operation to make sure the results match your expectation.



### ⚠ ALERT

DO NOT use the Output Trim for a Stage unless it is absolutely necessary. Test burner operation and modulation output matching after adjusting the Output Trim.

## CONFIGURATION

**Button:** MENU/<Maintenance>/<Configuration>

- This menu option provides a consolidated view of the BMC's Startup and Stage settings.



## DISPLAY

The BMC display layout provides a variety of information that gives an immediate picture of the operation status. The display shows four boilers at a time. When extensions are present, the two middle buttons scrolls the screen to view additional boilers. Moreover, all the information is brightly displayed. It can be viewed in brightly or dimly lit rooms.



- The buttons' functionality changes based on the screen and menu level. The buttons' functionality is displayed on a dark background on the screen bottom line.
- Horizontal arrows are to scroll through the available stages.
- Vertical arrows are to scroll through the menu functions when in menus or to change values of settings when in its specific screen.
- The Top line displays the available sensor values.
- The second line displays the Target set point. However, it will display any messages pertaining to the operation or status.
- The third line will list the boiler stages. Any additional stages can be scrolled to using the two middle buttons. The Lead boiler letter will be bracketed. See Lead Boiler Operation on page 19.
- The fourth line lists each boiler modulation status. See Display Boiler Modulation Status for possible status.

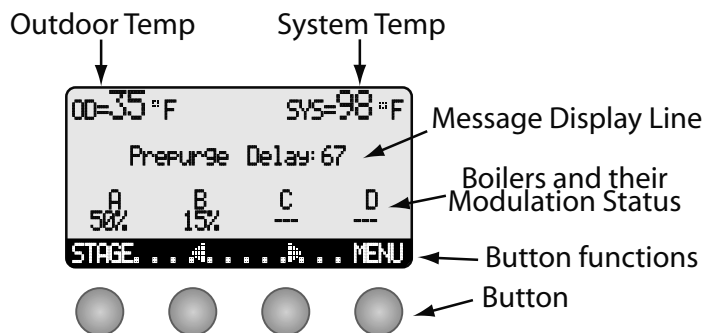

## DISPLAY BOILER MODULATION STATUS

The BMC boiler modulation status gives immediate access to each boiler status. The following list show all possible boiler status:

- Boiler is off due to no call for heat.
- 97% Boiler is modulating at the indicated percentage.
- ON Boiler Stage Mode is set to ON and boiler is firing at 100% (boiler is in bypass). See Mode on page 25.
- OFF Boiler Stage Mode is set to OFF and boiler stage is unavailable or boiler does not exist. See Mode on page 25.
- m95% Boiler Stage Mode is set to Manual and set to the specified percent. See Mode on page 25.
- C/E Boiler on Extension panel is NOT communicating back to the BMC. See connecting extensions on page 11.



## DISPLAY MESSAGES

The BMC normal display layout reserved the second line for message indications. The following is a list of the most common Message Display Line information:

- Summer The control is set to Summer. No heat is active. See Season on page 17.
- Shutdown Active The Shutdown Terminals are Shorted. No boilers will be active. See Shutdown on pages 15 and 9.
- Shutdown by EMS The EMS is below 2mA or above 22mA. See EMS input and External Set Point pages 14 and 31.
- Tstat Call The Tstat Terminals are Shorted. Boilers will be active.
- DHW Call (171°F) There is a DHW (Domestic Hot Water) call. The BMC will Raise system Set Point to the indicated temperature. DHW increases calculated temperature to 200°F or Max Water Temperature, whichever is lower. See DHW setting on page 15.
- Purge Delay: 23 The current boiler is in purge cycle and the remaining purge time in seconds is 23. See Purge Delay on page 19.
- Lag Delay: 123 The lead boiler is at 100% and the remaining purge time to start the lag boiler in seconds is 123. See Lag Delay on page 20.
- Holding Until 150°F The Lead boiler is in Last Stage Hold. This example shows that the lead stage will turn off when system temperature reaches 150°F. See Last Stage Hold on page 21.
- System Run-On: 46 The System relay is ON for the System Run-On Delay. This example shows that it will remain in System Run-On for an additional 46 seconds before turning off. See System Run-On on page 20.
- Waiting for Prove The System relay is ON and the prove terminals are open before the lead boiler relay can energize. See Prove setting on page 15.
- Prove Failure After boilers have run for a while, Prove signal was opened. The boiler relays will de-energize. However, the System relay will remain energized. See Prove setting on page 15.

## BOILER STAGE SETTINGS

**Button:** STAGE/

The Maintenance menu gives access to sensor and outputs trimming and Soft-Off. In addition, you'll have access to view the Startup configuration settings.

- In most installations, all active boiler adjustments are the same, but each can be configured differently if desired.
- If the boilers are not set up properly, the BMC operation may appear to be erratic.
- When the STAGE button is depressed, the Boiler A Settings menu will be shown.
- Make all the appropriate settings for Boiler A (See below).
- After completing all the settings for Boiler A (See below), you have the option of copying these settings to all other boilers. Everything but the Mode -- Auto/Standby/Manual/Off/On -- will be copied.
- Then select the Next Stage option from the menu to bring up the Boiler B Settings menu and make all the settings. Continue until all boilers have been set.
- If a BMC-6X is connected to the BMC, scrolling through stages using the Next and Prev Stage menu options will scroll through the BMC-6X stages as well.

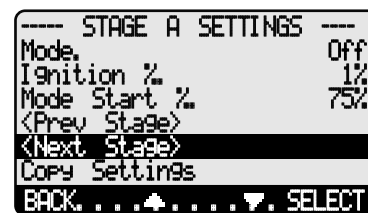

### ⚠ CAUTION

Remember to set the Mode for each stage. For Stages that do not have a boiler, contractor must change their Mode to OFF. Otherwise the BMC will include them in the modulation calculation and rotation. That might have dire effects on system response.

### ⚠ ALERT

To be able to change the BMC settings, the Program/Run Switch must be set to Program. The switch is located under the Enclosure Wiring Cover for security. The Enclosure Wiring Cover can be securely closed using a lock.

PROGRAM  RUN

## MODE

**Auto, Standby, Manual, Off, On**

**Default: Auto**

**Button:** STAGE/Mode

- The BMC only controls the modulation of boilers set to Auto or (after a delay) those set to Standby. None of the other settings is recommended for output boilers connected to active units.
- Any boiler without an active unit connected must be set to Off.
- The following list describes the MODE options:



# BMC and BMC-6X Installation and Operation Manual

- Auto -** The BMC will control the boiler's operation to maintain the desired Set Point. Only boilers set to Auto can be Lead boilers.
- Standby** Standby boilers can only be activated when all boilers in Auto have been at 100% modulation for a selectable period of time. Standby is generally used when you want a specific boiler to be available in extreme load conditions. Note that a Standby boiler Cannot be a Lead boiler.
- Manual** The Manual Mode should only be used when testing a boiler. Manual overrides the Prove input. The exact percent of modulation for a boiler can be set with the Manual mode. Once selected, the unit will immediately turn on and modulate to the selected percentage.
- Off** Any output Boiler A through D not connected to a physical unit should be set to Off. The Off Mode can also be used to disable units that are being serviced.
- On** The On Mode should only be used when testing a boiler. The On Mode overrides the PROVE input. Once set to On the boiler will immediately start firing and modulate to 100%.

## IGNITION %

Adjustable from 1% to 50%

Default: 1%

**Button:** STAGE/Ignition %

- The Ignition Point is the percent of modulation that must be attained before the unit can be activated.
- For most modern power draft units, the Ignition Point should be set at 1%.
- Older units or atmospheric units may require the modulating fuel valve to be open from 20-50% before proper ignition can be attained. Check with the boiler manufacturer if you are in doubt about the minimum position of the fuel valve for ignition.

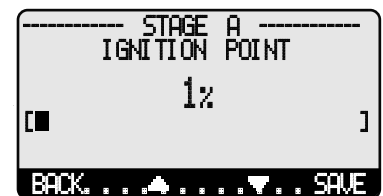

## MODULATION START %

Adjustable from 0% to 100%

Default: 75%

**Button:** STAGE/Mod Start %

- The Modulation Start determines at what modulation percent the previous boiler should be for the current boiler to be activated.
- For example, if the Modulation Start for Boiler B is set to 75%, then when Boiler A reaches 75% modulation plus Ignition%, Boiler B (if Boiler B is in Auto Mode and is not already on) will be brought on at the Ignition % level.
- When modulation is decreasing, the lag unit will remain on at the Ignition % modulation until the previous boiler reaches 40% of lag boiler's Modulation Start, or 2% above the Ignition Point, whichever is higher.
- Using the same example, as the load decreases, Boiler B would modulate down to its Ignition %. Boiler A would then modulate down to 30%. Only then would Boiler B turn off.
- If the Lag Delay is set to anything other than 0, a boiler must always go up to 100% modulation before the next boiler is activated. However, the Modulation Start % should still be set correctly, because it will be valid when modulation is decreasing.

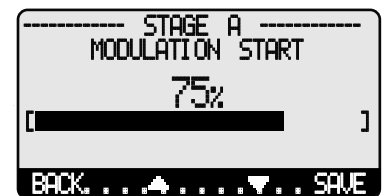

## COPY SETTINGS - BOILER A ONLY

**Button:** STAGE/Copy Settings

- If all the active boilers will have the same Ignition Start Point and Modulation Point, they can be set for Boiler A and then copied to the other boilers.
- It is still required to select the Mode for all other boilers as the Mode is NOT copied.



### ⚠ ALERT

The Mode MUST be set for each boiler. The Copy Settings command will not set the Mode for the remaining boilers. Only Ignition % and Modulation Start % are copied.

## TROUBLESHOOTING

### SENSOR INPUTS

#### Display shows Sensor OPEN or SHORT

When OPEN, Check the sensor is connected and the wires are continuous to the BMC. Finally follow the procedure for Incorrect Temperature or Pressure Display. When SHORT Remove the wires from the sensor terminals. The display should change to read OPEN. If it does not, the BMC may be damaged.

#### Display shows an Incorrect Temperature

Remove the wires from the sensor terminals. The display should change to read OPEN. If it does not, the BMC may be damaged. Take an ohm reading across the detached sensor wires. The ohm reading should correspond to the Temperature sensor Table. If it does not, the sensor may be damaged.

**Temperature Sensor Chart**

TEMPERATURE		Value (in Ohms)
°F	°C	
-30	-34	117720
-20	-29	82823
-10	-23	59076
0	-18	42683
10	-12	31215
20	-7	23089
25	-4	19939
30	-1	17264
35	2	14985
40	4	13040
45	7	11374
50	10	9944
55	13	8714
60	16	7653
70	21	5941
80	27	4649
90	32	3667
100	38	2914
110	43	2332
120	49	1879
130	54	1524
140	60	1243
150	66	1021
160	71	842
170	77	699
180	82	583
190	88	489
200	93	412
210	99	349
220	104	297
230	110	253
240	116	217
250	121	187

### CONTROL OPERATION

#### No Heat

- **Season** - Make sure that the Season is set to Winter. Check Message Display Line on page 24.
- **Prove** - Even though, the system relay may be energized, the BMC will not energize and stage relays unless the Prove is shorted. Check Message Display Line on page 24.
- **Shutdown** - The BMC will activate stage outputs when the Shutdown terminals are short. Check Message Display Line on page 24.
- **Tstat** - The BMC will activate stage outputs when the Tstat terminals are open. Check Message Display Line on page 24.
- **Sensor Fault** - When the Sensor Fault is set to All Off in the startup menu (see page 16), the System sensor fault (in all Sensor Type modes) or the Outdoor sensor fault (in Reset mode) will de-energize all stage relays. Check the display for sensor values.
- **System or Outdoor Sensor** - If the System or Outdoor sensor reading was higher than the actual temperature, the BMC might not bring any stage on. Check "Display shows an Incorrect Temperature" section.

#### Too Much Heat

Check if the control has any of the following:

- **Domestic Hot Water call** - The BMC will raise the temperature of the system to either 200°F or Maximum Water Temperature on a DHW call, connected to terminals 29 and 30. Check to see if there is a call for DHW and the length of time it lasts.
- **Reset Ratio and Offset** - If excessive heat occurs only in certain weather conditions, adjust the Reset Ratio and Offset (See Understanding Operating Concept on page 5). If excessive heat occurs year round, reduce the Offset.
- **Boiler Mode Settings** - The BMC will only modulate boilers their mode is set to Auto or Standby. Check to if any boiler stage is set to Manual or On. See Mode on page 25.
- **Control Settings** - The Last Stage Hold will allow only the Lead boiler to stay on for an additional number of degrees. If the setting is too high, and only the Lead boiler is on, the system can over heat. Reduce the Last Stage Hold setting. See page 21.

#### Too Little Heat

Check if the control has any of the following:

- **Reset Ratio and Offset** - If reduced heat occurs only in certain weather conditions, adjust the Reset Ratio and Offset (See Understanding Operating Concept on page 5). If reduced heat occurs year round, increase the Offset.
- **Setback and Day/Night Schedule** - If reduced heat occurs only during specific hours, check the Day/Night Schedule and the Setback values. Either reduce the Setback setting (See page 20).

# BMC and BMC-6X Installation and Operation Manual

---

- **Boiler Mode Settings** - The BMC will only modulate boilers their mode is set to Auto or Standby. Check if any boiler stage is set to Manual, Off, or Standby. See Mode on page 25.

## **Boilers are Short-Cycling**

- **Lag Delay** - Increase the Lag Delay only if all boilers tend to short-cycle.
- **Last Stage Hold** - Increase the Last Stage Hold only if the lead boiler tends to short-cycle.

## **System is Overshooting or Undershooting**

- **Gain** - If the system is overshooting reduce the Gain.
- **Gain** - If the system is undershooting increase the Gain.

# MULTIPLE MODULATING BOILERS DIRECT HEATING PIPING DIAGRAM

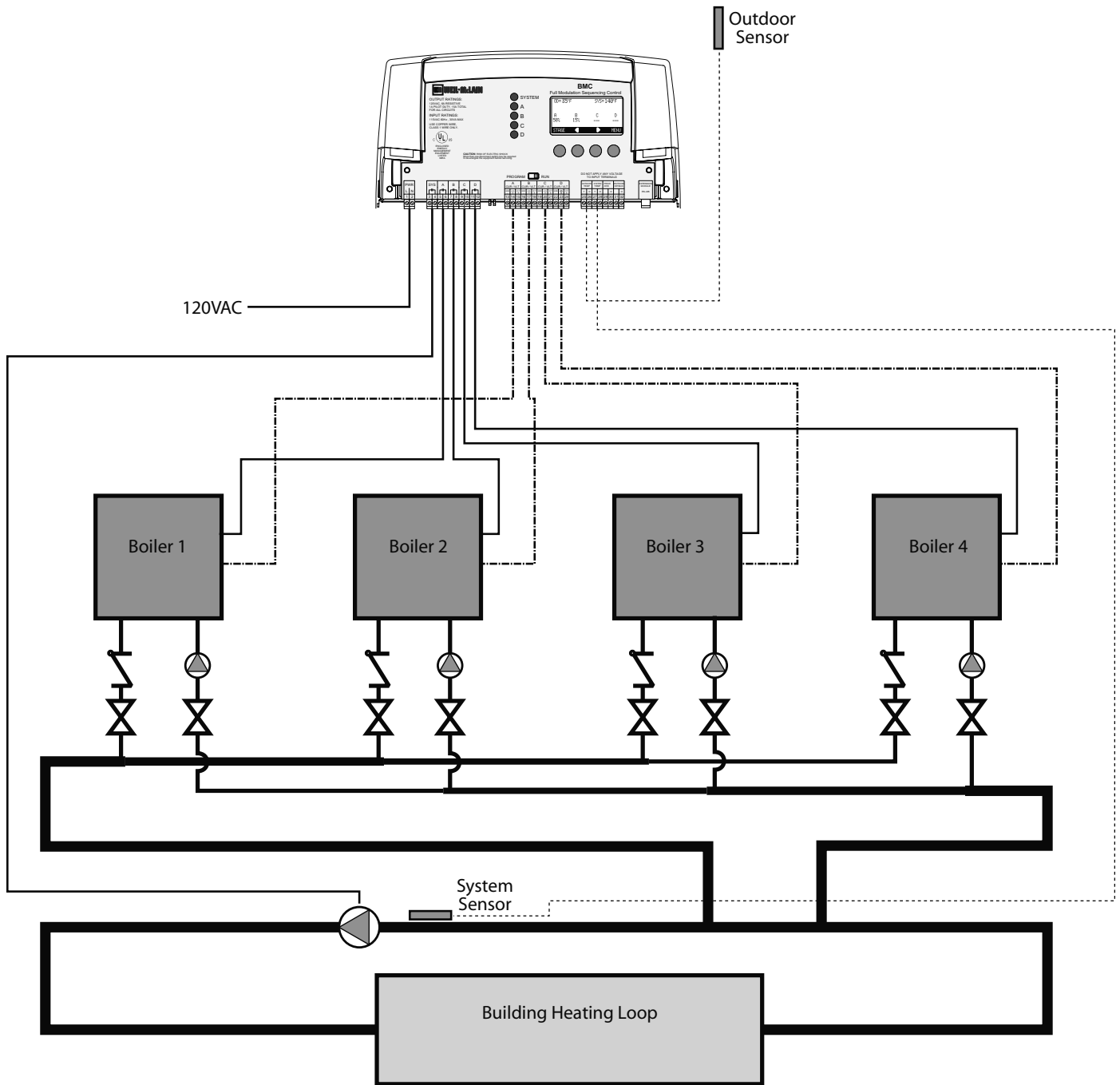

**System:**

The BMC provides 4 modulating boilers. The boilers are piped in Reverse Return on the primary loop. The System output is controlling the System Pump.

Weil McLain is aware that each installation is unique. Thus, Weil McLain is not responsible for any installation related to any electrical or plumbing diagram generated by Weil McLain. The provided illustrations are to demonstrate Weil McLain's control operating concept only.

# MULTIPLE MODULATING BOILERS DIRECT HEATING WIRING DIAGRAM

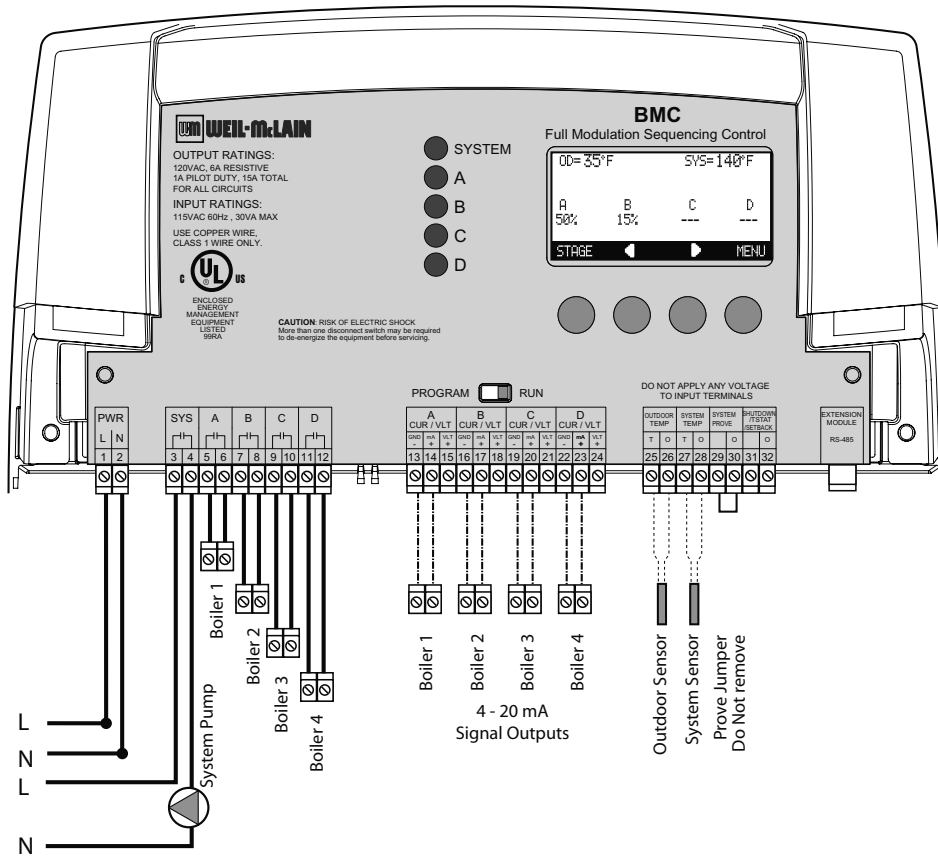

4-20mA Modulating  
Outputs

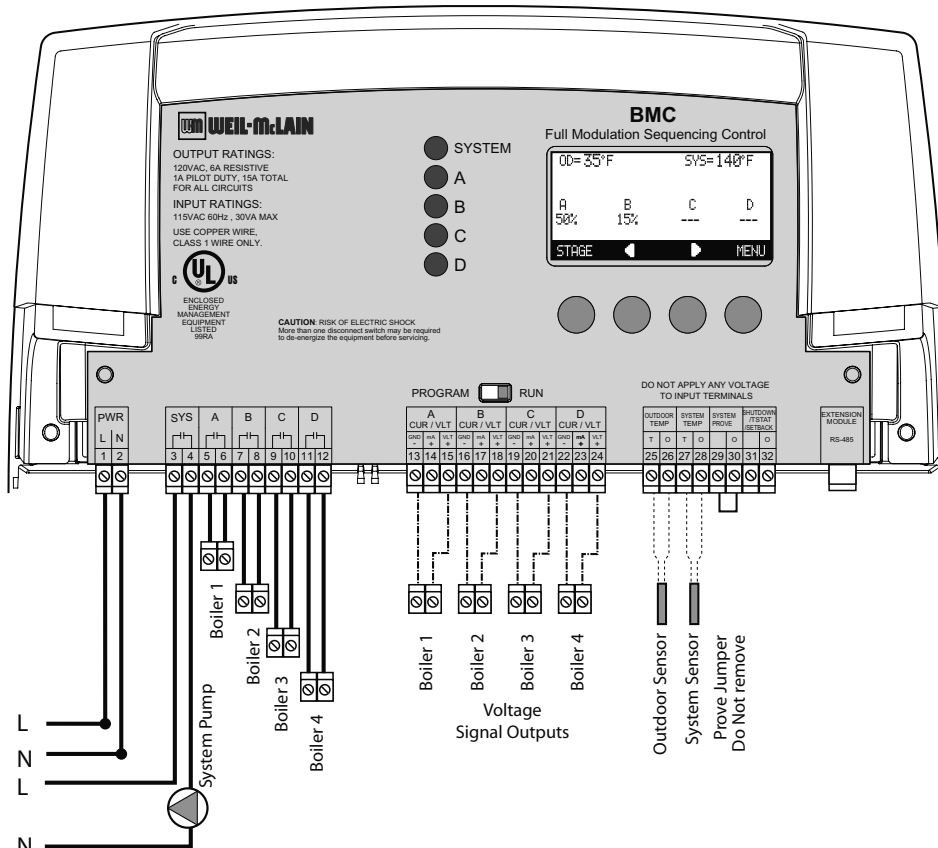

Voltage Modulating  
Outputs

# MULTIPLE MODULATING BOILERS EXTERNAL 4-20MA SET POINT USING 4-20MA EMS INTERFACE

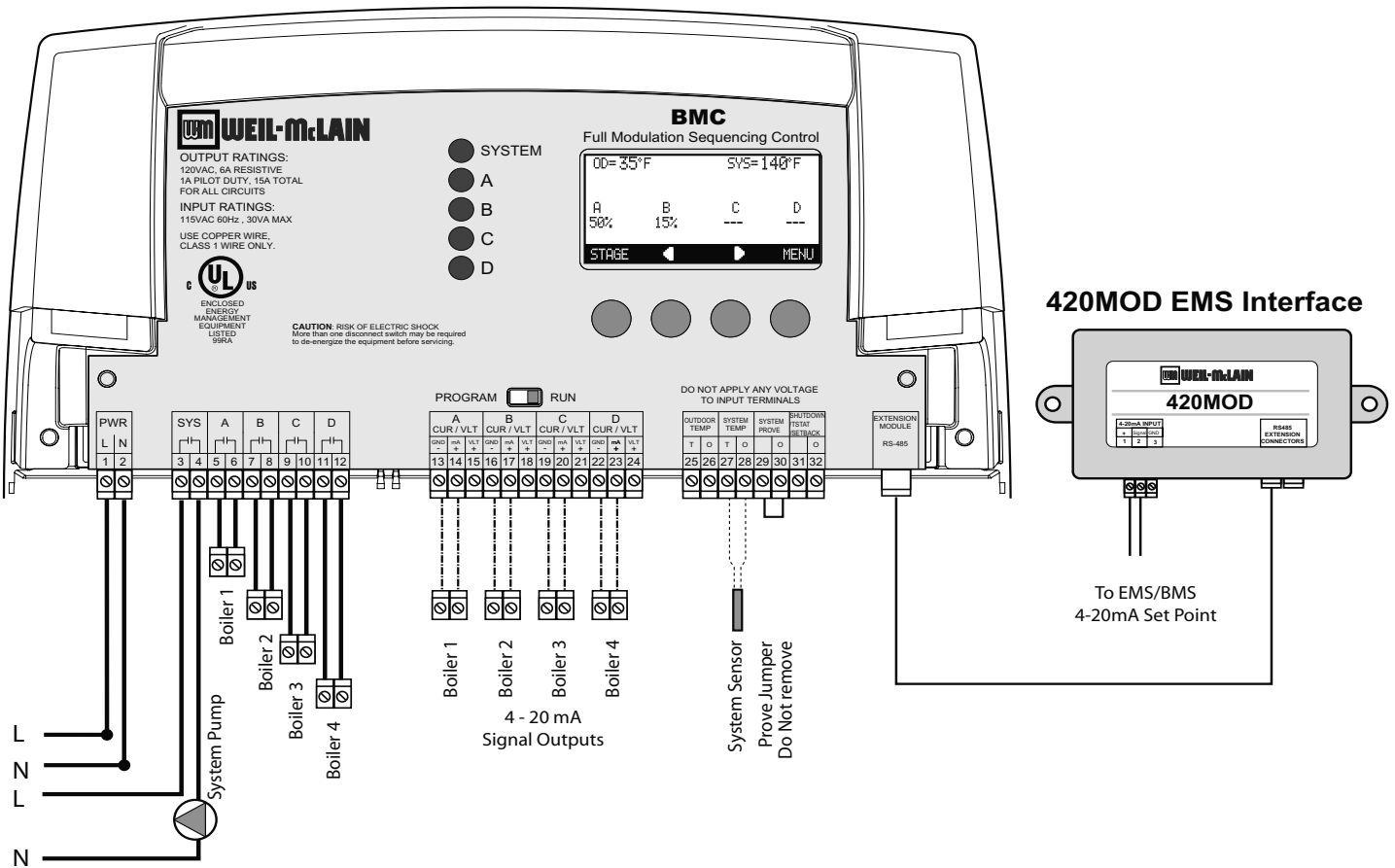

# SPECIFICATIONS

<b>Voltage Input:</b>	120 VAC 60 Hz
<b>Power Consumption:</b>	12 VA Max
<b>Operating Temperature:</b>	20°F/-7°C to 120°F/49°C
<b>Operating Humidity:</b>	20% to 80%
<b>Dimensions:</b>	11"W x 9" H x 3 3/4" D
<b>Weight:</b>	2.5 pounds

## BMC SPECIFICATIONS

<b>Lead Stage Rotation:</b>	Time ( 1 to 1440 Hours (60 days)), Manual, Last-On
<b>Pump Output:</b>	(1) N.O. S.P.S.T
<b>Boiler Modes:</b>	Auto, Manual (0% - 100%), Standby, On, Off
<b>Standby Time:</b>	1 to 60 minutes
<b>Modulating Output Types:</b>	Total of four outputs. Can be either Current (4-20mA) or VDC (0-5V, 0-10V, 1-5V, 2-10V)
<b>Output Relay Ratings:</b>	(5) 1 Amp inductive (1/8HP), 6Amp resistive at 120 VAC 60 Hz, 15A total for all circuits
<b>Add-On BMC-6X Panels:</b>	up to two BMC-6X Panels using RS485
<b>Ignition Point %:</b>	1 to 50%
<b>Modulation Start Point %:</b>	0 to 100%
<b>Modulation Modes:</b>	Normal or Parallel
<b>Temperature Display:</b>	Fahrenheit or Celsius.
<b>Display:</b>	Graphical Alphanumeric (7 rows x 21 char. each)
<b>LED:</b>	(1) System Output relay, (4) Boiler Output relays
<b>Sensor Ranges:</b>	Outdoor temperature sensor -35°F/-37°C to 250°F/121°C Heating system sensor -35°F/-37°C to 250°F/121°C
<b>Outdoor Cutoff Range:</b>	20°F/-7°C to 100°F/38°C, ON and OFF
<b>Reset Ratio Range:</b>	(1.00 : 4.00) to (4.00 : 1.00) (Outdoor : System Water)
<b>Offset Adjustment:</b>	-40F°/-22C° to + 40F°/+22C
<b>Minimum Water Temperature:</b>	70°F/21°C to 170°F/77°C
<b>Maximum Water Temperature (Reset Only):</b>	90°F/32°C to 240°F/116°C
<b>Set Point Temperature Range:</b>	70°F/21°C to 250°F/121°C
<b>EMS Temperature Range:</b>	70°F/21°C to 240°F/116°C
<b>Domestic Hot Water:</b>	with Priority or without Priority
<b>Pump Run-On:</b>	0 to 360 minutes
<b>Purge Delay:</b>	0.0 to 10.0 minutes
<b>Lag Delay:</b>	0 to 60 minutes
<b>Last Stage Hold:</b>	0F°/0°C to 30F°/17C°
<b>Schedules:</b>	(1) Day and (1) Night (Setback) settings per day (Require Shutdown or Tstat mode)
<b>Night Setback:</b>	0F°/0C° to 75F°/42C°
<b>Power Backup:</b>	Lithium coin battery, 100 days minimum 5 year replacement (Maintains Clock in power outages).
<b>External Inputs:</b>	Tstat Input/Shutdown Input/Setback Input, and Prove Input/DHW Input (Dry Contacts Only)
<b>Season:</b>	Winter and Summer.

## BMC-6X SPECIFICATIONS

(Each BMC-6X can add up to (6) additional modulating boilers. A maximum of two BMC-6Xs can be added to a single BMC.)

<b>Extension Numbering:</b>	Toggle Switch A or B
<b>Boiler Outputs:</b>	(6) N.O. S.P.S.T.
<b>Modulating Output Types:</b>	(6) 4-20mA, 0-5V, 0-10V, 1-5V, 2-10V
<b>Output Relay Ratings:</b>	1 Amp inductive (1/8HP), 6Amp resistive at 120 VAC 60 Hz, 15A total for all circuits
<b>Connection to BMC and another extension:</b>	Two RS485 connections using 6 wire phone cable (Cable is provided)

