



**30" Self-Cleaning
Electric Free-Standing Range
Use & Care Guide**

**Estufa Eléctrica
30" Tipo "Independiente"
con Autolimpieza**

Guía para el Uso y Cuidado

Models, Modelos 911.93501, 93508, 93581, 93582, 93587,
93588, 93601, 93602, 93607, 93608

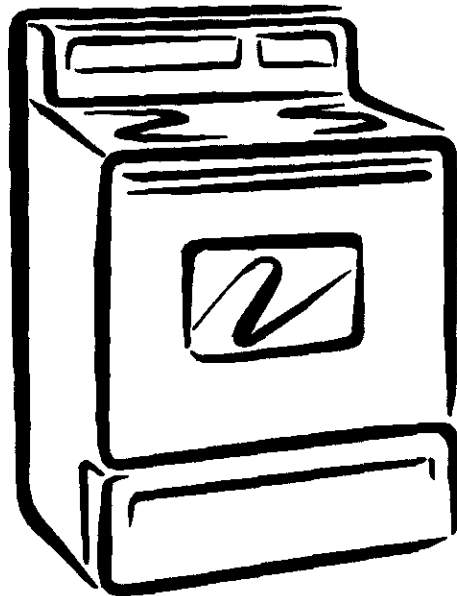

**ENGLISH
ESPAÑOL**

229C4020P183-6
(SR-10452)

Sears, Roebuck and Co.,
Hoffman Estates, IL 60179 U.S.A. www.sears.com

SELF-CLEANING FREE-STANDING RANGE

Table of Contents

SAFETY INSTRUCTIONS

Range Safety 3-7
Anti-Tip Bracket 3-4

OPERATION

Features of Your Range 8
Removal of Packaging Tape 8
Cooking Elements 9
Control Settings 9
Home Canning Tips 9
Hour/Minute Arrow Pad 10
Temp Recall 10
Display 10
Oven Light Switch 10
Indicator Lights 10
Black Out The Display 10
F-Codes 11
PF Code 11
Automatic Oven Shutoff 11
To Set The Clock 12
To Set The Timer 12
To Reset The Timer 12
To Cancel The Timer 12
Baking 13-14
Oven Cooking Tips 15-17
Strong Smell or Odor 15
Aluminum Foil 15
Oven Vent 15
Peeking 15
Preheating 15
Oven Light 15
Baking With Margarine 15
Bakeware Placement 16
Bakeware 16
Element Cycling 16

Oven Racks 17
Oven Control 17
Broiling 18-19

CARE AND CLEANING

Self-Cleaning Cycle 20-21
Preparing Your Oven 20
Oven Door Gasket 20
To Set A Clean Cycle 21
To Set A Delayed Cycle 21
To Stop A Cycle 21
After The Cycle 21
Control Panel 22
Broiler Pan and Grid 22
Walls Of The Oven 22
Cooktop and Area Under
Cooktop 22
Drawer and Sides of Range ... 22
Oven Door Glass 22
Door Vent Trim 22
Removable Parts 23-28
Lift-Up Cooktop 23
Control Knobs 24
Oven Light Bulb 24
Cooktop Units 25
Oven Racks 26
Oven Door 26-27
Storage Drawer 28

PROBLEM SOLVING

Before Calling for
Service 29-31
Temperature Adjustment 17, 32
Warranty 34
Consumer Service Numbers ... 68

For your convenience and future reference, please write down your model and serial numbers in the space provided. They are located on the front frame behind the storage drawer.

MODEL NUMBER:

SERIAL NUMBER:

© Sears, Roebuck and Co.

IMPORTANT SAFETY INSTRUCTIONS

SAVE THESE INSTRUCTIONS

Read all instructions before using this appliance. When using gas or electrical appliances, basic safety precautions should be followed, including the following:

ANTI-TIP BRACKET

WARNING

- All Ranges Can Tip
- Injury to Persons Could Result
- Install Anti-Tip Device Packed With Range
- See Installation Instructions

These ANTI-TIP bracket installation instructions are for wood or concrete floors and walls. Any other type of construction may require special installation techniques to provide adequate fastening of the ANTI-TIP bracket to the floor and wall.

The use of this bracket does not prevent tipping of the range when bracket is not properly installed.

NOTE: The installation of the ANTI-TIP bracket must meet all local codes for securing appliance.

Step 1

Locating the bracket

A. Locate the bracket against the rear wall and either the right or left cabinet. If the countertop overhangs the cabinet, offset the bracket from the cabinet by the amount of overhang. If there is no adjacent cabinet, position the edge of the bracket at the desired location of the range side panel.

B. Use the bracket as a template and mark 2 hole positions on the wall and 2 hole positions on the floor. Use either the wood or concrete floor set of positions, depending on your floor type. See Fig. 1.

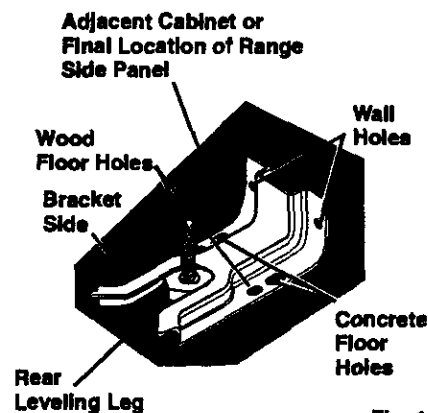

Fig. 1

continued on next page

IMPORTANT SAFETY INSTRUCTIONS

Anti-Tip Bracket (contd.)

Step 2

Anti-tip bracket installation

A. Wood Construction:

1. **Floor:** Drill a $\frac{1}{8}$ " pilot hole in the center of each pre-marked wood floor hole position (a nail or awl may be used if a drill is not available),

AND

2. **Wall:** Drill an angled $\frac{1}{8}$ " pilot hole (as shown in Fig. 2) in the center of each pre-marked wall hole position (a nail or awl may be used if a drill is not available).

ATTACHMENT TO WALL AND FLOOR

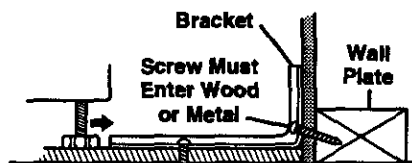

Fig. 2

- B. Mount the **ANTI-TIP** bracket with the 4 screws provided as illustrated in Fig. 2.

C. Concrete Construction:

1. Hardware required:

- 4 each $\frac{1}{4}$ " x $1\frac{1}{2}$ " lag bolt
- 4 each $\frac{1}{2}$ " O.D. sleeve anchor

2. Drill the recommended size hole for the anchors into the concrete at the center of each pre-marked concrete floor and wall hole position. Install the sleeve anchor into the drilled holes and then install the lag bolts through the bracket. **DO NOT OVERTIGHTEN THE BOLTS.**

Step 3

Checking the installation

- A. Complete the installation of the range per the installation instructions provided with it.
- B. Check if the **ANTI-TIP** bracket is installed and engaged properly. Remove the kick panel or storage drawer and inspect the **REAR LEVELING LEG**. Make sure it fits securely into the slot. See Fig. 1.

IMPORTANT SAFETY INSTRUCTIONS



WARNING!

To prevent accidental tipping of the range from abnormal use, including excessive loading of the oven door, attach the range to the wall or floor by installing the Anti-Tip device supplied. If the range is moved for cleaning, servicing or any reason, be sure the Anti-Tip device is re-engaged properly when the range is slid back in the opening. Failure to do so could result in the range tipping and may cause personal injury. To inspect the Anti-Tip device, remove the storage drawer and look to see if the rear leg leveler fully engages the slot in the bracket.

Important: To ensure safety for yourself, family, and home, please read your Owner's Manual carefully. Keep it handy for reference. Pay close attention to Safety Sections. **BE SURE** your appliance is installed and grounded by a qualified technician.

IMPORTANT SAFETY NOTICE!

The California Safe Drinking Water and Toxic Enforcement Act requires the governor of California to publish a list of substances known to the state to cause birth defects or other reproductive harm and requires businesses to warn their customers of potential exposure to such substances. The fiberglass insulation in a self-cleaning oven will give off a very small amount of carbon monoxide during the cleaning cycle. Exposure can be minimized by venting with an open door or window or using a ventilation fan or hood.

IMPORTANT: The health of some birds is extremely sensitive to the fumes given off during the self-cleaning cycle of any range. Move birds to another well-ventilated room.

- **DO NOT** leave children alone or unattended near an appliance in use.
- **TEACH CHILDREN** not to play with controls or any part of the appliance and not to sit, climb, or stand on the door or any other parts of the appliance.
- **CAUTION: NEVER STORE** items of interest to children on the backguard or in cabinets above the appliance. Children climbing on the appliance could be seriously injured.
- **KEEP THIS** book for later use.
- **NEVER TRY** to repair or replace any part of the appliance unless instructions are given in this manual. All other work should be done by a qualified technician.
- **NEVER USE** your appliance for warming or heating the room.

IMPORTANT SAFETY INSTRUCTIONS

- **ALWAYS KEEP** combustible wall coverings, curtains, dishcloths, towels, potholders and other linens a safe distance from the appliance.
- **NEVER HEAT** unopened food containers. Pressure buildup can cause the container to burst and cause injury.
- **NEVER LEAVE** containers of fat or drippings in your oven.
- **ALWAYS KEEP** the oven and surface unit areas free from things that will burn. Food, wooden utensils, and grease buildup could catch fire. Plastic utensils could melt and canned foods could explode. Your appliance should never be used as a storage area.
- **ALWAYS KEEP** your appliance clear of things that will burn (gasoline and other flammable vapors or liquids).
- **NEVER TRY** to clean hot surfaces. Some cleaners produce noxious fumes, and wet cloths or sponges could cause steam burns.
- **NEVER WEAR** loose-fitting clothing when using your appliance.
- **NEVER USE** a towel or other bulky cloth as a potholder. Make sure the potholder is dry. Moist potholders and wet cloths or sponges could cause steam burns. **DO NOT** let potholders touch hot heating elements.
- **DO NOT** touch heating elements, surfaces near them, or interior oven surfaces. These may be hot enough to cause burns even though they are dark in color. During and after use, do not touch or let clothing or flammable material contact the elements or hot surfaces until they have had time to cool. Other

surfaces near the oven vent openings, oven door and window and cooktop surfaces may also be hot enough to cause burns.

COOKTOP SAFETY

- **ONLY CERTAIN** kinds of glass or ceramic cookware can be used for cooktop cooking. Make sure the cookware you choose to use is designed for cooktop cooking without breaking due to the sudden temperature changes.
- **ALWAYS USE** care when touching cooktop elements. They will retain heat after the range has been turned off.
- **NEVER BLOCK** the oven air vent under the right rear element.
- **COOKWARE USED** for cooktop cooking should be flat on the bottom and large enough to cover the heating area being used. Undersized utensils expose the heating element and may result in direct contact or ignition of clothing. The proper size utensil will also improve efficiency.
- **ALWAYS USE** drip bowls to prevent wiring and component damage. **DO NOT** use aluminum liners or foil in drip bowls. Improper use may result in risk of electric shock or fire.
- **NEVER LEAVE** surface units unattended at high settings. Boilovers result in smoking or greasy spills which could catch fire.
- **ALWAYS TURN** utensil handles inward and away from other surface units to reduce the risk of burns, ignition, unintended contact, and spillage.
- **NEVER** put heating elements in water.
- **WHEN PREPARING** flaming foods under the vent hood, turn the fan on.

IMPORTANT SAFETY INSTRUCTIONS

OVEN SAFETY

- **PLACE OVEN RACKS** in the desired position while the oven is cool. If racks must be moved while oven is hot, do not let potholder contact the hot oven element.
- **AFTER BROILING**, always take the broiler pan and grid out of the oven and clean them. Leftover grease in the broiler pan could catch fire the next time you use your oven.
- **ALWAYS USE** care when opening the oven door. Let hot air and steam escape before moving foods.
- **NEVER USE** aluminum foil to line the oven bottom. Improper use of foil could start a fire, or electrical shock could result.

SELF-CLEAN SAFETY

- **CLEAN ONLY** the parts listed in this manual. Follow all cleaning instructions. Be sure to remove the broiler pan and grid before the self-clean cycle.
- **NEVER RUB**, move, clean, or damage the door gasket on self-cleaning ranges. It is essential for a good seal.
- **NEVER TRY** to clean utensils, cookware, removable parts, or broiler pan and grid in the self-clean cycle.
- **DO NOT USE** oven cleaners – No commercial oven cleaner or protective coating of any kind should be used in or around any part of the oven.

- **IF THE SELF-CLEANING** mode malfunctions, turn the oven off and disconnect the power supply. Have it serviced by a qualified technician.



CAUTION:

Never line the drip bowls with aluminum foil. Foil can block the normal heat flow and damage the range.

Always use cookware and woks that are flat on the bottom and the same size as the cooking element being used.

Cookware should not extend more than 1" beyond the edge of the cooking element.

READ AND UNDERSTAND THIS INFORMATION NOW!

Be sure everyone in your home knows what to do in case of fire. Never use water on a grease fire; it will only spread the flames.

COOKTOP GREASE FIRE:

Never pick up a flaming pan...

1. Turn off the surface elements.
2. Smother the flame with a tightly fitting lid, use baking soda, or use a dry chemical, foam or halon-type extinguisher.

Do not try to move the pan!

1. Close the oven door and turn controls off.
2. If fire continues, carefully open the door, throw baking soda on the fire, or use a dry chemical, foam, or halon-type extinguisher.

OPERATION

FEATURES OF YOUR RANGE

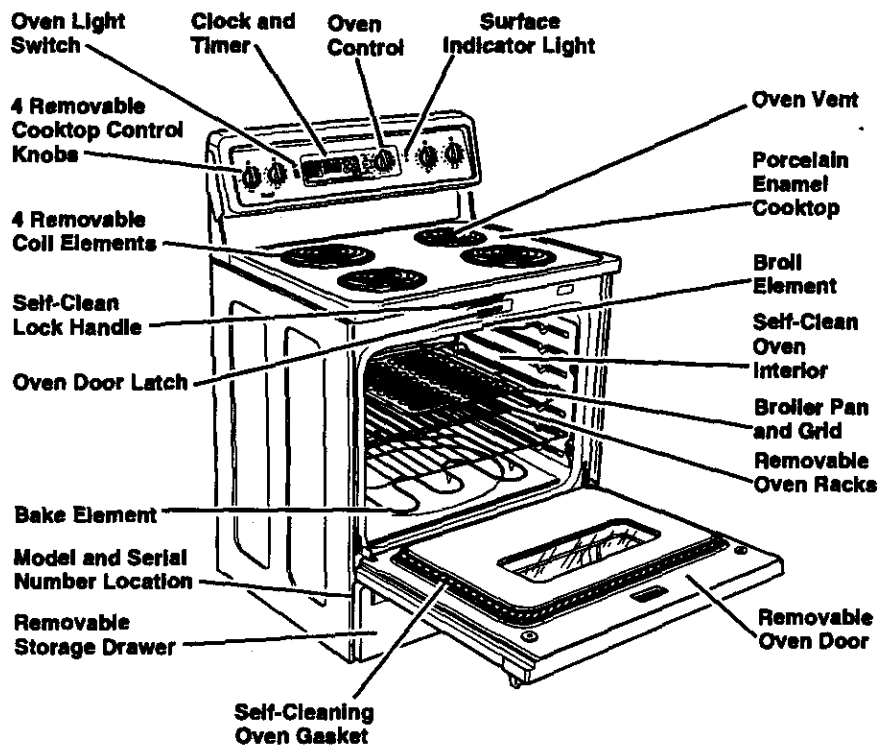

REMOVAL OF PACKAGING TAPE

To remove the adhesive residue left from packaging tape, use household dishwashing liquid, mineral oil, or cooking oil. With a soft cloth, rub into the area and allow to soak. Rinse and dry well. Repeat procedure using an appliance polish to insure no damage is done to the oven. **This should be done before the range is turned on for the first time. The tape cannot be removed once the oven has heated.** Packaging tape can be found in the following areas: Cooktop Surface, Control Panel Area, Door Handle, Oven Area, and Door Trim.

OPERATION

Cooktop Cooking

COOKING ELEMENTS

The sign below each control knob shows you which element is turned on by that knob.

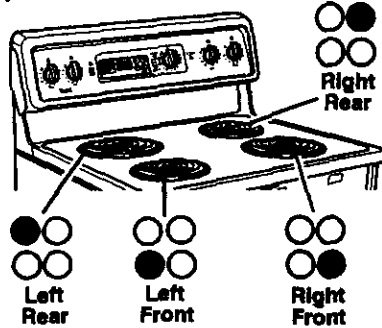

CONTROL SETTINGS

- HI** For quick starts, such as bringing water to a boil.
- MED** For slow boiling and sautéing.
- LO** For steaming foods or keeping cooked foods at serving temperature.

1. Push in to turn the knob.

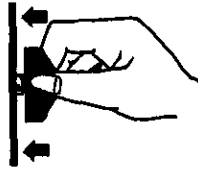

2. Set on or between marks for desired heat.



The surface unit indicator light will glow when any cooking element is activated.

HOME CANNING TIPS

1. Center canner over the element.
2. Make sure the canner is flat on the bottom.
3. Use recipes and procedures from reputable sources. These are available from manufacturers such as Ball® and Kerr® and the Department of Agriculture Extension Service.
4. Use caution, while canning, to prevent burns from steam or heat.

OPERATION

Oven Control, Clock, and Timer

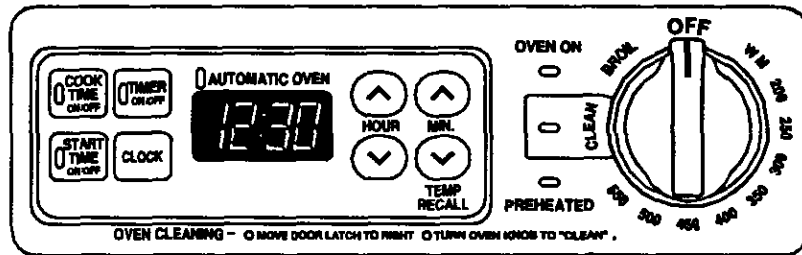

Your range **CLOCK**, **TIMER**, and **OVEN** operations are simple and easy to understand

THE HOUR/MINUTE ARROW PAD

The **HOUR/MINUTE** arrow pads allow you to set the exact time you need

TEMP RECALL

Touch the **DOWN** arrow pad to display the selected oven temperature

DISPLAY

The display will show

1. The time of day **CLOCK**
2. The amount of time you choose when using the **TIMER**
3. Any delayed functions or cooking times set

OVEN LIGHT SWITCH

The oven light switch turns the light inside the oven on or off

INDICATOR LIGHTS

As you read through your manual, you will find what each of the individual indicators are used for and how they will help you in understanding your new control

TO BLACK OUT THE DISPLAY

If the time of day is showing in the display, touch the **CLOCK** pad once
To bring back the display from the time of day blackout, touch the **CLOCK** pad twice.

OPERATION

Oven Control, Clock, and Timer (cont.)

F-CODES

If the display flashes an "F" followed by a number and beeps continuously, you have a function error code. Note the number after the "F." Turn the oven control knob to the **OFF** position. Disconnect all power to the range for at least 30 seconds and retry the oven operation. If the "F" displays during a self-clean cycle, check the oven door latch. Make sure the latch is moved to the right as far as it will go. Turn the **OVEN CONTROL KNOB** to the **OFF** position. Allow the oven to cool 1 hour and retry the oven operation. If the problem repeats, call for service. Advise the technician what the flashing code was.

PF CODE

When the power to your range is turned on for the first time, or if you experience a power failure, the display will flash "PF." By touching the **CLOCK** pad, the display will flash "12:00." Touch the **CLOCK** pad again and follow the instructions to set the clock. Any operation set before a power failure will need to be reset.

AUTOMATIC OVEN SHUTOFF

The oven will automatically shut off if it has been left on for more than 12 hours.



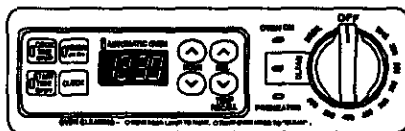

To deactivate or reactivate the automatic shutoff, touch and hold the **MIN UP** and **DOWN** arrow pads for about 4 seconds.

OPERATION

Clock and Timer





TO SET THE CLOCK

-  1. Touch the **CLOCK** pad until display flashes.
- 
 2. Touch the **HOUR/MIN UP** or **DOWN** arrow pads to set the time of day.
-  3. Touch the **CLOCK** pad.

TO SET THE TIMER

The Timer is used to time cooking processes or other household activities. It does not control the oven. It can be set for up to 11 hours and 59 minutes. It will count down in minutes until the **LAST 60 SECONDS** is reached, then the control will beep once. When the countdown reaches **ZERO**, the control will beep 3 times followed by one beep every 6 seconds until the **TIMER ON/OFF** pad is touched.

-  1. Touch the **TIMER ON/OFF** pad. "0:00" and the **TIMER** indicator light will flash.
- 
 2. Touch the **HOUR/MIN UP** or **DOWN** arrow pads to set the amount of time.

After releasing the arrow pad, the **TIMER** indicator light will blink three to five times. The countdown will automatically begin. The **TIMER** indicator light will remain on until the countdown reaches "0."

When the timer has started the countdown, you may touch the **CLOCK** pad to return to the current time of day.

At the end of the countdown, the control will beep and the **TIMER** indicator light will flash. Touch the **TIMER ON/OFF** pad.

REMINDER!

If you hesitate while touching the arrow pads, the display and the TIMER indicator lights will blink 3 times and return the display to the time-of-day clock. If this happens, touch the TIMER ON/OFF pad to start over.

TO RESET THE TIMER

If you decide to change your set time:

If the countdown is showing in the display, touch the **HOUR/MIN UP** or **DOWN** arrow pads. Select the new time.

If the time-of-day clock is showing in the display, touch the **TIMER ON/OFF** pad. Then, touch the **HOUR/MIN UP** or **DOWN** arrow pads. Select the new time.

TO CANCEL THE TIMER

If the countdown is showing in the display, simply change the time. If it isn't, touch the **TIMER ON/OFF** pad, then touch the **TIMER ON/OFF** pad to cancel.

OPERATION

Baking

TO SET BAKE

1. Set the **OVEN CONTROL KNOB** to the temperature you want to use when baking. The **OVEN ON** indicator light will glow.

When the temperature inside the oven reaches your selected temperature, the preheat tone will sound and the **PREHEATED** indicator light will glow.

2. When baking is finished, turn the **OVEN CONTROL KNOB** to the **OFF** position.

BAKING SHELF POSITION CHART

TYPE OF FOOD	SHELF POSITION
Frozen pies (on cookie sheet)	4
Angel food cake, bundt or pound cakes	3 or 4
Biscuits, muffins, brownies, cookies, cupcakes, layer cakes, pies	3 or 4
Casseroles	3 or 4
Turkey or Roast	1

TO SET A COOK TIME

The oven will turn on immediately and cook for a selected length of time. At the end of the cooking time, the oven will turn off automatically.

1. Make sure the correct time of day is showing in the display.
2. Touch the **COOK TIME ON/OFF** pad.
3. Touch the **HOUR/MIN UP** and/or **DOWN** arrow pads, to set how long you want foods to cook.
4. Turn the **OVEN CONTROL KNOB** to the baking temperature you want to use.

The **OVEN ON** and **AUTOMATIC OVEN** indicator lights will glow. When the temperature inside the oven reaches the temperature you have selected, the **PREHEATED** indicator light will glow.

5. When the set amount of cooktime has reached zero, a tone will sound and the **AUTOMATIC OVEN** indicator light will blink until the **OVEN CONTROL KNOB** is turned to the **OFF** position.

OPERATION **Baking (cont.)**

TO SET A DELAYED START

You can set the oven control to delay start the oven, cook for a specific length of time, and then turn off automatically.

1. Make sure the correct time of day is showing in the display.
2. Touch the **COOK TIME ON/OFF** pad.
3. Touch the **HOURL/MIN UP** and/or **DOWN** arrow pads, to set how long you want foods to cook.
4. Touch the **START TIME ON/OFF** pad.
5. Touch the **HOURL/MIN UP** and/or **DOWN** arrow pads to set the time of day you want the oven to turn on.
6. Turn the **OVEN CONTROL KNOB** to the baking temperature you want to use.
The **OVEN ON** and **AUTOMATIC OVEN** indicator lights will glow.
7. When the start time is reached, the oven will automatically turn on and start cooking. When the temperature inside the oven reaches the temperature you have selected, the **PREHEATED** indicator light will glow. The set amount of cooktime will count down to zero, a tone will sound, and the **AUTOMATIC OVEN** indicator light will blink until the oven control knob is turned to the **OFF** position.

NOTE: After touching the **COOK TIME** or **START TIME** pads, if you hesitate before touching the **HOURL/MIN** pads, the display will blink 3 times and return to the time of day. If this happens, repeat the operation to continue.

OPERATION

Oven Cooking Tips

STRONG SMELL OR ODOR

It is normal to have some odor when using your oven for the first time. To help eliminate this odor, **ventilate the room by opening a window or using a vent hood.**

ALUMINUM FOIL

IMPORTANT: Never cover the oven bottom or oven rack with aluminum foil. Improper use can cause poor heat flow, poor baking results, and may damage the oven finish. To prevent staining from spillovers, you may place a piece of aluminum foil or a cookie sheet on the rack below the food which may spill over.



OVEN VENT

The oven vent is located under the right rear element. This area could become hot during oven use. It is normal for steam to come out of the vent and/or collect moisture underneath when the oven is in use. The vent is important for proper air circulation. **Never block this vent.**



PEEKING

Opening the door often to check foods will cause heat loss and poor baking results.

PREHEATING

Preheating is bringing the oven temperature up to the temperature you will be using during baking. Let the oven preheat when recipes call for preheating.

OVEN LIGHT

To prolong the life of your oven light bulb, follow this helpful tip: Always turn the light off when the oven is not in use or during a clean cycle. If your oven light is left on for an extended period of time, the oven will be warm when the door is opened due to the heat generated from the oven light bulb.

THE TYPE OF MARGARINE AFFECTS BAKING PERFORMANCE

Most recipes for baking have been developed using high-fat products such as butter or margarine (80% fat by weight—the federal requirement for products labeled “margarine”). You will get poor results if cakes, pies, pastries, cookies, or candies are made with low-fat spreads. Low-fat spreads contain less fat and more water. The high moisture content of these spreads affects the texture and flavor of favorite baked recipes. The lower the fat content of a spread product, the more noticeable these differences become. To ensure best results, use margarine, butter, or stick spreads containing at least 70% vegetable oil.

OPERATION **Oven Cooking Tips (cont.)**

BAKEWARE PLACEMENT

Baking results will be better if baking pans are centered in the oven as much as possible. If baking with more than one pan, place the pans so each has at least 1 to 1½" of air space around it. If baking four cake layers at the same time, place two layers on rack 2 and two layers on rack 4. Stagger pans on the rack so one is not directly above the other.

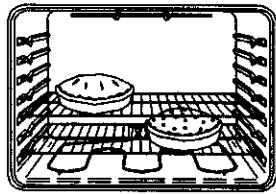

BAKEWARE

FLAT COOKIE SHEETS, without sides, allow air to circulate all around the cookies for even browning.

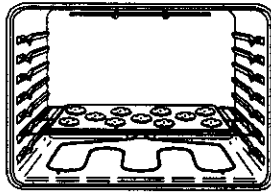

SHINY PANS reflect heat and are perfect for cakes and quick breads that need a light brown crust.

GLASS, DARK NON-STICK, OR DARKENED-BY-AGE BAKEWARE absorbs heat and can be used for yeast breads, pie crust, or foods that need a brown crust. The oven temperature should be reduced by 25°F.

ELEMENT CYCLING

The Oven Temperature Sensor continuously senses and controls the temperature inside the oven. To keep a constant set temperature, the elements will cycle (turn on and off during cooking).

OPERATION Oven Cooking Tips (cont.)

OVEN RACKS

The oven racks are designed with stops, a convenience as well as a safety precaution. The guides have a bump to prevent the racks from tilting when they are pulled out of the oven. This design allows the racks to be inserted in only one way.



Your oven has six (6) rack positions. The top position is only a guide. It cannot be used as a rack position.

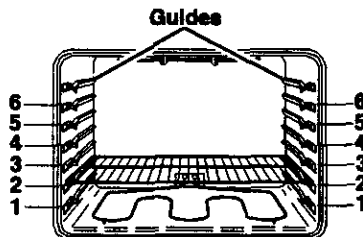

Always place oven racks in the proper position while oven is cool.

CAUTION: When you are using the rack in the lowest position (1), you will need to use caution when pulling the rack out. We recommend that you pull the rack out several inches and then, using two potholders, pull the rack out by holding the sides of it. The rack is low and you could be burned if you place your hand in the middle of the rack and pull all the way out. Be very careful not to burn your hand on the door when using a rack in the lowest position (1).

OVEN TEMPERATURE ADJUSTMENT

You may feel that your new oven cooks differently than the oven it replaced. We recommend that you use your new oven a few weeks to become more familiar with it, following the times given in your recipes as a guide. If you feel your oven is too hot or too cool for your cooking preference, see Do-It-Yourself Adjustment in the back of this manual to make the adjustment.

OVEN CONTROL

NOTE: On some models the Oven Control Knob must be pushed in before turning.

Your oven control has a selector knob for setting Bake, Broil, or Clean. Simply turn the knob to the bake temperature setting you want to use or to **BROIL** or **CLEAN**.

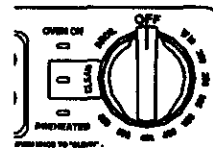

The Indicator Lights:

- **PREHEATED** indicator light – turns on and stays on when oven has reached selected temperature.
- **OVEN ON** indicator light – turns on and stays on when a Bake, Broil, or Clean function has been chosen.
- **CLEAN** indicator light – turns on and stays on for self-clean. If the **CLEAN** indicator light flashes, you should check for one of the following:
 1. The latch handle is locked during a baking function.
 2. The latch handle is not locked during a self-clean function.

OPERATION

Broiling

GENERAL RULES

Broiling is cooking by direct heat from the upper element. The oven door should remain opened to the broil stop position during broiling.

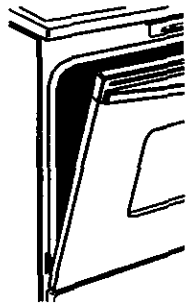

It is not necessary to preheat the oven when broiling. Use the broiler pan and grid that came with your range. Both are designed for proper drainage of fat and liquids.



If foil is used, it must be molded tightly to the grid and slits cut into the foil to match those of the grid. This allows fats and liquids to drain into the broiler pan, preventing fire and excessive smoke.

Always remove the pan and grid from the oven. Storing or forgetting a soiled broiler pan in the oven is a potential smoke or fire hazard.



The U.S. Department of Agriculture recommends to cook meat and poultry thoroughly—meat to at least an INTERNAL temperature of 160°F and poultry to at least an INTERNAL temperature of 180°F. Cooking to these temperatures usually protects against food-borne illness.

The closer you place foods to the broil element, the faster foods brown on the outside yet remain red to pink in the center.

Moving meats away from the element will allow the meat to cook to the center while browning on the outside. Using this positioning, cook side 1 at least 2 minutes longer than side 2. If your oven is connected to 208 volts, you may want to use a higher rack position and/or broil foods longer.

The size, weight, thickness, starting temperature, and your preference of the doneness of the meat will affect broiling. The chart on the next page is based on meats at refrigerator temperature.

HOW TO SET BROIL

1. Set the **OVEN CONTROL KNOB** to **BROIL**.
2. When broiling is finished, turn the **OVEN CONTROL KNOB** to the **OFF** position.

OPERATION

Broiling (cont.)

BROILING GUIDE (HI Broil)

FOOD	QUANTITY AND/OR THICKNESS	SHELF POSITION	FIRST SIDE TIME (MIN.)	SECOND SIDE TIME (MIN.)	COMMENTS
Ground Beef Well Done	1 lb (4 patties) ½" to ¾" thick	4	13	8	Space evenly.
	4 lbs. (12 patties)	4	15	11	
Beef Steaks	Rare† Medium Well Done	¾" to 1" thick	6	4	Steaks less than ¾" thick are difficult to cook rare.
		(1 to 1½ lbs.)	5	8	
		5	10	8	
Rare† Medium Well Done	1½" thick (2 to 2½ lbs.)	4	10	8	Slash fat.
		4	15	10-12	
		5	20	20	
Chicken	1 whole, cut up (2 to 2½ lbs.), split lengthwise Breast	3	25	25	Brush each side with melted butter. Broil skin-side down first.
		3	25	15	
Bakery Products Bread (Toast) or English Muffins	2 to 4 slices 2 (split)	5	3	1	Space evenly. Place English muffins cut-side-up and brush with butter, if desired.
		6	3-4		
Lobster Tails	2 to 4 (6 to 8 oz. each)	3	18-20	Do not turn over.	Cut through back of shell. Spread open. Brush with melted butter before broiling and after half of broiling time.
Fish	1 lb. fillets ¼" to ½" thick	5	5	5	Handle and turn very carefully. Brush with lemon butter before and during cooking, if desired.
Salmon Steaks Fillets	2 (1" thick) 2 (½" to ¾" thick)	5	10	5	Turn carefully. Do not turn skin-side down.
		5	10		
Ham Slices (precooked)	½" thick 1" thick	4	6	6	
		4	8	8	
Pork Chops Well Done	2 (½" thick) 2 (1" thick) about 1 lb.	4	10	10	Slash fat.
		4	15	15	
Lamb Chops Medium Well Done Medium Well Done	2 (1" thick), about 10 to 12 oz. 2 (1½" thick) about 1 lb.	5	7	4	Slash fat.
		5	10	9	
		5	9	6	
		5	14	10	

† The U.S. Department of Agriculture says "Rare beef is popular, but you should know that cooking it to only 140°F means some food poisoning organisms may survive." (Source: Safe Food Book. Your Kitchen Guide. USDA Rev. June 1985.)

CARE AND CLEANING Self-Cleaning Cycle

PREPARING YOUR OVEN FOR A SELF-CLEAN CYCLE

1. Remove the broiler pan and grid, oven racks, utensils, and any foil that may be in the oven.
2. Soil on the front frame and outside the gasket on the door liner will need to be cleaned by hand.

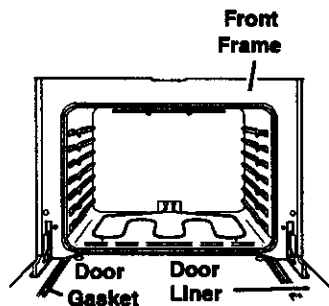

Clean these areas with hot water, soap-filled steel-wool pads, or cleansers such as Soft Scrub® to remove any soil. Rinse well with clean water and dry.

3. Wipe up any heavy spillovers on the oven bottom.
4. Do not clean the gasket. The fiberglass material of the oven door gasket cannot withstand abrasion. It is essential for the gasket to remain intact. If you notice it becoming worn or frayed, it should be replaced.

OVEN DOOR GASKET

The gasket is designed to have a 5"-6" gap at the bottom of the door. This allows for proper air circulation.

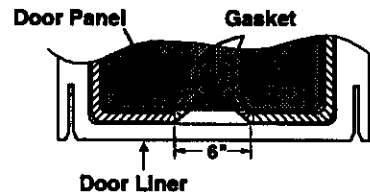

It is normal for your oven door to give the appearance of not having a good seal against the range. This is due to the gasket. The location of the gasket on the door maintains a good seal and prevents any heat loss.



Utensils should never be left in the oven during a self-clean cycle.

The oven racks may be cleaned during the self-clean cycle, but will lose their luster and become hard to slide. If you choose to leave them in during the cycle, wiping them down with vegetable oil after the cycle will help them slide easier.

For the first clean cycle, vent the room with an opened window or hood vent. This will reduce the odor produced when heating new parts.

CARE AND CLEANING Self-Cleaning Cycle (cont.)

TO SET A CLEAN CYCLE

1. For best results, follow the steps in **PREPARING YOUR OVEN**.
2. Slide the self-clean lock handle to the right as far as it will go. Do not force the handle.



3. Turn the oven control knob to **CLEAN**. The **CLEAN** and **OVEN ON** indicator lights will glow.
If the **CLEAN** indicator flashes, the door is not closed completely. Simply push the handle to the lock position.
4. The clean cycle lasts 4 hours and 20 minutes—this includes a cool-down time. You may change this to any time from 3 hours to 5 hours and 59 minutes by touching the **HOUR/MIN UP** and/or **DOWN** arrow pads.

When the door locks, **CLEAN** and **OVEN ON** indicator lights will glow. The oven temperature must drop below the locking temperature before the door can be opened. The **CLEAN** and **OVEN ON** indicators will blink at the end of the cycle.

5. Turn the **OVEN CONTROL KNOB** to the **OFF** position and unlock the door.

TO SET A DELAYED CYCLE

1. Make sure the correct time of day is displayed.
2. For best results, follow the steps in **PREPARING YOUR OVEN**.
3. Slide the self-clean lock handle to the right as far as it will go. Do not force the handle.
4. Turn the **OVEN CONTROL KNOB** to **CLEAN**. The **CLEAN** and **OVEN ON** indicator lights will glow.
5. To delay the start of the clean cycle touch the **START TIME ON/OFF** pad.
6. Touch the **HOUR/MIN UP** and/or **DOWN** arrow pads to set the time of day you want the oven to start cleaning.
7. When the cycle is finished, the **OVEN ON** and **CLEAN** indicator lights will flash. Turn the **OVEN CONTROL KNOB** to the **OFF** position and unlock the door.

TO STOP A CYCLE

Turn the **OVEN CONTROL KNOB** to the **OFF** position. Wait (approx. 1 hour) before attempting to open the door. The indicator light will not blink if the cycle is stopped.

AFTER THE CYCLE

After the cycle, you may notice some white ash in the oven. Just wipe it up with a damp cloth or sponge.

If white spots remain, scrub them with a soap-filled steel-wool pad. Be sure to rinse thoroughly. These are usually deposits of salt that cannot be removed during the cycle.

If for any reason you are not satisfied with the cleaning results, just repeat the cycle.

CARE AND CLEANING

Cleaning

CONTROL PANEL

CLEANING MATERIALS

- Dishwashing detergent
- Warm water
- Soft cloth

Do not use abrasive cleaners, industrial cleaners, or bleach.

BROILER PAN AND GRID

CLEANING MATERIALS

- Dishwashing detergent
- Warm water
- Soap-filled steel-wool pad
- Commercial oven cleaner

TO CLEAN

Allow the pan to soak. Sprinkle the grid with dishwashing detergent and cover with a damp cloth or paper towel and let stand. Scour as needed. Wash, rinse, and dry well. You may also place both the pan and grid in the dishwasher.

WALLS OF THE OVEN

Clean only as touch-up between clean cycles. Use dishwashing liquid, warm water, or soap-filled steel-wool pad. Rinse well after cleaning and dry.

NEVER USE OVEN CLEANERS IN OR AROUND ANY PART OF THE OVEN.

When cleaning, be sure not to bend or displace the temperature sensor, located on the back wall of the oven.

COOKTOP AND AREA UNDER COOKTOP

CLEANING MATERIALS

- Dishwashing detergent
- Warm water
- Paper towel
- Ammonia
- Abrasive cleaner
- Scouring pad

TO CLEAN

Clean after each use. If acidic foods (hot fruit filling, tomatoes, sauerkraut, or sauces with vinegar or lemon juice) spill, use a dry paper towel to wipe up as much as possible. When surface has cooled, thoroughly clean cooktop.

DRAWER AND SIDES OF RANGE

CLEANING MATERIALS

- Dishwashing detergent
- Warm water
- Paper towels

TO CLEAN

Do not use oven cleaners, cleansing powder or harsh abrasives. If marinades, tomato sauce, basting materials, etc. should spill, wipe up as much as possible. When surfaces have cooled, thoroughly clean painted areas.

OVEN DOOR GLASS

TO CLEAN

For everyday cleaning, use glass cleaner and a paper towel. For stubborn soil, use paste of baking soda and water. Rinse thoroughly.

DOOR VENT TRIM

CLEANING MATERIALS

- Soft abrasive cleaner
- Sponge scrubber

Do not use hard, abrasive cleaners, industrial cleaners, or bleach.

CARE AND CLEANING

Removable Parts

LIFT-UP COOKTOP

(on some models)

Some models have a cooktop that can be lifted up for easier cleaning. The entire cooktop may be lifted up and supported in the up position.

The surface units do not need to be removed; however, you may remove one to make raising the cooktop easier. There are two side supports that lock into position when the cooktop is lifted up.

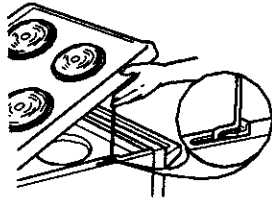

Be sure all surface units are turned off before raising the cooktop.

After cleaning under the cooktop with hot, mild soapy water and a clean cloth, lower the cooktop. Be careful not to pinch your fingers.

To lower the cooktop, push the rods back and gently lower the cooktop until it rests in place.



CAUTION: When working in this area, be careful not to bump into the support rod(s). The porcelain enamel surface of the cooktop can chip if dropped.

CARE AND CLEANING Removable Parts (cont.)

CONTROL KNOBS

CLEANING MATERIALS

- Dishwashing detergent
- Warm water
- Soft cloth

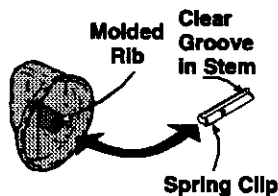

TO REMOVE

1. Be sure the control knob is in the **OFF** position.
2. Pull straight off the stem. Using a piece of string can make removing the knob easier. Slip the string under and around the knob, pulling straight out.

TO CLEAN

Wash the knob thoroughly with soapy water. Dry completely with a soft cloth. **DO NOT let the knob soak.**

TO REPLACE

1. Check the back of the knob.
2. The molded rib of the knob is designed to fit perfectly onto the knob stem.
3. Align the molded rib to the clear groove in the knob stem. Push the knob back as far as it will go.

REPLACING THE OVEN LIGHT BULB



CAUTION:

Disconnect electrical power to the oven at the main circuit breaker or fuse box before attempting to replace the oven light bulb. Do not touch a hot light bulb with wet hands or a wet cloth. Wait until the bulb has cooled and use a dry cloth.

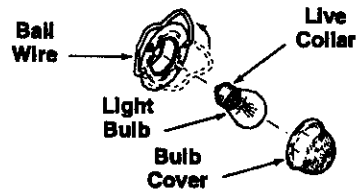

TO REPLACE

1. Hold your hand under the bulb cover and firmly push back the ball wire, until it clears and releases the bulb cover.
2. Unscrew the light bulb.
3. Replace the bulb with a 3½ 40-watt appliance bulb.
4. Place the bulb cover into the grooves of the socket and pull the ball wire forward until it rests in the indentation on top of the bulb cover.

CARE AND CLEANING Removable Parts (cont.)

REMOVABLE COOKTOP UNIT

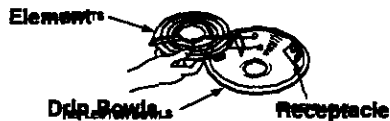

TO REMOVE

1. Be sure the controls are in the **OFF** position and the elements are cool before attempting to remove them.
2. Grasp the element and lift slightly, just enough to clear the drip bowl and pull it straight out.



CAUTION: Do not lift the element more than 1". Lifting the element more than 1" can damage the receptacle, causing the element not to lie flat when it is plugged back in.

3. Lift out the drip bowl.

TO CLEAN THE DRIP BOWL

For brown food stains – Use dishwashing detergent, warm water, plastic scouring pads, mild abrasive cleaners, soap-filled scouring pads, or ammonia. Clean drip bowls after each use. Rinse and dry well. Foods that are not removed can cause permanent stains that cannot be removed. For heavily soiled bowls, place them in a covered container (or a plastic bag) with ¼ cup of ammonia to loosen the soil, then gently scrub the bowl with a plastic scouring pad.



CAUTION: Do not operate the cooktop elements without the drip bowl in place. Scorching of the cooktop, burning of wiring insulation and loss of energy will occur.

TO REPLACE THE UNIT

1. Place the drip bowl into the opening and make sure the receptacle is visible.
2. Slide the element firmly back into the receptacle and lower it onto the drip bowl.

CARE AND CLEANING Removable Parts (cont.)

REMOVABLE OVEN RACKS

CLEANING MATERIALS

- Dishwashing detergent
- Warm water
- Scouring pad or soap-filled steel-wool pad

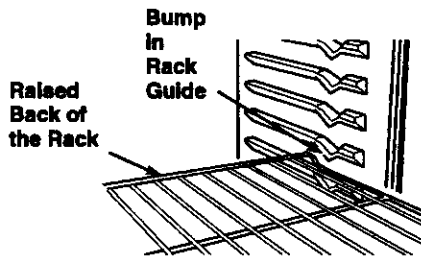

TO REMOVE

1. Pull the racks out to the stop position.
2. Pull up the front of the rack and slide under the bump of the rack guide.

TO CLEAN

Clean with warm water and detergent. For hard-to-remove stains, gently scrub with a scouring pad or a soap-filled steel-wool pad. Rinse well.

TO REPLACE

1. Place the raised back of the rack onto the rack guides.
2. Lift the front of the rack until the raised back slides under the bump of the rack guides.
3. Slide the rack all the way back.

REMOVABLE OVEN DOOR

TO REMOVE

1. Fully open the door.
2. Push the hinge locks down toward the door frame, to the unlocked position. This may require a flat-blade screwdriver.

Hinge Lock
(Unlocked
Position)



Hinge Arm

3. Firmly grasp both sides of the door at the top.
4. Close door to the door removal position.
5. Lift door up until the hinge arm is clear of the slot.

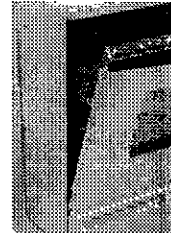

Removal Position

TO REPLACE

1. Firmly grasp both sides of the door at the top.
2. With the door at the same angle as the removal position, seat the indentation of the hinge arm into the bottom edge of the hinge slot.

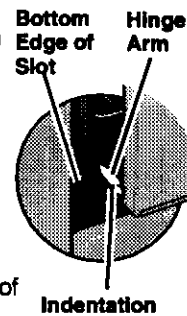

CARE AND CLEANING **Removable Parts (cont.)**

Removable Oven Door (cont.)

3. Fully open the door.
4. Push the hinge locks up against the front frame of the oven cavity, to the locked position.

**Locked
Position**



5. Close the oven door.

**Sealed Hinge
Arm**

TO CLEAN OUTSIDE OF DOOR

- Use soap and water to thoroughly clean the top, sides, and front of the oven door. Rinse well. You may also use a glass cleaner to clean the glass on the outside of the door. Do not let water drip into the vent openings.
- Spillage of marinades, fruit juices, tomato sauces, and basting materials containing acids may cause discoloration and should be wiped up immediately. When surface is cool, clean and rinse.
- Do not use oven cleaners, cleaning powders, or harsh abrasives on the outside of the door.
- If any stain on the door vent trim is persistent, use a soft abrasive cleaner and a sponge scrubber for best results.

TO CLEAN INSIDE OF DOOR

- Because the area inside the gasket is cleaned during the self-clean cycle, you do not need to clean this by hand.
- The area outside the gasket and the door liner can be cleaned with a soap-filled steel-wool or plastic pad, hot water, and detergent. Rinse well with a vinegar and water solution.

CARE AND CLEANING Removable Parts (cont.)

REMOVABLE STORAGE DRAWER

TO REMOVE

1. Pull the drawer out until it stops.
2. Lift the front of the drawer until the stops clear the guides.

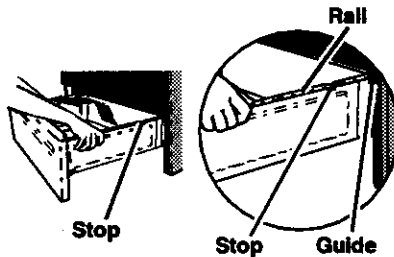

3. Remove the drawer.

TO REPLACE

1. Place the drawer rail on the guides.
2. Push the drawer back until it stops.
3. Lift the front of the drawer and push back until the stops clear the guides.
4. Lower the front of the drawer and push back until it closes.

IF DRAWER WON'T CLOSE

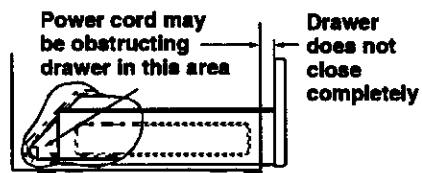

Rear drawer support is resting on top of guide rail

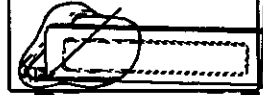

Drawer front panel tipped away from body side

IF DRAWER IS CROOKED

Rear drawer support is on top of guide rail on the high side



Drawer front panel tipped to one side

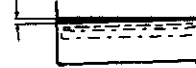

CAUTION: The drawer gives you space for keeping cookware and bakeware. Plastics and flammable materials should not be kept in this drawer. Do not overload the storage drawer. If the drawer is too heavy, it may slip off the base rail when opened.

STORAGE DRAWER LINER (on some models)

CLEANING MATERIALS

- Dishwashing detergent
- Damp cloth
- Warm water

TO REMOVE

1. Remove the drawer.
2. Lift the liner out of the drawer.

TO REPLACE

1. Place the liner back into the drawer.
2. Place the drawer back into the range.

BEFORE CALLING FOR SERVICE

To save you time and money, before making a service call, check the list below for any problem you may feel you have with the performance of your range. If the problem is something you cannot repair, use the Consumer Service Numbers located at the back of this manual. **When making any calls, have the Model No., Serial No., Repair Parts List, Use and Care Manual, and the Date of Purchase available.**

PROBLEM	POSSIBLE CAUSE	POSSIBLE SOLUTION
Range will not work; totally inoperative.	No power to range.	a. Check the household circuit breaker or fuse box. b. Check to make sure the range is plugged in.
Cooktop will not work, oven is ok.	Elements unplugged.	Check the elements, make sure they are properly plugged into the receptacle.
Oven will not work, Cooktop okay.	Control set improperly.	Check the control and check oven cooking section.
Foods do not bake properly.	a. Oven is not preheated. b. Improper rack or pan placement. c. Oven vent blocked or covered with foil. d. Improper use of foil. e. Improper temperature setting for utensil used. f. Oven temperature needs adjustment. g. Range and oven rack not level.	a. Be sure to preheat until the tone sounds. b. Maintain uniform air space around pans and utensils. See oven cooking tips section. c. Keep vent clear. d. Racks should not be covered during baking. e. Reduce temperature 25 degrees for glass or dull/darkened pans. f. Check the temperature adjustment following this section. g. Check the installation instructions for leveling.

BEFORE CALLING FOR SERVICE

PROBLEM	POSSIBLE CAUSE	POSSIBLE SOLUTION
Oven temperature seems inaccurate.	Oven control calibration.	See temperature adjustment section.
Oven will not unlock.	Clean cycle is not finished.	Oven temperature must drop below the lock temperature before the door will unlock.
Oven light does not work.	<ul style="list-style-type: none">a. Light switch is in off position.b. Bulb needs replacing or is loose.	<ul style="list-style-type: none">a. Check switch setting.b. Check or replace light bulb.
Foods do not broil properly.	<ul style="list-style-type: none">a. Improper rack position.b. Oven preheated.c. Improper use of foil.d. Oven door closed during broiling.e. Low voltage (208 volts).f. Improper broiling time.	<ul style="list-style-type: none">a. Check broil pan placement; see broiling section.b. Do not preheat when broiling.c. Check broiling section.d. Open door to broil stop position.e. Use higher rack position and/or longer cooking time.f. Check broiling chart in broiling section.
Oven smokes.	<ul style="list-style-type: none">a. Dirty oven.b. Broiler pan containing grease left in the oven.	<ul style="list-style-type: none">a. Check for heavy spillover.b. Clean pan and grid after each use.

BEFORE CALLING FOR SERVICE

PROBLEM	POSSIBLE CAUSE	POSSIBLE SOLUTION
Oven emits odor.	<p>a. Oven insulation may emit odor during the first few usages.</p> <p>b. Failure to wipe out excess soil.</p>	<p>a. Put oven through self-clean cycle to speed up process of odor "wearing off."</p> <p>b. Wipe excess soil off before using oven.</p>
Oven door accidentally locked while baking.	<p>Do not force the lock handle. Temperatures above the locking temperature will prevent the lock handle from sliding to the unlock position.</p>	<p>Turn the control knob to the off position. Allow the oven to cool until the temperature inside drops below the lock temperature and the handle slides easily.</p>
Cleaning results were poor.	<p>a. Oven was heavily soiled.</p> <p>b. Clean cycle interrupted.</p>	<p>a. Heavy spillovers should be cleaned before the cycle is set.</p> <p>b. Allow the oven to clean its full cycle.</p>
"F—and a number or letter" flash in the display	<p>You have a function error code.</p>	<p>If a function error code appears during the self-cleaning cycle, check the oven door latch. The latch may have been moved, even if only slightly, from the locked position. Make sure the latch is moved to the right as far as it will go. Turn the oven temperature control knob to OFF. Allow the oven to cool for one hour. Put the oven back into operation.</p> <p>If the function code repeats, disconnect all power to the range for at least 30 seconds and then reconnect power. If the function error code repeats, call for service.</p>

"DO-IT-YOURSELF" TEMPERATURE ADJUSTMENT

You may feel that your new oven cooks differently than the oven it replaced. We recommend that you use your new oven a few weeks to become more familiar with it, following the times given in your recipes as a guide.

If you think your new oven is too hot (burning foods) or not hot enough (foods are undercooked), you can adjust the temperature yourself. The appearance and texture of foods is a better indicator of oven accuracy than an oven thermometer. These thermometers can vary by 20–40 degrees from the true temperature of the oven. In addition, the oven door must be opened to read these thermometers. Opening the door will change the temperature of the oven.

To decide how much to change the temperature, set the oven temperature 25 degrees higher (if foods are undercooked) or 25 degrees lower (if foods are burning) than the temperature in your recipe, then bake. The results of this "test" should give you an idea of how much the temperature should be changed.

TO MAKE THE ADJUSTMENT

1. Press and hold, **at the same time**, the **HOUR UP** and **DOWN** arrow pads until the display shows a two-digit number.
2. Press the **HOUR UP** arrow pad to increase the temperature up to +35°F hotter.

or

Press the **HOUR DOWN** arrow pad to decrease the temperature down to -35°F cooler.

3. When this adjustment has been made, the display will return to the time of day.

This adjustment will remain in memory until these steps are repeated and a new temperature is selected. It will remain in memory even after a power failure.

This adjustment will not affect the Broil or Clean temperatures.



NOTES

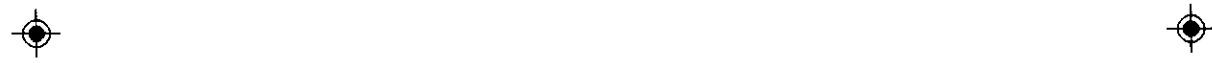

Kenmore **FREE-STANDING RANGE WARRANTY**

FULL ONE-YEAR WARRANTY ON ALL PARTS

If, within one year from the date of installation, any part fails to function properly due to a defect in material or workmanship, Sears will repair or replace it, at our option, free of charge.

If this product is subjected to other than private family use, the above warranty is effective for only 90 days.

WARRANTY SERVICE IS AVAILABLE BY CONTACTING THE NEAREST SEARS SERVICE CENTER IN THE UNITED STATES.

This warranty gives you specific legal rights, and you may also have other rights which vary from state to state.

Sears Roebuck and Co. Dept. 817 WA Hoffman Estates, IL 60179

**To further add to the value of your Range,
Buy a Sears Maintenance Agreement.**

Years of Ownership Coverage	1st Year	2nd Year	3rd Year
1. Replacement of Defective Parts	W	MA	MA
2. Annual Preventive Maintenance Check at your request	MA	MA	MA

W - Warranty MA - Maintenance Agreement

Kenmore Appliances are designed, manufactured and tested for years of dependable operation. Yet, any appliance may require service from time to time. The Sears Maintenance Agreement offers you an outstanding service program for your product.

The table above shows the additional benefits a Sears Maintenance Agreement offers compared to a Sears Warranty.

Contact your Sears Sales Associate or local Sears Service Center to purchase a Sears Maintenance Agreement.